



# TESLA UK LTD

## 2021/22 Product Guide

Manufacturer and provider of innovative and traditional plumbing materials



# Welcome to Tesla UK Ltd

Tesla UK Ltd has built its reputation throughout the UK as a primary supplier of in-depth product ranges dedicated to the Plumbing & Heating Industries. Tesla's expertise and manufacturing facilities are utilised by the industry, to support product supply and competitive pricing to meet market requirements. We are an ISO9001 certificated business and many of our products hold Kitemark WRAS, Gas and OFTEC approvals.



## Distribution

Operating from a 35,000-square foot warehouse based in the West Midlands we hold a wide range of products in stock so that we are able to offer a next day delivery service to our customers nationwide, including Northern Ireland.

Our customer service team are well trained, knowledgeable, friendly and efficient. We believe in going the extra mile for our customers ensuring they get what they want, when they want it. We aim to be a reliable extension of your own business.

Our Right-First-Time philosophy with accounts and documentation means that you have more time to concentrate on the important elements of your business.



## Product Development

Our quality and technical team have over 50 years of industry experience and continually work towards developing our product ranges to exceed the market demand, improving on safety and quality features, whilst working in partnership with our customers.

We are the designers and creators behind the cooker hose that incorporates a patented Fire Safe fusible plug which will shut off the gas supply at the socket in the event of a fire.



## Manufacturing

With more than 20 years of manufacturing experience in the UK, at our West Midlands based production facility we produce and test products to a high standard and in accordance with the Kitemark Terms & Conditions issued by BSI.

We have the manufacturing capability to produce large volume or specific one-off, individual products.

### SALES / CUSTOMER SERVICE

Tel: +44 (0) 121 686 8711  
Email: [sales@teslauk.com](mailto:sales@teslauk.com)

### TECHNICAL SUPPORT

Tel: +44 (0) 121 686 8733  
Email: [technical@teslauk.com](mailto:technical@teslauk.com)

### FACSIMILIE

Fax: +44 (0) 121 686 8712



### Our service is first class

Customers choose us for the quality of our products first and foremost but also for our ability to be flexible and helpful. Whether it is having your goods packed a certain way, identifying product with your part numbers, or rising to those moments where you need your supplier to react and make something happen, we pride ourselves on our ability to offer that personal attention.



### Excellent stock availability

We hold large amounts of quality products in stock at our West Midlands distribution centre meaning that you don't have to wait as long for that essential item.



### Our prices are competitive

Due to our size and focus on service we can afford to pass on savings to our customers.



### We deliver daily

We will endeavour to get your order to you, to the precise location, on the day required. Our carriage paid value is £150 net, orders below this would incur a carriage cost of £9.95. We offer the following additional delivery options:

- Next working day by 9am
- Next working day by 10:30am
- AM next day delivery
- Saturday delivery

For these options please call our Customer Service Team who will be happy to provide you with prices.



### Our invoicing is both prompt and accurate

We're not a huge corporate organisation and because of this we can be flexible with our ordering and invoicing processes and adapt them to effectively match your requirements.



### Accreditations

Tesla UK and Thermco provide market leading, quality products that meet the appropriate industry standards where required. Our products offer Kitemark, WRAS, BEAB, CE, OFTEC approval where indicated. Members of our teams also sit on a variety of councils and committees such as BSI, OFTEC and the Hot Water Association ensuring the quality and standards are maintained in both the industry and our own business.



\*\*NB. Although care has been taken to ensure all information and images in this product guide are accurate, Tesla UK Ltd takes no responsibility for errors, omissions and product technical changes within this catalogue.



@TeslaUK



@TeslaUKLtd

# TESLA INNOVATIONS & EXCLUSIVES



**GAS COOKER HOSES**

**PAGE 8**



**IMMERSION HEATERS**

**PAGE 18**



**T-SMART HOT WATER CYLINDER THERMOSTAT**

**PAGE 22**



**TOWEL RAIL ELEMENTS**

**PAGE 26**

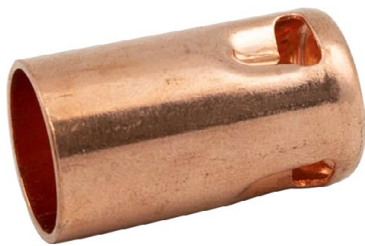

**VFLOW PRV BLOW-OFF CAP**

**PAGE 32**



**EXPANSION VESSEL SERVICE VALVE**

**PAGE 34**



**T-BAR EXPANSION VESSEL MOUNTING KIT**

**PAGE 35**



**TESLATUN DRY TRAP TUNDISH**

**PAGE 36**

# CONTENTS

<b>1 GAS HOSES, FITTINGS &amp; VALVES</b>			
8	Gas hoses	12	Teslaflex Corrugated Stainless Steel Tubing
9	Gas Hose Accessories	14	Gas Meter Fittings
10	Isolation Valves & Gascocks	15	Test Point Valves & Fittings
11	Mini Ball Valves	16	Gas Fire Tubes & Accessories
<b>2 WATER HEATING</b>			
18-20	Immersion Heaters & Thermostats	31	Boiler & Cylinder Accessories
22-23	T-Smart Hot Water Cylinder Thermostat	32	vFlow PRV Blow-off Cap
24-25	Commercial & Industrial Immersion Heaters	33	Cylinder Flanges
26-27	Towel Rail Heating	34-35	Expansion Vessel Accessories
28-29	Radiator Valves	36	TeslaTun Dry Trap Tundish
30	Radiator Accessories		
<b>3 PIPE CLIPS &amp; ACCESSORIES</b>			
38	Brass Clips	39	Worm Drive Hose Clamps
39	Backplates	40	Rubber Lined Clips & Accessories
39	Copper Saddle Clips		
<b>4 OIL LINE EQUIPMENT</b>			
43	Remote Action Fire Valves	44-45	Oil Line Equipment
<b>5 GENERAL VALVES &amp; ACCESSORIES</b>			
46-47	Lever Ball Valves	54	Stopcocks & Bibtaps
48-49	Check Valves & Strainers	55	Isolating & Gate Valves
50	Drain Cocks	57	Washing Machine Valves
52	Pump Valves	58	Float Valves
<b>6 GENERAL PLUMBING FITTINGS</b>			
62-63	Brass Fittings	69-71	Compression Fittings
64-66	End Feed Fittings	72	Chrome Compression Fittings
67-68	Solder Ring Fittings	73	Heavy Duty Compression Fittings
<b>7 MALLEABLE IRON FITTINGS</b>			
76	Plugs & Backnuts	76-77	Nipples
76	Sockets & Bushes	77	Elbows
76	Caps	78	Pipe Clips & Backplates
<b>8 TOOLS</b>			
80	Immersion Heater Spanners	80	Pipe & Sink Cleaners
80	Radiator Keys	81	Pipe Cutters
80	Bending Springs	81	Drainage Key Set



# THE PROFESSIONAL DOMESTIC GAS HOSE

## DESIGN & QUALITY

Tesla UK Ltd is the UK leader in gas hose and gas fitting design and technology with over 100 years' experience in manufacture. We are always at the forefront of design and quality and as well as representation on UK Standards Committees have also worked on European Committees for gas hoses and gas fittings.

## APPROVALS & TESTING

Cookerflex gas hoses and fittings by Tesla UK Ltd are tested and approved, to their respective standards, by BSI and are approved under the BSI Kitemark ensuring quality is maintained through factory audit of our manufacturing process. We also have all our own in-house testing to ensure compliance with standards of safety and all gas hoses and fittings are 100% leak tested before despatch.

## PATENTED FIRE SAFE TECHNOLOGY

All Tesla UK Ltd Cookerflex bayonet and micropoint hoses have a patented end fitting design that shuts off the gas supply in case of fire near the gas cooker. With gas cookers being a main cause of fires in kitchens we developed and introduced this technology to help save lives.

## MADE IN BRITAIN

Tesla UK Ltd is the leading UK manufacture of gas hoses and fittings with over 100 years of experience in manufacture and product development. All Tesla UK Ltd Cookerflex gas hoses are manufactured in our ISO 9001 approved, UK factory based in Minworth and are regularly audited by BSI to ensure consistency of quality and design.

Where you see the Cookerflex Brand you are sure to be using the safest of products manufactured in Britain.

MANUFACTURED IN THE UK  
**COOKERFLEX** 



# 01

## GAS HOSES, FITTINGS & VALVES

08.	Cooker & Catering Hoses
09.	Cooker Hose Sockets & Accessories
10.	Lever Ball Valves
10.	Gas Cocks
11.	Mini Lever Ball Valves
12-13.	Teslaflex Corrugated Stainless Steel Tubing
14.	Gas Meter Fittings
15.	Testpoint Valves & Fittings
16.	Gas Fire Tubes & Accessories

## PATENTED FIRE SAFE FEATURE

- British design and long established UK product development
- Proud UK manufacturers
- Unrivalled temperature rating up to 95 °C (BS669 Pt.1)
- Award winning design

MADE IN BRITAIN



AGSM

Gas Safety WINNER



**Bowbros**

MANUFACTURED IN THE UK  
**COOKERFLEX**



- Approved to BS669 Pt.1
- Manufactured in the UK
- For use with Natural Gas

KM 637746  
BS 669 PT.1

### BAYONET - BS669 PT.1

Code	Size
THN120	2ft x 1/2"
THN130	3ft x 1/2"
THN140	4ft x 1/2"
THN150	5ft x 1/2"
THN160	6ft x 1/2"



- Approved to BS669 Pt.1
- Manufactured in the UK
- For use with Natural Gas

KM 637746  
BS 669 PT.1

### MICROPOINT BS669 PT.1

Code	Size
THN630	2ft x 1/2"
THN635	3ft x 1/2"
THN640	4ft x 1/2"



- Manufactured in the UK
- For use with Natural Gas

KM 637746  
BS 669 PT.1

### NUT & UNION

Code	Size
THN320	2ft x 1/2"
THN330	3ft x 1/2"
THN340	4ft x 1/2"



- Approved to EN14800
- Recommended for use with LPG

KM 641091  
BS EN18400

### EN14800 - BAYONET

Code	Size
THUS1000	1/2" x 1m
THUS1250	1/2" x 1.25m



- Approved to EN14800
- Recommended for use with LPG

KM 641091  
BS EN18400

### EN14800 - MICROPOINT

Code	Size
THUM1000	1/2" x 1m
THUM1250	1/2" x 1.25m



- Manufactured in accordance with BS669-2:1997.
- Suitable for 1st, 2nd and 3rd family gases
- Quick release

### CATERING HOSE

Code	Size
CHC-12-1000	1/2" x 1m
CHC-12-1500	1/2" x 1.5m
CHC-34-1000	3/4" x 1m
CHC-34-1500	3/4" x 1.5m





- For use with Natural Gas and LPG
- CE marked



## ANGLED BAYONET

Code	Size
B553	1/2"

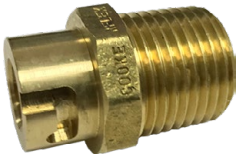

- For use with Natural Gas and LPG
- CE marked



## MICROPOINT

Code	Size
B614	1/2"



## GAS HOB RESTRICTOR ELBOW

Code	Size
GHRE	1/2" x 15mm



- For use with Natural Gas and LPG
- CE marked



## STRAIGHT BAYONET

Code	Size
B593	1/2"



- As required by BS6172 installation standard

## COOKER CHAINS

Code	Description
GCSC	Cooker Chain Kit
GCRHOOK	1m Chain & Hook
GCRC	1m Galvanised Chain Only
GRCHEAVY	1m Galv. Chain Heavy Pattern
HOOKB	Hook Only



- As required by BS6172 installation standard

## STABILITY BRACKET

Code
CSB



- For use with Natural Gas and LPG

## WALL CONNECTOR

Code	Size
REWCS	15mm x 1/2" Straight
REWCA	15mm x 1/2" Angled



## STRAPPED ELBOW

Code	Size
B583	15mm x 1/2"



## BACKPLATE ADAPTOR WITH STUB

Code	Size
B579	15mm x 1/2"



## BACKPLATE ADAPTOR

Code	Size
B578	15mm x 1/2"



- EN331 approved
- CE marked
- Compression ends to EN1254-2



## GAS ISOLATION VALVES

Code	Size
GC802	8mm
GC102	10mm
GC1502	15mm
GC2202	22mm



- Full bore
- Suitable for natural gas, LPG and oil
- Approved to BS EN331
- Nickel plated
- PN25



## BUTTERFLY LEVER BALL VALVES

Code	Size	Colour
GB/BVT14	1/4"	Yellow
GB/BVT38	3/8"	Yellow
GB/BVT12	1/2"	Yellow
GB/BVT34	3/4"	Yellow
GB/BVT15	15mm	Yellow
PROBBV28	28mm	Yellow



- Rigid fan

## CAPILLARY GASCOCKS

Code	Size
TGC150	8mm
TGC160	15mm
TGC165	22mm



Temperature range:  
-10°C to +110°C



- Full bore
- Suitable for natural gas, LPG and oil
- Approved to BS EN331
- Nickel plated



## COMPRESSION LEVER BALL VALVE

Code	Size	Colour
GB/BVL15	15mm	Yellow
GB/BVL22	22mm	Yellow
GB/BVL28	28mm	Yellow
GB/BVL35	35mm	Yellow
GB/BVL42	42mm	Yellow
GB/BVL54	54mm	Yellow



- Full bore.
- Approved to EN331.



## TOPGAS LEVER BALL VALVES

Code	Size
PROBVT12	1/2"
PROBVT34	3/4"
PROBVT1	1"
PROBVT114	1-1/4"
PROBVT112	1-1/2"
PROBVT2	2"



- Rigid fan

## COMPRESSION GASCOCKS

Code	Size
TGC020	15mm
TGC025	22mm



Temperature range:  
-20°C to +130°C



- Full bore
- Suitable for natural gas, LPG and oil
- Approved to BS EN331
- Nickel plated



## FEMALE LEVER BALL VALVES

Code	Size	Colour
GB/BVL14	1/4"	Yellow
GB/BVL38	3/8"	Yellow
GB/BVL12	1/2"	Yellow
GB/BVL34	3/4"	Yellow
GB/BVL1	1"	Yellow
GB/BVL114	1-1/4"	Yellow
GB/BVL112	1-1/2"	Yellow
GB/BVL2	2"	Yellow
PROBV212	2-1/2"	Yellow
PROBV3	3"	Yellow
PROBV4	4"	Yellow



- Includes low pressure test point
- EN331 approved
- Full bore
- 1/4" turn



## TEST POINT LEVER BALL VALVES

Code	Size
GT/BVL34	3/4"
GT/BVL1	1"



WRAS APPROVED  
LEVER BALL VALVES  
SEE PAGE 46

- Suitable for Natural Gas, LPG & Oil
- EN331 approved
- Compression ends to BS EN1254
- Suitable for class CS & D fuel oils to BS2869 (excluding petrol)



CE

COMPRESSION	
Code	Size
GCM08	8mm
GCM10	10mm
GCM12	12mm
GCM15	15mm



CE

COMPRESSION REDUCING	
Code	Size
GCM1008	10mm x 8mm
GCM1508	15mm x 8mm
GCM1510	15mm x 10mm



CE

ANGLED COMPRESSION	
Code	Size
GCM08A	8mm
GCM10A	10mm
GCM15A	15mm
GCM1508A	15mm x 8mm
GCM1510A	15mm x 10mm



CE

MALE x FEMALE	
Code	Size
GCM14MF	1/4"
GCM38MF	3/8"



CE

BSPT MALE x COMPRESSION	
Code	Size
GCM0814	8mm x 1/4"
GCM1014	10mm x 1/4"
GCM1038	10mm x 3/8"
GCM1512M	15mm x 1/2"



MINI BALL VALVE - LONG SPINDLE	
Code	Size
GCM08LS	8mm



CE

COMPRESSION W/ BACKPLATE	
Code	Size
GCM08BP	8mm
GCM08BPR	8mm (red insert)
GCM10BP	10mm
MGCM1510BP	15mm x 10mm



CE

FEMALE	
Code	Size
GCM14F	1/4"
GCM38F	3/8"
GCM12CP	1/2"

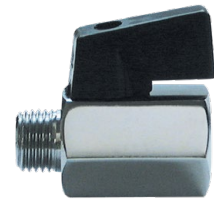

MxF BLACK HANDLE	
Code	Size
MBVM18S	1/8"
MBVM14S	1/4"
MBVM38S	3/8"
MBVM12S	1/2"
MBVM34S	3/4"



Fx F BLACK HANDLE	
Code	Size
MBV18	1/8"
MBV14S	1/4"
MBV38	3/8"
MBV12	1/2"
MBV34	3/4"



Our starter kits contain everything you need to get up and running.

Kit Includes:

- 10m coil of pipe
- 2 x male adaptors
- 1 x roll of self-amalgamating tape

## STARTER KITS

Code	Size
TFX1210KIT	DN12
TFX3410KIT	DN15
TFX0110KIT	DN22
TFX11410KIT	DN28



- Kitemark approved
- Can be buried in concrete
- Meter markings

## COILS

Code	Size	Length	Weight
TFX1210BS	DN12	10m	3
TFX1230BS	DN12	30m	6
TFX1275BS	DN12	75m	19
TFX3410BS	DN15	10m	3
TFX3430BS	DN15	30m	7
TFX3475BS	DN15	75m	20
TFX0110BS	DN22	10m	3.5
TFX0130BS	DN22	30m	9
TFX0175BS	DN22	75m	33
TFX11410BS	DN28	10m	4
TFX11430BS	DN28	30m	12
TFX11475BS	DN28	75m	35
TFX11210BS	DN32	10m	7.6
TFX11230BS	DN32	30m	17.6
TFX11275BS	DN32	75m	41



## MALE ADAPTORS

Code	Size
TFXM1238	DN12 x 3/8"
TFXM1512	DN15 x 1/2"
TFXM2034	DN22 x 3/4"
TFXM251	DN28 x 1"
TFXM32114	DN32 x 1-1/4"



## FEMALE ADAPTORS

Code	Size
TFXF1238	DN12 x 3/8"
TFXF1512	DN15 x 1/2"
TFXF2034	DN22 x 3/4"
TFXF251	DN28 x 1"
TFXF32114	DN32 x 1-1/4"

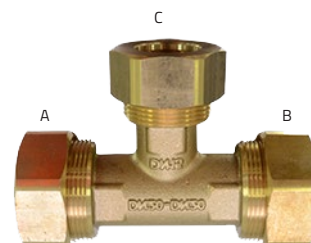

## COMPRESSION ADAPTORS

Code	Size
TFX1215C	DN12 x 15mm
TFX1515C	DN15 x 15mm
TFX1522C	DN15 x 22mm
TFX2022C	DN22 x 22mm
TFX2522C	DN28 x 22mm
TFX2528C	DN28 x 28mm



## TEES

Code	Size (A/B/C)
TFXT201515	DN22 x DN15 x DN15
TFXT201520	DN22 x DN22 x DN15
TFXT20	DN22 x DN22 x DN22
TFXT252020	DN28 x DN22 x DN22
TFXT252520	DN28 x DN22 x DN28
TFXT25	DN28 x DN 28 x DN28



- Protects the exposed hose against possible corrosion

## SELF-AMALGAMATING TAPE

Code	Size
TIFTAPE	25mm x 3m

## COUPLERS

Code	Size
TFXC12	DN12
TFXC15	DN15
TFXC20	DN22
TFXC25	DN28
TFXC32	DN32

Thanks to its flexible corrugated structure, TeslaFlex CSST can easily adopt directional changes through the connection line, requiring no additional fittings (elbows etc.)

The hose may be bent within the limits of bending radius characteristics, although repeat bending must be avoided.

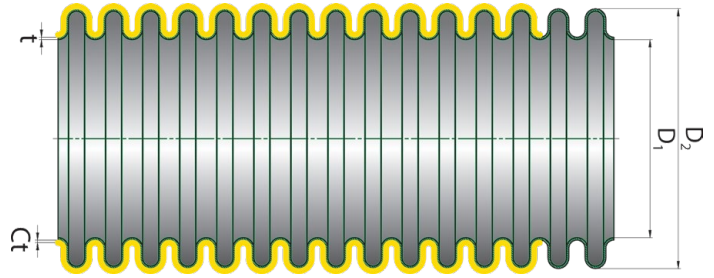

DN	BSPT Thread	Inside Dia. (Nom)mm D1	Jacket Out Dia. (Max)mm D2	Minimum Bending Radius	Recommended Bending Radius
Size	mm	mm	mm	mm	mm
DN12	3/8"	11.8	16.8	20	140
DN15	1/2"	15.5	21.3	28	160
DN22	3/4"	20.7	27.65	32	170
DN28	1"	25.2	33	40	190
DN32	1.1/4"	33.2	41	50	260

- 1 - Flexible metal hose
- 2 - PVC cover
- 3 - Nuts
- 4 - Split ring
- 5 - Fitting body

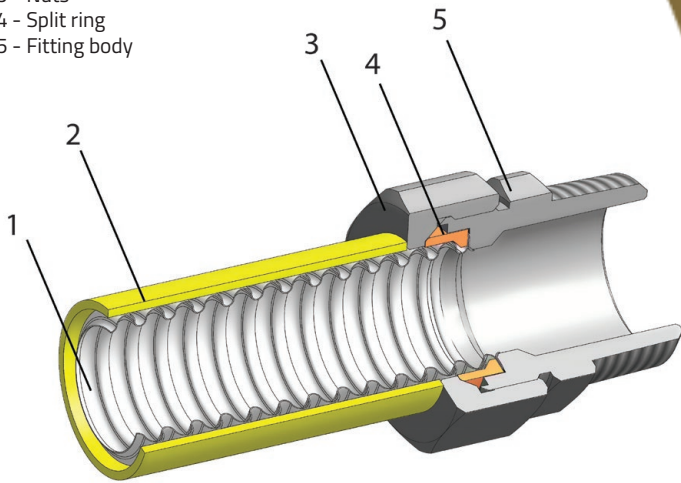

- No specialist tools required
- Flame free
- Connects to existing gas lines
- Time saving
- Cost saving
- Kitemark approved

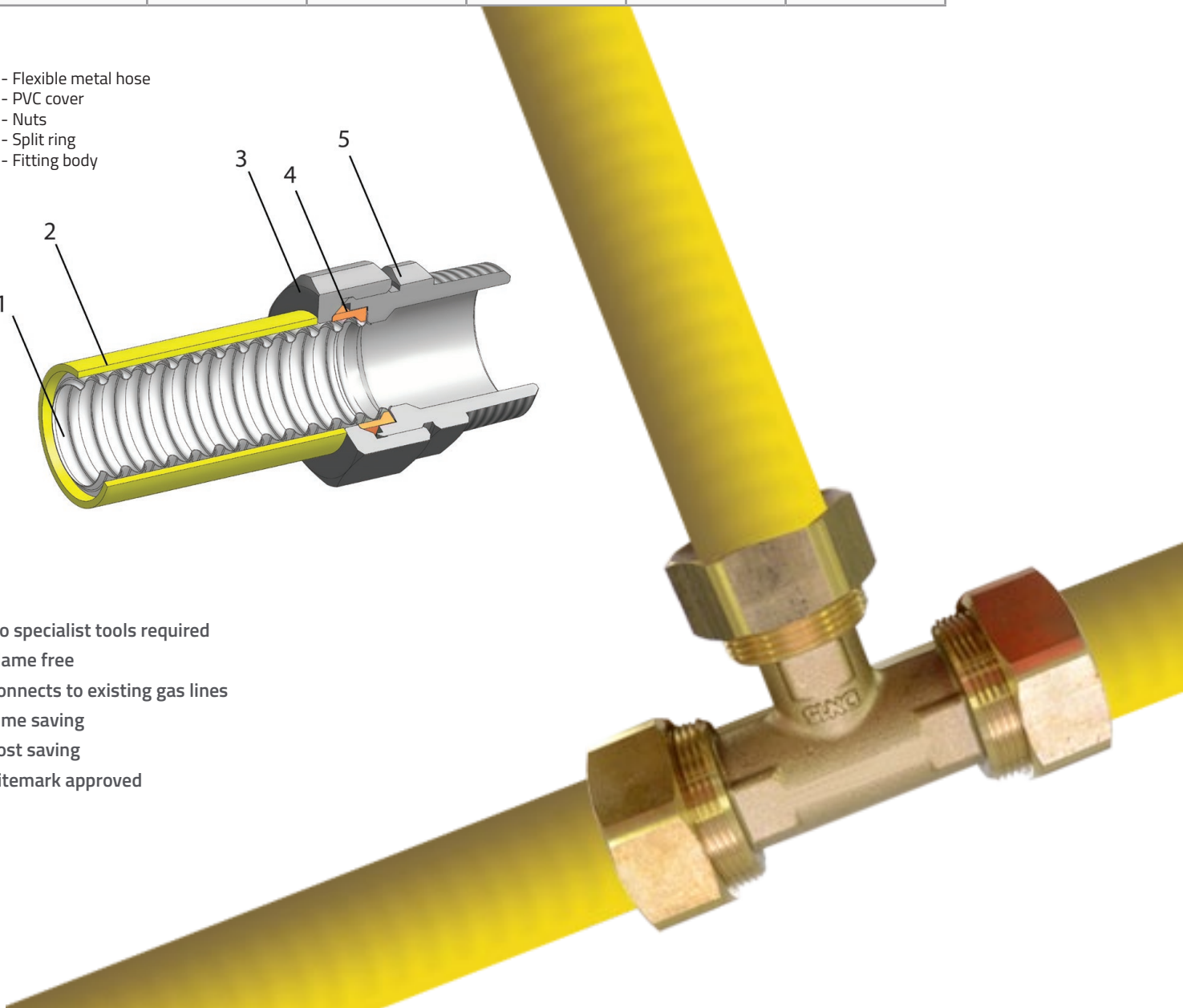

Grooved, allowing fitment of meter brackets.

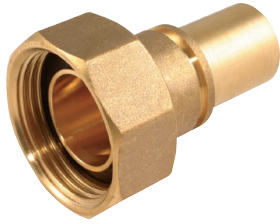

- Manufactured in accordance to BS746:2014
- Supplied with washer

GROOVED METER UNION	
Code	Size
GMU221	22mm x 1"
GM078	22/28mm x 1"

Suitable for either 22mm or 28mm fitting. The 22mm bore allows the pipe to be fitted in the shank. The 28mm outside diameter allows use of a tube coupling.



- Manufactured in accordance to BS746:2014
- Supplied with washer
- Universal

22/28mm METER UNION	
Code	Size
GM077	22/28mm x 1"



- Manufactured in accordance to BS746:2014

METER UNION WASHER	
Code	Size
B353	3/4"
GMUW1	1"
GM079	1-1/4"



METER CAP	
Code	Size
B535	3/4"
B535/1	1"



- Manufactured in accordance to BS746:2014

METER CAP WASHER	
Code	Size
B350	3/4"
B352	1"



SEALING DISC	
Code	Size
B534	3/4"
B534/1	1"



METER BOX KEY	
Code	
GMK	



- Includes low pressure test point
- EN331 approved
- Full bore
- 1/4" turn



## TEST POINT LEVER BALL VALVE

Code	Size	Finish
GT/BVL34	3/4	Nickel
GT/BVL1	1"	Nickel



- Screwdriver operated

## TEST POINT BALL VALVE

Code	Size	Finish
GTBV15	15mm	Brass
GTBV22	22mm	Brass

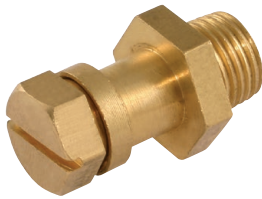

## TEST POINT NIPPLE

Code	Size	Finish
GTN18	1/8"	Brass



## ISOGAS VALVE & TEST POINT

Code	Size
SP330	3/8" Mx F



- Can be used on soldered, compression and crimped fittings
- Reduced cost when fitting into a standard tee
- Save time by only making one joint

## GAS FINGER TEST POINT

Code	Size	Finish
GASFIN	15mm	Brass



## TEST POINT ADAPTOR

Code	Size
SP320	3/8" Mx F



FOR MORE  
FINGER FITTINGS  
SEE PAGE 60



RESTRICTOR TUBES		
Code	Size	Finish
RTC18	8mm x 1m	Chrome
RTC1258	8mm x 1.25m	Chrome
RTBR18	8mm x 1m	Brass



A restrictor elbow may be screwed directly to the floorplate, or can be used with the extension pieces to give extra height.

RESTRICTOR FLOOR PLATE		
Code	Size	Finish
RF18	1/4"	Chrome



RESTRICTOR ELBOW		
Code	Size	Finish
RE18	1" x 8mm	Chrome
RE28	2" x 8mm	Chrome



Kit includes:  
1" x 8mm restrictor elbow, floorplate, extension piece, 2 crush rings, 15mm x 1/4" brass adaptor & 1m x 8mm restrictor tube.

GAS FIRE FIXING KIT		
Code	Size	Finish
GK48TA	8mm	Chrome



Kit includes:  
1" x 8mm restrictor elbow, floorplate, extension piece & 2 crush rings.

RESTRICTOR KIT		
Code	Size	Finish
GK48	8mm	Chrome

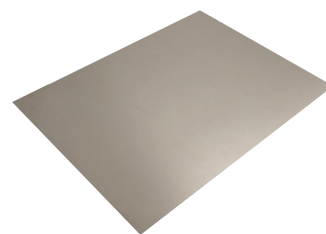

GAS FIRE BACKPLATE		
Code	Size	Finish
AB2418	24" x 18"	Aluminium
AB36	36" x 36"	Aluminium



RESTRICTOR ADAPTOR		
Code	Size	Finish
GA15	15mm x 1/4"	Brass
GA15CP	15mm x 1/4"	Chrome



# 02

## WATER HEATING

18.	Immersion Heaters & Thermostats (2-1/4")
19.	Immersion Heaters & Thermostats (1-3/4")
20.	Willis Type Immersion Heater
22-23.	T-Smart Immersion Heater
24-25.	Commercial & Industrial Immersion Heaters
26-27.	Towel Rail Heating
28-29.	Radiator Valves
30.	Radiator Accessories
31.	Boiler & Cylinder Accessories
32.	vFlow Blow-off Cap
33.	Cylinder Flanges
34-35.	Expansion Vessel Valves & Accessories
36.	TeslaTun Dry Trap Tundish

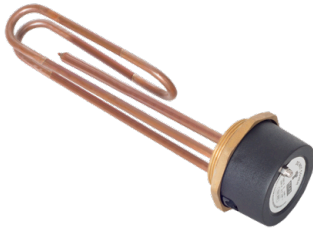

- Not suitable for stainless steel cylinders
- For soft water areas only

COPPER			
Code	Length	Boss	Thermostat
TIH505	11"	2-1/4"	7"
TIH510	14"	2-1/4"	11"
TIH515	18"	2-1/4"	11"
TIH520	23"	2-1/4"	11"
TIH525	27"	2-1/4"	18"
TIH530	30"	2-1/4"	18"
TIH535	36"	2-1/4"	18"



- Not suitable for stainless steel cylinders
- For medium to hard water areas

INCOLOY w/ COPPER POCKET			
Code	Length	Boss	Thermostat
TIH540	11"	2-1/4"	7"
TIH545	14"	2-1/4"	11"
TIH547	18"	2-1/4"	11"
TIH548	23"	2-1/4"	11"
TIH550	27"	2-1/4"	18"
TIH555	30"	2-1/4"	18"
TIH560	36"	2-1/4"	18"



- Suitable for medium to hard water areas

INCOLOY w/ INCOLOY POCKET				
Code	Length	Boss	kW	Stat
TIH640	11"	2-1/4"	3kW	7"
TIH641	11"	2-1/4"	1kW	7"
TIH475	14"	1-1/2"	3kW	11"
TIH645	14"	2-1/4"	3kW	11"
TIH647	18"	2-1/4"	3kW	11"
TIH648	23"	2-1/4"	3kW	11"
TIH642	27"	2-1/4"	1kW	18"
TIH651	27"	2-1/4"	2kW	18"
TIH650	27"	2-1/4"	3kW	18"
TIH655	30"	2-1/4"	3kW	18"
TIH660	36"	2-1/4"	3kW	18"



- Suitable for hard to aggressive water areas

TITANIUM			
Code	Length	Boss	Thermostat
TIH565	11"	2-1/4"	7"
TIH570	14"	2-1/4"	11"
TIH585	27"	2-1/4"	18"



- Not suitable for stainless steel cylinders
- For soft water areas only
- 3kW/2kW

DUAL HEATERS - COPPER			
Code	Length	Cable	Thermostat
TIH460	24"/11"	1m	18"
TIH461	24"/11"	2m	18"
TIH465	27"/11"	1m	18"
TIH466	27"/11"	2m	18"
TIH467	36"/11"	1m	18"
TIH468	36"/11"	2m	18"

- Suitable for medium to hard water areas

DUAL HEATERS - INCOLOY			
Code	Length	Cable	Thermostat
TIH481	24"/11"	2m	18"
TIH486	27"/11"	2m	18"
TIH498	36"/18"	2m	18"

## Tesla UK Rod Stat for Immersion Heaters with Thermal Cut Out

### Tesla TS

The Tesla rod stats are an ideal solution for existing installations as a replacement or to bring your old system up standard by simply changing the thermostat. The rod stat incorporates a secondary safety cut-out, which is independent of the main thermostat limiting water temperature to 98°C should the primary thermostat fail. The second cut-out is non self-resetting, so will need to be manually reset if it has been activated.

Product Code	Length	Range °C	Cut-out °C
TS220	7"	10-70°C	85°C (±5°C)
TS225	11"	25-70°C	85°C (±5°C)
TS230	18"	20-70°C	85°C (±5°C)



## 1-3/4" IMMERSION HEATERS (For Unvented Cylinders)

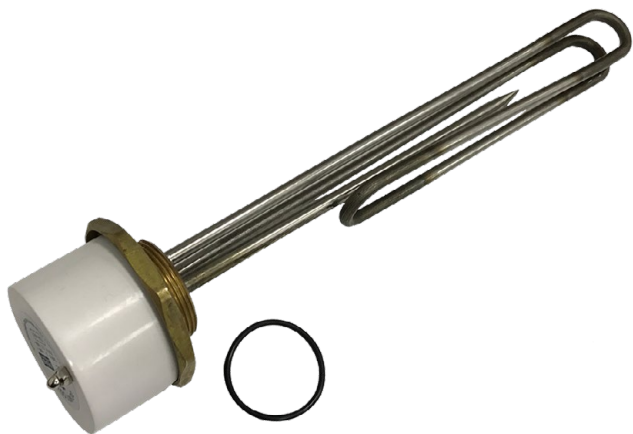

Code	Material	Length	Boss	Thermostat
TIH472PI	Incoloy	11"	1-3/4"	PLUG-IN
TIH476PI	Incoloy	14"	1-3/4"	PLUG-IN
TIH572PI	Titanium	14"	1-3/4"	PLUG-IN



### Tesla TPS

#### ROD THERMOSTATS FOR 1-3/4" HEATERS

Product Code	Brand	Length	Range °C	Cut-out °C
TPS300	Tesla	11"	0-65°C	75°C (±5°C)

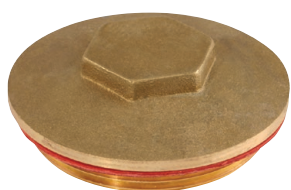

#### IMMERSION HEATER PLUG

Code	Description
IH134	1-3/4" Plug & 'O' Ring
IH214	2-1/4" Plug & Washer

#### FLANGES

Code	Description
BF445	Mechanical Flange & Washer 2-1/4"
BF446	Mechanical Flange Washer 2-1/4"
IH2141	Standard Sweated Flange 2-1/4"

#### WASHERS

Code	Description
IH01	Immersion Heater Fibre Washer 2-1/4"
OR476	Immersion Heater 'O' Ring 1-3/4"
OR525	Immersion Heater 'O' Ring 2-1/4"



**WE OFFER A BESPOKE IMMERSION HEATER SERVICE. PLEASE SEE PAGES 24-25 FOR MORE INFORMATION.**

# INLINE IMMERSION HEATER

For fast, economical domestic hot water

## FEATURES & BENEFITS

- Saves electricity
- Heats the amount of water you require only
- Fits externally to the main hot water cylinder
- Pre-wired



**BEAB**

The Tesla Geeza inline heater is fitted alongside a standard hot water cylinder. Cold water is drawn in from the bottom of the cylinder, heated in the Geeza and returned to the top of the cylinder using convection. As the Geeza is only heating a small amount of water it is heated very quickly and hot water can be drawn off from the cylinder very soon after the Geeza is switched on. Once the required amount of water has been heated the Geeza can be turned off to minimise the amount of energy used.

This feature can be particularly useful if used with solar power. Since solar power only comes available when the panels are in the sun the water in the cylinder may be cold in the morning. With a conventional immersion heater it will be some time before the water is heated to a usable temperature, whereas if a Geeza is fitted then hot water will be available very soon after the solar panels start producing electricity.

Alternatively if the Geeza is left powered up the entire cylinder of water will be heated to the same temperature with no stratification. Stratification in cylinders may be a concern if there is a danger of Legionella bacteria multiplying where a layer of the water is not heated sufficiently. This problem is often addressed with the use of a pump, but a Geeza may be more reliable and cost effective. The lack of stratification may also mean that a smaller cylinder can be used.

- Not suitable for stainless steel cylinders
- For soft water areas only

Code	Fitting	Length	kW
INLINEHEATER1KW	15mm Compression	11"	1kW
INLINEHEATER1KW28	28mm Compression		
INLINEHEATER2KW		11"	2kW
TIH305	15mm Compression	11"	3kW

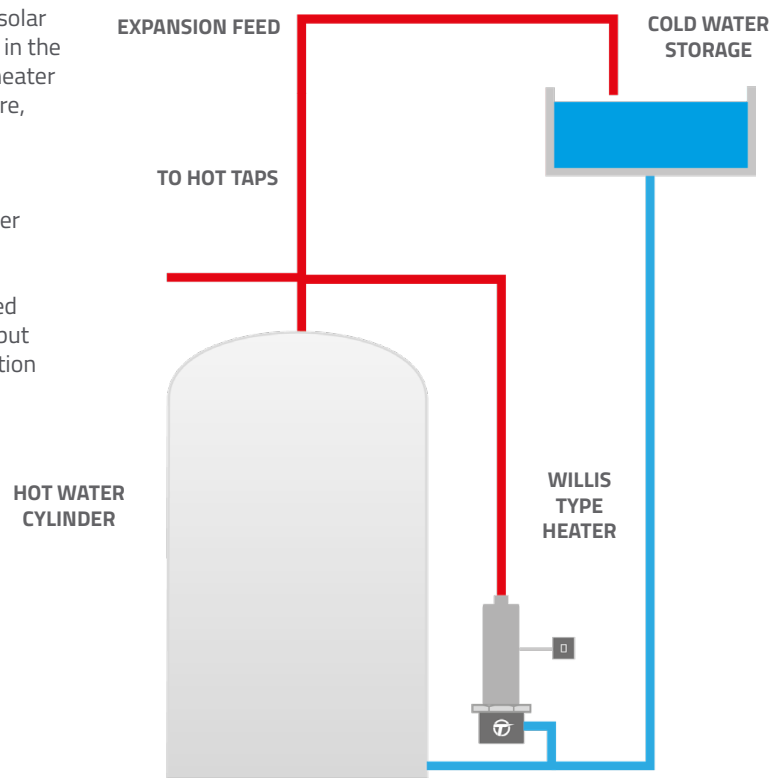

# Choosing the right immersion heater

There are a number of factors that need to be considered when selecting the right immersion heater for your application. Whether it be a vented, unvented, economy 7, solar system, copper or stainless steel cylinder and side or top mounted.

Selection of the boss/head size, kW requirement, length of the immersion heater, and finally the correct immersion heater material that is conducive to the water hardness in your geographical area.

Information of suitability and a map illustrating levels of water hardness are detailed below.

If you need assistance in selecting the correct element please call our technical helpline: 0121 686 8733.



All our immersion heaters are BEAB Approved and compliant with BS EN 60335-2-73 and are fitted with a dual function thermostat to control water temperature and protect against over temperature.

Soft water areas - Fit copper.

Moderate to hard - We recommend fitting either incoloy or titanium.

Hard to very hard - Incoloy will suffice but we highly recommend fitting titanium which will last longer.

## Water hardness map

-  *Hard to very hard*
-  *Moderate to hard*
-  *Soft*

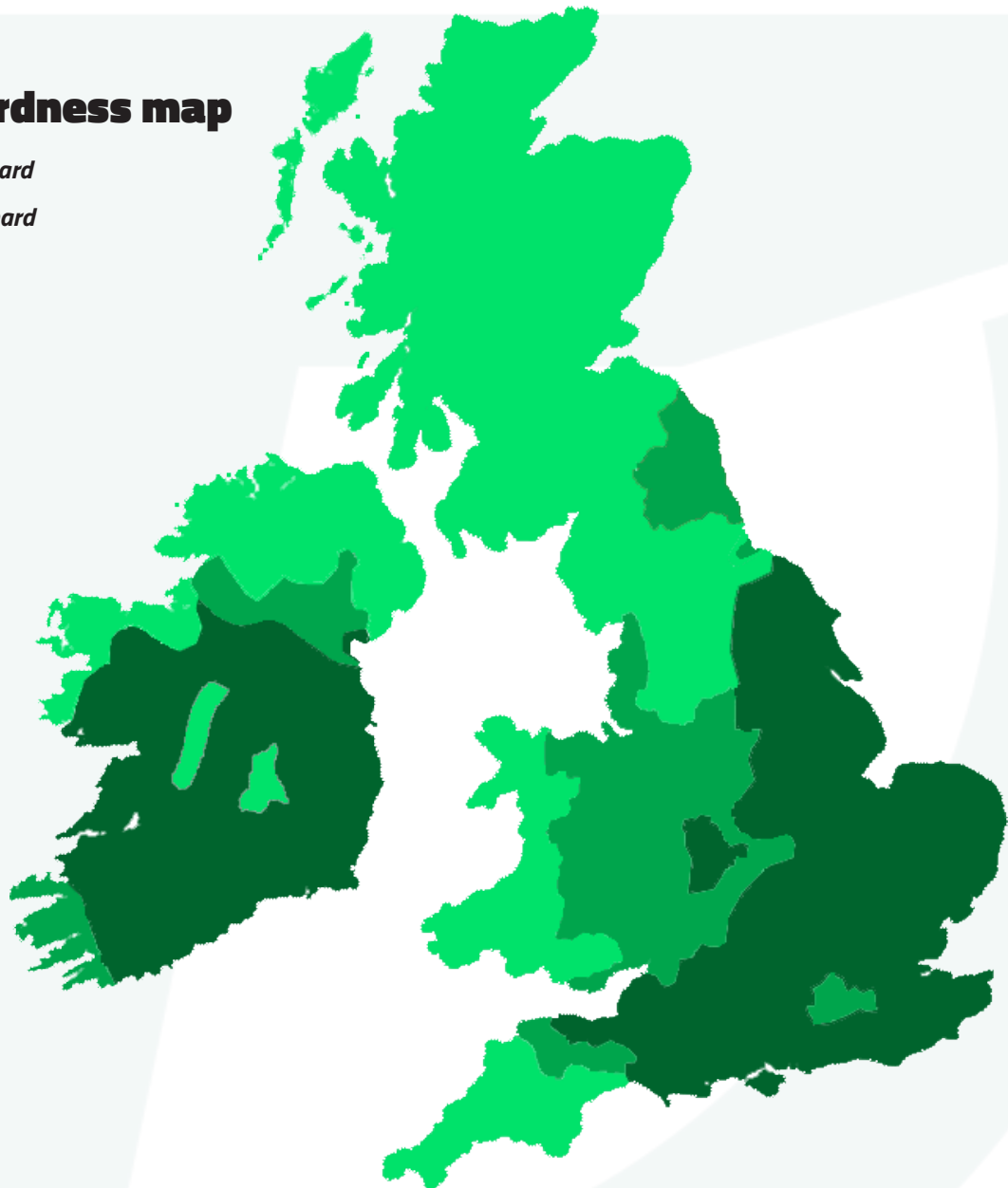

The T-Smart learning hot water thermostat provides hot water when you need it, reducing energy wastage by managing your hot water usage.

## THE RANGE

Code	Description	Boss	Length	kW
TIHTS476	Incoloy Immersion Heater & T-Smart	1-3/4"	14"	3kW
TIHTS572	Titanium Immersion Heater & T-Smart	1-3/4"	14"	3kW
TIHTS496	Incoloy Immersion Heater & T-Smart	2-1/4"	14"	3kW
TIHTS	T-Smart (no element)			



### CONTROL FROM ANYWHERE

Once connected to your WiFi router, the T-Smart thermostat can be controlled via the mobile application. You can choose the function required, set time programmes and even activate or deactivate travel mode to conserve energy whilst travelling.

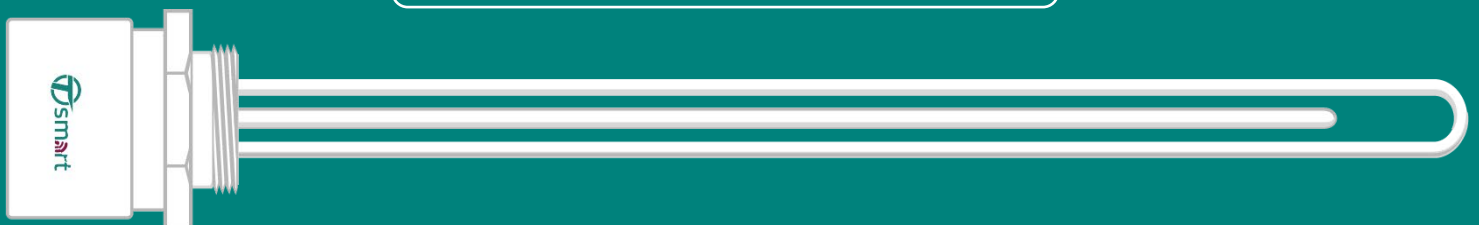



# FUNCTIONS

- MANUAL** Simple on/off and temperature control.
- ECO** Set at 55° to ensure energy efficiency.
- SMART** The learning function will provide hot water when it's needed based on historical use.
- TIMER** Allows a seven day timer plan to be set removing the need for a separate time clock or controller.
- HOLIDAY** Sets the tank to 10° with anti freeze protection to save energy whilst travelling.

## Anti-Legionella

The Anti Legionella function is built into each mode of the T-Smart. Giving you peace of mind that your system will be protected from bacteria. This function ensures the system carries out pasteurisation at least once every 15 days.

## Connectivity

Once connected to your WiFi router, the T-Smart thermostat can be controlled via the mobile application. You can chose the function required, set time programmes and even activate or deactivate travel mode to conserve energy whilst travelling.

## Energy Efficient

Smart, Eco and Holiday mode offer differing energy efficiency benefits for your system whilst built in protection will ensure bacteria growth is controlled and freeze protection is covered.

## Frost Protection

The frost protection function will ensure your hot water tank is protected and prevents the stored water from falling below 10°C.

## Programmer

Built in features such as on/off at set times and a 7 day built in programmer with easy view weekly/daily display. Unlimited time and temperature settings gives the homeowner complete flexibility and control.



### What's in the box?

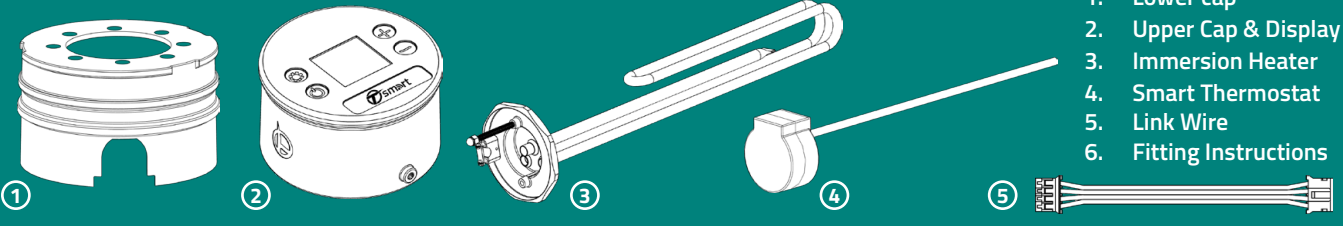

1. Lower cap
2. Upper Cap & Display
3. Immersion Heater
4. Smart Thermostat
5. Link Wire
6. Fitting Instructions

For more information  
**Sales: 0121 686 8711**  
**Technical: 0121 686 8733**

# Commercial Immersion Heaters

The Thermco Commercial Immersion Heaters are designed for commercial use on both single and three phase applications.

Our Commercial range are fitted with an IP55 rated aluminium splash proof cover, have a 20mm cable gland and come with Control and High Limit Thermostats fitted as standard. Constructed from a hot stamped brass flange, stainless steel thermostat pockets, Incoloy or Titanium elements and with regulation and high limit thermostats fitted as standard.

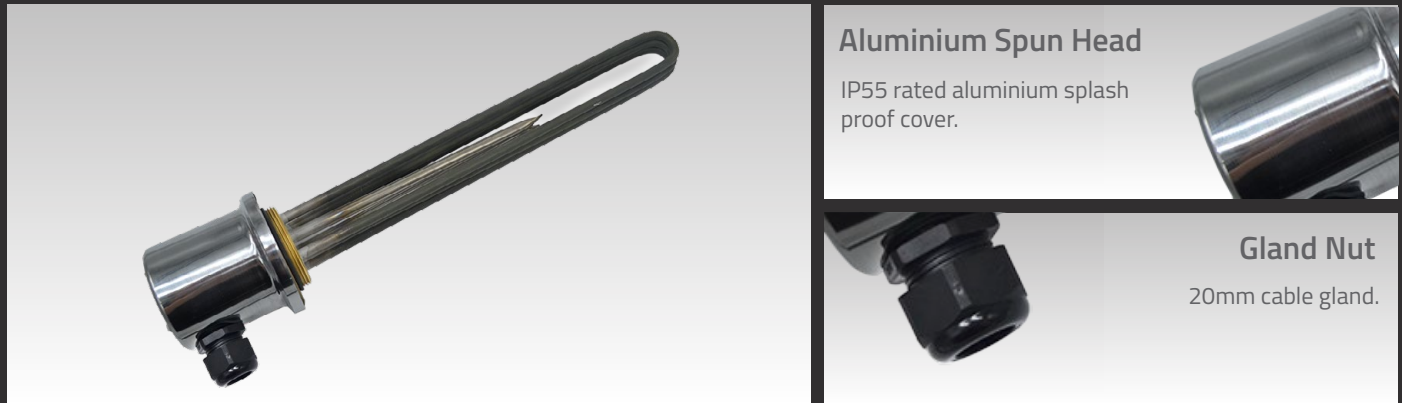

**TYC Range - K Lid with TSDR Thermostat**

Code	Size	Material	kW Rating	Length (mm)
31027-WTYSC	1-1/2"	Incoloy	3kW 1/3 Phase	270
32040-WTYSC	1-1/2"	Incoloy	6kW 1/3 Phase	400
33040-WTYSC	1-1/2"	Incoloy	9kW 1/3 Phase	400
34040-WTYSC	1-1/2"	Incoloy	12kW 1/3 Phase	400

**TYT Range - K Lid with Twin Thermostats**

Code	Size	Material	kW Rating	Length (mm)
31027-XYTST	1-3/4"	Incoloy	3kW 1/3 Phase	270
32040-XYTST	1-3/4"	Incoloy	6kW 1/3 Phase	400
33040-XYTST	1-3/4"	Incoloy	9kW 1/3 Phase	400
34040-XYTST	1-3/4"	Incoloy	12kW 1/3 Phase	400
36090-XYTST	1-3/4"	Incoloy	18kW 3 Phase	900
31027-YTYST	2"	Incoloy	3kW 1/3 Phase	270
32040-YTYST	2"	Incoloy	6kW 1/3 Phase	400
33040-YTYST	2"	Incoloy	9kW 1/3 Phase	400
34040-YTYST	2"	Incoloy	12kW 1/3 Phase	400
31027-ZTYST	2-1/4"	Incoloy	3kW 1/3 Phase	270
32040-ZTYST	2-1/4"	Incoloy	6kW 1/3 Phase	400
33040-ZTYST	2-1/4"	Incoloy	9kW 1/3 Phase	400
34040-ZTYST	2-1/4"	Incoloy	12kW 1/3 Phase	400
36090-ZTYST	2-1/4"	Incoloy	18kW 3 Phase	900

**TTT Range - K Lid with Twin Thermostats**

Code	Size	Material	kW Rating	Length (mm)
31027-XTTST	1-3/4"	Titanium	3kW 1/3 Phase	270
32040-XTTST	1-3/4"	Titanium	6kW 1/3 Phase	400
33040-XTTST	1-3/4"	Titanium	9kW 1/3 Phase	400
34040-XTTST	1-3/4"	Titanium	12kW 1/3 Phase	400
36090-XTTST	1-3/4"	Titanium	18kW 3 Phase	900
31027-XTTST	2"	Titanium	3kW 1/3 Phase	270
32040-XTTST	2"	Titanium	6kW 1/3 Phase	400
33040-XTTST	2"	Titanium	9kW 1/3 Phase	400
34040-XTTST	2"	Titanium	12kW 1/3 Phase	400
31027-XTTST	2-1/4"	Titanium	3kW 1/3 Phase	270
32040-XTTST	2-1/4"	Titanium	6kW 1/3 Phase	400
33040-XTTST	2-1/4"	Titanium	9kW 1/3 Phase	400
34040-XTTST	2-1/4"	Titanium	12kW 1/3 Phase	400
36090-XTTST	2-1/4"	Titanium	18kW 3 Phase	900



# Industrial IP65 Immersion Heaters



The Thermco Industrial Immersion Heaters are designed for commercial use on both single and three phase applications.

Our Industrial range are fitted with an IP65 rated two piece cast cover, have a 20mm cable gland and come with Control and High Limit Thermostats fitted as standard. Constructed from a hot stamped brass flange, stainless steel thermostat pockets, Incoloy or Titanium elements and with regulation and high limit thermostats fitted as standard.

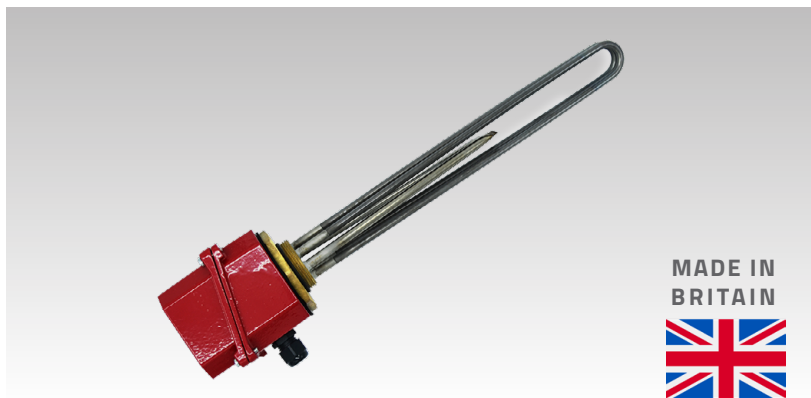

MADE IN  
BRITAIN



## Cast Iron Head

IP65 rated two piece cast cover.

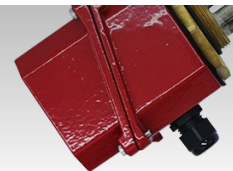

## Gland Nut

20mm cable gland.

### RYC Range - Red Lid with TSDR Thermostat

Code	Size	Material	kW Rating	Length (mm)
31027-WRYSC	1-1/2"	Incoloy	3kW 1/3 Phase	270
32040-WRYSC	1-1/2"	Incoloy	6kW 1/3 Phase	400
33040-WRYSC	1-1/2"	Incoloy	9kW 1/3 Phase	400
34040-WRYSC	1-1/2"	Incoloy	12kW 1/3 Phase	400

### RYT Range - Red Lid with Twin Thermostats

Code	Size	Material	kW Rating	Length (mm)
31027-XRYST	1-3/4"	Incoloy	3kW 1/3 Phase	270
32040-XRYST	1-3/4"	Incoloy	6kW 1/3 Phase	400
33040-XRYST	1-3/4"	Incoloy	9kW 1/3 Phase	400
34040-XRYST	1-3/4"	Incoloy	12kW 1/3 Phase	400
36090-XRYST	1-3/4"	Incoloy	18kW 3 Phase	900
31027-YRYST	2"	Incoloy	3kW 1/3 Phase	270
32040-YRYST	2"	Incoloy	6kW 1/3 Phase	400
33040-YRYST	2"	Incoloy	9kW 1/3 Phase	400
34040-YRYST	2"	Incoloy	12kW 1/3 Phase	400
31027-ZRYST	2-1/4"	Incoloy	3kW 1/3 Phase	270
32040-ZRYST	2-1/4"	Incoloy	6kW 1/3 Phase	400
33040-ZRYST	2-1/4"	Incoloy	9kW 1/3 Phase	400
34040-ZRYST	2-1/4"	Incoloy	12kW 1/3 Phase	400
36090-ZRYST	2-1/4"	Incoloy	18kW 3 Phase	900

### RTT Range - Red Lid with Twin Thermostats

Code	Size	Material	kW Rating	Length (mm)
31027-XRTST	1-3/4"	Titanium	3kW 1/3 Phase	270
32040-XRTST	1-3/4"	Titanium	6kW 1/3 Phase	400
33040-XRTST	1-3/4"	Titanium	9kW 1/3 Phase	400
34040-XRTST	1-3/4"	Titanium	12kW 1/3 Phase	400
36090-XRTST	1-3/4"	Titanium	18kW 3 Phase	900
31027-YRTST	2"	Titanium	3kW 1/3 Phase	270
32040-YRTST	2"	Titanium	6kW 1/3 Phase	400
33040-YRTST	2"	Titanium	9kW 1/3 Phase	400
34040-YRTST	2"	Titanium	12kW 1/3 Phase	400
31027-ZRTST	2-1/4"	Titanium	3kW 1/3 Phase	270
32040-ZRTST	2-1/4"	Titanium	6kW 1/3 Phase	400
33040-ZRTST	2-1/4"	Titanium	9kW 1/3 Phase	400
34040-ZRTST	2-1/4"	Titanium	12kW 1/3 Phase	400
36090-ZRTST	2-1/4"	Titanium	18kW 3 Phase	900

## TOWEL RAIL ELEMENTS

For use with plumbed and non-plumbed towel rails. Must be hard wired to fused spur.

BEAB approved EN 60335-1 : 2002; EN 50366 : 2003

Includes:

- Chrome 'T' piece for dual fuel systems
- Chrome blanking plug
- Chrome and white caps
- Pre-wired
- 800mm cable



TOWEL RAIL ELEMENTS		
Code	Wattage	Length
TR11	150w	295mm
TR12	200w	340mm
TR13	250w	340mm
TR14	300w	425mm
TR15	400w	395mm
TR16	500w	495mm
TR27-6	600w	695mm
TR27-8	800w	695mm

NEW Retail Packaging



SEE PAGE 28 FOR TOWEL RAIL VALVES



### DUAL FUEL ELBOW

Code	Description
DFELB	1/2" Dual Fuel Elbow



### DUAL FUEL TEE

Code	Description
8T15	1/2" Dual Fuel Tee



### RADIATOR PLUG

Code	Description
RP12C	1/2" Chrome Plug & 'O' Ring

## THERMAL CONTROL PLATE

This towel rail control plate by Tesla UK is used to control the output of your towel rail element. The towel rail element can be wired directly into this control plate, in the bathroom (IPX5 rated).

This control gives you five increments of control, from 20% up to 100%, indicated by the LED lights. The 2 hour boost function switches the element to full power for 2 hours, then reverts to the previous setting.

THERMAL CONTROL PLATE	
Code	Description
TCP200	IPX5 Thermal Controller
TCPCP	Chrome cover for TCP200

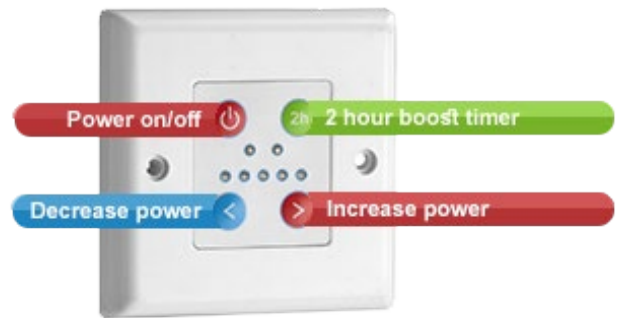



## CONTEMPORARY TOWEL RAIL VALVES

Code	Size	Finish
OPTIMACCA15	15mm Angled	Chrome
OPTIMACCS15	15mm Straight	Chrome

## TRADITIONAL TOWEL RAIL VALVES

Code	Size	Finish
OPTIMATTA15	15mm Angled (Pair)	Chrome
OPTIMATTS15	15mm Angled (Pair)	Chrome



- Allows pipework to remain hidden
- With a 1/2" female thread on the bottom of the valves, the towel rail element can go straight through the valve. One of the neatest ways to do a dual fuel installation on a towel rail.

## MINIMALISTIC TOWEL RAIL VALVES

Code	Size	Finish
OPTIMAMMA15	15mm Angled	Chrome
OPTIMAMMS15	15mm Straight	Chrome

## DUEL FUEL CORNER TOWEL RAIL VALVES

Code	Size	Finish
DFTRV	15mm x 1/2"	Chrome



## VERONA TOWEL RAIL VALVES

Code	Description	Finish
RVVERA	15mm x 1/2" Angled (Pair)	White
RVVERS	15mm x 1/2" Straight (Pair)	White



## STANDARD

Code	Size
RV10S	10mm Straight
RV15	15mm Angled
RV15S	15mm Straight



## STANDARD WITH DRAIN-OFF

Code	Size
RVD08	8mm Angled
RVD10	10mm Angled
RVD15	15mm Angled



- PTFE coated tail
- Non-rising spindle

## PREMIER

Code	Size
RVP10	10mm Angled
RVP15	15mm Angled



- PTFE coated tail
- Non-rising spindle

## PREMIER WITH DRAIN-OFF

Code	Size
RVP10D	10mm Angled
RVP15D	15mm Angled



- PTFE coated tail
- Non-rising spindle

## PREMIER WITH DRAIN-OFF

Code	Size
RVP15CPH	15mm Angled
RVP15SCPH	15mm Angled



- Positive shut-off
- Bi-directional valve
- Lockshield included
- Removable inserts at the bottom allow the valves to take either 15mm pipe or 1/2" thread.

## WINCHESTER RADIATOR VALVES

Code	Size	Finish
RVWINB	15mm x 1/2"	Brass
RVWINN	15mm x 1/2"	Nickel



Used to connect radiator valves to radiators.

- 15mm chrome plated shank with nut & olive
- Can be cut to length

### RIGID EXTENSION PIECES

Code	Length
RVEX1260	60mm
RVEX12100	100mm



### TELESCOPIC EXTENSION PIECES

Code	Length
RVEX1230T	Upto 50mm
RVEX1260T	Upto 70mm



### RADIATOR TAILS

Code	Size
BF460	20mm
RVEX1540	40mm



### RADIATOR BRACKET

Code	Description
RADBKT	Universal Radiator Bracket (Pack of 4)



### 3-WAY ALLEN KEY

Code	Description
TL010	3-Way Radiator Allen Key



### COMPRESSION AIR VENT

Code	Size	Finish
BF420	15mm	Brass



### CAPILLARY AIR VENT

Code	Size	Finish
AV15	15mm	Brass
AV22	22mm	Brass



### SLIP AIR RELEASE PLUG

Code	Size
BSARPLUG15	15mm



SEE PAGE 55 FOR BOTTLE AIR VENTS



### UNIVERSAL RADIATOR CAP

Code	Colour
RVCAP	White



### RADIATOR KEYS

Code	Description/Colour
BF428	Alloy
RK1	T Handle Brass
RK1C	Clock Type



### RADIATOR AIR VENTS

Code	Size	Finish
AV18B	1/8"	Brass
AV14B	1/4"	Brass
CPAV12	1/2"	Chrome
AV12	1/2"	Brass
AV12DIR	1/2"	White/Chrome
RVPLUGSET12	1/2"	Directional Air Vent & Plug Kit



### AUTO RADIATOR AIR VENTS

Code	Size	Description
AV18	1/8"	Chrome
HV30C	1/2"	Aladdin Pack of 2 Chrome
HV30CBP	1/2"	Aladdin Autovent & Plug Chrome



## IMMERSION HEATER PLUG

Code	Description
IH134	1-3/4" Plug & 'O' Ring
IH214	2-1/4" Plug & Washer



## FLANGES

Code	Description
BF445	Mechanical Flange & Washer 2-1/4"
BF446	Mechanical Flange Washer 2-1/4"
IH2141	Standard Sweated Flange 2-1/4"



## WASHERS

Code	Description
IH01	Immersion Heater Fibre Washer 2-1/4"
OR476	Immersion Heater 'O' Ring 1-3/4"
OR525	Immersion Heater 'O' Ring 2-1/4"



## BYPASS VALVES

Code	Description
ABV22	22mm Angled
ABVS22	22mm Straight



- Allows the end user to check the system pressure and fill/top-up in a more convenient location
- Back-flow prevention
- Supplied with 4bar gauge, double check valve, service valve, hose & blanking caps

## FILLING LOOP WITH GAUGE

Code	Description
CBFLSG	Remote Filling Loop with Gauge



## FILLING LOOPS

Code	Description
CBFLS	Straight 9.5mm Part L
CBFLT	Tee 9.5mm Part L
CV3S	Straight 9.5mm Heavy Pattern
CVBS	Straight 9.5mm Bore

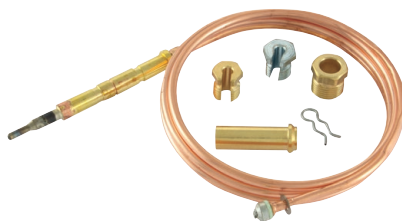

## THERMOCOUPLES

Code	Size	Description
SUTC	900mm	Super Universal
T20-900	900mm	Standard Universal



## DUAL CYLINDER THERMOSTAT

Code
DUALCT



## SAFETY RELIEF VALVES

Code	Size
SP505	1/2" FxF 3bar
SP506	1/2" FxF 6bar
SRV12M	1/2" MxF 3bar



Code	Size
SRV312	1/2" MxF 3bar w/ Gauge Port



## SPRING SAFETY VALVE

Code	Size
SV12	1/2"

EXCLUSIVE



## vFLOW PRV Blow-off Cap

For a quick and easy installation of pressure relief valves (PRVs.)

- Cost competitive with the traditional method of swan necking
- Can be installed internally (useful when working at heights)
- One fitting, single solder joint
- Cuts installation time
- Low profile

vFlow PRV Blow-off Cap	
Code	Size
VFLOW15	15mm
VFLOW22	22mm





## Leamington Flanges

Designed to provide an independent hot water supply and to dramatically reduce air surging, noise and temperature variations. With a dipped stem that will take water from within the cylinder to pre-vent air being taken into the shower circuit, thus preventing potential damage to the pump, shower or mixers.

- Reduces aeration of hot water
- Reduces airlocks in shower pumps & power showers
- Easily installed on standard cylinders



MALE CYLINDER FLANGES	
Code	Size
LF34M	3/4" BSP Male
LF1M	1" BSP Male
LF1F	1" BSP Female

FEMALE CYLINDER FLANGES	
Code	Size
LF1F	1" BSP Female

### NEW Blister Packs



## Ultimo Cylinder Flange

The Ultimo cylinder flange has been designed to ensure that the hot water supply to your shower is maintained when hot water taps are turned on while the shower is in use.

### Suitable for:

- Dedicated supply to specific outlets
  - Power showers
  - Booster pumps
  - Mixer showers
  - Thermostatic mixers
- Reduces aeration of hot water
  - Reduces airlocks in shower pumps & power showers
  - Integrated air baffle
  - Easily installed on standard cylinders



CYLINDER FLANGES	
Code	Size
UF221M	1" MI x 3/4" FI BSP

## EXPANSION VESSEL SERVICE VALVE

**EXCLUSIVE**

Saving you time and money when servicing or replacing an expansion vessel

- Isolate without having to drain down the whole system
- No need to add inhibitor back into the system
- Allows the vessel to be isolated and drained for essential periodic servicing and re-charging
- Shut off and drain, for membrane expansion vessels in sealed heating and cooling systems
- Protected shut/open facility against inadvertent closing
- Anti-tamper lever
- Drain vessel contents according to EN 12828
- Can be used in conjunction with the Tesla Sealed System Installation Kit (EVCKIT)
- Supplied with washer and locking wire
- Swivel nut for ease of installation
- Includes swivel drain off



Code	Description	Size
EVSV	Expansion Vessel Service Valve	3/4"



Includes:

- Filling loop with caps
- Valve
- Nut, washer & olive
- Gauge

### SEALED SYSTEM INSTALLATION KIT

Code	Description
EVCKIT	Sealed system installation kit



Includes:

- Bracket (holds up-to 25ltr vessels)
- Jubilee clip
- Rawl plugs
- Screws

### VESSEL MOUNTING BRACKET KIT

Code	Description
EVMBKIT	Expansion Vessel Mounting Bracket Kit

**NEW**



- Single diaphragm design
- Patented stainless steel or Noryl water connection
- Two-part polyurethane, epoxy primed paint finish
- Leak free, O-ring sealed air valve cap
- Comprehensive testing
- No maintenance

### SHOCK ARRESTOR

Code	Description
HGNSA	0.16LX Shock Arrestor 1/2"

## EXPANSION VESSEL FIXING BAR KIT



**EXCLUSIVE**

**NEW**

The T-Bar from Tesla UK Ltd, is the perfect item to accompany your expansion vessel. Our expansion vessel fixing bar provides the complete solution for the hanging of expansion vessels up to 25 litres and comes complete with our Expansion Vessel Service Valve. Our T-BARKIT allows for the expansion vessel to be firmly and accurately connected to the heating system.

### What's Included

1. Manual Air Vent
2. Expansion Vessel Service Valve
3. 3/4" thread for direct connection to an Expansion Vessel
4. 3bar Pressure Relief Valve with Gauge
5. 15mm System Inlet
6. Wall fixing backplate



### EXPANSION VESSEL FIXING BAR

Code	Description
T-BARKIT	Expansion Vessel Fixing Bar Kit
T-BAR	Wall Fixing Bar ONLY

**EXCLUSIVE**

## DRY TRAP TUNDISH

Eliminates the need to install both a tundish and a dry trap providing you with the all-in-one-solution.

- Type AA back-flow prevention
- Visual means of discharge
- 15x22mm compression connections. 15x32mm connects directly onto the waste pipe without the need to adapt
- Ideal for use with an unvented water heater or boiler relief valve discharge
- Operates under full bore discharge or only a few drips
- Faster, easier and cost effective installation
- The all in one solution - no need for additional traps

### DRY TRAP TUNDISH

Code	Size
DTUN1522	15 x 22mm
DTUN1532	15 x 32mm

### Suitable for:

- Instant hot water taps
- Boilers
- Cylinders
- Water heaters (under sink)



# 03

## PIPE CLIPS & ACCESSORIES

38.	Brass Clips
39.	Backplates
39.	Copper Saddle Clips
39	All Round Galvanised Banding
39	Pipe Collars
39.	Worm Drive Hose Clamps
40.	Rubber Lined Clips & Accessories



- Polished Brass/Chrome
- Die Cast
- M10

## MUNSEN RINGS

Code	Size	Finish	Bag	Box
MR15	15mm	Brass	50	900
MR15CP	15mm	Chrome	50	800
MR1518	15mm (1/8" BSP)	Brass	50	800
MR22	22mm	Brass	50	700
MR22CP	22mm	Chrome	50	500
MR2218	22mm (1/8" BSP)	Brass	50	500
MR28	28mm	Brass	25	450
MR28CP	28mm	Chrome	25	400
MR35	35mm	Brass	25	300
MR35CP	35mm	Chrome	25	250
MR42	42mm	Brass	25	250
MR42CP	42mm	Chrome	25	200
MR54	54mm	Brass	10	150
MR54CP	54mm	Chrome	10	200
MR67	67mm	Brass	5	50
MR76	76mm	Brass	5	50
MR108	108mm	Brass	5	50



- Polished Brass/Chrome
- Die Cast
- M10

## DOUBLE MUNSEN RINGS

Code	Size	Finish	Bag	Box
MR15D	15mm	Brass	50	800
MR22D	22mm	Brass	50	600
MR28D	28mm	Brass	25	400
MR35D	35mm	Brass	25	200



- Polished Brass/Chrome
- Die Cast

## SCREW TO WALL

Code	Size	Finish	Bag	Box
SO15	15mm	Brass	50	800
SO15CP	15mm	Chrome	50	600
SO22	22mm	Brass	50	450
SO22CP	22mm	Chrome	50	400
SO28	28mm	Brass	50	300
SO28CP	28mm	Chrome	50	250
SO35	35mm	Brass	25	250
SO35CP	35mm	Chrome	25	200
SO42	42mm	Brass	10	150
SO42CP	42mm	Chrome	10	100
SO54	54mm	Brass	10	100
SO54CP	54mm	Chrome	10	100



- Polished Brass/Chrome
- Die Cast
- 1/4" BSPP Threads

## DUAL PURPOSE

Code	Size	Finish	Bag	Box
DPBSP15	15mm	Brass	50	450
DPBSP15CP	15mm	Chrome	50	500
DPBSP22	22mm	Brass	25	400
DPBSP22CP	22mm	Chrome	25	250
DPBSP28	28mm	Brass	25	300
DPBSP28CP	28mm	Chrome	25	250
DPBSP35	35mm	Brass	25	200
DPBSP35CP	35mm	Chrome	25	200
DPBSP42	42mm	Brass	10	150



## PRESSED SCREW-ON

Code	Size	Finish	Bag	Box
SOPB12	12mm	Brass	50	500
SOPB15	15mm	Brass	50	800
SOPB15CP	15mm	Chrome	50	500
SOPB22	22mm	Brass	50	500
SOPB22CP	22mm	Chrome	50	500
SOPB28	28mm	Brass	25	300
SOPB28CP	28mm	Chrome	50	400
SOPB35	35mm	Brass	20	250
SOPB35CP	35mm	Chrome	20	200
SOPB42	42mm	Brass	10	150
SOPB42CP	42mm	Chrome	10	150
SOPB54	54mm	Brass	10	100
SOPB54CP	54mm	Chrome	10	100



## HOSPITAL BRACKETS

Code	Size	Finish	Bag	Box
HB15	15mm	Brass	25	400
HB15CP	15mm	Chrome	25	250
HB22	22mm	Brass	25	300
HB22CP	22mm	Chrome	25	200
HB28	28mm	Brass	10	100
HB28CP	28mm	Chrome	10	100
HB35	35mm	Brass	10	100
HB35CP	35mm	Chrome	10	100
HB42	42mm	Brass	10	100
HB42CP	42mm	Chrome	10	100



**SEE PAGE 78 FOR  
MALLEABLE IRON  
PIPE CLIPS**



- Polished Brass/Chrome
- M10

### MUNSEN RING BACK PLATES

Code	Size	Finish	Bag	Box
MP10	M10 Male	Brass	50	800
MP10CP	M10 Male	Chrome	50	800
FP10	M10 Female	Brass	100	1000
FP10CP	M10 Female	Chrome	100	1000
MRBSP18	1/8" Male	Brass	50	800
MPBSP14	1/4" Male	Brass	40	800
FPBSP14	1/4" Female	Brass	50	400



Fits between a male backplate and munsen ring. Used to extend the munsen ring further off the wall (ideal when using lagging.)

### MUNSEN RING EXTENSION PIECES

Code	Size	Finish	Bag	Box
MREXT	M10	Brass	50	600
MREXTCP	M10	Chrome	50	600



### WORM DRIVE HOSE CLAMPS

Code	Size
HC8-12	8-12mm
HC10-16	10-16mm
HC12-20	12-20mm
HC16-25	16-25mm
HC20-32	20-32mm
HC25-40	25-40mm



### COPPER SADDLES

Code	Size	Finish	Bag	Box
CS8	8mm	Copper	100	6000
CS10	10mm	Copper	100	5000
CS15	15mm	Copper	100	2000
CS15CP	15mm	Chrome	100	2000
CS22	22mm	Copper	100	2000
CS22CP	22mm	Chrome	100	2000
CS28	28mm	Copper	100	1500
CS35	35mm	Copper	100	1500
CS42	42mm	Copper	100	1000
CS54	54mm	Copper	100	1000



### COPPER SADDLES - 2 PIECE

Code	Size	Finish	Bag	Box
CS215	15mm	Copper	100	800
CS215CP	15mm	Chrome	100	800
CS222	22mm	Copper	100	500
CS222CP	22mm	Chrome	100	500



### STEEL SADDLES

Code	Size	Finish	Bag	Box
SS12	1/2"	SS	100	2000
SS34	3/4"	SS	100	1000
SS1	1"	SS	100	1000
SS114	1-1/4"	SS	100	1000
SS112	1-1/2"	SS	100	500
SS2	2"	SS	100	300



- Supplied in protective casing

### ALL ROUND GALVANISED BANDING

Code	Size	Length	Box
ARB12	12mm wide x 0.8mm	10m	20
ARB17	17mm wide x 0.8mm	10m	20



### PIPE COLLARS

Code	Size	Finish	Bag	Box
PC10W	10mm	White	25	1950
PC10C	10mm	Chrome	25	1950
PC15W	15mm	White	25	1300
PC15C	15mm	Chrome	25	1300
PC22W	22mm	White	25	800
PC22C	22mm	Chrome	25	800
PC28W	28mm	White	25	800
PC28C	28mm	Chrome	25	800



- Chrome plated copper tube x 2
- Plastic collars x 2

### RADIATOR TUBES & COVERS

Code	Description
RVTC	Radiator Tubes & Covers



- Anti-vibration
- Universal M8/M10
- Mild Steel, Zinc Plated

## MUNSEN RINGS

Code	Size	Box
RLC1419	14-19mm	230
RLC2025	20-25mm	220
RLC2631	26-31mm	180
RLC3236	32-36mm	140
RLC3843	38-43mm	200
RLC4751	47-51mm	100
RLC5358	53-58mm	140
RLC6064	60-64mm	165
RLC6872	68-72mm	120
RLC7580	75-80mm	100
RLC8186	81-86mm	100
RLC8792	87-92mm	80
RLC99105	99-105mm	75
RLC109112	109-112mm	55
RLC113118	113-118mm	55
RLC125130	125-130mm	60
RLC132137	132-137mm	50
RLC138142	138-142mm	50
RLC148152	148-152mm	40
RLC159166	159-166mm	50
RLC168172	168-172mm	50
RLC200212	200-212mm	40
RLC215220	215-220mm	30
RLC248252	248-252mm	40
RLC313318	313-318mm	30



- Universal M8/M10

## BACKPLATE - FEMALE

Code	Size	Finish	Bag	Box
RLCBP	M8/M10	Zinc	50	500

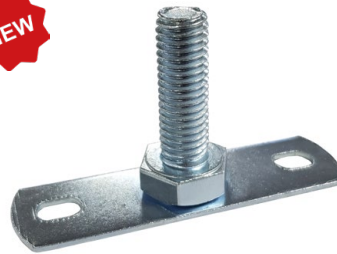

## BACKPLATE - MALE

Code	Size	Finish	Bag	Box
RLCBPM	M10	Zinc	100	400



## STUDDING (ALL THREAD)

Code	Size	Finish
MISDM8	M8	Zinc
MISDM10	M10	Zinc



## SPARES

Code	Size	Item
RLCN10	M10	Nut
RLCW10	M10	Washer



Prevents the tube from crushing caused by over tightening of compression type fittings or clamps.

## TUBE SUPPORTS

Code	Size
877-0006	6mm I.D
877-0008	8mm I.D
877-0009	9mm I.D
877-0010	10mm I.D
877-0012	12mm I.D
877-0013	13mm I.D



# 04

## OIL LINE EQUIPMENT

42.	Remote Action Fire Valves
43.	Oil Filters
43.	Oil Line Fittings
43.	Oil Gauges



- BSRIA approved to OFS E101:1998 and BS5410-1
- Recommended to be fitted to all oil fired appliances by The Fire Protection Association and OFTEC
- Fully resettable
- Can be fitted horizontally or vertically
- Fully compatible with the new Bio Fuels, B30 & B50 as well as kerosene

### 1/4" SAFFIRE FIRE VALVES 65 °C

Code	Capillary Length	Cut-out
KFV6515	1.5m	65 °C
KFV6530	3m	65 °C
KFV6560	6m	65 °C
KFV6590	9m	65 °C
KFV65120	12m	65 °C

### 1/4" SAFFIRE FIRE VALVES 90 °C

Code	Capillary Length	Cut-out
KFV9020	2m	90 °C
KFV9030	3m	90 °C
KFV9060	6m	90 °C
KFV9090	9m	90 °C

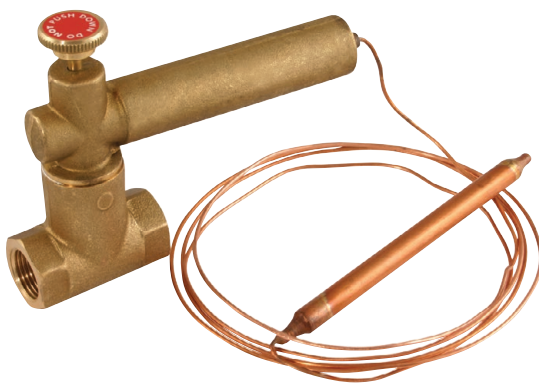

- BSRIA approved to OFS E101:1998 and BS5410-1.
- Fully resettable remote acting capillary firevalves.
- Optional 10mm compression fittings
- Can be fitted horizontally or vertically.
- Suitable for Class C2 & Class D to BS 2869

### 3/8" CLASSIC FIRE VALVES 65 °C

Code	Capillary Length	Cut-out
TFV66015	1.5m	66 °C
TFV66030	3m	66 °C
TFV66060	6m	66 °C
TFV66090	9m	66 °C
TFV66150	15m	66 °C

### 3/8" CLASSIC FIRE VALVES 90 °C

Code	Capillary Length	Cut-out
TFV90015	1.5m	90 °C
TFV90030	3m	90 °C
TFV90060	6m	90 °C
TFV90090	9m	90 °C
TFV90150	15m	90 °C





- Wheelhead
- Solder melt point 97°C

### FUSIBLE HEAD FIRE VALVE

Code	Size
FV38E	3/8", 10mm



- Viton seal

### OIL CHECK VALVE

Code	Size
VAL38V	3/8" BSPP
VAL14V	1/4" BSPP



- MxF Inlet/Outlet
- Pressed steel hand wheel

### ANGLED LOCKING VALVE

Code	Size
SP030	1"



- Aluminium bowl
- Plastic mesh
- 40 micron filter

### ALUMINIUM OIL FILTER BOWL

Code	Size
OFM38	3/8" Fx F

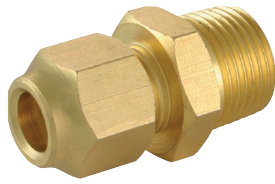

### FLARED MI ADAPTOR

Code	Size
U1-6B	10mm x 1/4" MI
U1-6C	10mm x 3/8" MI

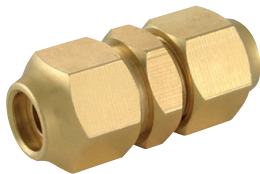

### FLARED COUPLER

Code	Size
U2-6	10mm

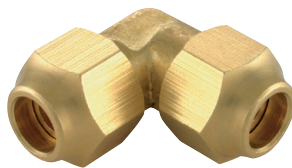

### FLARED ELBOW

Code	Size
E2-6	10mm

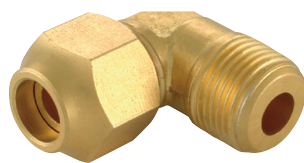

### FLARED MI ELBOW

Code	Size
E1-6B	10mm x 1/4" MI
E1-6C	10mm x 3/8" MI



### FLARED NUT

Code	Size
NFS-10M	10mm



### SIGHT GAUGE - LEVER OPERATED

Code	Size
OL005	4ft
OL010	6ft



### SIGHT GAUGE - PUSH BUTTON

Code	Size
OL025	4ft
OL027	5ft
OL030	6ft



### MONARCH TANK GAUGE

Code	Description
OL045	4ft with filter
OL050	6ft with filter



### SPARE FILTER

Code	Material
FV515	Plastic



### ADJUSTABLE FLOAT GAUGE

Code	Length
OL108	4ft

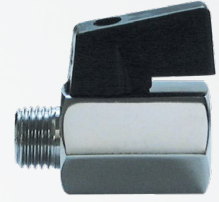

### MxF MINI BALL VALVE

Code	Size
MBVM18S	1/8"
MBVM14S	1/4"
MBVM38S	3/8"
MBVM12S	1/2"
MBVM34S	3/4"



### FxF MINI BALL VALVE

Code	Size
MBV18	1/8"
MBV14S	1/4"
MBV38	3/8"
MBV12	1/2"
MBV34	3/4"

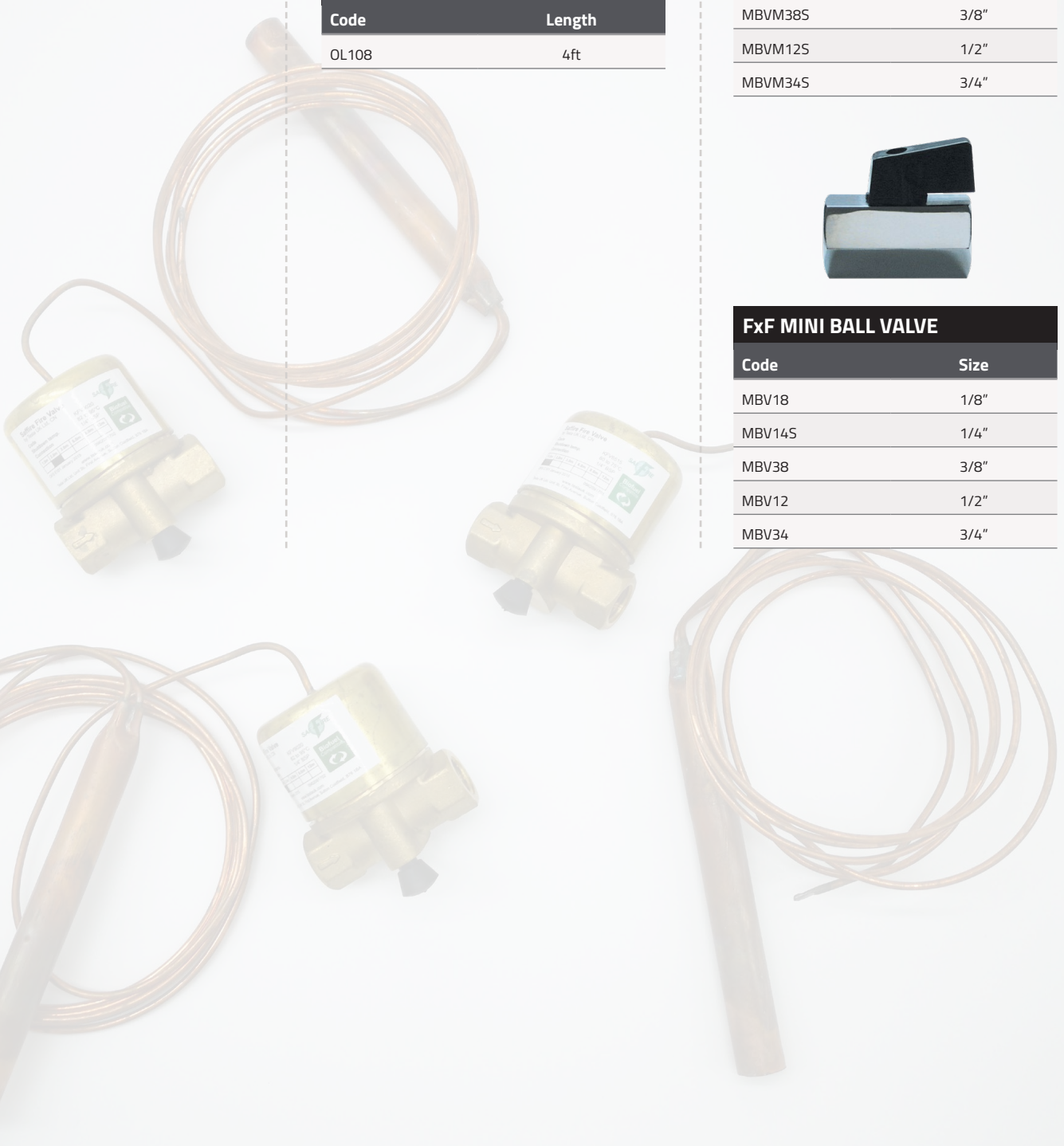

# 05

## GENERAL VALVES & ACCESSORIES

46-47.	Lever Ball Valves
48-49.	Check Valves & Strainers
49.	Enolgas Valves
50.	Drain Cocks
52.	Pump Valves & Accessories
53.	Flexible Hose Adaptors
54.	Stopcocks & Bibtaps
55.	Isolating & Gate Valves
57.	Washing Machine Valves & Accessories
58.	Float Valves



CE



- Full bore
- CE marked
- EN331 approved
- Compression ends to BS EN1254-2

### COMPRESSION LEVER BALL VALVE

Code	Size	Colour
GB/BVL15R	15mm	Red
GB/BVL15B	15mm	Blue
GB/BVL22R	22mm	Red
GB/BVL22B	22mm	Blue
GB/BVL28R	28mm	Red
GB/BVL28B	28mm	Blue
GB/BVL35R	35mm	Red
GB/BVL35B	35mm	Blue
GB/BVL42R	42mm	Red
GB/BVL42B	42mm	Blue
GB/BVL54R	54mm	Red
GB/BVL54B	54mm	Blue



- Comes with removable red/blue bands
- Compression ends to BS EN1254-2

### UNIVERSAL LEVER BALL VALVE

Code	Size	Colour
BVL15B	15mm (full bore)	Universal
BVL22B	22mm	Universal



CE



- Full bore
- CE marked
- EN331 approved
- Threads to ISO 228 (formerly BS 21)

### FxF LEVER BALL VALVE

Code	Size	Colour
GB/BVL14R	1/4"	Red
GB/BVL14B	1/4"	Blue
GB/BVL38R	3/8"	Red
GB/BVL38B	3/8"	Blue
GB/BVL12R	1/2"	Red
GB/BVL12B	1/2"	Blue
GB/BVL34R	3/4"	Red
GB/BVL34B	3/4"	Blue
GB/BVL1R	1"	Red
GB/BVL1B	1"	Blue
GB/BVL114R	1-1/4"	Red
GB/BVL114B	1-1/4"	Blue
GB/BVL112R	1-1/2"	Red
GB/BVL112B	1-1/2"	Blue
GB/BVL2R	2"	Red
GB/BVL2B	2"	Blue
PROBV212R	2-1/2"	Red
PROBV212B	2-1/2"	Blue
PROBV3R	3"	Red
PROBV4R	4"	Red



CE



- Full bore
- CE marked
- EN331 approved
- Compression ends to BS EN 1254-2

### BUTTERFLY BALL VALVE

Code	Size	Colour
GB/BVT15R	15mm	Red
GB/BVT15B	15mm	Blue
GB/BVT22R	22mm	Red
GB/BVT22B	22mm	Blue
GB/BVT28R	28mm	Red
PROBBV28B	28mm	Blue

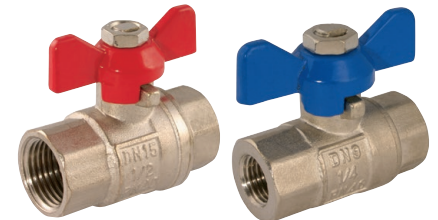

CE



- Full bore
- CE marked
- EN331 approved
- Threads to ISO 228 (formerly BS 21)

### FxF BUTTERFLY LEVER BALL VALVE

Code	Size	Colour
GB/BVT14R	1/4"	Red
GB/BVT14B	1/4"	Blue
GB/BVT38R	3/8"	Red
GB/BVT38B	3/8"	Blue
GB/BVT12B	1/2"	Blue
GB/BVT34R	3/4"	Red
PROBBV34B	3/4"	Blue
PROBBV1B	1"	Blue
GB/BVT1R	1"	Red

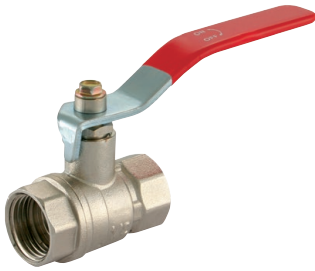

## ECONOMY LEVER BALL VALVES

Code	Size	Colour
BVL14R	1/4"	Red
BVL12R	1/2"	Red
BVL34R	3/4"	Red
BVL1R	1"	Red
BVL114R	1-1/4"	Red
BVL112R	1-1/2"	Red
BVL2R	2"	Red

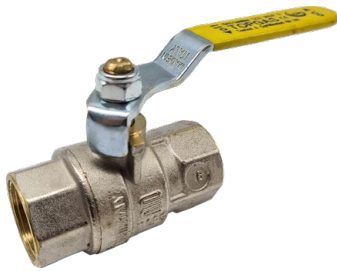

- Full bore.
- Suitable for 1st, 2nd & 3rd family gases.
- Approved to EN331.

## TOPGAS LEVER BALL VALVES

Code	Size
PROBVT12	1/2"
PROBVT34	3/4"
PROBVT1	1"
PROBVT114	1-1/4"
PROBVT112	1-1/2"
PROBVT2	2"



The NEW concealed ball valves are designed for wall built-in installation and suitable for hot and cold water, air, hydrocarbons and non-aggressive fluids.

## CONCEALED BALL VALVE

Code	
TBA	COMING SOON



Temperature range:  
-10°C to +110°C

- Full bore
- Suitable for natural gas, LPG and oil
- Approved to BS EN331



## COMPRESSION LEVER BALL VALVE

Code	Size	Colour
GB/BVL15	15mm	Yellow
GB/BVL22	22mm	Yellow
GB/BVL28	28mm	Yellow
GB/BVL35	35mm	Yellow
GB/BVL42	42mm	Yellow
GB/BVL54	54mm	Yellow

Temperature range:  
-20°C to +140°C

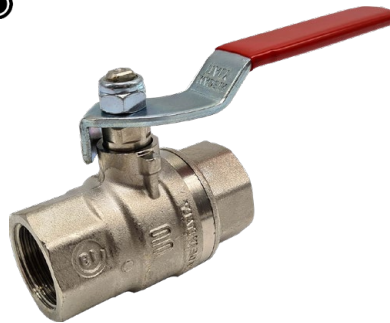

- Suitable for hot and cold water, compressed air, oils and hydrocarbons in general.
- Full bore.



## LOGIC LEVER BALL VALVES

Code	Size
LOGBV14	1/4"
LOGBV38	3/8"
LOGBV12	1/2"
LOGBV34	3/4"

Temperature range:  
-20°C to +130°C



- Full bore
- Suitable for natural gas, LPG and oil
- Approved to BS EN331



## FEMALE LEVER BALL VALVES

Code	Size	Colour
GB/BVL14	1/4"	Yellow
GB/BVL38	3/8"	Yellow
GB/BVL12	1/2"	Yellow
GB/BVL34	3/4"	Yellow
GB/BVL1	1"	Yellow
GB/BVL114	1-1/4"	Yellow
GB/BVL112	1-1/2"	Yellow
GB/BVL2	2"	Yellow
PROBV212	2-1/2"	Yellow
PROBV3	3"	Yellow
PROBV4	4"	Yellow

Temperature range:  
-20°C to +130°C



- Full bore
- Suitable for natural gas, LPG and oil
- Approved to BS EN331



## BUTTERFLY LEVER BALL VALVES

Code	Size	Colour
GB/BVT14	1/4"	Yellow
GB/BVT38	3/8"	Yellow
GB/BVT12	1/2"	Yellow
GB/BVT34	3/4"	Yellow
GB/BVT15	15mm	Yellow
PROBBV28	28mm	Yellow



## SINGLE CHECK VALVES

Code	Size
CV15	15mm
CV22	22mm
CV28	28mm

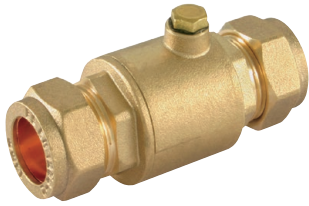

## SINGLE CHECK VALVES - HEAVY

Code	Size
CVH15	15mm
CVH22	22mm
CVH28	28mm

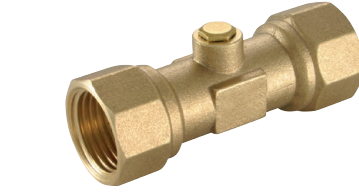

## FEMALE DOUBLE CHECK VALVES

Code	Size
CVF12	1/2"
CVF34	3/4"
CVF1	1"



## SWING CHECK VALVES

Code	Size
CV12	1/2"
CV34	3/4"
CV1	1"
CV114	1-1.4"
CV112	1-1/2"
CV2	2"

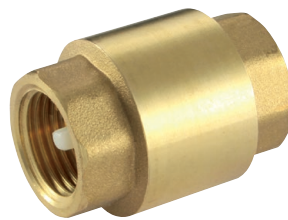

## NON-RETURN VALVES

Code	Size
CV12U	1/2"
CV34U	3/4"
CV1U	1"
CV114U	1-1.4"
CV112U	1-1/2"
CV2U	2"



## Y STRAINERS - COMPRESSION

Code	Size
BYS15	15mm
YS15	15mm DZR
BYS22	22mm
YS22	22mm DZR



## Y STRAINERS - FEMALE

Code	Size
BYS12	1/2"
BYS34	3/4"
BYS1	1"
BYS114	1-1.4"
BYS112	1-1/2"
BYS2	2"

## DOUBLE CHECK VALVES

Code	Size	Finish
CV155	15mm	Brass
CV155CP	15mm	Chrome
CV122	22mm	Brass
CV122CP	22mm	Chrome
CV128	28mm	Brass



## DOUBLE CHECK VALVE WITH ISO

Code	Size	Finish
DCBL15	15mm	Chrome



## BRONZE DOUBLE CHECK VALVES

Code	Size
CVD35	35mm
CVD42	42mm
CVD54	54mm



## SHOWER CHECK VALVE

Code	Size
CVS12	1/2"





- Suitable for any type of hydraulic, heating or pneumatic system.
- For hot and cold water, compressed air and oil.
- NBR gasket.

### EUROSTOP CHECK VALVES

Code	Size
ENRV12	1/2"
ENRV34	3/4"
ENRV1	1"
ENRV114	1-1/4"
ENRV112	1-1/2"
ENRV2	2"
ENRV212	2-1/2"
ENRV3	3"



- Suitable for any type of hydraulic, heating or pneumatic system.
- For hot and cold water, compressed air and oil.

with NBR Gasket

### VALSTOP CHECK VALVES

Code	Size
VAL14	1/4"
VAL38	3/8"
VAL12	1/2"
VAL34	3/4"
VAL1	1"

with Fluoroelastomer/Viton Gasket

### VALSTOP CHECK VALVES

Code	Size
VAL14V	1/4"
VAL38V	3/8"



### SLUDGE COCK

Code	Size
SLC15	15mm



**A SINGLE PRODUCT**  
with the function of two valves  
plus a filter

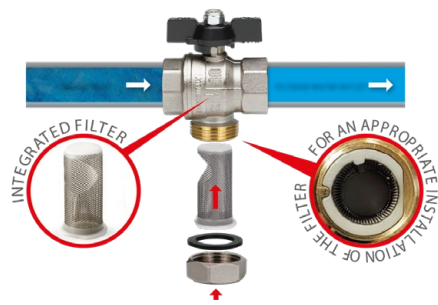

This is a solution that integrates the normal ON-OFF function of a ball valve with the function of protecting the system from impurities.

- Particularly useful where space is limited
- Easy to maintain

### BALL VALVE & STRAINER

Code	Size
EKOFIL12	1/2"
EKOFIL34	3/4"
FKOFIL1	1"



### TYPE 'A' BSP DRAIN COCKS

Code	Size	Finish
DC03	1/2"	Brass
DC03CP	1/2"	Chrome
DC06	1/2" (DZR)	Brass
DC034	3/4"	Brass



### TYPE 'A' METRIC DRAIN COCKS

Code	Size
DC15	15mm
DC15S	15mm (DZR)
DC22	22mm



### TYPE 'A' EXTENDED TAIL

Code	Size
DC15L	15mm



### TYPE 'A' METRIC with LOCKSHIELD

Code	Size
DL15	15mm



### TYPE 'A' BSP with LOCKSHIELD

Code	Size
DL12	1/2"
DL125	1/2" (DZR)



### TYPE 'B' METRIC DRAIN COCKS

Code	Size
DC02	15mm



### TYPE 'B' BSP DRAIN COCKS

Code	Size
DC01	1/2"



NEW

### DRAIN ELBOW

Code	Size
CMDE2234	22mm x 3/4"



### DRAIN COCK WASHER

Code	Description
1DOCW	Spare DOC Washer



### SELF-CUTTING DRAIN COCK

Code	Size
DC15SC	15mm

## THE NEXT GENERATION DRAIN-OFF COCK

EXCLUSIVE



# COMING LATE 2021

▪ Includes Washer



## PUMP VALVES - GATE TYPE

Code	Size
PV221	22mm x 1-1/2"
PV281	28mm x 1-1/2"

▪ Includes Washer



## PUMP VALVES - BALL TYPE

Code	Size
PV222	22mm x 1-1/2"
PV282	28mm x 1-1/2"

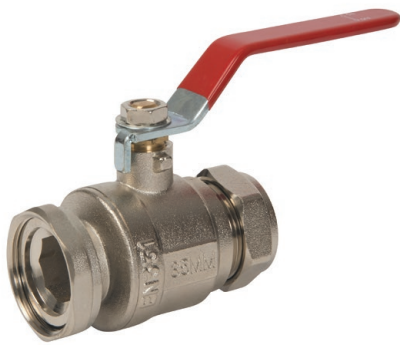

▪ Includes Rubber Washer  
▪ Supplied as a pair

## PUMP VALVES - LEVER

Code	Size
PV35L	35mm x 1-1/2"



▪ Includes Washer

## PUMP ADAPTORS

Code	Size
PA01	1-1/2" Standard
PA02	1-1/2" Extended



## PUMP UNIONS

Code	Size
PU01	1-1/2" x 1"



## PUMP NUT

Code	Size
PN01	1-1/2" x 1"



## PUMP BRACKETS

Code	Size
PPMB22	22mm
PPMB28	28mm

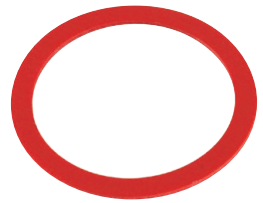

## PUMP GASKET

Code	Size
PG01	1"

## FLEXIBLE HOSE TAP ADAPTORS

- Prevents damage to flexible hose washers
- Prevents leaks
- Cheaper alternative to using separate MI fitting
- Quick installation time vs. MI fitting

When fitting a flexible hose swivel nut directly on to an isolating valve, the chamfered edge on the ISO valve can cut into the washer, causing damage and potentially causing a leak.

Our flexible hose tap adaptors can be fitted straight into a 15mm isolating valve, creating a flat face for the flexible hose swivel nuts, thus preventing damage and leaks. This is also a cost-effective alternative to fitting a separate length of pipe with a MI fitting.



Code	Size
FLTT38	3/8"
FLTT1512	1/2"



## FLEXIBLE COPPER TUBE

- Flexible
- Great for awkward jobs
- Supplied with protective caps
- 15mm x 15mm
- 300mm long
- Works with solder, compression and push-fit fittings
- Higher flow rate than standard flexible hoses
- Can be used on; gas, hot and cold water



Code	Size	Length
FLEXCOP	15mm	300mm





## COMPRESSION STOPCOCKS

Code	Size
SC15	15mm
SC1522	15mm x 22mm
SC22	22mm
SC28	28mm



## BRONZE STOPCOCKS

Code	Size
SC425	45mm
SC545	54mm



## POLY STOPCOCKS

Code	Size
PS1520	15mm x 20mm
PS1525	15mm x 25mm
PS20	20mm
PS2225	22mm x 25mm
PS25	25mm
PZSC25	25mm (DZR)
PZSC32	32mm (DZR)



## BIBTAPS

Code	Size
HU12	1/2"
HU34	3/4"



## BIBTAPS WITH CHECK VALVE DZR

Code	Size
HB12	1/2"
HB34	3/4"



## LOCKSHIELD BIBTAPS

Code	Size
HU12L	1/2"
HB12L	1/2" DZR with Check Valve



For conversion of old style garden and washing machine taps to 3/4" standard size

## TAP EXTENSION Mx F

Code	Size
BB341258	3/4" x 5/8" x 1/2"



## QUARTER TURN BIBTAPS

Code	Size
HU12Q	1/2"
HB12Q	1/2" with Check Valve

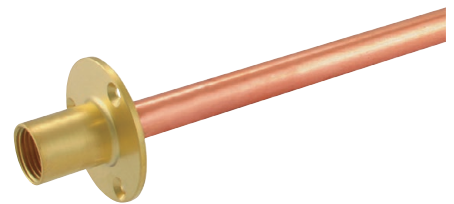

## WALLPLATE & COPPER TUBE

Code	Size
GTKASS	1/2" x 350mm
GTKASS18	1/2" x 450mm
GTKASS24	1/2" 600mm



## FEMALE STOPCOCKS

Code	Size
SC12	1/2"
SC1	1"
SC112	1-1/2"
SC2	2"

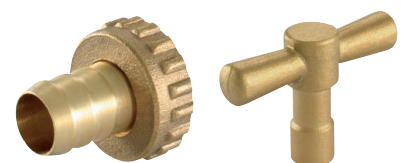

## SPARES

Code	Description
HT12	1/2" Hose Tail & Washer
HUKEY	KEY for HU12L & HB12L



### LOCKSHIELD STOPCOCK

Code	Size
SC225LS	22mm (DZR)



### WHEELHEAD GATEVALVES

Code	Size
GB15	15mm
GB22	22mm
GB28	28mm
GB35	35mm
GB42	42mm
GB54	54mm



### LOCKSHIELD GATEVALVES

Code	Material	Size
GSL15	Brass	15mm
GBL15	DZR Brass	15mm
GSL22	Brass	22mm
GBL22	DZR Brass	22mm
GSL28	Brass	28mm
GBL28	DZR Brass	28mm
GBL35	DZR Brass	35mm



### ISOLATING VALVES

Code	Colour	Size
BL155	Brass	15mm
BL15	Chrome	15mm
BL22	Chrome	22mm

- Heavy Pattern
- Full Bore



### ISOLATING VALVES - HEAVY

Code	Colour	Size
BLH15	Chrome	15mm
BLH22	Chrome	22mm



### ISOLATING VALVES WITH LEVER

Code	Colour	Size
BL151	Chrome	15mm
BL221	Chrome	22mm



**SEE PAGE FOR MORE AIR VENTS**



### STRAIGHT SERVICE VALVES

Code	Size
BS15	15mm x 1/2"
BS22	22mm x 3/4"



### BENT SERVICE VALVES

Code	Size
BS151	15mm x 1/2"



### BOTTLE AIR VENTS

Code	Description
BAV12	1/2"
BAVCV38	3/8" with Check Valve
BAVCV12	1/2" with Check Valve



### BOTTLE AIR VENTS - COMPRESSION

Code	Size
CBV15	15mm



## EasyFit Isolator

The quick-fit plumbing isolation valve for pressurised pipe

- Isolate pressurised Plastic Pipe, which cannot be frozen by pipe freezers! (PE-X, PB, Copper, Multi-layer)
- Isolate heating system pipework to maintain system, while hot, no requirement to drain down.
- Isolate mains water where stopcock seized, the EasyFit Isolator is WRAS approved and replaces your Stopcock.
- Emergency Isolation during flood, (you cannot use pipe freezing to isolate moving water)
- Isolate behind Thermostatic Mixing Valve. (e.g. when testing for Legionnaires), without shutting off system!
- Isolate to install Pressure Reducing Valves.
- Isolate in multi-occupancy buildings, without disrupting other residents!



EASYFIT ISOLATOR		
Code	Description	Size
EZF03	Starter Kit (Includes tools)	15mm
EZF01	Refill	15mm
EZF02	Toolkit	15mm
EZF06	Starter Kit (Includes tools)	22mm
EZF04	Refill	22mm
EZF05	Toolkit	22mm



## Autovents

Automatically bleed radiators and towel rails



AUTOVENTS		
Code	Description	Size
HV30C	Autovent - 2 Pack	1/2"
HV30CBP	Autovent & Blanking Plug	1/2"



- Automatically bleed radiators and towel rails
- Keep radiators hot to the top
- Improve heat output and saves energy
- Easy to fit, no need to drain the system
- No air = reduced corrosion = extended radiator life
- Reduces radiator noise
- Improves visual appearance

visit [www.teslauk.com](http://www.teslauk.com) for more information



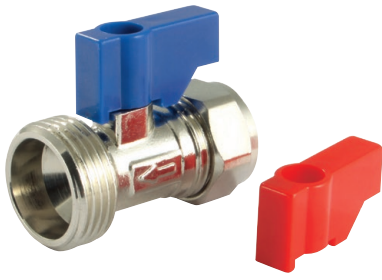

### STRAIGHT VALVES

Code	Size
WMC	15mm x 3/4"

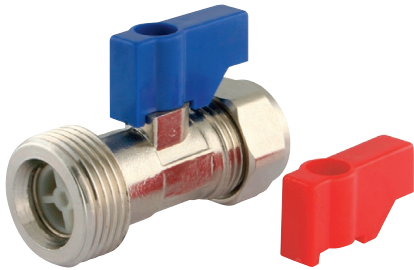

### STRAIGHT WITH CHECK VALVE

Code	Size
WMCV	15mm x 3/4"



### STRAIGHT WITH CHECK VALVE

Code	Size
WMA	15mm x 3/4"

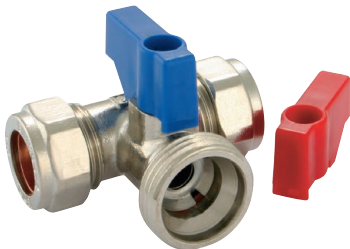

### STRAIGHT WITH CHECK VALVE

Code	Size
WM2C	15mm x 3/4"

Allows you to run two appliances off one incoming piece of pipe



### DUAL APPLIANCE TEE

Code	Size
CAT1534	15mm x 3/4" x 3/4"



### STRAIGHT WITH BACKPLATE

Code	Size
WMBK	15mm x 3/4"



### SELF CUTTING

Code	Size
WMSC	15mm x 3/4"
WMSC22	22mm x 3/4"



### CUT-IN KIT

Code	Description
WMKIT	Waste Plumbing Kit



### INLET HOSE CONNECTOR

Code	Size
WMIC	3/4"



### OUTLET HOSE CONNECTOR

Code	Size
WMOC	17mm



## BRASS HIGH PRESSURE PART 1

Code	Description	Size
BV01	Nylon Piston with Cone & Plastic Nuts	1/2"
BV04	Nylon Piston with Cone & Plastic Nuts	3/4"
BV016	3" Extension Tail & 6" Arm	1/2"
BV05	Brass Piston with Cone & Plastic Nuts	1/2"
VT504	Brass Piston with Cone & Nuts	1/2"



## BRONZE HIGH PRESSURE PART 1

Code	Size
BV1	1"
BV114	1-1/4"
BV112	1-1/2"
BV2	2"



## BRASS LOWER PRESSURE PART 1

Code	Size
BV11	3/4"

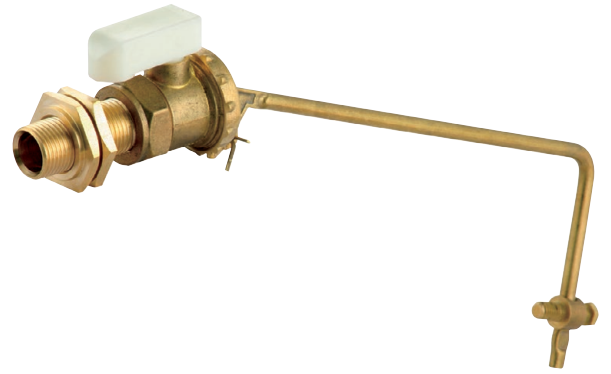

## BRASS HIGH PRESSURE PART 2

Code	Description	Size
BV09	Brass Backplate with Plastic Nuts	1/2"
BV096	with 6" Arm	1/2"
VT531	Brass Backplate with Seal & Nut	1/2"
BV0934	Brass Backplate with Plastic Nuts	3/4"



## BRASS HIGH PRESSURE PART 2 BOTTOM ENTRY

Code	Size
BV901	1/2"



## PLASTIC FLOATS

Code	Size
FLOAT412	4-1/2" (with brass insert)



- Adjustable up to 75mm
- Suits square or hexagonal shafts up to 10mm

## CISTERN LEVER ARM

**Code**

TL105



## TOILET SEAT HINGES

**Code**

**Finish**

4UNHBR

Polished Brass

4UNHCP

Chrome Plated

## PRESSURE OPERATED URINAL FLUSH VALVE

The Governor Valve is a water saving device installed on the supply pipe to a urinal cistern. The valve regulates flushing by opening only when short-term pressure drops occur (e.g. through use of taps or WCs on the same supply).

When activated, the valve (normally closed) opens for a fixed length of time to allow water to flow into the urinal cistern until the pressures on both sides of the valve have equalised. When the cistern is full, the auto-siphon will flush.

This compact unit has been designed for quicker & easier installation in ceiling and wall cavities and can be installed in vertical or horizontal orientations. The flow rate is adjustable using the supplied Allen Key to suit system requirements and no power supply is needed.

- Maximum Inlet Pressure: 10 Bar
- Operating Pressure: 1.0 - 6 Bar
- Adjustable Flow Rate: 0.5 - 6 lpm
- Operating Sensitivity: 15%
- Maximum Temperature: 30°C
- Connection Size: 1/2" FBSP
- Suitable Media: Water



**Code**

**Size**

POUFV

1/2"



- Can be used on soldered, compression and crimped fittings
- Reduced cost when fitting into a standard tee
- Save time by only making one joint

Application:  
The Gas Finger is fitted when a pressure test point is required in a copper gas line, often in a commercial or domestic environment.

GAS FINGER TEST POINT		
Code	Size	Finish
GASFIN	15mm	Brass



- Can be used on soldered, compression and crimped fittings
- Reduced cost when fitting into a standard tee
- Save time by only making one joint

Application:  
The Air Finger is used when a manual air vent is required on heating or hot and cold water lines.

AIR FINGER RELEASE POINT		
Code	Size	Finish
AIRFIN	15mm	Brass



- Can be used on soldered, compression and crimped fittings
- Reduced cost when fitting into a standard tee
- Save time by only making one joint
- Can be used with gas, air or water

Application:  
The fitting allows a direct one move adaptor from copper tube to BSP which allows one joint from copper pipe to either a pressure safety valve, auto air vent or pressure gauge (etc.)

REDUCING FINGER		
Code	Size	Finish
REDFIN	15mm	Brass



# 06

## GENERAL PLUMBING FITTINGS

62-63.	Brass Fittings
64-66.	End Feed Fittings
67-68.	Solder Ring Fittings
69-71	Compression Fittings
72.	Chrome Compression Fittings
73.	Heavy Duty Compression Fittings



## HEXAGON NIPPLES

Code	Size
BN18	1/8"
BN14	1/4"
BN38	3/8"
BN12	1/2"
BN34	3/4"
BN1	1"
BN114	1-1/4"
BN112	1-1/2"
BN2	2"



## RUNNING NIPPLES

Code	Size
BNR18	1/8"
BNR14	1/4"
BNR38	3/8"
BNR12	1/2"
BNR12L4	1/2" (4" Long)
BNR34	3/4"
BNR3434L4	3/4" (4" Long)
BNR1	1"



## BARREL NIPPLES

Code	Size
BNB18	1/8"
BNB14	1/8"
BNB38	3/8"
BNB12	1/2"
BNB1	1"
BNB114	1-1/4"



## SOCKETS

Code	Size
BS18	1/8"
BS14	1/4"
BS38	3/8"
BS12	1/2"
BS34	3/4"
BS1	1"
BS114	1-1/4"



## CAPS

Code	Size
BC18	1/8"
BC14	1/4"
BC38	3/8"
BC12	1/2"
CPBC12	1/2" Chrome
BC34	3/4"
BC1	1"
BC114	1-1/4"
BC112	1-1/2"
BC2	2"



## FLANGED BACKNUTS

Code	Size
BK38	3/8"
BK12	1/2"
BK34	3/4"
BK1	1"
BK114	1-1/4"
BK112	1-1/2"
BK2	2"
BK214	2-1/4"



## FLANGED PLUGS

Code	Size
BP18	1/8"
BP14	1/4"
BP38	3/8"
BP12	1/2"
BP34	3/4"
BP1	1"
BP114	1-1/4"
BP112	1-1/2"
BP2	2"



## HEXAGON REDUCING BUSHES

Code	Size (MxF)
BB1418	1/4" x 1/8"
BB3818	3/8" x 1/8"
BB3814	3/8" x 1/4"
BB1218	1/2" x 1/8"
BB1214	1/2" x 1/4"
BB1238	1/2" x 3/8"
BB3414	3/4" x 1/4"
BB3458	3/4" x 5/8"
BB3412	3/4" x 1/2"
CPBB412	3/4" x 1/2" Chrome
BB112	1" x 1/2"
BB134	1" x 3/4"
BB11412	1-1/4" x 1/2"
BB11434	1-1/4" x 3/4"
BB1141	1-1/4" x 1"
BB11214	1-1/2" x 1/4"
BB11212	1-1/2" x 1/2"
BB11234	1-1/2" x 3/4"
BB1121	1-1/2" x 1"
BB234	2" x 3/4"
BB21	2" x 1"
BB2114	2" x 1-1/4"
BB2112	2" x 1-1/2"



## ELBOWS FxF

Code	Size
BE18FF	1/8"
BE14FF	1/4"
BE38FF	3/8"
BE12FF	1/2"
BE34FF	3/4"
BE1FF	1"



## ELBOWS MxF

Code	Size
BE38MF	3/8"
BE12MF	1/2"
BE34MF	3/4"
BE1MF	1"



## EQUAL TEES

Code	Size
BT18	1/8"
BT14	1/4"
BT38	3/8"
BT12	1/2"
BT34	3/4"
BT1	1"



## HOSE TAILS

Code	Size
SF150	1/8" x 1/8"
SF165	1/4" x 1/4"
SF170	1/4" x 5/16"
SF175	1/4" x 3/8"
SF180	1/4" x 1/2"
SF185	3/8" x 1/4"
SF190	3/8" x 3/8"
SF200	3/8" x 1/2"
SF205	1/2" x 1/4"
SF210	1/2" x 3/8"
SF211	1/2" x 5/16"
SF215	1/2" x 1/2"
SF220	1/2" x 5/8"
SF225	1/2" x 3/4"
SF230	3/4" x 1/2"
SF235	3/4" x 3/4"
SF240	3/4" x 1"
SF245	1" x 3/4"
SF250	1" x 1"
SF265	1-1/4" x 1-1/4"
SF266	1-1/4" x 1"
SF270	1-1/2" x 1-1/2"
SF275	2" x 2"



## MANIFOLDS

Code	Description
BMF2282	22mm x 8mm (2 Port)
BMF22102	22mm x 10mm (2 Port)
BMF2283	22mm x 8mm (3 Port)
BMF22103	22mm x 10mm (3 Port)
BMF2284	22mm x 8mm (4 Port)



## EXTENSION PIECES

Code	Size
CPEX25	1/2" x 1/2" x 25mm
CPEX50	1/2" x 1/2" x 50mm
CPEX75	1/2" x 1/2" x 75mm
CPEX100	1/2" x 1/2" x 100mm



## TAP EXTENSIONS MxF

Code	Size
BE12	1/2"
BE34	3/4"



For conversion of old style garden and washing machine taps to 3/4" standard size

## TAP EXTENSIONS MxFxF

Code	Size
BB341258	3/4" x 5/8" x 1/2"



## IMMERSION HEATER PLUG

Code	Description
IH134	1-3/4" Plug & 'O' Ring
IH214	2-1/4" Plug & Washer



COUPLINGS	
Code	Size
EFC08	8mm
EFC10	10mm
EFC15	15mm
EFC22	22mm
EFC28	28mm
EFC35	35mm
EFC42	42mm
EFC54	54mm
EFC67	67mm
EFC108	108mm



IMPERIAL x METRIC	
Code	Size
EFA2234	22mm x 3/4"
EFA281	28mm x 1"
EFA35114	35mm x 1-1/4"



END CAPS	
Code	Size
EFEC08	8mm
EFEC15	15mm
EFEC22	22mm
EFEC28	28mm
EFEC35	35mm

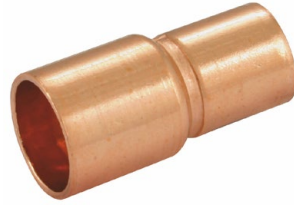

FITTING REDUCER	
Code	Size
EFR1008	10 x 8mm
EFR1210	12 x 10mm
EFR1508	15 x 8mm
EFR1510	15 x 10mm
EFR2215	22 x 15mm
EFR2815	28 x 15mm
EFR2822	28 x 22mm
EFR3515	35 x 15mm
EFR3522	35 x 22mm
EFR3528	35 x 28mm
EFR4215	42 x 15mm
EFR4228	42 x 28mm
EFR4235	42 x 35mm
EFR5415	54 x 15mm
EFR5422	54 x 22mm
EFR5428	54 x 28mm
EFR5435	54 x 35mm
EFR5442	54 x 42mm
EFR6735	67 x 35mm
EFR7667	76 x 67mm



MALE ADAPTORS	
Code	Size
EFMI1514	15mm x 1/4"
EFMI1512	15mm x 1/2"
EFMI281	28mm x 1"



REDUCER	
Code	Size
EF1508	15 x 8mm
EF1510	15 x 10mm
EF2215	22 x 15mm
EF2815	28 x 15mm
EF2822	28 x 22mm
EF3522	35 x 22mm
EF3515	35 x 15mm
EF3528	35 x 28mm
EF4215	42 x 15mm
EF4222	42 x 22mm
EF4228	42 x 28mm
EF4235	42 x 35mm
EF5428	54 x 28mm
EF5435	54 x 35mm
EF5442	54 x 42mm



SLIP COUPLERS	
Code	Size
EFCS15	15mm
EFCS22	22mm
EFCS28	28mm
EFCS35	35mm
EFCS42	42mm
EFCS54	54mm



FEMALE ADAPTOR	
Code	Size
EFFI1512	15mm x 1/2"



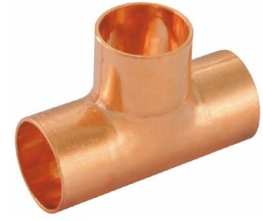

## ELBOWS

Code	Size
EFE08	8mm
EFE10	10mm
EFE12	12mm
EFE15	15mm
EFE22	22mm
EFE28	28mm
EFE35	35mm
EFE42	42mm
EFE54	54mm
EFE76	76mm

## ELBOWS - 45°

Code	Size
EFOE15	15mm
EFOE22	22mm
EFOE28	28mm
EFOE35	35mm
EFOE42	42mm
EFOE54	54mm

## EQUAL TEES

Code	Size
EFT08	8mm
EFT10	10mm
EFT15	15mm
EFT18	18mm
EFT22	22mm
EFT28	28mm
EFT35	35mm
EFT42	42mm
EFT54	54mm
EFT108	108mm

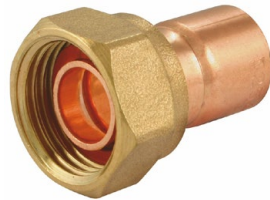

## TAP CONNECTORS - STRAIGHT

Code	Size
EFT1512	15mm x 1/2"
EFT1534	15mm x 3/4"
EFT2234	22mm x 3/4"

## STREET ELBOWS - 90°

Code	Size
EFSE10	10mm
EFSE15	15mm
EFSE18	18mm
EFSE22	22mm
EFSE28	28mm
EFSE35	35mm
EFSE42	42mm
EFSE54	54mm

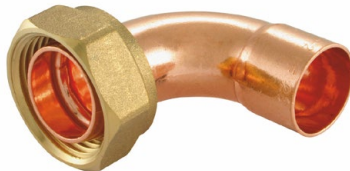

## TAP CONNECTORS - STRAIGHT

Code	Size
EFBT1512	15mm x 1/2"
EFBT1534	15mm x 3/4"
EFBT2234	22mm x 3/4"

## STREET ELBOWS - 45°

Code	Size
EFOSE15	15mm
EFOSE22	22mm
EFOSE35	35mm
EFOSE54	54mm

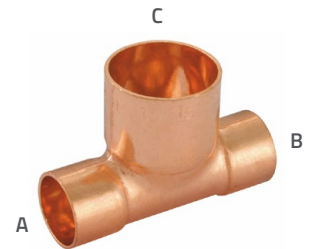

## REDUCING TEES

Code	A	B	C
EFT1110	15mm	15mm	10mm
EFT211	22mm	15mm	15mm
EFT212	22mm	15mm	22mm
EFT221	22mm	22mm	15mm
EFT2228	22mm	22mm	28mm
EFT28122	28mm	15mm	22mm
EFT28155	28mm	15mm	15mm
EFT28222	28mm	22mm	22mm
EFT2822	28mm	28mm	22mm
EFT352222	35mm	22mm	22mm
EFT3528	35mm	35mm	28mm
EFT35335	35mm	28mm	35mm
EFT4215	42mm	42mm	15mm
EFT4222	42mm	42mm	22mm
EFT42342	42mm	28mm	42mm
EFT4235	42mm	42mm	35mm
EFT42435	42mm	35mm	35mm
EFT5415	54mm	54mm	15mm
EFT5428	54mm	54mm	28mm
EFT5442	54mm	54mm	42mm
EFT54554	54mm	42mm	54mm



### LONG RADIUS BENDS - 90°

Code	Size
EFBE15	15mm
EFBE22	22mm
EFBE28	28mm



### VFLOW PRV BLOW-OFF CAP

Code	Size
VFLOW15	15mm
VFLOW22	22mm



### FULL CROSSOVERS

Code	Size
EFCR15	15mm
EFCR22	22mm



### PART CROSSOVERS

Code	Size
EFPC15	15mm
EFPC22	22mm



### WALLPLATE ELBOW

Code	Size
EFBP15	15mm x 1/2"



### MALE ADAPTOR ELBOW

Code	Size
EFME2234	22mm x 3/4"



### FEMALE ADAPTOR ELBOW

Code	Size
EFME2234	22mm x 3/4"

## FLEXIBLE COPPER TUBE

- Flexible
- Great for awkward jobs
- Supplied with protective caps
- 15mm x 15mm
- 300mm long
- Works with solder, compression and push-fit fittings
- Higher flow rate than standard flexible hoses
- Can be used on; gas, hot and cold water



Code	Size	Length
FLEXCOP	15mm	300mm

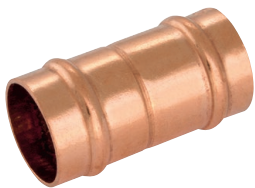

## COUPLINGS

Code	Size
SRC08	8mm
SRC10	10mm
SRC12	12mm
SRC15	15mm
SRC22	22mm
SRC28	28mm

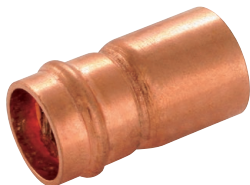

## FITTING REDUCERS

Code	Size
SRR1008	10 x 8mm
SRR1510	15 x 10mm
SRR2215	22 x 15mm
SRR2822	28 x 22mm
SRR3515	35 x 15mm
SRR4222	42 x 22mm
SRR5422	54 x 22mm
SRR5435	54 x 35mm

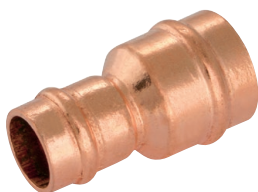

## REDUCERS

Code	Size
SR1008	10 x 8mm
SR1508	15 x 8mm
SR1510	15 x 10mm
SR1512	15 x 12mm
SR2215	22 x 15mm
SR2815	28 x 15mm
SR2822	28 x 22mm
SR3515	35 x 15mm
SR3522	35 x 22mm
SR3528	35 x 28mm
SR4228	42 x 28mm



## ELBOWS

Code	Size
SRE08	8mm
SRE10	10mm
SRE12	12mm
SRE15	15mm
SRE22	22mm
SRE28	28mm
SRE35	35mm
SRE42	42mm
SRE54	54mm



## ELBOWS - 45°

Code	Size
SROE15	15mm
SROE22	22mm
SROE28	28mm
SROE35	35mm
SROE42	42mm
SROE54	54mm

## STREET ELBOW - 90°

Code	Size
SRSE15	15mm
SRSE22	22mm

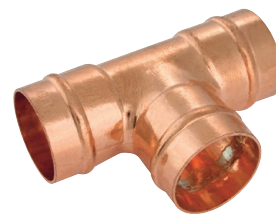

## EQUAL TEES

Code	Size
SRT08	8mm
SRT15	15mm
SRT22	22mm
SRT28	28mm

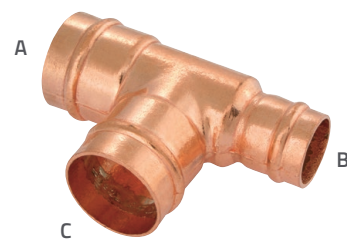

## REDUCING TEES

Code	A	B	C
SRT1510	15mm	15mm	10mm
SRT211	22mm	15mm	15mm
SRT212	22mm	15mm	22mm
SRT221	22mm	22mm	15mm
SRT22228	22mm	22mm	28mm
SRT28128	28mm	15mm	28mm
SRT3515	35mm	35mm	15mm
SRT3528	35mm	35mm	28mm
SRT4222	42mm	42mm	22mm
SRT4228	42mm	42mm	28mm
SRT422	54mm	54mm	22mm
SRT5435	54mm	54mm	35mm



## END CAPS

Code	Size
SREC08	8mm
SREC10	10mm
SREC15	15mm
SREC22	22mm

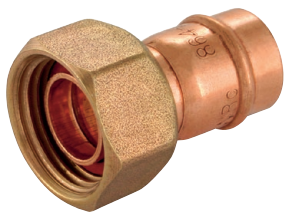

## TAP CONNECTOR - STRAIGHT

Code	Size
SRT1512	15mm x 1/2"



## PIPE COWL

Code	Size
SRPC15	15mm



## CYLINDER UNION - BENT

Code	Size
SRBCU221	22mm x 1"

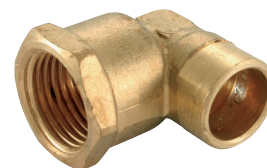

## FEMALE ADAPTOR ELBOW

Code	Size
SRFE1512	15mm x 1/2"

The one stop fix to a leaking pipe

- No pipe cutting
- Useful in awkward places
- Seals holes in 15mm pipe

## CLICK FIX

Code	Size
CLFIX15	15mm
CLFIX22	22mm



## FEMALE ADAPTOR

Code	Size
SRFI1512	15mm x 1/2"



## MALE ADAPTOR

Code	Size
SRMI1512	15mm x 1/2"



## COUPLINGS

Code	Size
CC06	6mm
CC08	8mm
CC10	10mm
CC12	12mm
CC15	15mm
CC22	22mm
CC28	28mm
CC35	35mm
CC42	42mm
CC54	54mm



## REDUCING COUPLINGS

Code	Size
CC1008	10 x 8mm
CC1210	12 x 10mm
CC1508	15 x 8mm
CC1510	15 x 10mm
CC1512	15 x 12mm
CC2215	22 x 15mm
CC2815	28 x 15mm
CC2822RC	28 x 22mm
CC3528	35 x 28mm



## MALE ADAPTORS

Code	Size
CCMI0614	6mm x 1/4"
CCMI0812	8mm x 1/2"
CCMI0814	8mm x 1/4"
CCMI0838	8mm x 3/8"
CCMI1012	10mm x 1/2"
CCMI1014	10mm x 1/4"
CCMI1038	10mm x 3/8"
CCMI1214	12mm x 1/4"
CCMI1238	12mm x 3/8"
CCMI1512	15mm x 1/2"
CCMI1514	15mm x 1/4"
CCMI1534	15mm x 3/4"
CCMI1538	15mm x 3/8"
CCMI221	22mm x 1"
CCMI2212	22mm 1/2"
CCMI2234	22mm x 3/4"
CCMI281	28mm x 1"
CCMI2834	28mm x 3/4"
CCMI35114	35mm x 1-1/4"
CCMI42112	42mm x 1-1/2"
CCMI542	54mm x 2"



## STOPENDS

Code	Size
CEC08	8mm
CEC10	10mm
CEC12	12mm
CEC15	15mm
CEC22	22mm
CEC28	28mm
CEC35	35mm
CEC42	42mm
CEC54	54mm



## FEMALE ADAPTORS

Code	Size
CCFI0614	6mm x 1/4"
CCFI0812	8mm x 1/2"
CCFI0814	8mm x 1/4"
CCFI0838	8mm x 3/8"
CCFI1012	10mm x 1/2"
CCFI1014	10mm x 1/4"
CCFI1038	10mm x 3/8"
CCFI1512	15mm x 1/2"
CCFI1514	15mm x 1/4"
CCFI1534	15mm x 3/4"
CCFI1538	15mm x 3/8"
CCFI221	22mm x 1"
CCFI2212	22mm 1/2"
CCFI2234	22mm x 3/4"
CCFI281	28mm x 1"
CCFI2834	28mm x 3/4"
CCFI35114	35mm x 1-1/4"
CCFI42112	42mm x 1-1/2"
CCFI542	54mm x 2"



## BLANKING DISCS

Code	Size
BD08	8mm
BD10	10mm
BD15	15mm
BD22	22mm
BD28	28mm



## ELBOWS

Code	Size
CE06	6mm
CE08	8mm
CE10	10mm
CE12	12mm
CE15	15mm
CE22	22mm
CE28	28mm
CE35	35mm
CE42	42mm
CE54	54mm
CE2215	22 x 15mm

## FEMALE ELBOWS

Code	Size
CEFI0814	8mm x 1/4"
CEFI1012	10mm x 1/2"
CEFI1014	10mm x 1/4"
CEFI1038	10mm x 3/8"
CEFI1512	15mm x 1/2"
CEFI1514	15mm x 1/4"
CEFI1534	15mm x 3/4"
CEFI221	22mm x 1"
CEFI2212	22mm x 1/2"
CEFI2234	22mm x 3/4"
CEFI281	28mm x 1"
CEFI35114	35mm x 1-1/4"

## EQUAL TEES

Code	Size
CT06	6mm
CT08	8mm
CT10	10mm
CT12	12mm
CT15	15mm
CT22	22mm
CT28	28mm
CT35	35mm
CT42	42mm
CT54	54mm



## MALE ELBOWS

Code	Size
CEMI0814	8mm x 1/4"
CEMI0838	8mm x 3/8"
CEMI1012	10mm x 1/2"
CEMI1014	10mm x 1/4"
CEMI1038	10mm x 3/8"
CEMI1512	15mm x 1/2"
CEMI1514	15mm x 1/4"
CEMI1534	15mm x 3/4"
CEMI221	22mm x 1"
CEMI2212	22mm x 1/2"
CEMI2234	22mm x 3/4"
CEMI281	28mm x 1"
CEMI35114	35mm x 1-1/4"
CEMI42112	42mm x 1-1/2"

## WALLPLATE ELBOWS

Code	Size
CWP1512	15mm x 1/2"
CWP2212	22mm x 1/2"
CWP2234	22mm x 3/4"



## REDUCING TEES - FEMALE

Code	A	B	C
CTFI1512	15mm	15mm	1/2"
CTFI2212	22mm	22mm	1/2"
CTFI2234	22mm	22mm	3/4"

## REDUCING TEES

Code	A	B	C
CT112	15mm	15mm	22mm
CT211	22mm	15mm	15mm
CT212	22mm	15mm	22mm
CT221	22mm	22mm	15mm
CT28128	28mm	15mm	28mm
CT2815	28mm	28mm	15mm
CT2822	28mm	28mm	22mm
CT28222	28mm	22mm	22mm
CT28228	28mm	22mm	28mm
CT3515	35mm	35mm	15mm
CT3528	35mm	35mm	28mm

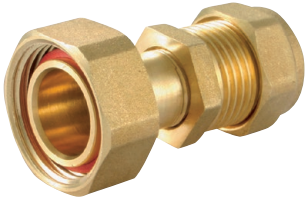

## TAP CONNECTORS - STRAIGHT

Code	Size
CTC1512	15mm x 1/2"
CTC1534	15mm x 3/4"
CTC2234	22mm x 3/4"



## TAP CONNECTORS - BENT

Code	Size
CBT1512	15mm x 1/2"
CBT2234	22mm x 3/4"



## TANK CONNECTORS

Code	Size
CTC15	15mm
CTC22	22mm
CTC28	28mm
CTC35	35mm
CTC42	42mm
CTC54	54mm



## COPPER OLIVES

Code	Size
CO1008C	8mm
CO1010C	10mm
CO1012C	12mm
CO1015C	15mm
CO1020C	20mm
CO1022C	22mm
CO1025C	25mm
CO1028C	28mm
CO1035C	35mm
CO1042C	42mm
CO1054C	54mm
CO1034C	3/4"



## BRASS OLIVES

Code	Size
CO1008B	8mm
CO1010B	10mm
CO1012B	12mm
CO1015B	15mm
CO1020B	20mm
CO1022B	22mm
CO1025B	25mm
CO1028B	28mm
CO1035B	35mm
CO1042B	42mm
CO1054B	54mm
CO1034B	3/4"



## INTERNAL REDUCING SETS

Code	Size
CR1006	10 x 6mm
CR1008	10 x 8mm
CR1508	15 x 8mm
CR1510	15 x 10mm
CR1510P1	15 x 10mm (1 Part)
CR1512	15 x 12mm
CR2815	28 x 15mm
CR2822	28 x 22mm
CR3515	35 x 15mm
CR3522	35 x 22mm
CR3528	35 x 28mm
CR4215	42 x 15mm
CR4228	42 x 28mm
CR5428	54 x 28mm
CR5442	54 x 42mm



## COMPRESSION NUTS

Code	Size
CN1008	8mm
CN1010	10mm
CN1015	15mm
CN1022	22mm
CN1028	28mm



COUPLINGS	
Code	Size
CPC15	15mm
CPC22	22mm
CPC28	28mm



MALE ADAPTORS	
Code	Size
CPMI1512	15mm x 1/2"
CPMI2234	22mm x 3/4"



FEMALE ADAPTORS	
Code	Size
CPFI1512	15mm x 1/2"
CPFI2234	22mm x 3/4"
CPFI221	22mm x 1"



STOPENDS	
Code	Size
CPEC15	15mm
CPEC28	28mm



ELBOWS	
Code	Size
CPE15	15mm
CPE22	22mm
CPE28	28mm



MALE ELBOWS	
Code	Size
CPME1512	15mm x 1/2"
CPME2234	22mm x 3/4"



FEMALE ELBOWS	
Code	Size
CPFE1512	15mm x 1/2"
CPFE1534	15mm x 3/4"
CPFE2234	22mm x 3/4"



WALLPLATE	
Code	Size
CPWP15	15mm x 1/2"
CPWP2234	22mm x 3/4"



EQUAL TEES	
Code	Size
CPT15	15mm
CPT22	22mm
CPT28	28mm

REDUCING TEES			
Code	A	B	C
CPT221	22mm	22mm	15mm





## COUPLINGS

Code	Size	Olive
MCF600B	8mm	Brass
MCF600C	8mm	Copper
MCF630B	15mm	Brass
MCF630C	15mm	Copper
MCF633B	22mm	Brass
MCF633C	22mm	Copper



## REDUCING COUPLINGS

Code	Size	Olive
MCF611B	10 x 8mm	Brass
MCF615B	15 x 8mm	Brass
MCF615C	15 x 8mm	Copper
MCF625B	15 x 10mm	Brass
MCF625C	15 x 10mm	Copper
MCF632B	22 x 15mm	Brass
MCF632C	22 x 15mm	Copper



## MALE ADAPTORS

Code	Size	Olive
MCF618B	10mm x 1/2"	Brass
MCF618C	10mm x 1/2"	Copper



## ELBOWS

Code	Size	Olive
CE08B	8mm	Brass
CE08C	8mm	Copper
MCF640B	15mm	Brass
MCF640C	15mm	Copper
MCF642B	22mm	Brass
MCF642C	22mm	Copper



## REDUCING ELBOWS

Code	Size	Olive
MCF643B	22 x 15mm	Brass
MCF643C	22 x 15mm	Copper



## EQUAL TEES

Code	Size	Olive
MCF648B	10mm	Brass
MCF660B	15mm	Brass
MCF660C	15mm	Copper



## REDUCING TEES

Code	A	B	C	Olive
MCF700B	15mm	10mm	10mm	Brass
MCF710B	15mm	15mm	8mm	Brass
MCF710C	15mm	15mm	8mm	Copper
MCF715B	15mm	15mm	10mm	Brass
MCF715C	15mm	15mm	10mm	Copper
MCF721B	22mm	15mm	15mm	Brass
MCF730B	22mm	22mm	10mm	Brass
MCF725B	22mm	22mm	15mm	Brass

# BIG BOSS

## THE CONVENIENT ALTERNATIVE TO THE STRAP-ON BOSS

- Easy fitting means that fitting time is much less than existing methods.
- Simply drill correct size hole, remove burr, glue, and fix.
- Looks far better than existing applications, largely due to a neater finish and more precise fit.
- Less material than existing currently used strap on boss fittings.
- Internal stop to ensure connection doesn't cause a blockage
- Ideal when soil stack is too close to wall to allow a strap on boss to be fitted
- 2.5° fall on fitting to ensure best practice when fitted.
- Manufactured in ABS for solvent weld application
- Made in UK



### BIG BOSS ADAPTORS - BLACK

Code	Colour	Size	Holesaw
BB1/BL	Black	3/4" 110mm	25mm
BB3/BL	Black	1-1/4" 110mm	38mm
BB2/BL	Black	1-1/2" 110mm	44mm

### BIG BOSS ADAPTORS - GREY

Code	Colour	Size	Holesaw
BB1/GR	Grey	3/4" 110mm	25mm
BB3/GR	Grey	1-1/4" 110mm	38mm
BB2/GR	Grey	1-1/2" 110mm	44mm

### BIG BOSS ADAPTORS - WHITE

Code	Colour	Size	Holesaw
BB1/WH	Black	3/4" 110mm	25mm
BB3/WH	Black	1-1/4" 110mm	38mm
BB2/WH	Black	1-1/2" 110mm	44mm

# 07

## MALLEABLE IRON FITTINGS

76.	Plugs
76	Backnuts
76.	Sockets
76.	Bushes
76.	Caps
76-77.	Nipples
77.	Elbows
77.	Unions
77.	Tees
78.	Pipe Clips & Backplates



## HOLLOW PLUGS

Black Iron	Size	Galvanised
MIBP14	1/4"	MIGBP14
MIBP38	3/8"	MIGBP38
MIBP12	1/2"	MIGBP12
MIBP34	3/4"	MIGBP34
MIBP1	1"	MIGBP1
MIBP114	1-1/4"	MIGBP114
MIBP112	1-1/2"	MIGBP112
MIBP2	2"	MIGBP2



## SOLID PLUGS

Black Iron	Size	Galvanised
C148-18N	1/8"	C148-18
C148-14N	1/4"	C148-14
C148-38N	3/8"	C148-38
C148-12N	1/2"	C148-12
C148-34N	3/4"	C148-34
C148-1N	1"	C148-1
C148-114N	1-1/4"	C148-114
C148-112N	1-1/2"	C148-112
C148-2N	2"	C148-2

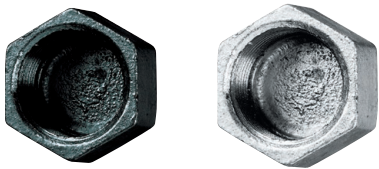

## CAPS

Black Iron	Size	Galvanised
MIBC14	1/4"	MIGC14
MIBC38	3/8"	MIGC38
MIBC12	1/2"	MIGC12
MIBC34	3/4"	MIGC34
MIBC1	1"	MIGC1
MIBC114	1-1/4"	MIGC114
MIBC112	1-1/2"	MIGC112
MIBC2	2"	MIGC2



## BACKNUTS

Black Iron	Size	Galvanised
MIBK14	1/4"	MIBKG14
MIBK38	3/8"	MIBKG38
MIBK12	1/2"	MIBKG12
MIBK34	3/4"	MIBKG34
MIBK1	1"	MIBKG1
MIBK114	1-1/4"	MIBKG114
MIBK112	1-1/2"	MIBKG112
MIBK2	2"	MIBKG2



## SOCKETS

Black Iron	Size	Galvanised
MIBS14	1/4"	MIGS14
MIBS38	3/8"	MIGS38
MIBS12	1/2"	MIGS12
MIBS34	3/4"	MIGS34
MIBS1	1"	MIGS1
MIBS114	1-1/4"	MIGS114
MIBS112	1-1/2"	MIGS112
MIBS2	2"	MIGS2



## MxR REDUCING BUSHES

Black Iron	Size	Galvanised
MIBBS3814	3/8" x 1/4"	MIGB3814
MIBBS1214	1/2" x 1/4"	MIGB1214
MIBBS1238	1/2" x 3/8"	MIGB1238
MIBBS3438	3/4" x 3/8"	MIGB3438
MIBBS3412	3/4" x 1/2"	MIGB3412
MIBBS138	1" x 3/8"	MIGB138
MIBBS112	1" x 1/2"	MIGB112
MIBBS134	1" x 3/4"	MIGB134
MIBBS11412	1-1/4" x 1/2"	MIGB11412
MIBBS11434	1-1/4" x 3/4"	MIGB11434
MIBBS1141	1-1/4" x 1"	MIGB1141
MIBBS11212	1-1/2" x 1/2"	MIGB11212
MIBBS11234	1-1/2" x 3/4"	MIGB11234
MIBBS1121	1-1/2" x 1"	MIGB1121
MIBBS112114	1-1/2" x 1-1/4"	MIGB112114
MIBBS212	2" x 1/2"	MIGB212
MIBBS234	2" x 3/4"	MIGB234
MIBBS21	2" x 1"	MIGB21
MIBBS2114	2" x 1-1/4"	MIGB2114
MIBBS2112	2" x 1-1/2"	MIGB2112

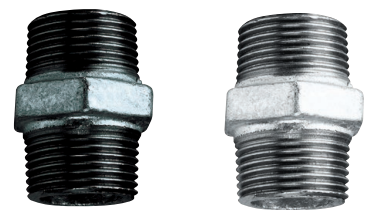

## HEXAGON NIPPLES

Black Iron	Size	Galvanised
MIBN14	1/4"	MIGN14
MIBN38	3/8"	MIGN38
MIBN12	1/2"	MIGN12
MIBN34	3/4"	MIGN34
MIBN1	1"	MIGN1
MIBN114	1-1/4"	MIGN114
MIBN112	1-1/2"	MIGN112
MIBN2	2"	MIGN2

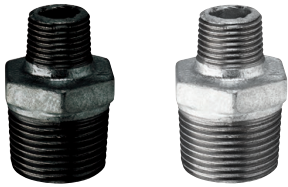

## REDUCING HEXAGON NIPPLES

Black Iron	Size	Galvanised
MIBN1418	1/4" x 1/8"	MIGRN1418
MIBN3814	3/8" x 1/4"	MIGRN3814
MIBN1214	1/2" x 1/4"	MIGRN1214
MIBN1238	1/2" x 3/8"	MIGRN1238
MIBN3438	3/4" x 3/8"	MIGRN3438
MIBN3412	3/4" x 1/2"	MIGRN3412
MIBN112	1" x 1/2"	MIGRN112
MIBN134	1" x 3/4"	MIGRN134
MIBN11434	1-1/4" x 3/4"	MIGRN11434
MIBN1141	1-1/4" x 1"	MIGRN1141
MIBN1121	1-1/2" x 1"	MIGRN1121
MIBN112114	1-1/2" x 1-1/4"	MIGRN112114
MIBN21	2" x 1"	MIGRN21
MIBN2114	2" x 1-1/4"	MIGRN2114
MIBN2112	2" x 1-1/2"	MIGRN2112
MIBN32	3" x 2"	MIGRN32



## ELBOWS

Black Iron	Size	Galvanised
MIBE14	1/4"	MIGE14
MIBE38	3/8"	MIGE38
MIBE12	1/2"	MIGE12
MIBE34	3/4"	MIGE34
MIBE1	1"	MIGE1
MIBE114	1-1/4"	MIGE114
MIBE112	1-1/2"	MIGE112
MIBE2	2"	MIGE2



## MxL ELBOWS

Black Iron	Size	Galvanised
MIBE14MF	1/4"	MIGMFE14
MIBE38MF	3/8"	MIGE38MF
MIBE12MF	1/2"	MIGE12MF
MIBE34MF	3/4"	MIGMFE34
MIBE1MF	1"	MIGMFE1
MIBE114MF	1-1/4"	MIGE114MF
MIBE112MF	1-1/2"	MIGE112MF
MIBE2MF	2"	MIGMFE2

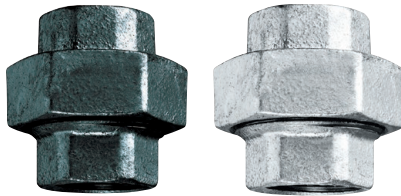

## UNIONS FxF

Black Iron	Size	Galvanised
MIBU14	1/4"	MIGU14
MIBU38	3/8"	MIGU38
MIBU12	1/2"	MIGU12
MIBU34	3/4"	MIGU34
MIBU1	1"	MIGU1
MIBU114	1-1/4"	MIGU114
MI340-112N	1-1/2"	MIGU112
MI340-2N	2"	MIGU2

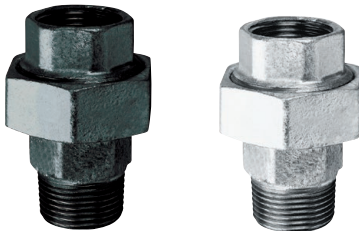

## UNIONS MxF

Black Iron	Size	Galvanised
MIBU14	1/4"	MIGU14T
MIBU38	3/8"	MIGU38T
MIBU12T	1/2"	MIGU12T
MIBU34T	3/4"	MIGU34T
MIBU1MF	1"	MIGU1T
MIBU114	1-1/4"	MIGU114T
MIBU112MF	1-1/2"	MIGU112T
MI98-2N	2"	MIGU2T

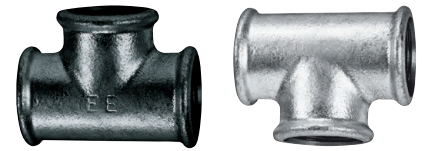

## TEES

Black Iron	Size	Galvanised
MIBT14	1/4"	MIGT14
MIBT38	3/8"	MIGT38
MIBT12	1/2"	MIGT12
MIBT34	3/4"	MIGT34
MIBT1	1"	MIGT1
MIBT114	1-1/4"	MIGT114
MIBT112	1-1/2"	MIGT112
MIBT2	2"	MIGT2

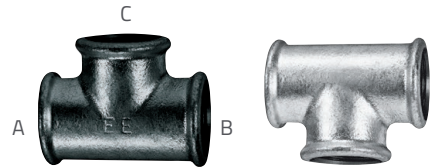

## REDUCING TEES

Black Iron	A	B	C	Galvanised
MIBT121238	1/2"	1/2"	3/8"	MIGT121238
MIBT121234	1/2"	1/2"	3/4"	MIGT121234
MIBT341212	3/4"	1/2"	1/2"	MIGT341212
MIBT341234	3/4"	1/2"	3/4"	MIGT341234
MIBT343412	3/4"	3/4"	1/2"	MIGT3412
MIBT34341	3/4"	3/4"	1"	MIGT34341
MIBT1112	1"	1"	1/2"	MI130-1-12
MIBT1134	1"	1"	3/4"	MIGT134

Can't find what you're looking for?  
Contact us to discuss your requirements.

0121 686 8711



## M10 MUNSEN RING (SINGLE)

Black Iron	Size	Galvanised
MISTP14N	1/4"	MISTP14
MISTP38N	3/8"	MISTP38
MISTP12N	1/2"	MISTP12
MISTP34N	3/4"	MISTP34
MISTP1N	1"	MISTP1
MISTP114N	1-1/4"	MISTP114
MISTP112N	1-1/2"	MISTP112
MISTP2N	2"	MISTP2



## SCHOOLBOARD CLIPS

Black Iron	Size	Galvanised
MISB14N	1/4"	MISB14
MISB38N	3/8"	MISB38
MISB12N	1/2"	MISB12
MISB34N	3/4"	MISB34
MISB1N	1"	MISB1
MISB114N	1-1/4"	MISB114
MISB112N	1-1/2"	MISB112
MISB2N	2"	MISB2



## BACKPLATES

Black Iron	Size	Galvanised
N/A	M8	RLCBPM8
MIBPM10N	M10	RLCBPM10



▪ Supplied in protective casing

## ALL ROUND GALVANISED BANDING

Code	Size	Length	Box
ARB12	12mm wide x 0.8mm	10m	20
ARB17	17mm wide x 0.8mm	10m	20

# 08

## TOOLS

80.	Immersion Heater Spanners
80.	Radiator Keys
80.	Bending Springs
80.	Pipe & Sink Cleaners
81.	Stopcock Keys
81.	Pipe Cutters
81.	Drainage Key Set



### 4-WAY MULTI KEY

Code
9T4WAY



### ADJUSTABLE BASIN WRENCH

Code
TABW

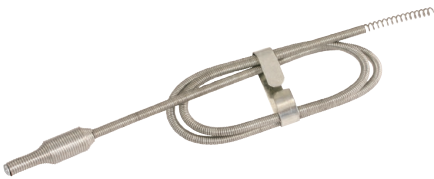

### PIPE & SINK CLEANERS

Code	Size
TL110	3ft x 0.9mm
TL115	6ft x 1.9mm
TL120	9ft x 2.75mm
TL125	12ft x 3.55mm

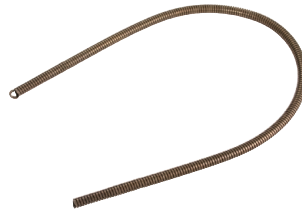

### INTERNAL BENDING SPRINGS

Code	Size
TL142	10mm
TBS15	15mm
TBS22	22mm
TBS28	28mm

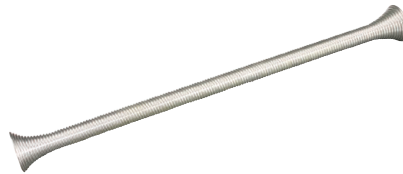

### EXTERNAL BENDING SPRINGS

Code	Size
TBS08	8mm
TBS10	10mm



### CLOCK TYPE RADIATOR KEY

Code	Finish
RK1C	Brass



### 'T' TYPE RADIATOR KEY

Code	Finish
RK1	Brass



### ALLOY RADIATOR KEY

Code	Finish
BF428	Alloy





### MINI COPPER PIPE CUTTER

Code	Size
TMTC	3-22mm

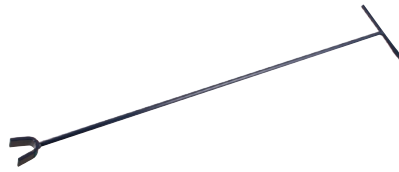

### CRUTCH TYPE STOPCOCK KEY

Code
TL090



- Strong Rubberised Magnet
- Doubles up as a USB Power Bank
- Flexible Goosenecks
- 7 hours + runtime
- Light modes: Full, Half, SOS & Flash



### STANDARD COPPER PIPE CUTTER

Code	Size
TSTC	3-30mm

### GLOFORCE EYELIGHT

Code	Gooseneck Length	Wattage
GLFM8	270mm	10w
GLFE10M8	450mm	10w

## MANUP KEY DRAINAGE SET

Introducing the ManUp Key - A revolutionary new way of lifting manholes, drain covers and utility lids. These covers can now be lifted without chiselling or hammering, reducing effort, time, damages and costs. The ManUp Key provides a 'one man' solution whilst still ensuring safe lifting and manual handling practices.

The UK produced kit consist of:

- ManUp Key Bar
- 32mm Flat Tip
- 22mm Flat Tip
- 12mm J Hook Tip
- Cleaning Tip

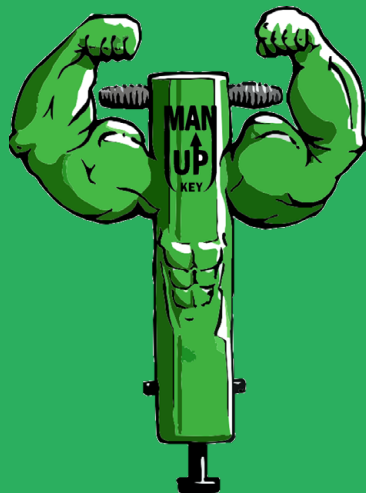

Code
MUBDS

Extra handles for easier lifting & keeping good posture

Non-slip soft grip rubber

Supplied with new accessory case



Multi directional interchangeable tips



**A**

Air Vents 30  
All round band 39

**B**

Brass Backnuts 62  
Backplates 39  
Bibtops 54  
Black Iron Fittings 76–77  
Blow-off Cap 32  
Brass Bushes 62

**C**

Brass Caps 62  
Check Valve (Oil) 43  
Check Valves 48  
Cistern Lever Arm 59  
Compression Fittings 69–71  
Cooker Hose Fittings & Accessories 9  
Cooker Hoses 8  
Copper Saddle Clips 39  
Flexible Copper Tube 66  
Gas Pipe (CSST) 12  
Cylinder Flanges 33  
Cylinder Thermostat 31

**D**

Drainage Set 81  
Drain Cocks 50  
Dry Trap Tundish 34

**E**

EasyFit Isolator 56  
Brass Elbows 63  
End Feed Fittings 64–66  
Expansion Vessel Bracket 34  
Expansion Vessel Service Valve 34  
Brass Extensions 63

**F**

Filling Loops 31  
Fire Valves 42  
Flared Fittings 43  
Flexible Tap Adaptors 53  
Float Valves 58

**G**

Galvanised Fittings 76–77  
Gas Meter Fittings 14  
Gate Valves 55  
Gloforce Eyelight 81

**H**

Hose Tails 63  
Hospital Brackets 38

**I**

Immersion Heaters 18  
Gas Isolation Valves 10  
Isolation Valves 55

**L**

Lever Ball Valves 46–47  
Locking Valve 43

**M**

Brass Manifolds 63  
Mini Ball Valves 11  
Munsen Rings 38

**N**

Brass Nipples 62  
Non-Return Valves 48

**O**

Oil Filter Bowl 43  
Oil Gauges 43

**P**

Pipe Clips 38  
Pipe Collars 39  
Pipe Cutter 81  
Brass Plugs 62  
Pressed Clips 38  
Pump Valves 52

**R**

Radiator Brackets 30  
Radiator Cap 30  
Radiator Extension Pieces 30  
Radiator Keys 30  
Radiator Valves 29  
Restrictor Tubes & Fittings 16  
Rubber Lined Clips 40

**S**

Safety Relief Valves 31  
Sealed System Installation Kit 34  
Service Valves 55  
Shock Arrestor 34  
Sludge Cock 49  
Brass Sockets 62  
Solder Ring Fittings 67–68  
Steel Saddle Clips 39  
Stopcocks 54

**T**

Tap Extensions 63  
Brass Tees 63  
TeslaTun 34  
Test Point Valves & Fittings 15  
Thermal Control Plate 27  
Thermocouples 31  
Toilet Seat Hinges 59  
Towel Rail Elements 26  
Towel Rail Valves 28

**U**

Urinal Flush Valve 59

**W**

Wallplates 54  
Washers 31  
Washing Machine Valves 57

**Y**

Y-Strainers 48





[www.teslauk.com](http://www.teslauk.com)

**SALES**

Tel: +44 (0) 121 686 8711  
Fax: +44 (0) 121 686 8712  
Email: [sales@teslauk.com](mailto:sales@teslauk.com)

**TECHNICAL**

Tel: +44 (0) 121 686 8733  
Email: [technical@teslauk.com](mailto:technical@teslauk.com)



[@TeslaUKLtd](https://www.instagram.com/TeslaUKLtd)



[@TeslaUK](https://twitter.com/TeslaUK)



[info@teslauk.com](mailto:info@teslauk.com)

Tesla UK Ltd  
Unit 3b, First Avenue  
Minworth, Sutton Coldfield  
West Midlands  
B76 1BA

VAT Reg No.: 963 7391 28  
Company Reg No.: 6081188