



Insignia

Insignia Bath Taps

Product Code: INS102

Finish: Chrome

Features

Construction:	Brass
Valve/Cartridge type:	Ceramic Disc
Supply:	Suitable for all plumbing systems
Working Pressures:	0.2 - 5.0 bar
Inlet connections:	3/4" BSP
Flexi or Copper:	Plastic Backnuts

- Optimised for bath filling
- 1/4 turn ceramic handles ensure a smooth operation
- Products which are easy to use by all the family



*Please refer to website for full warranty details.

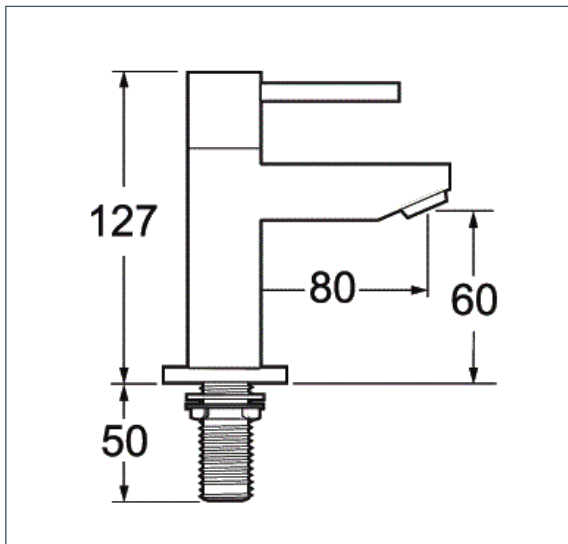

Flow (Bar - l/min, open outlet)

Spout

Flow 0.1	Flow 0.3	Flow 0.5	Flow 1.0	Flow 2.0	Flow 3.0	Flow 4.0	Flow 5.0
8	12	16	21	30	36	39	43



1404042

