

H	W	D	H	W	Edging	OP 1	OP 2	OP 3	OP 4	OP 5	OP 6	OP 7	OP 8	All drawing dimensions in millimetres Tolerance 0.25mm Unless specified

Finish Sizes Cut Sizes

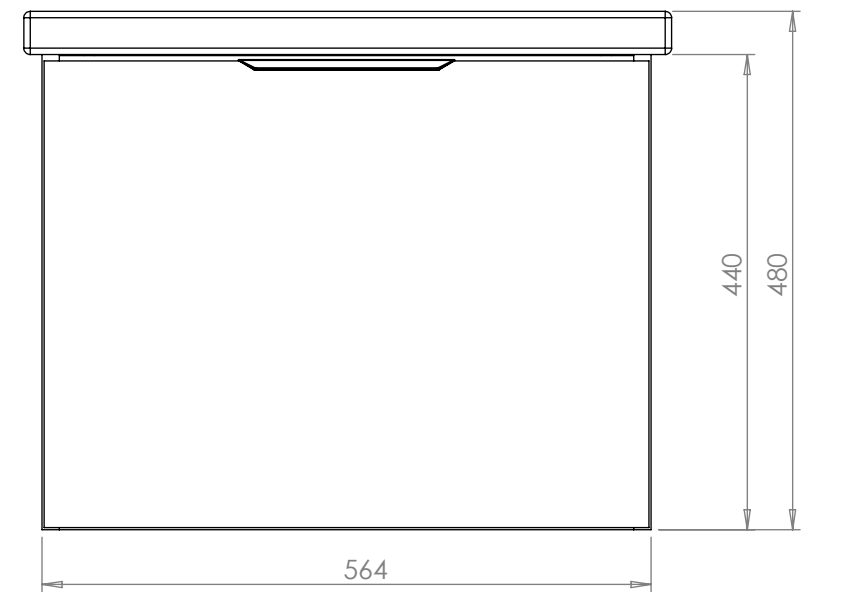
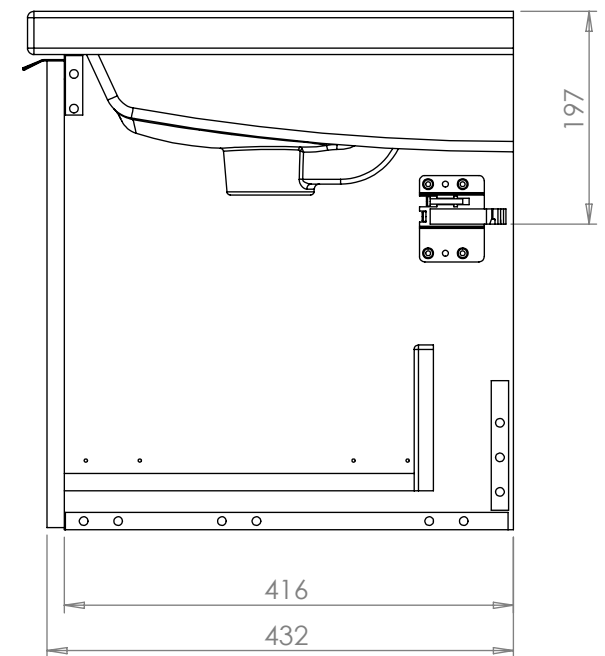
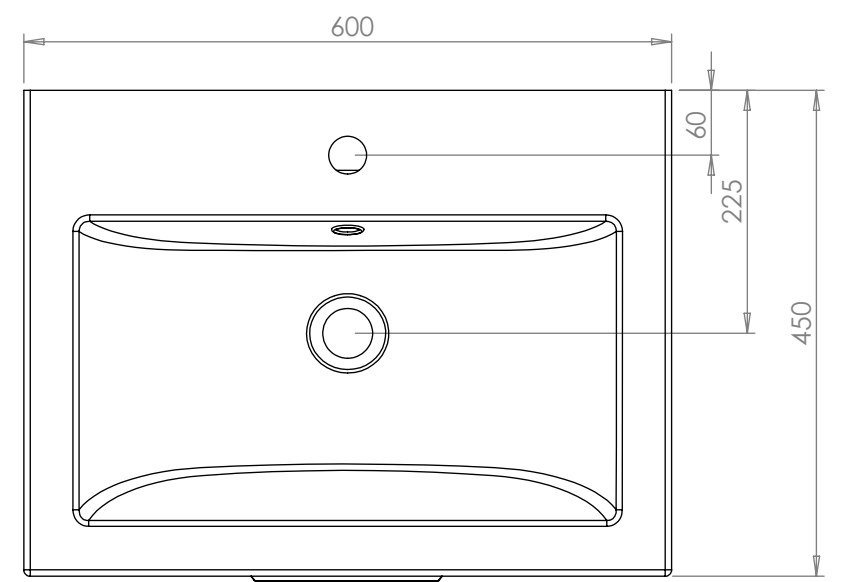

Rev	Date	Description
3	00-00-00	--
2	00-00-00	--
1	00-00-00	--

Utopia Furniture Limited Springvale Business Park Springvale Avenue Wolverhampton WV14 0QL United Kingdom Tel: +44 (0)1902 406 400 Fax: +44 (0)1902 406 401 Email: info@utopiagroup.com Web: www.utopiagroup.com	No part of this publication may be reproduced or transmitted in any form or by any means electronic or mechanical, including photocopying, recordings or otherwise stored in any retrieval of any nature without written permission of the copyright owner.	MATERIAL: -	HEIGHT: -	FILE NAME: - 600 SINGLE DRAW		
			WIDTH: -	DESCRIPTION: -	PART NUMBER: -	OLD PART NUMBER: -
			THICKNESS: -	DRAWN BY: -	DATE: - 26/07/2018	EDGING TYPE: -