

ARAYA MODERN

922031 – BASIN TAP PAIR

FRANCIS PEGLER

www.francispegler.co.uk

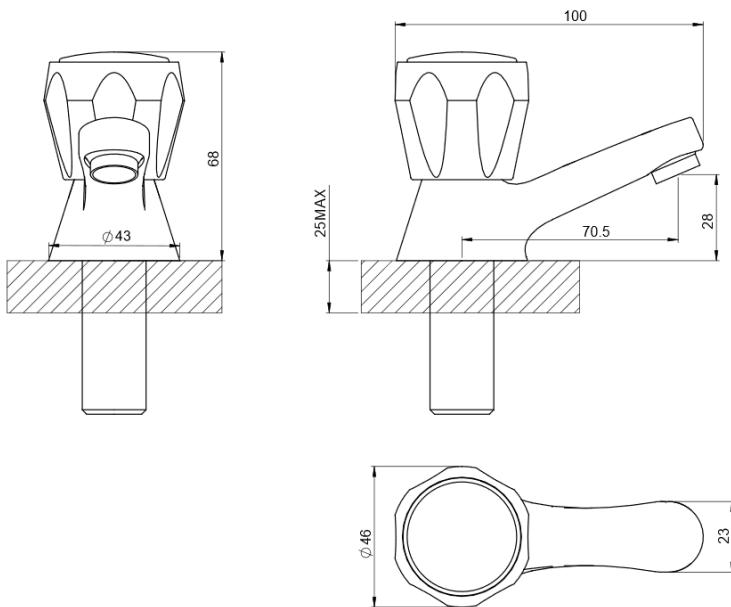

Specification

Finish	Chrome
Body	Brass
Fittings	Metal Backnut & Washer
Connection	½" BSP Threaded Tail
Min dynamic pressure	0.1
Max dynamic pressure	6
Max static pressure	16
Max water temperature	85°C

Flow rates

Pressure	0.1	0.5	1	3
F/Straight	11.3	30.3	43.3	75.8

All Pressures in Bar. All flow in L/Min.





Dimensions supplied are nominal and subject to tolerance.

Inclusion or restrictors (sold separately unless stated) will affect flow rate result.

Performance details are based on trials under test conditions and for guidance only.

The Company reserves the right to change product specification without prior notice.

Features & Benefits

 Guarantee	 Low Pressure	 Metal Back Nut	 Flow Straightener
 Single Flow			

Certifications

	
Tested at 0.2 bar	