

## Technical data

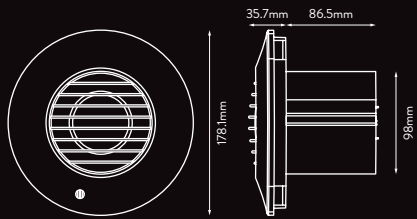

Shower Fan Complete

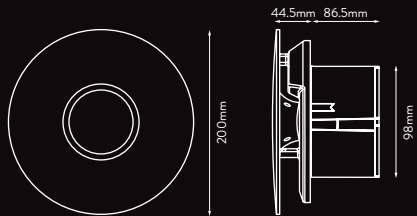

Illumi Shower Fan Complete

## Ceiling installation

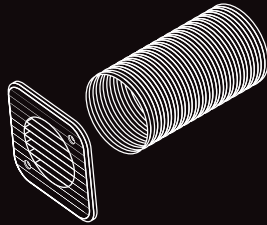
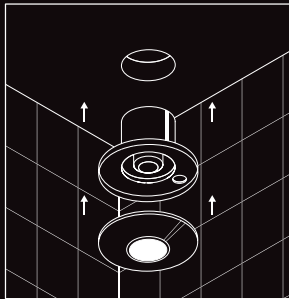

**Kit Includes\*:**  
Extractor Fan, External Grille & 3M Flexible Ducting.

## Side view

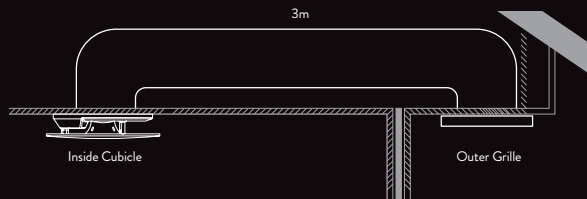

## Product information

### Models

Models		Design	Timer	Transformer	Light
Shower Fan Complete	93086AW	●	✓		
Illumi Shower Fan Complete	93087AW	●	✓	✓	✓

### Performance

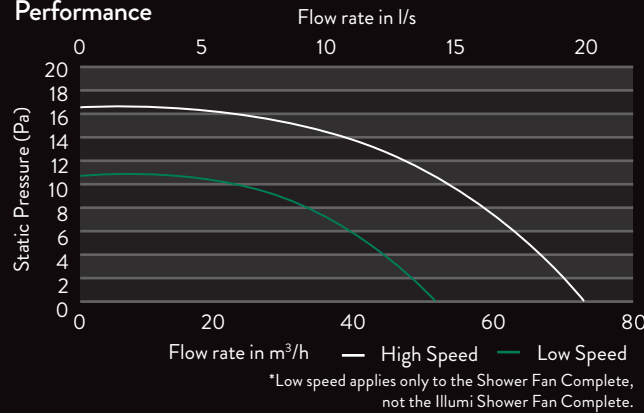

### Specification

	Shower Fan Complete	Illumi Shower Fan Complete
Speeds	2	1
Extract Performance (l/s)	15/21	21
Extract Performance (m <sup>3</sup> /h)	54/76	76
Electrical Power Rating (W)	6.7/7.7	12.2 (Fan Only) 15 (Fan & Light)
Specific Fan Power (W/l/s)	0.45/0.37	0.58
Sound Pressure Level (dBA@3M)	22/34	29
IP Rating	X4	X4
Installation Zone	Zone 1	Zone 1
Voltage	240V 60Hz	
LED Type	Warm White	
Lumens	207	



## Simply Silent™ Shower Fan Complete range

So quiet. So stylish. So simple to install.



4"/100mm extractor fan and installation kit.  
Also available with built-in LED light.



Sound pressure testing carried out at ISVR, University of Southampton – August 2015

ISVR Consulting  
Consultants in Noise and Vibration

Sales Hotline: 0844 372 7750  
Sales Fax: 0844 372 7760  
[www.xpelair.co.uk](http://www.xpelair.co.uk)

**Xpelair**  
AIR QUALITY INNOVATION

X124

**GH@ST**  
AIR MOVEMENT TECHNOLOGY

**Xpelair**  
AIR QUALITY INNOVATION

Calls cost 7p per minute plus your network provider's standard access charge.

## High power. In-shower

### Low on sound. High on performance

Combining low noise levels with high extraction power, Simply Silent™ Shower Fans are purpose-designed for in-shower installation. They carry out direct extraction right at the point of humidity for a steam-free bathroom environment. In fact, an installed Simply Silent™ Shower Fan achieves an 88% improved extraction rate over comparable in-line shower fans.

### So Simple Installation

Because they're positioned directly in the shower cubicle itself, they're quick and easy to fit. Plus, they aren't subjected to the loft space temperature extremes that in-line shower fans are. They also come with an installation kit, which includes external grille and 3m flexible ducting.

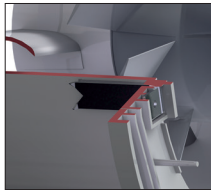

#### Quick-fit clamp

The built-in So Simple quick-fit clamp allows the fan to be secured simply to ceilings.

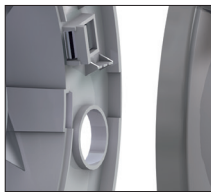

#### Larger cable access

Larger cable access slots enable easy wiring.



#### Radial fixing points and level reference

Use the level reference to ensure a flexible and accurate fan alignment.



#### No screws needed

The hook and clip fan cover on the Simply Silent™ Shower Fan Complete allows for quick, fuss-free installation.

## Simply Silent™ Illumi Shower Fan Complete

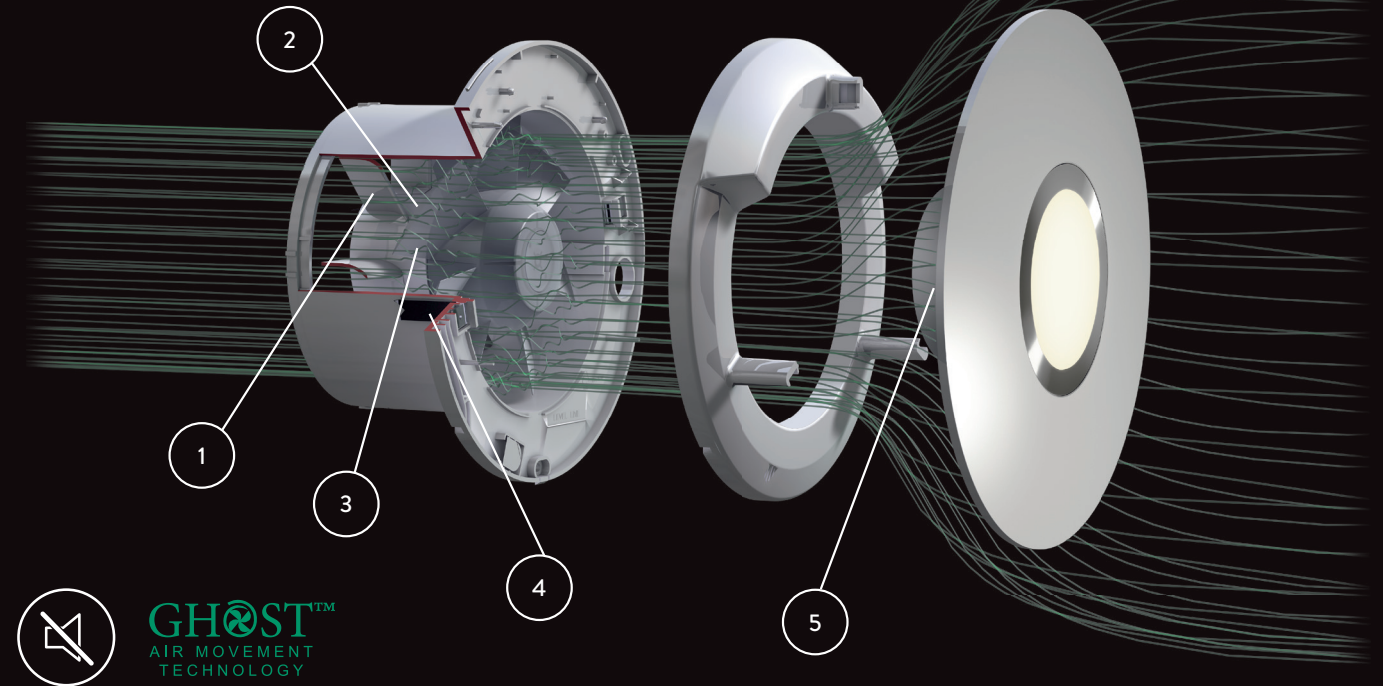

The Simply Silent™ family of purpose-designed in-shower fans use unique, innovative Ghost™ Air Movement Technology to deliver near-silent running.

Fan noise comes from both the motor and the movement of air. To combat this, Ghost™ Air Movement Technology uses long-life silent running motors and precision engineered components to avoid mechanical noise, while advanced air flow management eliminates irregular air flow paths and turbulence.

### A look inside



Flow straighteners guide air through the duct, reducing turbulence.



Long-life ball-bearing motors suppress motor noise.



Optimised impeller blade design maximises performance, while minimising noise.



So Simple in-shower installation with use of quick fit clamps.



Sleek stylish fascia design with warm white LED light available specifically for the Illumi.