

Hep₂O

Installer Guide



Flexible plumbing by Wavin

**NEW
Product
Selector
Section**

wavin

Contents

	Page	
Introduction	4	Next generation Hep ₂ O
	5	Unique 'next generation' benefits:
	6	Easier installation and proven performance
	7	Approvals
Basics	8	Hep ₂ O Polybutylene Pipe
	8	Straight
	8	Coil
	9	Standard pipe
	9	Barrier pipe
	10	Cutting Hep ₂ O pipe
	11	Hep ₂ O fittings
	12	Jointing with Hep ₂ O pipe and fittings
	12	SmartSleeve [™] pipe support sleeve
	13	Jointing procedure
	14	Jointing copper pipe to Hep ₂ O fittings
	15	Checking the joint using In4Sure [™] joint recognition technology
	16	Demounting joints using the Hep ₂ O HepKey [™] system
	16	Two types of HepKey [™] are available:
	16	To use HepKey Plus [™] :
	17	To use HepKey [™] :
	18	Hints and tips for trouble-free Hep ₂ O installation
	18	Hep ₂ O pipe
	19	Hep ₂ O fittings
	19	Handling and storage
20	Colour-coded packaging	
Other jointing applications	21	Connecting Hep ₂ O pipe to compression fittings
	22	Hep ₂ O connections adjacent to capillary joints
	22	Connection to chrome plated or stainless steel pipe
	22	Connection to brass spigots
	22	Connection to earlier Hep ₂ O systems
	23	Connecting Hep ₂ O fittings to other brands of pipe
	23	Connecting Hep ₂ O to steel pipes and threaded bosses
	24	Connections to appliances using Hep ₂ O
	24	System alterations
	24	Using a blanking peg to seal off a fitting
	24	Using a stop end to seal off a pipe
	25	Where it's OK to use Hep ₂ O
	25	Where it's not OK to use Hep ₂ O
Sitework	26	Cabling through joists
	27	Less risk to health and greater site safety
	27	Hep ₂ O push-fit jointing also has the following advantages:
	27	Other system benefits include:
	27	Drilling the floor joists
	29	Engineered joists
	29	Spigot tees and manifolds
	29	Connecting pumps, valves etc:
	29	Pipe support
	31	Cable ties
	31	Pipe support distances
	32	Minimum bending radius for Hep ₂ O pipe
	32	Pipework installation

Contents

	Page	
Sitework cont.	32	Concealed locations
	33	Use of metal tape to aid 'electronic' pipe detection
	34	Pipes through walls and floors
	34	Laying pipe in floor screeds
	34	Pipes adjacent to metalwork
	34	Hep ₂ O pipe means quieter operation because there's less noise...
	35	Installing pipes in concrete floors or walls
	35	Hep ₂ O conduit system
	36	Installation
	38	Fitting a junction box
	39	Fitting pipe into conduit
	40	Terminating the conduit
	42	Hep ₂ O Pipe-in-Pipe system
Heating systems	43	Dry lined wall feeds for radiators
	43	Radiator outlet cover plate
	44	First-fix radiator feeds
	45	Connecting Hep ₂ O pipe to storage vessels and radiators
	45	Connecting Hep ₂ O to ancillaries (<i>pumps, valves, etc.</i>)
	46	Connecting boilers and heaters
	47	Manifolds
	48	Installation and performance benefits
	48	Hep ₂ O within internal drywall systems
	49	Hep ₂ O within timber framed and steel framed buildings
	50	General advice
Important information	51	Freezing for maintenance/system modification
	51	Painting Hep ₂ O
	51	Use of corrosion inhibitors
	51	Antifreeze
	52	Electrical safety
	52	Equipotential bonding
52	Woodworm / timber treatment	
Precautions	53	External installations
	53	Vermin
	53	Chlorine
Testing	54	Pressure testing
	55	Testing procedure
Special applications	56	Boats
	56	Caravans
	56	Exhibitions
	56	Portable buildings, site cabins, toilets etc.
	56	Agriculture and horticulture
Fault finding	57	Typical Problems
	57	1. Joint weeps
	57	2. Split fittings
	58	3. Pipe or fitting melting
General information	59	Advisory service
	59	Other sources of information
Product selector	60	

Introduction

This Installer Guide is designed to help professional plumbers obtain the best results when using Hep₂O plastic push-fit fittings and pipe. It provides guidance on good plumbing practice and comprehensive advice to enable users to get the best possible performance from the Hep₂O system.

Hep₂O is a fully tried and tested system and has been the first choice of professional plumbers in the UK for over 30 years. We've listened to our customers, and made some major improvements to the fittings. The result is our 'Next Generation' Hep₂O system.

Next Generation Hep₂O

Next Generation Hep₂O is our most technologically advanced professional plastic push-fit plumbing system available, with a fully comprehensive range of white fittings and some unique new features designed to reduce installation time and improve operating performance.

Hep₂O pipe is now white to match the new range of fittings, but pipe flexibility and ease of 'cabling' is exactly the same as before.

The Hep₂O system is available in 10, 15, 22 and 28mm sizes, and we've introduced a simple colour-code for the packaging to make identification easier:

- 10mm: **green**
- 15mm: **blue**
- 22mm: **purple**
- 28mm: **orange**



Fig. 1 Next Generation Hep₂O

Introduction

Unique Next Generation benefits:

We've listened to our customers, all professional plumbers and heating engineers, and we've responded to their wish list with some unique features that are not available with any other comparable push-fit system:

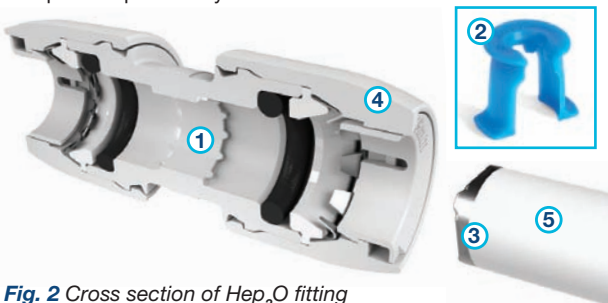

Fig. 2 Cross section of Hep₂O fitting

1. In4Sure™ joint recognition tells you when the pipe's inserted

Just insert the pipe into the fitting then rotate it. If it's fully inserted you'll feel a 'rumbling' sensation, caused by the profiled end of the pipe support sleeve making contact with the castellated seat inside the fitting.

2. New HepKey™ demounting system

The clever new **HepKey™** makes demounting quick, easy and tamper-proof, so joints only come apart when you want them to.

3. New SmartSleeve™ for reduced force joint assembly

As well as forming part of the new **In4Sure™** technology, the clever design of the new **SmartSleeve™** pipe support sleeve also reduces the force required to push the pipe into the fitting.

4. New white fittings with sleek new look

The white colour combined with a slimmer, more streamlined and altogether more stylish design, means Hep₂O fittings are now much more acceptable for 'on view' applications.

5. Same quality pipe – but now in white

We've changed the colour but all the other traditional benefits of Hep₂O pipe have been retained. It is just as flexible as ever and with our straight coil technology stays straight when uncoiled.

Market-leading 50 year guarantee

Due to a rigorous quality control and testing programme, all Next Generation Hep₂O pipe and fittings are guaranteed for 50 years against defects in materials and manufacturing.

The only proviso is that good professional installation practice is followed, as outlined in this guide. Notably, this includes working within the peak life cycle operating temperatures and pressures detailed in Table No.1 - see page 7.

Introduction

Easier installation and proven performance

Hep₂O has evolved over 30 years and is now recognised as the professional's system of choice. With significant performance benefits, easier and quicker installations without any compromise on quality or joint integrity. Pipe flexibility and joint security remain the key benefits of Hep₂O.

- Flexible pipe means it can more easily be 'cabled' around obstructions.
- 'Cabling' the pipe means fewer joints are required.
- Fewer joints reduce installation time and system costs.
- Push-fit also means no naked flames with reduced inherent risks.

There are also significant long-term performance benefits over traditional rigid metal systems.

- Plastic pipe means no scale build-up.
- No corrosion and reduced risk of burst pipes.
- Quieter in service, cooler to the touch and less heat loss.



Easy demounting with **HepKey™**



Easy cabling. Fewer joints



High resistance to impact



Measure and cut in-situ



No scale build-up



No bursts. Corrosion free

Fig. 3 Hep₂O offers significant benefits over traditional systems

Introduction

Approvals

Hep₂O carries a British Standard Kitemark against **BS7291** parts 1 & 2 Class S. Standard pipe and fittings also carry a British Standard Kitemark against **BS EN ISO 15876**. Barrier pipe and fittings also carry a British Standard Kitemark against **BS EN ISO 21003**.

All products are manufactured under the scope of a Quality Management System that is third party accredited to **BS EN ISO 9001:2008**.



Hep₂O is listed in the Water Fittings and Materials Directory – listing number 0812080.

Hep₂O is suitable for use in domestic water distribution and central heating systems including pressurised systems and combination boilers in accordance with Table No. 1. It may also be used in buildings other than dwellings providing the service conditions are not exceeded.

Hep₂O pipe is offered in two types, Standard and Barrier (see page 9). Both are accepted by British Gas / Scottish Gas Central Heating Care Contracts.

Table No. 1 Peak life cycle operating temperatures/pressures

	20°C	30°C	40°C	50°C	60°C	70°C	80°C	95°C	Short Malfunction at 114°C
Safe pressures:									
Bar	12	11.5	11	10.5	9	8	7	6	3
psi	174	167	160	152	131	116	102	87	43.5
Head of water (m)	120	115	110	105	90	80	70	60	29

Note:

All reference to Hep₂O fittings on the following pages refer to the latest 'Next Generation' range of all white fittings.

Hep₂O Polybutylene pipe

Available in straight lengths or coils in Standard or Barrier.

Straight

Straight lengths of Hep₂O Standard and Barrier pipe are supplied in 3m lengths in 15mm, 22mm and 28mm diameters. Straight pipe is just as flexible as coiled pipe and is primarily intended for exposed pipework where neatness is vital, or where only a short length of pipe is required.

Coil

A unique characteristic of Hep₂O pipe coil is its remarkable ability to remain straight once uncoiled, unlike some other plastic materials which act like a spring. This makes handling so awkward that two men may well be required to carry out a relatively simple job.

Hep₂O pipe is much easier to handle and much easier to cable because of its inherent tendency to stay where it's put. Even though the colour has changed from grey to white, the easy handling attributes of Hep₂O pipe remain unchanged.

Coiled Hep₂O pipe is supplied in 25m to 100m coils, in 10mm, 15mm, 22mm and 28mm diameters, in a **SmartPack™** dispenser.

- Choice of Standard or Barrier pipe.
- Uncoiled pipe retains its flexibility.
- For installations into screed use the Hep₂O 'Pipe-in-Pipe' system. This incorporates Hep₂O Barrier pipe in a pre-sheathed conduit.



Fig. 4 Hep₂O pipe (left) comes off the coil straight

Standard pipe

- Suitable for domestic hot/cold water and heating applications.
- When used for heating, a suitable inhibitor such as Sentinel or Fernox MB1 should be used.

Barrier pipe

- Designed for central heating systems.
- Incorporates an oxygen barrier to inhibit oxygen permeation.
- Use of inhibitors are recommended as corrosion can occur in all types of system regardless of pipe material.
- May also be used for domestic hot and cold water services.

Note:

Hep₂O pipe is NOT suitable for conveying gas, oil or underground supplies



- Cut length:
Standard and Barrier straight cut lengths.

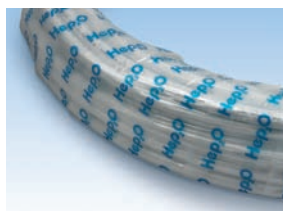

- Standard coiled pipe:
Straight coiled lengths in **SmartPack™** dispenser.



- Barrier coiled pipe:
Straight coiled lengths in **SmartPack™** dispenser.



- Pipe-in-Pipe system:
Hep₂O Barrier pipe in blue or red conduit.

Fig. 5 Hep₂O offers a range of pipe options

Cutting Hep₂O pipe

Recommended cutters (*HD74, HD75, HD77 or HD78*), as shown in the current Hep₂O Trade Price List should be used to cut Hep₂O pipe. Place the pipe in the jaws of the cutter and apply pressure, then rotate the pipe and maintain the pressure until it is severed (see *Fig. 6*).

Before making a joint, check that the pipe end is clean, cut square and free from burrs and surface damage.

Do use recommended cutters to cut the pipe.
Do test the pipe is fully inserted into the fitting when making a joint using our **In4Sure™** technology. Calculate the correct pipe length, cut the pipe at one of the cutting marks 'Λ' printed onto the pipe (see *Fig. 8*). The distance between the 'Λ' marks is the insertion depth into the fitting and this should be allowed for.



Fig. 6 Always use recommended cutters to cut Hep₂O pipe



Fig. 7 Don't use a hacksaw to cut Hep₂O pipe

Don't use a hacksaw to cut Hep₂O pipe.
Don't use damaged pipe. Ensure pipe ends are free from burrs and surface damage. If not, re-cut the pipe.

Table No. 2 Correct insertion depths for Hep₂O fittings

Pipe size	Nominal insertion depth including sleeve
10mm	28mm
15mm	32mm
22mm	33mm
28mm	36mm

Note:

SmartSleeve™ support sleeve is an integral part of the system and should NEVER be omitted when using Hep₂O pipe.

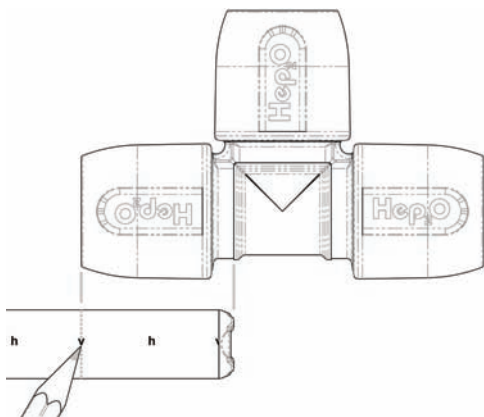

Fig. 8 Hep₂O 15mm assembly with pipe markings

Hep₂O fittings

Hep₂O fittings are only available in white. They are offered in colour-coded packs (see 'Packaging', page 20) in a range of sizes 10, 15, 22 and 28mm and in a comprehensive range of types to answer all domestic hot/cold water and heating applications.

All O-ring seals contained in Hep₂O fittings have been pre-lubricated during factory assembly and during normal installation additional lubrication should not be required.

If the fitting has been used previously or if fittings have been un-bagged for several weeks, then the lubricant may have been removed or dried out and may require replacing. In these situations Hep₂O Jointing Lubricant Spray (code HX200) must be used to avoid contravention of Water By-laws and ensure compatibility with other system materials (see Fig. 9).

Don't use other manufacturer's lubricant or any alternative.



Fig. 9 Spraying used O-ring with silicone lubricant

Jointing with Hep₂O pipe and fittings

SmartSleeve™ pipe support sleeve

Before making a joint using Hep₂O pipe, it is essential to insert a Hep₂O **SmartSleeve**™ pipe support sleeve into the cut pipe end (see Fig. 10). The only exception is when connecting to the open spigot end of a Hep₂O fitting.

The **SmartSleeve**™ has several purposes:

- It ensures the pipe retains its circular cross-section.
- It eases insertion of the pipe into the fitting.
- The profiled end of the **SmartSleeve**™ helps you to check the pipe is fully inserted. See **In4Sure**™ joint recognition technology (see page 15).
- It maintains the rigidity of the pipe within the fitting.
- It retains the circular cross-section of the pipe under extreme temperatures.
- Barbs on the **SmartSleeve**™ lock it in the pipe, which helps ensure it is not left in the fitting when demounting.

All **SmartSleeve**™ pipe inserts are manufactured from 'food quality' 316 stainless steel and are impervious to contaminants. They are designed to be captive in the pipe but can be removed if required, using long nosed pliers. However, if damaged, the **SmartSleeve**™ must not be re-used.

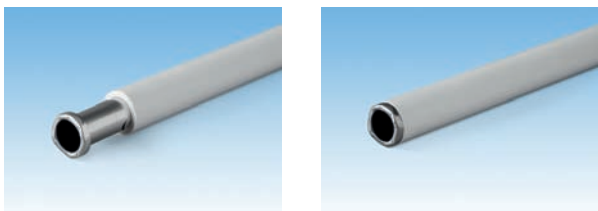

Fig. 10 Inserting **SmartSleeve**™ into pipe

Jointing procedure

Whichever type of Hep₂O fitting is used, the same jointing procedure should be followed.



1. Cut the pipe squarely at one of the 'Λ' marks using recommended pipe cutters and ensure the pipe end is free from burrs (see page 10).



2. Insert a Hep₂O **SmartSleeve**[™] pipe support sleeve into the pipe end.



3. Push the pipe firmly into the fitting, then use Hep₂O's unique **In4Sure**[™] joint recognition technology to 'feel' if the pipe is fully inserted (see page 15).



4. Tug back on the pipe to ensure the grab-ring engages correctly and prevents the pipe withdrawing.

Fig. 11 Hep₂O jointing sequence

Jointing copper pipe to Hep₂O fittings

Hep₂O fittings have been designed to form reliable joints with metric copper pipe which conforms to **BS EN 1057 - R520**.

1. Measure the pipe, allowing sufficient length for insertion into the fitting, and mark with a pencil (see *Table No.2*).
2. Cut the copper pipe with a wheel cutter.
3. Carefully inspect the pipe ends for burrs or swarf.
4. Push the pipe firmly into the fitting.
5. Tug back on the pipe to ensure the grab-ring engages correctly and prevents the pipe withdrawing.

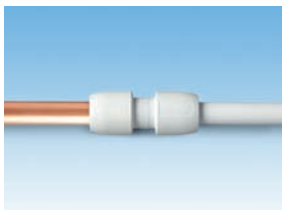

Fig. 12 Hep₂O fittings are also compatible with copper pipe

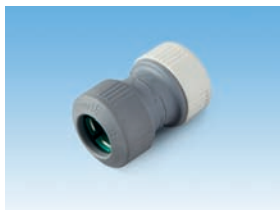

Fig. 13 HD3A/22 3/4" Imperial/22mm adaptor

With a little extra care, it is also possible to connect 10mm **BS EN 1057 - R220** copper pipe into Hep₂O fittings.

R220 pipe is particularly 'soft' and therefore susceptible to becoming misshaped or dented if it is not handled with care. Particular attention should be paid to the cut end, looking for any signs of damage. R220 copper pipe should be cut with a mini wheel cutter, and then a chamfer should be filed on the pipe and any copper filings rinsed away, and the pipe dried-off.

Hep₂O can also be connected to 3/4" Imperial copper pipe using a special O-ring straight adaptor (*HD3A/22*) which accepts 22mm copper pipe at one end and 3/4" Imperial copper pipe at the other.

Note:

New pipe insert for copper providing joint recognition will be available soon.

Checking the joint using In4Sure™ joint recognition technology

Follow normal procedure to establish the insertion depth of the pipe into the fitting as previously described (see page 13).

In4Sure™ joint recognition technology then provides a further check by allowing you to 'feel' if the pipe is fully inserted.

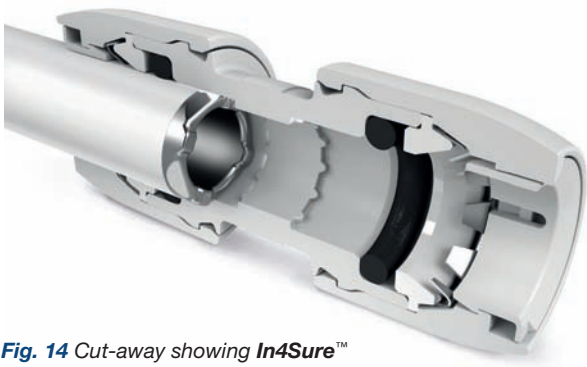

Fig. 14 Cut-away showing **In4Sure™** joint recognition technology

To use **In4Sure™** joint recognition technology:

1. Hold the centre (*fixed*) part of the fitting in one hand.
2. After inserting the appropriate pipe sleeve, push the pipe firmly into the fitting.
3. While still pushing, rotate the pipe using a screwing action. If the pipe is fully inserted you will feel a 'rumbling' sensation as the profiled end of the **SmartSleeve™** passes over the castellated seat inside the fitting.
4. Pull back to check the joint integrity.

This simple procedure is designed to give you the peace of mind that comes from knowing that the joint is good. You can also make a visual check by checking the next 'Λ' mark is level with the end of the fitting.

Demounting joints using the Hep₂O

Three types of demounting tool are available:

- **HepKey Plus™** simply clips onto the fitting and holds the grab-ring in its release position.
- The **HepKey™** is small enough to be kept in your pocket.
- **HepTool™** is a specialist metal demounting tool which can help in restricted spaces, for example where a fitting is hard up against a wall or another fitting.



Fig. 15 HepKey Plus™



Fig. 16 HepKey™

HepKey™ and **HepKey Plus™** are colour coded: 10 **green**, 15 **blue**, 22 **purple** and 28mm **orange**.



Fig. 17 Cut-away drawing of HepKey Plus™



Fig. 18 HepTool™

To use HepKey Plus™:

1. Place the **HepKey Plus™** around the pipe
2. Clip **HepKey Plus™** over the fitting
3. In this position it depresses the inner release ring of the fitting.
4. Withdraw the pipe from the fitting.



Step 1



Step 2



Step 3



Step 4

Fig. 19 Demounting sequence using **HepKey Plus™**



Fig. 20 Cut-away drawing of **HepKey™**

To use **HepKey™**:

1. Clip the **HepKey™** round the pipe next to the joint to be demounted, with the flat side of the **HepKey™** away from the fitting.
2. Slide the **HepKey™** up to the fitting and press so that the protruding 'lugs' depress the inner release ring of the fitting.
3. Withdraw the pipe from the fitting.

To use **HepTool™**:

1. Position the appropriate sized tool around the collar of the fitting.
2. Push down the release ring and pull out the pipe.

Note:

Before re-using the fitting we recommend applying a small amount of Jointing Lubricant Spray (code HX200) to the O-ring seal inside the fitting (see page 11).

Hints and tips for trouble-free Hep₂O installation

These are simple and effective precautionary steps which should be taken to avoid problems and ensure trouble free installation of Hep₂O.

Hep₂O pipe

The biggest potential problem is damage to a pipe end, in the form of a deep scratch which can create a leak pathway for water to pass. Taking a few precautionary measures can eradicate any such problems.

- Take care how and where the pipe is stored.
- Retain pipe in protective packaging until it is to be used.
- Never use an open bladed knife to remove the pipe packaging.
- In the case of coiled pipe, always use the shielded blade tool supplied (see Fig. 21) to slit the packaging around the inside of the coil. This enables the pipe to be drawn from the inside. The packaging then serves to contain the coiled pipe until the last metre (see Fig. 22).
- When threading pipe through holes in stone, brick or block walls always use a pipe sleeve or a small piece of foam pipe insulation to protect the pipe from the rough surface.
- Ensure exposed first fix pipe ends are protected from damage by using a temporary end protector. This also ensures no debris will enter the pipe (see Fig. 23).
- Avoid kinking the pipe during installation.



Fig. 21 Unwrapping coil



Fig. 23 Always protect pipe ends



Fig. 22 Packaging retains pipe until last metre

Hep₂O fittings

As the fitting cannot be taken apart few problems can arise but some basic precautions are advisable.

- Avoid dust and debris entering the fitting.
- Store materials in a secure place free from dust and dirt etc.
- Keep fittings in their bags until ready for use.
- When re-using a fitting, spray a little Hep₂O HX200 Jointing Lubricant onto the O-ring (see Fig. 9 on page 11).

Handling and storage

Hep₂O is an extremely tough and durable system. However, following the simple guidelines below will ensure its performance is not impaired by poor storage.

- Straight lengths of Hep₂O pipe should be stored flat or stacked vertically.
- Coils may be laid on their side or edge.
- Pipe and fittings, wherever possible, should be stored in their original packaging.
- All Hep₂O pipe and fittings should be protected from contact with petroleum and oil derivatives.
- Do not expose to UV light for prolonged periods
- Avoid dragging the pipe along the ground or on other surfaces such as walls.
- When feeding pipe through holes in walls and brickwork pipe ends should be taped over, or an end cap should be used. These precautions will protect the pipe end from damage and also prevent debris entering the pipe.
- Care should be taken to avoid kinking the pipe during installation.

Colour-coded packaging

To make buying, handling, storing and installing the Hep₂O system as simple as possible, a colour-coded system has been introduced.

Hep₂O fittings are now supplied in sealed polythene bags colour-coded by size, which makes them easy to keep clean and easier to identify – you can see all the 15mm fittings at a glance – just look for the blue packs.

Just to make it easier still, the same colour-coded packaging has also been applied to Hep₂O pipe.

- 10mm: **green**
- 15mm: **blue**
- 22mm: **purple**
- 28mm: **orange**

No more searching the van to find those elusive 22mm elbows, just look for the purple bag!



Fig. 24 Colour-coded packaging is designed to make product selection easier

Other Jointing Applications

Connecting Hep₂O pipe to compression fittings

Hep₂O pipe is suitable for connecting to compression fittings which comply with **BS EN 1254**.

Cut the Hep₂O pipe with the recommended cutters and proceed as follows:

1. Cut pipe and insert a Hep₂O **SmartSleeve**[™] pipe support sleeve into the pipe end.
2. Apply PTFE tape if required.
3. Fully insert the pipe into the fitting.
4. Tighten nut, taking care not to over-tighten.



Insert support sleeve into pipe



Apply PTFE tape if required



Ensure pipe is fully inserted



Tighten nut

Fig. 25 Procedure for connecting Hep₂O pipe to a compression fitting

Note:

- Do not use oil based jointing compounds
- Always use an appropriate **SmartSleeve**[™] pipe support sleeve
- Use copper olives in preference to brass
- Hep₂O pipe will not rotate in a compression fitting after tightening

Other Jointing Applications

Hep₂O connections adjacent to capillary joints

When using Hep₂O pipe or fittings adjacent to capillary joints, soldering work should be carried out before the Hep₂O is installed. If this is not possible, keep any heat away from Hep₂O and observe the following precautions:

- 1. Don't** allow Flux to run onto Hep₂O pipe or fittings. Flux runs inside the pipe may occur during soldering, this effect can be reduced by not using excessive amounts of Flux and by applying Flux to copper pipe end only.
- 2. Don't** allow hot solder to come into contact with Hep₂O.
- 3. Don't** allow Hep₂O to overheat. Wrap a damp cloth around copper pipe to minimise any likely heat transfer or use a heat absorbing gel.

Note:

Systems should be flushed with water to remove any internal Flux residues.

Connection to chrome plated or stainless steel pipe

Hep₂O fittings cannot be connected directly to chrome plated copper or stainless steel, because of the relative surface hardness of these materials. The recommended method is to use compression fitting (*see page 21*).

Connection to brass spigots

The only brass spigots suitable for jointing into Hep₂O fittings are those included within the Hep₂O range. Brass spigots designed for compression or capillary joints do not have the necessary joint grooves and are too short.

Connection to earlier Hep₂O systems

Hep₂O is fully compatible with all current and earlier versions of Hep₂O fittings, including its immediate predecessor and the earlier Acorn[®] system manufactured by Bartol.

Other Jointing Applications

Connecting Hep₂O fittings to other brands of pipe

Hep₂O fittings should not be used in conjunction with other manufacturers' plastic pipe and fittings, as dimensional tolerances and quality control cannot be guaranteed by Wavin.

Connecting Hep₂O to steel pipes and threaded bosses

In order to facilitate connection to male and female iron threads, four adaptors (*HX28/HX29 socket adaptors*) and (*HX31/HX30 spigot adaptors*) are available in the Hep₂O range. This enables connection to a wide range of different materials.

Installers are recommended to take note of the advice given in the foreword of EN 10226-2. Taking account of the variations which may be present in the mating threads, Wavin recommends the use of PTFE thread tape to ensure a reliable seal.



HX28 Socket adaptor



HX29 Socket adaptor



HX30 Spigot adaptor



HX31 Spigot adaptor

Fig. 26 Hep₂O adaptors

Other Jointing Applications

Connections to appliances using Hep₂O

When connecting to appliances and dishwashers always use Hep₂O appliance valves from the Hep₂O range (HX38/15). Adjacent Hep₂O pipework should be clipped in accordance with the recommended clipping distances using screw-type clips (HX85) (see pipe support - page 29).



HX38/15 Appliance Valve

Fig. 27 Valves for connecting appliances

System alterations

Using a Blanking peg to seal off a fitting

When you need to provide a temporary or permanent seal to one of the ports on a Hep₂O fitting, insert a blanking plug (HX44) directly into the open connection. You can use **In4Sure™** joint recognition technology to check the plug is fully inserted. To remove the plug use a **HepKey™** or **HepKey Plus™** and continue with the installation.



Fig. 28 Blanking peg shown on its own, and inserted into fitting

Using a stop end to seal off a pipe

When you need to close off the open end of a pipe, first fit a **SmartSleeve™** support sleeve in to the open pipe end then fit a stop end (HD62) onto the pipe to provide a temporary or permanent seal.



Just push to release -
no tools needed

Fig. 29 15mm stop end

Other Jointing Applications

Where it's OK to use Hep₂O

Hep₂O is suitable for most domestic and commercial hot/cold water and heating applications. A comprehensive range of fittings meets all today's requirements and provides secure connection and reliable operation. Providing installation work has been carried out using good plumbing practice as outlined in this guide, all Hep₂O pipe and fittings are guaranteed for 50 years under normal use.



Fig. 30 New Hep₂O is now more compatible with modern sanitary ware

Where it's not OK to use Hep₂O

The Hep₂O system has been designed and tested to meet the requirements of modern heating and water distribution systems.

Testing has not been carried out to determine suitability for other purposes and therefore Hep₂O should not be used in the following applications:

- Conveyance of gas
- Conveyance of fuel oil
- In areas contaminated by petroleum and oil derivatives
- Conveyance of compressed air
- Hep₂O is not suitable for use in systems where the water carried in the pipe contains a high concentration of chlorine e.g. swimming pools or decorative water features
- Hep₂O will not be affected by those levels of chlorine expected in the UK water supply (*typically less than 0.5ppm*). Short term chlorination for disinfection will not have an adverse effect on the system (*see page 51*).
- Hep₂O should not be used for the primary circuit of a Solar Heating System as temperature cannot be thermostatically controlled. Hep₂O is suitable for secondary circulation of these systems.
- Hep₂O should be protected at all times from exposure to direct sunlight and ultra violet light.
- **Hep₂O should not be installed in Continuously operated re-circulating systems (Secondary Hot Water Circulation / Ring main installations). Please see Important Information section on page 51 for more details.**

Cabling through joists

The Building Regulations Approved Document A allows for pipework to be installed in joists by either notching or drilling. The traditional method has been to notch the joists as the rigidity of the pipe does not easily allow for any other method of installation. However this has a number of disadvantages:

- Pipework must be installed prior to the floorboards being laid.
- Plumber has to work on open joists increasing risk of accident.
- Need to return after floors are laid to connect radiators, etc.
- Tails often moved by other tradesmen, causing extra work to reposition pipework correctly for radiators.



Fig. 31 *Hep₂O speeds up installations because pipework can be easily cabled through drilled joists*

The exceptional flexibility of Hep₂O pipe removes most of these restrictions by allowing pipe to be easily curved and 'cabled' through drilled joists, or I-beams which means:

- Flooring can be laid prior to the plumber carcassing from below which will progress the building schedule as other trades can work on the floor above e.g. to form studwork etc.
- Site safety enhanced as the plumber is not exposed to the danger of falling or the discomfort of kneeling on open joists.
- Other trades working below are protected from the dangers of falling tools, molten solder, gas bottles etc.
- Carcassing at a later stage in the construction programme means the building is likely to be weatherproof.
- Less danger of puncturing the pipe with nails used for fixing the floorboards and no need to use protective devices such as 'joist clips'.

It is worth noting that drilled holes in joists should be large enough to allow for thermal movement of the pipe.

Less risk to health and greater site safety

The unique Hep₂O system ensures:

- Effective, leak-free pipe jointing without the use of a naked flame.
- No soldering means safety from fire, especially in restricted spaces.
- Improved working environment.
- No Flux or Solder eliminates potential contamination of water supplies.

Hep₂O push-fit jointing also has the following advantages:

- No naked flame means that precautions such as obtaining a 'Hot Work' permit, having a fire extinguisher readily available, and remaining on site for a while after jointing, are not necessary.
- No risk of infringement of Health and Safety recommendations applicable to some brands of Flux. e.g. means to control exposure to noxious fumes when working in a confined space, and use of eye protection (*where appropriate*).
- After jointing, the fitting is clean and safe to touch, e.g. after soldering, the joint is hot and Flux traces need to be removed.
- Joint is rotatable after installation.

Other system benefits include:

- Longer pipe runs and less joints, due to pipe flexibility.
- Elimination of 'dry runs' as pipe can be cut and jointed in situ.
- Absence of solvents means testing can be carried out as soon as installation is complete.
- Tails for connection to sanitary ware can be left long enough for final connection, thus eliminating the need for straight and offset connectors as with rigid pipe systems.
- Natural flexibility of the pipe helps overcome small misalignments.

Drilling the floor joists

- Hole diameters should be no greater than 0.25 of the depth of the joist and should be drilled at the neutral axis.
- They should be not less than 3 diameters (*centre to centre*) apart and should be located between 0.25 and 0.4 times the span from the support.

Note:

The Building Regulations Approved Document A gives exact instructions on the drilling of floor joists.

Sitework

These points are illustrated (see Fig. 32).

The value 0.25 is obviously one quarter and can easily be calculated on site. The value 0.4 is less obvious and can be obtained (see Fig. 33).

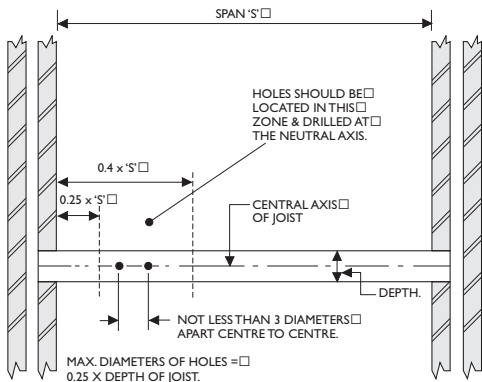

Fig. 32 Explanation of drilling joists in accordance with the Building Regulations Approved Document A

Note:

The minimum distance between a hole and a notch in the same joist should not be less than 100mm.

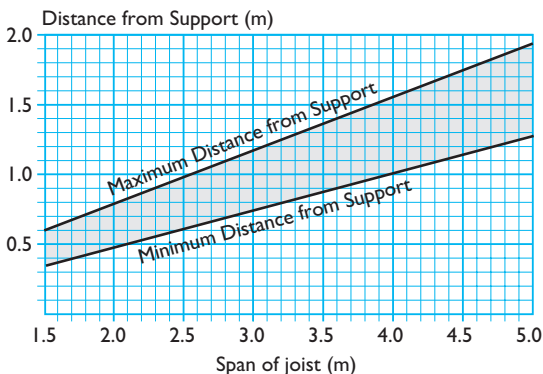

Fig. 33 Graph showing dimension of joist drilling zone from support

Note:

This graph should be used in conjunction with Fig. 32. Example of use: Joist span is 4.5m. Find value on horizontal scale and read up to sloping line. Transfer point of intersection to the vertical scale and read 1.8m.

Engineered joists

Hep₂O is ideal in buildings incorporating timber 'I' joists. Piping can be properly installed through holes in the web section without damaging flange members (eg. *TJI Joist system, Truss Joist MacMillan Ltd.*) even where the pre-formed holes do not align on the plan.

Spigot tees and manifolds

The Hep₂O system incorporates a comprehensive range of spigot tees which can be used individually or in groups to give manifold arrangements with the benefit of 360° rotation. Alternatively, the system includes a selection of manifolds from single to four ports (see page 47).

Connecting pumps, valves etc:

Where Hep₂O is connected to pumps, valves and similar devices consideration should be given to adequately supporting the item in question (*bearing in mind the rotatability of the Hep₂O joint*). Equipment should not be suspended from the pipe without adequate support.

Pipe support

The Hep₂O system includes two types of pipe clip - the screw fix type (HX85) and the nail type (HX65).



Nail

Code	Nominal Diameter
HX65/10	10
HX65/15	15
HX65/22	22
HX65/28	28



Screw

Code	Nominal Diameter
HX85/15	15
HX85/22	22
HX85/28	28



Spacer

Code	Nominal Diameter
HX86/15	15
HX86/22	22

Note:
The HX86/22 spacer can be used with both the HX85/22 and HX85/28 clip.

Fig. 34 Pipe clips

Sitework

The nail type is designed for use on concealed pipework for rapid fixing to timber. The screw type may be used together with a spacer (HX86) to allow greater spacing between the pipe and the fixing background. The spacer therefore allows different pipe fixing centres which can be used to facilitate pipe cross-overs or fitting of thermal insulation to the pipe.

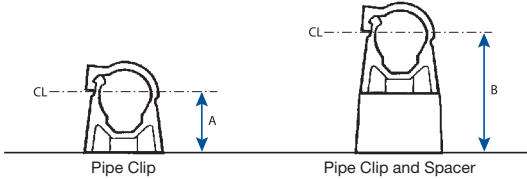

Note:
Fixing hole size is 5mm diameter.

Nominal Diameter mm	Dimension A mm	Dimension B mm
15	17	40
22	21	43
28	24	46

Fig. 35 Pipe fixing centres

A cold forming bend fixture (HX75) is also available to allow the formation of a bend on 15mm and 22mm pipes for situations where secure fixing and neatness are important.

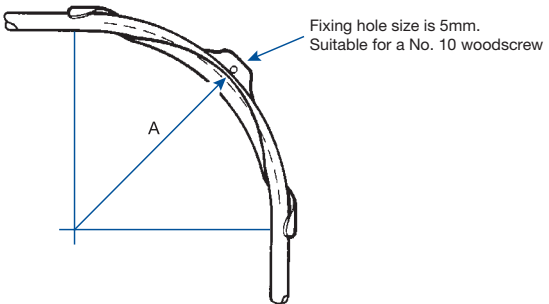

Nominal Diameter mm	Radius A mm
15	120
22	176

Fig. 36 Cold forming bend fixture radii

Cable ties

When pipe is concealed, cable ties may be used for support instead of clips. However these should not be over-tightened. The pipe should be allowed to slide freely to allow for thermal movement.

Pipe support distances

We recommend the use of pipe clips both to support the pipe and give a neat finish. The recommended support distances for general purpose use are shown in Table No. 3.

Where piping is adequately supported (*e.g. through suspended timber floors*) clips can be reduced or omitted provided that:

- Pipe does not form part of an open vent provided for safe operation of a heat source.
- Pipe does not form a distribution pipe or circuit where effective air venting might be impaired by poor pipe alignment.
- Hot pipe will not come into contact with cold pipe or vice versa.
- There is no risk that pipes or fittings will come in contact with sharp, abrasive or other potentially damaging surfaces.
- There is no risk pipe will come in contact with materials which may be affected by transmitted heat.

Where pipe is visible, a support distance between fixings of 300mm is suggested.

Where provision has been made for electrical wiring, such as in some partition systems, this can often be utilised for Hep₂O pipework.

Table No. 3 Recommended clipping distances

Nominal Diameter mm	Horizontal Runs m	Vertical Runs m
10	0.3	0.5
15	0.3	0.5
22	0.5	0.8
28	0.8	1.0

Minimum bending radius for Hep₂O pipe

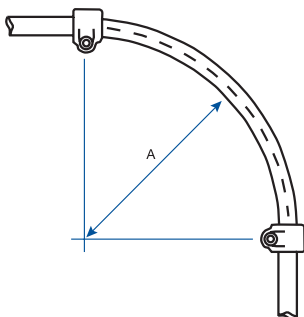

Nominal Diameter	mm	10	15	16	20	22	28
A	mm	80	120	128	160	176	224

Fig. 37 Minimum bending radii (8x pipe diameter)

Fig. 34 shows a cold formed bend fixture (HX75). This is suitable for use with 15mm or 22mm where secure fixing and neatness are important.

Hep₂O pipe can easily be manipulated by hand to form bends of any angle. In order to prevent any long term detrimental effect on the material, the curvature of Hep₂O pipe should be not less than that shown. A bending radius of 8x the pipe diameter is the minimum allowed.

Pipework installation

Hep₂O fittings are now much sleeker and more stylish than previously, making them a lot more acceptable for exposed locations.

However, Hep₂O pipe expands as temperature increases, causing it to undulate along its length and this effect is sometimes exacerbated where it is 'cabled' through joists. This will not create airlocks or have any other adverse effect on the operation of the plumbed system.

Concealed locations

Hep₂O pipe is relatively easy to install in concealed locations in floors, roof spaces etc. Any expansion in the pipe will have little mechanical effect, this being absorbed within the pipe length so undulation can be ignored.

Installation in difficult locations is aided by the cabling ability of Hep₂O pipe. If adequately supported, Hep₂O pipe in concealed locations need only be clipped for system alignment e.g. at changes in direction. If preferred, cable ties can be used in such areas.

Use of metal tape to aid 'electronic' pipe detection

The NHBC Standards includes a section which affects the installation of pipework in walls. It states:

'Where pipework is in or behind wall surfaces, and would otherwise not be detected by a metal detector or similar equipment, a metallic tape should be applied to the pipework'.

The NHBC has agreed that other methods of installing tape are also acceptable, as any tape applied to plastic pipe or fittings will require testing to ensure compatibility with the pipe and ensure the adhesive will not pass through the pipe and taint the water.

Note:

Metallic tape with an adhesive backing should NOT be applied directly to Hep₂O pipe and fittings, but the following methods of aiding detection are allowed:

Metallic tape without adhesive can be lightly crimped around the pipe to allow detection by an electronic pipe detector or, adhesive metallic tape can be stuck to the backing wall as close as possible to the pipe run.



Fig. 38 *Metallic tape can be used to aid electronic pipe detection*

Note:

Self adhesive information labels should not be applied directly to Hep₂O pipes and fittings, they must be placed on suitable surfaces adjacent to the pipe run.

Pipes through walls and floors

Wherever Hep₂O pipe passes through brickwork, stone or concrete it should be sleeved. The annular gap between the pipe and the sleeve should be filled with a resilient material to provide an effective fire stop and also prevent the transmission of noise from one room to another.

Expanding foam, in its initial wet state, must not come into contact with the Hep₂O pipe as it can cause an adverse chemical reaction whilst drying. The use of a pipe sleeve will provide the necessary protection.

Laying pipe in floor screeds

Unlike metal pipes, Hep₂O is not affected by the corrosive effects of cement, lime, mortar or concrete. However, account should be taken of the Water Byelaws which requires distribution pipework to be accessible to facilitate its removal and replacement (*see page 35 Hep₂O Conduit system*).

Pipes adjacent to metalwork

When running Hep₂O adjacent to or 'through' metalwork, it is important to ensure that the pipe doesn't come into contact with any sharp edges as any subsequent thermal movement could cause damage.

The following cautionary measures should be observed:

- Where pipe passes through a small drilled hole, fit a suitable grommet
- Where pipe passes through a large hole in metalwork or adjacent to a sharp edge, fix an extruded flexible profile to the metalwork
- Provide adequate pipe clips or cable ties to prevent abrasive contact between pipe and metalwork
- Run the pipe within a conduit

Hep₂O pipe means quieter operation because there's less noise...

Problems with noise are often found in systems which incorporate rigid pipes. Hep₂O pipe does not transmit noise and with careful installation, can be installed to run almost silently.

...from friction

Noise can be caused by friction between a pipe and adjacent surfaces – typically where rigid pipes are installed beneath timber or chipboard flooring.

Hep₂O can greatly reduce this effect. Where holes are drilled through joists they should be of sufficient diameter to allow Hep₂O pipe to slide freely (*see page 26*). This will prevent any

friction between the underside of a floor, and more importantly, it will avoid the 'ticking' and creaking normally associated with the thermal movement of rigid pipes

...from knocking

Noise can be caused by rigid pipes knocking together or knocking on adjacent surfaces. Hep₂O's inherent elasticity cushions such impact, causing less impact noise and absorbing vibration, thus preventing the transmission of sound along the pipe.

...and from 'water hammer'

Similarly noise from 'water hammer' resulting from abrupt stoppage of water flow (*typically by closure of quarter turn valves, solenoids and reverberating ball valves*). Such noise is normally absorbed by Hep₂O and is not transmitted along the pipes.

Installing pipes in concrete floors or walls

Hep₂O Conduit system

The Hep₂O Conduit system allows pipe and fittings to be installed directly into concrete floors or into walls whilst complying with the requirements of the Water Regulations.

The flexible conduit allows Hep₂O pipe to be easily withdrawn for inspection, and junction boxes allow maximum accessibility to fittings for inspection and possible removal.

If any bent sections of conduit pipe are formed in an installation then future replacement of the Hep₂O is likely to require the use of a 'draw cable'. This requires a cable to be attached to one end of the Hep₂O pipe before it is pulled out of the conduit from the other end. The draw cable remains in the conduit. Subsequent replacement of a new section of Hep₂O pipe may require two operatives; one pulling the draw cable which is attached to the pipe end, and the other person feeding-in the new length from the opposite end. Future replacement will be easier if conduit bends are kept to a minimum and any radius kept as large as practicable. See also 'Fitting the conduit', later in this section.

The system is available in all diameters, together with junction boxes with lids and terminal fittings.

Holes can be cut in the sides of the junction box at the appropriate position to accommodate the conduit which simply clicks into position.

Installation

The Hep₂O pipe should be fed into position at the same time as the conduit system is installed, i.e. before screeding. The conduit system should not be installed on sub-floors a long time in advance of screeding as damage by site traffic could occur. The junction box allows access to pipe fittings, and also allows pipe cross-overs (which are normally undesirable within the floor screed material). Dimensions are shown (see Fig. 41).

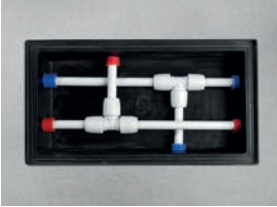

Fig. 39 Conduit junction box



Fig. 40 Cut conduit box for wall termination

The conduit pipe should be fixed to the sub-floor using suitable straps to prevent movement. Conduit pipes for cold water systems should not be run in floor screeds which incorporate underfloor heating loops. If required the junction box can be cut in half and installed up against a wall (see Fig. 40).

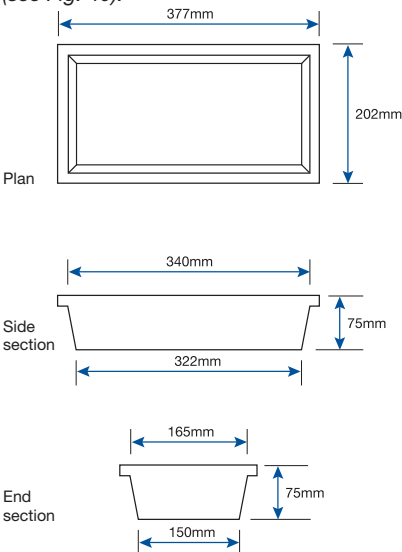

Fig. 41 Junction box dimensions

Installation continued

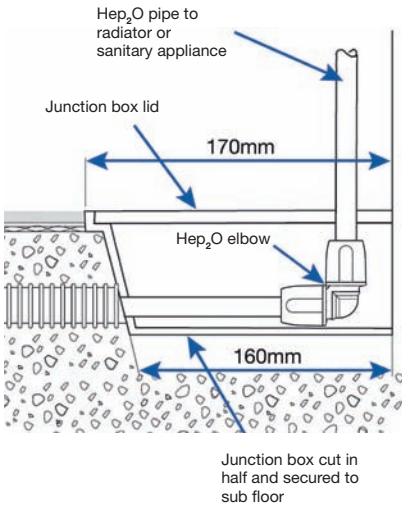

Fig. 42 Cut junction box

The junction box should be drilled using a hole cutter or spade bit, to allow the conduit to fit snugly and click into position.

It should protrude at least 5mm inside the box. Hole sizes and conduit OD's are shown in Table No. 4.

Table No. 4 Drill size for conduit box holes

Hep ₂ O Size (mm)	Conduit Code	Conduit OD (mm)
10 & 15	HXC25/15 - HXC50/15 - HXXC50/10 - HXXC50/15	25
22	HXC25/22 - HXC50/22 - HXXC50/22	34
28	HXXC25/28	42

Note:

Central heating pipework should not be run within the same junction box as cold water pipework unless there is space to fix adequate thermal insulation to prevent the warming of the cold water. The prevention of cold water becoming warm is a Water Regulations requirement.

Fitting a junction box

The junction box should be fixed to the sub-floor to prevent movement during screeding. Fixings with suitable washers should be used and the box should be positioned so that the lid (when fitted) will be level with the adjacent final floor finish. If the required screed depth exceeds that of the junction box, suitable packing should be placed under the base. However, if the junction box is to be installed into insulation, there is no effective method of holding the box down, so double sided adhesive tape should be used.

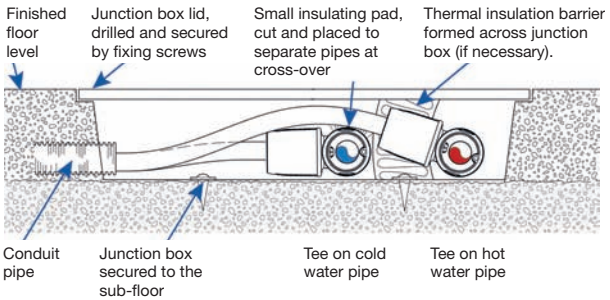

Fig. 43 Hot and cold water distribution pipes at tees

Note:

Thermal pipe insulation is not necessary when the junction box is used solely for central heating pipes.

Fitting pipe into conduit

To facilitate the possible removal and replacement of Hep₂O, the conduit should be installed without joints and should ideally run in straight lines between junction boxes. Where bends are unavoidable, there should not be more than two changes of direction between adjacent junction boxes.

- Conduit carrying cold water pipes should not touch conduit carrying hot water or central heating pipes.
- When running conduit within floor screeds the recommended gap between hot and cold should not be less than 50mm in order to prevent the warming of cold water (see Fig. 44).
- The conduit system should not contain unused water pipes which remain connected to water systems. Redundant pipework will result in water stagnation which would pose a risk to health.

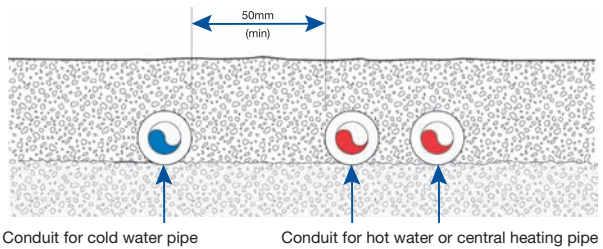

Fig. 44 Spacing for cold water conduit in floor screeds

Terminating the conduit

For terminating the conduit pipe at wall and floor finish level for direct 15mm connections to appliances, a conduit terminal fitting is available (HX101/15). For floor terminations the plastic housing may be drilled through the base to allow fixing. Floor termination procedure (see Fig. 47).



Fig. 45 HX101/15
15mm conduit terminal



Fig. 46 HX103 terminal
back plate



Fig. 47 HX101/15 conduit terminal installation procedure

Terminating the conduit continued



Fig. 48 HX101/15, 15mm conduit terminal and HX103 terminal back plate



Fig. 49 HX103, terminal back plate and HX6/15 wall plate elbow

For wall terminations the HX103 terminal back plate can be used to mount two terminals side by side (see Figs. 46 and 48) or it can be easily split to form two single plates. The same terminal back plate can also be used to fix a maximum of four wall plate elbows (see Fig. 49).

Installers are recommended to take note of the advice given in the foreword of EN 10226-2. Taking account of the variations which may be present in the mating threads, Wavin recommends the use of PTFE thread tape to ensure a reliable seal.

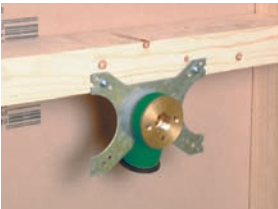

Fig. 50 Installation of HX102 terminal fitting plate and HX101/15, 15mm conduit terminal

Hep₂O Pipe-in-Pipe system

This consists of Hep₂O Barrier pipe (see page 9) pre-sheathed in conduit ready for underscreed installation.

This saves time and effort whilst complying with the current regulations. Hep₂O Pipe-in-Pipe is available in manageable coil lengths, and the conduit is available in red and blue to aid identification.



Fig. 51 Hep₂O Pipe-in-Pipe is supplied in coils with a choice of red or blue conduit

Dry lined wall feeds for radiators

There are distinct advantages to using 10mm Hep₂O pipe instead of microbore copper feeds to radiators. Hep₂O pipe can easily be accommodated behind 'dot and dab' plasterboard (see *Hep₂O within internal drywall system on page 48*) to give a pipe-free appearance within a room, but unlike copper, it is not susceptible to damage such as dents or kinks which can be caused on 'soft' copper by other follow-on trades.

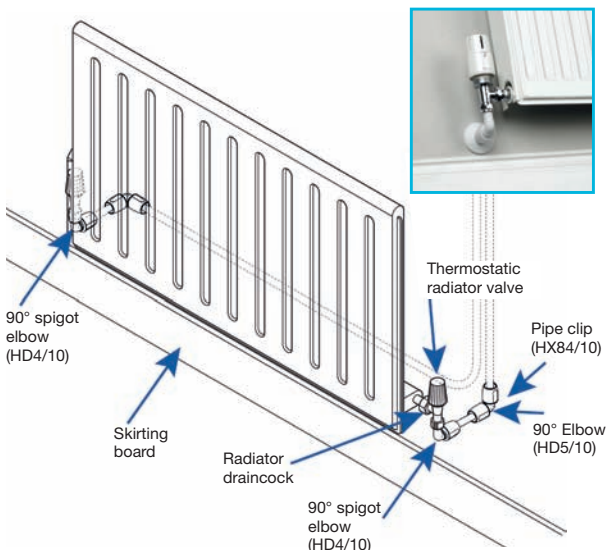

Fig. 52 Radiator pipework in 10mm Hep₂O within dry lined walls

Radiator outlet cover plate

A neat solution when using 10mm Hep₂O pipe, is to utilise the HX113 Hep₂O Radiator Outlet Cover Plate. This cover plate, fitted in conjunction with a back box provides an exceptionally neat and easy to install method of connecting radiators. It also has the benefit of a hinged flap that provides an airtight seal.

The box is fixed in a central position behind the radiator with the 10mm pipes dropping out to the radiator valves. This gives a smart professional finish where little or no pipe is seen and for new build provides an anchor point for the pipework prior to plastering/boarding (see *Fig. 53 on page 44*).



1. Position back box centrally behind radiator location with adequate pipe for left or right connection



2. Fit cover plate which provides an airtight seal when closed



3. Pipework can now be left until follow-on trades have finished working



4. The result leaves little or no pipe on show

Fig. 53 Installation procedure of HX113 cover plate

First-fix radiator feeds

The following is good practice for first-fix pipework:

- For conventional connections to radiators, the pipe drops should run vertically, side by side at one end of the radiator position.
- Where a radiator outlet cover plate is used, the radiator drops should run vertically, side by side, to the centre of the radiator position.
- Lateral pipes should be run horizontally through the stud work, avoiding any obvious fixing zones such as skirting boards.

Note: Where subsequent wall fixings are likely, metallic tape should be used to enable an electronic pipe detector to be used (see page 33).

For fixing pipework to lightweight blockwork, use wooden dowels at each clip position. The HX65 pipe clip is not suitable for fixing directly to such walls because of the low pull-out resistance of the nail.

Connecting Hep₂O pipe to storage vessels and radiators

Hep₂O pipe is compatible with most other makes of fittings, but when connecting it to cylinders, radiators etc. Hep₂O fittings should be used wherever possible. If an appropriate fitting is not available from the Hep₂O range, a recognised brand should be used.

The Hep₂O range includes double check valves, tank connectors, gate valves, stopcocks and cylinder connectors.

If the use of compression fittings is unavoidable then the jointing instructions outlined in the section, 'Connection Using Compression Fittings' (see page 21) should be carefully followed.

Also:

- **Do not** use any jointing compound on the jointing shoulder of the cylinder connector, use only PTFE tape.
- **Do not** use any jointing compound when fitting tank connectors, use only sealing washers.



Fig. 54 Hep₂O tank connector

Connecting Hep₂O to ancillaries (pumps, valves, etc.)

When connecting Hep₂O to ancillary items, it is important to follow the guidance in the section 'Connections Using Compression Fittings' (see page 21).

Hep₂O pipework must be clipped adjacent to the outlets of the pumps and valves using Hep₂O screw pipe clips (code HX85). This ensures adequate support and reduces vibration in the majority of cases. Where it is felt that the weight of the connected equipment merits extra support, metal brackets should be used. Where the size of the pump and/or valve requires fixing at a greater distance from the wall than can be accommodated by the pipe clip alone, this can be augmented with a pipe spacer (HX86). This will allow a greater 'stand-off' distance whilst maintaining security.

Connecting boilers and heaters

Where boilers incorporate a high limit cut out thermostat, pump overrun device and have connections outside the boiler casing 350mm from the heat source, direct connection can be made using Hep₂O. Typically these boilers contain a copper heat exchanger and are low water content boilers.

Where the above criteria for direct connection to a boiler cannot be met a minimum one metre run of copper pipe should be installed between the boiler and the start of the Hep₂O system.

Note:

Where individual boiler manufacturers instructions state differently, they should always be followed.

In all cases including instantaneous water heaters, caravan heaters etc. care must be taken to ensure that appliances have the appropriate thermostatic controls and cut outs to ensure that operating conditions do not exceed the temperature and pressure limits laid down for Class S pipe. (see Table No.1 - page 7).

For any type of back boiler, all the water connections should be extended from the appliance to the outside of the fireplace opening using copper pipe.

Any gravity circuit of a solid fuel boiler should always be installed in copper. Regulations require that metal pipe be used as the discharge pipe from temperature/pressure relief valves on unvented water heaters, to or from a tundish, or from safety valves on sealed central heating systems. On sealed systems where the safety valve is not provided within the boiler casing, the pipe between the safety valve and the boiler should be in copper. All boiler connections should be made in accordance with the requirements of **BS 5955**, part 8.

Note:

During commissioning it is important to ensure that all trapped air is purged from the heating system before the boiler is operated. 'Pockets' of air can effect proper circulation and impair the correct operation of boiler temperature controls, and this can cause severe overheating.

Manifolds

Hep₂O 10mm manifolds are particularly suited to microbore plumbing and are available in 2 and 4 port versions. They are designed primarily for use in central heating systems but can also be used for hot and cold water supplies. Hep₂O 15mm manifolds are available in 2 and 3 port versions.

A Hep₂O manifold is a single fitting which brings together multiples of 10mm or 15mm pipe, on the flow or return pipework, to one area of a building, enabling easy access.

A comprehensive range of Hep₂O manifolds is available, and these can be connected in series to allow any number of outlets. Alternatively, a range of 'spigot tee' fittings can be coupled together to give independent 360° joint rotation.



Fig. 55 Hep₂O manifolds are used to connect multiples of 10mm or 15mm pipe

Heating Systems

Installation and performance benefits

- Choice of 2, 3 or 4 port manifolds reduce the number of fittings required to connect 22mm pipe to 10mm or 15mm pipe.
- Manifolds reduce the number of fittings required and cut installation time.
- Manufactured from Polybutylene, an extremely robust yet lightweight material, they are easy to install.
- Lightweight Polybutylene manifolds enable pipe to be suspended between joists without fear of it being dragged down.
- Hep₂O blanking pegs can be used to close off any unused sockets.

Hep₂O within internal drywall systems

The Hep₂O system can easily be cabled within timber studwork and within wall systems (eg. *Paramount Board*) during construction. This method is often used for running feeds to radiators or where concealed plumbing is necessary, e.g. supplies to a recessed shower mixer.

A connection for a radiator can be made by using a secured elbow in the wall and fixing a plastic snap-on escutcheon to neatly cover the hole through the wall surface.

Alternatively for 10mm Hep₂O a dry lining box can be used which gives the advantage of allowing minor alignment adjustment to the 'tail' during 'second-fix' (see *Fig 56*) and allowing access to the elbow. 'First-fix' pipework should follow the good practice advice in the text headed 'Dry lined wall feeds to radiators' described above, and 'pipes adjacent to metalwork' (see *page 34*).

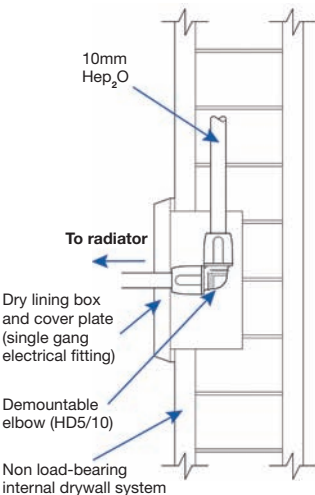

Fig. 56 Radiator connection using 10mm Hep₂O and a dry lining box within a drywall

Note:
This solution can also be used where the radiator is fed from below in which case the risers should be located directly under each box.

Hep₂O within timber framed and steel framed buildings

The Hep₂O system is ideal for use within both timber framed and steel framed buildings but consideration must be given to:

1. Early detection of leaks which could damage the building fabric if left unattended. Resultant repair delays would also contravene Water Bylaws.
2. Installation of the pipework which should be on the warm side of any thermal insulation layer. It must also be possible to replace any pipes which pass through vapour control layers without affecting the integrity of the layer.

To comply with the above, pipework should either be run within a recessed duct designed by the architect, or run within a conduit system. Whichever method is used it is necessary to consider the detail at the junction between the wall and floor to avoid floor joist problems and to agree pipe penetrations at header rails/bottom rails. For radiator connections, 10mm Hep₂O within conduit pipe may be used (see Fig. 57).

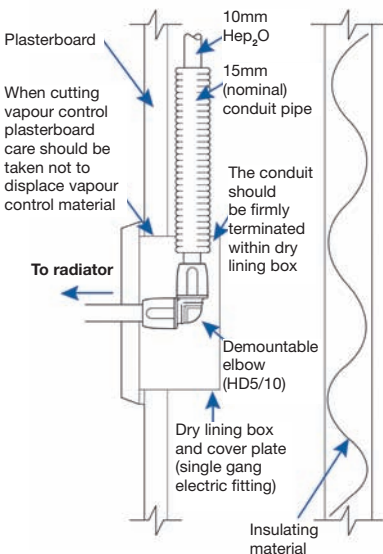

Fig. 57 Radiator connection using 10mm Hep₂O within timber or steel framed external wall

General advice

- For drilling holes through timber joists (see Figs. 32 and 33).
- Within steel framed buildings, pipework should be routed through preformed holes in steelwork wherever practicable. No holes should be formed in steelwork without the approval of the architect. See text headed 'Pipes adjacent to metalwork' (see page 34).
- **Do not** lay pipework in areas where plasterboard is likely to be fixed.
- Care should be taken to ensure pipework located within compartments or passing through party walls or floors does not impair the fire rating of the building.



Fig. 58 Installation is quicker and easier due to the flexibility of the Hep₂O system

Continuously operated re-circulating systems (Secondary Hot Water Circulation / Ring main installations)

A continuously operated re-circulating system is a water-replenished circulating system which is maintained at a constant high temperature to provide a constant source of hot water.

Continuously operated re-circulating systems are used to distribute constant hot water to draw off points that may be distant from the heat source or hot water storage vessel.

Continuously operated re-circulating systems are very different from conventional hot water supply and central heating systems found in domestic properties, for which our products have been tested to, under either BS 7291 2010 Class S or WRAS approval standards, and for this reason Hep₂O products must NOT be used on any continuously operated re-circulating systems as they are not approved under the current version of these standards.

Freezing for maintenance/system modification

Hep₂O pipe can be frozen for maintenance/repairs without damage to the system. When freezing equipment, manufacturers' instructions should be followed. Always freeze at a reasonable distance from where pipe is to be cut.

Painting Hep₂O

Hep₂O can be painted. In fact, painting is strongly advised for outdoor applications to protect the pipe from the effects of sunlight and ultra violet light. Painting with emulsion paint is preferred but oil based gloss paint can also be used in conjunction with undercoat. Before painting, ensure all surfaces are clean, free of grease and dry. Cellulose based paints, paint strippers or thinners must not be used.

Use of corrosion inhibitors

Corrosion of metals is a hazard in all installations therefore it is essential that possible causes of corrosion are kept to a minimum.

To provide maximum system protection, independent of pipe material, all heating circuits should be protected using an inhibitor. Fernox and Sentinel have been tested and are suitable for use with Hep₂O pipe and fittings.

Oxygen will almost always be present in any system as it can enter through a variety of points. Hep₂O Barrier pipe incorporates an additional oxygen barrier to reduce the ingress of oxygen through the pipe wall. It is accepted by

Important Information

British Gas and is suitable for use in heating systems which specify SuperWarm, GasWarm or are covered by British Gas Contract Service.

Antifreeze

Antifreezes based on Ethylene Glycol mixtures will not have any adverse effect on Hep₂O, however if there is any doubt, please contact our Technical Advisory Service –

Tel: 0844 856 5165.

Electrical safety

Hep₂O does not conduct electricity therefore there is no risk of electric shock, and the practice of utilising metal pipework system for earthing was discontinued in 1966.

However, if Hep₂O forms a break in the continuity of existing metal pipework which may have been used for earthing or bonding, the electrical continuity must be reinstated by fixing the bonding lead permanently to both ends of the existing metal pipework. For further information contact the Technical Advisory Service – **Tel: 0844 856 5165**, or for information on electrical safety and the IEE regulations, contact a registered electrical contractor or your local electricity provider.

Equipotential bonding

A Hep₂O installation requires no more and in many cases needs less equipotential bonding than metal pipework.

Woodworm / timber treatment

When treating timber for woodworm or rot, aqueous based solutions are generally accepted, and it is preferable to carry out any such spraying prior to Hep₂O being installed. Where this is not practical, care should be taken to protect and cover Hep₂O pipe and fittings prior to any spraying. Please note that solvent based treatments should not be used. For further information contact the Technical Advisory Service – **Tel: 0844 856 5165.**

Precautions

External installations

If Hep₂O is installed outdoors or in an unheated environment, it should be protected from frost in accordance with **BS 5422, BS 6700 and BS EN 806**, Water Bylaws and Building Regulations Approved Document L.

Hep₂O should be protected from the effects of ultraviolet radiation. If insulation has been installed to avoid freezing this provides adequate protection. Where insulation is not used, painting or covering is recommended.

Vermin

Testing has demonstrated that vermin do not show a preference for Hep₂O over other materials. However, all items which are softer than rodents' teeth are liable to be gnawed in vermin infested property. If vermin infestation is suspected, a reputable rodent exterminator should be consulted. If vermin are present they may damage Hep₂O pipework.

Chlorine

Hep₂O will not be affected by the levels of chlorine expected in the UK water supply (*typically less than 0.5ppm*), nor will short term chlorination for disinfection have an adverse effect on the system.

However, high sustained concentrations of chlorine will have an adverse effect on plastic pipe. Hep₂O is therefore not suitable for use in systems where the water contains a high concentration of chlorine e.g. swimming pools or decorative water features.

Pressure testing

When testing Hep₂O pipework systems, the recommended test is 1.5 times working pressure.

If the system contains ANY earlier version grab-ring or SlimLine fitting, a further test to a maximum of 18 bar should always be undertaken, but any non-Hep₂O appliances or fittings that will not withstand testing at 18 bar should be disconnected – check with other manufacturers instructions.

The duration of the test should be not less than 1 hour in accordance with **BS 6700** and **BS EN 806**.



Fig. 59 Pressure testing

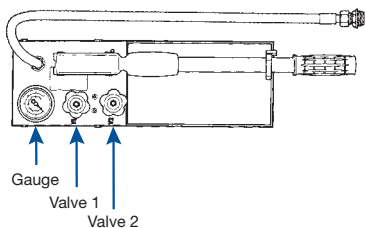

Fig. 60 Pressure testing kit (HX81)

Testing procedure

1. Disconnect any non-Hep₂O components that will not withstand the test pressure.
2. Blank off all open ends using Hep₂O blanking pegs 'System alterations' (see page 24).
3. Connect pressure hose to system at a convenient point using a Hep₂O socket.
4. Close valve V2 and open valve V1 (see Fig. 60).
5. Completely fill system to be tested with water and purge all air.
6. Raise pressure to test pressure and close valve V1 (see Fig. 60).
7. At end of test duration, tap gauge (to ensure pointer is 'free') and read pressure on gauge. If there is no appreciable drop in pressure, the system is watertight.
8. Release valve V1 and V2 to release pressure and drain system if necessary.

Note:

Pressure testing is NOT a substitute for making sure the pipe has been correctly inserted into the Hep₂O fittings. This should be achieved by following the correct jointing procedure and wherever possible, checking the joints using Hep₂O joint recognition technology as detailed (see page 15).

Special Application

Boats

Hep₂O is resistant to corrosion and light in weight. This makes it ideally suited to marine applications.

The flexibility of Hep₂O pipe means it can be cabled around the interior cavities of boats and easily hidden behind bulkheads. The mechanical flexibility of the Hep₂O system also allows it to absorb vibrations from the engine and forces of the sea which may cause soldered or compression joints to crack or work themselves loose. Hep₂O is impervious to electrolytic corrosion and performance is further assured through jointing technology which carries a 50 year guarantee.

Caravans

Hep₂O is ideal for caravans where its lightness and flexibility allows fitting in confined spaces without damage to the fabric of the vehicle, or adding unduly to the kerbside weight. Resistance to corrosion and freezing make Hep₂O an obvious choice for this application.

Exhibitions

Easy to install and dismantle, Hep₂O provides an ideal solution. The temporary nature of exhibitions combined with the requirement that services be run for considerable distances with multiple take-off points, requires a plumbing system which is flexible and capable of regular dismantling and re-installing to different layouts. A Hep₂O system answers all the requirements for flexibility and economy.

Portable buildings, site cabins, toilets etc.

The Hep₂O range includes all the necessary items to ensure compliance with local Water Bylaws (*e.g. double check valves*) whilst allowing the building to be moved to another location when required, with the minimum disruption to internal systems. Hep₂O is the ideal choice for these structures.

Agriculture and horticulture

Inherent durability and resistance to corrosion and cold weather make Hep₂O ideal for many applications in agricultural and horticultural environments. Typical applications include water supplies to milking parlours, drinking troughs and horticultural watering systems.

Fault Finding

In the unlikely event of a problem occurring, the following notes will help to identify the cause:

Typical Problems

1. Joint weeps

Probable causes:

- a. Deeply scored or scratched pipe.
Evidence: Visual inspection of pipe.
- b. Pipe has been inserted through grab-ring but not through O-ring.
Evidence: Joint leaks but pipe remains in fitting.
- c. Dust or burrs under O-ring seal (*usually occurs if a hacksaw has been used to cut the pipe*).
Evidence: Contamination evident on visual examination of components.
- d. O-ring seal has been damaged, usually by the insertion of a sharp ended copper pipe), or the pipe support sleeve has been omitted.
Evidence: Cause evident on visual examination of the component.
- e. Fitting may have been connected to old Imperial copper.
Evidence: Measurement of pipe will reveal discrepancy with current standard diameter (**BS 2871 Part: 1 1971**).

2. Split fittings

Probable cause:

Formation of ice within a system containing metal pipework, or adjacent to metal taps.

Evidence: Splitting of fitting or fitting pulled off pipe after severe cold spell.

Note:

Water freezes at 0°C and increases 9% in volume. Hep₂O pipe can absorb this volume increase without rupture, but if metal pipe or components are involved in the system, the extra pressure generated may occasionally be sufficient to split the fitting.

3. Pipe or fitting melting

Probable causes:

- a. Melting point of Polybutylene is approximately 125°C. Direct contact with any naked flame, electric fire, or hot flue pipe etc. would cause the pipe to melt.
- b. Water/steam within pipe reaches temperatures in excess of normal boiler safety and malfunction levels. This is very rare and if found should initiate a thorough investigation of both heating and electric systems. One cause has been found to be stray electric current passing through impurities in water.

Evidence: Visual examination shows material to be deformed. Surface of material may appear 'glossy'. If in any doubt please return the pipe and fitting to the Technical Advisory Department for further analysis.

Note:

If a fitting is being returned, care should be taken not to damage the sample which may hinder analysis.

As much of the affected installation should be returned as possible, but sufficient pipe should be left in fittings

to allow pressure testing (*minimum requirement 50mm*).

If possible a full metre of pipe should be returned complete with markings or a note made of all pipe markings.

The above notes cover some possible malfunctions generally resulting from incorrect installation or service conditions. By following the procedures and advice contained in this guide these problems will be avoided.

General Information

Advisory service

Wavin provides a comprehensive range of support services to ensure that any queries are dealt with swiftly and efficiently.

Hep₂O is a professional product and is distributed nationwide via a network of builders' and plumbers' merchants. It is not available through DIY or other retail outlets.

For details of your nearest Hep₂O stockist visit our website at www.hep2o.co.uk

Other sources of information

The Plumbing Engineering Services Design Guide published by: The Institute of Plumbing.

Building Regulations - Approved Documents A, G and L.





BS 5449: Code of Practice for Central Heating for Domestic Premises.

BS 5955: Part 8: Specification for the installation of thermoplastics pipes and associated fittings for use in domestic hot and cold water services and heating systems.

BS 6700 and BS EN 806: Design, Installation, Testing and Maintenance of services supplying water for domestic use within buildings and their curtilages.

This guide follows requirements stated in the standards, byelaws and regulations listed previously. Should it differ from any new UK or European requirements issued since we went to print, please obtain clarification by calling the appropriate enquiry hotline.

Polybutylene Pipe

	Description	Nom Dia mm	Cat No	Colour Ref	
	Straight Coiled Pipe Straight Coiled Lengths in SmartPack dispensers Please Note: Order pipe by unit (coil) not by metre		Standard		
	25m ♡	15	HXP25/15	W	
	50m ♡	15	HXP50/15	W	
	100m ♡	15	HXP100/15	W	
	25m ♡	22	HXP25/22	W	
	50m ♡	22	HXP50/22	W	
				Barrier	
		25m ♡	10	HXX25/10	W
		50m ♡	10	HXX50/10	W
		100m ♡	10	HXX100/10	W
25m ♡		15	HXX25/15	W	
50m ♡		15	HXX50/15	W	
100m ♡		15	HXX100/15	W	
25m ♡		22	HXX25/22	W	
50m ♡		22	HXX50/22	W	
25m ♡		28	HXX25/28	W	
50m ♡	28	HXX50/28	W		
	Pipe in Pipe System Coil of Hep ₂ O Barrier Pipe in Blue or Red Conduit Please Note: Order pipe by unit (coil) not by metre		Barrier		
	50m ♡	10	HXXC5010	Bu Rd	
	50m ♡	15	HXXC5015	Bu Rd	
	50m ♡	22	HXXC5022	Bu Rd	
	25m ♡	28	HXXC2528	Bu Rd	
	Cut Lengths 3.0m ♡ 3.0m ♡		Standard		
		15	HXP03/15	W	
		22	HXP03/22	W	
	3.0m ♡	15	HXX03/15	W	
	3.0m ♡	22	HXX03/22	W	
	3.0m ♡	28	HXX03/28	W	

Important Note:
 Order pipe by unit (length) not by metre. Cut lengths only available as pack quantities.









Demountable Fittings

	Description	Nom Dia mm	Cat No	Colour Ref
	SmartSleeve Pipe Support	10 15 22 28	HX60/10 HX60/15 HX60/22 HX60/28	
	Straight Connector ♥ ♥ ♥ ♥	10 15 22 28	HD1/10 HD1/15 HD1/22 HD1/28	W W W W
	Socket Reducer 15 x 10mm ♥ 22 x 15mm ♥ 28 x 22mm ♥	15 22 28	HD2/15 HD2/22 HD2/28	W W W
	Imperial Copper Adaptor 22mm - 3/4" ♥	22	HD3A/22	Gr
	Spigot Elbow 90° Single Socket ♥ ♥ ♥ ♥	10 15 15x10 22	HD4/10 HD4/15 HD4A/15 HD4/22	W W W W
	Elbow 90° ♥ ♥ ♥ ♥	10 15 22 28	HD5/10 HD5/15 HD5/22 HD5/28	W W W W
	Obtuse Bend 135° Single Socket ♥ ♥ ♥	10 15 22	HD8/10 HD8/15 HD8/22	W W W
	Equal Tee ♥ ♥ ♥ ♥	10 15 22 28	HD10/10 HD10/15 HD10/22 HD10/28	W W W W
	End Reduced Tee 22 x 15 x 22mm ♥ 28 x 22 x 28mm ♥	22 28	HD12/22 HD12/28	W W

Important Note:

All fittings are pre-lubricated - no additional lubrication required.
Hep₂O fittings are fully compatible with Hep₂O and copper pipe.

Demountable Fittings

	Description	Nom Dia mm	Cat No	Colour Ref
	Double End Reduced Tee 10 x 10 x 15mm ♡ 10 x 10 x 22mm ♡ 15 x 15 x 22mm ♡ 22 x 22 x 28mm ♡	15 22 22 28	HD18/15 HD18A/22 HD18/22 HD18/28	W W W W
	Branch Reduced Tee 15 x 15 x 10mm ♡ 22 x 22 x 10mm ♡ 22 x 22 x 15mm ♡ 28 x 28 x 15mm ♡ 28 x 28 x 22mm ♡	15 22 22 28 28	HD13/15 HD13A/22 HD13/22 HD13A/28 HD13/28	W W W W W
	Branch Reduced Tee – Spigot 15 x 15 x 10mm ♡ 22 x 22 x 15mm ♡	15 22	HD15/15 HD15/22	W W
	Branch and One End Reduced Tee 15 x 10 x 10mm ♡ 22 x 10 x 10mm ♡ 22 x 15 x 15mm ♡ 28 x 22 x 22mm ♡	15 22 22 28	HD14/15 HD14A/22 HD14/22 HD14/28	W W W W
	Tank Connector with BSP tail & backnut (For cold water use only) BSP 1/2" BSP 3/4"	15 22	HX20/15 HX20/22	W W
	Straight Tap Connector with brass nut and alternative rubber washer BSP 1/2" ♡ * BSP 3/4" ♡ * BSP 3/4" ♡ *	15 15 22	HD25A/15 HD25B/15 HD25B/22	W W W
	Bent Tap Connector with brass nut and alternative rubber washer BSP 1/2" ♡ *	15	HD27/15	W
	Tap Connector Spanner for use with HD25 & HD27 Tap Connectors BSP 1/2" BSP 3/4"	15 15	HX54 HX54A	Y Bu

* For intermittent hot and cold water use up to a maximum of 65°C
 Not for use with Central Heating

Demountable Fittings

	Description	Nom Dia mm	Cat No	Colour Ref
	Hand-Titan™ Tap Connector with rubber washer BSP 1/2" ♡ * BSP 1/2" ♡ * BSP 3/4" ♡ * BSP 3/4" ♡ *	10 15 15 22	HD26A/10 HD26A/15 HD26B/15 HD26B/22	W W W W
	Demountable Stop-End ♡ ♡ ♡ ♡	10 15 22 28	HD62/10 HD62/15 HD62/22 HD62/28	W W W W
	Blanking Peg For Demountable Hep ₂ O Fittings ♡ ♡ ♡ ♡	10 15 22 28	HX44/10 HX44/15 HX44/22 HX44/28	W W W W
	HepKey Plus Demounting Tool	10 15 22 28	HX79/10 HX79/15 HX79/22 HX79/28	
	HepKey Demounting Tool	10 15 22 28	HX78/10 HX78/15 HX78/22 HX78/28	
	HepTool Demounting Tool 10/28mm 15/22mm	10 15	HX77/10 HX77/15	

* For intermittent hot and cold water use up to a maximum of 65°C
 Not for use with Central Heating

Flexible Tap Connectors

	Description	Nom Dia mm	Cat No	Hose Type
	Hep2O x BSP Nut with brass nut & rubber washer 150mm BSP 1/2" *	15	HD425A/15	Braided
	300mm BSP 1/2" *	15	HD125A/15	Braided
	300mm BSP 3/4" *	15	HD125B/15	Braided
	300mm BSP 3/4" (full bore) *	22	HD125C/22	Braided
	300mm BSP 3/4" *	22	HD125B/22	Braided
	500mm BSP 1/2" *	15	HD225A/15	Braided
	500mm BSP 3/4" *	15	HD225B/15	Braided
	500mm BSP 3/4" (full bore) *	22	HD225C/22	Braided
	500mm BSP 3/4" *	22	HD225B/22	Braided
	1000mm BSP 1/2" *	15	HD325A/15	Braided
	1000mm BSP 3/4" *	22	HD325B/22	Braided
		Hep2O x BSP Nut with brass nut & rubber washer 300mm BSP 1/2" *	15	HDW125A/15
300mm BSP 3/4" *		15	HDW125B/15	White
300mm BSP 3/4" *		22	HDW125B/22	White
500mm BSP 1/2" *		15	HDW225A/15	White
500mm BSP 3/4" *		15	HDW225B/15	White
500mm BSP 3/4" *		22	HDW225B/22	White
	Hep2O x Hep2O 300mm 15mm x 15mm *	15	HD125H/15	Braided
	300mm 22mm x 22mm *	22	HD125H/22	Braided
	500mm 15mm x 15mm *	15	HD225H/15	Braided
	500mm 22mm x 22mm *	22	HD225H/22	Braided
	Hep2O x Hep2O 300mm 15mm x 15mm *	15	HDW125H/15	White
	300mm 22mm x 22mm *	22	HDW125H/22	White
	Hep2O x Elbow BSP Nut with brass nut & rubber washer 300mm Elbow BSP 1/2" *	15	HD125D/15	Braided
	300mm Elbow BSP 1/2" *	15	HDW125D/15	White







* For intermittent hot and cold water use up to a maximum of 65°C
 Not for use with Central Heating

Flexible Tap Connectors

	Description	Nom Dia mm	Cat No	Hose Type
	Hep₂O Brass Service Valve x BSP Nut with brass nut & rubber washer 300mm BSP 1/2" * 300mm BSP 3/4" *	15	HD125E/15	Braided
		22	HD125E/22	Braided
	500mm BSP 1/2" *	15	HD225E/15	Braided
	500mm BSP 3/4" *	15	HD225I/15	Braided
	500mm BSP 3/4" *	22	HD225E/22	Braided
	Hep₂O Brass Service Valve x BSP Nut with brass nut & rubber washer 300mm BSP 1/2" * 300mm BSP 3/4" *	15	HDW125E/15	White
		22	HDW125E/22	White
	Hep₂O Brass Service Valve (Handle) x BSP Nut with brass nut & rubber washer 300mm BSP 1/2" * 300mm BSP 3/4" *	15	HD125EH/15	Braided
		22	HD125EH/22	Braided
	Hep₂O x Monobloc Mixers 300mm 15mm x M10 * 300mm 15mm x M12 *	15	HD125F/15 •	Braided
		15	HD125G/15 •	Braided

• Sold and priced as a pair

Auxiliary Fittings











	Description	Nom Dia mm	Cat No	Colour Ref
	Adaptor Male BSP/Hep ₂ O socket DZR Brass BSP 1/2" ♡ BSP 3/4" ♡ BSP 1" ♡	15 22 28	HX29/15 HX29/22 HX29/28	W W W
	Adaptor Female BSP/Hep ₂ O socket DZR Brass BSP 1/2" ♡ BSP 3/4" ♡ BSP 3/4" ♡ BSP 1" ♡	15 15 22 28	HX28/15 HX24/15 HX28/22 HX28/28	W W W W
	Adaptor Male BSP/Hep ₂ O spigot DZR Brass BSP 1/2" ♡ BSP 3/4" ♡ BSP 1" ♡	15 22 28	HX31/15 HX31/22 HX31/28	
	Adaptor Female BSP/Hep ₂ O spigot DZR Brass BSP 1/2" ♡ BSP 3/4" ♡ BSP 1" ♡	15 22 28	HX30/15 HX30/22 HX30/28	
	Draincock Brass 15mm spigot DZR Brass ♡	15	HX32/15	
	Adaptor Converts 1/2" tap connector to 3/8" DZR Brass BSP 1/2"x 3/8" ♡		HX39	
	Wall Plate Elbow Hep ₂ O BSP 1/2" ♡ BSP 3/4" ♡	15 22	HX6/15 HX6/22	BI BI
	Cylinder Connector DZR Brass BSP 1" (cone ended socket adaptor with nut) ♡	22	HX34/22	

Auxiliary Fittings



	Description	Nom Dia mm	Cat No	Colour Ref
	Ball Valve Plated Brass (for hot & cold water use) 15x15mm 22x22mm	15 22	HX22/15 HX22/22	
	Gate Valve – Hot/Cold DZR Brass Hep20 ends	15 22	HX35/15 HX35/22	
	Stopcock – Cold Water fitted with Hep20 ends	15 22	HX36/15 HX36/22	
	Stopcock – Cold Water Hep20 to MDPE Conversion 22mm to 25mm MDPE	22	HX43/22	
	Shut-off Valve With hot/cold indicator insert. NB: *SEE USAGE NOTE	15	HX37/15	W
	Appliance Valve With hot/cold indicator insert. NB: *SEE USAGE NOTE	15	HX38/15	W
	Straight Service Valve With hot/cold indicator insert. NB: *SEE USAGE NOTE	15	HX18/15	W
	Angled Service Valve With hot/cold indicator insert. NB: *SEE USAGE NOTE	15	HX19/15	W
	Double-Check Valve Plastics NB: *SEE USAGE NOTE	15	HX72/15	W

*For intermittent hot and cold water use up to a maximum of 65°C
Not for use with Central Heating

Auxiliary Fittings

	Description	Nom Dia mm	Cat No	Colour Ref
	Radiator Draincock	15	HX23/15	
	Two Port Manifold 22x15mm ports Closed Spigot ♡	22	HX88/22	W
	Two Port Manifold 22x15mm ports All socket ♡	22	HX88B/22	W
	Three Port Manifold 22x15mm ports Closed Spigot ♡	22	HX89/22	W
	Three Port Manifold 22x15mm ports All socket ♡	22	HX89B/22	W
	Two Port Manifold 22x10mm ports All socket ♡	22	HX92B/22	W
	Four Port Manifold 22x10mm ports All socket ♡	22	HX94B/22	W
	Two Port Manifold 22x10mm ports Socket and closed spigot ♡	22	HX92/22	W
	Four Port Manifold 22x10mm ports Socket and closed spigot ♡	22	HX94/22	W
	Four Port Manifold 22x10mm ports Socket and closed spigot, on one side ♡	22	HX96/22	W
	Four Port Manifold 22x10mm ports All socket, on one side ♡	22	HX96B/22	W

Auxiliary Fittings

	Description	Nom Dia mm	Cat No	Colour Ref
	One Port Valved Manifold Plated Brass 3/4" BSP Male/Female. 22mm Hep20 port ♡	22	HX91T/22	
	Two Port Valved Manifold Plated Brass 3/4" BSP Male/Female. 15mm Hep20 ports ♡	15	HX92T/15	
	Three Port Valved Manifold Plated Brass 3/4" BSP Male/Female. 15mm Hep20 ports ♡	15	HX93T/15	
	Four Port Valved Manifold Plated Brass 3/4" BSP Male/Female. 15mm Hep20 ports ♡	15	HX94T/15	
	Manifold End Caps 3/4" BSP Female End Cap 3/4" BSP Male End Cap		HX97 HX98	
	Manifold Bracket – Pair for HX92T/15, HX93T/15 & HX94T/15		HX95A	
	Radiator Outlet Back Box Plastic (for stud wall)		HX109	W
	Radiator Outlet Back Box Metal (for solid wall)		HX110	
	Radiator Outlet Cover with Flap For use with HX109 & HX110		HX113	W
	Back Box Grommet For use with HX110		HX112	BI

Ancillary Pipe and Fittings

	Description	Nom Dia mm	Cat No	Colour Ref
	Pipe Clips – Screw	15	HX85/15	W
		22	HX85/22	W
		28	HX85/28	W
	Pipe Clip – Spacers	15	HX86/15	W
		22	HX86/22	W
	Pipe Clip Cable Type	10	HX65/10	W
		15	HX65/15	W
		22	HX65/22	W
		28	HX65/28	W
	Flat Tap Connector Washers – Rubber	15	HX58/15	
		22	HX58/22	
	Conical Tap Connector Washers - Rubber	15	HX57/15	
		22	HX57/22	
	Hep ₂ O Silicone Lubricant Spray 400 ml Aerosol Can Hep ₂ O Fittings		HX200	
	Hep₂O Joint Test Kit		HX81	Rd
	Replacement Seals		HX81A	
	Product Display Stand Height 1840mm (1620mm + header 220mm) Depth 500mm Width 1000mm		HX2009	Bl

Pipe Ancillaries

	Description	Nom Dia mm	Cat No	Colour Ref
	Cold Forming Bend Fixture	15	HX75/15	
	Metal with passivate finish	16	HX75/16	
		22	HX75/22	
	Pipe Cutter – Scissor Type Standard		HD74	Rd
	Pro Cutter		HD75	Rd
	Pipe Cutter – Ratchet Type up to 42mm pipe up to 28mm pipe		HD77 HD78	Rd Rd

Product Selector

Conduit System

	Description	Nom Dia mm	Cat No	Colour Ref
	Conduit Pipe	15	HXC25/15	Bl
		15	HXC50/15	Bl
		22	HXC25/22	Bl
		22	HXC50/22	Bl
	Conduit Junction Box		HX100	Bl
		Conduit Junction Box Lid	HX104	Bl
	Conduit Terminal	15	HX101/15	Gn
	Terminal Back Plate		HX103	
	Routabout Spacer Ring Ring, 250mm, for 18mm board		HX404	Rd
	Ring, 250mm, for 22mm board		HX405	Rd

Heating Room Packs

	Description	Nom Dia mm	Cat No	Colour Ref
	UFH Packs Conservatory Pack	16	UH150	

Hotlines

Technical Advisory Service:

Tel 0844 856 5165

Literature Service:

Tel 01249 766333

Fax 01249 766332

Email:

info@hep2o.co.uk

Web Site:

www.hep2o.co.uk

Registered Office:

Wavin Limited, Hazlehead, Crow Edge, Sheffield S36 4HG

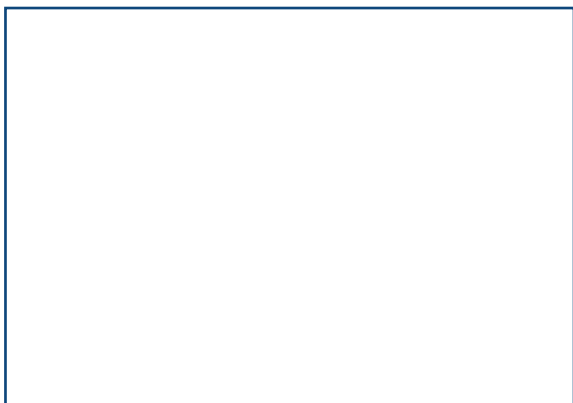

©Wavin 2012. Hep₂O is a registered trademark of Wavin. Wavin operates a programme of continuous improvement, and reserves the right to modify or amend the specification of products without notice. All information in this publication is believed correct at the time of going to press. However, no responsibility can be accepted for any errors or omissions.