

# SERVICE MANUAL R32

## <Outdoor unit>

### [Model Name]

PUZ-WM50VHA

PUZ-WM60VAA

PUZ-WM85VAA

PUZ-WM85YAA

PUZ-WM112VAA

PUZ-WM112YAA

### [Service Ref.]

**PUZ-WM50VHA.UK**
**PUZ-WM60VAA.UK**
**PUZ-WM85VAA.UK**
**PUZ-WM85YAA.UK**
**PUZ-WM112VAA.UK**
**PUZ-WM112YAA.UK**

## Salt proof model

PUZ-WM50VHA-BS

PUZ-WM60VAA-BS

PUZ-WM85VAA-BS

PUZ-WM85YAA-BS

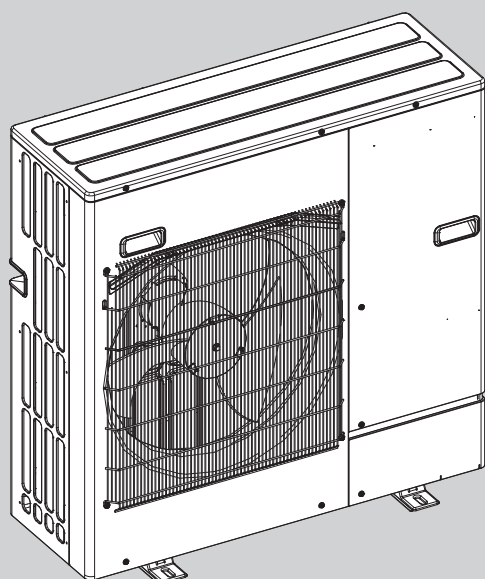
PUZ-WM112VAA-BS

PUZ-WM112YAA-BS

**PUZ-WM50VHA-BS.UK**
**PUZ-WM60VAA-BS.UK**
**PUZ-WM85VAA-BS.UK**
**PUZ-WM85YAA-BS.UK**
**PUZ-WM112VAA-BS.UK**
**PUZ-WM112YAA-BS.UK**

### Note:

- This manual describes service data of the outdoor units only.


**PUZ-WM50VHA.UK**

## CONTENTS

1. REFERENCE MANUAL.....	2
2. SAFETY PRECAUTION .....	3
3. SPECIFICATIONS .....	10
4. DATA .....	12
5. OUTLINES AND DIMENSIONS.....	13
6. WIRING DIAGRAM.....	15
7. WIRING SPECIFICATIONS .....	18
8. REFRIGERANT SYSTEM DIAGRAM .....	19
9. TROUBLESHOOTING .....	22
10. MONITORING THE OPERATION DATA BY THE REMOTE CONTROLLER .....	60
11. DISASSEMBLY PROCEDURE .....	66





PARTS CATALOG (OCB727)

## INDOOR UNIT SERVICE MANUAL

### 1-1. FOR AIR TO WATER SYSTEM

Model name	Service ref.	Service manual No.	
EHPT17X-VM2D	EHPT17X-VM2D.UK	OCH714 OCB714	
EHPT17X-VM6D	EHPT17X-VM6D.UK		
EHPT17X-YM9D	EHPT17X-YM9D.UK		
ERPT17X-VM2D	ERPT17X-VM2D.UK		
EHPT20X-MED	EHPT20X-MED.UK		
EHPT20X-VM6D	EHPT20X-VM6D.UK		
EHPT20X-YM9D	EHPT20X-YM9D.UK		
EHPT20X-YM9ED	EHPT20X-YM9ED.UK		
EHPT20X-TM9D	EHPT20X-TM9D.UK		
EHPT20X-MHEDW	EHPT20X-MHEDW.UK		
ERPT20X-MD	ERPT20X-MD.UK		
ERPT20X-VM2D	ERPT20X-VM2D.UK		
ERPT20X-VM6D	ERPT20X-VM6D.UK		
EHPT30X-MED	EHPT30X-MED.UK		
EHPT30X-YM9ED	EHPT30X-YM9ED.UK		
ERPT30X-VM2ED	ERPT30X-VM2ED.UK		
EHPX-VM2D	EHPX-VM2D.UK		OCH712 OCB712
EHPX-VM6D	EHPX-VM6D.UK		
EHPX-YM9D	EHPX-YM9D.UK		
EHPX-MED	EHPX-MED.UK		
EHPX-YM9ED	EHPX-YM9ED.UK		

## MEANINGS OF SYMBOLS DISPLAYED ON THE UNIT

	<b>WARNING</b> (Risk of fire)	This mark is for R32 refrigerant only. Refrigerant type is written on nameplate of heat pump unit. In case that refrigerant type is R32, this unit uses a flammable refrigerant. If refrigerant leaks and comes in contact with fire or heating part, it will create harmful gas and there is risk of fire.
		Read the OPERATION MANUAL carefully before operation.
		Service personnel are required to carefully read the OPERATION MANUAL and INSTALLATION MANUAL before operation.
		Further information is available in the OPERATION MANUAL, INSTALLATION MANUAL, and the like.

## 2-1. ALWAYS OBSERVE FOR SAFETY

**Before obtaining access to terminal, all supply circuits must be disconnected.**

## 2-2. CAUTIONS RELATED TO NEW REFRIGERANT

## Cautions for units utilizing refrigerant R32

**Preparations before the repair service**

- Prepare the proper tools.
- Prepare the proper protectors.
- Provide adequate ventilation.
- After stopping the operation of the air to water heat pump unit, turn off the power-supply breaker.
- Discharge the condenser before the work involving the electric parts.

**Use a vacuum pump with a reverse flow check valve.**

Vacuum pump oil may flow back into refrigerant cycle and that can cause deterioration of refrigerant oil, etc.

**Use the following tools specifically designed for use with R32 refrigerant.**

The following tools are necessary to use R32 refrigerant.

Tools for R32	
Gauge manifold	Flare tool
Charge hose	Size adjustment gauge
Gas leak detector	Vacuum pump adaptor
Torque wrench	Electronic refrigerant charging scale

**Do not use refrigerant other than R32.**

If other refrigerant (R22, etc.) is used, chlorine in refrigerant can cause deterioration of refrigerant oil, etc.

**Preparations during the repair service**

- Do not perform the work involving the electric parts with wet hands.
- Do not pour water into the electric parts.
- Do not touch the refrigerant.
- Do not touch the hot or cold areas in the refrigerating cycle.
- When the repair or the inspection of the circuit needs to be done without turning off the power, exercise great caution not to touch the live parts.

**Handle tools with care.**

If dirt, dust or moisture enters into refrigerant cycle, that can cause deterioration of refrigerant oil or malfunction of compressor.

**Use the specified refrigerant only.****Never use any refrigerant other than that specified.**

Doing so may cause a burst, an explosion, or fire when the unit is being used, serviced, or disposed of.

Correct refrigerant is specified in the manuals and on the spec labels provided with our products.

We will not be held responsible for mechanical failure, system malfunction, unit breakdown or accidents caused by failure to follow the instructions.

**Ventilate the room if refrigerant leaks during operation. If refrigerant comes into contact with a flame, poisonous gases will be released.**

## [1] Warning for service

- (1) Do not alter the unit.
- (2) For installation and relocation work, follow the instructions in the Installation Manual and use tools and pipe components specifically made for use with refrigerant specified in the outdoor unit installation manual.
- (3) Ask a dealer or an authorized technician to install, relocate and repair the unit.  
For appliances not accessible to the general public.
- (4) Refrigerant pipes connection shall be accessible for maintenance purposes.
- (5) If the heat pump unit is installed in a small room or closed room, measures must be taken to prevent the refrigerant concentration in the room from exceeding the safety limit in the event of refrigerant leakage. Should the refrigerant leak and cause the concentration limit to be exceeded, hazards due to lack of oxygen in the room may result.
- (6) Keep gas-burning appliances, electric heaters, and other fire sources (ignition sources) away from the location where installation, repair, and other work will be performed.  
If refrigerant comes into contact with a flame, poisonous gases will be released.
- (7) When installing or relocating, or servicing the heat pump unit, use only the specified refrigerant (R32) to charge the refrigerant lines.  
Do not mix it with any other refrigerant and do not allow air to remain in the lines.  
If air is mixed with the refrigerant, then it can be the cause of abnormal high pressure in the refrigerant line, and may result in an explosion and other hazards.
- (8) After installation has been completed, check for refrigerant leaks. If refrigerant leaks into the room and comes into contact with the flame of a heater or portable cooking range, poisonous gases will be released.
- (9) Do not use low temperature solder alloy in case of brazing the refrigerant pipes.
- (10) When performing brazing work, be sure to ventilate the room sufficiently or work outside. Make sure that there are no hazardous or flammable materials nearby.  
When performing the work in a closed room, small room, or similar location, make sure that there are no refrigerant leaks before performing the work.  
If refrigerant leaks and accumulates, it may ignite or poisonous gases may be released.
- (11) Do not install the unit in places where refrigerant may build-up or places with poor ventilation such as a semi-basement: Refrigerant is heavier than air, and inclined to fall away from the leak source.
- (12) The appliance shall be stored in a room without continuously operating ignition sources (for example: open flames, an operating gas appliance or an operating electric heater).
- (13) Do not pierce or burn.
- (14) Do not use means to accelerate the defrosting process or to clean, other than those recommended by the manufacturer.
- (15) Be aware that refrigerants may not contain an odour.
- (16) Pipe-work shall be protected from physical damage.
- (17) Compliance with national gas regulations shall be observed.
- (18) Keep any required ventilation openings clear of obstruction.
- (19) Servicing shall be performed only as recommended by the manufacturer.
- (20) The appliance shall be stored in a well-ventilated area where the room size corresponds to the room area as specified for operation.
- (21) Maintenance, service and repair operations shall be performed by authorized technician with required qualification.
- (22) Be sure to have appropriate ventilation in order to prevent ignition. Furthermore, be sure to carry out fire prevention measures that there are no dangerous or flammable objects in the surrounding area.

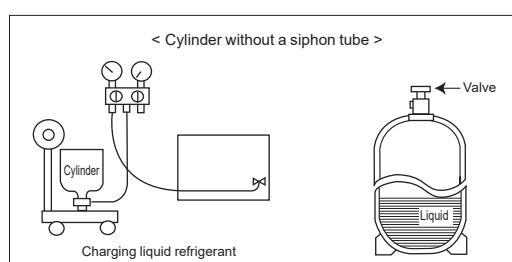
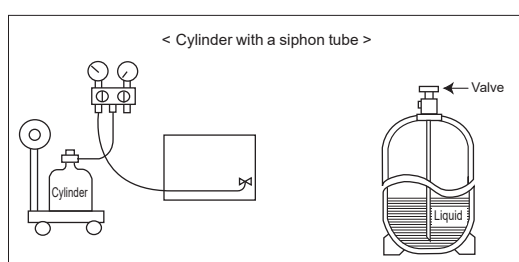
## [2] Cautions for service

- (1) Perform service after recovering the refrigerant left in unit completely.
- (2) Do not release refrigerant in the air.
- (3) After completing service, charge the cycle with specified amount of refrigerant.
- (4) When performing service, install a filter drier simultaneously.  
Be sure to use a filter drier for new refrigerant.

## [3] Refrigerant charge

### When charging directly from cylinder

R32 is a single refrigerant and its composition does not change. Therefore, both liquid charging and gas charging are possible. Liquid charging of refrigerant all at once from the low pressure side may cause the compressor malfunction. Accordingly, make sure that charging is gradual.



## [4] Cautions for unit using R32 refrigerant

### Pay careful attention to the following points.

#### (1) Information on servicing

##### (1-1) Checks on the Area

Prior to beginning work on systems containing flammable refrigerants, safety checks are necessary to ensure that the risk of ignition is minimized.

For repair to the refrigerating systems, (1-3) to (1-7) shall be completed prior to conducting work on the systems.

##### (1-2) Work Procedure

Work shall be undertaken under a controlled procedure so as to minimize the risk of a flammable gas or vapor being present while the work is being performed.

##### (1-3) General Work Area

All maintenance staff and others working in the local area shall be instructed on the nature of work being carried out.

Work in confined spaces shall be avoided. The area around the workspace shall be sectioned off. Ensure that the conditions within the area have been made safe by control of flammable material.

##### (1-4) Checking for Presence of Refrigerant

The area shall be checked with an appropriate refrigerant detector prior to and during work, to ensure the technician is aware of potentially toxic or flammable atmospheres. Ensure that the leak detection equipment being used is suitable for use with all applicable refrigerants, i.e. non-sparking, adequately sealed or intrinsically safe.

##### (1-5) Presence of Fire Extinguisher

If any hot work is to be conducted on the refrigeration equipment or any associated parts, appropriate fire extinguishing equipment shall be available to hand.

Have a dry powder or CO<sub>2</sub> fire extinguisher adjacent to the charging area.

##### (1-6) No Ignition Sources

No person carrying out work in relation to a refrigeration system which involves exposing any pipe work shall use any sources of ignition in such a manner that it may lead to the risk of fire or explosion. All possible ignition sources, including cigarette smoking, should be kept sufficiently far away from the site of installation, repairing, removing and disposal, during which refrigerant can possibly be released to the surrounding space. Prior to work taking place, the area around the equipment is to be surveyed to make sure that there are no flammable hazards or ignition risks. "No Smoking" signs shall be displayed.

##### (1-7) Ventilated Area

Ensure that the area is in the open or that it is adequately ventilated before breaking into the system or conducting any hot work. A degree of ventilation shall continue during the period that the work is carried out. The ventilation should safely disperse any released refrigerant and preferably expel it externally into the atmosphere.

##### (1-8) Checks on the Refrigeration Equipment

Where electrical components are being changed, they shall be fit for the purpose and to the correct specification. At all times the manufacturer's maintenance and service guidelines shall be followed. If in doubt, consult the manufacturer's technical department for assistance.

The following checks shall be applied to installations using flammable refrigerants:

- The charge size is in accordance with the room size within which the refrigerant containing parts are installed.
- The ventilation machinery and outlets are operating adequately and are not obstructed.
- Marking to the equipment continues to be visible and legible. Markings and signs that are illegible shall be corrected.
- Refrigeration pipe or components are installed in a position where they are unlikely to be exposed to any substance which may corrode refrigerant containing components, unless the components are constructed of materials which are inherently resistant to being corroded or are suitably protected against being corroded.

##### (1-9) Checks on Electrical Devices

Repair and maintenance to electrical components shall include initial safety checks and component inspection procedures. If a fault exists that could compromise safety, then no electrical supply shall be connected to the circuit until it is satisfactorily dealt with. If the fault cannot be corrected immediately but it is necessary to continue operation, an adequate temporary solution shall be used. This shall be reported to the owner of the equipment so all parties are advised. Initial safety checks shall include that:

- capacitors are discharged: this shall be done in a safe manner to avoid possibility of sparking;
- no live electrical components and wiring are exposed while charging, recovering or purging the system;
- there is continuity of earth bonding

#### (2) Repairs to Sealed Components

(2-1) During repairs to sealed components, all electrical supplies shall be disconnected from the equipment being worked upon prior to any removal of sealed covers, etc. If it is absolutely necessary to have an electrical supply to equipment during servicing, then a permanently operating form of leak detection shall be located at the most critical point to warn of a potentially hazardous situation.

(2-2) Particular attention shall be paid to the following to ensure that by working on electrical components, the casing is not altered in such a way that the level of protection is affected. This shall include damage to cables, excessive number of connections, terminals not made to original specification, damage to seals, incorrect fitting of glands, etc.

Ensure that the apparatus is mounted securely.

Ensure that seals or sealing materials have not degraded to the point that they no longer serve the purpose of preventing the ingress of flammable atmospheres.

Replacement parts shall be in accordance with the manufacturer's specifications.

(3) Repair to intrinsically Safe Components

Do not apply any permanent inductive or capacitance loads to the circuit without ensuring that this will not exceed the permissible voltage and current permitted for the equipment in use.

Intrinsically safe components are the only types that can be worked on while live in the presence of a flammable atmosphere. The test apparatus shall be at the correct rating.

Replace components only with parts specified by the manufacturer. Other parts may result in the ignition of refrigerant in the atmosphere from a leak.

(4) Cabling

Check that cabling will not be subject to wear, corrosion, excessive pressure, vibration, sharp edges or any other adverse environmental effects. The check shall also take into account the effects of aging or continual vibration from sources such as compressors or pumps.

(5) Detection of Flammable Refrigerants

Under no circumstances shall potential sources of ignition be used in the searching for or detection of refrigerant leaks.

A halide torch (or any other detector using a naked flame) shall not be used.

(6) Leak Detection Methods

Electronic leak detectors may be used to detect refrigerant leaks but, in the case of flammable refrigerants, the sensitivity may not be adequate, or may need re-calibration. (Detection equipment shall be calibrated in a refrigerant-free area.)

Ensure that the detector is not a potential source of ignition and is suitable for the refrigerant used. Leak detection equipment shall be set at a percentage of the LFL of the refrigerant and shall be calibrated to the refrigerant employed, and the appropriate percentage of gas (25% maximum) is confirmed.

Leak detection fluids are suitable for use with most refrigerants but the use of detergents containing chlorine shall be avoided as the chlorine may react with the refrigerant and corrode the copper pipe-work.

If a leak is suspected, all naked flames shall be removed/extinguished.

If a leakage of refrigerant is found which requires brazing, all of the refrigerant shall be recovered from the system, or isolated (by means of shut off valves) in a part of the system remote from the leak. For appliances containing flammable refrigerants, oxygen free nitrogen (OFN) shall then be purged through the system both before and during the brazing process.

(7) Removal and Evacuation

When breaking into the refrigerant circuit to make repairs – or for any other purpose conventional procedures shall be used. However, for flammable refrigerants it is important that best practice is followed since flammability is a consideration. The following procedure shall be adhered to:

- remove refrigerant
- purge the circuit with inert gas
- evacuate
- purge again with inert gas
- open the circuit by cutting or brazing.

The refrigerant charge shall be recovered into the correct recovery cylinders. For appliances containing flammable refrigerants, the system shall be “flushed” with OFN to render the unit safe. This process may need to be repeated several times.

Compressed air or oxygen shall not be used for purging refrigerant systems.

For appliances containing flammable refrigerants, flushing shall be achieved by breaking the vacuum in the system with OFN and continuing to fill until the working pressure is achieved, then venting to atmosphere, and finally pulling down to a vacuum. This process shall be repeated until no refrigerant is within the system. When the final OFN charge is used, the system shall be vented down to atmospheric pressure to enable work to take place. This operation is absolutely vital if brazing operations on the pipe-work are to take place.

Ensure that the outlet for the vacuum pump is not close to any ignition sources and that ventilation is available.

(8) Charging Procedures

In addition to conventional charging procedures, the following requirements shall be followed:

- Ensure that contamination of different refrigerants does not occur when using charging equipment. Hoses or lines shall be as short as possible to minimize the amount of refrigerant contained in them.
- Cylinders shall be kept upright.
- Ensure that the refrigeration system is earthed prior to charging the system with refrigerant.
- Label the system when charging is complete (if not already).
- Extreme care shall be taken not to overfill the refrigeration system.

Prior to recharging the system, it shall be pressure-tested with the appropriate purging gas. The system shall be leak-tested on completion of charging but prior to commissioning. A follow up leak test shall be carried out prior to leaving the site.

(9) Decommissioning

Before carrying out this procedure, it is essential that the technician is completely familiar with the equipment and all its detail. It is recommended good practice that all refrigerants are recovered safely. Prior to the task being carried out, an oil and refrigerant sample shall be taken in case analysis is required prior to re-use of reclaimed refrigerant. It is essential that electrical power is available before the task is commenced.

a) Become familiar with the equipment and its operation.

Continued to the next page

- b) Isolate system electrically.
- c) Before attempting the procedure, ensure that:
  - mechanical handling equipment is available, if required, for handling refrigerant cylinders;
  - all personal protective equipment is available and being used correctly;
  - the recovery process is supervised at all times by a competent person;
  - recovery equipment and cylinders conform to the appropriate standards.
- d) If a vacuum is not possible, make a manifold so that refrigerant can be removed from various parts of the system.
- e) Make sure that cylinder is situated on the scales before recovery takes place.
- f) Start the recovery machine and operate in accordance with manufacturer's instructions.
- g) Do not overfill cylinders. (No more than 80 % volume liquid charge).
- h) Do not exceed the maximum working pressure of the cylinder, even temporarily.
- i) When the cylinders have been filled correctly and the process completed, make sure that the cylinders and the equipment are removed from site promptly and all isolation valves on the equipment are closed off.
- j) Recovered refrigerant shall not be charged into another refrigeration system unless it has been cleaned and checked.

(10) Labelling

Equipment shall be labelled stating that it has been de-commissioned and emptied of refrigerant. The label shall be dated and signed. For appliances containing flammable refrigerants, ensure that there are labels on the equipment stating the equipment contains flammable refrigerant.

(11) Recovery

When removing refrigerant from a system, either for servicing or decommissioning, it is recommended good practice that all refrigerants are removed safely. When transferring refrigerant into cylinders, ensure that only appropriate refrigerant recovery cylinders are employed. Ensure that the correct number of cylinders for holding the total system charge are available. All cylinders to be used are designated for the recovered refrigerant and labelled for that refrigerant (i.e. special cylinders for the recovery of refrigerant). Cylinders shall be complete with pressure-relief valve and associated shut-off valves in good working order. Empty recovery cylinders are evacuated and, if possible, cooled before recovery occurs.

The recovery equipment shall be in good working order with a set of instructions concerning the equipment that is at hand and shall be suitable for the recovery of all appropriate refrigerants including, when applicable, flammable refrigerants. In addition, a set of calibrated weighing scales shall be available and in good working order. Hoses shall be complete with leak-free disconnect couplings and in good condition. Before using the recovery machine, check that it is in satisfactory working order, has been properly maintained and that any associated electrical components are sealed to prevent ignition in the event of a refrigerant release. Consult manufacturer if in doubt.

The recovered refrigerant shall be returned to the refrigerant supplier in the correct recovery cylinder, and the relevant waste transfer note arranged. Do not mix refrigerants in recovery units and especially not in cylinders. If compressors or compressor oils are to be removed, ensure that they have been evacuated to an acceptable level to make certain that flammable refrigerant does not remain within the lubricant. The evacuation process shall be carried out prior to returning the compressor to the suppliers. Only electric heating to the compressor body shall be employed to accelerate this process. When oil is drained from a system, it shall be carried out safely.

(12) Parts inspection

Parts	Check every	Possible failures
Pressure relief valve (3 bar) Temperature and pressure relief valve	1 year (turning the knob manually)	PRV would be fixed and expansion vessel would burst

## [5] Service tools

Use the below service tools as exclusive tools for R32 refrigerant.

No.	Tool name	Specifications
①	Gauge manifold	<ul style="list-style-type: none"> <li>· Only for R32</li> <li>· Use the existing fitting specifications. (UNF1/2)</li> <li>· Use high-tension side pressure of 5.3MPa·G or over.</li> </ul>
②	Charge hose	<ul style="list-style-type: none"> <li>· Only for R32</li> <li>· Use pressure performance of 5.09MPa·G or over.</li> </ul>
③	Electronic weighing scale	—
④	Gas leak detector	· Use the detector for R134a, R407C, R410a or R32.
⑤	Adaptor for reverse flow check	· Attach on vacuum pump.
⑥	Refrigerant charge base	—
⑦	Refrigerant cylinder	<ul style="list-style-type: none"> <li>· Only for R32</li> <li>· Cylinder with syphon</li> </ul>
⑧	Refrigerant recovery equipment	—

## 2-3. PRECAUTIONS WHEN REUSING EXISTING R22/R410a REFRIGERANT TOOLS

### Cautions for refrigerant piping work

Tools for R32 (The following table shows whether conventional tools can be used or not.)

Tools and materials	Use	R32 tools	Can R22 tools be used?	Can R407C tools be used?	Can R410a tools be used?
Gauge manifold	Air purge, refrigerant charge and operation check	Tool exclusive for R32	×	×	○
Charge hose		Tool exclusive for R32	×	×	○
Gas leak detector	Gas leak check	Tool for HFC refrigerant	×	○	○
Refrigerant recovery equipment	Refrigerant recovery	Tool exclusive for R32	×	×	○
Refrigerant cylinder	Refrigerant charge	Tool exclusive for R32	×	×	×
Safety charger	Prevent compressor malfunction when charging refrigerant by spraying liquid refrigerant	Tool exclusive for R32	×	×	○
Charge valve	Prevent gas from blowing out when detaching charge hose	Tool exclusive for R32	×	×	○
Vacuum pump	Vacuum drying and air purge	Tools for other refrigerants can be used if equipped with adapter for reverse flow check	△ (Usable if equipped with adapter for reverse flow)	△ (Usable if equipped with adapter for reverse flow)	△ (Usable if equipped with adapter for reverse flow)
Welder and nitrogen gas cylinder	Weld the pipes	Tools for other refrigerants can be used	○	○	○
Refrigerant charging scale	Refrigerant charge	Tools for other refrigerants can be used	○	○	○
Vacuum gauge or thermistor vacuum gauge and vacuum valve	Check the degree of vacuum. (Vacuum valve prevents back flow of oil and refrigerant to thermistor vacuum gauge)	Tools for other refrigerants can be used	○	○	○
Charging cylinder	Refrigerant charge	Tool exclusive for R32	×	—	×

× : Prepare a new tool. (Use the new tool as the tool exclusive for R32.)

△ : Tools for other refrigerants can be used under certain conditions.

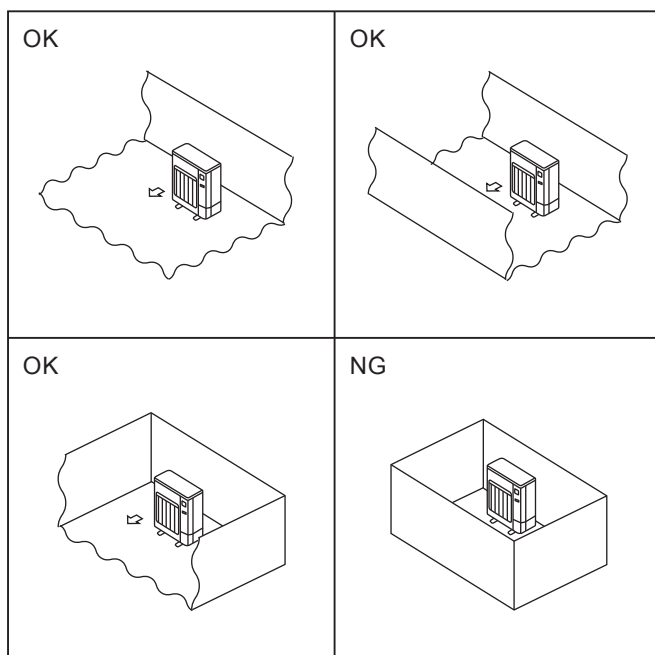
○ : Tools for other refrigerants can be used.

## 2-4. PRECAUTIONS FOR SALT PROOF TYPE "-BS" MODEL

Although "-BS" model has been designed to be resistant to salt damage, observe the following precautions to maintain the performance of the unit.

1. Avoid installing the unit in a location where it will be exposed directly to seawater or sea breeze.
2. If the cover panel may become covered with salt, be sure to install the unit in a location where the salt will be washed away by rainwater. (If a sunshade is installed, rainwater may not clean the panel.)
3. To ensure that water does not collect in the base of the outdoor unit, make sure that the base is level, not at angle. Water collecting in the base of the outdoor unit could cause rust.
4. If the unit is installed in a coastal area, clean the unit with water regularly to remove any salt build-up.
5. If the unit is damaged during installation or maintenance, be sure to repair it.
6. Be sure to check the condition of the unit regularly.
7. Be sure to install the unit in a location with good drainage.

## 2-5. Choosing the outdoor unit installation location



R32 is heavier than air—as well as other refrigerants—so tends to accumulate at the base (in the vicinity of the floor). If R32 accumulates around base, it may reach a flammable concentration in case room is small. To avoid ignition, maintaining a safe work environment is required by ensuring appropriate ventilation. If a refrigerant leak is confirmed in a room or an area where there is insufficient ventilation, refrain from using of flames until the work environment can be improved by ensuring appropriate ventilation.

Install outdoor units in a place where at least one of the four sides is open, and in a sufficiently large space without depressions.



## 2-6. Minimum installation area

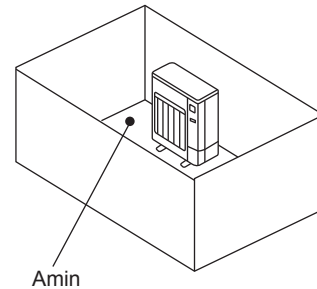
If you unavoidably install a unit in a space where all four sides are blocked or there are depressions, confirm that one of these situations (A, B or C) is satisfied.

Note: These countermeasures are for keeping safety not for specification guarantee.

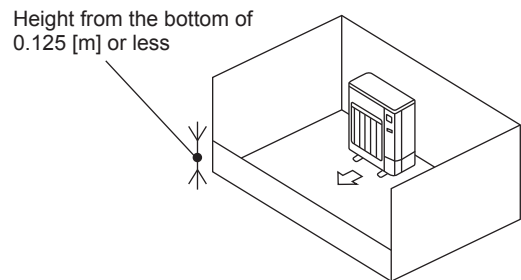
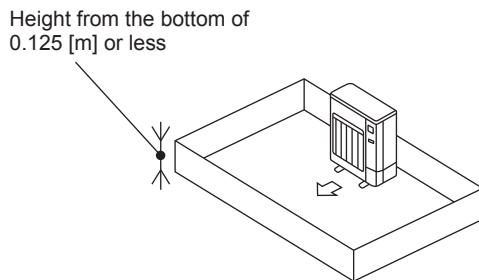
A) Secure sufficient installation space (minimum installation area  $A_{min}$ ).

Install in a space with an installation area of  $A_{min}$  or more, corresponding to refrigerant amount M (factory-charged refrigerant + locally added refrigerant).

M [kg]	$A_{min}$ [m <sup>2</sup> ]
1.0	12
1.5	17
2.0	23
2.5	28
3.0	34
3.5	39
4.0	45
4.5	50
5.0	56
5.5	62
6.0	67
6.5	73
7.0	78
7.5	84



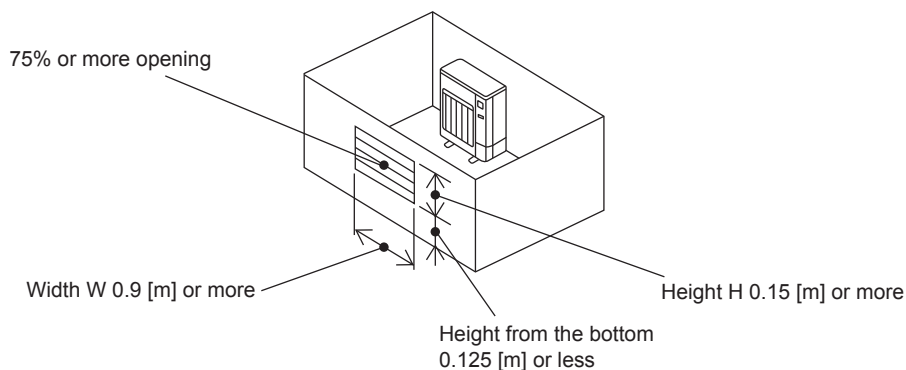
B) Install in a space with a depression height of  $\leq 0.125$  [m].



C) Create an appropriate ventilation open area.

Make sure that the width of the open area is 0.9 [m] or more and the height of the open area is 0.15 [m] or more. However, the height from the bottom of the installation space to the bottom edge of the open area should be 0.125 [m] or less.

Open area should be 75% or more opening.



# 3

# SPECIFICATIONS

## 3-1. SPECIFICATIONS

Service Ref.			PUZ-WM50VHA.UK PUZ-WM50VHA-BS.UK	PUZ-WM60VAA.UK PUZ-WM60VAA-BS.UK	PUZ-WM85VAA.UK PUZ-WM85VAA-BS.UK	PUZ-WM85YAA.UK PUZ-WM85YAA-BS.UK
OUTDOOR UNIT	Power source (Phase, cycle, voltage)		Single, 50 Hz, 230 V	Single, 50 Hz, 230 V	Single, 50 Hz, 230 V	3-Phase, 50 Hz, 400 V
	Max. current	A	13.0	13.0	22.0	11.5
	External finish		Munsell: N8.75 Munsell N2.75 (FRONT PANEL)			
	Refrigerant control		Linear Expansion Valve			
	Compressor		Hermetic twin rotary	Hermetic twin rotary		
	Model	Model	SVB130FBBMC-L3	SVB220FEGMC-L1	SVB220FEGMC-L1	SVB220FEAMC-L1
		Motor output	kW	0.9	1.5	
		Starter type	Inverter			
		Protection devices	HP switch, Comp. surface thermo Discharge thermo, Over current detection			
	Crankcase heater	W	—			
	Heat exchanger		Plate fin coil			
	Fan	Fan (drive) × No.		Propeller fan x 1		
		Fan motor output	kW	0.074		
		Airflow	m³/min (CFM)	36 (1270)	44 (1,550)	
	Defrost method		Reverse cycle *1	Reverse cycle *1		
	(PWL)Sound power level	Heating	dB	61	58	
	Dimensions	W	mm (inch)	950 (37-3/8)	1050 (41-5/16)	
		D	mm (inch)	330 +30*2 (13+1-3/16)	480 (18-7/8)	
H		mm (inch)	943 (37-1/8)	1020 (40-3/16)		
Weight	kg (lb)	71 (157)	97 (214)	98 (216)	111 (245)	
Refrigerant		R32				
Charge	kg (lb)	2.0 (4.4)	2.2 (4.9)			
	Oil (Model)	L	0.60 (FW68S)	0.60 (FW68S)		
Water pipe connection		G1B (WATER)				

\*1 Hot gas with 4-way valve \*2 Grill

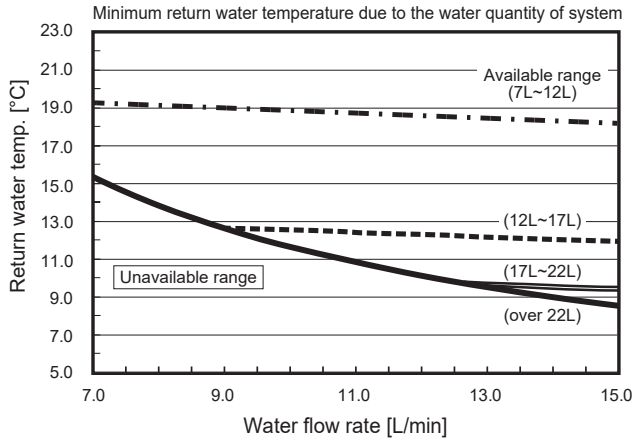
Service Ref.			PUZ-WM112VAA.UK PUZ-WM112VAA-BS.UK	PUZ-WM112YAA.UK PUZ-WM112YAA-BS.UK	
OUTDOOR UNIT	Power source (Phase, cycle, voltage)		Single, 50 Hz, 230 V	3-Phase, 50 Hz, 400 V	
	Max. current	A	28.0	13.0	
	External finish		Munsell: N8.75 Munsell N2.75 (FRONT PANEL)		
	Refrigerant control		Linear Expansion Valve		
	Compressor		Hermetic scroll		
	Model	Model	DVB28FBAMT	DVB28FBBMT	
		Motor output	kW	2.2	
		Starter type	Inverter		
		Protection devices	HP switch, Comp. surface thermo Discharge thermo, Over current detection		
	Crankcase heater	W	—		
	Heat exchanger		Plate fin coil		
	Fan	Fan (drive) × No.		Propeller fan x 1	
		Fan motor output	kW	0.2	
		Airflow	m³/min (CFM)	50 (1,760)	
	Defrost method		Reverse cycle		
	(PWL)Sound power level	Heating	dB	60	
	Dimensions	W	mm (inch)	1050 (41-5/16)	
		D	mm (inch)	480 (18-7/8)	
H		mm (inch)	1020 (40-3/16)		
Weight	kg (lb)	119 (262)	132 (291)		
Refrigerant		R32			
Charge	kg (lb)	3.0 (6.6)			
	Oil (Model)	L	0.9 (FW68S)		
Water pipe connection		G1 B (WATER)			

### 3-2. AVAILABLE RANGE (WATER FLOW RATE, RETURN WATER TEMP.)

Note: If the value of water flow rate and return water temp. become lower than the available range, it could cause damage to the parts of unit.

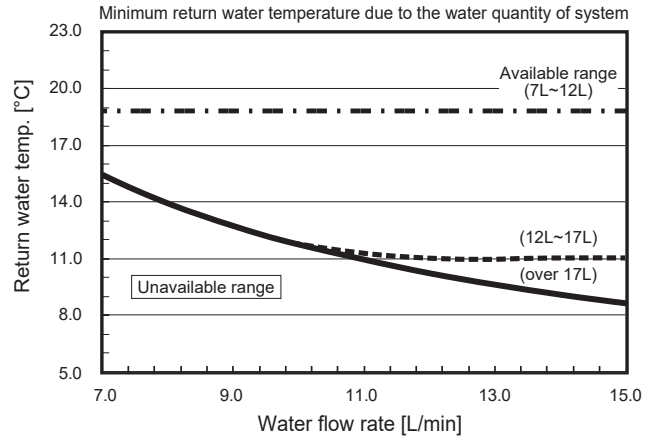
#### ■ Heating

PUZ-WM50VHA(-BS)

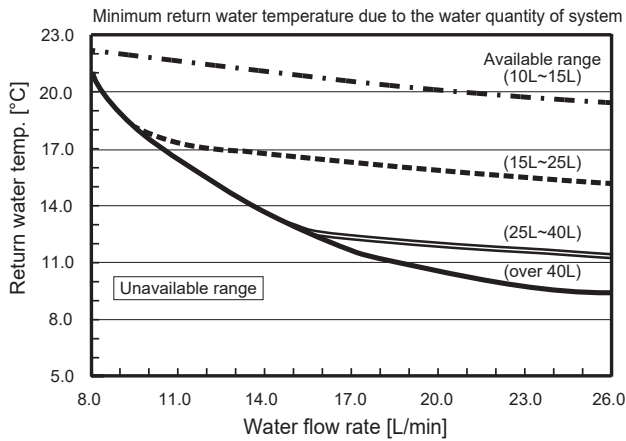


#### ■ Cooling

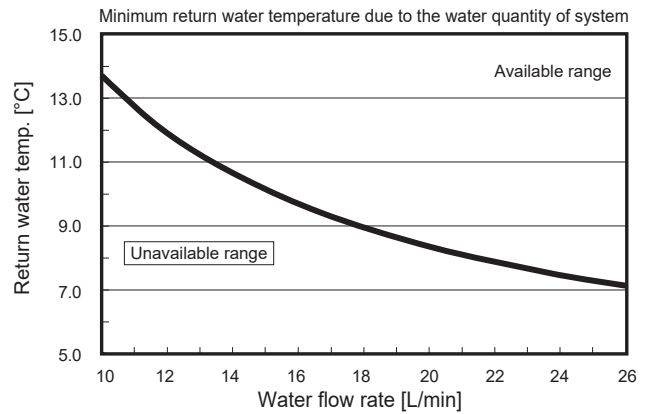
PUZ-WM50VHA(-BS)



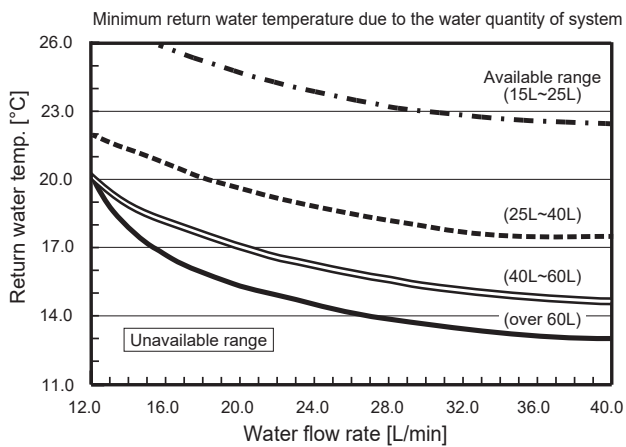
PUZ-WM60VAA(-BS) PUZ-WM85VAA(-BS) PUZ-WM85YAA(-BS)



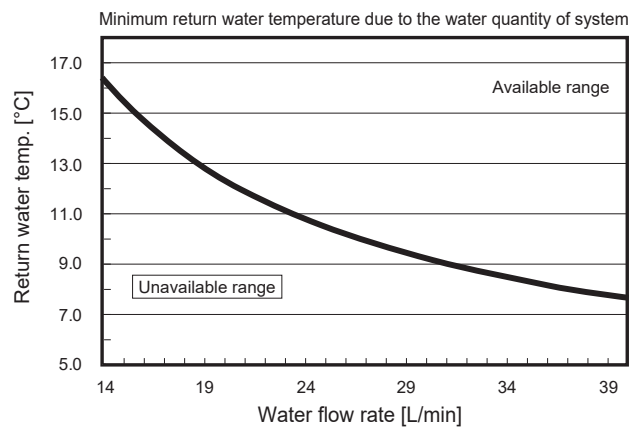
PUZ-WM60VAA(-BS) PUZ-WM85VAA(-BS) PUZ-WM85YAA(-BS)



PUZ-WM112VAA(-BS) PUZ-WM112YAA(-BS)



PUZ-WM112VAA(-BS) PUZ-WM112YAA(-BS)



#### Note:

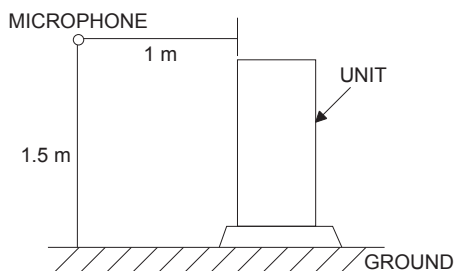
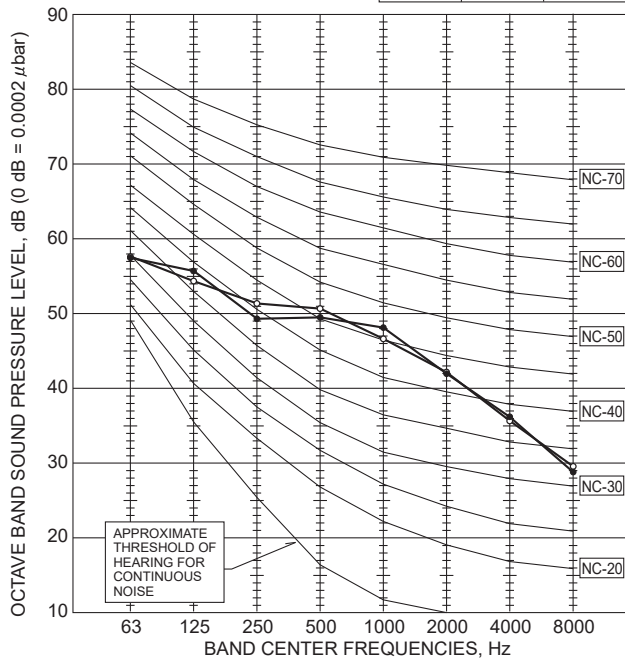
Be sure to avoid the unavailable range during defrosting.

Otherwise, the outdoor unit is insufficiently defrosted and/or the heat exchanger of the indoor unit may freeze.

NOISE CRITERION CURVES

PUZ-WM50VHA.UK  
PUZ-WM50VHA-BS.UK

MODE	SPL(dB)	LINE
COOLING	52	○—○
HEATING	52	●—●



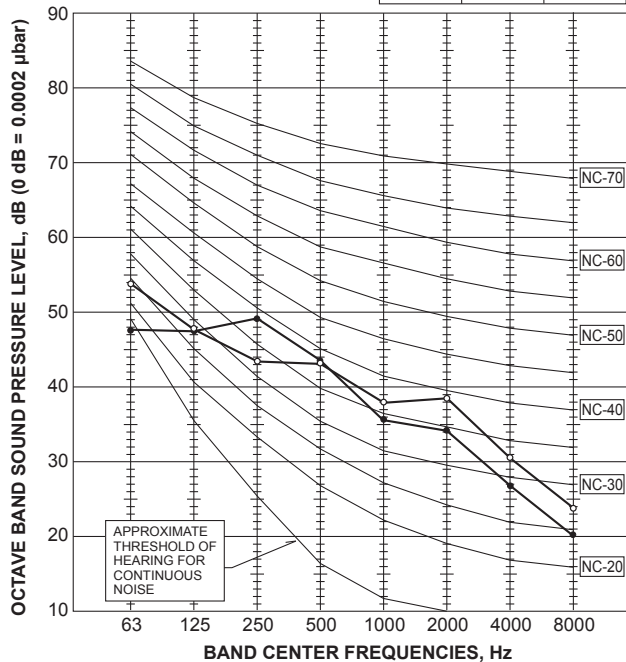
PUZ-WM60VAA.UK  
PUZ-WM85VAA.UK  
PUZ-WM85YAA.UK

PUZ-WM60VAA-BS.UK  
PUZ-WM85VAA-BS.UK  
PUZ-WM85YAA-BS.UK

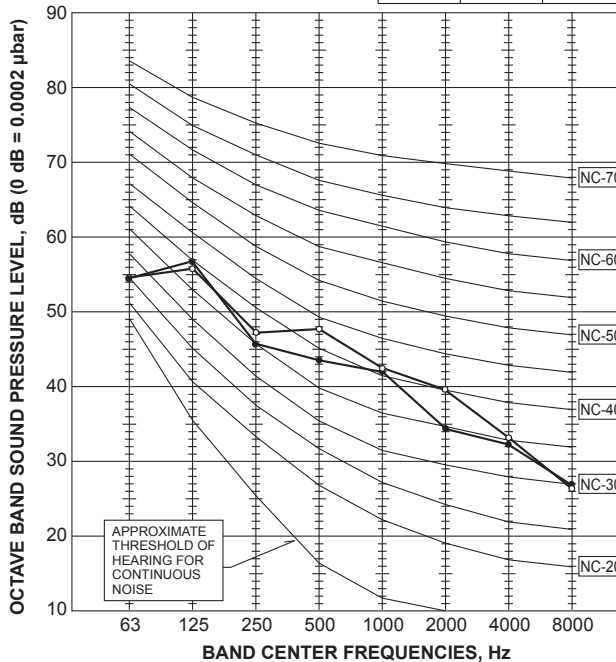
PUZ-WM112VAA.UK  
PUZ-WM112YAA.UK

PUZ-WM112VAA-BS.UK  
PUZ-WM112YAA-BS.UK

MODE	SPL(dB)	LINE
COOLING	45	○—○
HEATING	45	●—●



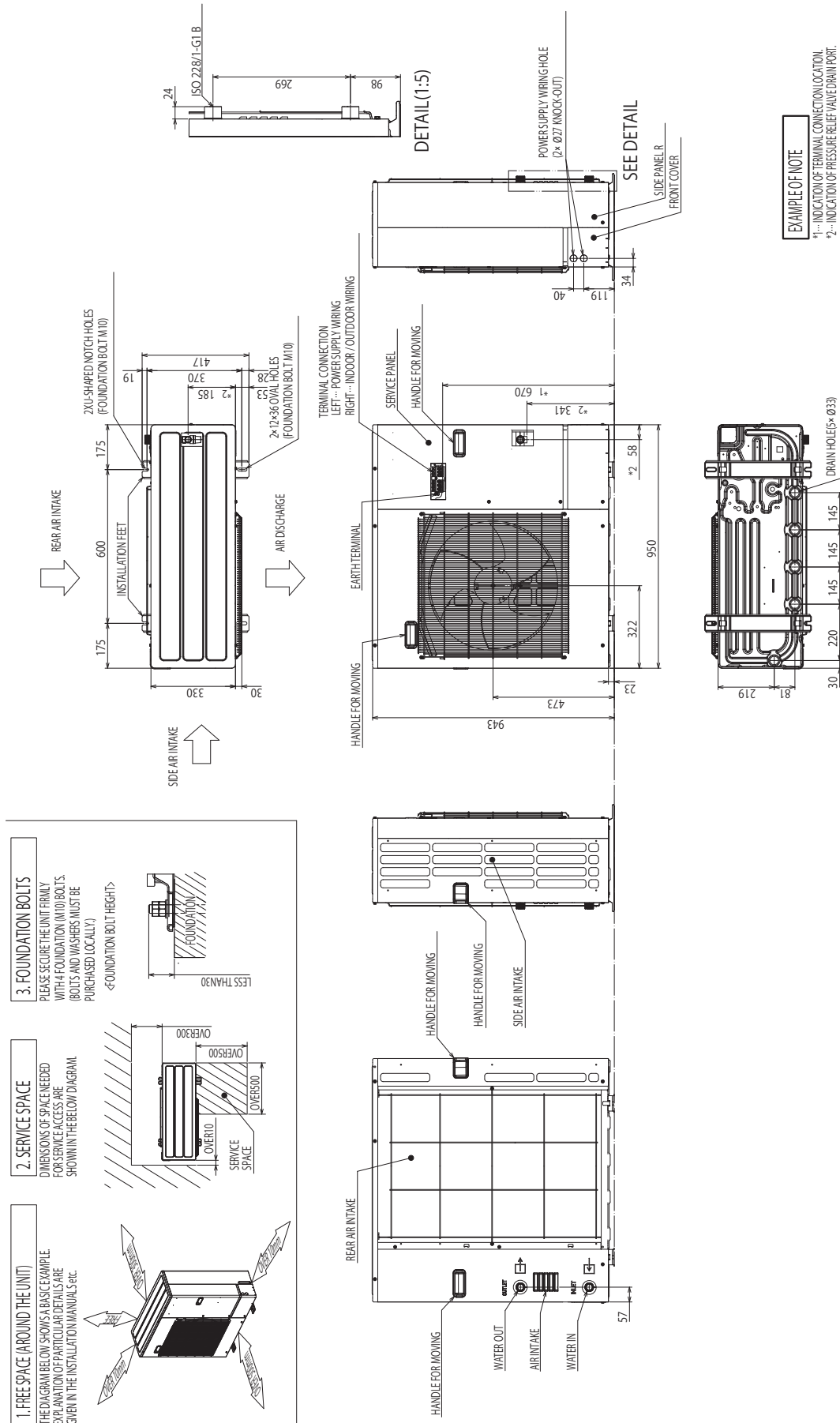
MODE	SPL(dB)	LINE
COOLING	49	○—○
HEATING	47	●—●



PUZ-WM50VHA.UK

PUZ-WM50VHA-BS.UK

Unit: mm

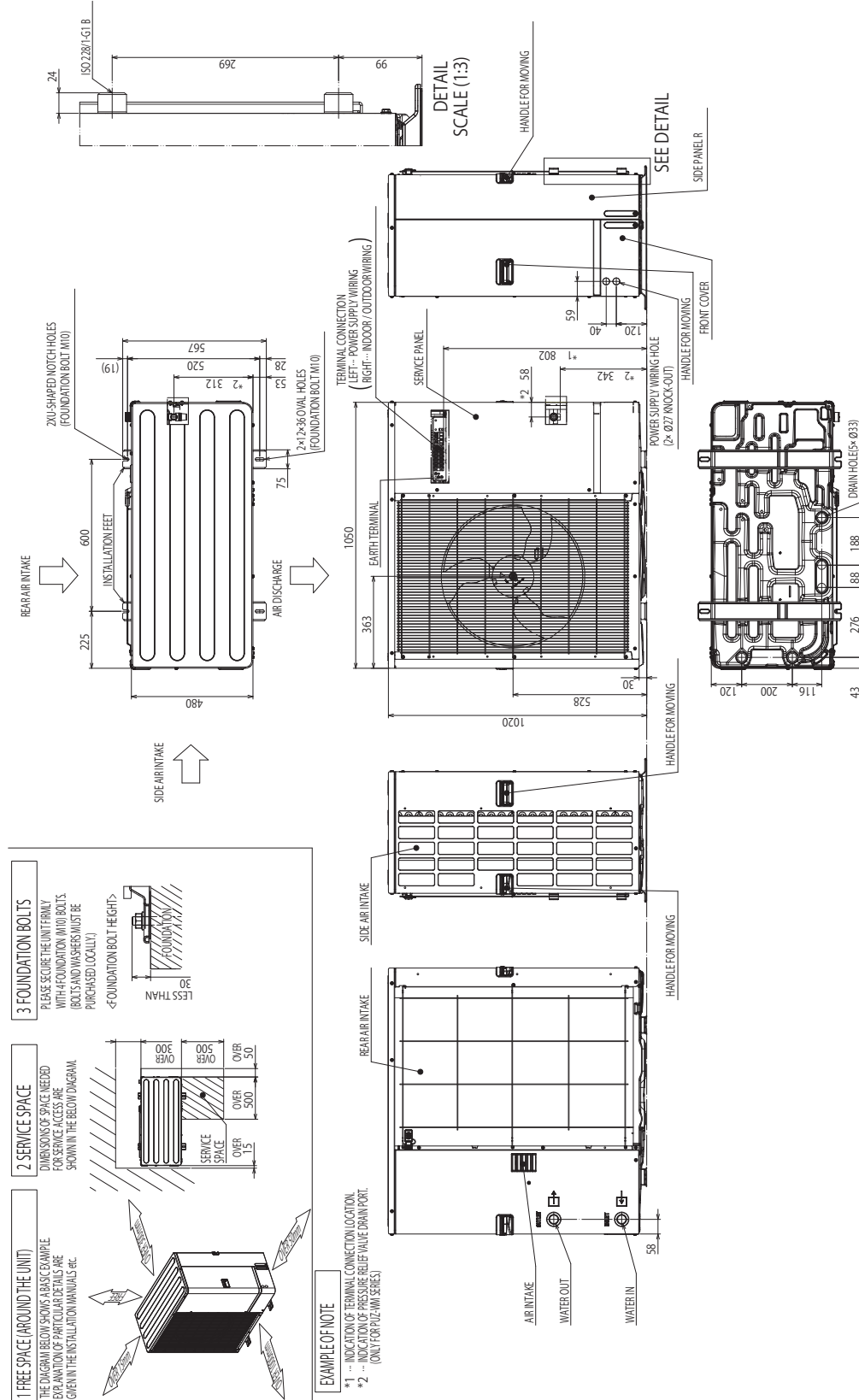


PUZ-WM60VAA.UK  
 PUZ-WM60VAA-BS.UK  
 PUZ-WM112VAA.UK  
 PUZ-WM112VAA-BS.UK

PUZ-WM85VAA.UK  
 PUZ-WM85VAA-BS.UK  
 PUZ-WM112YAA.UK  
 PUZ-WM112YAA-BS.UK

PUZ-WM85YAA.UK  
 PUZ-WM85YAA-BS.UK

Unit: mm

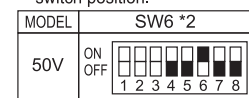


PUZ-WM50VHA.UK

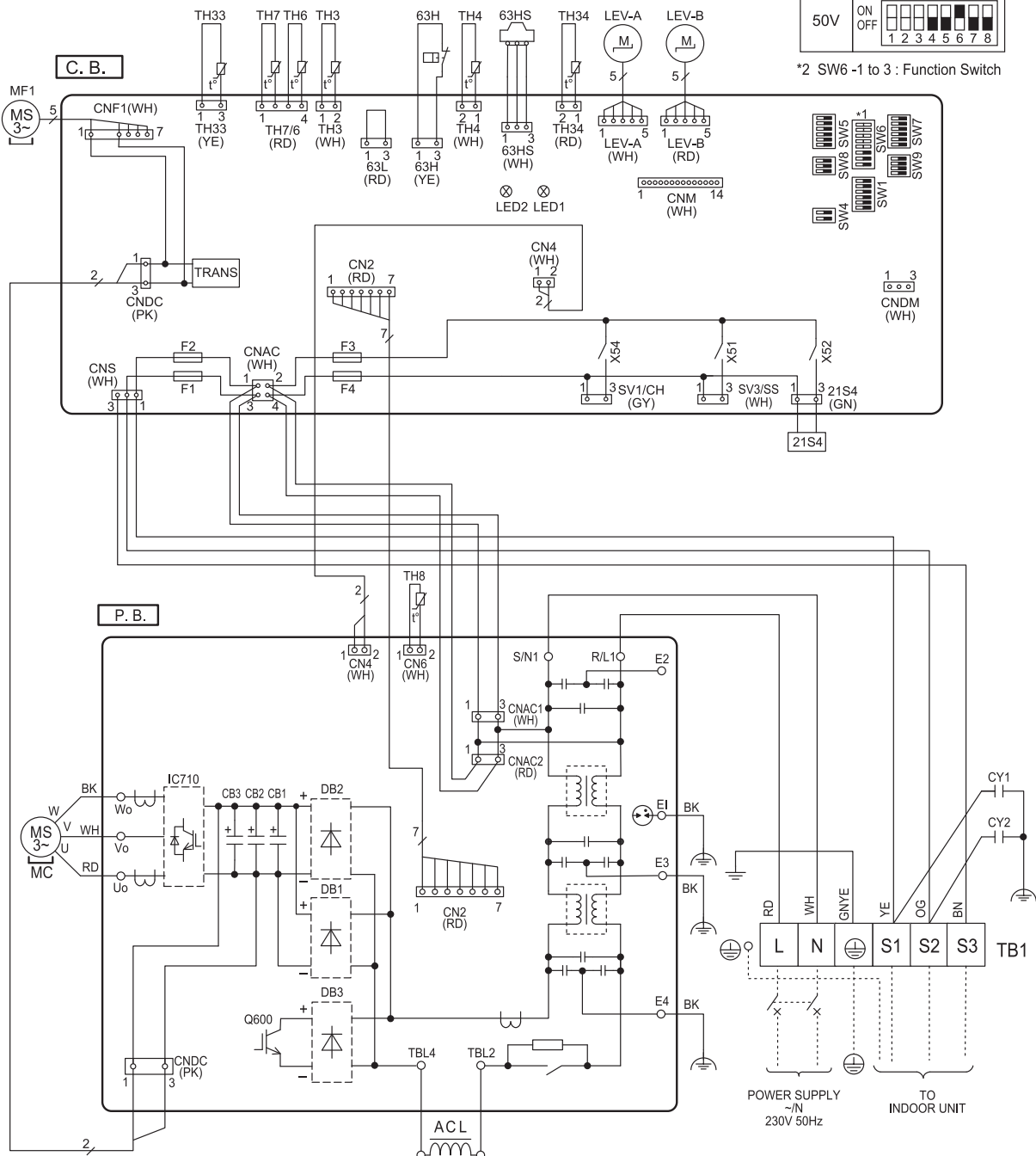
PUZ-WM50VHA-BS.UK

SYMBOL	NAME	SYMBOL	NAME
TB1	Terminal Block <Power Supply, Indoor/Outdoor>	CY1, CY2	Capacitor
MC	Motor for Compressor	P.B.	Power Circuit Board
MF1	Fan Motor	C.B.	Controller Circuit Board
21S4	Solenoid Valve (4-Way Valve)	SW1	Switch <Manual Defrost, Defect History Record Reset, Refrigerant Address>
63H	High Pressure Switch	SW4	Switch <Function Switch>
63HS	Pressure Sensor	SW5	Switch <Function Switch>
TH3	Thermistor <Liquid>	SW6	Switch <Function Switch, Model Select>
TH4	Thermistor <Discharge>	SW7	Switch <Function Switch>
TH6	Thermistor <2-Phase Pipe>	SW8	Switch <Function Switch>
TH7	Thermistor <Ambient>	SW9	Switch <Function Switch>
TH8	Thermistor <Heat Sink>	CNDM	Connector <Connection for Option>
TH33	Thermistor <Comp. Surface>	SV1/CH	Connector <Connection for Option>
TH34	Thermistor <Plate Hex Liquid>	SV3/SS	Connector <Connection for Option>
LEV-A, LEV-B	Linear Expansion Valve	CNM	Connector <Connection for Option>
ACL	Reactor	F1, F2, F3, F4	Fuse <T6.3AL250V>

\*1 MODEL SELECT  
The black square (■) indicates a switch position.



\*2 SW6-1 to 3 : Function Switch

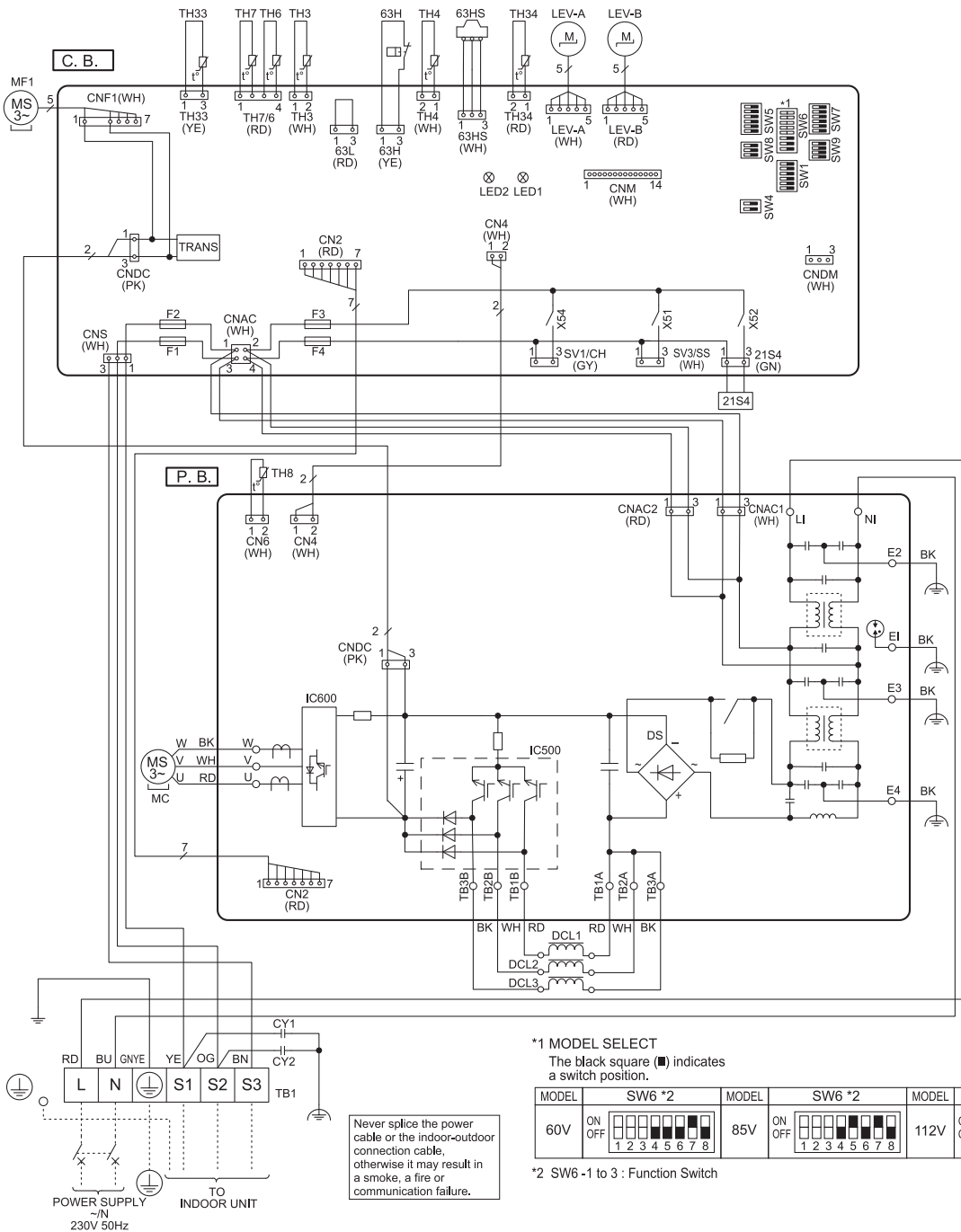


**PUZ-WM60VAA.UK**  
**PUZ-WM60VAA-BS.UK**

**PUZ-WM85VAA.UK**  
**PUZ-WM85VAA-BS.UK**

**PUZ-WM112VAA.UK**  
**PUZ-WM112VAA-BS.UK**

SYMBOL	NAME	SYMBOL	NAME
TB1	Terminal Block <Power Supply, Indoor/Outdoor>	P.B.	Power Circuit Board
MC	Motor for Compressor	C.B.	Controller Circuit Board
MF1	Fan Motor	SW1	Switch <Manual Defrost, Defect History Record Reset, Refrigerant Address>
21S4	Solenoid Valve (4-Way Valve)	SW4	Switch <Function Switch>
63H	High Pressure Switch	SW5	Switch <Function Switch>
63HS	Pressure Sensor	SW6	Switch <Function Switch, Model Select>
TH3	Thermistor <Liquid>	SW7	Switch <Function Switch>
TH4	Thermistor <Discharge>	SW8	Switch <Function Switch>
TH6	Thermistor <2-Phase Pipe>	SW9	Switch <Function Switch>
TH7	Thermistor <Ambient>	CNDM	Connector <Connection for Option>
TH8	Thermistor <Heat Sink>	SV1/CH	Connector <Connection for Option>
TH33	Thermistor <Comp. Surface>	SV3/SS	Connector <Connection for Option>
TH34	Thermistor <Plate Hex Liquid>	CNM	Connector <Connection for Option>
LEV-A, LEV-B	Linear Expansion Valve	F1, F2, F3, F4	Fuse <T6.3AL250V>
DCL1, DCL2, DCL3	Reactor		
CY1, CY2	Capacitor		

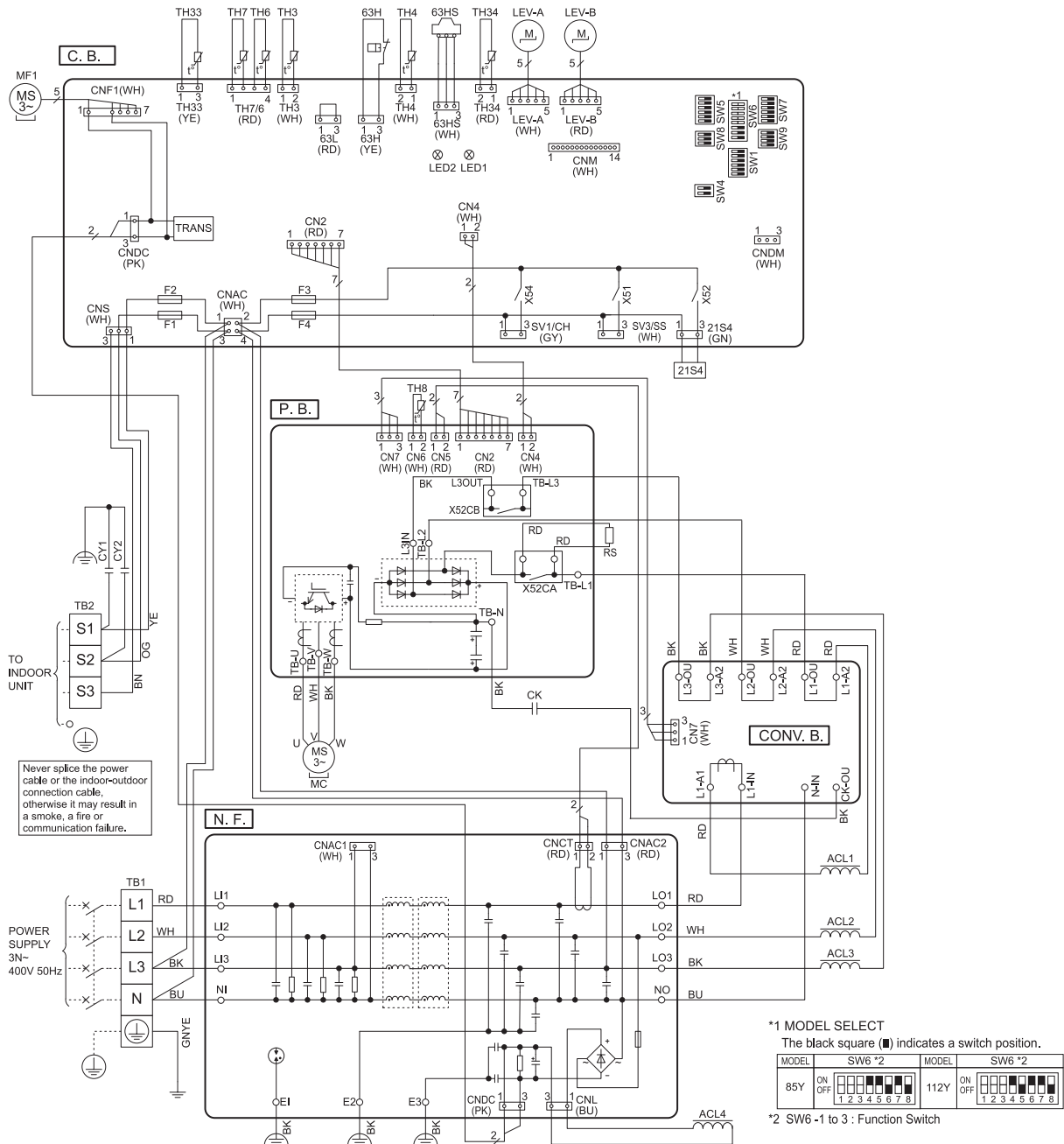




**PUZ-WM85YAA.UK**  
**PUZ-WM85YAA-BS.UK**

**PUZ-WM112YAA.UK**  
**PUZ-WM112YAA-BS.UK**

SYMBOL	NAME	SYMBOL	NAME
TB1	Terminal Block <Power Supply>	P. B.	Power Circuit Board
TB2	Terminal Block <Indoor/Outdoor>	N. F.	Noise Filter Circuit Board
MC	Motor for Compressor	CONV. B.	Converter Circuit Board
MF1	Fan Motor	C. B.	Controller Circuit Board
21S4	Solenoid Valve (4-Way Valve)	SW1	Switch <Manual Defrost, Defect History Record Reset, Refrigerant Address>
63H	High Pressure Switch	SW4	Switch <Function Switch>
63HS	Pressure Sensor	SW5	Switch <Function Switch>
TH3	Thermistor <Liquid>	SW6	Switch <Function Switch, Model Select>
TH4	Thermistor <Discharge>	SW7	Switch <Function Switch>
TH6	Thermistor <2-Phase Pipe>	SW8	Switch <Function Switch>
TH7	Thermistor <Ambient>	SW9	Switch <Function Switch>
TH8	Thermistor <Heat Sink>	CNDM	Connector <Connection for Option>
TH33	Thermistor <Comp. Surface>	SV1/CH	Connector <Connection for Option>
TH34	Thermistor <Plate Hex Liquid>	SV3/SS	Connector <Connection for Option>
LEV-A, LEV-B	Linear Expansion Valve	CNM	Connector <Connection for Option>
ACL1, ACL2, ACL3, ACL4	Reactor	F1, F2, F3, F4	Fuse <T6.3AL250V>
CY1, CY2	Capacitor		
CK	Capacitor		
RS	Rush Current Protect Resistor		



## FIELD ELECTRICAL WIRING (power wiring specifications)

Outdoor unit model		WM50V	WM60V	WM85V	WM112V	WM85Y, WM112Y	
Outdoor unit power supply		~N (single), 50 Hz, 230 V					3N~ (3 ph 4-wires), 50 Hz, 400 V
Outdoor unit input capacity Main switch (Breaker) *1		16 A	16 A	25 A	32 A	16 A	
Wiring Wire No. x size (mm <sup>2</sup> )	Outdoor unit power supply	3 × Min 1.5	3 × Min 2.5	3 × Min 2.5	3 × Min 4	5 × Min 1.5	
	Indoor unit-Outdoor unit *2	3 × 1.5 (polar)					
	Indoor unit-Outdoor unit earth *2	1 × Min 1.5					
	Remote controller-Indoor unit	2 × 0.3 (Non-polar)					
Circuit rating	*Outdoor unit L-N (single)	230 V AC					
	Outdoor unit L1-N, L2-N, L3-N (3 phase)*	230 V AC					
	Indoor unit-Outdoor unit S1-S2 *3	230 V AC					
	Indoor unit-Outdoor unit S2-S3 *3	24 V DC					
	Remote controller-Indoor unit *3	12 V DC					

\*1. A breaker with at least 3.0 mm contact separation in each pole shall be provided. Use earth leakage breaker (NV).

Make sure that the current leakage breaker is one compatible with higher harmonics.

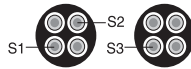
Always use a current leakage breaker that is compatible with higher harmonics as this unit is equipped with an inverter.

The use of an inadequate breaker can cause the incorrect operation of inverter.

\*2. Maximum 45 m

If 2.5 mm<sup>2</sup> is used, maximum 50 m.

If 2.5 mm<sup>2</sup> is used and S3 is separated, maximum 80 m.



\*3. The figures are NOT always against the ground.

S3 terminal has 24 V DC against S2 terminal. However between S3 and S1, these terminals are NOT electrically insulated by the transformer or other device.

**⚠ Caution: Be sure to install N-line. Without N-line, it could cause damage to the unit.**

**Notes:** 1. Wiring size must comply with the applicable local and national codes.

2. Power supply cables and the cables between Interface unit/Flow temp. controller and outdoor unit shall not be lighter than polychloroprene sheathed flexible cables. (Design 60245 IEC 57)

3. Be sure to connect the cables between Interface unit/Flow temp. controller and outdoor unit directly to the units (no intermediate connections are allowed).

Intermediate connections may result in communication errors. If water enters at the intermediate connection point, it may cause insufficient insulation to ground or a poor electrical contact.

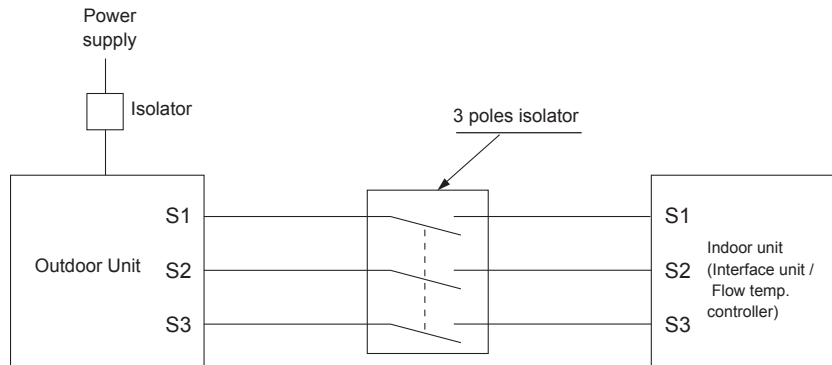
(If an intermediate connection is necessary, be sure to take measures to prevent water from entering the cables.)

4. Install an earth line longer than power cables.

5. Do not construct a system with a power supply that is turned ON and OFF frequently.

6. Use self-extinguishing distribution cable for power supply wiring.

7. Properly route wiring so as not to contact the sheet metal edge or screw tip.



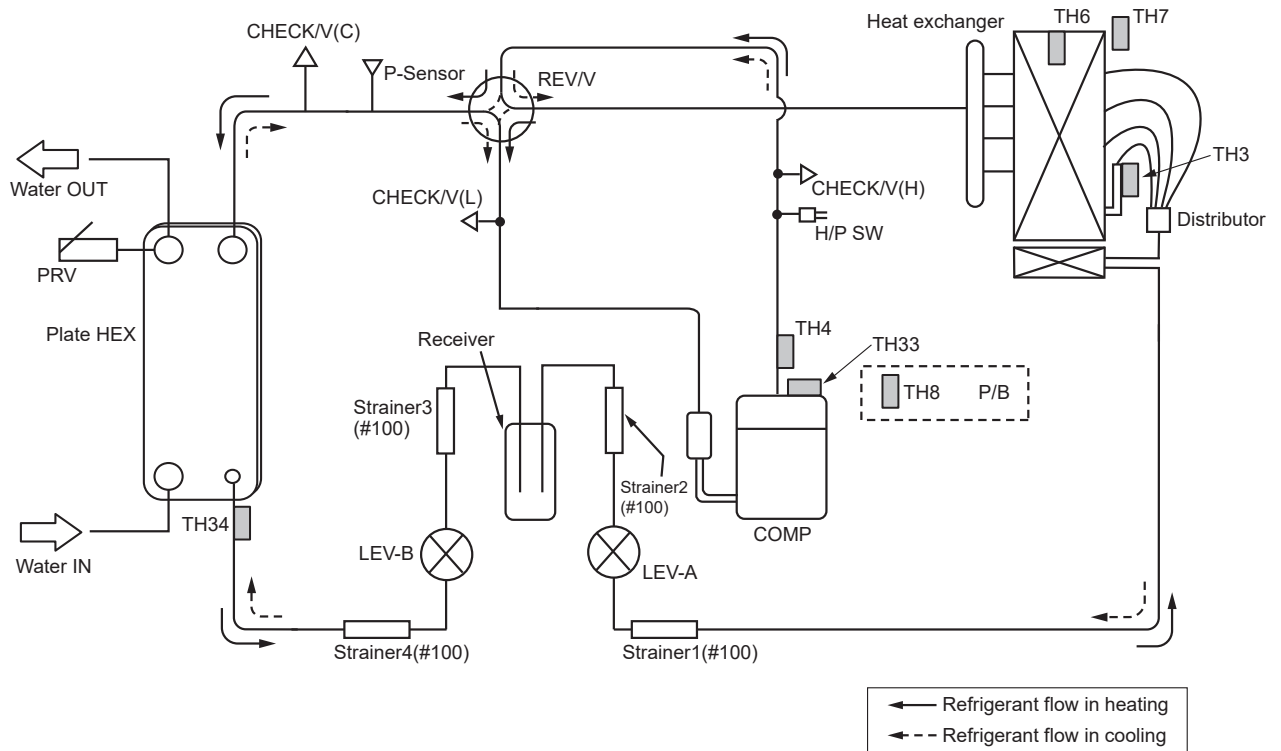
**⚠ Warning:**

- In case of A-control wiring, there is high voltage potential on the S3 terminal caused by electrical circuit design that has no electrical insulation between power line and communication signal line. Therefore, please turn off the main power supply when servicing. And do not touch the S1, S2, S3 terminals when the power is energized. If isolator should be used between indoor unit and outdoor unit, please use 3-pole type.

Never splice the power cable or the Interface unit/Flow temp. controller-outdoor unit connection cable, otherwise it may result in smoke emission, a fire or communication failure.

PUZ-WM50VHA.UK

PUZ-WM50VHA-BS.UK

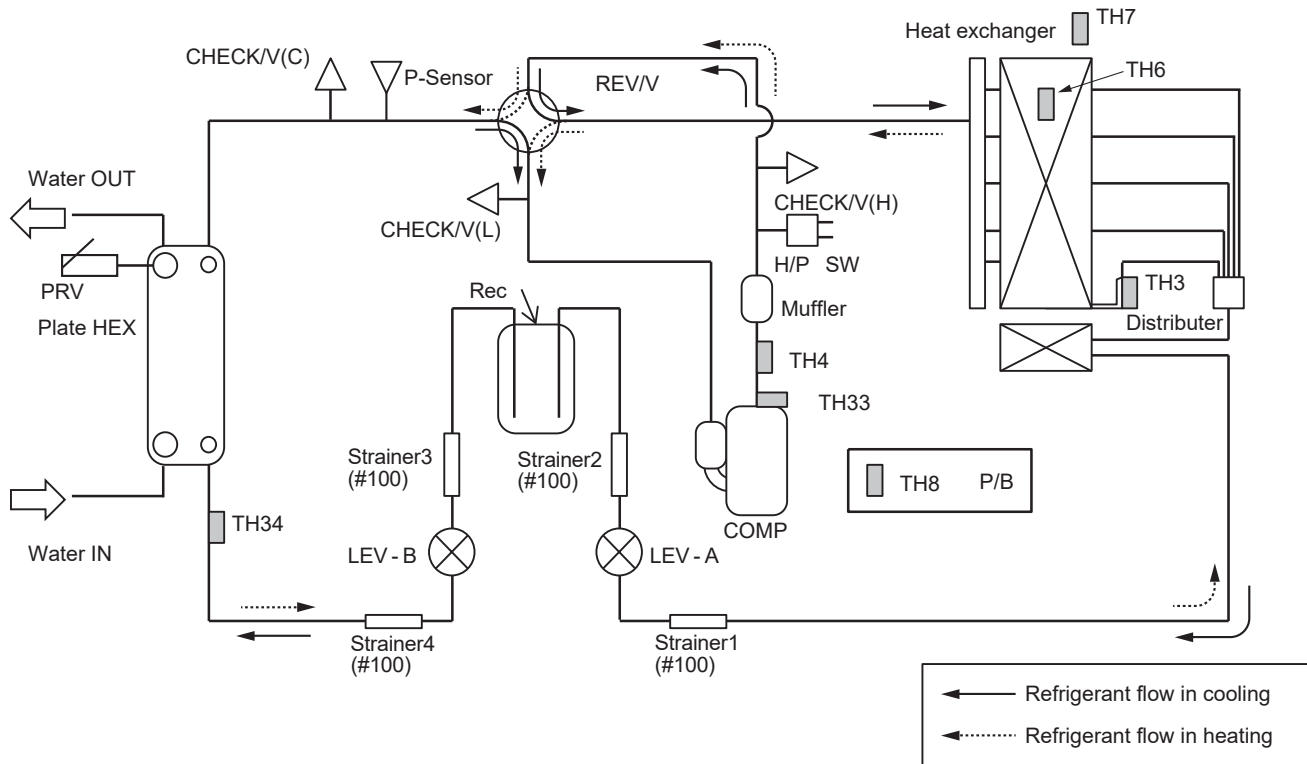


Symbol	Part name	Detail
COMP	Compressor	DC inverter twin rotary compressor (Mitsubishi Electric Corporation)
H/P SW	High pressure switch (63H)	For protection (OFF: 4.15MPa)
REV/V	Reversing (4-way) valve (21S4)	Change the refrigerant circuit (Heating/Cooling) and for Defrosting
CHECK/V	Check valve	(H): High pressure/(L): Low pressure/(C): For production test use
P-Sensor	Refrigerant pressure sensor (63HS)	For calculation of the saturation temperature from refrigerant pressure
P/B	Power circuit board	Inverter power board
LEV-A	Linear expansion valve -A	Heating: Secondary LEV Cooling: Primary LEV
LEV-B	Linear expansion valve -B	Heating: Primary LEV Cooling: Secondary LEV
TH3	Liquid temperature thermistor	Heating: Evaporating temperature Cooling: Sub cool liquid temperature
TH4	Discharge temperature thermistor	For LEV control and for compressor protection
TH6	2-phase pipe temperature thermistor	Heating: Evaporating temperature Cooling: Condensing temperature
TH7	Ambient temperature thermistor	For fan control and for compressor frequency control
TH8	Heat sink temperature thermistor	For power board protection
TH33	Comp.surface temperature thermistor	For compressor protection
TH34	Plate HEX liquid temperature thermistor	Heating: Sub cool liquid temperature Cooling: Evaporating temperature
Receiver	Receiver	For accumulation of refrigerant
Plate HEX	Plate Heat Exchanger	MWA1-28HM (Mitsubishi Electric Corporation)
PRV	Pressure relief valve	For water pressure protection (Discharge: 3bar)

**PUZ-WM60VAA.UK**  
**PUZ-WM60VAA-BS.UK**

**PUZ-WM85VAA.UK**  
**PUZ-WM85VAA-BS.UK**

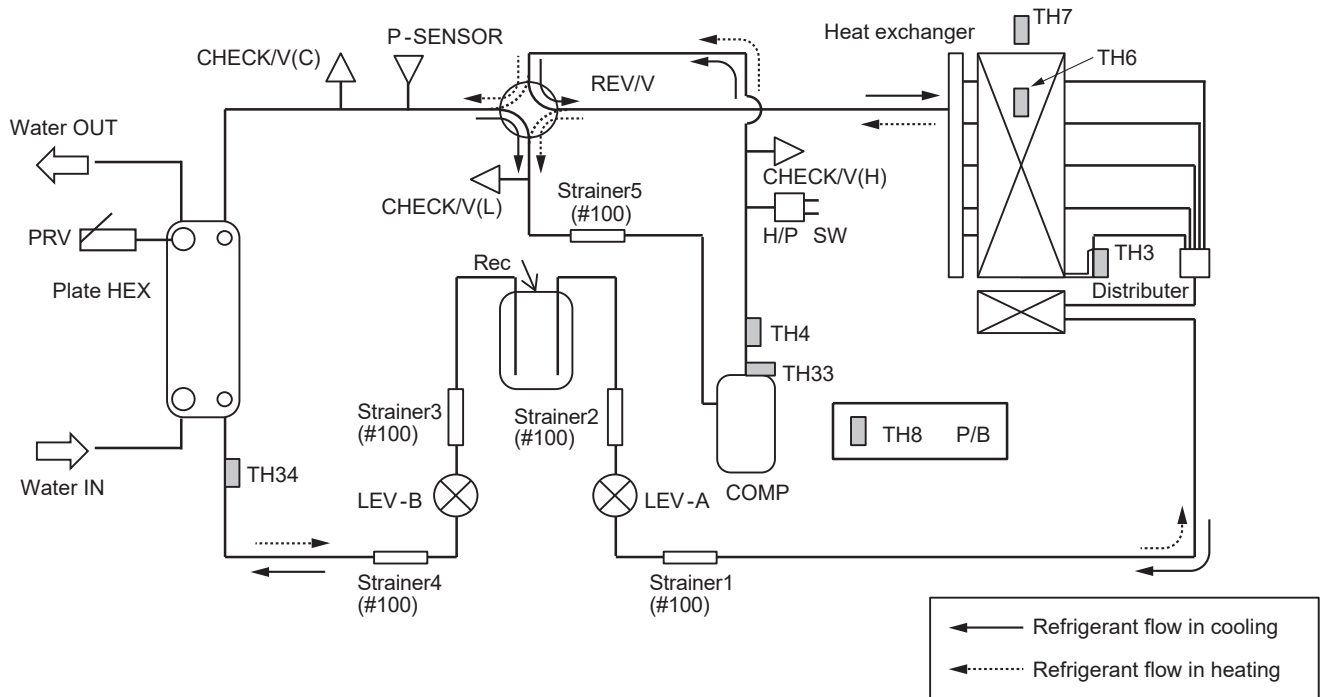
**PUZ-WM85YAA.UK**  
**PUZ-WM85YAA-BS.UK**



Symbol	Parts name	Detail
COMP	Compressor	DC inverter scroll compressor (Mitsubishi Electric Corporation)
H/P SW	High pressure switch (63H)	For protection (OFF: 4.15MPa)
REV/V	Reversing (4-way) valve (21S4)	Change the refrigerant circuit (Heating / Cooling) and for Defrosting
CHECK/V	Charge plug	(H): High pressure/(L): Low pressure/(C): For production test use
P-Sensor	Refrigerant pressure sensor (63HS)	For calculation of the saturation temperature from refrigerant pressure
LEV-A	Linear expansion valve -A	Heating: Secondary LEV Cooling: Primary LEV
LEV-B	Linear expansion valve -B	Heating: Primary LEV Cooling: Secondary LEV
TH3	Liquid temperature thermistor	Heating: Evaporating temperature Cooling: Sub cool liquid temperature
TH4	Discharge temperature thermistor	For LEV control and for compressor protection
TH6	2-phase pipe temperature thermistor	Heating: Evaporating temperature Cooling: Condensing temperature
TH7	Ambient temperature thermistor	For fan control and for compressor frequency control
TH8	Heat sink temperature thermistor	For power board protection
TH33	Comp. surface temperature thermistor	For protection
TH34	Plate HEX liquid temperature thermistor	Heating: Sub cool liquid temperature Cooling: Evaporating temperature
Rec	Receiver	For accumulation of refrigerant
P/B	Power circuit board	Inverter power board
Plate HEX	Plate Heat Exchanger	MWA1-44HM (Mitsubishi Electric Corporation)
PRV	Pressure relief valve	For water pressure protection (Discharge: 3bar)

PUZ-WM112VAA.UK  
 PUZ-WM112VAA-BS.UK

PUZ-WM112YAA.UK  
 PUZ-WM112YAA-BS.UK



Symbol	Parts name	Detail
COMP	Compressor	DC inverter scroll compressor (Mitsubishi Electric Corporation)
H/P SW	High pressure switch (63H)	For protection (OFF: 4.15MPa)
REV/V	Reversing (4-way) valve (21S4)	Change the refrigerant circuit (Heating / Cooling) and for Defrosting
CHECK/V	Charge plug	(H): High pressure/(L): Low pressure/(C): For production test use
P-Sensor	Refrigerant pressure sensor (63HS)	For calculation of the saturation temperature from refrigerant pressure
LEV-A	Linear expansion valve -A	Heating: Secondary LEV Cooling: Primary LEV
LEV-B	Linear expansion valve -B	Heating: Primary LEV Cooling: Secondary LEV
TH3	Liquid temperature thermistor	Heating: Evaporating temperature Cooling: Sub cool liquid temperature
TH4	Discharge temperature thermistor	For LEV control and for compressor protection
TH6	2-phase pipe temperature thermistor	Heating: Evaporating temperature Cooling: Condensing temperature
TH7	Ambient temperature thermistor	For fan control and for compressor frequency control
TH8	Heat sink temperature thermistor	For power board protection
TH33	Comp. surface temperature thermistor	For protection
TH34	Plate HEX liquid temperature thermistor	Heating: Sub cool liquid temperature Cooling: Evaporating temperature
Rec	Receiver	For accumulation of refrigerant
P/B	Power circuit board	Inverter power board
Plate HEX	Plate Heat Exchanger	MWA1-44HM (Mitsubishi Electric Corporation)
PRV	Pressure relief valve	For water pressure protection (Discharge: 3bar)

**9-1. TROUBLESHOOTING****<Check code displayed by self-diagnosis and actions to be taken for service (summary)>**

Present and past check codes are logged, and they can be displayed on the control board of outdoor unit. Actions to be taken for service, which depends on whether or not the trouble is reoccurring in the field, are summarized in the table below. Check the contents below before investigating details.

Unit conditions at service	Check code	Actions to be taken for service (summary)
The trouble is reoccurring.	Displayed	Judge what is wrong and take a corrective action according to "9-2. SELF-DIAGNOSIS ACTION TABLE".
	Not displayed	Conduct troubleshooting and ascertain the cause of the trouble according to "9-3. TROUBLESHOOTING OF PROBLEMS".
The trouble is not reoccurring.	Logged	<ul style="list-style-type: none"> <li>①Consider the temporary defects such as the work of protection devices in the refrigerant circuit including compressor, poor connection of wiring, noise, etc. Re-check the symptom, and check the installation environment, refrigerant amount, weather when the trouble occurred, matters related to wiring, etc.</li> <li>②Reset check code logs and restart the unit after finishing service.</li> <li>③There is no abnormality in electrical component, controller board, remote controller, etc.</li> </ul>
	Not logged	<ul style="list-style-type: none"> <li>①Re-check the abnormal symptom.</li> <li>②Conduct troubleshooting and ascertain the cause of the trouble according to "9-3. TROUBLESHOOTING OF PROBLEMS".</li> <li>③Continue to operate unit for the time being if the cause is not ascertained.</li> <li>④There is no abnormality concerning of parts such as electrical component, controller board, remote controller, etc.</li> </ul>

## 9-2. SELF-DIAGNOSIS ACTION TABLE

<Abnormalities detected when the power is turned on>

Note: Refer to indoor unit section for code P, code E, and Code L.

Check code	Abnormal points and detection method	Cause	Judgment and action
None	—	<p>① No voltage is supplied to terminal block (TB1) of outdoor unit. a) Power supply breaker is turned off. b) Contact failure or disconnection of power supply terminal c) Open phase (L or N phase)</p> <p>② Electric power is not charged to power supply terminal of outdoor power circuit board. a) Contact failure of power supply terminal b) Open phase on the outdoor power circuit board</p> <p>③ Electric power is not supplied to outdoor controller circuit board. a) Disconnection of connector (CNDC)</p> <p>④ Disconnection of reactor (DCL or ACL)</p> <p>⑤ Disconnection of outdoor noise filter circuit board or parts failure in outdoor noise filter circuit board</p> <p>⑥ Defective outdoor power circuit board</p> <p>⑦ Open of rush current protect resistor(RS)(Y)</p> <p>⑧ Defective outdoor controller circuit board</p>	<p>① Check following items. a) Power supply breaker b) Connection of power supply terminal block (TB1) c) Connection of power supply terminal block (TB1)</p> <p>② Check following items. a) Connection of power supply terminal block (TB1) b) Connection of terminal on outdoor power circuit board Check connection of the connector LI or NI. Refer to "9-6.TEST POINT DIAGRAM".</p> <p>③ Check connection of the connector (CNDC) on the outdoor controller circuit board. Check connection of the connector, CNDC on the outdoor power circuit board(V)/the noise filter(Y). Refer to "9-6.TEST POINT DIAGRAM".</p> <p>④ Check connection of reactor. (DCL or ACL) Refer to "9-6.TEST POINT DIAGRAM".</p> <p>⑤ a) Check connection of outdoor noise filter circuit board. b) Replace outdoor noise filter circuit board. Refer to "9-6.TEST POINT DIAGRAM".</p> <p>⑥ Replace outdoor power circuit board.</p> <p>⑦ Replace rush current protect resistor(RS). Power circuit board might be short-circuit. Check the power circuit board.(Refer to "9-6.TEST POINT DIAGRAM".)</p> <p>⑧ Replace controller board (When items above are checked but the units cannot be repaired).</p>
F5 (5201)	<p><b>63H connector open</b> Abnormal if 63H connector circuit is open for 3 minutes continuously after power supply.</p> <p>63H: High pressure switch</p>	<p>① Disconnection or contact failure of 63H connector on outdoor controller circuit board</p> <p>② Disconnection or contact failure of 63H</p> <p>③ 63H is working due to defective parts.</p> <p>④ Defective outdoor controller circuit board</p>	<p>① Check connection of 63H connector on outdoor controller circuit board. Refer to "9-6.TEST POINT DIAGRAM".</p> <p>② Check the 63H side of connecting wire.</p> <p>③ Check continuity by tester. Replace the parts if the parts are defective.</p> <p>④ Replace outdoor controller circuit board.</p>



Check code	Abnormal points and detection method	Cause	Judgment and action
EA (6844)	<p><b>Indoor/outdoor unit connector miswiring, excessive number of units (2 units or more)</b></p> <p>1. Outdoor controller circuit board can automatically check the number of connected indoor units. Abnormal if the number cannot be checked automatically due to miswiring of indoor/outdoor unit connecting wire and etc. after power is turned on for 4 minutes.</p> <p>2. Abnormal if outdoor controller circuit board recognizes the number of connected indoor units as "2 units or more".</p>	<p>① Contact failure or miswiring of indoor/outdoor unit connecting wire</p> <p>② Diameter or length of indoor/outdoor unit connecting wire is out of specified capacity.</p> <p>③ 2 or more indoor units are connected to one outdoor unit.</p> <p>④ Defective transmitting receiving circuit of outdoor controller circuit board</p> <p>⑤ Defective transmitting receiving circuit of indoor controller board</p> <p>⑥ Defective indoor power board</p> <p>⑦ Do NOT use refrigerant address 0, as 0 is used for FTC (Master). The address range is 1 to 6. (In case of multiple outdoor units control.)</p> <p>⑧ Noise has entered into power supply or indoor/outdoor unit connecting wire.</p>	<p>① Check disconnection or looseness or polarity of indoor/outdoor unit connecting wire of indoor and outdoor units.</p> <p>② Check diameter and length of indoor/outdoor unit connecting wire. Total wiring length: 80 m (including wiring connecting each indoor unit and between indoor and outdoor unit) Also check if the connection order of flat cable is S1, S2, S3.</p> <p>③ Check the number of indoor units that are connected to one outdoor unit. (If EA is detected)</p> <p>④-⑥ Turn the power off once, and on again to check. Replace outdoor controller circuit board, indoor controller board or indoor power board if abnormality occurs again.</p> <p>⑦ Check if refrigerant addresses (SW1-3 to SW1-6 on outdoor controller circuit board) are overlapping in case of multiple outdoor units control.</p> <p>⑧ Check transmission path, and remove the cause.</p> <p>Note: The descriptions above, ①-⑧, are for EA, Eb and EC.</p>
Eb (6845)	<p><b>Miswiring of indoor/outdoor unit connecting wire (reverse wiring or disconnection)</b></p> <p>Outdoor controller circuit board can automatically set the unit number of indoor units. Abnormal if the indoor unit number cannot be set within 4 minutes after power on because of miswiring (reverse wiring or disconnection) of indoor/outdoor unit connecting wire.</p>	<p>① Contact failure or miswiring of indoor/outdoor unit connecting wire</p> <p>② Diameter or length of indoor/outdoor unit connecting wire is out of specified capacity.</p> <p>④ Defective transmitting receiving circuit of outdoor controller circuit board</p> <p>⑤ Defective transmitting receiving circuit of indoor controller board</p> <p>⑥ Defective indoor power board</p> <p>⑦ Do NOT use refrigerant address 0, as 0 is used for FTC (Master). The address range is 1 to 6. (In case of multiple outdoor units control.)</p> <p>⑧ Noise has entered into power supply or indoor/outdoor unit connecting wire.</p>	<p>①-⑧</p>
EC (6846)	<p><b>Startup time over</b></p> <p>The unit cannot finish startup process within 4 minutes after power on.</p>	<p>① Contact failure of indoor/outdoor unit connecting wire</p> <p>② Diameter or length of indoor/outdoor unit connecting wire is out of specified capacity.</p> <p>③ Do NOT use refrigerant address 0, as 0 is used for FTC (Master). The address range is 1 to 6. (In case of multiple outdoor units control.)</p> <p>④ Noise has entered into power supply or indoor/outdoor unit connecting wire.</p>	<p>①-④</p>
EE	<p><b>Incorrect connection</b></p> <p>The outdoor unit does not receive the signals of I/F or FTC.</p>	<p>① A device other than Interface unit or Flow temp. controller unit is connected to the unit.</p>	<p>① Connect I/F or FTC to the unit.</p>





Check code	Abnormal points and detection method	Cause	Judgment and action
<p>U1 (1302)</p>	<p><b>High pressure (High pressure switch 63H operated)</b> Abnormal if high pressure switch 63H operated (4.15 MPa) during compressor operation. 63H: High pressure switch</p>	<p>① Defective operation of stop valve (Not fully open) ② Clogged or broken pipe ③ Locked outdoor fan motor ④ Malfunction of outdoor fan motor ⑤ Short cycle of outdoor unit ⑥ Dirt of outdoor heat exchanger ⑦ Decreased airflow caused by defective inspection of outside temperature thermistor (It detects lower temperature than actual temperature.) ⑧ Disconnection or contact failure of connector (63H) on outdoor controller board ⑨ Disconnection or contact failure of 63H connection ⑩ Defective outdoor controller board ⑪ Defective action of linear expansion valve ⑫ Malfunction of fan driving circuit</p>	<p>① Check if stop valve is fully open. ② Check piping and repair defect. ③–⑥ Check outdoor unit and repair defect. ⑦ Check the detected temperature of outside temperature thermistor on LED display. (SW2 on A-Control Service Tool : Refer to "9-7. FUNCTION OF SWITCHES, CONNECTORS AND JUMPERS".) ⑧–⑩ Turn the power off and check F5 is displayed when the power is turned again. When F5 is displayed, refer to "Judgment and action" for F5. ⑪ Check linear expansion valve. Refer to "9-4. HOW TO CHECK THE PARTS". ⑫ Replace outdoor controller board.</p>
<p>U2 (1102)</p>	<p><b>High discharge temperature</b> (1) Abnormal if TH4 exceeds 125°C or 110°C continuously for 5 minutes. Abnormal if TH4 exceeds 110°C or more continuously for 30 seconds after 90 seconds have passed since the defrosting operation started.  (2) Abnormal if discharge superheat (Cooling: TH4–TH6 / Heating: TH4–T63HS) exceeds 70°C continuously for 10 minutes.  TH4: Thermistor &lt;Discharge&gt; temperature TH6: Thermistor &lt;2-phase temp.&gt; temperature T63HS: Plate HEX cond./eva. temperature  <b>High comp. surface temperature</b> Abnormal if TH33 exceeds 125°C. In the case of high comp. surface temperature error, compressor does not restart unless the thermistor (TH33) becomes less than 95°C.  TH33: Thermistor &lt;Comp. surface&gt;</p>	<p>① Overheated compressor operation caused by shortage of refrigerant ② Defective operation of stop valve ③ Defective thermistor ④ Defective outdoor controller board ⑤ Defective action of linear expansion valve ⑥ Clogging with foreign objects in refrigerant circuit Note: Clogging occur in the parts which become below freezing point when water enters in refrigerant circuit. ⑦ In the case of the unit does not restart: Detection temp. of thermistor (TH33) ≥ 95°C</p>	<p>① Check intake superheat. Check leakage of refrigerant. Charge additional refrigerant. ② Check if stop valve is fully open. ③④ Turn the power off and check if U3 is displayed when the power is turned on again. When U3 is displayed, refer to "Judgment and action" for U3. ⑤ Check linear expansion valve. Refer to "9-4. HOW TO CHECK THE PARTS". ⑥ After recovering refrigerant, remove water from entire refrigerant circuit under vacuum more than 1 hour.</p>
<p>U3 (5104)</p>	<p><b>Open/short circuit of outdoor unit temperature thermistor (TH4, TH33)</b> Abnormal if open (-20°C or less) or short (217°C or more) is detected during compressor operation. (Detection is inoperative for 10 minutes of compressor starting process and for 10 minutes after and during defrosting.)  TH4: Thermistor &lt;Discharge&gt; TH33: Thermistor &lt;Comp. surface&gt;</p>	<p>① Disconnection or contact failure of connectors (TH4, TH33) on the outdoor controller circuit board ② Defective thermistor ③ Defective outdoor controller circuit board</p>	<p>① Check connection of connector (TH4, TH33) on the outdoor controller circuit board. Check breaking of the lead wire for TH4, TH33. Refer to "9-6. TEST POINT DIAGRAM". ② Check resistance value of TH4, TH33 or temperature by microprocessor. (Thermistor/TH4, TH33: Refer to "9-4. HOW TO CHECK THE PARTS".) (SW2 on A-Control Service Tool: Refer to "9-7. FUNCTION OF SWITCHES, CONNECTORS AND JUMPERS".) ③ Replace outdoor controller board.</p>



Check code	Abnormal points and detection method	Cause	judgment and action																											
U4 (TH3:5105) (TH6:5107) (TH7:5106) (TH8:5110) (TH34:5105)	<b>Open/short of outdoor unit thermistors (TH3, TH34, TH6, TH7, and TH8)</b> Abnormal if open or short is detected during compressor operation. Open detection of TH3, TH34 and TH6 is inoperative for 10 seconds to 10 minutes after compressor starting and 10 minutes after and during defrosting. Note: Check which unit has abnormality in its thermistor by switching the mode of SW2. (PAC-SK52ST) (Refer to "9-7. FUNCTION OF SWITCHES, CONNECTORS AND JUMPERS".)	① Disconnection or contact failure of connectors Outdoor controller circuit board: ( TH3, TH34, TH7/6 ) Outdoor power circuit board: CN3 ② Defective thermistor ③ Defective outdoor controller circuit board	① Check connection of connector (TH3, TH34, TH7/6) on the outdoor controller circuit board. Check connection of connector (CN3) on the outdoor power circuit board. Check breaking of the lead wire for TH3, TH34, TH6, TH7, TH8. Refer to "9-6.TEST POINT DIAGRAM". ② Check resistance value of TH3, TH34, TH6,TH7,TH8 or check temperature by microprocessor. (TH3,TH34,TH6,TH7,TH8: Refer to "9-6.TEST POINT DIAGRAM".) (SW2 on A-Control Service Tool: Refer to "9-7. FUNCTION OF SWITCHES, CONNECTORS AND JUMPERS".) ③ Replace outdoor controller circuit board. Note: Emergency operation is available in case of abnormalities of TH3, TH34, TH6 and TH7.																											
	<table border="1"> <thead> <tr> <th colspan="2">Thermistors</th> <th>Open detection</th> <th>Short detection</th> </tr> <tr> <th>Symbol</th> <th>Name</th> <td></td> <td></td> </tr> </thead> <tbody> <tr> <td>TH3</td> <td>Thermistor &lt;Liquid&gt;</td> <td>-40 °C or below</td> <td>90 °C or above</td> </tr> <tr> <td>TH6</td> <td>Thermistor &lt;Two-phase&gt;</td> <td>-40 °C or below</td> <td>90 °C or above</td> </tr> <tr> <td>TH7</td> <td>Thermistor &lt;Ambient&gt;</td> <td>-40 °C or below</td> <td>90 °C or above</td> </tr> <tr> <td>TH8</td> <td>Thermistor &lt;Heat sink&gt;</td> <td>-35 °C or below</td> <td>102 °C or above</td> </tr> <tr> <td>TH34</td> <td>Thermistor &lt;Plate hex liquid&gt;</td> <td>-40 °C or below</td> <td>90 °C or above</td> </tr> </tbody> </table>		Thermistors		Open detection	Short detection	Symbol	Name			TH3	Thermistor <Liquid>	-40 °C or below	90 °C or above	TH6	Thermistor <Two-phase>	-40 °C or below	90 °C or above	TH7	Thermistor <Ambient>	-40 °C or below	90 °C or above	TH8	Thermistor <Heat sink>	-35 °C or below	102 °C or above	TH34	Thermistor <Plate hex liquid>	-40 °C or below	90 °C or above
Thermistors		Open detection	Short detection																											
Symbol	Name																													
TH3	Thermistor <Liquid>	-40 °C or below	90 °C or above																											
TH6	Thermistor <Two-phase>	-40 °C or below	90 °C or above																											
TH7	Thermistor <Ambient>	-40 °C or below	90 °C or above																											
TH8	Thermistor <Heat sink>	-35 °C or below	102 °C or above																											
TH34	Thermistor <Plate hex liquid>	-40 °C or below	90 °C or above																											
U5 (4230)	<b>Temperature of heat sink</b> Abnormal if TH8 detects temperature indicated below. WM50V.....77°C WM60V,WM85V,WM112V .....78°C WM85Y,WM112Y.....85°C TH8: Thermistor <Heat sink>	① The outdoor fan motor is locked. ② Failure of outdoor fan motor ③ Airflow path is clogged. ④ Rise of ambient temperature ⑤ Defective thermistor ⑥ Defective input circuit of outdoor power circuit board ⑦ Failure of outdoor fan drive circuit	①② Check outdoor fan. ③ Check airflow path for cooling. ④ Check if there is something which causes temperature rise around outdoor unit. (Upper limit of ambient temperature is 46°C.) Turn off power, and on again to check if U5 is displayed within 30 minutes. If U4 is displayed instead of U5, follow the action to be taken for U4. ⑤ Check resistance value of TH8 or temperature by microprocessor. (TH8: Refer to "9-4. HOW TO CHECK THE PARTS".) (SW2 on A-Control Service Tool: Refer to "9-7. FUNCTION OF SWITCHES, CONNECTORS AND JUMPERS".) ⑥ Replace outdoor power circuit board. ⑦ Replace outdoor controller circuit board.																											
U6 (4250)	<b>Power module</b> Check abnormality by driving power module in case overcurrent is detected. (UF or UP error condition)	① Outdoor stop valve is closed. ② Decrease of power supply voltage ③ Looseness, disconnection or reverse of compressor wiring connection ④ Defective compressor ⑤ Defective outdoor power circuit board	① Open stop valve. ② Check facility of power supply. ③ Correct the wiring (U-V-W phase) to compressor. Refer to "9-6.TEST POINT DIAGRAM" (Outdoor power circuit board). ④ Check compressor referring to "9-4. HOW TO CHECK THE PARTS". ⑤ Replace outdoor power circuit board.																											
U7 (1502)	<b>Too low superheat due to low discharge temperature</b> Abnormal if discharge superheat is continuously detected less than or equal to -15°C for 3 minutes even though linear expansion valve has minimum open pulse after compressor starts operating for 10 minutes.	① Disconnection or loose connection of discharge temperature thermistor (TH4) ② Defective holder of discharge temperature thermistor ③ Disconnection or loose connection of linear expansion valve's coil ④ Disconnection or loose connection of linear expansion valve's connector ⑤ Defective linear expansion valve	①② Check the installation conditions of discharge temperature thermistor (TH4). ③ Check the coil of linear expansion valve. Refer to "9-5. HOW TO CHECK THE COMPONENTS". ④ Check the connection or contact of LEV-A and LEV-B on outdoor controller circuit board. ⑤ Check linear expansion valve. Refer to "9-4. HOW TO CHECK THE PARTS".																											
U8 (4400)	<b>Outdoor fan motor</b> Abnormal if rotational frequency of the fan motor is not detected during DC fan motor operation. Fan motor rotational frequency is abnormal if; • 100 rpm or below detected continuously for 15 seconds at 20°C or more outside air temperature. • 50 rpm or below or 1500 rpm or more detected continuously for 1 minute.	① Failure in the operation of the DC fan motor ② Failure in the outdoor circuit controller board	① Check or replace the DC fan motor. ② Check the voltage of the outdoor circuit controller board during operation. (When the failure is still indicated even after performing the action ① above.)																											



Check code	Abnormal points and detection method	Cause	Judgment and action	
U9 (4220)	Detailed codes	To find out the detail history (latest) about U9 error, turn ON SW2-1, 2-2 and 2-6. Refer to "9-7. FUNCTION OF SWITCHES, CONNECTORS AND JUMPERS".		
	01	<b>Overvoltage error</b> • Increase in DC bus voltage to WM50V : 400V WM60/85/112V : 430V WM85/112Y : 760V	<ol style="list-style-type: none"> <li>① Abnormal increase in power source voltage</li> <li>② Disconnection of compressor wiring</li> <li>③ Defective outdoor power circuit board</li> <li>④ Compressor has a ground fault.</li> </ol>	<ol style="list-style-type: none"> <li>① Check the field facility for the power supply.</li> <li>② Correct the wiring (U·V·W phase) to compressor. Refer to "9-7. FUNCTION OF SWITCHES, CONNECTORS AND JUMPERS". (Outdoor power circuit board).</li> <li>③ Replace outdoor power circuit board.</li> <li>④ Check compressor for electrical insulation. Replace compressor.</li> </ol>
	02	<b>Undervoltage error</b> • Instantaneous decrease in DC bus voltage to WM50/60/85/112V : 200V WM85/112Y : 350V	<ol style="list-style-type: none"> <li>① Decrease in power source voltage, instantaneous stop</li> <li>② Defective converter drive circuit in outdoor power circuit board (WM50V,WM60V,WM85V,WM112V)</li> <li>③ Defective 52C drive circuit in outdoor power circuit board</li> <li>④ Defective outdoor converter circuit board (WM85Y,WM112Y)</li> <li>⑤ Disconnection or loose connection of rush current protect resistor RS (WM85Y, WM112Y)</li> <li>⑥ Defective rush current protect resistor RS (WM85Y,WM112Y)</li> <li>⑦ Disconnection or loose connection of CN2 on the outdoor power circuit board /controller circuit board (WM50V,WM60V,WM85V,WM112V)</li> <li>⑧ Power circuit failure on DC supply for 15 V DC output on outdoor controller circuit board (WM50V,WM60V,WM85V,WM112V)</li> </ol>	<ol style="list-style-type: none"> <li>① Check the field facility for the power supply.</li> <li>② Replace outdoor power circuit board. (WM50V,WM60V,WM85V,WM112V)</li> <li>③ Replace outdoor power circuit board.</li> <li>④ Replace outdoor converter circuit board. (WM85Y,WM112Y)</li> <li>⑤ Check RS wiring. (WM85Y,WM112Y)</li> <li>⑥ Replace RS. (WM85Y,WM112Y)</li> <li>⑦ Check CN2 wiring. (WM50V,WM60V,WM85V,WM112V)</li> <li>⑧ Replace outdoor controller circuit board. (WM50V,WM60V,WM85V,WM112V)</li> </ol>
	04	<b>Input current sensor error/ L1-phase open error</b> • Decrease in input current through outdoor unit to 0.1A only if operation frequency is more than or equal to 40Hz or compressor current is more than or equal to 6A.	<ol style="list-style-type: none"> <li>① L1-phase open (WM85Y,WM112Y)</li> <li>② Disconnection or loose connection between TB1 and outdoor noise filter circuit board (WM85Y,WM112Y)</li> <li>③ Disconnection or loose connection of CN5 on the outdoor power circuit board/CNCT on the outdoor noise filter board</li> <li>④ Defective ACCT (AC current trans) on the outdoor noise filter circuit board (WM85Y,WM112Y)</li> <li>⑤ Defective input current detection circuit in outdoor power circuit board</li> <li>⑥ Defective outdoor controller circuit board</li> </ol>	<ol style="list-style-type: none"> <li>① Check the field facility for the power supply. (WM85Y,WM112Y)</li> <li>② Check the wiring between TB1 and outdoor noise filter circuit board. (WM85Y,WM112Y)</li> <li>③ Check CN5/CNCT wiring. (WM85Y,WM112Y)</li> <li>④ Replace outdoor noise filter circuit board. (WM85Y,WM112Y)</li> <li>⑤ Replace outdoor power circuit board.</li> <li>⑥ Replace outdoor controller circuit board.</li> </ol>
	08	<b>Abnormal power synchronous signal</b> • No input of power synchronous signal to power circuit board • Power synchronous signal of 44 Hz or less, or 65 Hz or more is detected on power circuit board.	<ol style="list-style-type: none"> <li>① Distortion of power source voltage, noise superimposition.</li> <li>② Disconnection or loose connection of earth wiring</li> <li>③ Disconnection or loose connection of CN2 on the outdoor power circuit board /controller circuit board</li> <li>④ Defective power synchronous signal circuit in outdoor controller circuit board</li> <li>⑤ Defective power synchronous signal circuit in outdoor power circuit board</li> </ol>	<ol style="list-style-type: none"> <li>① Check the field facility for the power supply.</li> <li>② Check earth wiring.</li> <li>③ Check CN2 wiring.</li> <li>④ Replace outdoor controller circuit board.</li> <li>⑤ Replace outdoor power circuit board.</li> </ol>

Continue to the next page

Continued from the previous page.

Check code	Abnormal points and detection method	Cause	judgment and action	
U9 (4220)	Detailed codes	<b>PFC error (Overvoltage/Undervoltage/Overcurrent)</b> • PFC detected any of the following a) Increase of DC bus voltage to 430 V. (Without WM50V) b) Decrease in PFC control voltage to 12 V DC or lower c) Increase in input current (WM50V,WM60V,WM85V, WM112V only)	① Abnormal increase in power source voltage ② Decrease in power source voltage, instantaneous stop ③ Disconnection of compressor wiring ④ Misconnection of reactor (DCL1-3:WM60V, WM85V, WM112V only)(DCL:WM50V only) ⑤ Defective outdoor power circuit board ⑥ Defective reactor (DCL1-3:WM60V, WM85V, WM112V only)(DCL:WM50V only) ⑦ Disconnection or loose connection of CN2 on the outdoor power circuit board/controller circuit board	①② Check the field facility for the power supply. ③ Correct the wiring (U•V•W phase) to compressor. Refer to "9-6. TEST POINT DIAGRAM". (Outdoor power circuit board). ④ Correct the wiring of reactor (DCL1-3:WM60V, WM85V, WM112V only)(DCL:WM50V only) ⑤ Replace outdoor power circuit board. ⑥ Replace reactor (DCL1-3:WM60V, WM85V, WM112V only)(DCL:WM50V only) ⑦ Check CN2 wiring.
	10			
	20	<b>PFC/IGBT error (Undervoltage)</b> • When Compressor is running, DC bus voltage stays at 310 V or lower for consecutive 10 seconds (WM50V,WM60V,WM85V, WM112V only)	① Incorrect switch settings on the outdoor controller circuit board for model select ② Defective outdoor power circuit board ③ Defective outdoor controller circuit board	① Correction of a model select ② Replace outdoor power circuit board. ③ Replace outdoor controller circuit board.
Ud (1504)	<b>Overheat protection</b> Abnormal if TH3, condensing temperature T <sub>63HS</sub> detects 70°C or more during compressor operation. TH3: Thermistor <Liquid>	① Defective outdoor fan (fan motor) or short cycle of outdoor unit during cooling operation ② Defective TH3, condensing temperature T <sub>63HS</sub> ③ Defective outdoor controller board	① Check outdoor unit air passage. ②③ Turn the power off and on again to check the check code. If U4 is displayed, follow the U4 processing direction.	
UE (1509)	<b>Abnormal pressure of 63HS</b> Abnormal if 63HS detects 0.1 MPa or less. Detection is inoperative for 3 minutes after compressor starting and 3 minutes after and during defrosting. 63HS: Pressure sensor	① Disconnection or contact failure of connector (63HS) on the outdoor controller circuit board ② Defective pressure sensor ③ Defective outdoor controller circuit board	① Check connection of connector (63HS) on the outdoor controller circuit board. Check breaking of the lead wire for 63HS. ② Check pressure by microprocessor. (Pressure sensor/ 63HS) (SW2: Refer to "9-7. FUNCTION OF SWITCHES, CONNECTORS AND JUMPERS".) ③ Replace outdoor controller board.	
UF (4100)	<b>Compressor overcurrent interruption (When compressor locked)</b> Abnormal if overcurrent of DC bus or compressor is detected within 30 seconds after compressor starts operating.	① Decrease of power supply voltage ② Looseness, disconnection or reverse of compressor wiring connection ③ Defective compressor ④ Defective outdoor power board	① Check facility of power supply. ② Correct the wiring (U•V•W phase) to compressor. Refer to "9-6.TEST POINT DIAGRAM". (Outdoor power circuit board). ③ Check compressor. Refer to "9-4. HOW TO CHECK THE PARTS". ④ Replace outdoor power circuit board.	
UH (5300)	<b>Current sensor error or input current error</b> • Abnormal if current sensor detects -1.0A to 1.0A during compressor operation. (This error is ignored in case of test run mode.) • Abnormal if 40A (WM50V,WM60V,WM85V, WM112V) of input current is detected or 37A (WM50V,WM60V,WM85V,WM112V) or more of input current is detected for 10 seconds continuously.	① Disconnection of compressor wiring ② Defective circuit of current sensor on outdoor power circuit board ③ Decrease of power supply voltage ④ Leakage or shortage of refrigerant	① Correct the wiring (U•V•W phase) to compressor. Refer to "9-6.TEST POINT DIAGRAM" (Outdoor power circuit board). ② Replace outdoor power circuit board. ③ Check the facility of power supply. ④ Check leakage of refrigerant.	



Check code	Abnormal points and detection method	Cause	Judgment and action
UL (1300)	<p><b>Low pressure</b> Abnormal if following conditions are detected after compressor starts heating operating for 3 minutes. TH33 - TH4 <math>\geq 20^{\circ}\text{C}</math> and TH33 <math>\geq 80^{\circ}\text{C}</math></p> <p>Thermistor TH33: Thermistor&lt;Comp. surface&gt; temperature TH4 : Thermistor &lt;Discharge&gt; temperature</p>	<p>① Leakage or shortage of refrigerant</p> <p>② Malfunction of linear expansion valve</p> <p>③ Clogging with foreign objects in refrigerant circuit</p> <p>④ Disconnection or contact failure of connector (63L) on outdoor controller board</p> <p>Note: If water enters in refrigerant circuit, clogging may occur where the part becomes below freezing point.</p>	<p>① Check intake superheat. Check leakage of refrigerant. Check additional refrigerant.</p> <p>② Check linear expansion valve. Refer to "10-6. HOW TO CHECK THE PARTS".</p> <p>③ After recovering refrigerant, remove water from entire refrigerant circuit under vacuum more than 1 hour.</p> <p>④ Check short wiring connected to connector (63L).</p>
UP (4210)	<p><b>Compressor overcurrent interruption</b> Abnormal if overcurrent DC bus or compressor is detected after compressor starts operating for 30 seconds.</p>	<p>① Decrease of power supply voltage</p> <p>② Looseness, disconnection or reverse of compressor wiring connection</p> <p>③ Defective fan of outdoor units</p> <p>④ Short cycle of outdoor units</p> <p>⑤ Defective input circuit of outdoor controller board</p> <p>⑦ Defective compressor</p> <p>⑧ Defective outdoor power circuit board</p> <p>⑨ DIP switch setting difference of outdoor controller circuit board</p>	<p>① Check facility of power supply.</p> <p>② Correct the wiring (U-V-W phase) to compressor. Refer to "9-6.TEST POINT DIAGRAM" (Outdoor power circuit board).</p> <p>③ Check indoor/outdoor fan.</p> <p>④ Solve short cycle.</p> <p>⑤ Replace outdoor controller circuit board. Note: Before the replacement of the outdoor controller circuit board, disconnect the wiring to compressor from the outdoor power circuit board and check the output voltage among phases, U, V, W, during test run. No defect on board if voltage among phases (U-V, V-W and W-U) is same. Make sure to perform the voltage check with same performing frequency.</p> <p>⑦ Check compressor. Refer to "9-4. HOW TO CHECK THE PARTS".</p> <p>⑧ Replace outdoor power circuit board.</p> <p>⑨ Check the DIP switch setting of outdoor controller circuit board.</p>
E0 or E4 (6831 or 6834)	<p><b>Remote controller transmission error (E0)/ signal receiving error (E4)</b></p> <p>① Abnormal if main remote controller cannot receive normally any transmission from indoor unit of refrigerant address "0" for 3 minutes. (Check code: E0)</p> <p>① Abnormal if indoor controller board cannot receive normally any data from remote controller board or from other indoor controller board for 3 minutes. (Check code: E4)</p> <p>② Indoor controller board cannot receive any signal from remote controller for 2 minutes. (Check code: E4)</p>	<p>① Contact failure at transmission wire of remote controller</p> <p>② Miswiring of remote controller</p> <p>③ Defective transmitting receiving circuit of remote controller</p> <p>④ Defective transmitting receiving circuit of indoor controller board of refrigerant address "0"</p> <p>⑤ Noise has entered into the transmission wire of remote controller.</p>	<p>① Check disconnection or looseness of indoor unit or transmission wire of remote controller.</p> <p>② Check wiring of remote controller. • Total wiring length: Max. 500 m (Do not use cable <math>\times 3</math> or more.) • The number of connecting indoor units: Max. 6 units • The number of connecting remote controller: Max. 1 unit</p> <p>If the cause of trouble is not in above ①-②, ③-⑤ Diagnose remote controller (PAC-IF011B-E only).</p> <p>a) When "RC OK" is displayed, Remote controllers have no problem. Turn the power off, and on again to check. If abnormality generates again, replace indoor controller board.</p> <p>b) When "RC NG" is displayed, Replace remote controller.</p> <p>c) When "RCE3" or "ERC00-66" is displayed, noise may be causing abnormality. Note: If the unit is not normal after replacing indoor controller board in group control, indoor controller board of address "0" may be abnormal. For the controllers other than PAC-IF011B-E, refer to Installation Manual or Service Handbook of the indoor unit.</p>



Check code	Abnormal points and detection method	Cause	Judgment and action
E1 or E2 (6201 or 6202)	<b>Remote controller control board</b> ① Abnormal if data cannot be normally read from the nonvolatile memory of the remote controller control board. (Check code: E1) ② Abnormal if the clock function of remote controller cannot be normally operated. (Check code: E2)	① Defective remote controller	① Replace remote controller.
E3 or E5 (6832 or 6833)	<b>Remote controller transmission error (E3)/ signal receiving error (E5)</b> ① Abnormal if remote controller could not find blank of transmission path for 6 seconds and could not transmit. (Check code: E3) ② Remote controller receives transmitted data at the same time, compares the data, and when detecting it, judges different data to be abnormal 30 continuous times. (Check code: E3)  ① Abnormal if indoor controller board could not find blank of transmission path. (Check code: E5) ② Indoor controller board receives transmitted data at the same time, compares the data, and when detecting it, judges different data to be abnormal 30 continuous times. (Check code: E5)	① Duplication of refrigerant address ② Defective transmitting receiving circuit of remote controller ③ Defective transmitting receiving circuit of indoor controller board ④ Noise has entered into transmission wire of remote controller.	① The address changes to a separate setting.  ②-④ Diagnose remote controller (PAC-IF011B-E only). a) When "RC OK" is displayed, remote controllers have no problem. Turn the power off, and on again to check. When becoming abnormal again, replace indoor controller board. b) When "RC NG" is displayed, replace remote controller. c) When "RC E3" or "ERC 00-66" is displayed, noise may be causing abnormality.  Note: For the controllers other than PAC-IF011B-E, refer to Installation Manual or Service Handbook of the indoor unit.
E8 (6840)	<b>Indoor/outdoor unit communication error (Signal receiving error) (Outdoor unit)</b> Abnormal if outdoor controller circuit board could not receive anything normally for 3 minutes.	① Contact failure of indoor/outdoor unit connecting wire ② Defective communication circuit of outdoor controller circuit board ③ Defective communication circuit of indoor controller board ④ Noise has entered into indoor/outdoor unit connecting wire.	① Check disconnection or looseness of indoor/outdoor unit connecting wire of indoor or outdoor units. ②-④ Turn the power off, and on again to check. Replace indoor controller board or outdoor controller circuit board if abnormality is displayed again.
E9 (6841)	<b>Indoor/outdoor unit communication error (Transmitting error) (Outdoor unit)</b> ① Abnormal if "0" receiving is detected 30 times continuously though outdoor controller circuit board has transmitted "1". ② Abnormal if outdoor controller circuit board could not find blank of transmission path for 3 minutes.	① Indoor/outdoor unit connecting wire has contact failure. ② Defective communication circuit of outdoor controller circuit board ③ Noise has entered power supply. ④ Noise has entered indoor/outdoor unit connecting wire.	① Check disconnection or looseness of indoor/outdoor unit connecting wire. ②-④ Turn the power off, and on again to check. Replace outdoor controller circuit board if abnormality is displayed again.
EF (6607 or 6608)	<b>Non defined check code</b> This code is displayed when non defined check code is received.	① Noise has entered transmission wire of remote controller. ② Noise has entered indoor/outdoor unit connecting wire. ③ Outdoor unit is not inverter models.	①② Turn the power off, and on again to check. Replace indoor controller board or outdoor controller circuit board if abnormality is displayed again. ③ Replace outdoor unit with inverter type outdoor unit.
Ed (0403)	<b>Serial communication error</b> ① Abnormal if serial communication between outdoor controller circuit board and outdoor power circuit board is defective.	① Breaking of wire or contact failure of connector CN2 between the outdoor controller circuit board and the outdoor power circuit board ② Breaking of wire or contact failure of connector CN4 between the outdoor controller circuit board and the outdoor power circuit board ③ Defective communication circuit of outdoor power circuit board ④ Defective communication circuit of outdoor controller circuit board for outdoor power circuit board	①② Check connection of each connector CN2 and CN4 between the outdoor controller circuit board and the outdoor power circuit board.  ③ Replace outdoor power circuit board. ④ Replace outdoor controller circuit board.

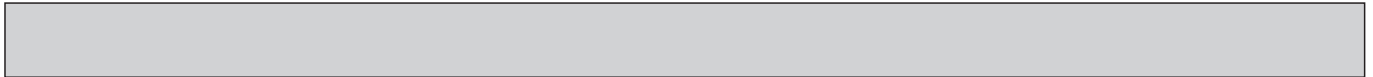


Check code	Abnormal points and detection method	Cause	judgment and action
P8	<p><b>Pipe temperature</b> Abnormal if the following conditions are detected for continuously 3 minutes after compressor starts operating for 10 minutes.</p> <p>1. Cooling mode TH6-TH7 <math>\leq</math> 2°C and TH3-TH7 <math>\leq</math> 4°C or TH6-TH3 &lt; 0°C and THW2(Indoor)-TH34 <math>\leq</math> 0°C and Compressor operation frequency is 61 Hz or more.</p> <p>2. Heating mode T<sub>63HS</sub>-THW2(Indoor) <math>\leq</math> 2°C and TH6-THW2(Indoor) <math>\leq</math> 1°C and TH7-TH3 <math>\leq</math> 1°C and Compressor operation frequency is 61 Hz or more.</p> <p>T<sub>63HS</sub>: Condensing temperature of pressure sensor (63HS) Thermistor TH3: Liquid temperature TH34: Plate HEX Liquid temperature TH7: Ambient temperature THW2(Indoor): Return water temp from Indoorunit thermistor</p>	<p>① Leakage or shortage of refrigerant</p> <p>② Malfunction of linear expansion valve</p> <p>③ Refrigerant circuit is clogged with foreign objects.</p> <p>Note: Clogging occurs in the parts which become below freezing point when water enters in refrigerant circuit.</p> <p>④ Disconnection of thermistor holder.</p>	<p>① Check intake superheat. Check leakage of refrigerant.</p> <p>② Check linear expansion valve.</p> <p>③ After recovering refrigerant, remove water from entire refrigerant circuit under vacuum more than 1 hour.</p> <p>④ Check temperature display on outdoor controller circuit board. Temperature display is indicated by setting SW2 of outdoor controller circuit board. Check the holder of thermistor.</p>
P6	<p><b>Freezing/overheating protection is working</b> (1) Freezing protection Plate HEX Liquid temperature(TH34) or refrigerant saturation temperature is 10 seconds smaller than the threshold.The threshold is dynamically calculated by inner operation using the operating time of the compressor and the water temperature.</p>	<p>(1) Freezing protection &lt;Cooling mode&gt;</p> <p>① Reduced water flow · Clogged filter · Leakage of water</p> <p>② Low temperature · Low-load · Inlet water is too cold.</p> <p>③ Defective water pump</p> <p>④ Defective outdoor fan control</p> <p>⑤ Leakage or shortage of refrigerant</p> <p>⑥ Defective refrigerant circuit (clogs)</p> <p>⑦ Malfunction of linear expansion valve</p> <p>&lt;Heating mode&gt;</p> <p>① Reduced water flow · Clogged filter · Leakage of water</p> <p>② Low temperature · Low-load · Inlet water is cold.</p> <p>③ Defective water pump</p> <p>④ Leakage or shortage of refrigerant</p> <p>⑤ Malfunction of linear expansion valve</p>	<p>(1) Freezing protection &lt;Cooling mode&gt;</p> <p>①② Check water piping.</p> <p>③ Check water pump.</p> <p>④ Check outdoor fan motor.</p> <p>⑤-⑦ Check operating condition of refrigerant circuit.</p> <p>⑦ Check linear expansion valve.</p> <p>&lt;Heating mode&gt;</p> <p>①② Check water piping.</p> <p>③ Check water pump.</p> <p>④ Correct to proper amount of refrigerant.</p> <p>⑤ Check linear expansion valve. Refer to "9-5. HOW TO CHECK THE COMPONENTS".</p>
PE	<p><b>Inlet water temperature</b> Abnormal if the following conditions are detected for continuously 10 seconds.</p> <p>1. Cooling mode During compressor operation THW2(Indoor) &lt; 3°C</p> <p>2. Heating mode (exclude defrosting) During compressor operation THW2(Indoor) &lt; -10°C</p> <p>3. Defrosting mode During compressor operation THW2(Indoor) &lt; 0°C</p> <p>Thermistor THW2(Indoor): Return water temp from Indoorunit thermistor</p>	<p>① Reduced water flow · Clogged filter · Leak of water</p> <p>② Low temperature · Low-load · Low temperature inlet water</p> <p>③ Defective water pump</p> <p>④ Leakage or shortage of refrigerant</p>	<p>①② Check water piping.</p> <p>③ Check water pump.</p> <p>④ Check intake superheat. Check leakage of refrigerant.</p>

### 9-3. TROUBLESHOOTING OF PROBLEMS

Phenomena	Factor	Countermeasure
1. Remote controller display does not work.	<p>① 12 V DC is not supplied to remote controller.</p> <p>② 12–15 V DC is supplied to remote controller, however, no display is indicated.</p> <ul style="list-style-type: none"> <li>• “PLEASE WAIT” is not displayed.</li> <li>• “PLEASE WAIT” is displayed.</li> </ul>	<p>① Check LED2 on indoor controller board.</p> <p>(1) When LED2 is lit. Check the remote controller wiring for breaking or contact failure.</p> <p>(2) When LED2 is blinking. Check short circuit of remote controller wiring.</p> <p>(3) When LED2 is not lit. Refer to No.3 below.</p> <p>② Check the following.</p> <ul style="list-style-type: none"> <li>• Failure of remote controller if “PLEASE WAIT” is not displayed</li> <li>• Refer to No.2 below if “PLEASE WAIT” is displayed.</li> </ul>
2. “PLEASE WAIT” display is remained on the remote controller.	<p>① At longest 2 minutes after the power supply “PLEASE WAIT” is displayed to start up.</p> <p>② Communication error between the remote controller and indoor unit</p> <p>③ Communication error between the indoor and outdoor unit</p> <p>④ Outdoor unit protection device connector is open.</p>	<p>① Normal operation</p> <p>② Self-diagnosis of remote controller</p> <p>③ “PLEASE WAIT” is displayed for 6 minutes at most in case of indoor/outdoor unit communication error. Check LED3 on indoor controller board.</p> <p>(1) When LED3 is not blinking. Check indoor/outdoor connecting wire for miswiring. (Reverse wiring of S1 and S2, or break of S3 wiring.)</p> <p>(2) When LED3 is blinking. Indoor/outdoor connecting wire is normal.</p> <p>④ Check LED display on outdoor controller circuit board. Refer to “9-6.TEST POINT DIAGRAM”. Check protection device connector (63L and 63H) for contact failure.</p>
3. When pressing the remote controller operation switch, the OPERATION display is appeared but it will be turned off soon.	<p>① After cancelling to select function from the remote controller, the remote controller operation switch will be not accepted for approx. 30 seconds.</p>	<p>① Normal operation</p>
4. Remote controller display works normally and the unit performs cooling operation, however, the capacity cannot be fully obtained.	<p>① Refrigerant shortage</p> <p>② Filter clogging</p>	<p>① If refrigerant leaks, discharging temperature rises and LEV opening increases. Inspect leakage by checking the temperature and opening. Check pipe connections for gas leakage.</p> <p>② Clean the filter of water piping.</p>
5. Remote controller display works normally and the unit performs heating operation, however, the capacity cannot be fully obtained.	<p>① Linear expansion valve fault Opening cannot be adjusted well due to linear expansion valve fault.</p> <p>② Refrigerant shortage</p> <p>③ Lack of insulation for refrigerant piping</p> <p>④ Filter clogging</p> <p>⑤ Bypass circuit of outdoor unit fault</p>	<p>① Discharging temperature and indoor heat exchanger temperature does not rise. Inspect the failure by checking discharging pressure. Replace linear expansion valve.</p> <p>② If refrigerant leaks, discharging temperature rises and LEV opening increases. Inspect leakage by checking the temperature and opening. Check pipe connections for gas leakage.</p> <p>③ Check the insulation.</p> <p>④ Clean the filter of water piping.</p> <p>⑤ Check refrigerant system during operation.</p>
6. ① For 3 minutes after temperature adjuster turns off, the compressor will not start operating even if temperature adjuster is turned on. ② For 3 minutes after temperature adjuster turns on, the compressor will not stop operating even if temperature adjuster is turned off. (Compressor stops operating immediately when turning off by the remote controller.)	<p>①② Normal operation (For protection of compressor)</p>	<p>①② Normal operation</p>





Phenomena	Factor	Countermeasure
7. A large amount of water is drained from the outdoor unit.	① Water is drained from PRV because of the pressure rise in water circuit. ② Water leakage due to the breakdown of PRV	① Check the below items following the indoor unit manual to suppress the pressure rise in water circuit. (1) Check the expansion tank. (2) Follow the trouble shooting when the water temperature rises abnormally ② Check the water pressure and flush with manual drainage water of PRV.
8. Compressor does not work after the breaker switched on.	Normal operation (For protection of compressor)	Start operating after 12 hours of power-on. (Refer to the Install manual.)

Phenomena	Countermeasure
A flowing water sound or occasional hissing sound is heard.	<ul style="list-style-type: none"> <li>These sounds can be heard when refrigerant and/or water is (are) flowing in the indoor unit or refrigerant pipe, or when the refrigerant and/or water is (are) chugging.</li> </ul>
Water does not heat or cool well.	<ul style="list-style-type: none"> <li>Clean the filter of water piping. (Flow is reduced when the filter is dirty or clogged.)</li> <li>Check the temperature adjustment and adjust the set temperature.</li> <li>Make sure that there is plenty of space around the outdoor unit.</li> </ul>
Water is dripping or vapour is emitted from the outdoor unit.	<ul style="list-style-type: none"> <li>During cooling mode, water may form and drip from the cool pipes and joints.</li> <li>During heating mode, water may form and drip from the heat exchanger of outdoor unit.</li> <li>During defrosting mode, water on the heat exchanger of outdoor unit evaporates and water vapour may be emitted.</li> </ul>
When restarting the outdoor unit soon after stopping it, it does not operate even though the ON/OFF button is pressed.	<ul style="list-style-type: none"> <li>Wait approximately 3 minutes. (Operation has stopped to protect the outdoor unit.)</li> </ul>
FTC operates without the ON/OFF button being pressed.	<ul style="list-style-type: none"> <li>Is the on timer set? Press the ON/OFF button to stop operation.</li> <li>Is the FTC connected to a external signal? Consult the concerned people who control the FTC.</li> <li>Does "☒" appear in the remote controller display? Consult the concerned people who control the FTC.</li> <li>Has the auto recovery feature from power failures been set? Press the ON/OFF button to stop operation.</li> </ul>
"PLEASE WAIT" appears in the remote controller display.	<ul style="list-style-type: none"> <li>The initial settings are being performed. Wait approximately 3 minutes.</li> <li>If the remote controller is not only for FTC, change it.</li> </ul>
A check code appears in the remote controller display.	<ul style="list-style-type: none"> <li>The protection devices have operated to protect the FTC and outdoor unit.</li> <li>Do not attempt to repair this equipment by yourself. Turn off the power switch immediately and consult your dealer. Be sure to provide the dealer with the model name and information that appeared in the remote controller display.</li> </ul>

• If the unit cannot be operated properly after test run, refer to the following table to find the cause.

Symptom		Cause
Wired remote controller		
PLEASE WAIT	For about 2 minutes after power-on	<ul style="list-style-type: none"> <li>For about 2 minutes following power-on, operation of the remote controller is not possible due to system startup. (Correct operation)</li> </ul>
PLEASE WAIT → Check code	Subsequent to about 2 minutes after power-on	<ul style="list-style-type: none"> <li>Connector for the outdoor unit's protection device is not connected.</li> <li>Reverse or open phase wiring for the outdoor unit's power terminal block (L1, L2, L3)</li> </ul>
Display messages do not appear even when operation switch is turned ON (operation lamp does not light up).		<ul style="list-style-type: none"> <li>Incorrect wiring between FTC and outdoor (incorrect polarity of S1, S2, S3)</li> <li>Remote controller wire short</li> </ul>

**Note: Operation is not possible for about 30 seconds after cancellation of function selection. (Correct operation)**

For description of each LED (LED1, 2, 3) provided on the FTC, refer to the following table.

LED1 (power for microprocessor)	Indicates whether control power is supplied. Make sure that this LED is always lit.
LED2 (power for remote controller)	Indicates whether power is supplied to the remote controller. This LED lights only in the case of the FTC which is connected to the outdoor unit refrigerant addresses "0".
LED3 (communication between FTC and outdoor units)	Indicates state of communication between the FTC and outdoor units. Make sure that this LED is always blinking.

**Symptoms: "PLEASE WAIT" is kept being displayed on the remote controller.**





Diagnosis flow	Cause	Inspection method and troubleshooting
<pre> graph TD     Start[Check the display time of "PLEASE WAIT" after turning on the main power.] --&gt; D1{How long is "PLEASE WAIT" kept being displayed on the remote controller?}     D1 -- "6 minutes or more" --&gt; C1[Check the LED display of the outdoor controller circuit board.]     D1 -- "2 to 6 minutes" --&gt; D2{Are any check codes displayed on the remote controller?}     D1 -- "2 minutes or less" --&gt; C2["PLEASE WAIT" will be displayed during the startup diagnosis after turning on the main power.]     D2 -- NO --&gt; C2     D2 -- YES --&gt; C3[Check the LED display of the outdoor controller circuit board.]     C1 --&gt; D3{Are any check codes displayed on the LED?}     D3 -- NO --&gt; C4["Defective indoor controller board&lt;br/&gt;Defective remote controller"]     D3 -- YES --&gt; C5["Miswiring of indoor/outdoor connecting wire&lt;br/&gt;Breaking of indoor/outdoor connecting wire (S3)&lt;br/&gt;Defective indoor controller board&lt;br/&gt;Defective outdoor controller circuit board"]     </pre>	<ul style="list-style-type: none"> <li>• "PLEASE WAIT" will be displayed during the startup diagnosis after turning on the main power.</li> <li>• Miswiring of indoor/outdoor connecting wire</li> <li>• Breaking of indoor/outdoor connecting wire (S3)</li> <li>• Defective indoor controller board</li> <li>• Defective outdoor controller circuit board</li> <li>• Defective indoor controller board</li> <li>• Defective remote controller</li> </ul>	<ul style="list-style-type: none"> <li>• Normal. The startup diagnosis will be over in around 2 minutes.</li> <li>• Refer to "Self-diagnosis action table" in order to solve the trouble.</li> <li>• In case of communication errors, the display of remote controller may not match the LED display of the outdoor unit.</li> </ul>

**Symptoms: Nothing is displayed on the remote controller. ①**

LED display of the indoor controller board  
 LED1 : ○  
 LED2 : ○  
 LED3 : ○

Diagnosis flow	Cause	Inspection method and troubleshooting
<pre>                     graph TD                         Start[Check the voltage between S1 and S2 on the terminal block of the indoor unit which is used to connect the indoor unit and the outdoor unit.] --&gt; D1{198 to 264 V AC?}                         D1 -- NO --&gt; S1[Check the voltage among L(L3) and N on the terminal block (TB1) of the outdoor power circuit board.]                         D1 -- YES --&gt; D2{198 to 264 V AC?}                         S1 --&gt; D2                         D2 -- NO --&gt; C1[• Troubles concerning power supply]                         D2 -- YES --&gt; S2[Check the voltage between S1 and S2 on the terminal block (TB1) of the outdoor unit which is used to connect the indoor unit and the outdoor unit.]                         S2 --&gt; D3{198 to 264 V AC?}                         D3 -- NO --&gt; C2[• Bad wiring of the outdoor controller board • The fuses on the outdoor controller circuit board are blown.]                         D3 -- YES --&gt; C3[• Bad wiring of the outdoor controller board • The fuses on the outdoor controller circuit board are blown.]                         D4{198 to 264 V AC?}                         Start --&gt; D4                         D4 --&gt; C4[• The fuses on the indoor controller circuit board are blown. • Defective indoor controller board]                     </pre>	<ul style="list-style-type: none"> <li>• Troubles concerning power supply</li> <li>• Bad wiring of the outdoor controller board</li> <li>• The fuses on the outdoor controller circuit board are blown.</li> <li>• Bad wiring of the outdoor controller board</li> <li>• The fuses on the outdoor controller circuit board are blown.</li> <li>• The fuses on the indoor controller circuit board are blown.</li> <li>• Defective indoor controller board</li> </ul>	<ul style="list-style-type: none"> <li>• Check the power wiring to the outdoor unit.</li> <li>• Check the breaker.</li> <li>• Check the wiring of the outdoor unit.</li> <li>• Check if the wiring is bad. Check if the fuses are blown. The fuses on the outdoor controller circuit board will be blown when the indoor /outdoor connecting wire short-circuits.</li> <li>• Check if miswiring, breaking or poor contact is causing this problem. Indoor/outdoor connecting wire is polarized 3-core type. Connect the indoor unit and the outdoor unit by wiring each pair of S1, S2 and S3 on the both side of indoor/outdoor terminal blocks.</li> <li>• Check if the fuses are blown.</li> <li>• Replace the indoor controller board.</li> </ul>



<b>Symptoms: Nothing is displayed on the remote controller. ②</b>	LED display of the indoor controller board LED1 :  LED2 :  LED3 :  or 
-------------------------------------------------------------------	-----------------------------------------------------------------------------------------------------------------------------------------------------------------------------------------------------------------------------------------------------------------------------------------------------------------------------------------------------------------------------------------------------------------------------

Diagnosis flow	Cause	Inspection method and troubleshooting
<p>Check the voltage between S1 and S2 on the terminal block of the indoor unit which is used to connect the indoor unit and the outdoor unit.</p> <p>198 to 264 V AC?</p> <p>NO → [Check the looseness or disconnection of the indoor/outdoor connecting wire.] → Are there looseness or disconnection of the indoor/outdoor connecting wire?</p> <p>YES → Check the status of the indoor controller board LED3 display.</p> <p>Not lighting. → [Check the looseness or disconnection of the indoor/outdoor connecting wire.] → Are there looseness or disconnection of the indoor/outdoor connecting wire?</p> <p>Blinking. → [Check the refrigerant address of the outdoor unit. (SW1-3 to 1-6)] → Is the refrigerant address "0"?</p> <p>NO → [Check the LED display of the outdoor unit after turning on the main power again.] → Is anything displayed?</p> <p>YES → [Check the LED display of the outdoor unit after turning on the main power again.] → Is anything displayed?</p> <p>Not displayed. → [Check the LED display of the outdoor unit after turning on the main power again.] → Is anything displayed?</p> <p>Displayed. → Is "EA" or "Eb" displayed?</p> <p>NO → [Check the LED display of the outdoor unit after turning on the main power again.] → Is anything displayed?</p> <p>YES → Is "E8" displayed?</p> <p>YES → [Check the LED display of the outdoor unit after turning on the main power again.] → Is anything displayed?</p> <p>NO → Can the unit be restarted?</p> <p>Can all the indoor unit be operated?</p> <p>NO → [Check the voltage between S2 and S3 on the terminal block of the outdoor unit.] → 17 to 28 V DC?</p> <p>YES → [Check the voltage between S2 and S3 on the terminal block of the outdoor unit.] → 17 to 28 V DC?</p> <p>NO → [Check the voltage between S2 and S3 on the terminal block of the outdoor unit.] → 17 to 28 V DC?</p> <p>YES → [Check the voltage between S2 and S3 on the terminal block of the outdoor unit.] → 17 to 28 V DC?</p>	<ul style="list-style-type: none"> <li>• Breaking or poor contact of the indoor/outdoor connecting wire</li> <li>• Normal Only the unit which has the refrigerant address "0" supplies power to the remote controller</li> <li>• Defective outdoor controller circuit board</li> <li>• Defective outdoor controller circuit board</li> <li>• Defective indoor controller board</li> <li>• Influence of electromagnetic noise</li> <li>• Defective outdoor power circuit board</li> <li>• Defective indoor power board</li> </ul>	<ul style="list-style-type: none"> <li>• Fix the breaking or poor contact of the indoor/outdoor connecting wire.</li> <li>• Set the refrigerant address to "0". In case of the multiple outdoor units control, recheck the refrigerant address again.</li> <li>• Replace the outdoor controller circuit board.</li> <li>• Replace the outdoor controller circuit board.</li> <li>• Replace the indoor controller board of the indoor unit which does not operate.</li> <li>• Not abnormal. There may be the influence of electromagnetic noise. Check the transmission wire and get rid of the causes.</li> <li>• Replace the outdoor power circuit board.</li> <li>• Replace the indoor power board.</li> </ul>

**Symptoms: Nothing is displayed on the remote controller. ③**

LED display of the indoor controller board  
 LED1 : ●  
 LED2 : ● or ●  
 LED3 : —

Diagnosis flow	Cause	Inspection method and troubleshooting
<pre> graph TD     A[Check the voltage of the terminal block (TB6) of the remote controller.] --&gt; B{10 to 16 V DC?}     B -- YES --&gt; C[Defective remote controller]     B -- NO --&gt; D{Check the status of the LED2.}     D -- Lighting --&gt; E[Breaking or poor contact of the remote controller wire]     D -- Blinking --&gt; F[Check the status of the LED2 after disconnecting the remote controller wire from the indoor unit.]     F --&gt; G{Check the status of the LED2.}     G -- Lighting --&gt; H[The remote controller wire short-circuits]     G -- Blinking --&gt; I[Defective indoor controller board]     </pre>	<ul style="list-style-type: none"> <li>• Defective remote controller</li> <li>• Breaking or poor contact of the remote controller wire</li> <li>• The remote controller wire short-circuits</li> <li>• Defective indoor controller board</li> </ul>	<ul style="list-style-type: none"> <li>• Replace the remote controller.</li> <li>• Check if there is breaking or poor contact of the remote controller wire. Check the voltage of the remote controller wire. If it is not between 10 and 16 V DC, the indoor controller board must be defective.</li> <li>• Check if the remote controller wire is short-circuited.</li> <li>• Replace the indoor controller board.</li> </ul>

## 9-4. HOW TO CHECK THE PARTS

PUZ-WM50VHA.UK

PUZ-WM60VAA.UK

PUZ-WM85VAA.UK

PUZ-WM50VHA-BS.UK

PUZ-WM60VAA-BS.UK

PUZ-WM85VAA-BS.UK

PUZ-WM85YAA.UK

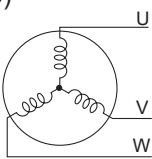
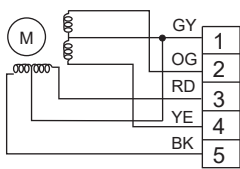
PUZ-WM112VAA.UK

PUZ-WM112YAA.UK

PUZ-WM85YAA-BS.UK

PUZ-WM112VAA-BS.UK

PUZ-WM112YAA-BS.UK

Parts name	Check points														
Thermistor (TH3) <Liquid> Thermistor (TH4) <Discharge> Thermistor (TH6) <Two-phase pipe> Thermistor (TH7) <Ambient> Thermistor (TH8) <Heat sink> Thermistor (TH33) <Comp. surface> Thermistor (TH34) <Plate hex liquid>	Disconnect the connector then measure the resistance with a tester. (At the ambient temperature 10 to 30°C) <table border="1" style="margin-top: 10px;"> <thead> <tr> <th></th> <th>Normal</th> <th>Abnormal</th> </tr> </thead> <tbody> <tr> <td>TH4 TH33</td> <td>160 to 410 kΩ</td> <td rowspan="3">Open or short</td> </tr> <tr> <td>TH3 TH6 TH7 TH34</td> <td>4.3 to 9.6 kΩ</td> </tr> <tr> <td>TH8</td> <td>39 to 105 kΩ</td> </tr> </tbody> </table>		Normal	Abnormal	TH4 TH33	160 to 410 kΩ	Open or short	TH3 TH6 TH7 TH34	4.3 to 9.6 kΩ	TH8	39 to 105 kΩ				
	Normal	Abnormal													
TH4 TH33	160 to 410 kΩ	Open or short													
TH3 TH6 TH7 TH34	4.3 to 9.6 kΩ														
TH8	39 to 105 kΩ														
Fan motor (MF1)	Refer to the next page.														
Solenoid valve coil <4-way valve> (21S4)	Measure the resistance between the terminals with a tester. (At the ambient temperature 20°C) <table border="1" style="margin-top: 10px;"> <thead> <tr> <th colspan="2">Normal</th> <th>Abnormal</th> </tr> <tr> <th>WM50</th> <th>WM60-112</th> <th rowspan="2">Open or short</th> </tr> </thead> <tbody> <tr> <td>1725 ± 173 Ω</td> <td>1435 ± 150 Ω</td> </tr> </tbody> </table>	Normal		Abnormal	WM50	WM60-112	Open or short	1725 ± 173 Ω	1435 ± 150 Ω						
Normal		Abnormal													
WM50	WM60-112	Open or short													
1725 ± 173 Ω	1435 ± 150 Ω														
Motor for compressor (MC) 	Measure the resistance between the terminals with a tester. (Winding temperature 20°C) <table border="1" style="margin-top: 10px;"> <thead> <tr> <th>WM50VHA</th> <th>WM60VAA</th> <th>WM85VAA</th> <th>WM85YAA</th> <th>WM112VAA</th> <th>WM112YAA</th> <th>Abnormal</th> </tr> </thead> <tbody> <tr> <td>0.98 Ω</td> <td>0.95 Ω</td> <td>0.95 Ω</td> <td>1.65 Ω</td> <td>0.74 Ω</td> <td>0.94 Ω</td> <td>Open or short</td> </tr> </tbody> </table>	WM50VHA	WM60VAA	WM85VAA	WM85YAA	WM112VAA	WM112YAA	Abnormal	0.98 Ω	0.95 Ω	0.95 Ω	1.65 Ω	0.74 Ω	0.94 Ω	Open or short
WM50VHA	WM60VAA	WM85VAA	WM85YAA	WM112VAA	WM112YAA	Abnormal									
0.98 Ω	0.95 Ω	0.95 Ω	1.65 Ω	0.74 Ω	0.94 Ω	Open or short									
Linear expansion valve (LEV-A/LEV-B) 	Disconnect the connector then measure the resistance with a tester. (Winding temperature 20°C) <table border="1" style="margin-top: 10px;"> <thead> <tr> <th colspan="4">Normal</th> <th>Abnormal</th> </tr> <tr> <th>Gray - Black</th> <th>Gray - Red</th> <th>Gray - Yellow</th> <th>Gray - Orange</th> <th rowspan="2">Open or short</th> </tr> </thead> <tbody> <tr> <td colspan="4" style="text-align: center;">46 ± 3Ω</td> </tr> </tbody> </table>	Normal				Abnormal	Gray - Black	Gray - Red	Gray - Yellow	Gray - Orange	Open or short	46 ± 3Ω			
Normal				Abnormal											
Gray - Black	Gray - Red	Gray - Yellow	Gray - Orange	Open or short											
46 ± 3Ω															

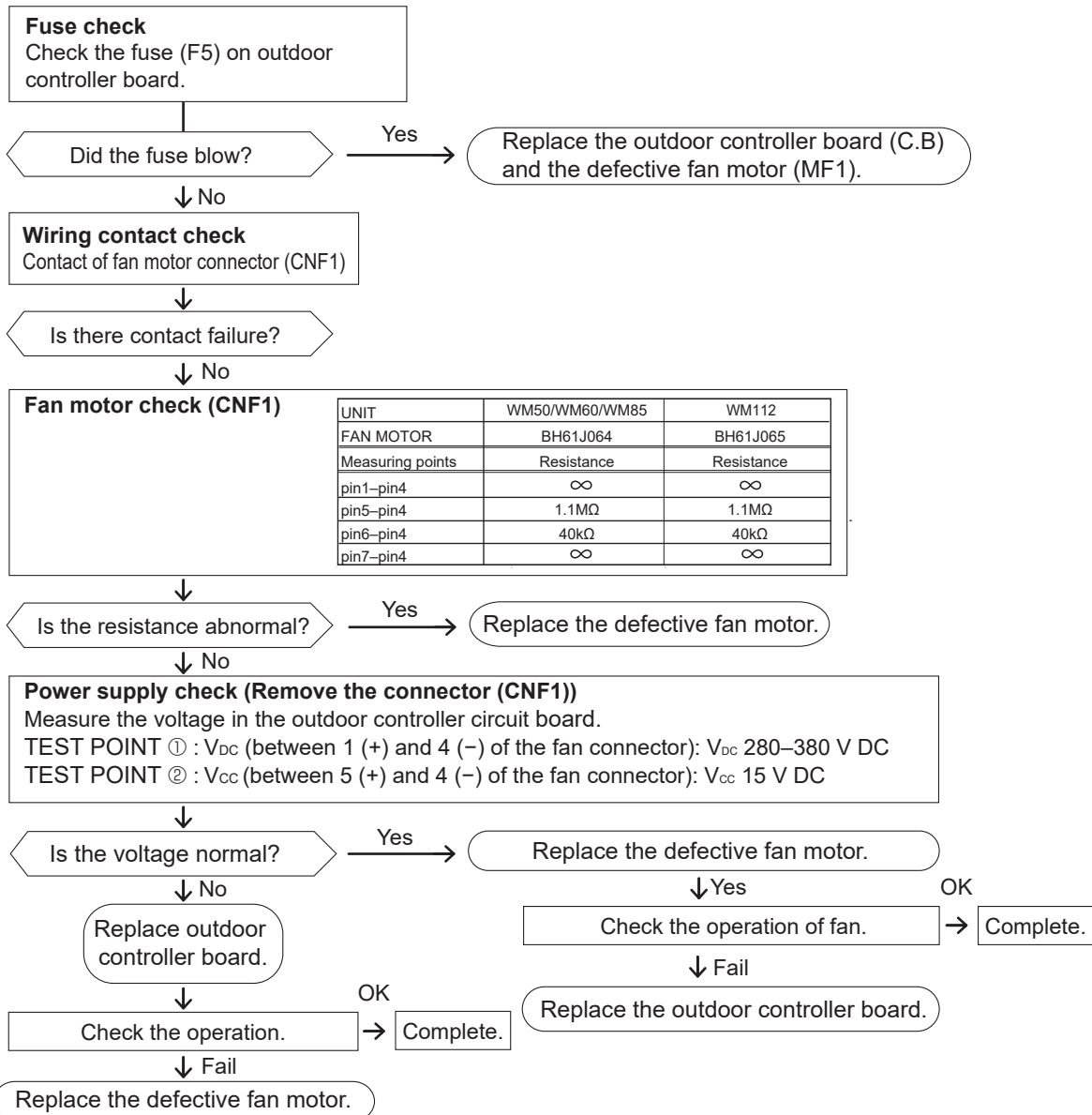
## Check method of DC fan motor (fan motor/outdoor controller circuit board)

### ① Notes

- High voltage is applied to the connector (CNF1) for the fan motor. Pay attention to the service.
- Do not pull out the connector (CNF1) for the motor with the power supply on.  
(It causes trouble of the outdoor controller circuit board and fan motor.)

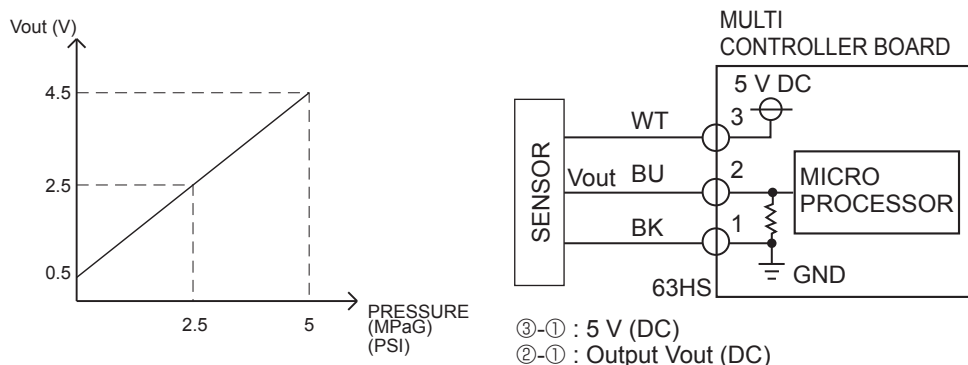
### ② Self check

Symptom: The outdoor fan cannot rotate.



## 9-5. HOW TO CHECK THE COMPONENTS

### <PRESSURE SENSOR>



**<Thermistor feature chart>**

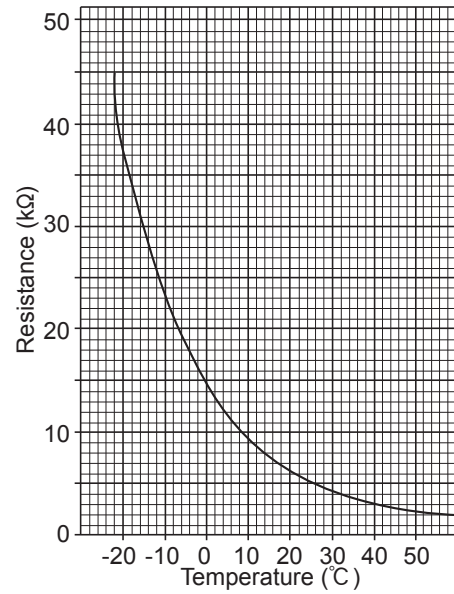
**Low temperature thermistors**

- Thermistor <Liquid> (TH3)
- Thermistor <Two-phase pipe> (TH6)
- Thermistor <Ambient> (TH7)
- Thermistor <Plate hex liquid>(TH34)

Thermistor R0 = 15 kΩ ± 3 %  
 B constant = 3480 ± 2 %

$$R_t = 15 \exp\left\{3480 \left( \frac{1}{273+t} - \frac{1}{273} \right)\right\}$$

0 °C	15 kΩ	30 °C	4.3 kΩ
10 °C	9.6 kΩ	40 °C	3.0 kΩ
20 °C	6.3 kΩ		
25 °C	5.2 kΩ		



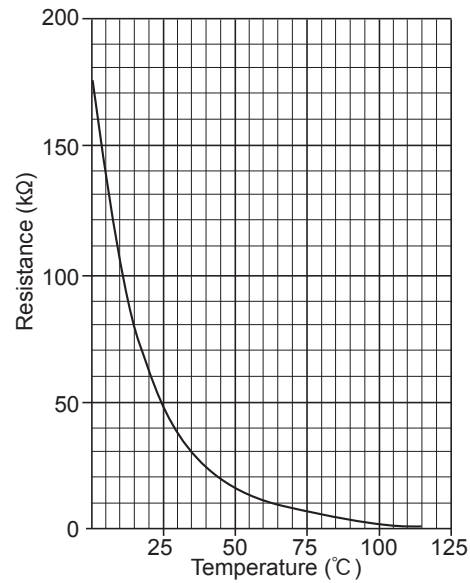
**Medium temperature thermistor**

- Thermistor <Heat sink> (TH8)

Thermistor R50 = 17 kΩ ± 2 %  
 B constant = 4150 ± 3 %

$$R_t = 17 \exp\left\{4150 \left( \frac{1}{273+t} - \frac{1}{323} \right)\right\}$$

0 °C	180 kΩ
25 °C	50 kΩ
50 °C	17 kΩ
70 °C	8 kΩ
90 °C	4 kΩ



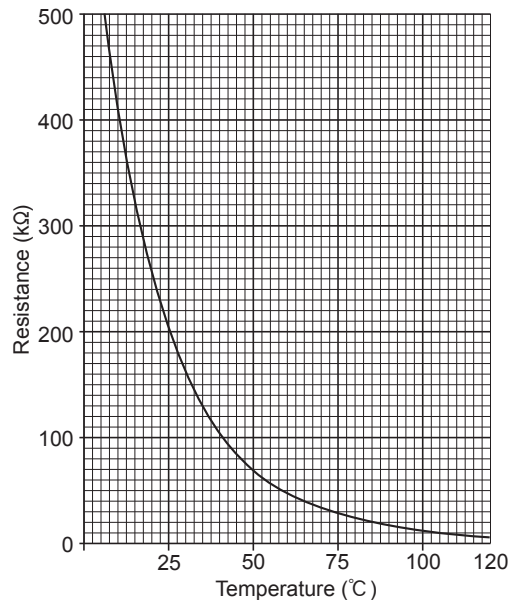
**High temperature thermistors**

- Thermistor <Discharge> (TH4)
- Thermistor <Comp. surface> (TH33)

Thermistor R120 = 7.465 kΩ ± 2 %  
 B constant = 4057 ± 2 %

$$R_t = 7.465 \exp\left\{4057 \left( \frac{1}{273+t} - \frac{1}{393} \right)\right\}$$

20 °C	250 kΩ	70 °C	34 kΩ
30 °C	160 kΩ	80 °C	24 kΩ
40 °C	104 kΩ	90 °C	17.5 kΩ
50 °C	70 kΩ	100 °C	13.0 kΩ
60 °C	48 kΩ	110 °C	9.8 kΩ



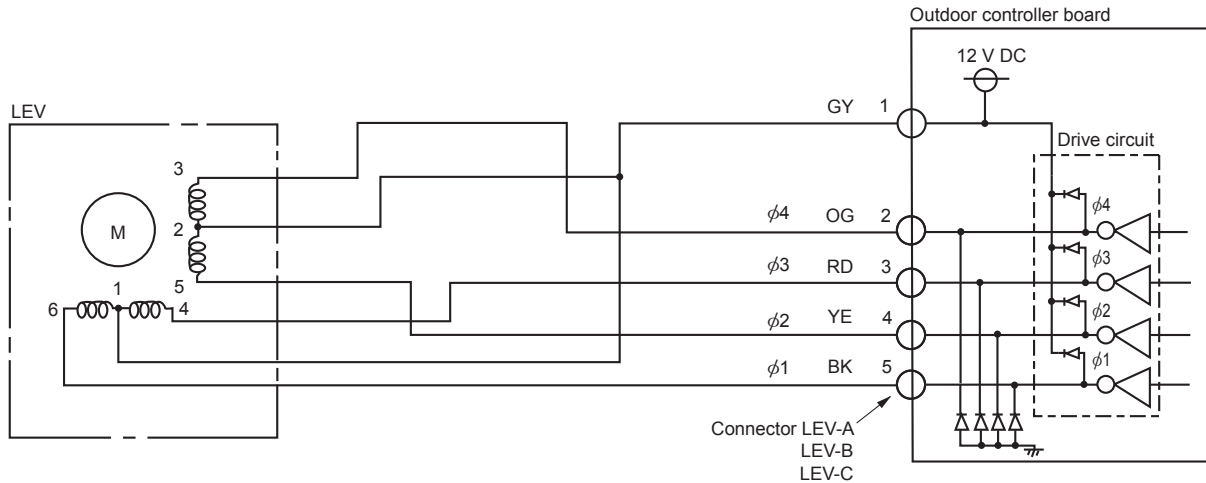


## Linear expansion valve

### (1) Operation summary of the linear expansion valve

- Linear expansion valve opens/closes through stepping motor after receiving the pulse signal from the outdoor controller board.
- Valve position can be changed in proportion to the number of pulse signal.

<Connection between the outdoor controller board and the linear expansion valve>



### <Output pulse signal and the valve operation>

Output (Phase)	Output							
	1	2	3	4	5	6	7	8
$\phi 1$	ON	ON	OFF	OFF	OFF	OFF	OFF	ON
$\phi 2$	OFF	ON	ON	ON	OFF	OFF	OFF	OFF
$\phi 3$	OFF	OFF	OFF	ON	ON	ON	OFF	OFF
$\phi 4$	OFF	OFF	OFF	OFF	OFF	ON	ON	ON

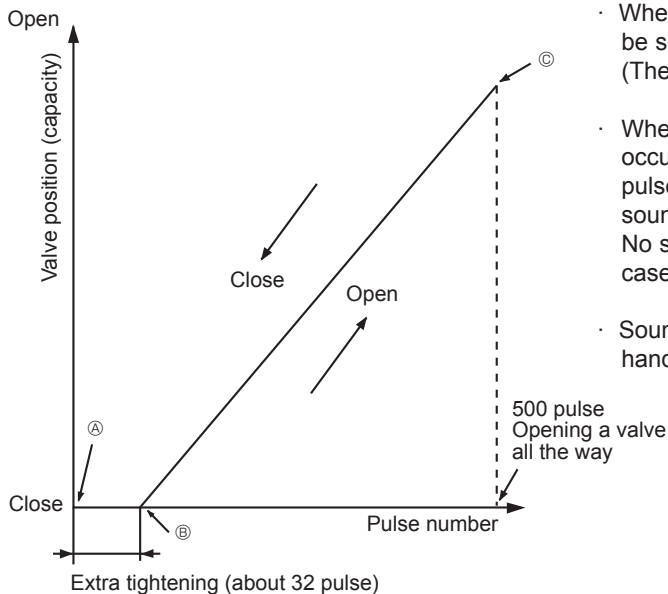
The output pulse shifts in below order.

Opening a valve : 8 → 7 → 6 → 5 → 4 → 3 → 2 → 1 → 8

Closing a valve : 1 → 2 → 3 → 4 → 5 → 6 → 7 → 8 → 1

- When linear expansion valve operation stops, all output phases become OFF.

### (2) Linear expansion valve operation

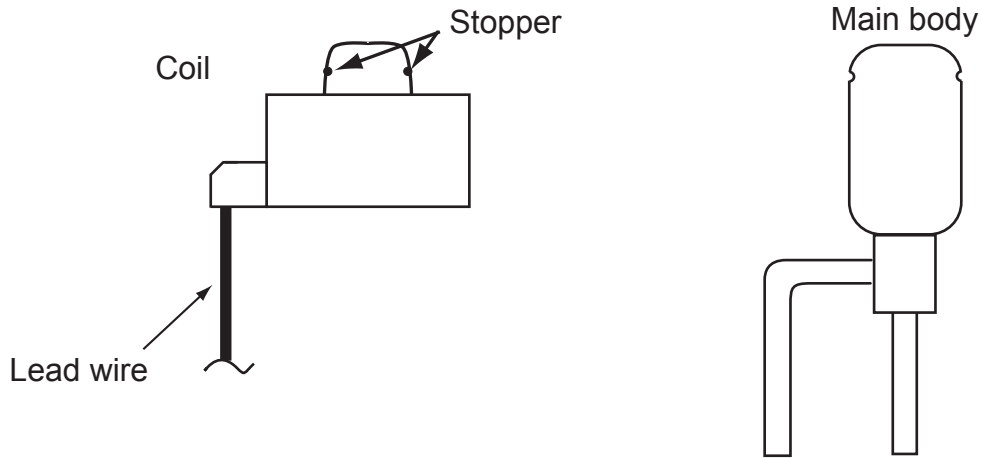


- When the power is turned on, 700 pulse closing valve signal will be sent till it goes to A point in order to define the valve position. (The pulse signal is being sent for about 20 seconds.)
- When the valve moves smoothly, there is no sound or vibration occurring from the linear expansion valve : however, when the pulse number moves from B to A or when the valve is locked, sound can be heard. No sound is heard when the pulse number moves from B to A in case coil is burnt out or motor is locked by open-phase.
- Sound can be detected by placing the ear against the screw driver handle while putting the screw driver to the linear expansion valve.

### (3) How to attach and detach the coil of linear expansion valve

<Composition>

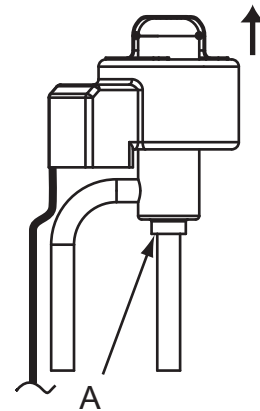
Linear expansion valve is separable into the main body and the coil as shown in the diagram below.



#### <How to detach the coil>

Hold the lower part of the main body (shown as A) firmly so that the main body does not move and detach the coil by pulling it upward.

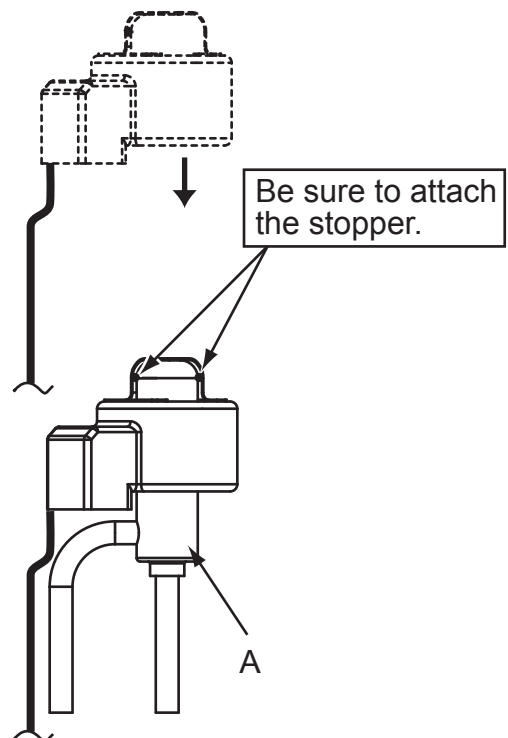
Be sure to detach the coil holding main body firmly. Otherwise pipes can bend due to stress.



#### <How to attach the coil>

Hold the lower part of the main body (shown as A) firmly so that the main body does not move and attach the coil by inserting it downward into the main body. Then securely attach the coil stopper to main body. (At this time, be careful that stress is not added to lead wire and main body is not wound by lead wire.) If the stopper is not firmly attached to main body, coil may be detached from the main body and that can cause defective operation of linear expansion valve.

To prevent piping stress, be sure to attach the coil holding the main body of linear expansion valve firmly. Otherwise pipe may break.



# 9-6. TEST POINT DIAGRAM

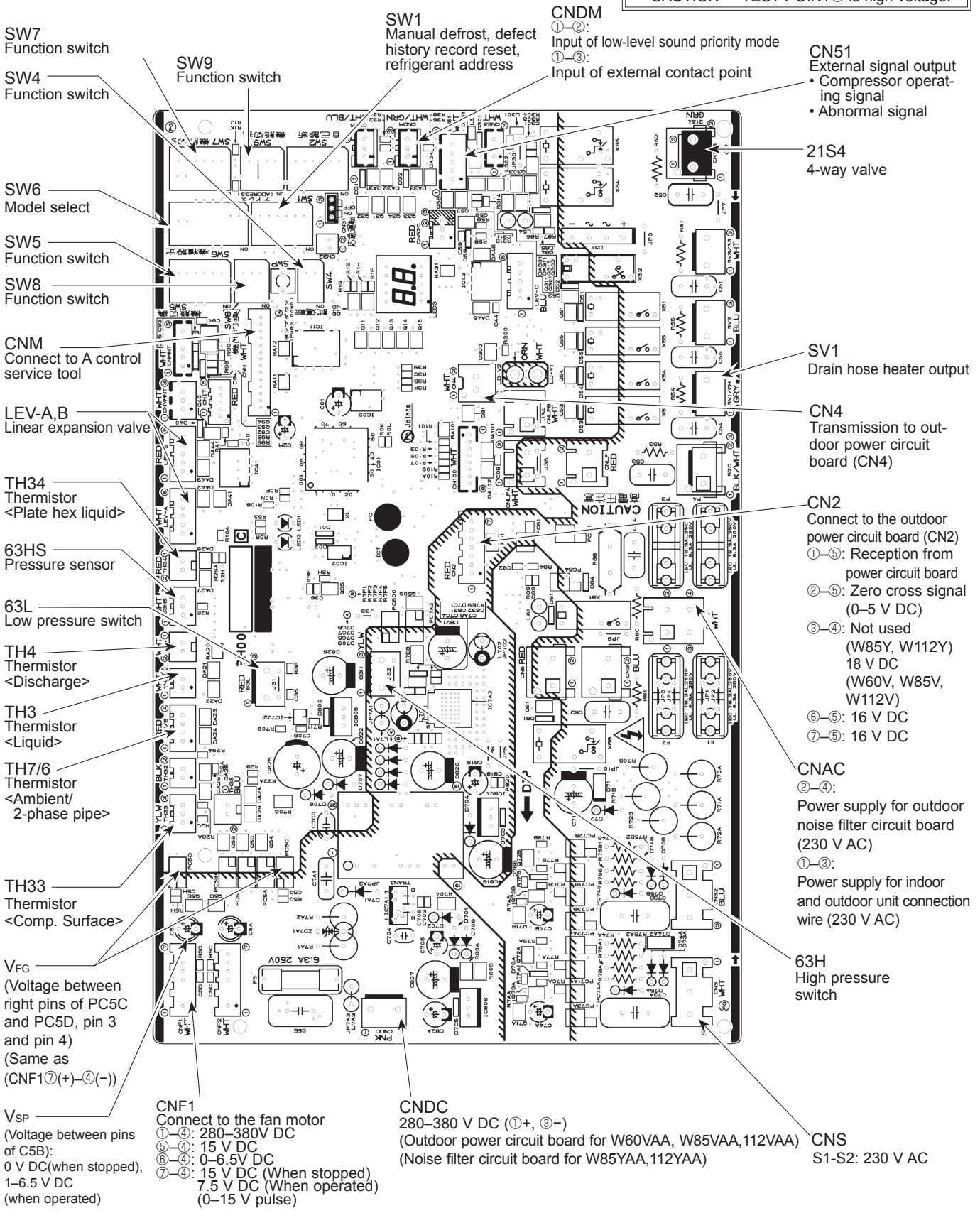
## Outdoor controller circuit board

PUZ-WM50VHA.UK  
 PUZ-WM50VHA-BS.UK  
 PUZ-WM85YAA.UK  
 PUZ-WM85YAA-BS.UK

PUZ-WM60VAA.UK  
 PUZ-WM60VAA-BS.UK  
 PUZ-WM112VAA.UK  
 PUZ-WM112VAA-BS.UK

PUZ-WM85VAA.UK  
 PUZ-WM85VAA-BS.UK  
 PUZ-WM112YAA.UK  
 PUZ-WM112YAA-BS.UK

<CAUTION> TEST POINT ① is high voltage.



SW7  
Function switch

SW4  
Function switch

SW6  
Model select

SW5  
Function switch

SW8  
Function switch

CNM  
Connect to A control service tool

LEV-A,B  
Linear expansion valve

TH34  
Thermistor  
<Plate hex liquid>

63HS  
Pressure sensor

63L  
Low pressure switch

TH4  
Thermistor  
<Discharge>

TH3  
Thermistor  
<Liquid>

TH7/6  
Thermistor  
<Ambient/  
2-phase pipe>

TH33  
Thermistor  
<Comp. Surface>

V<sub>FG</sub>  
(Voltage between right pins of PC5C and PC5D, pin 3 and pin 4)  
(Same as CNF1⑦(+)-④(-))

V<sub>SP</sub>  
(Voltage between pins of C5B):  
0 V DC (when stopped),  
1-6.5 V DC (when operated)

CNF1  
Connect to the fan motor  
①-④: 280-380V DC  
⑤-④: 15 V DC  
⑥-④: 0-6.5V DC  
⑦-④: 15 V DC (When stopped)  
7.5 V DC (When operated)  
(0-15 V pulse)

CNDC  
280-380 V DC (①+, ③-)  
(Outdoor power circuit board for W60VAA, W85VAA, 112VAA)  
(Noise filter circuit board for W85YAA, 112YAA)

SW1  
Manual defrost, defect history record reset, refrigerant address

CNDM  
①-②: Input of low-level sound priority mode  
①-③: Input of external contact point

CN51  
External signal output  
• Compressor operating signal  
• Abnormal signal

21S4  
4-way valve

SV1  
Drain hose heater output

CN4  
Transmission to outdoor power circuit board (CN4)

CN2  
Connect to the outdoor power circuit board (CN2)  
①-⑤: Reception from power circuit board  
②-⑤: Zero cross signal (0-5 V DC)  
③-④: Not used (W85Y, W112Y) 18 V DC (W60V, W85V, W112V)  
⑥-⑤: 16 V DC  
⑦-⑤: 16 V DC

CNAC  
②-④: Power supply for outdoor noise filter circuit board (230 V AC)  
①-③: Power supply for indoor and outdoor unit connection wire (230 V AC)

63H  
High pressure switch

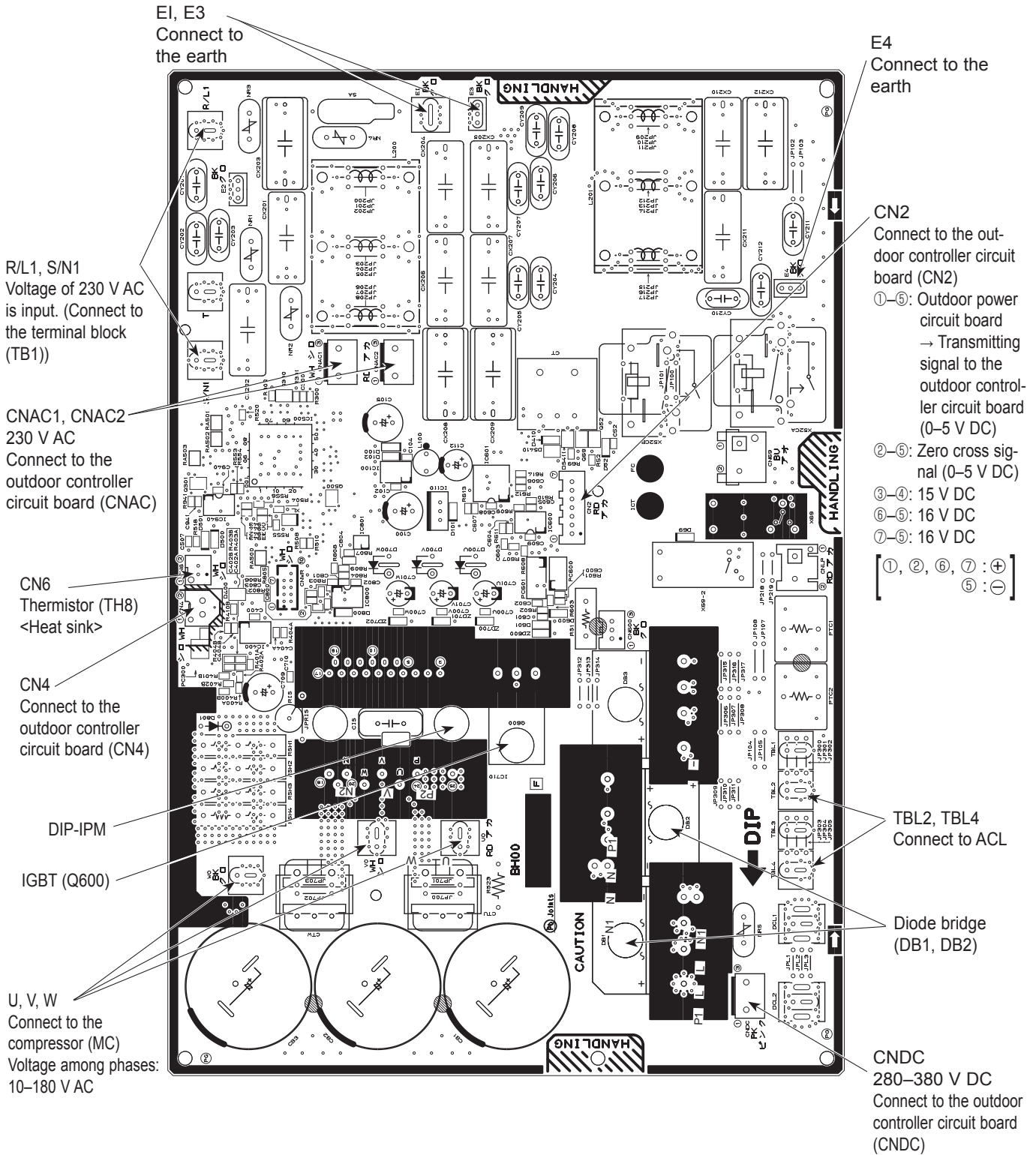
CNS  
S1-S2: 230 V AC

**Outdoor power circuit board**  
**PUZ-WM50VHA.UK**  
**PUZ-WM50VHA-BS.UK**

**Brief Check of POWER MODULE**

If they are short-circuited, it means that they are broken.  
 Measure the resistance in the following points (connectors, etc.).

1. Check of diode bridge  
 TABP1-TABS, TABN1-TABS, TABP1-TABT, TABN1-TABT
2. Check of DIP-IPM  
 P-U, P-V, P-W, N-U, N-V, N-W



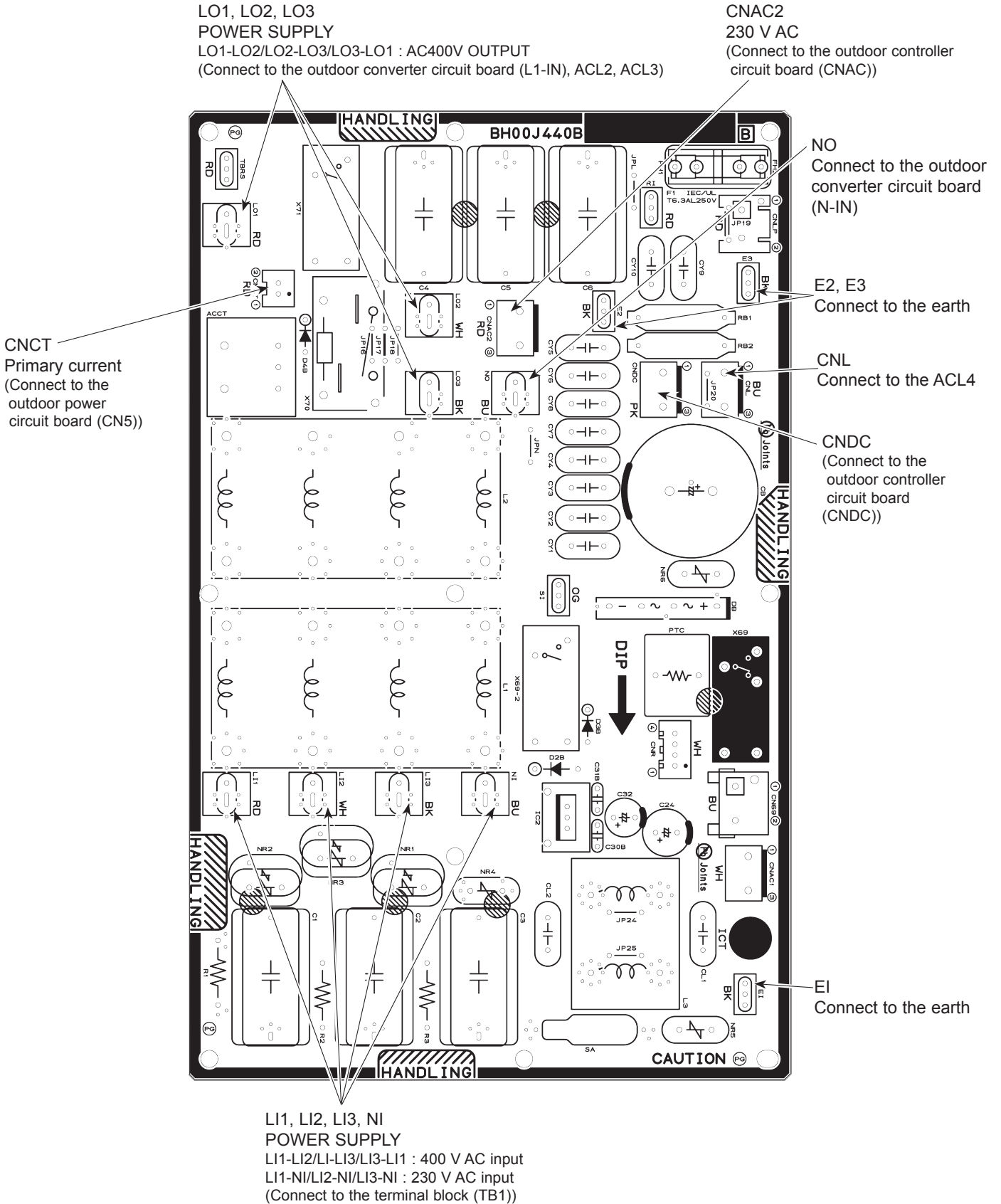
**Outdoor noise filter circuit board**

**PUZ-WM85YAA.UK**

**PUZ-WM112YAA.UK**

**PUZ-WM85YAA-BS.UK**

**PUZ-WM112YAA-BS.UK**



**Outdoor power circuit board**  
**PUZ-WM60VAA.UK**  
**PUZ-WM60VAA-BS.UK**  
**PUZ-WM85VAA.UK**  
**PUZ-WM85VAA-BS.UK**  
**PUZ-WM112VAA.UK**  
**PUZ-WM112VAA-BS.UK**

**Brief Check of DIP-IPM and DIODE MODULE**

If they are short-circuited, it means that they are broken.  
 Measure the resistance in the following points (connectors, etc.).

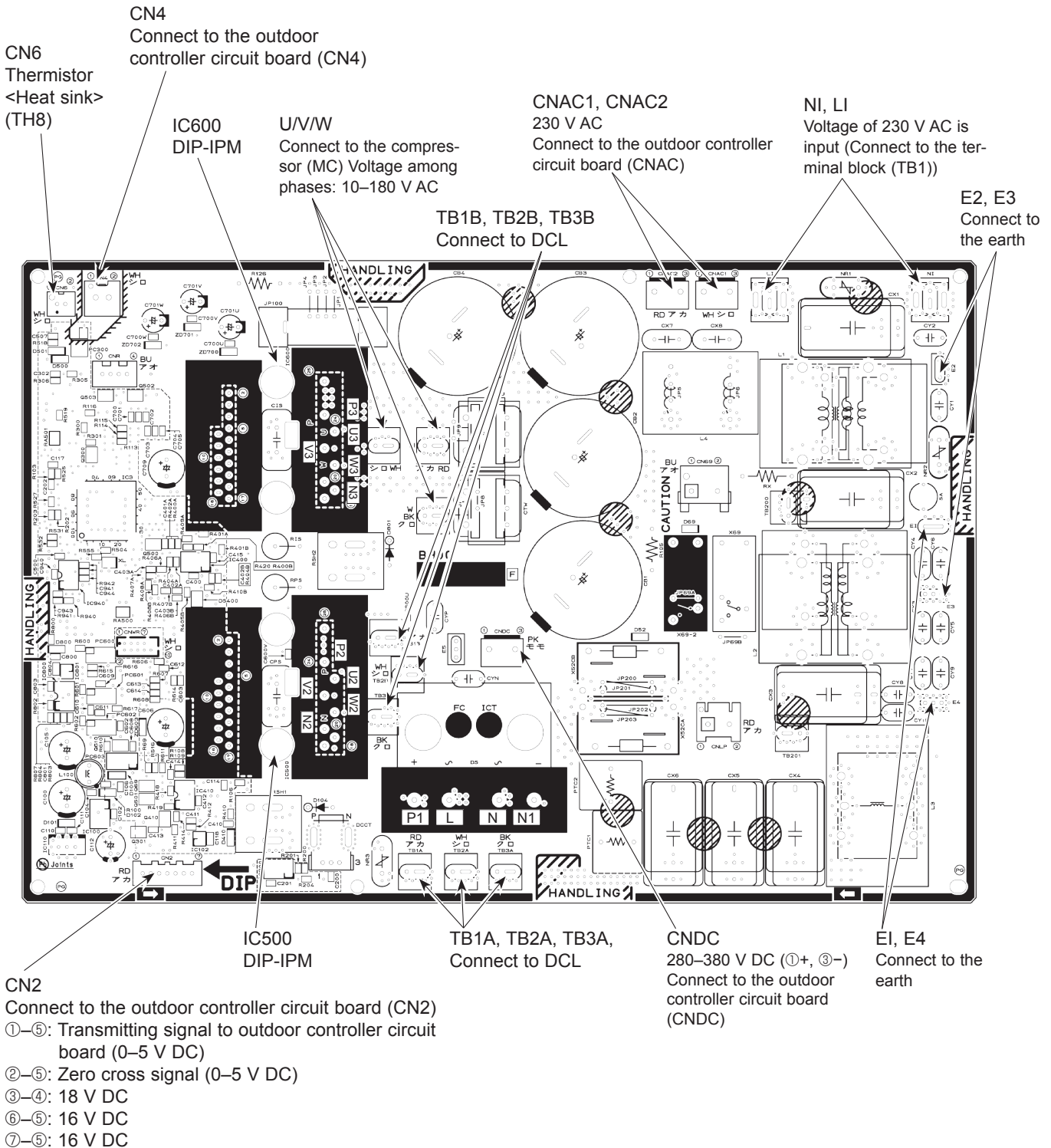
1. Check of DIP-IPM

P2 - U2, P2 - V2, P2 - W2, N2 - U2, N2 - V2, N2 - W2  
 P3 - U3, P3 - V3, P3 - W3, N3 - U3, N3 - V3, N3 - W3

2. Check of DIODE MODULE

P1 - L, P1 - N, L - N1, N - N1

Note: The marks, L, N, N1, N2, N3, P1, P2, P3, U2, U3, V2, V3, W2, and W3 shown in the diagram are not actually printed on the board.



**Outdoor power circuit board**  
**PUZ-WM85YAA.UK**  
**PUZ-WM85YAA-BS.UK**  
**PUZ-WM112YAA.UK**  
**PUZ-WM112YAA-BS.UK**

**Brief Check of POWER MODULE**

• If they are short-circuited, it means that they are broken.  
 Measure the resistance in the following points (connectors, etc.).

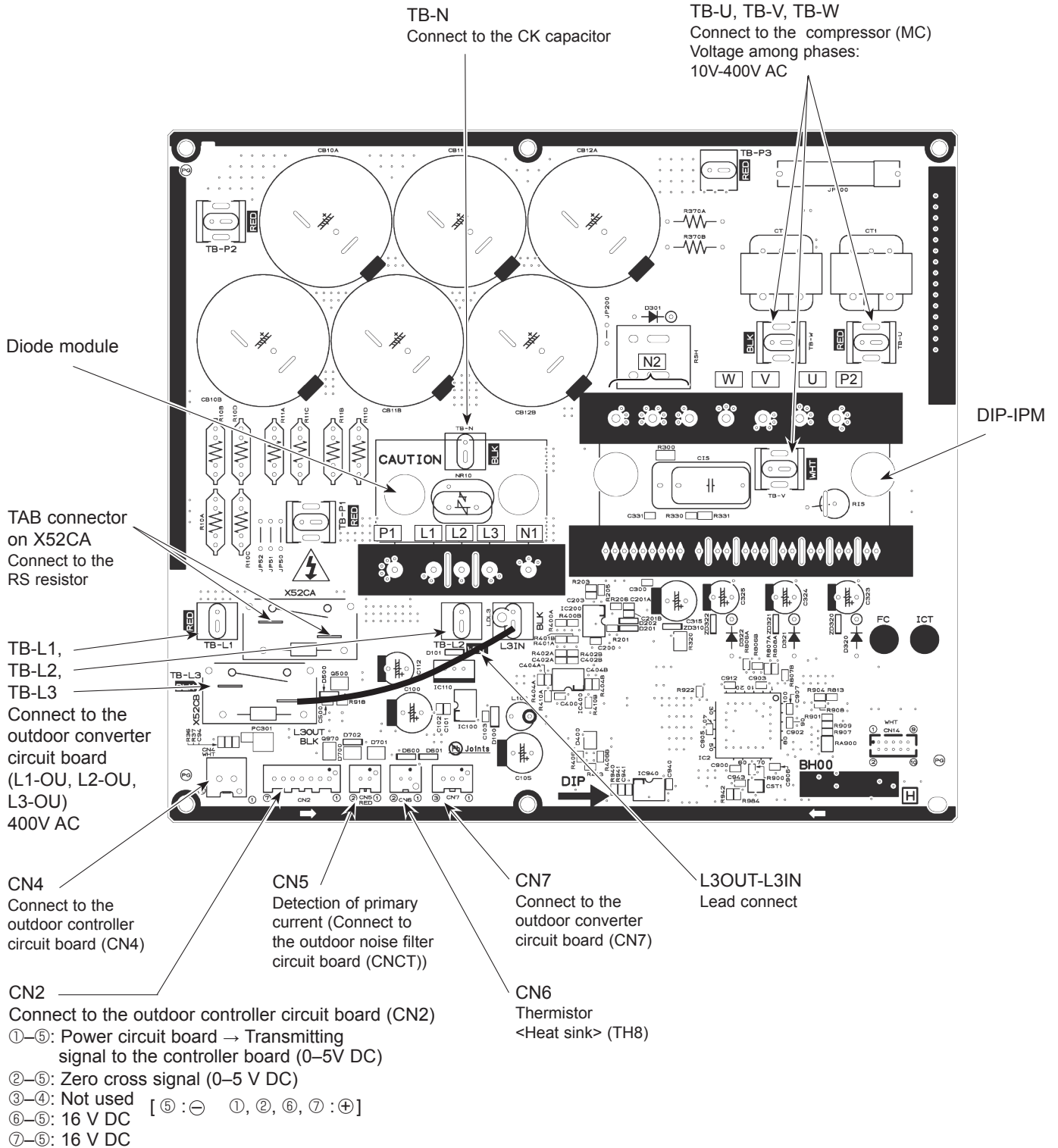
1. Check of DIODE MODULE

L1 - P1, L2 - P1, L3 - P1, L1 - N1, L2 - N1, L3 - N1

2. Check of DIP-IPM

P2 - U, P2 - V, P2 - W, N2 - U, N2 - V, N2 - W

Note: The marks L1, L2, L3, N1, N2, P1, P2, U, V and W shown in the diagram are not actually printed on the board.



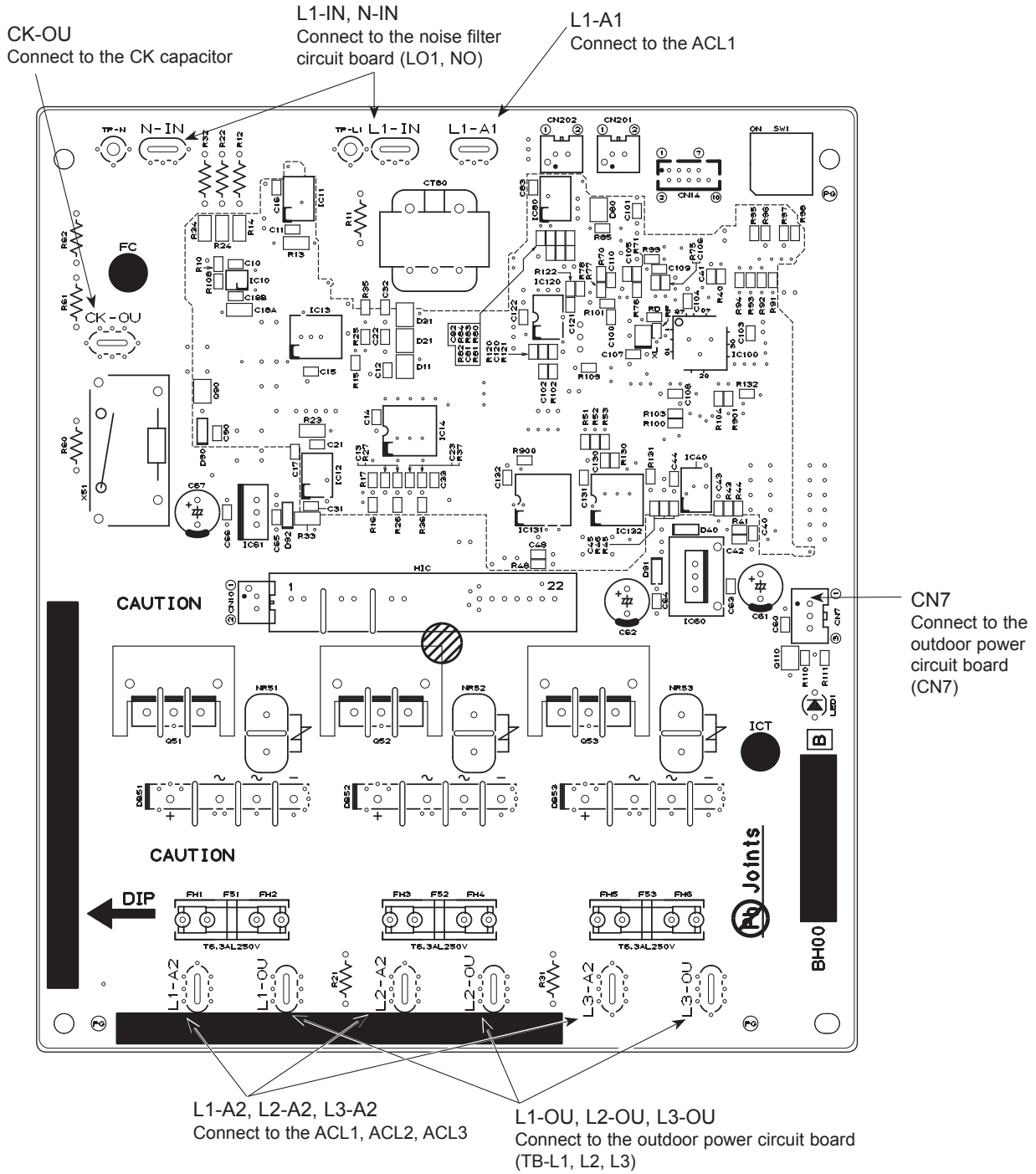
Outdoor converter circuit board

PUZ-WM85YAA.UK

PUZ-WM85YAA-BS.UK

PUZ-WM112YAA.UK

PUZ-WM112YAA-BS.UK





## 9-7. FUNCTION OF SWITCHES, CONNECTORS AND JUMPERS

### (1) Function of switches

PUZ-WM50VHA.UK

PUZ-WM60VAA.UK

PUZ-WM85VAA.UK

PUZ-WM50VHA-BS.UK

PUZ-WM60VAA-BS.UK

PUZ-WM85VAA-BS.UK

PUZ-WM85YAA.UK

PUZ-WM112VAA.UK

PUZ-WM112YAA.UK

PUZ-WM85YAA-BS.UK

PUZ-WM112VAA-BS.UK

PUZ-WM112YAA-BS.UK

The black square (■) indicates a switch position.

Type of Switch	Switch	No.	Function	Action by the switch operation		Effective timing
				ON	OFF	
DIP switch	SW1	1	Manual defrost *1	Start	Normal	When compressor is working in heating operation.*1
		2	Abnormal history clear	Clear	Normal	off or operating
		3	Refrigerant address setting			When power supply ON
		4				
		5				
		6				
	SW4	1	No function	—	—	—
		2	No function	—	—	—
	SW8	1	No function	—	—	—
		2	No function	—	—	—
		3	Separate indoor/outdoor unit power supplies	Used	Not used	When power supply ON
	SW5	1	No function	—	—	—
		2	Power failure automatic recovery*2	Auto recovery	No auto recovery	When power supply ON
		3,4,5,6	No function	—	—	—
	SW7*3	1,2,3	No function	—	—	—
		4	No function	—	—	—
		5	No function	—	—	—
		6	Defrost setting	For high humidity	Normal	Always
	SW9	1	No function	—	—	—
		2	No function	—	—	—
		3,4	No function	—	—	—
	SW6	1	Model select			
		2				
		3				
4						
5						
6						
7						
8						

\*1 Manual defrost should be done as follows.

① Change the DIP SW1-1 on the outdoor controller board from OFF to ON.

② Manual defrost will start by the above operation ① if all these conditions written below are satisfied.

- Heat mode setting
- 10 minutes have passed since compressor started operating or previous manual defrost finished.
- Pipe temperature is less than or equal to 8°C.

Manual defrost will finish if certain conditions have been satisfied.

Manual defrost can be done if above conditions have been satisfied when DIP SW1-1 is changed from OFF to ON.

After DIP SW1-1 is changed from OFF to ON, there is no problem if DIP SW1-1 is left ON or changed to OFF again. This depends on the service conditions.

\*2 "Power failure automatic recovery" can be set by either remote controller or this DIP SW. If one of them is set to ON, "Auto recovery" activates. Please set "Auto recovery" basically by remote controller because all units do not have DIP SW. Please refer to the indoor unit installation manual.

\*3 Please do not use SW7-3, 4, 6 usually. Trouble might be caused by the usage condition.

PUZ-WM50VHA.UK  
 PUZ-WM50VHA-BS.UK  
 PUZ-WM85YAA.UK  
 PUZ-WM85YAA-BS.UK

PUZ-WM60VAA.UK  
 PUZ-WM60VAA-BS.UK  
 PUZ-WM112VAA.UK  
 PUZ-WM112VAA-BS.UK

PUZ-WM85VAA.UK  
 PUZ-WM85VAA-BS.UK  
 PUZ-WM112YAA.UK  
 PUZ-WM112YAA-BS.UK

**<Display function of inspection for outdoor unit>**

The blinking patterns of both LED1 (green) and LED2 (red) indicate the types of abnormality when it occurs. Types of abnormality can be indicated in details by connecting an optional part "A-Control Service Tool (PAC-SK52ST)" to connector CNM on outdoor controller board.

[Display]

(1) Normal condition

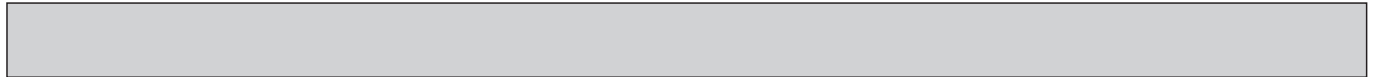
Unit condition	Outdoor controller board		A-Control Service Tool	
	LED1 (Green)	LED2 (Red)	Check code	Indication of the display
When the power is turned on	Lighted	Lighted	— ↔ —	Alternately blinking display
When unit stops	Lighted	Not lighted	00, etc.	Operation mode
When compressor is warming up	Lighted	Not lighted	08, etc.	
When unit operates	Lighted	Lighted	C5, H7, etc.	

(2) Abnormal condition

Indication		Error			Detailed reference page
Outdoor controller board	Contents	Check code*	Inspection method		
LED1 (Green)	LED2 (Red)				
1 blinking	2 blinking	Connector(63L) is open.	F3	①Check if connector (63H or 63L) on the outdoor controller board is not disconnected. ②Check continuity of pressure switch (63H or 63L) by tester.	**
		Connector(63H) is open.	F5		P.23
		2 connectors are open.	F9		**
2 blinking	1 blinking	Miswiring of indoor/outdoor unit connecting wire, excessive number of indoor units (4 units or more)	—	①Check if indoor/outdoor connecting wire is connected correctly. ②Check if 4 or more indoor units are connected to outdoor unit. ③Check if noise entered into indoor/outdoor connecting wire or power supply. ④Re-check error by turning off power, and on again.	P.24 (EA)
		Miswiring of indoor/outdoor unit connecting wire (converse wiring or disconnection)	—		P.24 (Eb)
		Startup time over	—		P.24 (EC)
			—		
	2 blinking	Indoor/outdoor unit communication error (signal receiving error) is detected by indoor unit.	E6	①Check if indoor/outdoor connecting wire is connected correctly. ②Check if noise entered into indoor/outdoor connecting wire or power supply. ③Check if noise entered into indoor/outdoor controller board. ④Re-check error by turning off power, and on again.	**
			E7		**
		Indoor/outdoor unit communication error (signal receiving error) is detected by outdoor unit.	—		P.30 (E8)
		Indoor/outdoor unit communication error (transmitting error) is detected by outdoor unit.	—		P.30 (E9)
	3 blinking	Remote controller signal receiving error is detected by remote controller.	E0	①Check if connecting wire of indoor unit or remote controller is connected correctly. ②Check if noise entered into transmission wire of remote controller. ③Re-check error by turning off power, and on again.	P.29
			E3		P.30
		Remote controller signal receiving error is detected by indoor unit.	E4		P.29
		Remote controller transmitting error is detected by indoor unit.	E5		P.30
4 blinking	Check code is not defined.	EF	①Check if noise entered into transmission wire of remote controller. ②Check if noise entered into indoor/outdoor connecting wire. ③Re-check error by turning off power, and on again.	P.30	
		EE		①Connect I/F or FTC to the unit.	P.24
5 blinking	Serial communication error <Communication between outdoor controller board and outdoor power board>	Ed	①Check if connector (CN4) on outdoor controller board and outdoor power board is not disconnected.	P.30	

\* Check code displayed on remote controller

\*\* Refer to service manual for indoor unit.



Indication		Error			
Outdoor controller board		Contents	Check code*	Inspection method	Detailed reference page
LED1 (Green)	LED2 (Red)				
3 blinking	1 blinking	Abnormality of discharging temperature (TH4) and Comp. surface temperature (TH33)	U2	①Check if stop valves are open. ②Check if connectors (TH4, LEV-A, and LEV-B) on outdoor controller board are not disconnected. ③Check if unit is filled with specified amount of refrigerant. ④Measure resistance values among terminals on indoor valve and outdoor linear expansion valve using a tester.	P.25
		Abnormality of superheat due to low discharge temperature	U7		P.26
	2 blinking	Abnormal high pressure (High pressure switch 63H operated.)	U1	①Check if indoor/outdoor units have a short cycle on their air ducts. ②Check if connector(63H)(63L) on outdoor controller board is not disconnected. ③Check if heat exchanger and filter is not dirty. ④Measure resistance values among terminals on linear expansion valve using a tester.	P.25
		Abnormal low pressure (Low pressure switch 63L operated.)	UL		P.29
	3 blinking	Abnormality of outdoor fan motor rotational speed	U8	①Check the outdoor fan motor. ②Check if connector (TH3) (63HS) on outdoor controller board is disconnected.	P.26
		Protection from overheat operation (TH3)	Ud		P.28
	4 blinking	Compressor overcurrent breaking(Start-up locked)	UF	①Check if stop valves are open. ②Check looseness, disconnection, and converse connection of compressor wiring. ③Measure resistance values among terminals on compressor using a tester. ④Check if outdoor unit has a short cycle on its air duct. ⑤Check leakage of refrigerant.	P.28
			UP		P.29
			UH		P.28
			U6		P.26
	5 blinking	Open/short of outdoor thermistors (TH4, TH33)	U3	①Check if connectors (TH3, TH32, TH4, TH33 and TH7/6) on outdoor controller board and connector (CN3) on outdoor power board are not disconnected. ②Measure resistance value of outdoor thermistors.	P.25
			U4		P.26
6 blinking	Abnormality of heat sink temperature	U5	①Check if indoor/outdoor units have a short cycle on their air ducts. ②Measure resistance value of outdoor thermistor(TH8).	P.26	
7 blinking	Abnormality of voltage	U9	①Check looseness, disconnection, and converse connection of compressor wiring. ②Measure resistance value among terminals on compressor using a tester. ③Check if power supply voltage decreases. ④Check the wiring of CN52C. ⑤Check the wiring of CNAF.	P.27– P.28	
4 blinking	1 blinking	Abnormality of room temperature thermistor (TH1)	P1	①Check if connectors on indoor controller board are not disconnected. ②Measure resistance value of indoor thermistors.	**
		Abnormality of pipe temperature thermistor /Liquid (TH2)	P2		**
		Abnormality of tank temperature thermistor	P9		**
	4 blinking	Abnormality of pipe temperature	P8	①Check if indoor thermistors(TH2 and TH5) are not disconnected from holder. ②Check if stop valve is open. ③Check converse connection of extension pipe. (on plural units connection) ④Check if indoor/outdoor connecting wire is connected correctly. (on plural units connection)	P.31

\* Check code displayed on remote controller

\*\* Refer to service manual for indoor unit.

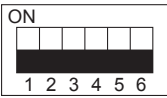
**<Outdoor unit operation monitor function>**

**[When optional part 'A-Control Service Tool (PAC-SK52ST)' is connected to outdoor controller board (CNM)]**

Digital indicator LED1 displays 2 digit number or code to inform operation condition and the meaning of check code by controlling DIP SW2 on "A-Control Service Tool".

Operation indicator SW2 : Indicator change of self diagnosis

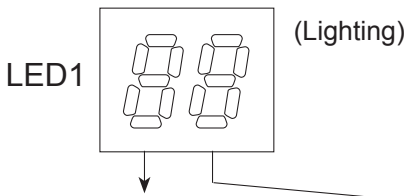
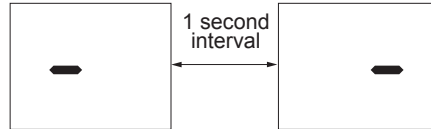
The black square (■) indicates a switch position.

SW2 setting	Display detail	Explanation for display	Unit
			

**<Digital indicator LED1 working details>**

(Be sure that 1 to 6 in the SW2 are set to OFF.)

- (1) Display when the power supply ON  
When the power supply ON, blinking displays by turns.  
Wait for 4 minutes at the longest.
- (2) When the display lights (Normal operation)
  - ① Operation mode display.



The tens digit : Operation mode

Display	Operation Model
O	OFF / FAN
C	COOLING / DRY
H	HEATING
d	DEFROSTING

The ones digit : Relay output

Display	Warming-up Compressor	Compressor	4-way valve	Solenoid valve
0	—	—	—	—
1	—	—	—	ON
2	—	—	ON	—
3	—	—	ON	ON
4	—	ON	—	—
5	—	ON	—	ON
6	—	ON	ON	—
7	—	ON	ON	ON
8	ON	—	—	—
A	ON	—	ON	—

- ② Display during error postponement  
Postponement code is displayed when compressor stops due to the work of protection device.  
Postponement code is displayed while error is being postponed.

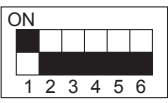
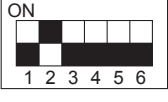
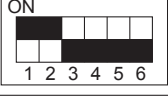
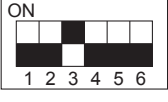
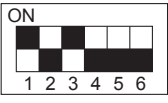
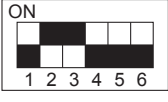
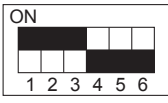
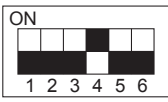
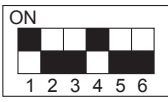
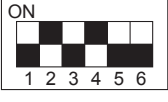
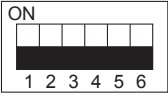
- (3) When the display blinks  
Inspection code is displayed when compressor stops due to the work of protection devices.

Display	Contents to be inspected (During operation)
U1	Abnormal high pressure (63H operated)
U2	Abnormal high discharge temperature, high comp. surface temperature, shortage of refrigerant
U3	Open/short of outdoor unit thermistors (TH4, TH33)
U4	Open/short of outdoor unit thermistors (TH3, TH6, TH7, TH8 and TH34)
U5	Abnormal temperature of heat sink
U6	Abnormality of power module
U7	Abnormality of superheat due to low discharge temperature
U8	Abnormality in outdoor fan motor
Ud	Overheat protection
UF	Compressor overcurrent interruption (When Comp. locked)
UH	Current sensor error
UL	Abnormal low pressure (63L operated)
UP	Compressor overcurrent interruption
P1-P8	Abnormality of indoor units

Display	Inspection unit
0	Outdoor unit
1	Indoor unit 1
2	Indoor unit 2

Display	Contents to be inspected (When power is turned on)
F3	63L connector(red) is open.
F5	63H connector(yellow) is open.
F9	2 connectors(63H/63L) are open.
E8	Indoor/outdoor communication error (Signal receiving error) (Outdoor unit)
E9	Indoor/outdoor communication error (Transmitting error) (Outdoor unit)
EA	Miswiring of indoor/outdoor unit connecting wire, excessive number of indoor units (4 units or more)
Eb	Miswiring of indoor/outdoor unit connecting wire(reverse wiring or disconnection)
EC	Startup time over
EE	Incorrect connection
E0-E7	Communication error except for outdoor unit

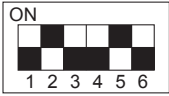
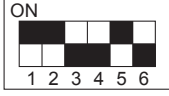
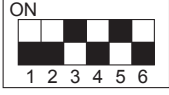

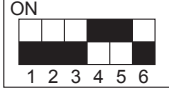
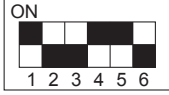
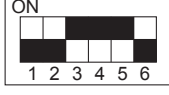
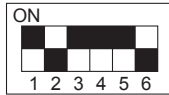
The black square (■) indicates a switch position.

SW2 setting	Display detail	Explanation for display	Unit
	Pipe temperature/Liquid (TH3) -40 to 90	-40 to 90 (When the coil thermistor detects 0°C or below, “-” and temperature are displayed by turns.) (Example) When -10°C; 0.5 s    0.5 s    2 s -□    →10    →□□ ↑	°C
	Discharge temperature (TH4) -20 to 217	-20 to 217 (When the discharge thermistor detects 100°C or more, hundreds digit, tens digit and ones digit are displayed by turns.) (Example) When 105°C; 0.5 s    0.5 s    2 s □1    →05    →□□ ↑	°C
	Output step of outdoor FAN 0 to 16	0 to 16	Step
	The number of ON/OFF times of compressor 0 to 9999	0 to 9999 (When the number of times is 100 or more, hundreds digit, tens digit and ones digit are displayed by turns.) (Example) When 42500 times (425 ×100 times); 0.5 s    0.5 s    2 s □4    →25    →□□ ↑	100 times
	Compressor integrating operation times 0 to 9999	0 to 9999 (When it is 100 hours or more, hundreds digit, tens digit and ones digit are displayed by turns.) (Example) When 2450 hours (245 ×10 hours); 0.5 s    0.5 s    2 s □2    →45    →□□ ↑	10 hours
	Compressor operating current 0 to 50	0 to 50 Note: Value after the decimal point will be truncated.	A
	Compressor operating frequency 0 to 225	0 to 255 (When it is 100 Hz or more, hundreds digit, tens digit and ones digit are displayed by turns.) (Example) When 125 Hz; 0.5 s    0.5 s    2 s □1    →25    →□□ ↑	Hz
	Primary LEV opening pulse 0 to 500 Heating: LEV-B Cooling: LEV-A	0 to 500 (When it is 100 pulse or more, hundreds digit, tens digit and ones digit are displayed by turns.) (Example) When 150 pulse; 0.5 s    0.5 s    2 s □1    →50    →□□ ↑	Pulse
	Error postponement code history (1) of outdoor unit	Postponement code display Blinking: During postponement Lighting: Cancellation of postponement “00” is displayed in case of no postponement.	Code display
	Operation mode on error occurring	Operation mode of when operation stops due to error is displayed by setting SW2 like below.  (SW2) 	Code display

The black square (■) indicates a switch position.

SW2 setting	Display detail	Explanation for display	Unit
	Pipe temperature/Liquid (TH3) on error occurring -40 to 90	-40 to 90 (When the coil thermistor detects 0°C or below, “-” and temperature are displayed by turns.) (Example) When -15°C; 0.5 s    0.5 s    2 s -□    → 15    → □□ ↑	°C
	Discharge temperature (TH4) on error occurring -20 to 217	-20 to 217 (When the temperature is 100°C or more, the hundreds digit, tens digit and ones digit are displayed by turns.) (Example) When 130°C; 0.5 s    0.5 s    2 s □1    → 30    → □□ ↑	°C
	Compressor operating current on error occurring 0 to 50	0 to 50	A
	Error history (1) (latest) Alternate display of abnormal unit number and code	When no error history, “ 0 ” and “ - ” are displayed by turns.	Code display
	Error history (2) Alternate display of error unit number and code	When no error history, “ 0 ” and “ - ” are displayed by turns.	Code display
	Thermo ON time 0 to 999	0 to 999 (When it is 100 minutes or more, the hundreds digit, tens digit and ones digit are displayed by turns.) (Example) When 245 minutes; 0.5 s    0.5 s    2 s □2    → 45    → □□ ↑	Minute
	Test run elapsed time 0 to 120	0 to 120 (When it is 100 minutes or more, the hundreds digit, tens digit and ones digit are displayed by turns.) (Example) When 105 minutes; 0.5 s    0.5 s    2 s □1    → 05    → □□ ↑	Minute
	Water flow rate	0 to 100	Unit

The black square (■) indicates a switch position.

SW2 setting	Display detail	Explanation for display	Unit										
	Capacity setting display	Displayed as an outdoor capacity code. <table border="1" data-bbox="863 318 1134 479"> <thead> <tr> <th>Capacity</th> <th>Code</th> </tr> </thead> <tbody> <tr> <td>WM50</td> <td>9</td> </tr> <tr> <td>WM60</td> <td>11</td> </tr> <tr> <td>WM85</td> <td>14</td> </tr> <tr> <td>WM112</td> <td>20</td> </tr> </tbody> </table>	Capacity	Code	WM50	9	WM60	11	WM85	14	WM112	20	Code display
Capacity	Code												
WM50	9												
WM60	11												
WM85	14												
WM112	20												
	Outdoor unit setting information	<ul style="list-style-type: none"> <li>The tens digit (Total display for applied setting)                             <table border="1" data-bbox="834 555 1398 674"> <thead> <tr> <th>Setting details</th> <th>Display details</th> </tr> </thead> <tbody> <tr> <td>H·P / Cooling only</td> <td>0 : H·P      1 : Cooling only</td> </tr> <tr> <td>Single phase / 3 phase</td> <td>0 : Single phase    2 : 3 phase</td> </tr> </tbody> </table> </li> <li>The ones digit                             <table border="1" data-bbox="834 730 1398 813"> <thead> <tr> <th>Setting details</th> <th>Display details</th> </tr> </thead> <tbody> <tr> <td>Defrosting switch</td> <td>0 : Normal      1 : For high humidity</td> </tr> </tbody> </table> </li> </ul> (Example) When heat pump, 3 phase and defrosting (normal) are set up, "20" is displayed.	Setting details	Display details	H·P / Cooling only	0 : H·P      1 : Cooling only	Single phase / 3 phase	0 : Single phase    2 : 3 phase	Setting details	Display details	Defrosting switch	0 : Normal      1 : For high humidity	Code display
Setting details	Display details												
H·P / Cooling only	0 : H·P      1 : Cooling only												
Single phase / 3 phase	0 : Single phase    2 : 3 phase												
Setting details	Display details												
Defrosting switch	0 : Normal      1 : For high humidity												
	Plate HEX liquid pipe temperature (TH34) -40 to 90	-40 to 90 (When the temperature is 0°C or less, "-" and temperature are displayed by turns.)	°C										
	Condensing temperature (T63HS) -39 to 88	-39 to 88 (When the temperature is 0°C or less, "-" and temperature are displayed by turns.)	°C										
	Return water temperature 0 to 100	0 to 100	°C										
	Flow water temperature 0 to 100	0 to 100	°C										
	2-phase pipe temperature thermistor (TH6) -40 to 90	-40 to 90 (When the temperature is 0: or less, "-" and temperature are displayed by turns.)	°C										
	Outdoor outside temperature (TH7) -40 to 90	-40 to 90 (When the temperature is 0°C or less, "-" and temperature are displayed by turns.)	°C										

The black square (■) indicates a switch position.

SW2 setting	Display detail	Explanation for display	Unit																		
	Outdoor heat sink temperature (TH8) -40 to 200	-40 to 200 (When the temperature is 0°C or less, “-” and temperature are displayed by turns.) (When the thermistor detects 100°C or more, hundreds digit, tens digit and ones digit are displayed by turns.)	°C																		
	Discharge superheat SHd 0 to 255 [Cooling = TH4-T <sub>63HS</sub> ] [Heating = TH4-T <sub>63HS</sub> ]	0 to 255 (When the temperature is 100°C or more, hundreds digit, tens digit and ones digit are displayed by turns.)	°C																		
	Number of defrost cycles 0 to FFFE	0 to FFFE (in hexadecimal notation) (When more than FF in hex (255 in decimal), the number is displayed in order of 16 <sup>3</sup> 's and 16 <sup>2</sup> 's, and 16 <sup>1</sup> 's and 16 <sup>0</sup> 's places. (Example) When 5000 cycles; <div style="text-align: center;"> <table style="margin: auto;"> <tr> <td style="padding: 0 10px;">0.5 s</td> <td style="padding: 0 10px;">0.5 s</td> <td style="padding: 0 10px;">2 s</td> </tr> <tr> <td style="text-align: center;">□9</td> <td style="text-align: center;">→ C4</td> <td style="text-align: center;">→ □□</td> </tr> <tr> <td style="text-align: center;">↑</td> <td></td> <td></td> </tr> </table> </div>	0.5 s	0.5 s	2 s	□9	→ C4	→ □□	↑			2 cycles									
0.5 s	0.5 s	2 s																			
□9	→ C4	→ □□																			
↑																					
	Input current of outdoor unit	0 to 500 (When it is 100 or more, hundreds digit, tens digit and ones digit are displayed by turns.)	0.1 A																		
	Secondary LEV opening pulse 0 to 500 Heating: LEV-A Cooling: LEV-B	0 to 500 (When it is 100 pulse or more, hundreds digit, tens digit and ones digit are displayed by turns.)	Pulse																		
	U9 error detail history (latest)	<table border="1" style="width: 100%; border-collapse: collapse;"> <thead> <tr> <th>Description</th> <th>Display</th> </tr> </thead> <tbody> <tr> <td>Normal</td> <td>00</td> </tr> <tr> <td>Overvoltage error</td> <td>01</td> </tr> <tr> <td>Undervoltage error</td> <td>02</td> </tr> <tr> <td>Input current sensor error</td> <td></td> </tr> <tr> <td>L-phase open error</td> <td>04</td> </tr> <tr> <td>Abnormal power synchronous signal</td> <td>08</td> </tr> <tr> <td>PFC/IGBT error (W-VAA)</td> <td></td> </tr> <tr> <td>Undervoltage</td> <td>20</td> </tr> </tbody> </table> <p>• Display examples for multiple errors:            Overvoltage (01) + Undervoltage (02) = 03            Undervoltage (02) + Power-sync signal error (08) = 0A            L-phase open error (04) + PFC/IGBT error (20) = 24</p>	Description	Display	Normal	00	Overvoltage error	01	Undervoltage error	02	Input current sensor error		L-phase open error	04	Abnormal power synchronous signal	08	PFC/IGBT error (W-VAA)		Undervoltage	20	Code display
Description	Display																				
Normal	00																				
Overvoltage error	01																				
Undervoltage error	02																				
Input current sensor error																					
L-phase open error	04																				
Abnormal power synchronous signal	08																				
PFC/IGBT error (W-VAA)																					
Undervoltage	20																				
	DC bus voltage 180 to 370	180 to 370 (When it is 100 V or more, hundreds digit, tens digit and ones digit are displayed by turns.)	V																		
	Error postponement code history (2) of outdoor unit	Postponement code display Blinking: During postponement Lighting: Cancellation of postponement “00” is displayed in case of no postponement.	Code display																		



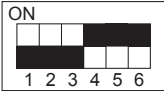
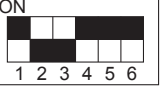
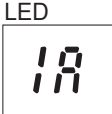
The black square (■) indicates a switch position.

SW2 setting	Display detail	Explanation for display	Unit
	Error postponement code history (3) of outdoor unit	Postponement code display Blinking: During postponement Lighting: Cancellation of postponement "00" is displayed in case of no postponement.	Code display
	Error history (3) (Oldest) Alternate display of abnormal unit number and code	When no error history, "0" and "--" are displayed by turns.	Code display
	Error thermistor display [When there is no error thermistor, "--" is displayed.]	3: Liquid pipe temperature (TH3) 4: Discharge pipe temperature (TH4) 6: Two phase pipe (TH6) 7: Ambient temperature (TH7) 8: Heat sink temperature (TH8) 33: Comp. surface temperature (TH33) 34: Plate hex liquid (TH34)	Code display
	Operation frequency on error occurring 0 to 255	0 to 255 (When it is 100 Hz or more, hundreds digit, tens digit and ones digit are displayed by turns.) (Example) When 125 Hz; 0.5 s      0.5 s      2 s □1      → 25      → □□	Hz
	Fan step on error occurring 0 to 16	0 to 16	Step
	Return water temperature on error occurring 0 to 100	0 to 100	°C
	Plate HEX Liquid temperature (TH34) on error occurring -40 to 90	-40 to 90 (When the temperature is 0°C or less, "--" and temperature are displayed by turns.) (Example) When -15°C; 0.5 s      0.5 s      2 s -□      → 15      → □□	°C
	Pressure saturation temperature (T <sub>63HS</sub> ) on error occurring -39 to 88	-39 to 88 (When the temperature is 0°C or less, "--" and temperature are displayed by turns.) (Example) When -15°C; 0.5 s      0.5 s      2 s -□      → 15      → □□	°C

The black square (■) indicates a switch position.

SW2 setting	Display detail	Explanation for display	Unit
	2-phase pipe temperature thermistor (TH6) -40 to 90	-40 to 90 (When the temperature is 0°C or less, “-” and temperature are displayed by turns.) (Example) When -15°C; 0.5 s    0.5 s    2 s -□    → 15    → □□	°C
	Outdoor outside temperature (TH7) on error occurring -40 to 90	-40 to 90 (When the temperature is 0°C or less, “-” and temperature are displayed by turns.) (Example) When -15°C; 0.5 s    0.5 s    2 s -□    → 15    → □□	°C
	Outdoor heat sink temperature (TH8) on error occurring -40 to 200	-40 to 200 (When the temperature is 0°C or less, “-” and temperature are displayed by turns.) (When the temperature is 100°C or more, hundreds digit, tens digit and ones digit are displayed by turns.)	°C
	Discharge superheat on error occurring SHd 0 to 255 [Cooling = TH4-T <sub>63HS</sub> ] [Heating = TH4-T <sub>63HS</sub> ]	0 to 255 (When the temperature is 100°C or more, hundreds digit, tens digit and ones digit are displayed by turns.) (Example) When 150°C; 0.5 s    0.5 s    2 s □1    → 50    → □□	°C
	Sub cool on error occurring SC 0 to 130 [Cooling = T <sub>63HS</sub> -TH3] [Heating = T <sub>63HS</sub> -TH2]	0 to 130 (When the temperature is 100°C or more, hundreds digit, tens digit and ones digit are displayed by turns.) (Example) When 115°C; 0.5 s    0.5 s    2 s □1    → 15    → □□	°C
	Thermo-on time until error stops 0 to 999	0 to 999 (When it is 100 minutes or more, hundreds digit, tens digit and ones digit are displayed by turns.) (Example) When 415 minutes; 0.5 s    0.5 s    2 s □4    → 15    → □□	Minute

The black square (■) indicates a switch position.

SW2 setting	Display detail	Explanation for display	Unit																
	<p>Comp. surface temperature (TH33) -52 to 221</p>	<p>-52 to 221 (When the temperature is 0°C or less, "-" and temperature are displayed by turns.) (When the discharge thermistor detects 100°C or more, hundreds digit, tens digit, and ones digit are displayed by turns.) (Example) When 105°C; 0.5 s    0.5 s    2 s □1    → 05    → □□           ↑                  ↓</p>	<p>°C</p>																
	<p>Controlling status of compressor operating frequency</p>	<p>The following code will be a help to know the operating status of unit.</p> <ul style="list-style-type: none"> <li>•The tens digit</li> </ul> <table border="1" data-bbox="842 696 1289 786"> <thead> <tr> <th>Display</th> <th>Compressor operating frequency control</th> </tr> </thead> <tbody> <tr> <td>1</td> <td>Primary current control</td> </tr> <tr> <td>2</td> <td>Secondary current control</td> </tr> </tbody> </table> <ul style="list-style-type: none"> <li>•The ones digit (In this digit, the total number of activated control is displayed.)</li> </ul> <table border="1" data-bbox="842 846 1289 1088"> <thead> <tr> <th>Display</th> <th>Compressor operating frequency control</th> </tr> </thead> <tbody> <tr> <td>1</td> <td>Preventive control for excessive temperature rise of discharge temperature</td> </tr> <tr> <td>2</td> <td>Preventive control for excessive temperature rise of condensing temperature</td> </tr> <tr> <td>4</td> <td>Frosting preventing control</td> </tr> <tr> <td>8</td> <td>Preventive control for excessive temperature rise of radiator panel</td> </tr> </tbody> </table> <p>(Example) The following controls are activated.</p> <ul style="list-style-type: none"> <li>• Primary current control</li> <li>• Preventive control for excessive temperature rise of condensing temperature</li> <li>• Preventive control for excessive temperature rise of heat sink</li> </ul> 	Display	Compressor operating frequency control	1	Primary current control	2	Secondary current control	Display	Compressor operating frequency control	1	Preventive control for excessive temperature rise of discharge temperature	2	Preventive control for excessive temperature rise of condensing temperature	4	Frosting preventing control	8	Preventive control for excessive temperature rise of radiator panel	<p>Code display</p>
Display	Compressor operating frequency control																		
1	Primary current control																		
2	Secondary current control																		
Display	Compressor operating frequency control																		
1	Preventive control for excessive temperature rise of discharge temperature																		
2	Preventive control for excessive temperature rise of condensing temperature																		
4	Frosting preventing control																		
8	Preventive control for excessive temperature rise of radiator panel																		

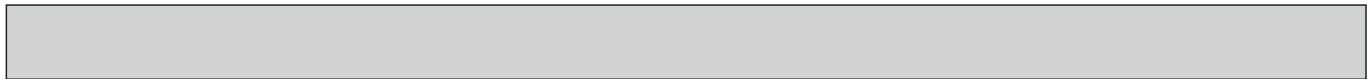
## 10-1. Request code list

Certain indoor/outdoor combinations do not have the request code function; therefore, no request codes are displayed. Refer to indoor unit service manual for how to use the controllers and request codes for indoor unit.

Request code	Request content	Description (Display range)	Unit	Remarks
0	Operation state	Refer to 10-1-1. Detail Contents in Request Code.	–	
1	Compressor-Operating current (rms)	0–50	A	
2	Compressor-Accumulated operating time	0–9999	10 hours	
3	Compressor-Number of operation times	0–9999	100 times	
4	Discharge temperature (TH4)	-20–217	°C	
5	Outdoor unit -Liquid pipe 1 temperature (TH3)	-40–90	°C	
6				
7				
8				
9	Outdoor unit-Outside air temperature (TH7)	-40–90	°C	
10	Outdoor unit-Heat sink temperature (TH8)	-40–200	°C	
11				
12	Discharge superheat (SHd)	0–255	°C	
13	Sub-cool (SC)	0–130	°C	
14	Condensing temperature (T <sub>63HS</sub> )	-39–88	°C	
15				
16	Compressor-Operating frequency	0–255	Hz	
17	Compressor-Target operating frequency	0–255	Hz	
18	Outdoor unit-Fan output step	0–16	Step	
19	Outdoor unit-Fan 1 speed (Only for air conditioners with DC fan motor)	0–9999	rpm	
20	Outdoor unit-Fan 2 speed (Only for air conditioners with DC fan motor)	0–9999	rpm	"0" is displayed if the air conditioner is a single-fan type.
21				
22	LEV (A) opening	0–500	Pulses	
23	LEV (B) opening	0–500	Pulses	
24				
25	Primary current	0–50	A	
26	DC bus voltage	180–370	V	
27				
28				
29				
30				
31				
32				
33				
34				
35				
36				
37				
38				
39				
40				
41				
42				
43				
44				
45				
46				
47				
48	Thermostat ON operating time	0–999	Minutes	
49				



Request code	Request content	Description (Display range)	Unit	Remarks
50				
51	Outdoor unit-Control state	Refer to 10-1-1.Detail Contents in Request Code.	-	
52	Compressor-Frequency control state	Refer to 10-1-1.Detail Contents in Request Code.	-	
53	Outdoor unit-Fan control state	Refer to 10-1-1.Detail Contents in Request Code.	-	
54	Actuator output state	Refer to 10-1-1.Detail Contents in Request Code.	-	
55	Error content (U9)	Refer to 10-1-1.Detail Contents in Request Code.	-	
56				
57				
58				
59				
60				
61				
62				
63				
64				
65				
66				
67				
68				
69				
70	Outdoor unit-Capacity setting display	Refer to 10-1-1.Detail Contents in Request Code.	-	
71	Outdoor unit-Setting information	Refer to 10-1-1.Detail Contents in Request Code.	-	
72				
73				
74				
75				
76				
77				
78				
79				
80				
81				
82				
83				
84				
85				
86				
87				
88				
89				
90	Outdoor unit-Microprocessor version information	Examples) Ver 5.01 → "0501"	Ver	
91	Outdoor unit-Microprocessor version information (sub No.)	Auxiliary information (displayed after version information) Examples) Ver 5.01 A000 → "A000"	-	
92				
93				
94				
95				
96				
97				
98				
99				
100	Outdoor unit - Error postponement history 1 (latest)	Displays postponement code. (" - " is displayed if no postponement code is present)	Code	
101	Outdoor unit - Error postponement history 2 (previous)	Displays postponement code. (" - " is displayed if no postponement code is present)	Code	
102	Outdoor unit - Error postponement history 3 (last but one)	Displays postponement code. (" - " is displayed if no postponement code is present)	Code	



Request code	Request content	Description (Display range)	Unit	Remarks
103	Error history 1 (latest)	Displays error history. (" --" is displayed if no history is present.)	Code	
104	Error history 2 (second to last)	Displays error history. (" --" is displayed if no history is present.)	Code	
105	Error history 3 (third to last)	Displays error history. (" --" is displayed if no history is present.)	Code	
106	Abnormal thermistor display (TH3/TH6/TH7/TH8)	3 : TH3 6 : TH6 7 : TH7 8 : TH8 0 : No thermistor error	Sensor number	
107	Operation mode at time of error	Displayed in the same way as request code "0".	–	
108	Compressor-Operating current at time of error	0–50	A	
109	Compressor-Accumulated operating time at time of error	0–9999	10 hours	
110	Compressor-Number of operation times at time of error	0–9999	100 times	
111	Discharge temperature at time of error	-20–217	°C	
112	Outdoor unit -Liquid pipe 1 temperature (TH3) at time of error	-40–90	°C	
113				
114				
115				
116	Outdoor unit-Outside air temperature (TH7) at time of error	-40–90	°C	
117	Outdoor unit-Heat sink temperature (TH8) at time of error	-40–200	°C	
118	Discharge superheat (SHd) at time of error	0–255	°C	
119	Sub-cool (SC) at time of error	0–130	°C	
120	Compressor-Operating frequency at time of error	0–255	Hz	
121	Outdoor unit at time of error • Fan output step	0–16	Step	
122	Outdoor unit at time of error • Fan 1 speed (Only for air conditioners with DC fan)	0–9999	rpm	
123	Outdoor unit at time of error • Fan 2 speed (Only for air conditioners with DC fan)	0–9999	rpm	"0" is displayed if the air conditioner is a singlefan type.
124				
125	LEV (A) opening at time of error	0–500	Pulses	
126				
127				
128				
129				
130	Thermostat ON time until operation stops due to error	0–999	Minutes	

## 10-1-1. Detail Contents in Request Code

### [Operation state] (Request code : "0")

Data display

□ □ C 4

Relay output state  
Operation mode

Operation mode

Display	Operation mode
0	STOP • FAN
C	COOL • DRY
H	HEAT
d	DEFROST

Relay output state

Display	Power currently supplied to compressor	Compressor	Four-way valve	Solenoid valve
0	—	—	—	—
1				ON
2			ON	
3			ON	ON
4		ON		
5		ON		ON
6		ON	ON	
7		ON	ON	ON
8	ON			
A	ON		ON	

### [Outdoor unit – Control state] (Request code : "51")

Data display	State
0 0 0 0	Normal
0 0 0 1	Preparing for heat operation
0 0 0 2	Defrost

### [Compressor – Frequency control state] (Request code : "52")

Data display

0 0 \* \*

Frequency control state ②  
Frequency control state ①

Frequency control state ①

Display	Current limit control
0	No current limit
1	Primary current limit control is ON.
2	Secondary current limit control is ON.

Frequency control state ②

Display	Discharge temperature overheat prevention	Condensation temperature overheat prevention	Anti-freeze protection control	Heat sink temperature overheat prevention
0				
1	Controlled			
2		Controlled		
3	Controlled	Controlled		
4			Controlled	
5	Controlled		Controlled	
6		Controlled	Controlled	
7	Controlled	Controlled	Controlled	
8				Controlled
9	Controlled			Controlled
A		Controlled		Controlled
b	Controlled	Controlled		Controlled
C			Controlled	Controlled
d	Controlled		Controlled	Controlled
E		Controlled	Controlled	Controlled
F	Controlled	Controlled	Controlled	Controlled

### [Fan control state] (Request code : "53")

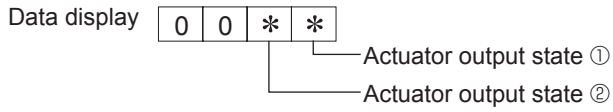
Data display

0 0 \* \*

Fan step correction value by heat sink temperature overheat prevention control  
Fan step correction value by cool condensation temperature overheat prevention control

Display	Correction value
- (minus)	-1
0	0
1	+1
2	+2

**[Actuator output state] (Request code : "54")**



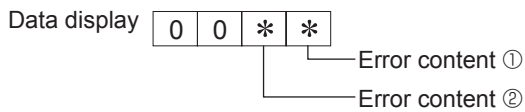
Actuator output state ①

Display	SV1	Four-way valve	Compressor	Compressor is warming up
0				
1	ON			
2		ON		
3	ON	ON		
4			ON	
5	ON		ON	
6		ON	ON	
7	ON	ON	ON	
8				ON
9	ON			ON
A		ON		ON
b	ON	ON		ON
C			ON	ON
d	ON		ON	ON
E		ON	ON	ON
F	ON	ON	ON	ON

Actuator output state ②

Display	52C	SV2	SS
0			
1	ON		
2		ON	
3	ON	ON	
4			ON
5	ON		ON
6		ON	ON
7	ON	ON	ON

**[Error content (U9)] (Request code : "55")**



Error content ①

● : Detected

Display	Oversvoltage error	Undervoltage error	L <sub>1</sub> -phase open error	Power synchronizing signal error
0				
1	●			
2		●		
3	●	●		
4			●	
5	●		●	
6		●	●	
7	●	●	●	
8				●
9	●			●
A		●		●
b	●	●		●
C			●	●
d	●		●	●
E		●	●	●
F	●	●	●	●

Error content ②

● : Detected

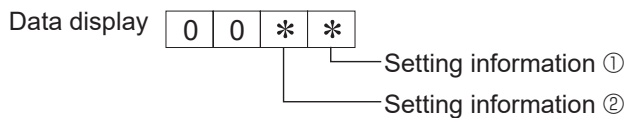
Display	Converter Fo error	PAM error
0		
1	●	
2		●
3	●	●



**[Outdoor unit – Capacity setting display] (Request code : "70")**

Data display	Capacity
9	35
10	50
11	60
14	71
20	100
25	125
28	140
40	200
50	250

**[Outdoor unit – Setting information] (Request code : "71")**



Setting information ①

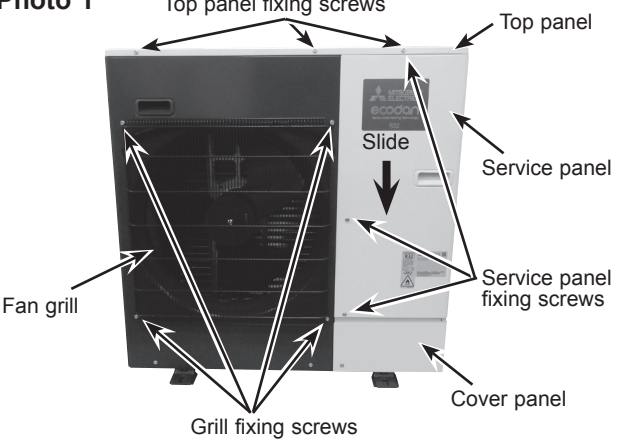
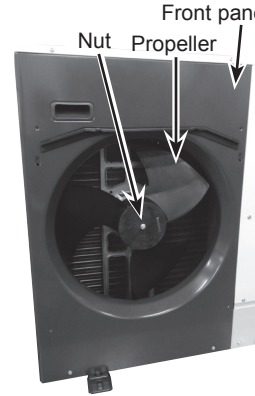
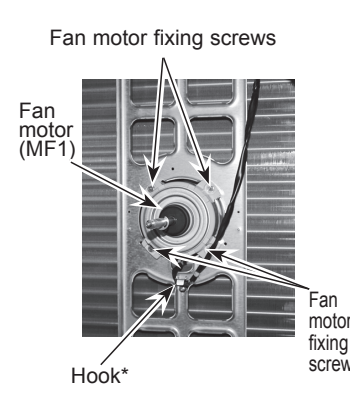
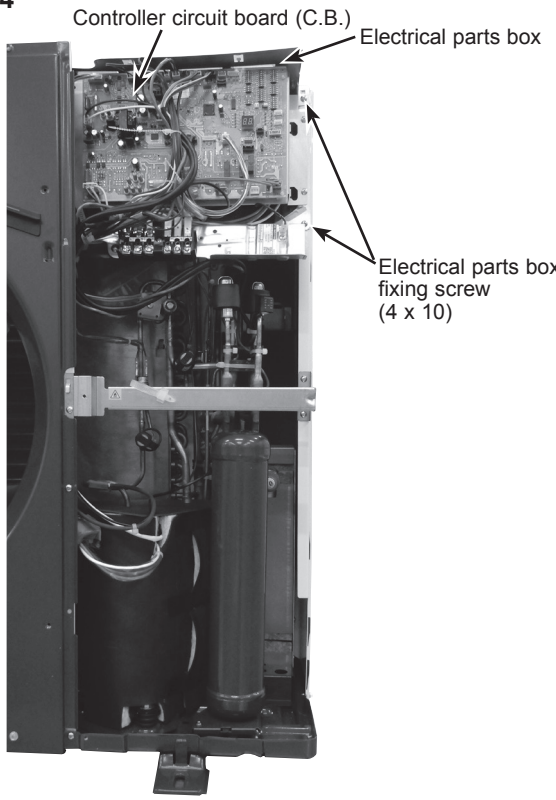
Display	Defrost mode
0	Standard
1	For high humidity

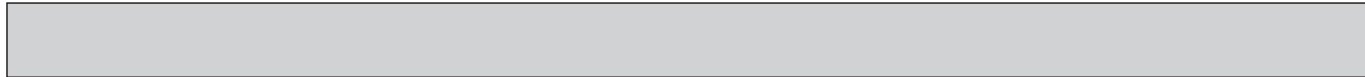
Setting information ②

Display	Single-/3-phase	Heat pump/cooling only
0	Single-phase	Heat pump
1		Cooling only
2	3-phase	Heat pump
3		Cooling only

PUZ-WM50VHA.UK

PUZ-WM50VHA-BS.UK

OPERATING PROCEDURE	PHOTOS/FIGURES
<p><b>1. Removing the service, top and cover panels</b></p> <p>(1) Remove 3 screws (5 × 12) and slide the hook on the right downward to remove the service panel.</p> <p>(2) Remove screws (3 for front, 3 for rear/5 × 12) of the top panel and remove it.</p> <p>(3) Remove 2 screws (5x12) of the cover panel and remove it.</p> <p><b>Note: When removing service panel and top panel at the same time, count one less screw since they share a screw.</b></p>	<p><b>Photo 1</b></p> 
<p><b>2. Removing the fan motor (MF1)</b></p> <p>(1) Remove the service panel. (See Photo 1)</p> <p>(2) Remove the top panel. (See Photo 1)</p> <p>(3) Remove 4 screws (5 × 12) to detach the fan grill. (See Photo 1)</p> <p>(4) Remove a nut (for right handed screw of M6) to detach the propeller. (See Photo 2)</p> <p>(5) Disconnect the connector CNF1 on controller circuit board in electrical parts box.</p> <p>(6) Loosen the clamp for the lead wire on motor support and separator.</p> <p>(7) Remove 4 screws (5 × 25) to detach the fan motor. (See Photo 3)</p> <p>* When attaching the fan motor, make sure to route the cable through the hook below the fan motor and fix firmly with the clamp. (See Photo 3)</p>	<p><b>Photo 2</b></p>  <p><b>Photo 3</b></p> 
<p><b>3. Removing the electrical parts box</b></p> <p>(1) Remove the service panel. (See Photo 1)</p> <p>(2) Remove the top panel. (See Photo 1)</p> <p>(3) Disconnect the indoor/outdoor connecting wire from terminal block.</p> <p>(4) Disconnect the connector CNF1, 63HS, LEV-A and LEV-B on the controller circuit board.</p> <p>&lt;Symbols on the board&gt;</p> <ul style="list-style-type: none"> <li>• CNF1 : Fan motor</li> <li>• 63HS: Pressure sensor</li> <li>• LEV-A, LEV-B : LEV</li> </ul> <p>(5) Disconnect the pipe-side connections of the following parts.</p> <ul style="list-style-type: none"> <li>• Thermistor &lt;Liquid&gt; (TH3)</li> <li>• Thermistor &lt;Discharge&gt; (TH4)</li> <li>• Thermistor &lt;Ambient, 2-Phase pipe&gt; (TH7/6)</li> <li>• Thermistor &lt;Heat sink&gt; (TH8)</li> <li>• Thermistor &lt;Plate HEX liquid&gt; (TH34)</li> <li>• Thermistor &lt;Comp. surface&gt; (TH33)</li> <li>• High pressure switch (63H)</li> <li>• 4-way valve coil (21S4)</li> </ul> <p>(6) Release the lead wire from the hole on separator.</p> <p>(7) Remove the terminal cover and disconnect the compressor lead wires.</p> <p>(8) Remove the 2 screws (4 × 10) and detach the electrical parts box by pulling it upward. The electrical parts box is fixed with 2 hooks on the left and 1 hook on the right.</p>	<p><b>Photo 4</b></p> 

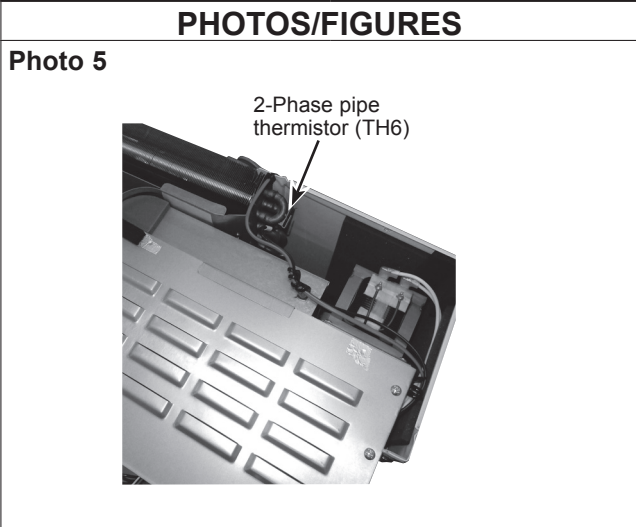


**OPERATING PROCEDURE**

**4. Removing the thermistor <2-Phase pipe> (TH6)**

- (1) Remove the service panel. (See Photo 1)
- (2) Remove the top panel. (See Photo 1)
- (3) Disconnect the connector TH7/6 on the controller circuit board.  
<Symbol on the board>
  - TH7/6: Thermistor <Ambient, 2-phase pipe>
- (4) Loosen the fastener on the electrical parts box and unbind the lead wires.
- (5) Loosen the clamp for the lead wire in the rear of the electrical parts box.
- (6) Pull out the thermistor <2-phase pipe> (TH6) from the sensor holder.

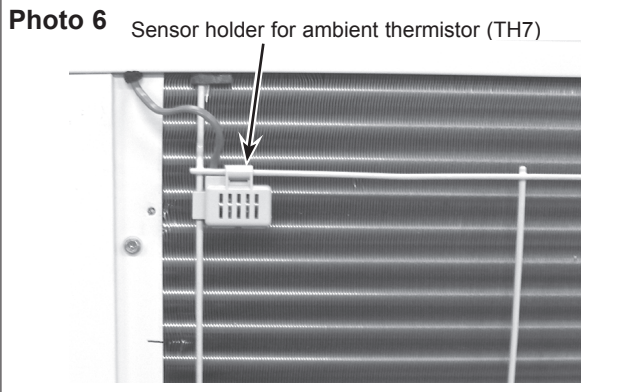
**Note1: When replacing thermistor <2-Phase pipe>(TH6), replace it together with thermistor<Ambient> (TH7), since they are combined together. Refer to No.5 below to remove thermistor <Ambient>.**



**5. Removing the thermistor <Outdoor ambient> (TH7)**

- (1) Remove the service panel. (See Photo 1)
- (2) Remove the top panel. (See Photo 1)
- (3) Disconnect the connector TH7/6 (red) on the controller circuit board.
- (4) Loosen the clamps for the lead wire.
- (5) Pull out the thermistor <Ambient> (TH7) from the sensor holder.

**Note1: When replacing thermistor <Ambient> (TH7), replace it together with thermistor <2-Phase pipe> (TH6), since they are combined together. Refer to No.4 above to remove thermistor <2-Phase pipe>.**



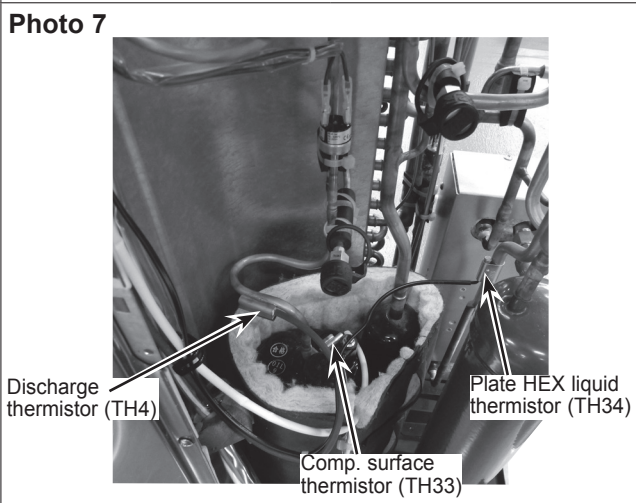
**6. Removing the thermistor <Discharge> (TH4), thermistor <Comp. surface> (TH33) and <Plate Hex liquid> (TH34)**

- (1) Remove the service panel. (See Photo 1)
- (2) Disconnect the connectors, TH34 (red), TH4 (white), and TH33 (yellow) on the controller circuit board.
- (3) Loosen the clamps for the lead wire.
- (4) Pull out the thermistor <Discharge> (TH4) from the sensor holder and detach the thermistor <Plate HEX liquid> (TH34).

**[Removing the thermistor <Comp. surface> (TH33)]**

- (5) Pull out the thermistor <Comp. surface> (TH33) from the holder of the compressor surface.

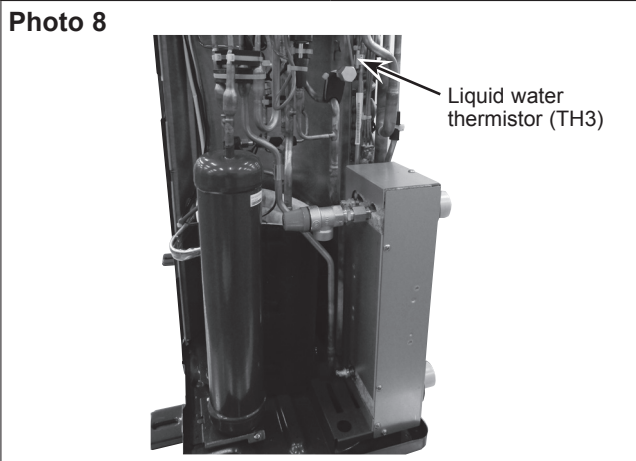
**Note1: When replacing the soundproof lid, fit the lid to the wrapped cover without making a gap.**



**7. Removing the thermistor <Liquid Water> (TH3)**

Removing the thermistor<Liquid Water> (TH3)

- (1) Remove the service panel. (See Photo 1)
- (2) Remove the top panel. (See Photo 1)
- (3) Disconnect the connector TH3 on the controller circuit board.
- (4) Loosen the clamps for the lead wire.
- (5) Detach the thermistor <Liquid Water> (TH3).



## OPERATING PROCEDURE

### 8. Removing the 4-way valve coil (21S4) linear expansion valve coil (LEV (A), LEV (B))

- (1) Remove the service panel. (See Photo 1)
- (2) Remove the top panel. (See Photo 1)
- (3) Remove the electrical parts box. (See Photo 4)

#### [Removing the 4-way valve coil ]

- (4) Remove the 4-way valve coil fixing screw (M4 × 6).
- (5) Remove the 4-way valve coil.
- (6) Disconnect the connector 21S4 (green) on the controller circuit board.

#### [Removing the linear expansion valve coil]

- (4) Remove the linear expansion valve coil by sliding the coil upward.
- (5) Disconnect the connectors, LEV A (white) and LEV B (red), on the controller circuit board.

### 9. Removing the 4-way valve

- (1) Remove the service panel. (See Photo 1)
- (2) Remove the top panel. (See Photo 1.)
- (3) Remove the cover panel. (See Photo 1)
- (4) Remove stay by removing the 3 fixing screws (4 × 10). Remove side panel (R) by removing the 5 fixing screws (4 for rear, 1 for right/5 × 12).
- (5) Remove the electrical parts box. (See Photo 4)
- (6) Remove the 4-way valve coil. (See Photo 10) (Refer to Procedure 8)
- (7) Recover refrigerant.
- (8) Remove the welded part of 4-way valve.

**Note1:** Recover refrigerant without letting it out in the air.

**Note2:** Access to the welded part becomes easier by removing the side panel (R).

**Note3:** When installing the 4-way valve, make sure to cover it with a wet cloth to prevent it from heating (120°C or more), then braze the pipes so that the inside of pipes are not oxidized.

### 10. Removing linear expansion valve

- (1) Remove the service panel. (See Photo 1)
- (2) Remove the top panel. (See Photo 1)
- (3) Remove the cover panel. (See Photo 1)
- (4) Remove the stay and the side panel (R). (Refer to Procedure 9)
- (5) Remove the electrical parts box. (See Photo 4)
- (6) Remove the linear expansion valve. (Refer to Procedure 8)
- (7) Recover refrigerant.
- (8) Remove the welded part of linear expansion valve.

**Note1:** Recover refrigerant without spreading it in the air.

**Note2:** Access to the welded part becomes easier by removing the side panel (R).

**Note3:** When installing the linear expansion valve, cover it with a wet cloth to prevent it from heating (120°C or more), then braze the pipes so that the inside of pipes are not oxidized.

## PHOTOS/FIGURES

Photo 9

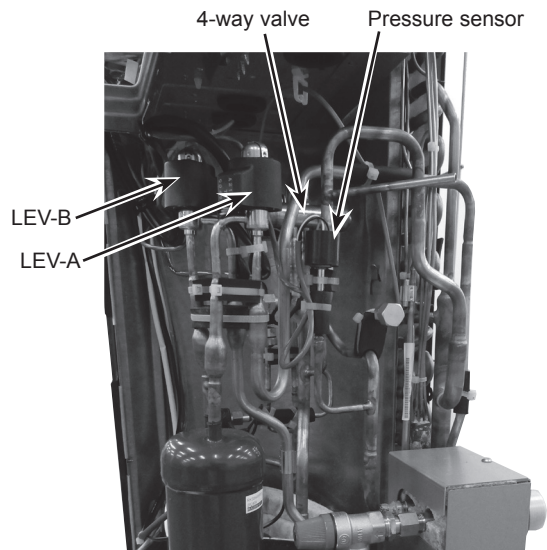
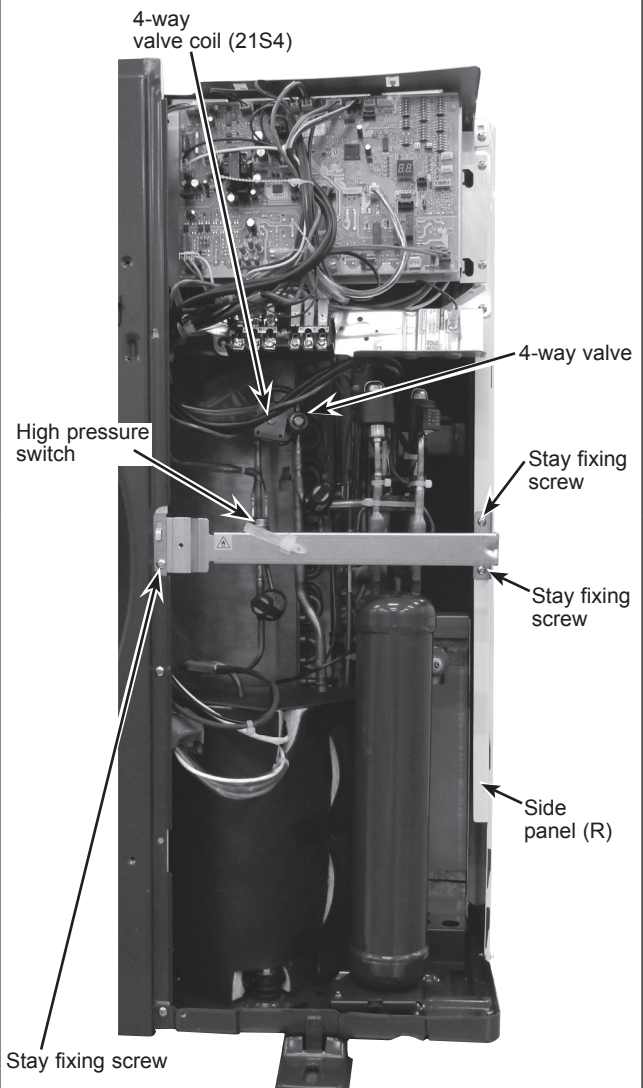

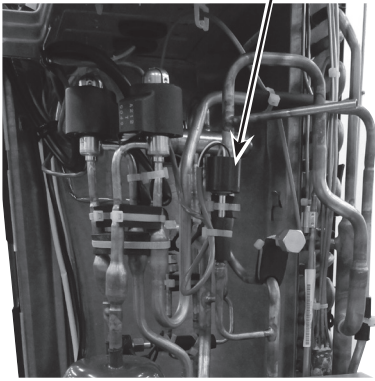



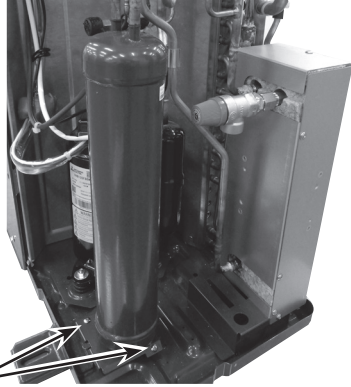
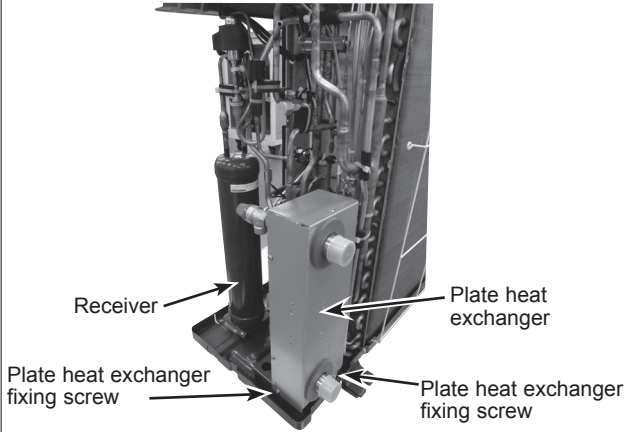
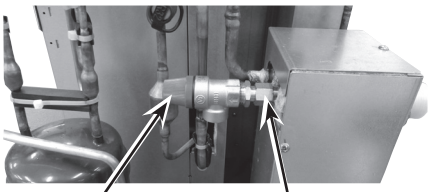
Photo 10





OPERATING PROCEDURE	PHOTOS/FIGURES
<p><b>11. Removing the high pressure switch (63H)</b></p> <ol style="list-style-type: none"> <li>(1) Remove the service panel. (See Photo 1)</li> <li>(2) Remove the top panel. (See Photo 1)</li> <li>(3) Remove the cover panel. (See Photo 1)</li> <li>(4) Remove the stay and the side panel (R). (Refer to Procedure 9)</li> <li>(5) Remove the electrical parts box (Refer to Procedure 3).</li> <li>(6) Pull out the lead wire of high pressure switch.</li> <li>(7) Recover refrigerant.</li> <li>(8) Remove the welded part of high pressure switch.</li> </ol> <p><b>Note1: Recover refrigerant without letting it out in the air.</b>  <b>Note2: Access to the welded part becomes easier by removing the right side panel.</b>  <b>Note3: When installing the high pressure switch, make sure to cover it with a wet cloth to prevent it from heating (100°C or more), then braze the pipes so that the inside of pipes are not oxidized.</b></p>	<p><b>Photo 11</b></p>  <p>High pressure switch (63H)</p>
<p><b>12. Removing the pressure sensor (63HS)</b></p> <ol style="list-style-type: none"> <li>(1) Remove the service panel. (See Photo 1)</li> <li>(2) Remove the top panel. (See Photo 1)</li> <li>(3) Remove the stay and the side panel (R). (Refer to Procedure 9)</li> <li>(4) Pull out the lead wire of pressure sensor.</li> <li>(5) Remove the electrical parts box (Refer to Procedure 3).</li> <li>(6) Recover refrigerant.</li> <li>(7) Remove the welded part of pressure sensor.</li> </ol> <p><b>Note1: Recover refrigerant without letting it out in the air.</b>  <b>Note2: Access to the welded part becomes easier by removing the right side panel.</b>  <b>Note3: When installing the pressure sensor, make sure to cover it with a wet cloth to prevent it from heating (100°C or more), then braze the pipes so that the inside of pipes are not oxidized.</b></p>	<p><b>Photo 12</b></p>  <p>Pressure sensor (63HS)</p>
<p><b>13. Removing the compressor (MC)</b></p> <ol style="list-style-type: none"> <li>(1) Remove the service panel. (See Photo 1)</li> <li>(2) Remove the top panel. (See Photo 1)</li> <li>(3) Remove the cover panel. (See photo 1)</li> <li>(4) Remove the stay and the side panel (R). (Refer to Procedure 9)</li> <li>(5) Remove the electrical parts box. (Refer to Procedure 3)</li> <li>(6) Remove the soundproof cover and lid.</li> <li>(7) Remove the Comp. surface thermistor (TH33) (Photo 7)</li> <li>(8) Remove the terminal cover and remove the lead wire for compressor.</li> <li>(9) Recover refrigerant.</li> <li>(10) Remove the 3 points of the compressor fixing nut using a spanner or a adjustable wrench.</li> <li>(11) Remove the welded pipe of the compressor, then remove the compressor.</li> </ol> <p><b>Note1 : Recover refrigerant without letting it out in the air.</b>  <b>Note2 : When replacing the soundproof lid, fit the lid to the wrapped cover without making a gap.</b></p>	<p><b>Photo 13</b></p>  <p>Terminal cover</p> <p>Lead wire of comp. surface thermistor (TH33)</p> <p>Lead wire for compressor</p> <p>Compressor (MC)</p> <p>Compressor fixing nuts</p>



OPERATING PROCEDURE	PHOTOS/FIGURES
<p><b>14. Removing the receiver</b></p> <ol style="list-style-type: none"><li>(1) Remove the service panel. (See Photo 1)</li><li>(2) Remove the top panel. (See Photo 1)</li><li>(3) Remove the cover panel. (See photo 1)</li><li>(4) Remove the stay and the side panel (R). (Refer to Procedure 9)</li><li>(5) Remove the electrical parts box. (Refer to Procedure 3)</li><li>(6) Recover the refrigerant.</li><li>(7) Remove 2 welded pipes of receiver.</li><li>(8) Remove 2 receiver leg fixing screws (4 × 10), then remove the receiver.</li></ol> <p><b>Note1 : Recover refrigerant without letting it out in the air.</b></p>	<p><b>Photo 14</b></p>  <p>Receiver leg fixing screw</p>
<p><b>15. Removing the plate heat exchanger</b></p> <ol style="list-style-type: none"><li>(1) Remove the service panel. (See Photo 1)</li><li>(2) Remove the top panel. (See Photo 1)</li><li>(3) Remove the cover panel. (See photo 1)</li><li>(4) Remove the stay and the side panel (R). (Refer to Procedure 9)</li><li>(5) Remove the electrical parts box. (Refer to Procedure 3)</li><li>(6) Recover the refrigerant</li><li>(7) Remove 2 welded pipes of plate heat exchanger inlet and outlet.</li><li>(8) Remove 2 plate heat exchanger fixing screws (4 × 10), then remove the plate heat exchanger.</li></ol> <p><b>Note1: Recover refrigerant without letting it out in the air.</b></p>	<p><b>Photo 15</b></p>  <p>Receiver Plate heat exchanger Plate heat exchanger fixing screw Plate heat exchanger fixing screw</p>
<p><b>16. Removing the pressure relief valve and the gasket</b></p> <ol style="list-style-type: none"><li>(1) Remove the service panel. (See Photo 1)</li><li>(2) Remove the top panel. (See Photo 1)</li><li>(3) Remove the cover panel. (See photo 1)</li><li>(4) Remove the stay and the side panel (R). (Refer to Procedure 9)</li><li>(5) Remove the electrical parts box. (Refer to Procedure 3)</li><li>(6) Drain the water in the plate heat exchanger.</li><li>(7) Loosen the nut of the pressure relief valve by a spanner (flat across width: 19mm).</li><li>(8) Remove the pressure relief valve and the gasket.<ul style="list-style-type: none"><li>• When reinstalling the G3/8" nut, use a new G3/8" gasket.</li></ul></li></ol> <p><b>Note1: The water may spout if the pressure relief valve is removed while the water is still inside the plate heat exchanger.</b></p> <p><b>Note2: Tightening torque of the nut: 15 ± 1 N.m.</b></p>	<p><b>Photo 16</b></p>  <p>Pressure relief valve Nut connecting the pressure relief valve</p>

## OPERATING PROCEDURE

### 17. Disassembling the electrical parts box

- (1) Remove the electrical parts box. (See Photo 3-1)
- (2) Disconnect all the connectors on the controller circuit board.
- (3) To remove the controller circuit board, release it from the support.
- (4) Remove the cont base front fixing screws (3 for front/ 4 × 10) to remove the cont base front.  
(The cont base front is fixed to the electrical parts box with a hook on the left side.)
- (5) Disconnect all the connectors on the power circuit board.
- (6) To remove the power circuit board, remove the power circuit board fixing screws (4 for front/ 3 × 12, 2 for front/ 4 × 18, and 1 for front 4 × 10), then release the board from the support.
- (7) Remove fixing screws (4 for rear/ 4 × 10) to remove the reactor (ACL), then disconnect the connectors on reactor.
- (8) Remove the thermistor <Heat sink> (TH8) fixing screws (2 for front/ 3 × 12) to remove the thermistor <Heat sink> (TH8).
- (9) To remove the heat sink, remove the heat sink duct fixing screws (6 for front/ 4 × 10), then slide the heat sink duct sideways to remove the heat sink.

**Note 1: When reassembling the electrical parts box, make sure the wirings are correct.**

**Note 2: The reactor is attached to the rear of the electrical parts box.**

## PHOTOS/FIGURES

Photo 17

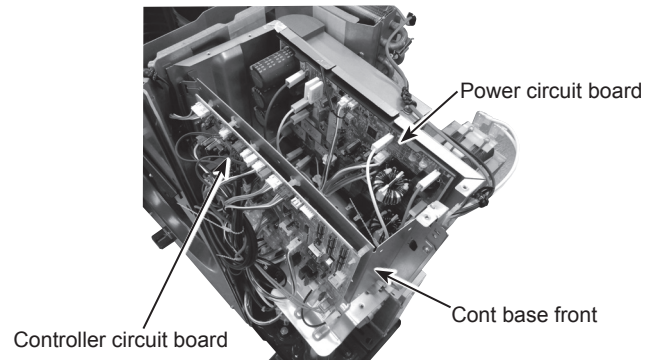


Photo 18

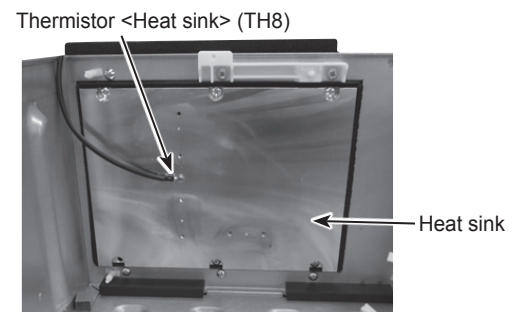
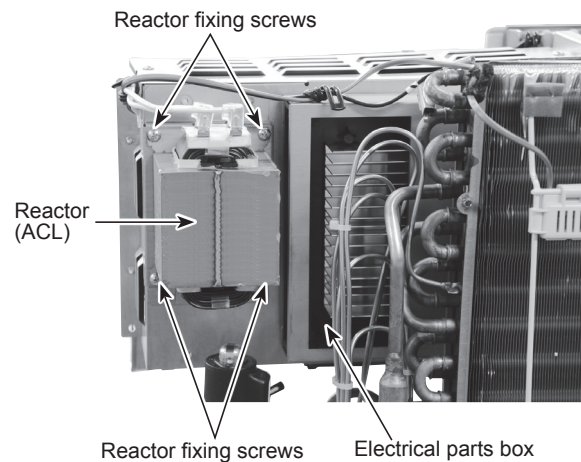


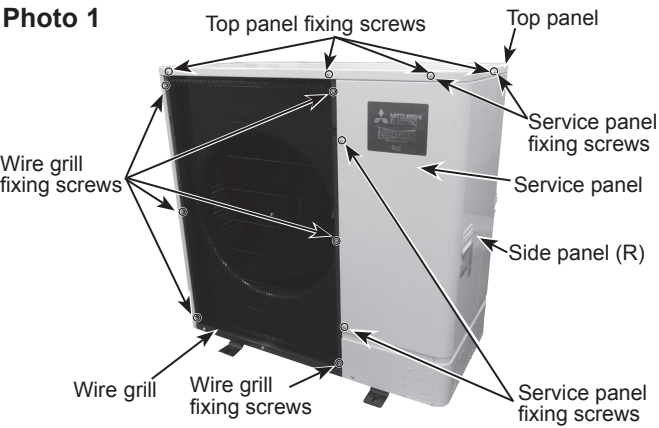
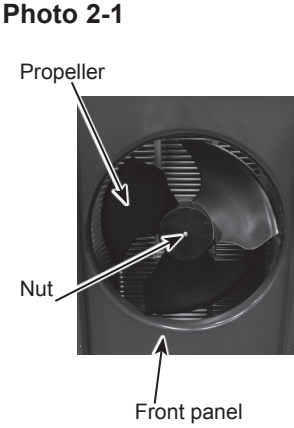
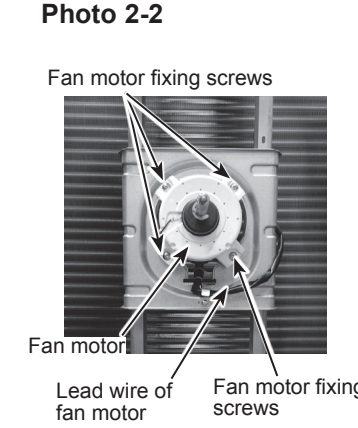
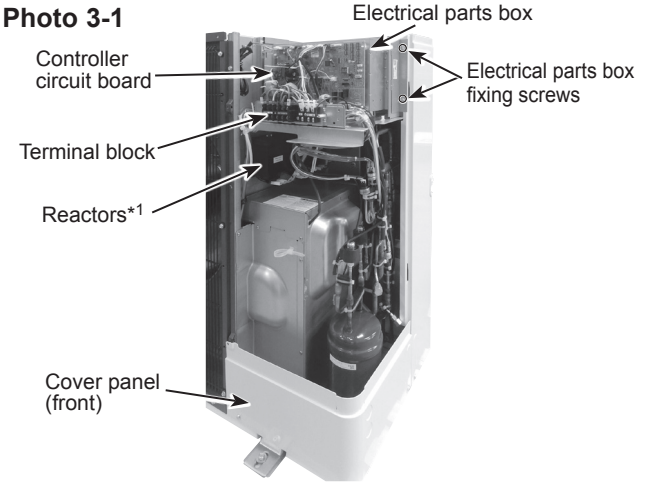
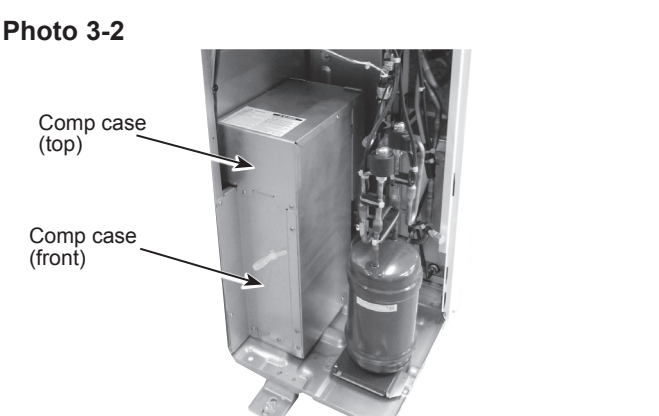
Photo 19



PUZ-WM60VAA.UK  
PUZ-WM60VAA-BS.UK

PUZ-WM85VAA.UK  
PUZ-WM85VAA-BS.UK

PUZ-WM85YAA.UK  
PUZ-WM85YAA-BS.UK

OPERATING PROCEDURE	PHOTOS/FIGURES
<p><b>1. Removing the service panel and top panel</b></p> <p>(1) Remove the service panel fixing screws (3 for front and 1 for right/ 5 × 12), then slide the service panel downward to remove it. (The service panel is fixed to the side panel (R) with a hook on the right side.)</p> <p>(2) Remove the top panel fixing screws (3 for front, 3 for rear and 1 for right/ 5 × 12) to remove the top panel.</p> <p><b>Note 1: When removing service panel and top panel at the same time, count 2 less screws since they share a screws.</b></p>	<p><b>Photo 1</b></p> 
<p><b>2. Removing the fan motor (MF1)</b></p> <p>(1) Remove the service panel. (See Photo 1)</p> <p>(2) Remove the top panel. (See Photo 1)</p> <p>(3) Remove the wire grill fixing screws (6 for front/ 5 × 12), then slide the wire grill upward to remove it. (See Photo 1)</p> <p>(4) Remove the screw of nut (1 for front/ M6), then slide the propeller fan forward to remove it.</p> <p>(5) Disconnect the connector CNF1 (WH) on the controller circuit board in the electrical parts box. (See Photo 3-1)</p> <p>(6) Loosen the clamps for the lead wire on motor support and separator.</p> <p>(7) Loosen the edge cover for the lead wire on separator.</p> <p>(8) Remove the fan motor fixing screws (4 for front/ 5 × 20) to remove the fan motor.</p> <p><b>Note 1: When attaching the fan motor, make sure to route the cable through the hook below the fan motor and fix firmly with the clamp.</b></p> <p><b>Note 2: Tighten the propeller fan with a torque of <math>5.7 \pm 0.3</math> N·m.</b></p>	<p><b>Photo 2-1</b></p>  <p><b>Photo 2-2</b></p> 
<p><b>3. Removing the electrical parts box</b></p> <p>(1) Remove the service panel. (See Photo 1)</p> <p>(2) Remove the top panel. (See Photo 1)</p> <p>(3) Disconnect the power supply cable from terminal block.</p> <p>(4) Disconnect the indoor/outdoor connecting wire from terminal block.</p> <p>(5) Loosen the cable strap for the lead wire on the comp case (front).</p> <p>(6) Disconnect the connectors CNF1 (WH), TH3 (WH), TH4 (WH), TH7/6 (RD), TH33 (YE), TH34 (RD), 63H (YE), 63HS (WH), 21S4 (GN), LEV-A (WH) and LEV-B (RD) from the controller circuit board.</p> <p>&lt;Symbols on the board&gt;</p> <ul style="list-style-type: none"> <li>• Fan motor (CNF1)</li> <li>• Thermistor &lt;Liquid&gt; (TH3)</li> <li>• Thermistor &lt;Discharge&gt; (TH4)</li> <li>• Thermistor &lt;Ambient/ 2-Phase pipe&gt; (TH7/6)</li> <li>• Thermistor &lt;Comp. Surface&gt; (TH33)</li> <li>• Thermistor &lt;Plate Hex Liquid&gt; (TH34)</li> <li>• High pressure switch (63H)</li> <li>• Pressure sensor (63HS)</li> <li>• 4-way valve (21S4)</li> <li>• LEV (LEV-A, LEV-B)</li> </ul> <p>(7) Disconnect the connectors ACL1 (RD), ACL2 (WH) and ACL3 (BK) on reactors in the separator.*1</p> <p>(8) Remove the cover panel (front) fixing screws (1 for front and 1 for right/ 5 × 12) to remove the cover panel (front).</p> <p>(9) Remove the comp case (top) fixing screws (2 for front and 1 for right/ 4 × 10) to remove the comp case (top).</p> <p>(10) Remove the comp case (front) fixing screws (4 for front and 2 for right/ 4 × 10) to remove the comp case (front).</p> <p>(11) Loosen the clamps, fasteners, band and cable straps for the lead wire in the electrical parts box and separator.</p> <p>(12) To disconnect the COMP lead wire, remove the terminal cover, then remove the terminal cover fixing screw of nut (1 for front/ M5).</p> <p>(13) Remove the electrical parts box fixing screws (2 for front/ 5 × 12), then slide the electrical parts box upward to remove it. (The electrical parts box is fixed to the side panel (R) with a hook on the right side, and to the separator duct with a hook on the left side.)</p> <p>*1 For W85Y model only</p>	<p><b>Photo 3-1</b></p>  <p><b>Photo 3-2</b></p> 



## OPERATING PROCEDURE

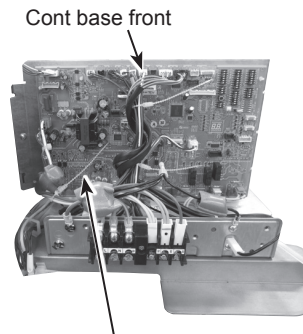
### 4. Disassembling the electrical parts box (V model only)

- (1) Remove the electrical parts box. (See Photo 3-1)
- (2) Disconnect all the connectors on the controller circuit board.
- (3) To remove the controller circuit board, release it from the support.
- (4) Remove the cont base front fixing screws (3 for front/ 4 × 10) to remove the cont base front. (The cont base front is fixed to the electrical parts box with a hook on the left side.)
- (5) Disconnect all the connectors on the power circuit board.
- (6) To remove the power circuit board, remove the power circuit board fixing screws (4 for front/ 3 × 12, 2 for front/ 4 × 18, and 1 for front 4 × 10), then release the board from the support.
- (7) Remove the reactor (DCL1, DCL2, DCL3) fixing screws (6 for rear/ 4 × 10) to remove the reactor, then disconnect the connectors on reactor.
- (8) Remove the thermistor <Heat sink> (TH8) fixing screws (2 for front/ 3 × 12) to remove the thermistor <Heat sink> (TH8).
- (9) To remove the heat sink, remove the heat sink duct fixing screws (6 for front/ 4 × 10), then slide the heat sink duct sideways to remove the heat sink.

**Note 1: When reassembling the electrical parts box, make sure the wirings are correct.**

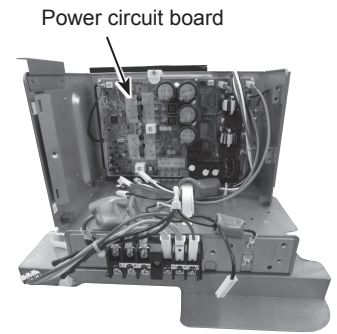
## PHOTOS/FIGURES

**Photo 4-1**

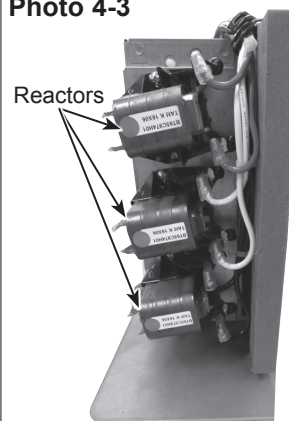


Controller circuit board

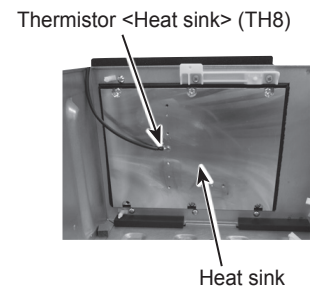
**Photo 4-2**



**Photo 4-3**



**Photo 4-4**

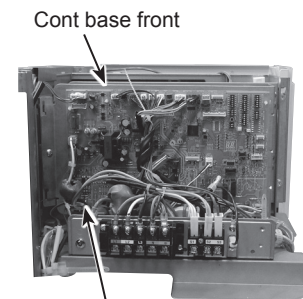


### 5. Disassembling the electrical parts box (Y model only)

- (1) Remove the electrical parts box. (See Photo 3-1)
- (2) Disconnect all the connectors on the controller circuit board.
- (3) To remove the controller circuit board, release it from the support.
- (4) Remove the cont base front fixing screws (3 for front/ 4 × 10) to remove the cont base front. (The cont base front is fixed to the electrical parts box with a hook on the left side.)
- (5) Disconnect all the connectors on the noise filter circuit board.
- (6) To remove the noise filter circuit board, release it from the support.
- (7) Remove the cont base fixing screws (3 for front/ 4 × 10) to remove the cont base. (The cont base is fixed to the electrical parts box with a hook on the left side.)
- (8) Disconnect all the connectors on the converter circuit board. (The converter circuit board is attached to the rear side of the cont base.)
- (9) To remove the converter circuit board, release it from the support.
- (10) Disconnect all the connectors on the power circuit board.
- (11) To remove the power circuit board, remove the power circuit board fixing screws (4 for front/ 4 × 14), then release the board from the support.
- (12) Remove the thermistor <Heat sink> (TH8) fixing screws (2 for front/ 3 × 12) to remove the thermistor <Heat sink> (TH8).
- (13) Disconnect the connectors on reactor (ACL4), resistor (RS) and capacitor (CK) first, then remove the fixing screws of reactor, resistor and capacitor (4 for front/ 4 × 10), and remove reactor, resistor, and capacitor.
- (14) To remove the heat sink, remove the heat sink duct fixing screws (6 for front/ 4 × 18), then slide the heat sink duct sideways to remove the heat sink.

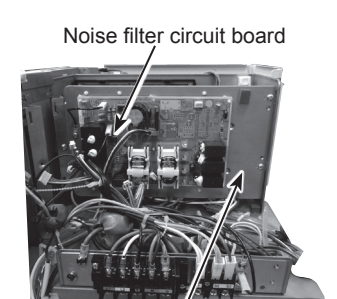
**Note 1: When reassembling the electrical parts box, make sure the wirings are correct.**

**Photo 5-1**



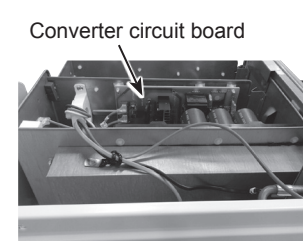
Controller circuit board

**Photo 5-2**

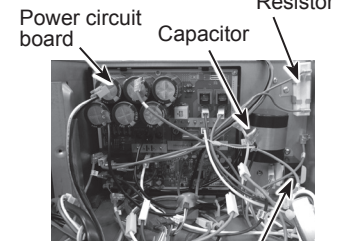


Cont base

**Photo 5-3**

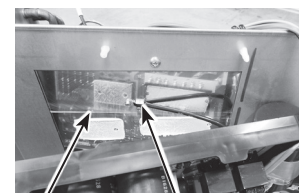


**Photo 5-4**



Reactor

**Photo 5-5**



Heat sink

Thermistor <Heat sink> (TH8)

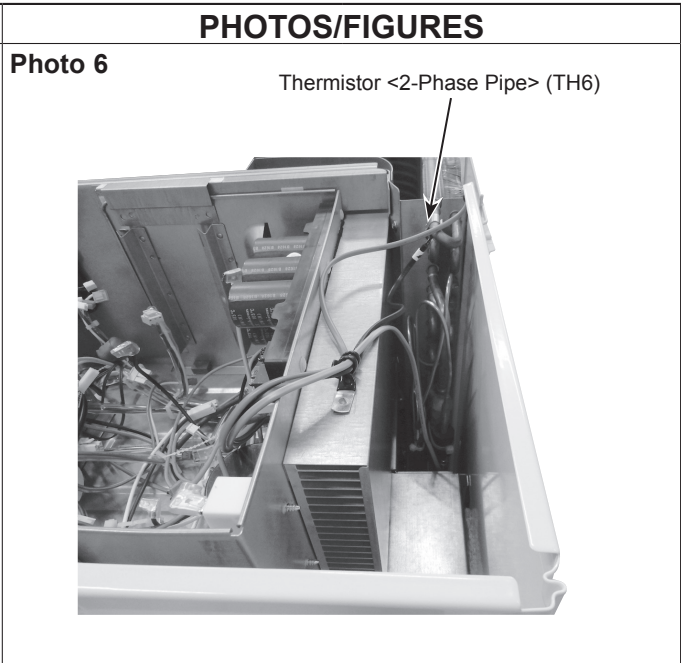


**OPERATING PROCEDURE**

**6. Removing the thermistor <2-Phase Pipe> (TH6)**

- (1) Remove the service panel. (See Photo 1)
- (2) Remove the top panel. (See Photo 1)
- (3) Disconnect the connector TH7/6 (RD) on the controller circuit board in the electrical parts box. (See Photo 3-1)
- (4) Loosen the fasteners and wire clips for the lead wire in the electrical parts box.
- (5) Loosen the clamp for the lead wire on the rear of electrical parts box.
- (6) Pull out the thermistor <2-phase pipe> (TH6) from thermistor clip.

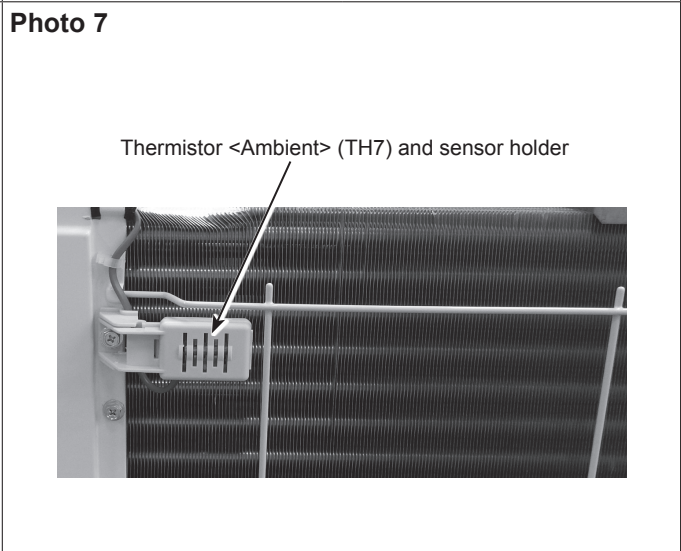
**Note 1: When replacing thermistor <2-phase pipe> (TH6), replace it together with thermistor <Ambient> (TH7) since they are combined together. Refer to procedure No.7 to remove the thermistor <Ambient> (TH7).**



**7. Removing the thermistor <Ambient> (TH7)**

- (1) Remove the service panel. (See Photo 1)
- (2) Remove the top panel. (See Photo 1)
- (3) Disconnect the connector TH7/6 (RD) on the controller circuit board in the electrical parts box. (See Photo 3-1)
- (4) Loosen the fasteners and wire clips for the lead wire in the electrical parts box.
- (5) Loosen the clamps for the lead wire on rear of electrical parts box.
- (6) Remove the sensor holder fixing screw (1 for rear/ 5 × 12) to remove the sensor holder.
- (7) Pull out the thermistor <Ambient> (TH7) from sensor holder.

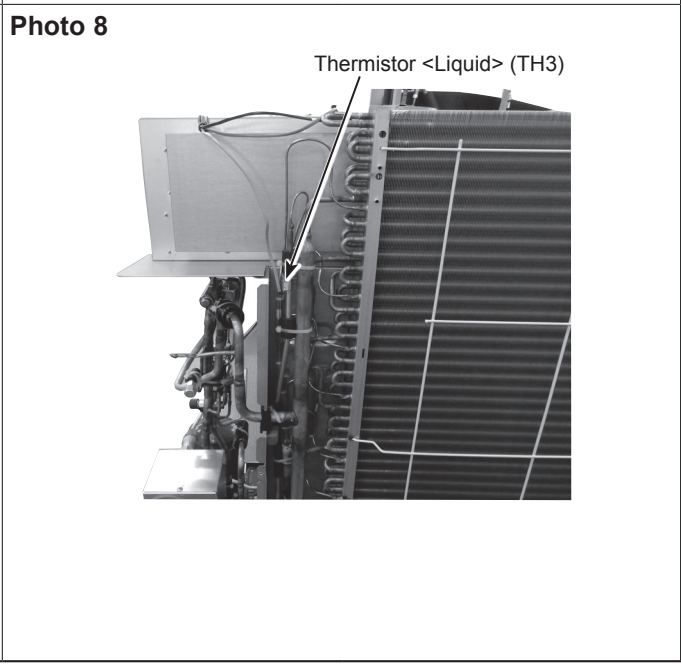
**Note 1: When replacing a thermistor <Ambient> (TH7), replace it together with thermistor <2-phase pipe> (TH6), since they are combined together. Refer to procedure No.6 to remove the thermistor <2-phase pipe>(TH6).**



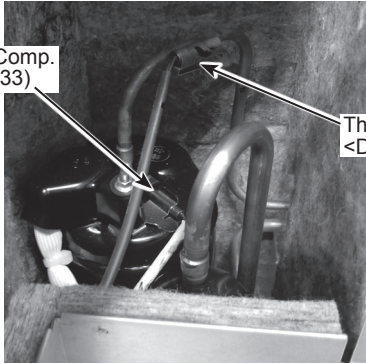
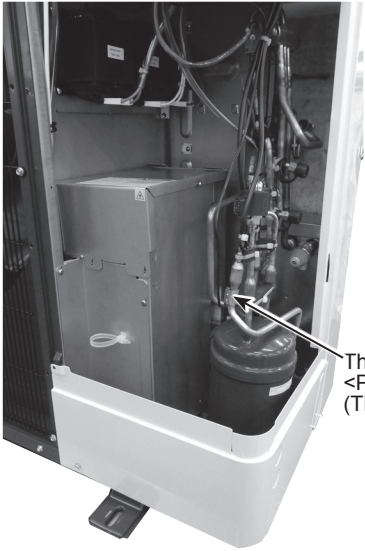
**8. Removing the thermistor <Liquid> (TH3)**

- (1) Remove the nozzle of plate heat exchanger for the water piping. (See Photo 14)
- (2) Remove the service panel. (See Photo 1)
- (3) Remove the top panel. (See Photo 1)
- (4) Remove the cover panel (front). (See Photo 3-1)
- (5) Remove the electrical parts box fixing screws (2 for front/ 5 × 12). (See Photo 3-1)
- (6) Remove the sensor holder.
- (7) Remove the side panel (R) fixing screws (4 for rear and 1 for right/ 5 × 12) to remove the side panel (R). (See Photo 1)
- (8) Disconnect the connector TH3 (WH) on the controller circuit board in the electrical parts box. (See Photo 3-1)
- (9) Loosen the fasteners and wire clips for the lead wire in the electrical parts box.
- (10) Loosen the clamp for the lead wires on the rear of electrical parts box.
- (11) Pull out the thermistor <Liquid> (TH3) from thermistor clip.

**Note 1: Drain the water in the plate heat exchanger before removing the water piping.**





OPERATING PROCEDURE	PHOTOS/FIGURES
<p><b>9. Removing the thermistor &lt;Discharge&gt; (TH4) and thermistor &lt;Comp. Surface&gt; (TH33)</b></p> <ol style="list-style-type: none"><li>(1) Remove the service panel. (See Photo 1)</li><li>(2) Remove the top panel. (See Photo 1)</li><li>(3) Remove the cover panel (front). (See Photo 3-1)</li><li>(4) Remove the comp case (top). (See Photo 3-2)</li><li>(5) Remove the comp case (front). (See Photo 3-2)</li><li>(6) Disconnect the connectors TH4 (WH) and TH33(YE) on the controller circuit board in the electrical parts box. (See Photo 3-1)</li><li>(7) Loosen the fasteners, wire clip and cable straps for the lead wires in the electrical parts box.</li><li>(8) Loosen the bands for the lead wires.</li><li>(9) Loosen the clamps for the lead wire in the separator.</li><li>(10) Pull out the thermistor &lt;Discharge&gt; (TH4) from thermistor holder.</li><li>(11) Pull out the thermistor &lt;Comp. Surface&gt; (TH33) from thermistor holder, then remove the terminal cover fixing screw of nut (1 for front/ M5).</li></ol>	<p><b>Photo 9</b></p>  <p>Thermistor &lt;Comp. Surface&gt; (TH33)</p> <p>Thermistor &lt;Discharge&gt; (TH4)</p>
<p><b>10. Removing the thermistor &lt;Plate Hex Liquid&gt; (TH34)</b></p> <ol style="list-style-type: none"><li>(1) Remove the service panel. (See Photo 1)</li><li>(2) Remove the top panel. (See Photo 1)</li><li>(3) Disconnect the connector TH34 (RD) on the controller circuit board in the electrical parts box. (See Photo 3-1)</li><li>(4) Loosen the fasteners and wire clips for the lead wire in the electrical parts box.</li><li>(5) Loosen the clamp for the lead wire on the bottom of electrical parts box.</li><li>(6) Detach the thermistor &lt;Plate Hex Liquid&gt; (TH34).</li></ol>	<p><b>Photo 10</b></p>  <p>Thermistor &lt;Plate hex liquid&gt; (TH34)</p>

## OPERATING PROCEDURE

## PHOTOS/FIGURES

### 11. Removing the 4-way valve coil (21S4), LEV coil (LEV-A, LEV-B) and lead wire for high pressure switch

- (1) Remove the electrical parts box. (See Photo 3-1)
- (2) Loosen the bands for the lead wire.

#### [Removing the 4-way valve coil]

- (3) Remove the 4-way valve coil fixing screw (1 for front/ M5) to remove the 4-way valve coil.
- (4) Slide the 4-way valve coil forward to remove it.

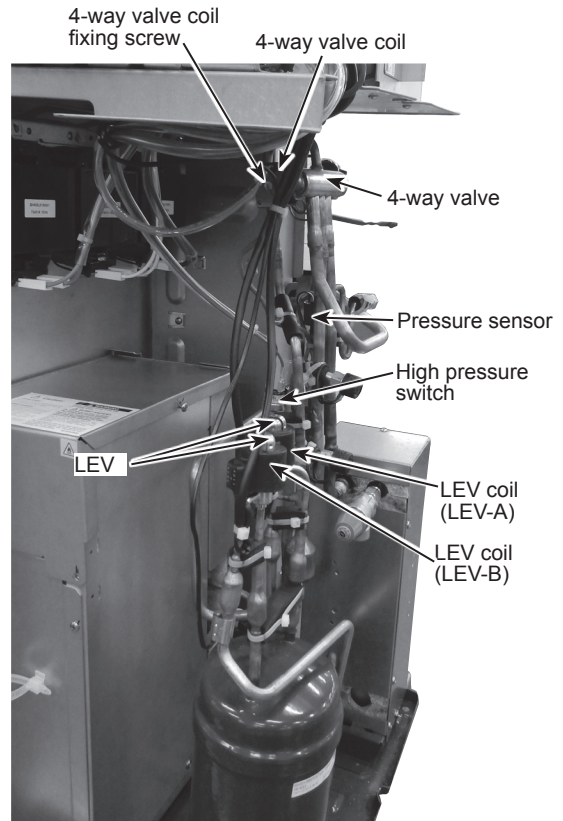
#### [Removing the LEV coil]

- (3) Loosen the lead wires fixed to the pipes with bands.
- (4) Slide the LEV coil upward to remove it.

#### [Removing the lead wire for high pressure switch]

- (3) Disconnect the lead wire from the high pressure switch.

Photo 11



### 12. Removing the 4-way valve, LEV (LEV-A, LEV-B), high pressure switch and pressure sensor

- (1) Remove the nozzle of plate heat exchanger for the water piping. (See Photo 14)
- (2) Remove the service panel. (See Photo 1)
- (3) Recover refrigerant.
- (4) Remove the electrical parts box. (See Photo 3-1)
- (5) Remove the side panel (R). (See Photo 1)

#### [Removing the 4-way valve]

- (6) Remove the 4-way valve coil.
- (7) Remove the welded part of 4-way valve (4 positions) to remove the 4-way valve.

#### [Removing the LEV]

- (6) Remove the LEV coil.
- (7) Loosen the LEV fixed to the pipe with a band and rubber mount.
- (8) Remove the welded part of LEV (2 positions) to remove the LEV.

#### [Removing the high pressure switch]

- (6) Disconnect the lead wire from the high pressure switch.
- (7) Loosen the high pressure switch fixed to the pipe with a band and rubber mount.
- (8) Remove the welded part of high pressure switch (1 position) to remove the high pressure switch.

#### [Removing the pressure sensor]

- (6) Loosen the pressure sensor fixed to the pipe with a band and rubber mount.
- (7) Remove the welded part of pressure sensor (1 position) to remove the pressure sensor.

**Note 1:** Drain the water in the plate heat exchanger before removing the water piping.

**Note 2:** Recover refrigerant without spreading it in the air.

**Note 3:** When installing the following parts, cover it with a wet cloth to prevent it from heating as the temperature below, then braze the pipes so that the inside of pipes are not oxidized;

- 4-way valve, 120°C or more
- LEV, 120°C or more
- High pressure switch, 100°C or more
- Pressure sensor, 100°C or more

## OPERATING PROCEDURE

### 13. Removing the compressor (MC)

- (1) Remove the nozzle of plate heat exchanger for the water piping. (See Photo 14)
- (2) Remove the service panel. (See Photo 1)
- (3) Recover refrigerant.
- (4) Remove the electrical parts box. (See Photo 3-1)
- (5) Remove the side panel (R). (See Photo 1)
- (6) Remove the thermistor <Plate Hex Liquid> (TH34), thermistor <Discharge> (TH4) and thermistor <Comp. Surface> (TH33). (See Photo 9 and 10)
- (7) Remove the 4-way valve coil and LEV coil. (See Photo 11)
- (8) Disconnect the lead wires from the pressure switch and sensor. (See Photo 11)
- (9) Loosen the rubber mount fixed to the receiver pipes with a band. (See Photo 13)
- (10) Remove the comp case (side) fixing screws (1 for front and 1 for right/ 4 x 10) to remove the comp case (side).
- (11) Remove the welded part (Joint part of the compressor, heat exchanger, receiver and plate heat exchanger) of piping (8 positions), then slide the piping upward to remove it.
- (12) Remove the compressor fixing nuts (3 for top/ M6) to remove the compressor.

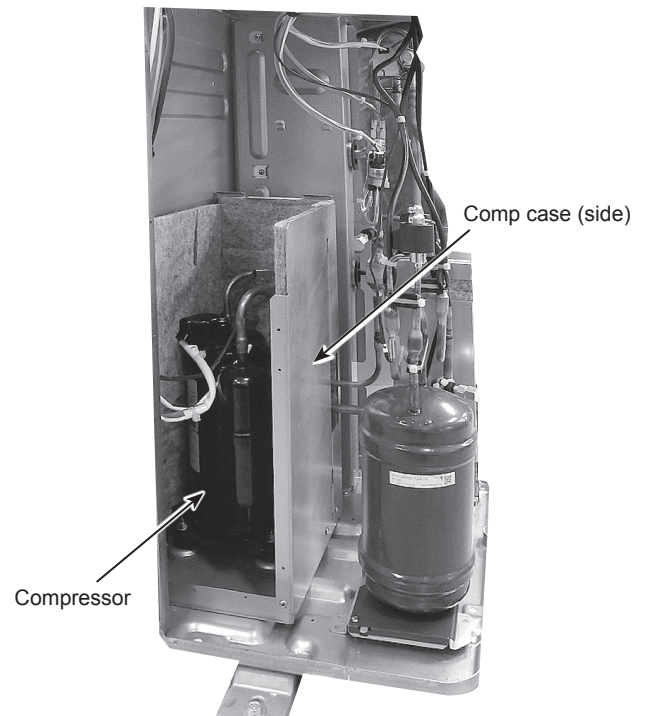
**Note 1: Drain the water in the plate heat exchanger before removing the water piping.**

**Note 2: Recover refrigerant without spreading it in the air.**

**Note 3: Tighten the nuts of compressor with a torque of  $4 \pm 0.4$  N·m.**

## PHOTOS/FIGURES

Photo 12



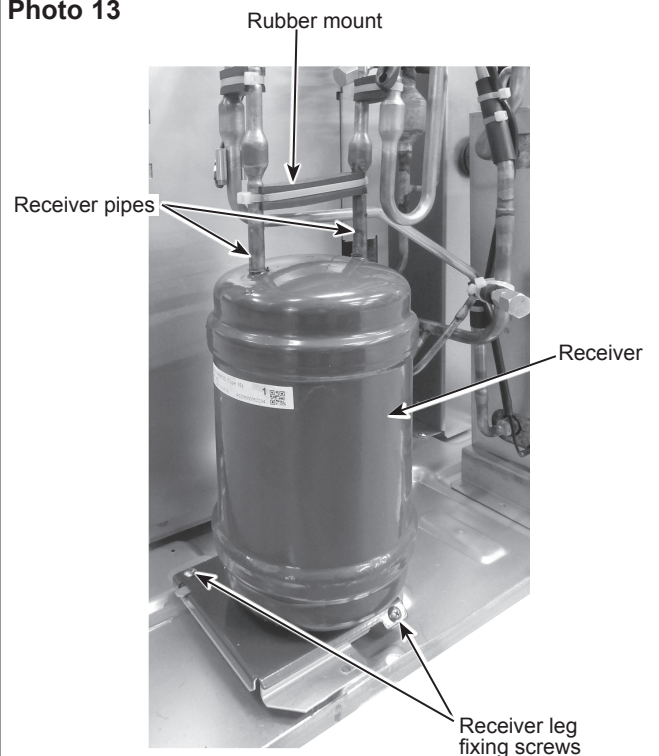
### 14. Removing the receiver

- (1) Remove the nozzle of plate heat exchanger for the water piping. (See Photo 14)
- (2) Remove the service panel. (See Photo 1)
- (3) Recover refrigerant.
- (4) Remove the piping.
- (5) Remove the receiver leg fixing screws (2 for top/ 4 x 10), then slide the receiver upward to remove it. (The receiver is fixed to the base with a hook on the bottom.)

**Note 1: Drain the water in the plate heat exchanger before removing the water piping.**

**Note 2: Recover refrigerant without spreading it in the air.**

Photo 13



## OPERATING PROCEDURE

### 15. Removing the plate heat exchanger

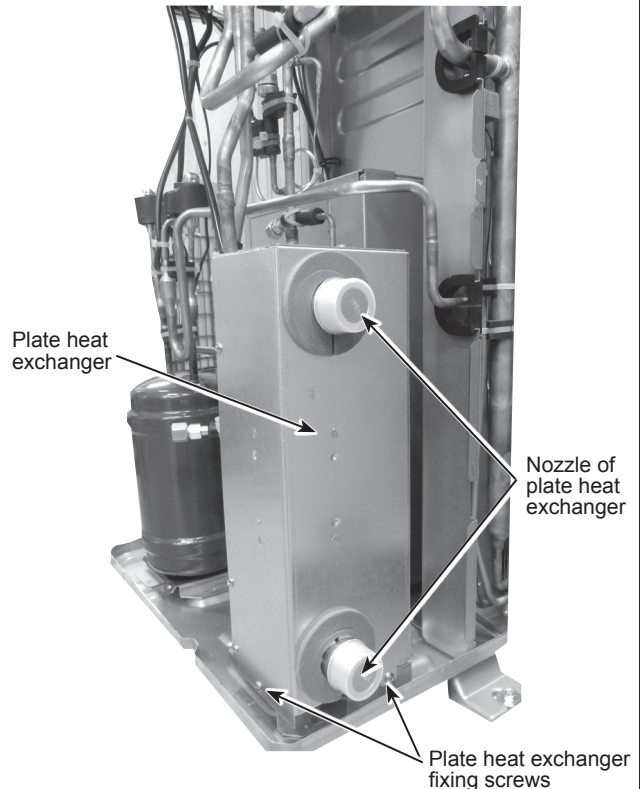
- (1) Remove the nozzle of plate heat exchanger for the water piping.
- (2) Remove the service panel. (See Photo 1)
- (3) Remove the refrigerant.
- (4) Remove the piping.
- (5) Remove the plate heat exchanger fixing screws (1 for right/ 4 × 10 and 1 for rear/ 4 × 10), then slide the plate heat exchanger upward to remove it.  
(The plate heat exchanger is fixed to the base with a hook on the bottom.)

**Note 1: Drain the water in the plate heat exchanger before removing the water piping.**

**Note 2: Recover refrigerant without spreading it in the air.**

## PHOTOS/FIGURES

Photo 14

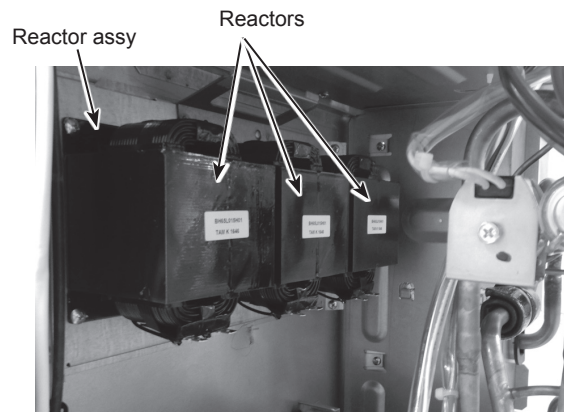


### 16. Removing the reactor (ACL1, ACL2, ACL3) (Y model only)

- (1) Remove the electrical parts box. (See Photo 3-1)
- (2) Remove the reactor assy fixing screws (4 for right/ 4 × 10), then slide the reactor assy upward to remove it.
- (3) Remove the reactor fixing screws (4 for front/ 4 × 10), to remove the reactor on the reactor assy.

**Note 1: Pay extra attention when handling the reactor since it is very heavy (4.1 kg).**

Photo 15



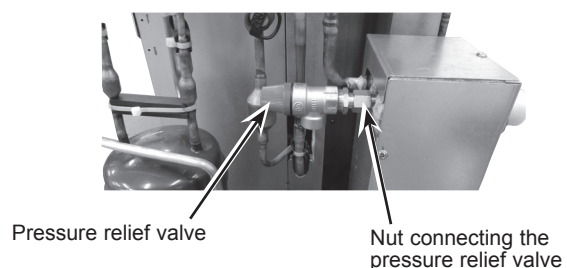
### 17. Removing the pressure relief valve and the gasket

- (1) Remove the service panel. (See Photo 1)
- (2) Remove the top panel. (See Photo 1)
- (3) Remove the cover panel. (See photo 1)
- (4) Remove the stay and the side panel (R). (Refer to Procedure 9)
- (5) Remove the electrical parts box. (Refer to Procedure 3)
- (6) Drain the water in the plate heat exchanger.
- (7) Loosen the nut of the pressure relief valve by a spanner (flat across width: 19mm).
- (8) Remove the pressure relief valve and the gasket.
  - When reinstalling the G3/8" nut, use a new G3/8" gasket.

**Note1: The water may spout if the pressure relief valve is removed while the water is still inside the plate heat exchanger.**

**Note2: Tightening torque of the nut: 15 ± 1 N.m.**

Photo 16



**OPERATING PROCEDURE**

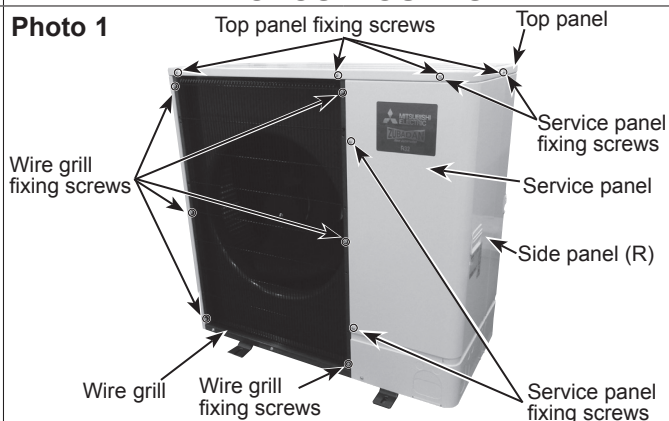
**PHOTOS/FIGURES**

**1. Removing the service panel and top panel**

- (1) Remove the service panel fixing screws (3 for front and 1 for right/ 5 × 12), then slide the service panel downward to remove it.  
 (The service panel is fixed to the side panel (R) with a hook on the right side.)
- (2) Remove the top panel fixing screws (3 for front, 3 for rear and 1 for right/ 5 × 12) to remove the top panel.

**Note 1: When removing service panel and top panel at the same time, count 2 less screws since they share a screws.**

**Photo 1**



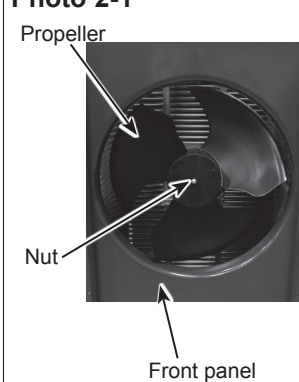
**2. Removing the fan motor (MF1)**

- (1) Remove the service panel. (See Photo 1)
- (2) Remove the top panel. (See Photo 1)
- (3) Remove the wire grille fixing screws (6 for front/ 5 × 12), then slide the wire grille upward to remove it. (See Photo 1)
- (4) Remove the screw of nut (1 for front/ M6), then slide the propeller fan forward to remove it.
- (5) Disconnect the connector CNF1 (WH) on the controller circuit board in the electrical parts box. (See Photo 3-1)
- (6) Loosen the clamps for the lead wire on motor support and separator.
- (7) Loosen the edge cover for the lead wire on separator.
- (8) Remove the fan motor fixing screws (4 for front/ 5 × 20) to remove the fan motor.

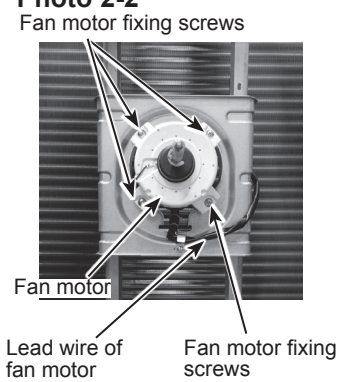
**Note 1: When attaching the fan motor, make sure to route the cable through the hook below the fan motor and fix firmly with the clamp.**

**Note 2: Tighten the propeller fan with a torque of 5.7 ± 0.3 N·m.**

**Photo 2-1**



**Photo 2-2**

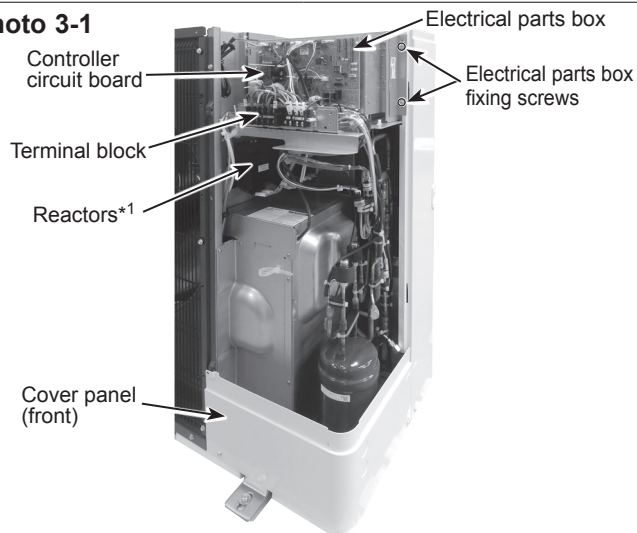


**3. Removing the electrical parts box**

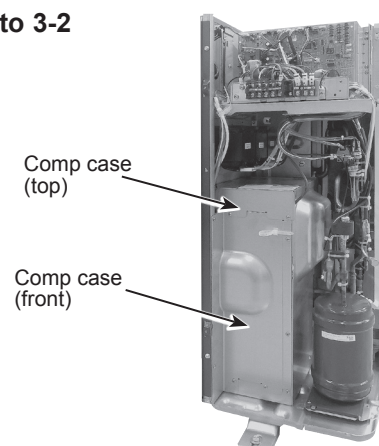
- (1) Remove the service panel. (See Photo 1)
- (2) Remove the top panel. (See Photo 1)
- (3) Disconnect the power supply cable from terminal block.
- (4) Disconnect the indoor/outdoor connecting wire from terminal block.
- (5) Loosen the cable strap for the lead wire on the comp case (front).
- (6) Disconnect the connectors CNF1 (WH), TH3 (WH), TH4 (WH), TH7/6 (RD), TH33 (YE), TH34 (RD), 63H (YE), 63HS (WH), 21S4 (GN), LEV-A (WH) and LEV-B (RD) from the controller circuit board.  
 <Symbols on the board>
  - Fan motor (CNF1)
  - Thermistor <Liquid> (TH3)
  - Thermistor <Discharge> (TH4)
  - Thermistor <Ambient/2-Phase pipe> (TH7/6)
  - Thermistor <Comp. Surface> (TH33)
  - Thermistor <Plate Hex Liquid> (TH34)
  - High pressure switch (63H)
  - Pressure sensor (63HS)
  - 4-way valve (21S4)
  - LEV (LEV-A, LEV-B)
- (7) Disconnect the connectors ACL1 (RD), ACL2(WH) and ACL3(BK) on reactors in the separator.\*1
- (8) Remove the cover panel (front) fixing screws (1 for front and 1 for right/ 5 × 12) to remove the cover panel (front).
- (9) Remove the comp case (top) fixing screws (2 for front and 1 for right/ 4 × 10) to remove the comp case (top).
- (10) Remove the comp case (front) fixing screws (4 for front and 2 for right/ 4 × 10) to remove the comp case (front).
- (11) Loosen the clamps, fasteners, band and cable straps for the lead wire in the electrical parts box and separator.
- (12) To disconnect the COMP lead wire, remove the terminal cover.
- (13) Remove the electrical parts box fixing screws (2 for front/ 5 × 12), then slide the electrical parts box upward to remove it.  
 (The electrical parts box is fixed to the side panel (R) with a hook on the right side, and to the separator duct with a hook on the left side.)

\*1 For W112Y model only

**Photo 3-1**



**Photo 3-2**



## OPERATING PROCEDURE

## PHOTOS/FIGURES

### 4. Disassembling the electrical parts box (V model only)

- (1) Remove the electrical parts box. (See Photo 3-1)
- (2) Disconnect all the connectors on the controller circuit board.
- (3) To remove the controller circuit board, release it from the support.
- (4) Remove the cont base front fixing screws (3 for front/ 4 × 10) to remove the cont base front.  
(The cont base front is fixed to the electrical parts box with a hook on the left side.)
- (5) Disconnect all the connectors on the power circuit board.
- (6) To remove the power circuit board, remove the power circuit board fixing screws (4 for front/ 3 × 12, 2 for front/ 4 × 18, and 1 for front/ 4 × 10), then release the board from the support.
- (7) Remove the reactor (DCL1, DCL2, DCL3) fixing screws (6 for rear/ 4 × 10) to remove the reactor, then disconnect the connectors on reactor.
- (8) Remove the thermistor <Heat sink> (TH8) fixing screws (2 for front/ 3 × 12) to remove the thermistor <Heat sink> (TH8).
- (9) To remove the heat sink, remove the heat sink duct fixing screws (6 for front/ 4 × 10), then slide the heat sink duct sideways to remove the heat sink.

**Note 1: When reassembling the electrical parts box, make sure the wirings are correct.**

Photo 4-1

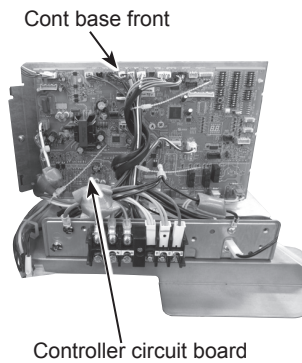


Photo 4-2

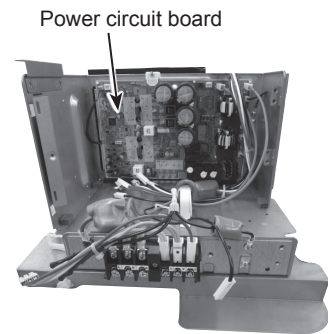


Photo 4-3

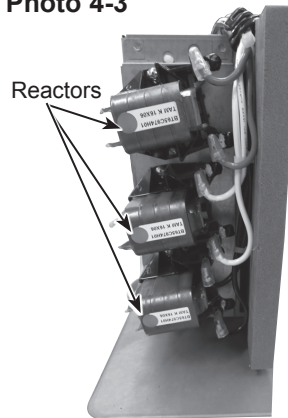
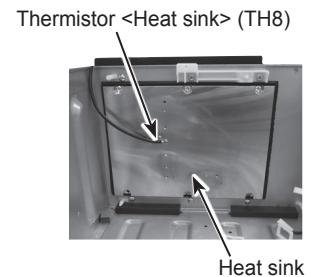


Photo 4-4



### 5. Disassembling the electrical parts box (Y model only)

- (1) Remove the electrical parts box. (See Photo 3-1)
- (2) Disconnect all the connectors on the controller circuit board.
- (3) To remove the controller circuit board, release it from the support.
- (4) Remove the cont base front fixing screws (3 for front/ 4 × 10) to remove the cont base front.  
(The cont base front is fixed to the electrical parts box with a hook on the left side.)
- (5) Disconnect all the connectors on the noise filter circuit board.
- (6) To remove the noise filter circuit board, release it from the support.
- (7) Remove the cont base fixing screws (3 for front/ 4 × 10) to remove the cont base.  
(The cont base is fixed to the electrical parts box with a hook on the left side.)
- (8) Disconnect all the connectors on the converter circuit board. (The converter circuit board is attached to the rear side of the cont base.)
- (9) To remove the converter circuit board, release it from the support.
- (10) Disconnect all the connectors on the power circuit board.
- (11) To remove the power circuit board, remove the power circuit board fixing screws (4 for front/ 4 × 14), then release the board from the support.
- (12) Remove the thermistor <Heat sink> (TH8) fixing screws (2 for front/ 3 × 12) to remove the thermistor <Heat sink> (TH8).
- (13) Disconnect the connectors on reactor (ACL4), resistor (RS) and capacitor (CK) first, then remove the fixing screws of reactor, resistor and capacitor (4 for front/ 4 × 10), and remove reactor, resistor and capacitor.
- (14) To remove the heat sink, remove the heat sink duct fixing screws (6 for front/ 4 × 18), then slide the heat sink duct sideways to remove the heat sink.

**Note 1: When reassembling the electrical parts box, make sure the wirings are correct.**

Photo 5-1

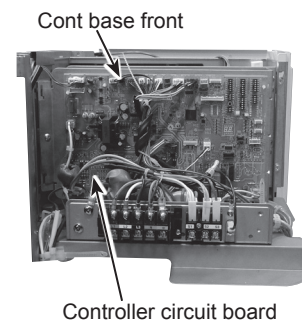


Photo 5-2

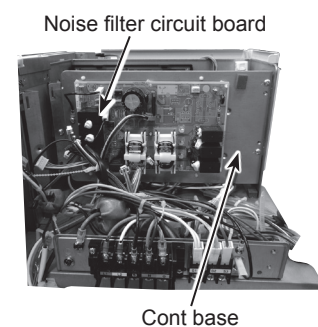


Photo 5-3

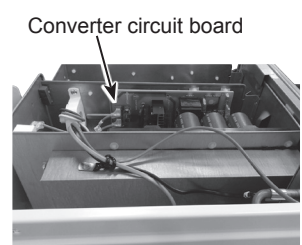


Photo 5-4

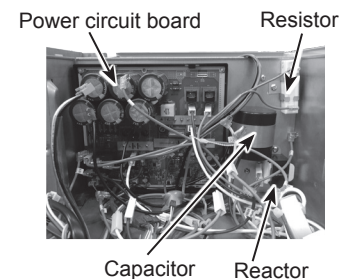
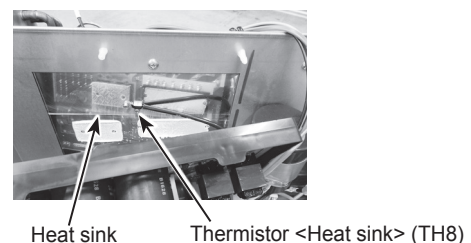
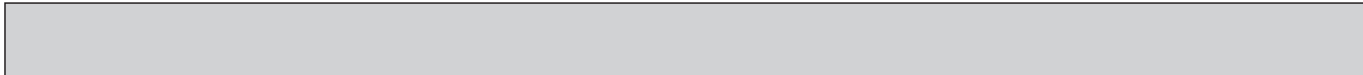
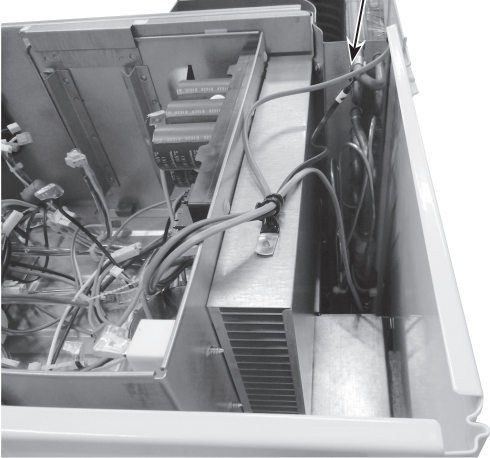
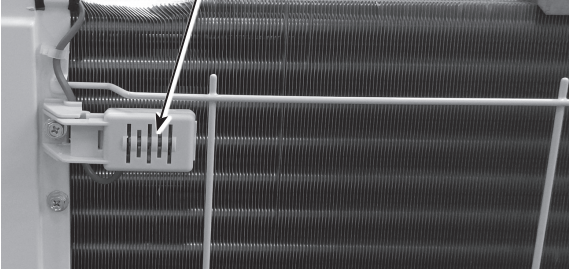
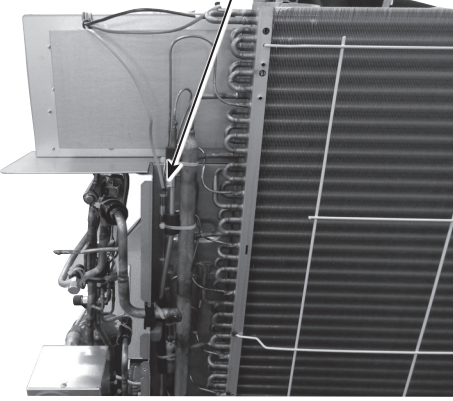


Photo 5-5







OPERATING PROCEDURE	PHOTOS/FIGURES
<p><b>6. Removing the thermistor &lt;2-Phase Pipe&gt; (TH6)</b></p> <ol style="list-style-type: none"> <li>(1) Remove the service panel. (See Photo 1)</li> <li>(2) Remove the top panel. (See Photo 1)</li> <li>(3) Disconnect the connector TH7/6 (RD) on the controller circuit board in the electrical parts box. (See Photo 3-1)</li> <li>(4) Loosen the fasteners and wire clips for the lead wire in the electrical parts box.</li> <li>(5) Loosen the clamp for the lead wire on the rear of electrical parts box.</li> <li>(6) Pull out the thermistor &lt;2-phase pipe&gt; (TH6) from thermistor clip.</li> </ol> <p><b>Note 1: When replacing thermistor &lt;2-phase pipe&gt; (TH6), replace it together with thermistor &lt;Ambient&gt; (TH7) since they are combined together. Refer to procedure No.7 to remove the thermistor &lt;Ambient&gt; (TH7).</b></p>	<p><b>Photo 6</b></p> <p style="text-align: right;">Thermistor &lt;2-Phase Pipe&gt; (TH6)</p> 
<p><b>7. Removing the thermistor &lt;Ambient&gt; (TH7)</b></p> <ol style="list-style-type: none"> <li>(1) Remove the service panel. (See Photo 1)</li> <li>(2) Remove the top panel. (See Photo 1)</li> <li>(3) Disconnect the connector TH7/6 (RD) on the controller circuit board in the electrical parts box. (See Photo 3-1)</li> <li>(4) Loosen the fasteners and wire clips for the lead wire in the electrical parts box.</li> <li>(5) Loosen the clamps for the lead wire on rear of electrical parts box.</li> <li>(6) Remove the sensor holder fixing screw (1 for rear/ 5 × 12) to remove the sensor holder.</li> <li>(7) Pull out the thermistor &lt;Ambient&gt; (TH7) from sensor holder.</li> </ol> <p><b>Note 1: When replacing a thermistor &lt;Ambient&gt; (TH7), replace it together with thermistor &lt;2-phase pipe&gt; (TH6), since they are combined together. Refer to procedure No.6 to remove the thermistor &lt;2-phase pipe&gt;(TH6).</b></p>	<p><b>Photo 7</b></p> <p style="text-align: right;">Thermistor &lt;Ambient&gt; (TH7) and sensor holder</p> 
<p><b>8. Removing the thermistor &lt;Liquid&gt; (TH3)</b></p> <ol style="list-style-type: none"> <li>(1) Remove the nozzle of plate heat exchanger for the water piping. (See Photo 14)</li> <li>(2) Remove the service panel. (See Photo 1)</li> <li>(3) Remove the top panel. (See Photo 1)</li> <li>(4) Remove the cover panel (front). (See Photo 3-1)</li> <li>(5) Remove the electrical parts box fixing screws (2 for front/ 5 × 12). (See Photo 3-1)</li> <li>(6) Remove the sensor holder.</li> <li>(7) Remove the side panel (R) fixing screws (4 for rear and 1 for right/ 5 × 12) to remove the side panel (R). (See Photo 1)</li> <li>(8) Disconnect the connector TH3 (WH) on the controller circuit board in the electrical parts box. (See Photo 3-1)</li> <li>(9) Loosen the fasteners and wire clips for the lead wire in the electrical parts box.</li> <li>(10) Loosen the clamp for the lead wire on the rear of electrical parts box.</li> <li>(11) Pull out the thermistor &lt;Liquid&gt; (TH3) from thermistor clip.</li> </ol> <p><b>Note 1: Drain the water in the plate heat exchanger before removing the water piping.</b></p>	<p><b>Photo 8</b></p> <p style="text-align: right;">Thermistor &lt;Liquid&gt; (TH3)</p> 

## OPERATING PROCEDURE

### 9. Removing the thermistor <Discharge> (TH4) and thermistor <Comp. Surface> (TH33)

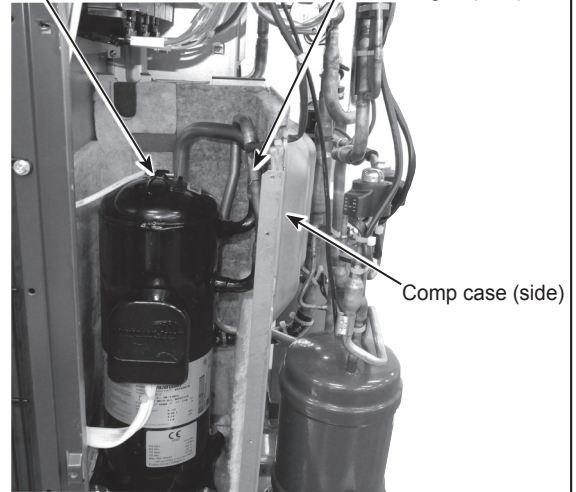
- (1) Remove the service panel. (See Photo 1)
- (2) Remove the top panel. (See Photo 1)
- (3) Remove the cover panel (front). (See Photo 3-1)
- (4) Remove the comp case (top). (See Photo 3-2)
- (5) Remove the comp case (front). (See Photo 3-2)
- (6) Disconnect the connectors TH4 (WH) and TH33 (YE) on the controller circuit board in the electrical parts box. (See Photo 3-1)
- (7) Loosen the fasteners, wire clip and cable straps for the lead wire in the electrical parts box.
- (8) Loosen the bands for the lead wire.
- (9) Loosen the clamps for the lead wire in the separator.
- (10) Loosen the edge cover for the lead wire on the comp case (side).
- (11) Pull out the thermistor <Discharge> (TH4) from thermistor holder.
- (12) Pull out the thermistor <Comp. Surface> (TH33) from thermistor holder.

## PHOTOS/FIGURES

Photo 9

Thermistor  
<Comp.Surface>  
(TH33)

Thermistor  
<Discharge> (TH4)

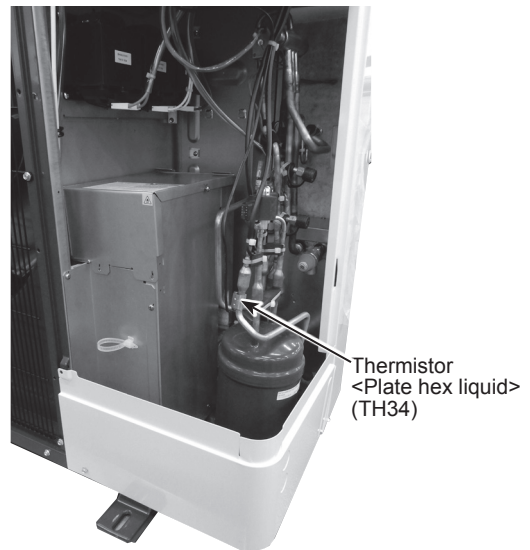


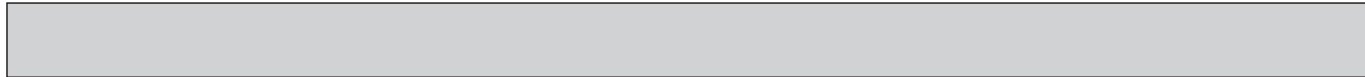
### 10. Removing the thermistor <Plate Hex Liquid> (TH34)

- (1) Remove the service panel. (See Photo 1)
- (2) Remove the top panel. (See Photo 1)
- (3) Disconnect the connector TH34 (RD) on the controller circuit board in the electrical parts box. (See Photo 3-1)
- (4) Loosen the fasteners and wire clips for the lead wire in the electrical parts box.
- (5) Loosen the clamp for the lead wire on the bottom of electrical parts box.
- (6) Detach the thermistor <Plate Hex Liquid> (TH34).

Photo 10

Thermistor  
<Plate hex liquid>  
(TH34)





**OPERATING PROCEDURE**

**11. Removing the 4-way valve coil (21S4), LEV coil (LEV-A, LEV-B), lead wires for high pressure switch**

- (1) Remove the electrical parts box. (See Photo 3-1)
- (2) Loosen the bands for the lead wire.

**[Removing the 4-way valve coil]**

- (3) Remove the 4-way valve coil fixing screw (1 for front/ M5) to remove the 4-way valve coil.
- (4) Slide the 4-way valve coil forward to remove it.

**[Removing the LEV coil]**

- (3) Loosen the lead wires fixed to the pipes with a band.
- (4) Slide the LEV coil upward to remove it.

**[Removing the lead wire for high pressure switch]**

- (3) Disconnect the lead wire from the high pressure switch.

**12. Removing the 4-way valve, LEV (LEV-A, LEV-B), high pressure switch and pressure sensor**

- (1) Remove the nozzle of plate heat exchanger for the water piping. (See Photo 14)
- (2) Remove the service panel. (See Photo 1)
- (3) Recover refrigerant.
- (4) Remove the electrical parts box. (See Photo 3-1)
- (5) Remove the side panel (R). (See Photo 1)

**[Removing the 4-way valve]**

- (6) Remove the 4-way valve coil.
- (7) Remove the welded part of 4-way valve (4 positions) to remove the 4-way valve.

**[Removing the LEV]**

- (6) Remove the LEV coil.
- (7) Loosen the LEV fixed to the pipe with a band and rubber mount.
- (8) Remove the welded part of LEV (2 positions) to remove the LEV.

**[Removing the high pressure switch]**

- (6) Disconnect the lead wire from the high pressure switch.
- (7) Loosen the pressure switch fixed to the pipe with a band and rubber mount.
- (8) Remove the welded part of high pressure switch (1 position) to remove the pressure switch.

**[Removing the pressure sensor]**

- (6) Loosen the pressure sensor fixed to the pipe with a band and rubber mount.
- (7) Remove the welded part of pressure sensor (1 position) to remove the high pressure sensor.

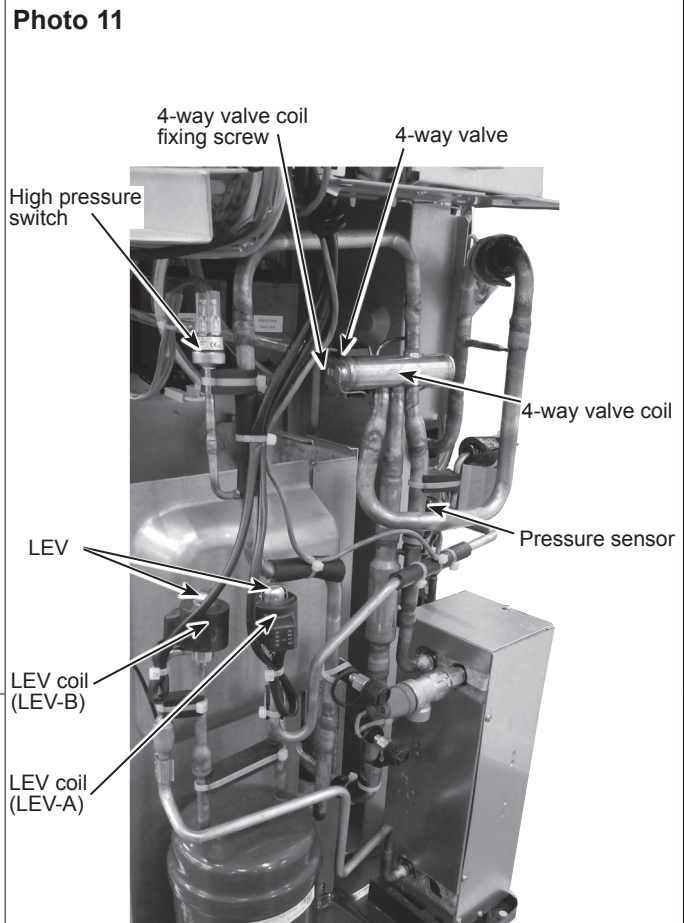
**Note 1: Drain the water in the plate heat exchanger before removing the water piping.**

**Note 2: Recover refrigerant without spreading it in the air.**

**Note 3: When installing the following parts, cover it with a wet cloth to prevent it from heating as the temperature below, then braze the pipes so that the inside of pipes are not oxidized;**

- 4-way valve, 120°C or more
- LEV, 120°C or more
- High pressure switch, 100°C or more
- Pressure sensor, 100°C or more

**PHOTOS/FIGURES**



## OPERATING PROCEDURE

### 13. Removing the compressor (MC)

- (1) Remove the nozzle of plate heat exchanger for the water piping. (See Photo 14)
- (2) Remove the service panel. (See Photo 1)
- (3) Recover refrigerant.
- (4) Remove the electrical parts box. (See Photo 3-1)
- (5) Remove the side panel (R). (See Photo 1)
- (6) Remove the thermistor <Plate Hex Liquid> (TH34), thermistor <Discharge> (TH4) and thermistor <Comp. Surface> (TH33). (See Photo 9 and 10)
- (7) Remove the 4-way valve coil and LEV coil. (See Photo 11)
- (8) Disconnect the lead wires from the pressure switch and sensor. (See Photo 11)
- (9) Loosen the rubber mount fixed to the receiver pipes with a band. (See Photo 13)
- (10) Remove the comp case (side) fixing screws (1 for front and 1 for right/ 4 × 10) to remove the comp case (side).
- (11) Remove the welded part (Joint part of the compressor, heat exchanger, receiver and plate heat exchanger) of piping (8 positions), then slide the piping upward to remove it.
- (12) Remove the compressor fixing nuts (3 for top/ M6) to remove the compressor.

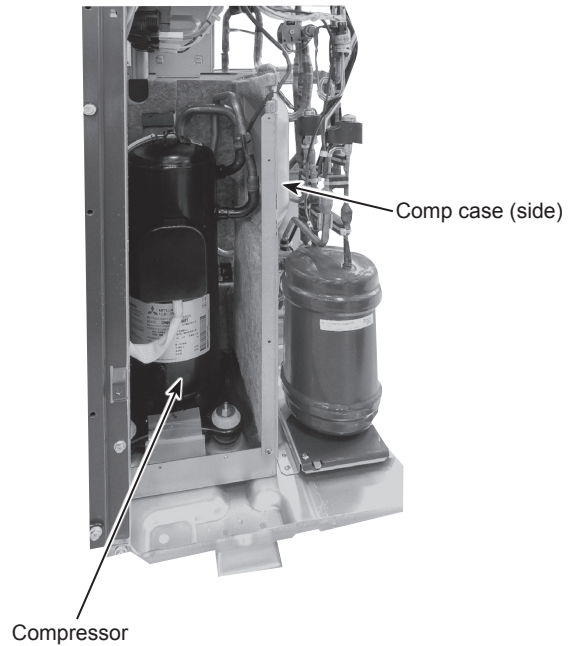
**Note 1:** Drain the water in the plate heat exchanger before removing the water piping.

**Note 2:** Recover refrigerant without spreading it in the air.

**Note 3:** Tighten the nuts of compressor with a torque of  $4 \pm 0.4 \text{ N}\cdot\text{m}$ .

## PHOTOS/FIGURES

Photo 12



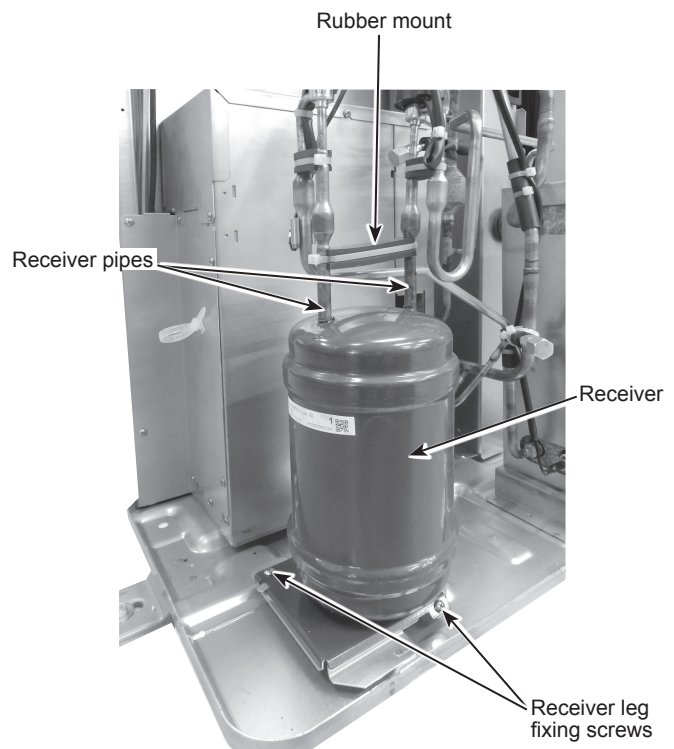
### 14. Removing the receiver

- (1) Remove the nozzle of plate heat exchanger for the water piping. (See Photo 14)
- (2) Remove the service panel. (See Photo 1)
- (3) Recover refrigerant.
- (4) Remove the piping.
- (5) Remove the receiver leg fixing screws (2 for top/ 4 × 10), then slide the receiver upward to remove it. (The receiver is fixed to the base with a hook on the bottom.)

**Note 1:** Drain the water in the plate heat exchanger before removing the water piping.

**Note 2:** Recover refrigerant without spreading it in the air.

Photo 13



## OPERATING PROCEDURE

### 15. Removing the plate heat exchanger

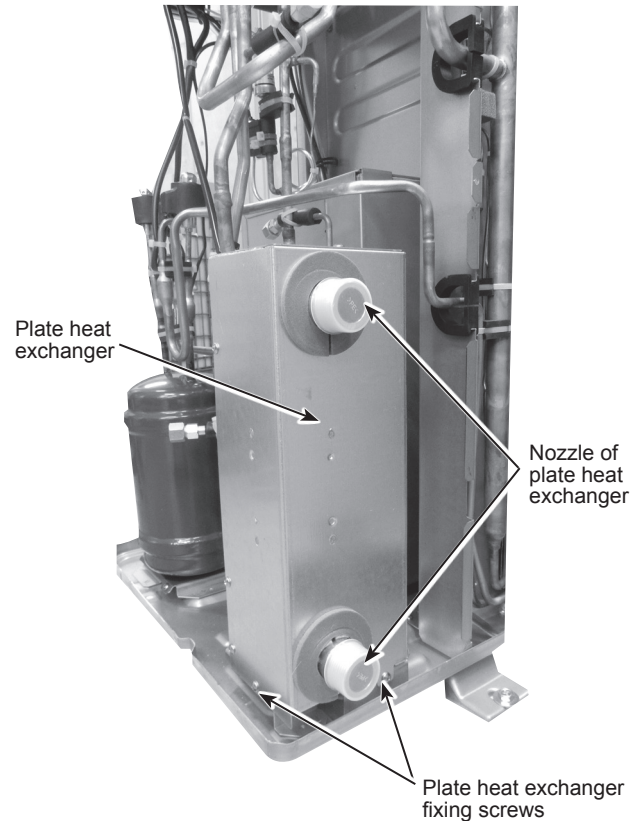
- (1) Remove the nozzle of plate heat exchanger for the water piping.
- (2) Remove the service panel. (See Photo 1)
- (3) Recover refrigerant.
- (4) Remove the piping.
- (5) Remove the plate heat exchanger fixing screws (1 for right/ 4 × 10 and 1 for rear/ 4 × 10), then slide the plate heat exchanger upward to remove it.  
(The plate heat exchanger is fixed to the base with a hook on the bottom.)

**Note 1: Drain the water in the plate heat exchanger before removing the water piping.**

**Note 2: Recover refrigerant without spreading it in the air.**

## PHOTOS/FIGURES

Photo 14



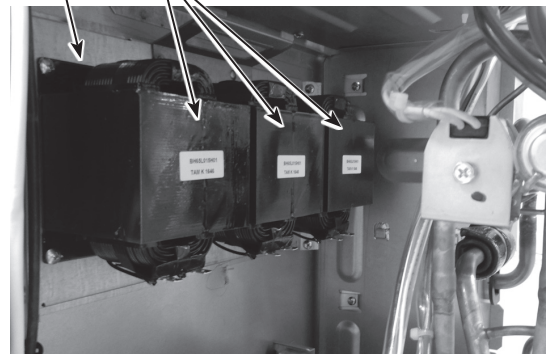
### 16. Removing the reactor (ACL1, ACL2, ACL3) (Y model only)

- (1) Remove the electrical parts box. (See Photo 3-1)
- (2) Remove the reactor assy fixing screws (4 for right/ 4 × 10), then slide the reactor assy upward to remove it.
- (3) Remove the reactor fixing screws (4 for front/ 4 × 10) to remove the reactor on the reactor assy.

**Note 1: Pay extra attention when handling the reactor since it is very heavy (4.1 kg).**

Photo 15

Reactor assy Reactors



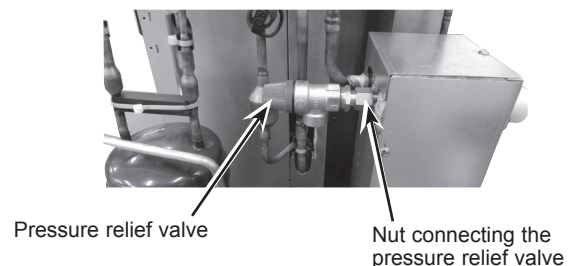
### 17. Removing the pressure relief valve and the gasket

- (1) Remove the service panel. (See Photo 1)
- (2) Remove the top panel. (See Photo 1)
- (3) Remove the cover panel. (See photo 1)
- (4) Remove the stay and the side panel (R). (Refer to Procedure 9)
- (5) Remove the electrical parts box. (Refer to Procedure 3)
- (6) Drain the water in the plate heat exchanger.
- (7) Loosen the nut of the pressure relief valve by a spanner (flat across width: 19mm).
- (8) Remove the pressure relief valve and the gasket.
  - When reinstalling the G3/8" nut, use a new G3/8" gasket.

**Note1: The water may spout if the pressure relief valve is removed while the water is still inside the plate heat exchanger.**

**Note2: Tightening torque of the nut: 15 ± 1 N.m.**

Photo 16



# **mitsubishi electric corporation**

HEAD OFFICE : TOKYO BUILDING, 2-7-3, MARUNOUCHI, CHIYODA-KU, TOKYO 100-8310, JAPAN

---