

SPECIFICATION GUIDE

TRUST MULTIKWIK



Since its inception Multikwik has revolutionised plumbing in the UK, as it was one of the first companies to support the use of plastics in plumbing. The innovative flexible EVA WC connectors were first introduced to the UK by Multikwik and provided plumbers with a product that is easy to install and creates a solution to a long standing plumbing problem.

From this innovation, the Multikwik ethos has grown – in every product manufactured, Multikwik strive for:

- Reliability
- Simplicity
- Speed of installation
- Problem solving features

Four very simple reasons why you can

TRUST MULTIKWIK



CONTENTS



SANITARY SYSTEMS.....4

- WC frames 10
- Concealed cisterns 15
- Flush valves 16
- Flush plates 18
- Toilet seats 26

TRAPS28

- Bottle traps 30
- Tubular / running traps 34
- Shower waste traps 36
- Bath waste traps 38
- Trap accessories 40
- Utility waste 42
- Bowl kits 44
- Waste accessories 46

COMPRESSION WASTE50

- Problem solvers 51
- Compression waste 52
- Compression waste chrome .. 54

WC CONNECTORS.....58

- Problem solvers 60
- For modern pans 62
- For old style pans 73
- For stainless steel pans 76
- Ancillaries 78

FLOOR DRAINAGE80

- Problem solvers 83
- Linnum range 84
- Trapped shower gully range .. 88
- Continuous channel 92

CUSTOMER INFORMATION.....95



SANITARY SYSTEMS

STRENGTH YOU CAN **TRUST**

The Multikwik sanitary system includes sanitary frames, concealed cisterns, flush & fill valves and a selection of flush plates – all the hidden things that offer reliability when designing modern washrooms.

Wall hung toilets and basins have many benefits over the traditional close coupled WCs and pedestal basins, including easier cleaning and maintenance, hiding unsightly pipework and providing a contemporary, sleek bathroom finish.

For versatility and reliability in modern bathroom design, trust the wide Multikwik sanitary systems range.

Multikwik sanitary frames

Multikwik sanitary frames are the backbone of professional plumbing, supporting the wall hung chinaware, concealing unsightly pipework and allowing for easier cleaning and maintenance. The range includes 820, 985 and 1120mm frames for various bathroom applications and panels for special needs. This enables bathroom designs for any customer requirement.

Strength

Multikwik sanitary frames will support loads up to 400kg (63st) and are designed for a 25 year lifespan.

Easy to maintain

Any necessary maintenance can be achieved through the flush plate access, avoiding the need for expensive, obtrusive access panels.

Water conservation

The dual flush capability offers a choice of 6/3 litre or 4.5/3 litre flushes.

Product range

With a choice of 820, 985 & 1120mm height options to suit a range of applications, the frames can be used under a window, under a vanity shelf or at full height. Also available are frames adapted for special needs requirements. In addition Multikwik offers a compact float manifold system, ideal for multiple pans in commercial applications.

Aesthetics

The very nature of the concealed frames allows for clean design lines by concealing unsightly pipework, taking up no more space than a back to wall installation.

Versatile

The full range of interchangeable Multikwik flush plates can be used with any Multikwik frame and are available as surface or recessed mounted.

Easy to clean

With the sanitary ware suspended from the frame, cleaning is far easier, faster and more effective, a key requirement for Facility Managers.

Multikwik sanitary frames

A Multikwik frame consists of many quality components to ensure reliability and long life expectancy, as detailed below:

- Individual frames suitable for drywall construction
- Fast and simple installation by just one person
- Can be combined with nearly any lightweight construction system or studs.



Installation frame supplied pre-assembled in protective cardboard box with integral carry handles

Multikwik pan connector and flush pipe supplied loose



Frame supplied with fixing set for wall hung WC pan including studs, washers, nuts and white cover caps



Multikwik concealed cisterns

Multikwik has a range of concealed cisterns, including the Proteus which is one of the smallest cisterns on the market. Ideal for installation in bathroom furniture or service duct for back to the wall pans.

All cisterns are supplied complete with high quality mechanisms for long life and easy installation.

PROTEUS CONCEALED CISTERN

The Multikwik Proteus concealed cistern is equipped with a top and side access facility and the choice of a 6/3 or 4/2 litre flush configuration, providing up to 33% water savings.

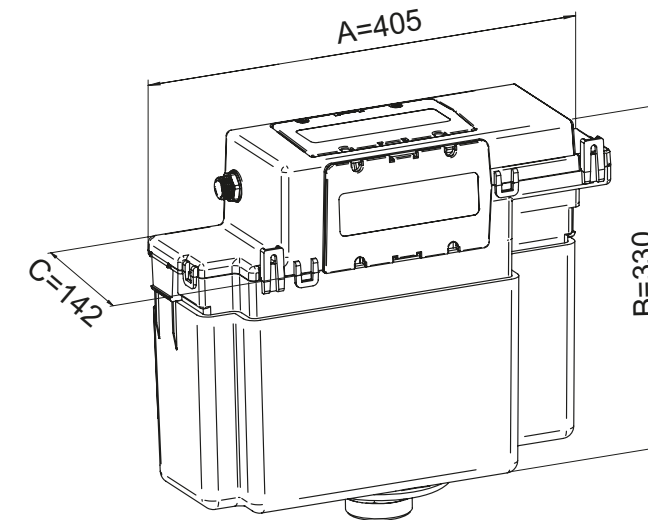

COMPACT

The Proteus cistern is just 405mm wide and engineered to offer a unique space saving solution, perfect for space restricted installations and an ideal solution for bathroom furniture.

INTELLIGENT

The WRAS approved Proteus cistern is supplied pre-set and ready for installation. Full insulation ensures a quiet acoustic performance.



TRC1830 cistern supplied with cable operated dual flush button MFVB7B in chrome/satin chrome finish



Please note the WC furniture cabinet must have a demountable panel or lid to access the concealed cistern once installed





Multikwik flush plates

The Multikwik range of flush plates include high quality glass, as well stainless steel and plastic, in a range of finishes, to suit all styles of bathrooms and washroom designs. All flush plates are dual flush, and offer the choice of 6/3 litre or 4.5/3 litre flushes.

Sprung frame design for flush plate mounting provides fast, easy and tool-free entry to the cistern to attend to any maintenance requirements.

Dual flush amenity of 6/3L or 4.5/3L, saving money and the environment.

A choice of designs and finishes offering solutions for a variety of applications.

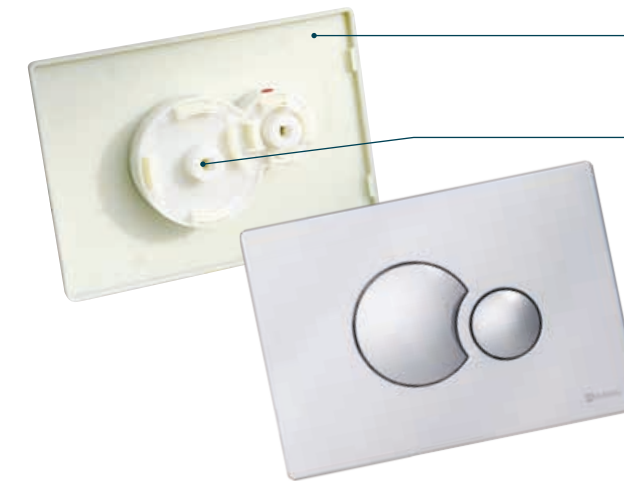
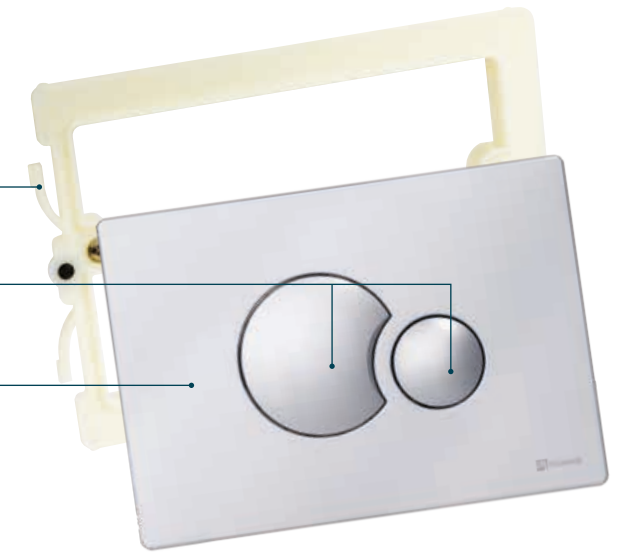

Made using robust and high quality components in well engineered mechanisms to ensure a low maintenance and reliable operation.

Quarter turn cable fixing function without any additional parts. Fast and easy to remove and replace, avoiding concerns or problems associated with losing or breaking components during installation or routine maintenance.

Interchangeable flush plate design provides choice to upgrade, update or replace for whole life use.

1mm recessed frame provides unobtrusive design.

Coloured co-ordinated or colour-matched buttons provide design choice.

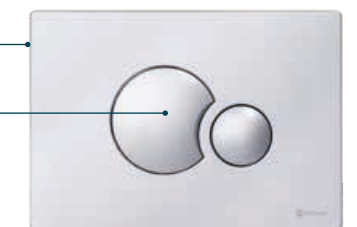

SANITARY SYSTEMS / WC FRAMES

WC FRAME - 820MM

TRM1820



PRODUCT CODE	TRM1820
SIZE (mm)	820
OUTLET CONNECTION	110mm spigot
WEIGHT (KG)	15.2
DIMENSIONS (mm) A x B x C	820 x 525 x 205

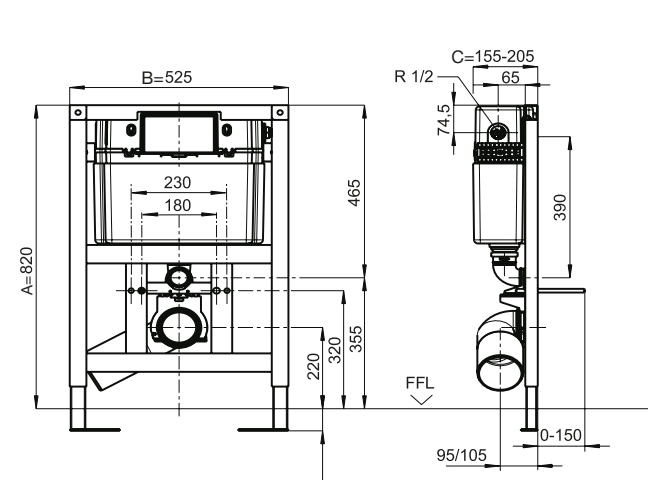

WC FRAME - 985MM

TRM1985



PRODUCT CODE	TRM1985
SIZE (mm)	985
OUTLET CONNECTION	110mm spigot
WEIGHT (KG)	11.7
DIMENSIONS (mm) A x B x C	985 x 525 x 205

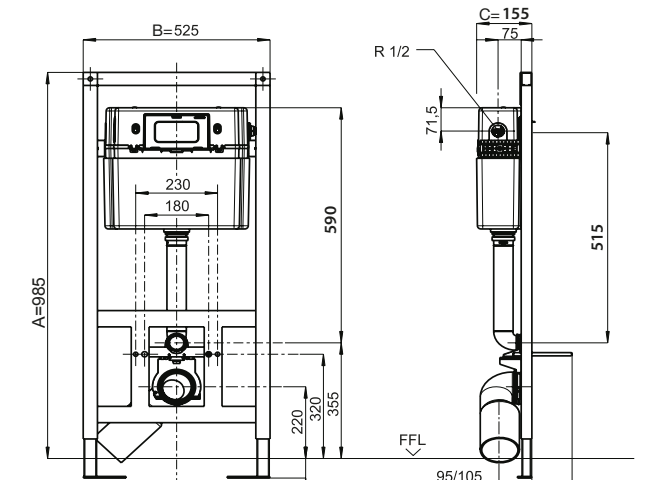

WC FRAME - 1120MM

TRM1120



PRODUCT CODE	TRM1200
SIZE (mm)	1120
OUTLET CONNECTION	110mm spigot
WEIGHT (KG)	11.7
DIMENSIONS (mm) A x B x C	1120 x 450 x 135

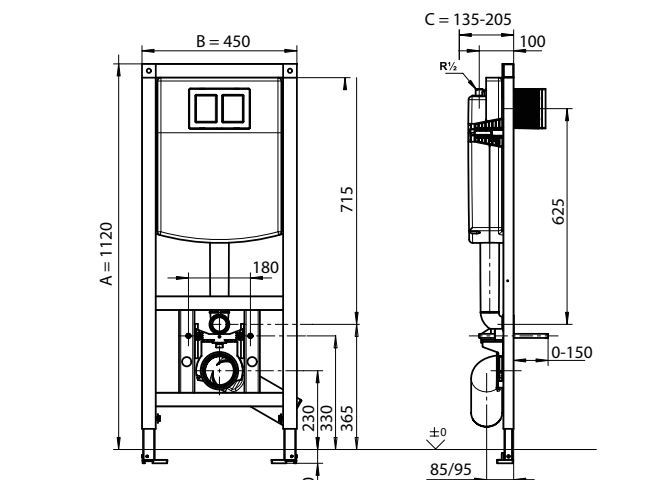

WC FRAME SPECIAL NEEDS

TRM1121



PRODUCT CODE	TRM1121
SIZE (mm)	1120
OUTLET CONNECTION	110mm spigot
WEIGHT (KG)	17
DIMENSIONS (mm) A x B x C	1120 x 450 x 135

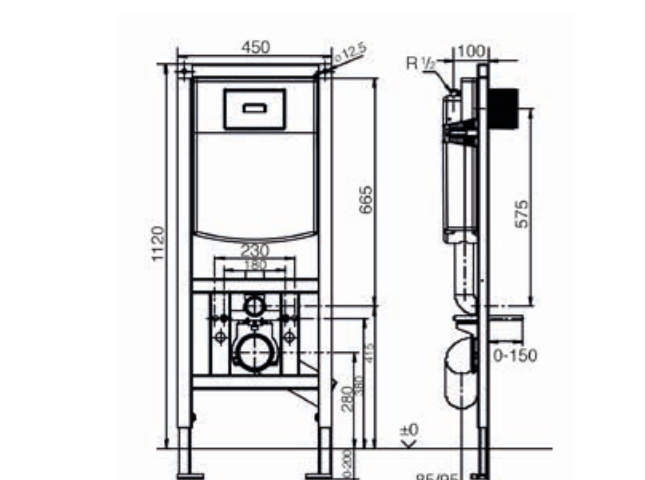

FLOOR DEPTH ADJUSTMENT	0 - 200mm
FRAME WIDTH	525mm
INSTALLATION DEPTH	155 - 205mm
FRAME WEIGHT SUPPORT	400kg
FLUSH VOLUME	6/3L or 4.5/3L
MIN/MAX WATER PRESSURE	0.5 - 10.0 bar
WATER SUPPLY INLET CONNECTION	Male 1/2" BSP left, right or rear
WC / WHB / URINAL FIXING CENTRES	230 - 180mm
90° OUTLET BEND	ØDN90 x DN100 spigot (Ø110mm)
WC pan connector (included)	Ø90 spigot x Ø97-108 socket
FLUSH INLET PIPE	Ø45mm x 180mm L
FLUSH VALVE	Cable operated dual flush drop valve
CISTERN ACCESS	Front & top
CONSTRUCTION	Powder coated welded steel frame
APPLICATION	For installation below 90cm height window sill.

FLOOR DEPTH ADJUSTMENT	0 - 200mm
FRAME WIDTH	525mm
INSTALLATION DEPTH	155 - 205mm
FRAME WEIGHT SUPPORT	400kg
FLUSH VOLUME	6/3L or 4.5/3L
MIN/MAX WATER PRESSURE	0.5 - 10.0 bar
WATER SUPPLY INLET CONNECTION	Male 1/2" BSP left, right or rear
WC / WHB / URINAL FIXING CENTRES	230 - 180mm
90° OUTLET BEND	ØDN90 x DN100 spigot (Ø110mm)
WC pan connector (included)	Ø90 spigot x Ø97-108 socket
FLUSH INLET PIPE	Ø45mm x 180mm L
FLUSH VALVE	Cable operated dual flush drop valve
CISTERN ACCESS	Front & top
CONSTRUCTION	Powder coated welded steel frame
APPLICATION	For part-height room duct installations

FLOOR DEPTH ADJUSTMENT	0 - 200mm
FRAME WIDTH	450mm
INSTALLATION DEPTH	135 - 205mm
FRAME WEIGHT SUPPORT	400kg
FLUSH VOLUME	6/3L or 4.5/3L
MIN/MAX WATER PRESSURE	0.5 - 10.0 bar
WATER SUPPLY INLET CONNECTION	Male 1/2" BSP centre
WC / WHB / URINAL FIXING CENTRES	180mm
90° OUTLET BEND	ØDN90 x DN100 spigot (Ø110mm)
WC pan connector (included)	Ø90 spigot x Ø97-108 socket
FLUSH INLET PIPE	Ø45mm x 180mm L
FLUSH VALVE	Cable operated dual flush drop valve
CISTERN ACCESS	Front only
CONSTRUCTION	Powder coated welded steel frame
APPLICATION	For full height room duct installations

FLOOR DEPTH ADJUSTMENT	0 - 200mm
FRAME WIDTH	450mm
INSTALLATION DEPTH	135 - 205mm
FRAME WEIGHT SUPPORT	400kg
FLUSH VOLUME	6/3L or 4.5/3L
MIN/MAX WATER PRESSURE	0.5 - 10.0 bar
WATER SUPPLY INLET CONNECTION	Male 1/2" BSP centre
WC / WHB / URINAL FIXING CENTRES	180mm
90° OUTLET BEND	ØDN90 x DN100 spigot (Ø110mm)
WC pan connector (included)	Ø90 spigot x Ø97-108 socket
FLUSH INLET PIPE	Ø45mm x 180mm L
FLUSH VALVE	Cable operated dual flush drop valve
CISTERN ACCESS	Front only
CONSTRUCTION	Powder coated welded steel frame
APPLICATION	Full height room duct, disabled installation

SANITARY SYSTEMS / WC FRAMES

WASHBASIN FRAME

TRM2820



PRODUCT CODE	TRM2820
SIZE (mm)	820
OUTLET CONNECTION	40mm
WEIGHT (KG)	6.5
DIMENSIONS (mm) A x B x C	820 x 525 x 135

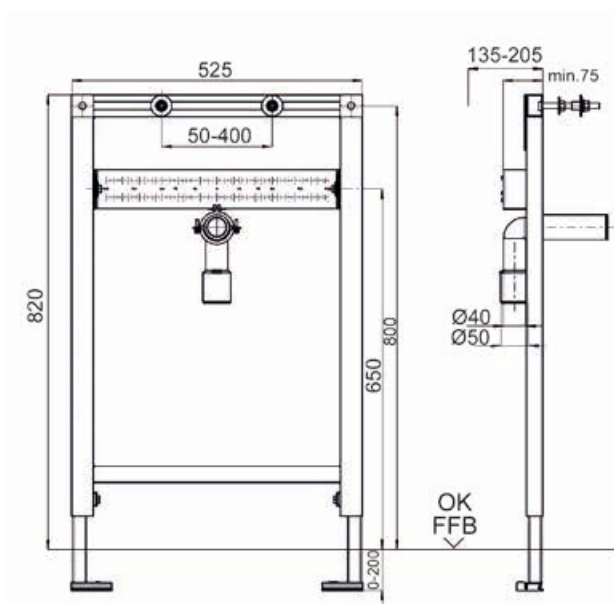

FLOOR DEPTH ADJUSTMENT	0 - 200mm
FRAME WIDTH	525mm
INSTALLATION DEPTH	135 - 205mm
FRAME WEIGHT SUPPORT	150kg
WC / WHB / URINAL FIXING CENTRES	50 - 400mm
90° OUTLET BEND	ØDN40 x DN50 spigot
CONSTRUCTION	Powder coated welded steel frame
APPLICATION	For installations below 90cm height window sill

WASHBASIN FRAME

TRM2985



PRODUCT CODE	TRM2985
SIZE (mm)	985
OUTLET CONNECTION	40mm
WEIGHT (KG)	7.6
DIMENSIONS (mm) A x B x C	985 x 525 x 135

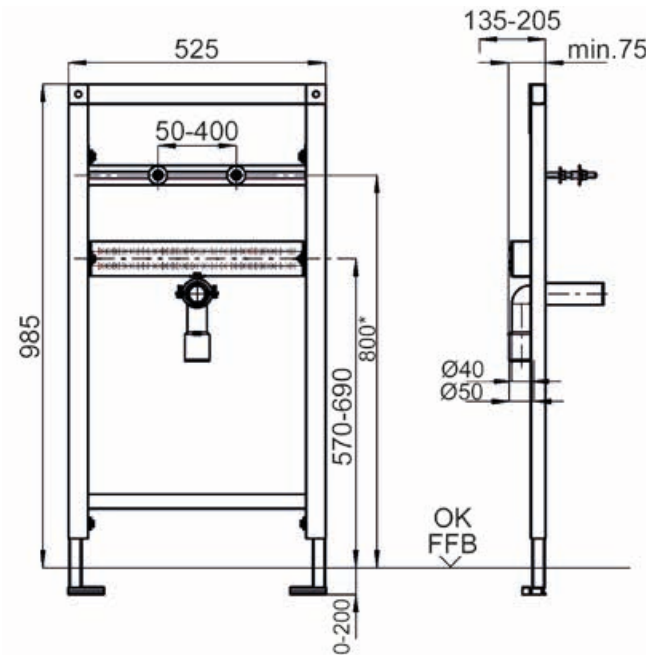

FLOOR DEPTH ADJUSTMENT	0 - 200mm
FRAME WIDTH	525mm
INSTALLATION DEPTH	135 - 205mm
FRAME WEIGHT SUPPORT	150kg
WC / WHB / URINAL FIXING CENTRES	50 - 400mm
90° OUTLET BEND	ØDN40 x DN50 spigot
CONSTRUCTION	Powder coated welded steel frame
APPLICATION	For part-height room duct installations

WASHBASIN FRAME

TRM2020



PRODUCT CODE	TRM2020
SIZE (mm)	1120
OUTLET CONNECTION	40mm
WEIGHT (KG)	14.2
DIMENSIONS (mm) A x B x C	1120 x 525 x 135

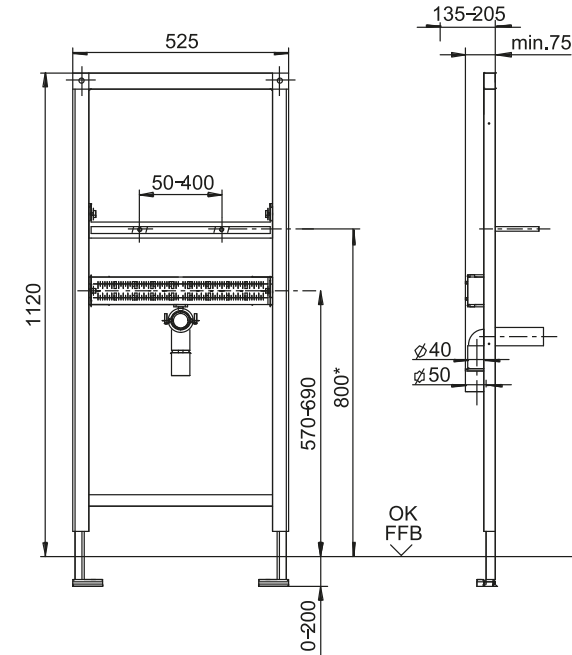

FLOOR DEPTH ADJUSTMENT	0 - 200mm
FRAME WIDTH	525mm
INSTALLATION DEPTH	135 - 205mm
FRAME WEIGHT SUPPORT	150kg
WC / WHB / URINAL FIXING CENTRES	50 - 400mm
90° OUTLET BEND	ØDN40 x DN50 spigot
CONSTRUCTION	Powder coated welded steel frame
APPLICATION	For full height room ducts

REASONS TO TRUST MULTIKWIK

Resealing Bottle Trap

Looking for a trap to go with your wash basin? Take a look at our Resealing Bottle Trap (see page 26)



- 1 When syphonic action occurs, air gets drawn through the bypass device, allowing an air break.
- 2 Once the negative pressure stops, the water goes back and reseals the trap.

TRUST MULTIKWIK

Our high quality components include, but are not limited to, our compression nuts, slip rings and EPDM profiled rubber seals – ensuring a secure watertight joint and helping achieve a fuss free 'no call back' installation.

SANITARY SYSTEMS / WC FRAMES

SUPPORT PANEL FRAME FOR SPECIAL NEEDS – LEFT

TRM6001

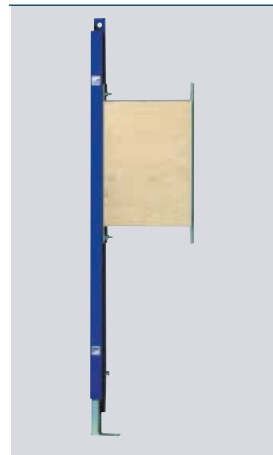

PRODUCT CODE	TRM6001
SIZE (mm)	1120
WEIGHT (KG)	4.4
DIMENSIONS (mm) A x B x C	1120 x 294 x 135
TYPE	Left

SUPPORT PANEL FRAME FOR SPECIAL NEEDS – RIGHT

TRM6002

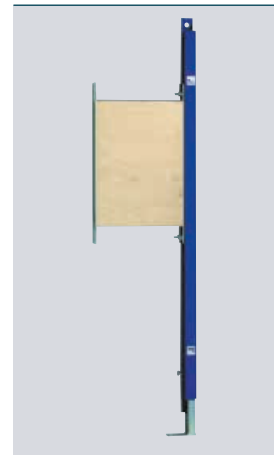

PRODUCT CODE	TRM6002
SIZE (mm)	1120
WEIGHT (KG)	4.4
DIMENSIONS (mm) A x B x C	1120 x 294 x 135
TYPE	Right

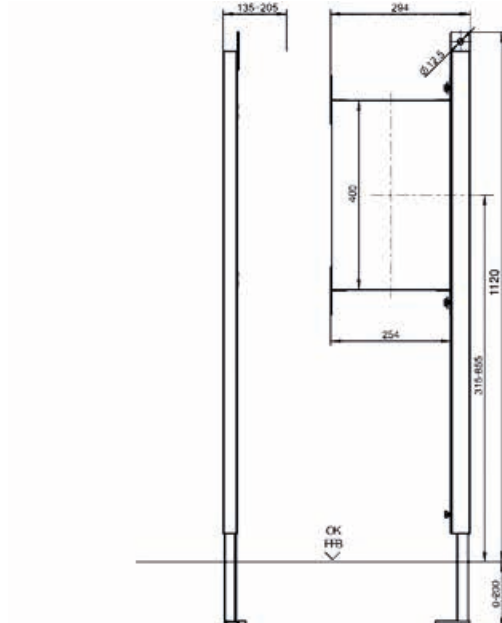
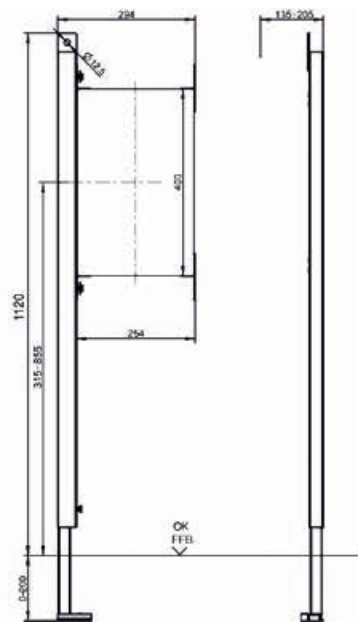

FLOOR DEPTH ADJUSTMENT	0 - 200mm
FRAME WIDTH	296mm
INSTALLATION DEPTH	135 - 205mm
CONSTRUCTION	Powder coated welded steel frame
APPLICATION	Left hand side support frame for mounting grab bars. For use with TRM1121 disabled WC frame.

FLOOR DEPTH ADJUSTMENT	0 - 200mm
FRAME WIDTH	296mm
INSTALLATION DEPTH	135 - 205mm
CONSTRUCTION	Powder coated welded steel frame
APPLICATION	Right hand side support frame for mounting grab bars. For use with TRM1121 disabled WC frame.

SANITARY SYSTEMS / CISTERNS

ECONOMY SIDE FILL CISTERN – WITH BUTTON

TRC1820

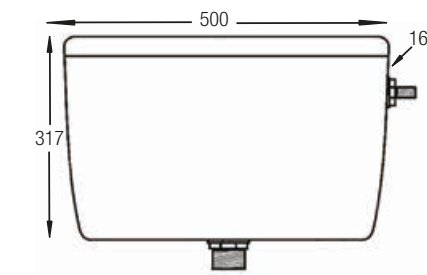

- Includes flush pipe 320 x 320 x Ø40 mm
- 6/3L flush adjustable to 4/2L
- Includes dual flush button (code: MFVB6B)
- Cable 800mm length overall
- Multiflush and side fill valve
- WRAS approved flush valve
- WRAS approved side fill valve
- Exposed low level WC cistern (can be used for concealed installation)

ECONOMY BOTTOM FILL CISTERN – WITH BUTTON

TRC1821

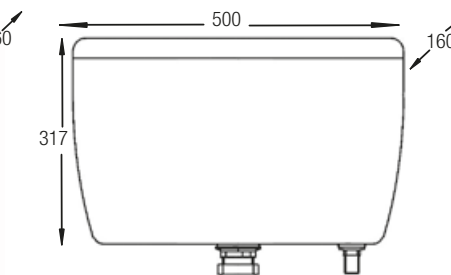

- Includes flush pipe 320 x 320 x Ø40 mm
- 6/3L flush adjustable to 4/2L
- Includes dual flush button (code: MFVB6B)
- Cable 800mm length overall
- Multiflush and bottom fill valve
- WRAS approved flush valve
- WRAS approved bottom fill valve
- Exposed low level WC cistern (can be used for concealed installation)

CONCEALED DUAL FLUSH CISTERN

TRV1820

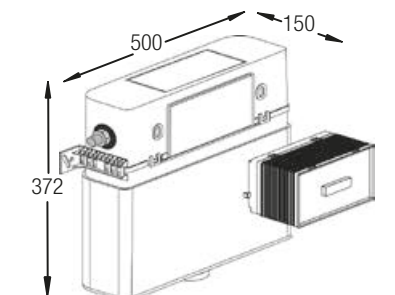

- Water pressure 0.5 – 10 bar
- Front or top access option
- 6/3 flush volume
- Cable operated
- Integral fill valve
- Integral isolation valve
- Flush bend and flush pipe included
- ½" BSP brass water supply connection

OUTLET SIZE	1½"
WEIGHT (KG)	2.58
DIMENSIONS (mm) A x B x C	500 x 317 x 160

OUTLET SIZE	1½"
WEIGHT (KG)	2.58
DIMENSIONS (mm) A x B x C	500 x 317 x 160

OUTLET SIZE	2"
WEIGHT (KG)	2.69
DIMENSIONS (mm) A x B x C	500 x 372 x 150

SANITARY SYSTEMS / CISTERNS & VALVES

PROTEUS CABLE CONCEALED CISTERN WITH BUTTON

TRC1830

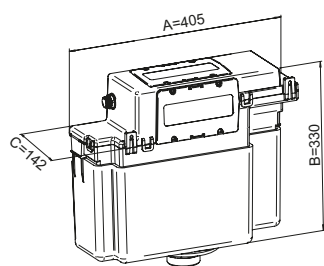

- Includes satin chrome dual flush button (code: MFVB7B)
- Water supply connection: Male ½" BSP (plastic) – left
- Flush valve type: Dual flush cable operated drop valve
- Cistern access: Front/ Top
- Plastic cistern and foam insulating jacket construction
- Includes integral isolating valve
- Includes flush pipe
- Cable 460mm overall
- For use in bathroom furniture

PRODUCT CODE	TRM1830
WATER FLUSH VOLUME:	6/3L or 4/2L adjustable
WATER PRESSURE:	0.5 – 10 bar
WEIGHT (KG)	1.53
DIMENSIONS (mm) A x B x C	405 x 330 x 142

MULTIFLUSH DUAL FLUSH VALVE – 340MM CABLE

MFV1C | MFV3C

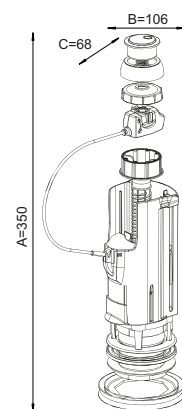

- Includes chrome dual flush button (code: MFVB6B)
- 6/3L adjustable to 4/2L flush volume
- For use in ceramic and plastic cisterns
- Adjustable internal overflow

PRODUCT CODE	MFV1C	MFV3C
WEIGHT (KG)	0.37	0.41
OUTLET SIZE	1½"	2"
DIMENSIONS (mm) A x B x C	300 x 106 x 68	300 x 106 x 68

MULTIFLUSH DUAL FLUSH VALVE – 800MM CABLE

MFV2C | MFV4C

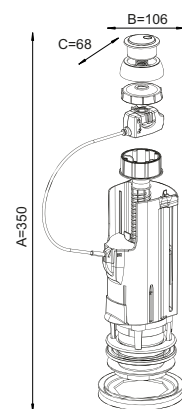

- Includes chrome dual flush button (code: MFVB6B)
- 6/3L adjustable to 4/2L flush volume
- For use in ceramic and plastic cisterns
- Adjustable internal overflow

PRODUCT CODE	MFV2C	MFV4C
WEIGHT (KG)	0.38	0.42
OUTLET SIZE	1½"	2"
DIMENSIONS (mm) A x B x C	300 x 106 x 68	300 x 106 x 68



SANITARY SYSTEMS / FLUSH PLATES



ECLIPSE – GLASS

ECLIPSE - RECESSED

ECLIPSE - SURFACE MOUNTED

TRF1215E White



TRF1201E White

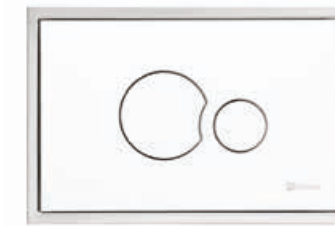

TRF0400E White



TRF1216E Black



TRF1202E Chrome

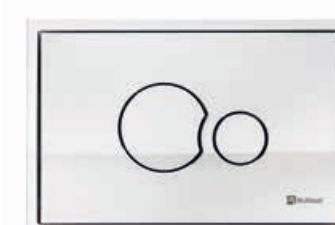

TRF0427E Chrome



TRF0428E Satin chrome



IO INFRA-RED

TRF1010IO

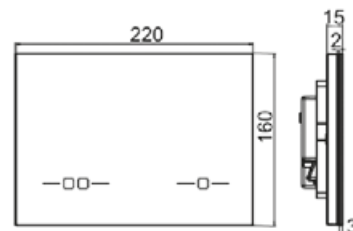
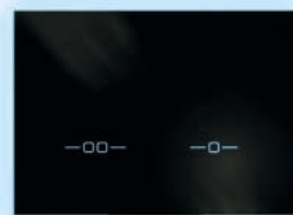

- Dual flush via short range IR sensor
- Finish: Black
- Material: Toughened safety glass
- Hygienic contactless operation
- LED lighting – 7 adjustable colours
- User detection via long range sensors
- Automatic forced flushing
- Cleaning mode
- Interval flushing at selectable intervals
- Flush plate settings accessible via flush plate or service remote (sold separately)

Bespoke Option

Promote your brand by selecting our bespoke option. Add your logo to the IO flush plate, which illuminates once installed, creating a personal touch to any washroom.

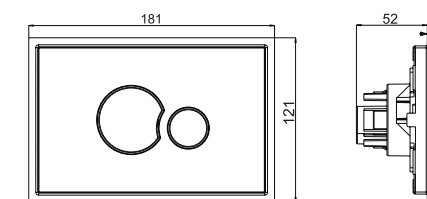

- Dual flush
- Finish: White, Black
- Material: Toughened safety glass
- Polished stainless steel frame
- Recessed mounted
- Cable operated

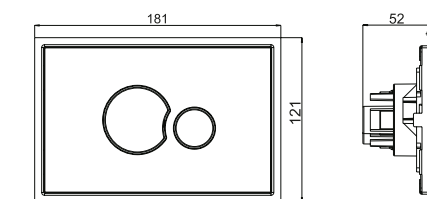

- Dual flush
- Finish: White, Chrome
- Material: ABS plastic
- Polished stainless steel frame
- Recessed mounted
- Cable operated

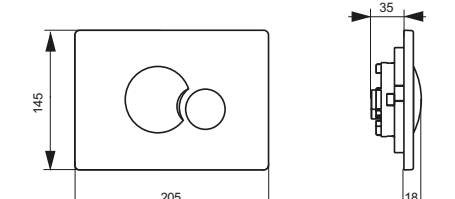

- Dual flush
- Finish: White, Chrome, Satin chrome
- Material: ABS plastic
- Surface mounted
- Cable operated

SANITARY SYSTEMS / FLUSH PLATES

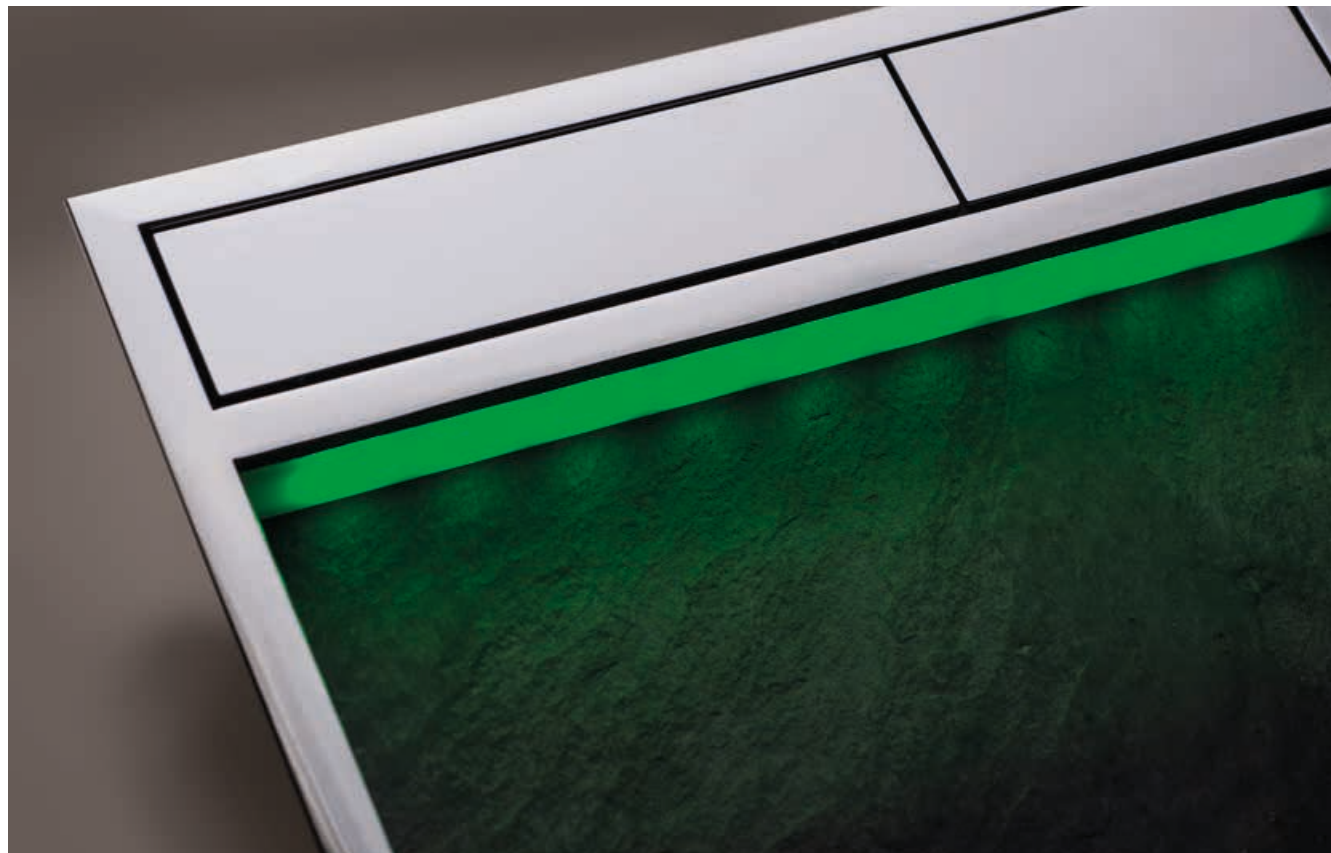

Light options

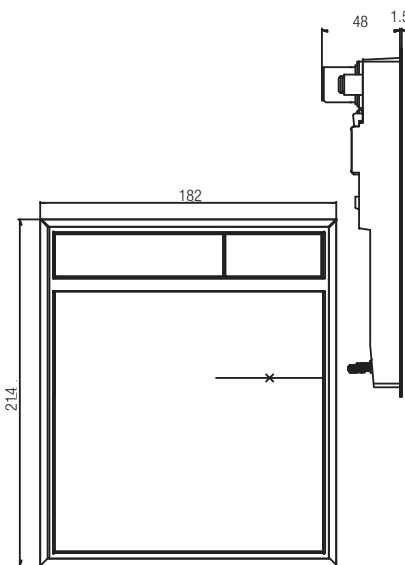

HYDRA

- Dual flush
- Finish: White, Silver grey, Anthracite grey, Slate grey – additional colours are available to order
- Material: Chrome metal frame
ABS button
Glass/Slate/ABS plate
- Illumination option available (Hydra Glow)
- Customisable
- Recessed mounted

HYDRA



HYDRA GLOW



Customisable Hydra

To complete the look, Multikwik offer a customise option for the Hydra flush plate. This choice allows for any wall tile to be installed into the plate, providing a sleek look to any modern bathroom.

64 finish combinations

In addition to the flush plate colour options above, the following are available to order, as well as interchanging buttons

FLUSH PLATE OPTIONS



BUTTON OPTIONS



SANITARY SYSTEMS / FLUSH PLATES

ATLAS

TRF0400AT White



TRF0427AT Chrome



TRF0428AT Satin chrome

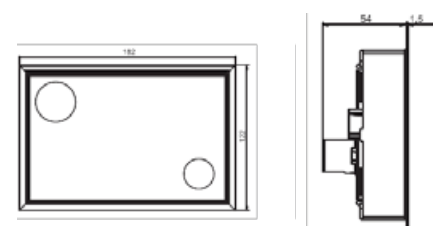

- Dual flush
- Finish: White, Chrome, Satin chrome
- Material: ABS plastic
- Polished stainless steel frame
- Recessed mounted
- Cable operated

LUNA

TRF0400LU White

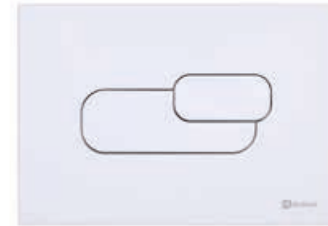

TRF0427LU Chrome

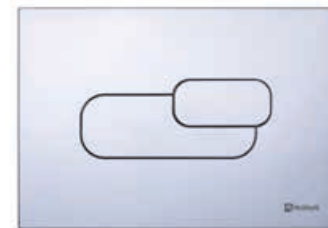

TRF0428LU Satin chrome

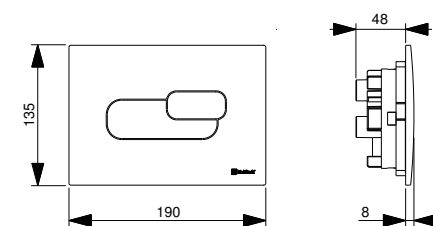
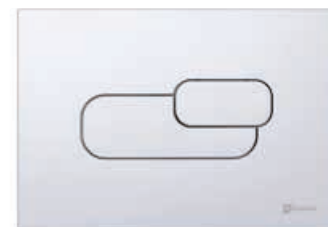

- Dual flush
- Finish: White, Chrome, Satin chrome
- Material: ABS plastic
- Polished stainless steel frame
- Recessed mounted
- Cable operated

METIS

TRF0400ME White



TRF0427ME Chrome



TRF0428ME Satin chrome

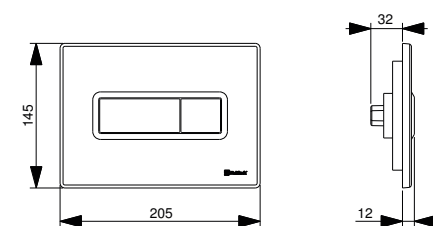

- Dual flush
- Finish: White, Chrome, Satin chrome
- Material: ABS plastic
- Surface mounted
- Cable operated

TELESTO

TRF0400L White



TRF0427L Chrome



TRF0428L White with satin chrome button

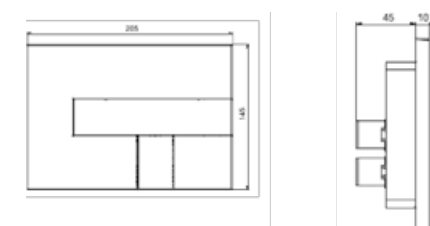
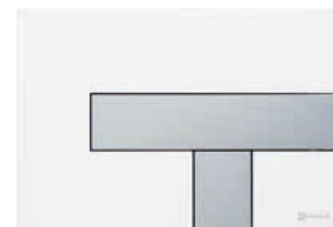

- Dual flush
- Finish: White, Chrome, White with satin chrome button
- Material: ABS Plastic
- Surface mounted
- Cable operated

SOLAR

TRF0427S Chrome



TRF0428S Satin chrome

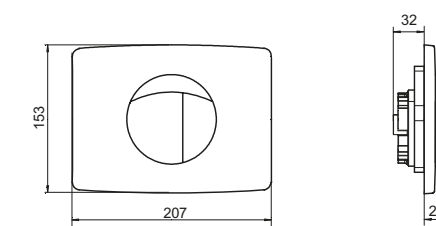

- Dual flush
- Finish: Chrome, Satin chrome
- Material: ABS plastic
- Surface mounted
- Cable operated

CRESCENT

TRF0400C White



TRF0427C Chrome



TRF0433C Stainless steel

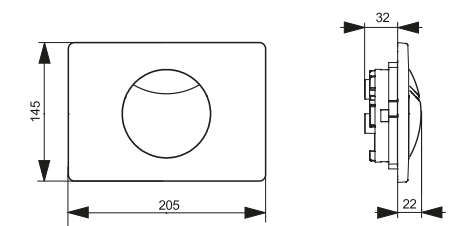

- Dual flush
- Finish: White, Chrome, Stainless steel
- Material: ABS plastic
- Surface mounted
- Cable operated

TITAN

TRF0400T White



TRF0427T Chrome



TRF0428T Satin chrome

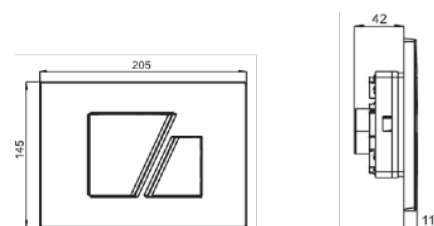

- Dual flush
- Finish: White, Chrome, Satin chrome
- Material: ABS Plastic
- Surface mounted
- Cable operated

PNEUMATIC

MFVP10K Chrome

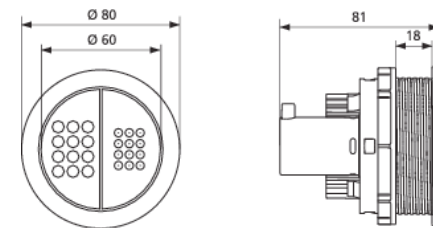

- Dual flush
- For use with TRV1820, TRM1820, TRM1985, TRM1120 only
- Finish: Chrome
- Material: Plastic
- Pneumatic activation. Includes pneumatic hose and pneumatic lifting unit

CABLE OPERATED

MFVB1B Chrome

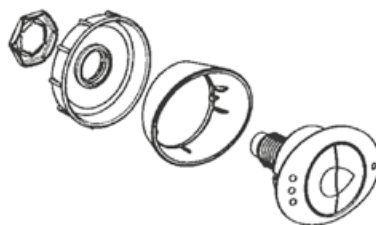

- Dual flush
- For use with Multiflush valves only
- Finish: Chrome
- Material: Plastic
- Surface mounted with removable collar

CABLE OPERATED

MFVB7B Chrome / satin chrome



MFVB6B Chrome

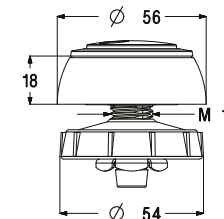

- Dual flush
- For use with Multiflush valves only
- Chrome/Satin Chrome, Chrome
- Material: Plastic
- ø50mm
- Surface mounted with removable collar

Installation Options (Install using option A or B)

A Lightweight construction using metal or timber studs. Stud work is required to be load bearing, this should be checked with stud work manufacturer.

Multikwik recommends:

Prior to installation, ensure that the studs are of sufficient strength to take the load:

- Stud to be min 50mm, or ideally 75mm
- Multikwik Frame to be level with the front of stud work.

- Frame fixed to stud, with 5x fixings at equal spacing
- Studs to be doubled up, with timber used to brace between studs.

- Plasterboard to be a minimum of 25mm thick covering the whole of the wall and fixed directly onto frame with no gap. Any gap can cause the pan, wall and frame to flex.



B Solid/Stud Partitioned Wall, if fixing to a partitioned wall, this wall must be of load bearing strength, please check with stud manufacture that wall has sufficient strength to take the load.

Multikwik recommends:

Partition wall to be a min of 2x 12.5mm plasterboard or 18mm ply thick

- Studs at 400mm centres
- 75mm studs or 50mm studs to be doubled back to back and braced with timber.

- For duct depths exceeding 205mm, 400mm extension wall fixings are available **Product code TRA4004**. Multikwik recommends not exceeding 400mm due to the increase in counter lever force applied to the frame.

- Plasterboard in front of frame to be a minimum of 25mm thick and covers the whole of the wall and fixed directly onto frame with no gap, as any gap can cause the pan, wall and frame to flex.



SANITARY SYSTEMS / TOILET SEATS

WEY
WC SEAT

MKKN002

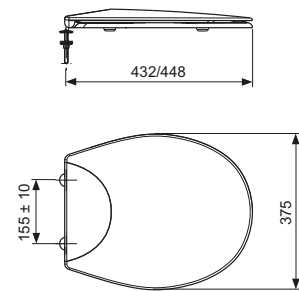

- Four point support underseat
- Suitable for back to the wall and mounted pans
- Includes Kwiknuts
- Adjustable stainless steel hinges
- Bevelled back
- Scratch resistant surface
- Moulded thermosetting plastic
- 1.95kg

COLOUR	White
DIMENSIONS (mm) A x B x C	455 x 375 x 155

HAMBLE
WC SEAT

MKKN003

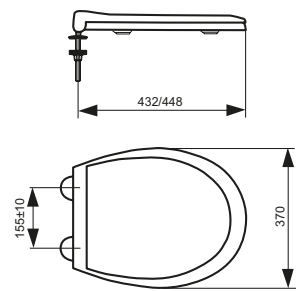

- Four point support underseat
- Suitable for back to the wall and mounted pans
- Includes Kwiknuts
- Adjustable stainless steel hinges
- Bevelled/contoured front
- Smooth underside for easy cleaning
- Injection moulded thermoplastic
- 1.85kg

COLOUR	White
DIMENSIONS (mm) A x B x C	455 x 370 x 155

MOORS
ANTIBAC WC SEAT

MKKN004

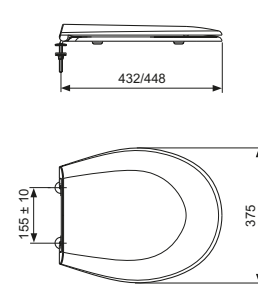

- Four point support underseat
- Suitable for back to the wall and mounted pans
- Includes Kwiknuts
- Adjustable stainless steel hinges
- Thermosetting plastic
- Scratch resistant surface
- Adjustable stainless steel hinges
- 2.40kg

COLOUR	White
DIMENSIONS (mm) A x B x C	450 x 375 x 155

SOFT CLOSE
WC SEAT

MKKN007

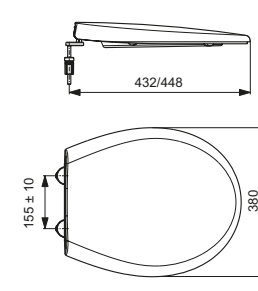

- Two point support underseat
- Suitable for back to the wall and mounted pans
- Soft close stainless steel hinges
- Thermosetting plastic
- Scratch resistant surface
- Seat integrated in lid when closed
- For WCs with D shaped bowl
- 2.20kg

COLOUR	White
DIMENSIONS (mm) A x B x C	450 x 376 x 155

EDUCATION
WC SEATS

MKKN006

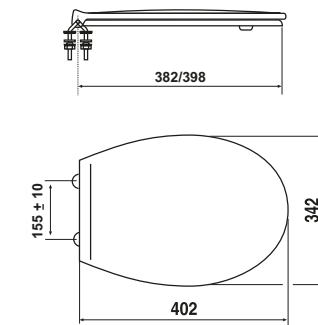

White ○

- Two point support underseat
- Adjustable stainless steel hinges
- Injection moulded thermoplastic
- Smooth underside for easy cleaning
- 1.35kg

COLOUR	White
DIMENSIONS (mm) A x B x C	402 x 342 x 155



TRAPS

SECURITY YOU CAN **TRUST**

Designed by our plumbing experts, the Multikwik traps range is a comprehensive suite of products which provide reliable solutions for both typical and more challenging installations.

From standard traps for basins, baths and showers to more complex utility traps and nozzles for appliance connections, the Multikwik range has a product suited to the job.

Whether you want to specify a trustworthy 'fit and forget' product or you want something that is quick and easy to install, Trust Multikwik.

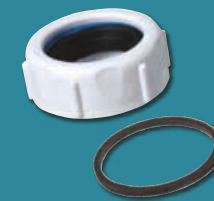

Multifit Nut & Seal

All Multikwik traps have a multifit nut and seal that allow connection to push fit, solvent and copper pipes. The thumb recesses make it easy to tighten, even with wet hands to ensure a 'fit and forget' installation every time!

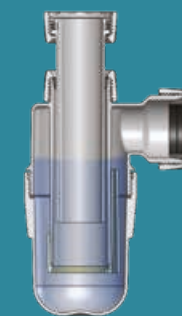

Water Seal

BS EN 12056-2:2000 states that traps which discharge to a soil stack should have a 75mm seal. Other seal depths can be installed, if installation with required seal depth isn't possible due to size restrictions.

- 50mm water seal traps can be fitted to baths, shower trays and basins with spray taps and no plugs.
- 38mm water seal traps can be used on ground floors when connecting to flat bottomed appliances that discharge to a back inlet gully.



TRAPS / BOTTLE TRAP

KEY: Resealable Adjustable

BOTTLE – STANDARD

B032 | B040

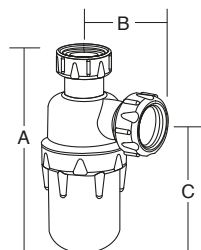

BOTTLE – RESEALING

B032R | B040R

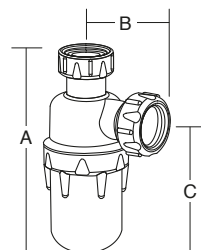

■ Resealing function to prevent loss of water seal

BOTTLE – ADJUSTABLE

B032A | B040A

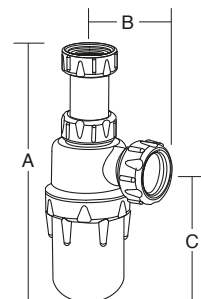

■ Adjustable inlet for installation flexibility
■ Min height: 195mm; max height: 300mm

BOTTLE – ADJUSTABLE / RESEALING

B032RA | B040RA

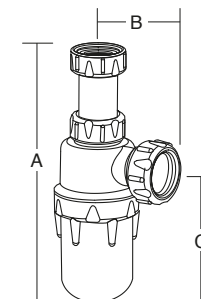

■ Adjustable inlet for installation flexibility
■ Resealing function to prevent loss of water seal
■ Min height: 195mm; max height: 300mm

BOTTLE – ANTI-VAC

B032V | B040V

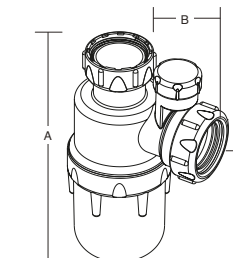

■ Resealing function to prevent loss of water seal
■ Anti-vac allows air into the waste pipes to prevent self-siphonage of the traps water seal and gurgling

PRODUCT CODE	B032	B040
SIZE (mm)	32	40
COLOUR	White	White
WATER SEAL DEPTH (mm)	75	75
WEIGHT (KG)	0.15	0.18
DIMENSIONS (mm) A x B x C	180 x 74 x 125	184 x 78 x 127

PRODUCT CODE	B032R	B040R
SIZE (mm)	32	40
COLOUR	White	White
WATER SEAL DEPTH (mm)	75	75
WEIGHT (KG)	0.16	0.19
DIMENSIONS (mm) A x B x C	180 x 74 x 125	184 x 78 x 127

PRODUCT CODE	B032A	B040A
SIZE (mm)	32	40
COLOUR	White	White
WATER SEAL DEPTH (mm)	75	75
WEIGHT (KG)	0.19	0.22
DIMENSIONS (mm) A x B x C	195 x 74 x 125	195 x 78 x 127

PRODUCT CODE	B032RA	B040RA
SIZE (mm)	32	40
COLOUR	White	White
WATER SEAL DEPTH (mm)	75	75
WEIGHT (KG)	0.20	0.23
DIMENSIONS (mm) A x B x C	195 x 74 x 125	195 x 78 x 127

PRODUCT CODE	B032V	B040V
SIZE (mm)	32	40
COLOUR	White	White
WATER SEAL DEPTH (mm)	75	75
WEIGHT (KG)	0.16	0.19
DIMENSIONS (mm) A x B x C	180 x 74 x 125	186 x 84 x 125

REASONS TO TRUST MULTIKWIK

Anti-vac trap

1

When syphonic action occurs, the anti-vac unit allows air to be drawn into the discharge pipe.

2

Through the negative pressure the valve rises, lets air in and that way the water seal remains unaffected.

3

Once the negative pressure stops, the valve closes again, making the trap water and airtight.

No gurgling – enjoy the sound of silence!



TRUST MULTIKWIK

Our high quality components include, but are not limited to, our compression nuts, slip rings and EPDM profiled rubber seals – ensuring a secure watertight joint and helping achieve a fuss free 'no call back' installation.

TRAPS / BOTTLE TRAP / STRAIGHT THROUGH TRAP

KEY: Resealable Adjustable

BOTTLE – COMPACT

B032S | B040S

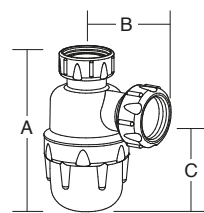

- Use when connecting into flat bottomed appliances that discharge into a gully

BOTTLE – SLIMLINE

BS032

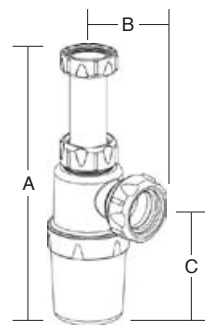

- Space saving
- Adjustable inlet for installation flexibility
- Minimum height: 195mm; max height 300mm

STRAIGHT THROUGH ADJUSTABLE

ST032

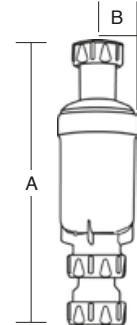

- Unique slimline design, saving space
- Adjustable telescopic outlet for installation flexibility
- Easy to clean and maintain

BOTTLE – ADJUSTABLE

B032ACR

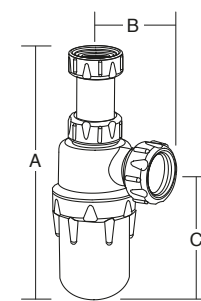

- High quality mirror chrome finish
- Includes 400mm x 32mm chromed pipe
- Adjustable inlet for installation flexibility
- Min height: 195mm; max height: 300mm

BOTTLE – ADJUSTABLE / RESEALING

B032RACR B040RACR

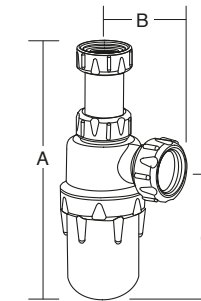

- Resealing function to prevent loss of water seal
- High quality mirror chrome finish
- Adjustable inlet for installation flexibility
- Min height: 195/225mm; max height: 300/327mm

PRODUCT CODE	B032S	B040S
SIZE (mm)	32	40
COLOUR	White	White
WATER SEAL DEPTH (mm)	38	38
WEIGHT (KG)	0.12	0.13
DIMENSIONS (mm) A x B x C	136 x 75 x 85	152 x 81 x 100

PRODUCT CODE	BS032
SIZE (mm)	32
COLOUR	White
WATER SEAL DEPTH (mm)	75
WEIGHT (KG)	0.15
DIMENSIONS (mm) A x B x C	182 x 71 x 112

PRODUCT CODE	ST032
SIZE (mm)	32
COLOUR	White
WATER SEAL DEPTH (mm)	75
WEIGHT (KG)	0.24
DIMENSIONS (mm) A x B	270 x 33

PRODUCT CODE	B032ACR
SIZE (mm)	32
COLOUR	Chrome
WATER SEAL DEPTH (mm)	75
WEIGHT (KG)	0.45
DIMENSIONS (mm) A x B x C	195 x 74 x 125

PRODUCT CODE	B032RACR	B040RACR
SIZE (mm)	32	40
COLOUR	Chrome	Chrome
WATER SEAL DEPTH (mm)	75	75
WEIGHT (KG)	0.25	0.29
DIMENSIONS (mm) A x B x C	195 x 74 x 125	225 x 80 x 130

REASONS TO TRUST MULTIKWIK

Resealing trap

1

When syphonic action occurs, air gets drawn through the bypass device, allowing an air break.

2

Once the negative pressure stops, the water goes back and reseals the trap.



Bottle Trap Resealing

The resealing function helps to prevent loss of water.

Easily removed and cleaned to ensure 100% reliability.



TRUST MULTIKWIK

The smooth, clean, internal surfaces facilitate self-cleaning and avoid debris build-up.

TRAPS / TUBULAR SWIVEL TRAP / RUNNING TRAP

KEY: Resealable Adjustable

UNIVERSAL ALL IN ONE

SP032 | SP040

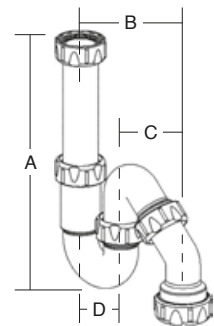

- Adjustable inlet for installation flexibility
- Multi position outlet adjusts 360° providing installation flexibility
- Use as either an 'S' or 'P' trap

RUNNING

RP032 | RP040 | RP050X

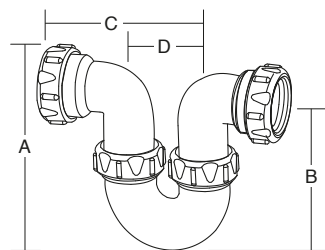

- Use to trap a range of appliances

'P' TRAP

P032 | P040 | P050

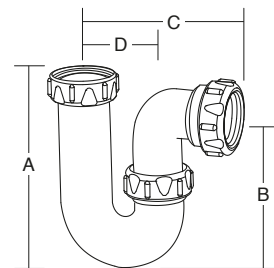

- Use for horizontal pipework

'P' TRAP – ADJUSTABLE

P032A | P040A

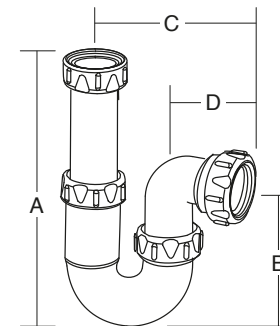

- Adjustable inlet for installation flexibility
- Min height: 220mm; max height: 270mm

'S' TRAP

S032 | S040

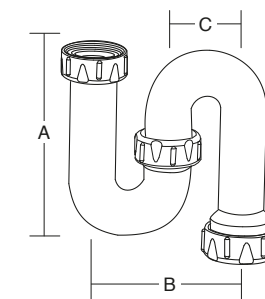

- Use for vertical pipework

PRODUCT CODE	SP032	SP040
SIZE (mm)	32	40
COLOUR	White	White
WATER SEAL DEPTH (mm)	75	75
WEIGHT (KG)	0.19	0.22
DIMENSIONS (mm) A x B x C x D	267 x 140 x 85 x 55	285 x 140 x 80 x 65

PRODUCT CODE	RP032	RP040	RP050X
SIZE (mm)	32	40	50
COLOUR	White	White	White
WATER SEAL DEPTH (mm)	75	75	75
WEIGHT (KG)	0.16	0.20	0.25
DIMENSIONS (mm) A x B x C x D	135 x 130 x 115 x 60	160 x 145 x 130 x 65	185 x 165 x 160 x 75

PRODUCT CODE	P032	P040	P050
SIZE (mm)	32	40	50
COLOUR	White	White	White
WATER SEAL DEPTH (mm)	75	75	75
WEIGHT (KG)	0.11	0.14	0.22
DIMENSIONS (mm) A x B x C x D	140 x 125 x 115 x 60	165 x 145 x 130 x 65	190 x 165 x 160 x 75

PRODUCT CODE	P032A	P040A
SIZE (mm)	32	40
COLOUR	White	White
WATER SEAL DEPTH (mm)	75	75
WEIGHT (KG)	0.15	0.20
DIMENSIONS (mm) A x B x C x D	220 x 135 x 115 x 60	245 x 145 x 130 x 65

PRODUCT CODE	S032	S040
SIZE (mm)	32	40
COLOUR	White	White
WATER SEAL DEPTH (mm)	75	75
WEIGHT (KG)	0.14	0.17
DIMENSIONS (mm) A x B x C	160 x 110 x 55	160 x 130 x 65

REASONS TO TRUST MULTIKWIK

Multi position outlet

The multi position outlet adjusts 360° for installations where space is at a premium or the pipework is misaligned.



Slip ring colours

To ensure accuracy and efficiency all Multikwik traps have unique slip ring colours to aid size identification.

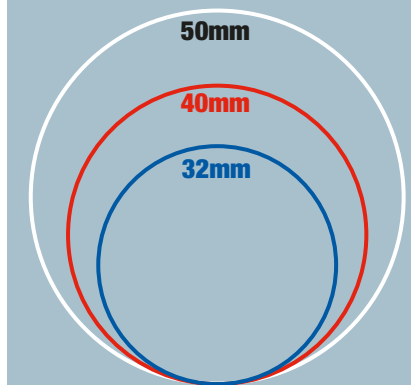

TRUST MULTIKWIK

All Multikwik traps have a multifit nut and seal that allow connection to push fit, solvent and copper pipes.

TRAPS / TUBULAR SWIVEL TRAP / SHOWER WASTE TRAP

KEY: Resealable Adjustable

TUBULAR SWIVEL

SWM040A

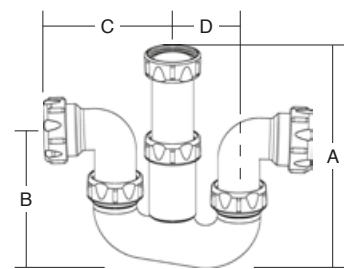

- Adjustable inlet for installation flexibility
- Inlet and outlet swivels to aid easy connection to pipes even in confined spaces

PRODUCT CODE	SWM040A
SIZE (mm)	40
COLOUR	White
WATER SEAL DEPTH (mm)	75
WEIGHT (KG)	0.25
DIMENSIONS (mm) A x B x C x D	255 x 150 x 127 x 65

SHOWER – COMPACT

S5040C

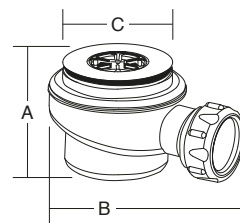

- Chrome waste
- 70mm flange
- High flow rate: 0.76 l/s

PRODUCT CODE	S5040C
SIZE (mm)	40 Outlet
COLOUR	White
WATER SEAL DEPTH (mm)	50
WEIGHT (KG)	0.18
DIMENSIONS (mm) A x B x C	92 x 150 x 70

SHOWER – COMPACT

S5040W

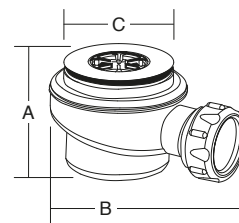

- White waste
- 70mm flange
- High flow rate: 0.76 l/s

PRODUCT CODE	S5040W
SIZE (mm)	40 Outlet
COLOUR	White
WATER SEAL DEPTH (mm)	50
WEIGHT (KG)	0.18
DIMENSIONS (mm) A x B x C	92 x 150 x 70

SHOWER – RESEALING

S5040CR

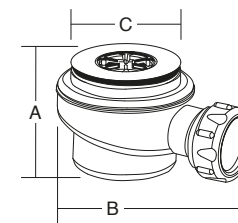

- Chrome waste
- Eliminates self-syphonage and gurgling through resealing device
- 70mm flange
- High flow rate: 0.76 l/s

PRODUCT CODE	S5040CR
SIZE (mm)	40 Outlet
COLOUR	White
WATER SEAL DEPTH (mm)	50
WEIGHT (KG)	0.18
DIMENSIONS (mm) A x B x C	92 x 150 x 70

REASONS TO TRUST MULTIKWIK

Access key

All shower traps are supplied with an access key for installation, easy cleaning and maintenance.



Resealing device

Install a resealing shower trap to eliminate self-syphonage and eradicate the gurgling in your system.



TRUST MULTIKWIK

The SWM040A Tubular Swivel Utility Trap is one of the most versatile fittings on the market, it swivels to any angle to accommodate any under-sink pipework configuration and the inlet is telescopic to allow maximum adjustment.

TRAPS / BATH WASTE TRAP

KEY: Resealable Adjustable

BATH – ONE PIECE

P1940

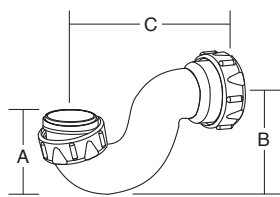

- For low level floors where a deeper water seal trap doesn't fit
- For appliances that discharge into a gully

PRODUCT CODE	P1940
SIZE (mm)	40
COLOUR	White
WATER SEAL DEPTH (mm)	19
WEIGHT (KG)	0.08
DIMENSIONS (mm) A x B x C	70 x 75 x 145

BATH – LOW LEVEL

P5040

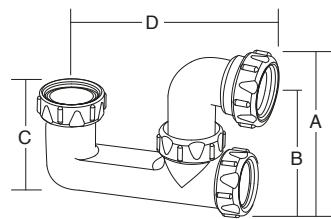

- Rodding point for cleaning

PRODUCT CODE	P5040
SIZE (mm)	40
COLOUR	White
WATER SEAL DEPTH (mm)	50
WEIGHT (KG)	0.15
DIMENSIONS (mm) A x B x C x D	140 x 110 x 89 x 172

BATH – LOW LEVEL ANTI-VAC

P5040V

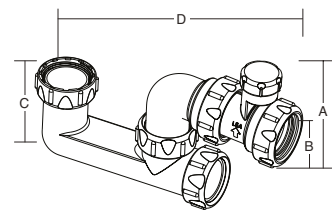

- Anti-vac allows air into the waste pipes to prevent self-syphonage of the traps water seal and gurgling
- Rodding point for cleaning

PRODUCT CODE	P5040V
SIZE (mm)	40
COLOUR	White
WATER SEAL DEPTH (mm)	50
WEIGHT (KG)	0.21
DIMENSIONS (mm) A x B x C x D	135 x 105 x 89 x 230

BATH – SWIVEL 'P' LOW LEVEL INLET

P040L

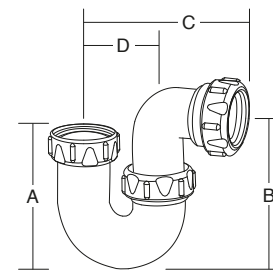

PRODUCT CODE	P040L
SIZE (mm)	40
COLOUR	White
WATER SEAL DEPTH (mm)	75
WEIGHT (KG)	0.13
DIMENSIONS (mm) A x B x C x D	125 x 150 x 127 x 65

BATH – STANDARD

P6040

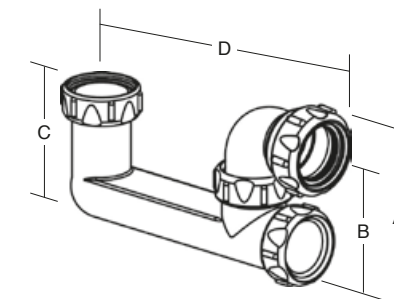

- Rodding point for cleaning

PRODUCT CODE	P6040
SIZE (mm)	40
COLOUR	White
WATER SEAL DEPTH (mm)	60
WEIGHT (KG)	0.17
DIMENSIONS (mm) A x B x C x D	140 x 110 x 98 x 220

REASONS TO TRUST MULTIKWIK

Size guide

32mm

- Hand basin
- Bidet
- Drinking fountain
- Kitchen appliances

40mm

- Bath
- Shower
- Sink
- Urinal

50mm

- Range of basins
- Range of urinals
- Catering sinks
- Hospital appliances

TRUST MULTIKWIK

All Multikwik traps have a 75mm seal unless otherwise stated.

TRAPS / TRAP ACCESSORIES

KEY: Resealable Adjustable

BATH – LOW LEVEL

P5040F

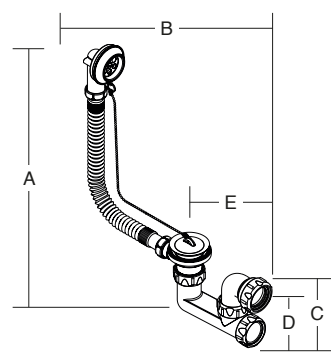

- Flexible overflow pipe for ease of installation
- Plug tidy overflow to retain plug when not in use

PRODUCT CODE	P5040F
SIZE (mm)	40
COLOUR	White
WATER SEAL DEPTH (mm)	50
WEIGHT (KG)	0.37
DIMENSIONS (mm) A x B x C x D x E	355 x 325 x 140 x 115 x 175

BATH – STANDARD

P6040F

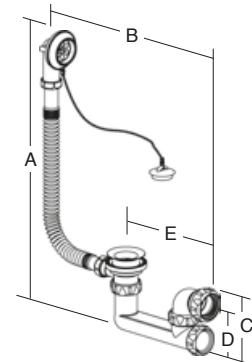

- Flexible overflow pipe for ease of installation
- Plug tidy overflow to retain plug when not in use

PRODUCT CODE	P6040F
SIZE (mm)	40
COLOUR	White
WATER SEAL DEPTH (mm)	60
WEIGHT (KG)	0.39
DIMENSIONS (mm) A x B x C x D x E	410 x 375 x 140 x 115 x 220

ANTI-VAC GURGLEMATER

WV032 | WV040

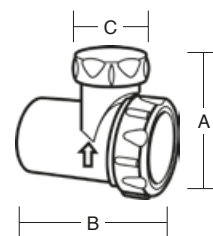

- Anti-vac allows air traps into the waste pipe to prevent gurgling and self-syphonage of the traps water seal
- Quick installation with simple multifit in-line assembly

PRODUCT CODE	WV032	WV040
SIZE (mm)	32	40
COLOUR	White	White
WEIGHT (KG)	0.05	0.06
DIMENSIONS (mm) A x B x C	80 x 90 x 39	90 x 90 x 40

ANTI-SYPHON UNIT

WW150 | WW151

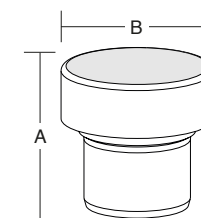

- To BS EN 12380
- Anti-vac allows air into the waste pipe to prevent gurgling and self-syphonage of the traps water seal
- Use with any BS EN 1566/5255 solvent weld sockets

PRODUCT CODE	WW150	WW151
SIZE (mm)	32	40
COLOUR	White	White
WEIGHT (KG)	0.05	0.05
DIMENSIONS (mm) A x B	57 x 61	60 x 61

WASHING MACHINE

PWM040

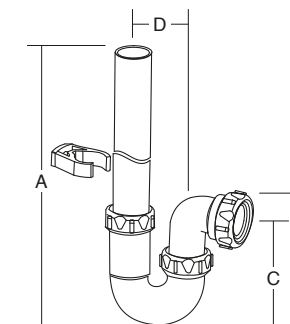

- Includes 500mm standpipe, retaining clips, screws and raw plugs

PRODUCT CODE	PWM040
SIZE (mm)	40
COLOUR	White
WATER SEAL DEPTH (mm)	75
WEIGHT (KG)	0.29
DIMENSIONS (mm) A x B x C x D	560 x 160 x 140 x 65

REASONS TO TRUST MULTIKWIK

Plug tidy overflow

Wondering about the plug tidy overflow feature? It retains the plug, when the bath is not in use.



Gurgle master

Can convert many traps from standard to anti-vac trap through quick in-line assembly.



TRUST MULTIKWIK

Part H requires ventilation of a soil stack to prevent water seals being drawn. Multikwik offers a number of unique and innovative solutions for ventilation to drainage systems such as our anti-siphon unit.

TRAPS / UTILITY WASTE TRAP

KEY: Resealable Adjustable

UTILITY 'P' COMPACT
– SINGLE NOZZLE

PWM040T

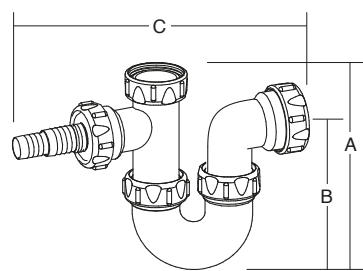

- Nozzle for connecting a washing machine or dishwasher

PRODUCT CODE	PWM040T
SIZE (mm)	40
COLOUR	White
WATER SEAL DEPTH (mm)	75
WEIGHT (KG)	0.21
DIMENSIONS (mm) A x B x C	190 x 145 x 270

ADJUSTABLE UTILITY 'P'
– SINGLE NOZZLE

PWM040S

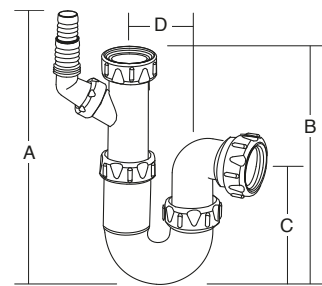

- Adjustable inlet for installation flexibility
- For connecting a washing machine or dishwasher
- Non-return valve to prevent backflow in nozzle
- Min height: 250mm; max height: 310mm

PRODUCT CODE	PWM040S
SIZE (mm)	40
COLOUR	White
WATER SEAL DEPTH (mm)	75
WEIGHT (KG)	0.20
DIMENSIONS (mm) A x B x C x D	250 x 215 x 145 x 65

ADJUSTABLE UTILITY 'P'
– DOUBLE NOZZLE

PWM040D

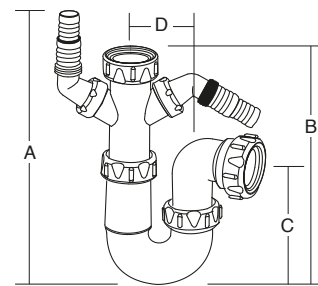

- Adjustable inlet for installation flexibility
- For connecting two appliances
- Non-return valve to prevent backflow in nozzle
- Min height: 250mm; max height: 310mm

PRODUCT CODE	PWM040D
SIZE (mm)	40
COLOUR	White
WATER SEAL DEPTH (mm)	75
WEIGHT (KG)	0.23
DIMENSIONS (mm) A x B x C x D	250 x 215 x 145 x 65

ADJUSTABLE UTILITY 'S'
– SINGLE NOZZLE

SWM040S

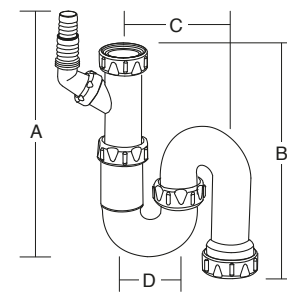

- Adjustable inlet for installation flexibility
- For connecting a washing machine or a dishwasher
- Non-return valve to prevent backflow in nozzle
- Min height: 250mm; max height: 310mm

PRODUCT CODE	SWM040S
SIZE (mm)	40
COLOUR	White
WATER SEAL DEPTH (mm)	75
WEIGHT (KG)	0.24
DIMENSIONS (mm) A x B x C x D	250 x 217 x 125 x 65

ADJUSTABLE UTILITY 'S'
– DOUBLE NOZZLE

SWM040D

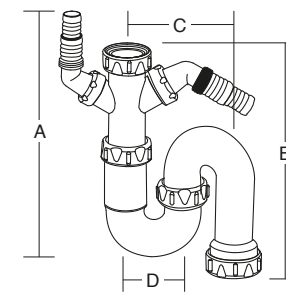

- Adjustable inlet for installation flexibility
- For connecting a washing machine and dishwasher
- Non-return valve to prevent backflow in nozzle
- Min height: 250mm; max height: 330mm

PRODUCT CODE	SWM040D
SIZE (mm)	40
COLOUR	White
WATER SEAL DEPTH (mm)	75
WEIGHT (KG)	0.26
DIMENSIONS (mm) A x B x C x D	250 x 220 x 125 x 65

REASONS TO TRUST MULTIKWIK

Non-return valve

To prevent the backflow of dirty water to your appliances, all nozzles are fitted with a non-return valve for peace of mind!



Multikwik nozzles

They allow a simple connection to washing machines and dishwashers. The stepped inlet ensures that even if the pipe isn't entirely true, it will still form a reliable watertight environment.



TRUST MULTIKWIK

All nozzles are supplied with a blanking cap to keep the inside of the product clean to the point of installation – an important benefit, especially on site!

TRAPS / BOWL KITS

KEY: Resealable Adjustable

SPACE SAVER KIT

SBK040D

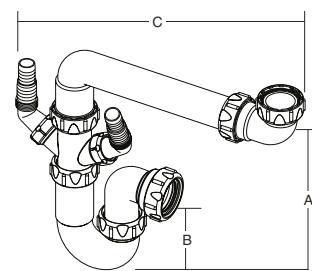

- Single bowl, double nozzle
- Flexible installation with full width and height adjustment

PRODUCT CODE	SBK040D
SIZE (mm)	40
COLOUR	White
WATER SEAL DEPTH (mm)	75
WEIGHT (KG)	0.34
DIMENSIONS (mm) A x B x C	330 x 145 x 375

1½ BOWL KIT – SINGLE NOZZLE

XSB040S

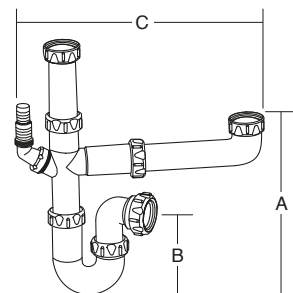

- Flexible installation with full width and height adjustment

PRODUCT CODE	XSB040S
SIZE (mm)	40
COLOUR	White
WATER SEAL DEPTH (mm)	75
WEIGHT (KG)	0.36
DIMENSIONS (mm) A x B x C	410 x 140 x 395

DOUBLE BOWL KIT – SINGLE NOZZLE

DBK040S

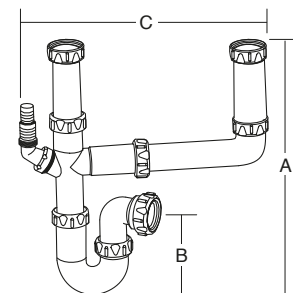

- Flexible installation with full width and height adjustment

PRODUCT CODE	DBK040S
SIZE (mm)	40
COLOUR	White
WATER SEAL DEPTH (mm)	75
WEIGHT (KG)	0.42
DIMENSIONS (mm) A x B x C	410 x 140 x 395

EXTENDED DOUBLE BOWL KIT – DOUBLE NOZZLE

DBKDS040

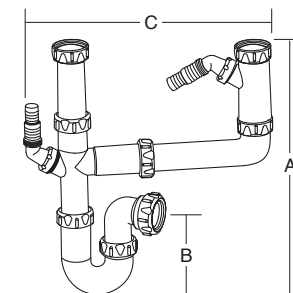

- Flexible installation with full width and height adjustment

PRODUCT CODE	DBKDS040
SIZE (mm)	40
COLOUR	White
WATER SEAL DEPTH (mm)	75
WEIGHT (KG)	0.49
DIMENSIONS (mm) A x B x C	410 x 140 x 610

TRAP HEIGHT ADJUSTER – SINGLE NOZZLE

WA040S

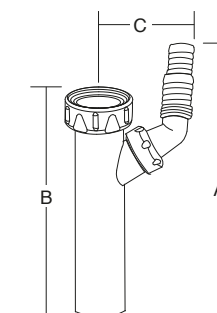

- For connections to a washing machine or dishwasher
- Non-return valve prevents backflow in nozzle

PRODUCT CODE	WA040S
SIZE (mm)	40
COLOUR	White
WEIGHT (KG)	0.07
DIMENSIONS (mm) A x B x C	195 x 150 x 70

TRAP HEIGHT ADJUSTER – DOUBLE NOZZLE

WA040D

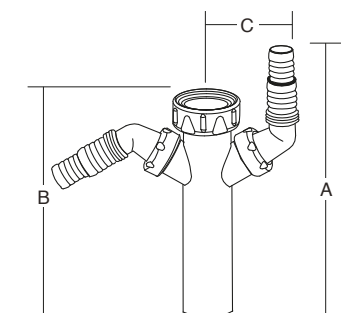

- For connections to a washing machine and dishwasher
- Non-return valve prevents backflow in nozzle

PRODUCT CODE	WA040D
SIZE (mm)	40
COLOUR	White
WEIGHT (KG)	0.10
DIMENSIONS (mm) A x B x C	195 x 150 x 78

SPACE SAVER

SBSK040

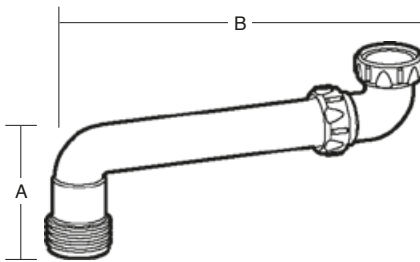

- Space saving design: pushes the trap & pipework to the back of the cupboard
- Trap not included

NOZZLE – ANGLED

NK001

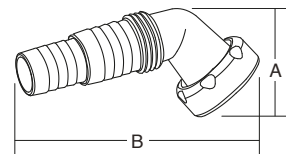

- Threaded connection to trap
- Simple connection for washing machines & dishwashers
- Non-return valve prevents backflow in nozzle
- Nozzle can be cut to suit a variety of applications
- To suit 1" & ¾" hose diameter

NOZZLE – STRAIGHT

NKT001

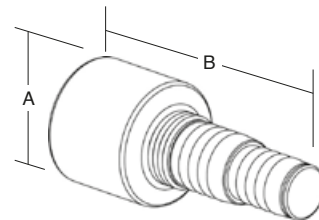

- To suit 1" and ¾" hose diameter
- For a variety of appliance hose connections
- Non-return valve prevents backflow
- Nozzle can be cut to suit a variety of applications

WASHING MACHINE TEE

WMT001

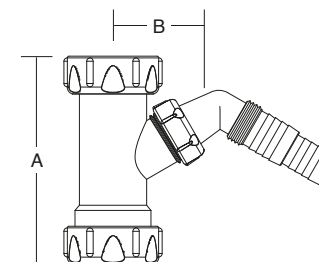

- 1½" BSP sink waste connection
- Can be inserted between an existing trap and outlet

FLEXIBLE CONNECTOR

WW170

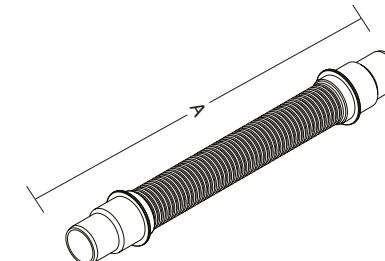

- Not suitable for solvent weld
- 350mm length. Cut end to suit compression fittings

WASHING MACHINE HOSE 1.5M

WW171

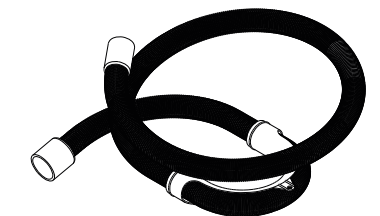

- Fit in accordance with the appliance manufacturers guidelines
- Non kink hose with rest support for reliable installation

PRODUCT CODE	SBSK040
SIZE (mm)	40
COLOUR	White
WEIGHT (KG)	0.11
DIMENSIONS (mm) A x B	125 x 325

PRODUCT CODE	NK001
SIZE (mm)	40
COLOUR	White
WEIGHT (KG)	0.02
DIMENSIONS (mm) A x B	55 x 110

PRODUCT CODE	NKT001
SIZE (mm)	40
COLOUR	White
WEIGHT (KG)	0.02
DIMENSIONS (mm) A x B	44 x 103

PRODUCT CODE	WMT001
SIZE (mm)	40
COLOUR	White
WEIGHT (KG)	0.06
DIMENSIONS (mm) A x B	113 x 65

PRODUCT CODE	WW170
SIZE (mm)	32/40
COLOUR	White
WEIGHT (KG)	0.1
DIMENSIONS (mm) A	350

PRODUCT CODE	WW171
SIZE (mm)	40
COLOUR	Grey
WEIGHT (KG)	0.15
DIMENSIONS (mm) A	1500

TRAPS / WASTE ACCESSORIES

KEY: Resealable Adjustable

BASIC SINK WASTE AND OVERFLOW KIT

CWS01

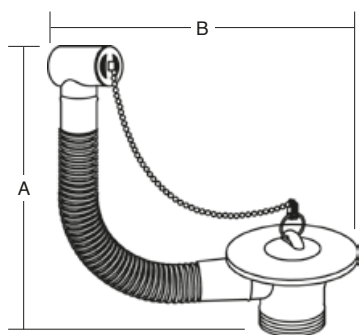

- Extendable overflow to suit various overflow heights
- Flexible overflow pipe

SINK WASTE AND OVERFLOW KIT

W4070RF

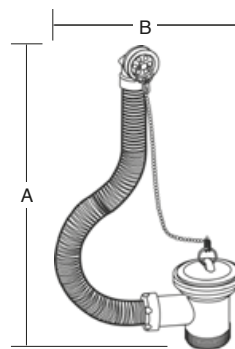

- Extendable overflow to suit various overflow heights
- Flexible overflow pipe

BASIC BATH WASTE AND OVERFLOW KIT

CWB01

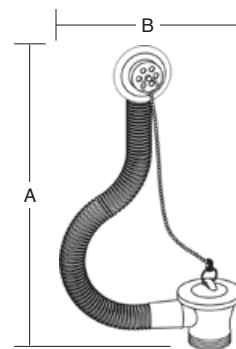

- Extendable overflow to suit various overflow heights
- Flexible overflow pipe

BATH WASTE AND OVERFLOW KIT

W040F

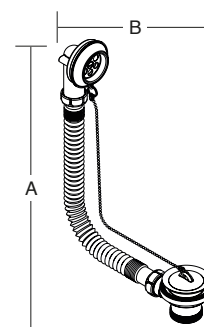

- Extendable overflow to suit various overflow heights
- Flexible overflow pipe
- Plug tidy overflow to retain the plug when not in use

BATH WASTE AND OVERFLOW KIT

WPU040C

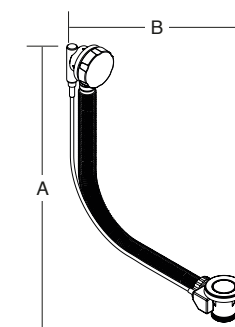

- Extendable overflow to suit various overflow heights
- Flexible overflow pipe
- Includes pop up waste

SLOTTED BASIN WASTE OUTLET

SBW01

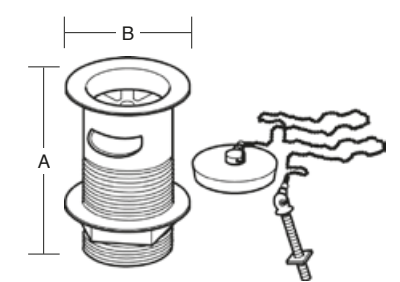

- Includes polyplug, chain and stay
- Slotted – for basins with an integral overflow

PRODUCT CODE	CWS01
SIZE (mm)	40
COLOUR	Black
WEIGHT (KG)	0.13
DIMENSIONS (mm) A x B	220 x 115

PRODUCT CODE	W4070RF
SIZE (mm)	40
COLOUR	White
WEIGHT (KG)	0.16
DIMENSIONS (mm) A x B	275 x 155

PRODUCT CODE	CWB01
SIZE (mm)	40
COLOUR	Black
WEIGHT (KG)	0.16
DIMENSIONS (mm) A x B	275 x 160

PRODUCT CODE	W040F
SIZE (mm)	40
COLOUR	White
WEIGHT (KG)	0.34
DIMENSIONS (mm) A x B	295 x 375

PRODUCT CODE	WPU040C
SIZE (mm)	40
COLOUR	White
WEIGHT (KG)	0.72
DIMENSIONS (mm) A x B	430 x 385

PRODUCT CODE	SBW01
SIZE (mm)	32
COLOUR	Stainless steel
WEIGHT (KG)	0.18
DIMENSIONS (mm) A x B	85 x 60

COMPRESSION WASTE

RELIABILITY YOU CAN **TRUST**

When designing and building any type of development, we know that costs and aesthetics can play a huge part in making decisions.

That's where Multikwik offers the choice – standard white compression waste components for hidden plumbing, and a chrome covered compression waste system for exposed pipework. Both options have a smooth inner bore, to reduce the chance of blockages and thumb recesses for easy hand tightening.

PROBLEM SOLVED

Multiflex
MFW32 | MFW40

- Adjustable from 0 – 90°
- Suitable for almost any installation



PROBLEM SOLVED

Condense adaptor
EB40R

- Adapts to condense line
- Fits most sizes of overflow (16.5 – 24mm)

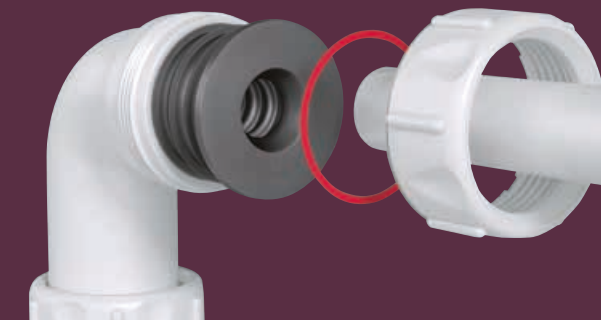

PROBLEM SOLVED

Easy Boss
MKEB4032G | MKEB4032B



- Connects 32mm or 40mm solvent or push fit pipe to 110mm soil stack
- No straps, ideal for limited access installations
- No solvent cement required for push fit connection
- Includes adaptor for easy solvent weld connection

COMPRESSION WASTE

KEY: Resealable Adjustable

OVERFLOW
CONDENSE ADAPTOR

EB40R

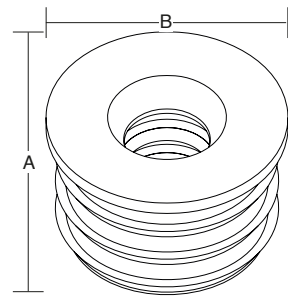

- Adapts to condensate pipework
- Connects 40mm to 16.5 – 24mm

MULTIFLEX BEND

MFW32 | MFW40

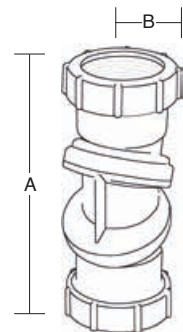

- Adjustable from 0 – 90° to meet demands of almost any installation

REDUCER

WP124 | WP225

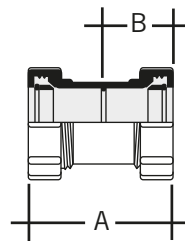

STRAIGHT COUPLING

WP114 | WP115 | WP216

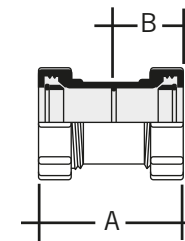

90° BEND

WP120 | WP121 | WP222

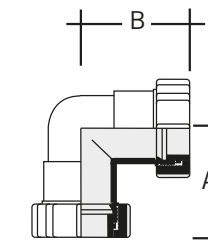

REASONS TO
TRUST MULTIKWIK

Multiflex bend

A problem solver to help overcome some of the challenges of non uniform installations.



Condensate adaptor

The EB40R condensate overflow adaptor is a simple solution to prevent your condensate pipe from freezing. It fits any 40mm trap or 40mm compression fitting and is designed to accept almost all overflow pipe sizes from 16.5 to 24mm.

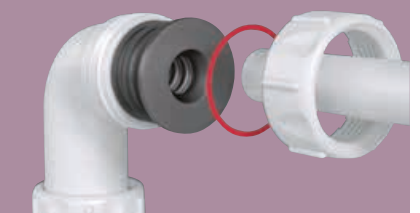

TRUST MULTIKWIK

The thumb recesses of Multikwik compression waste make it easy to tighten, even with wet hands to ensure a 'fit and forget' job every time!

PRODUCT CODE	EB40R
SIZE (mm)	40
COLOUR	Black
WEIGHT (KG)	0.03
DIMENSIONS (mm) A	34 x 50

PRODUCT CODE	MFW32	MFW40
SIZE (mm)	32	40
COLOUR	White	White
WEIGHT (KG)	0.07	0.10
DIMENSIONS (mm) A x B	131 x 26	145 x 31

PRODUCT CODE	WP124	WP225
SIZE (mm)	32/40	40/50
COLOUR	White	White
WEIGHT (KG)	0.06	0.07
DIMENSIONS (mm) A x B	70 x 35	78 x 39

PRODUCT CODE	WP114	WP115	WP216
SIZE (mm)	32	40	50
COLOUR	White	White	White
WEIGHT (KG)	0.04	0.05	0.10
DIMENSIONS (mm) A x B	70 x 35	70 x 35	100 x 50

PRODUCT CODE	WP120	WP121	WP222
SIZE (mm)	32	40	50
COLOUR	White	White	White
WEIGHT (KG)	0.05	0.06	0.13
DIMENSIONS (mm) A x B	55 x 55	60 x 60	83 x 83

COMPRESSION WASTE

135° BEND

WP126 | WP127 | WP218

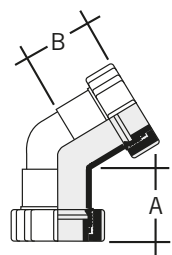

92.5° TEE

WP128 | WP129 | WP230

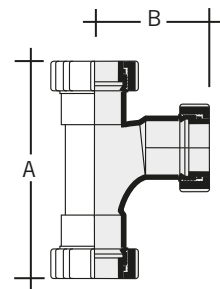

400MM PIPE

WP101C | WP102C



■ High quality mirror chrome finish

1.1M PIPE

WP105C | WP106C



■ High quality mirror chrome finish

STRAIGHT COUPLING

WP114C | WP115C

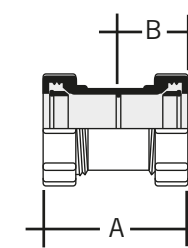

■ High quality mirror chrome finish



REASONS TO TRUST MULTIKWIK

White and chrome colour options

The compression waste range is available in a white and chrome finish in 32mm, 40mm and 50mm options.



Slip ring colours

To save time on site all Multikwik compression fittings have unique slip ring colours to aid size identification.

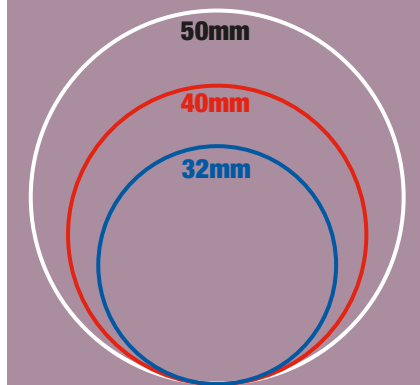

PRODUCT CODE	WP126	WP127	WP218
SIZE (mm)	32	40	50
COLOUR	White	White	White
WEIGHT (KG)	0.04	0.05	0.12
DIMENSIONS (mm) A x B	50 x 37	50 x 37	70 x 52

PRODUCT CODE	WP128	WP129	WP230
SIZE (mm)	32	40	50
COLOUR	White	White	White
WEIGHT (KG)	0.07	0.09	0.19
DIMENSIONS (mm) A x B	120 x 65	130 x 75	174 x 85

PRODUCT CODE	WP101C	WP102C
SIZE (mm)	32	40
COLOUR	Chrome	Chrome
WEIGHT (KG)	0.09	0.12

PRODUCT CODE	WP105C	WP106C
SIZE (mm)	32	40
COLOUR	Chrome	Chrome
WEIGHT (KG)	0.25	0.32

PRODUCT CODE	WP114C	WP115C
SIZE (mm)	32	40
COLOUR	Chrome	Chrome
WEIGHT (KG)	0.04	0.05
DIMENSIONS (mm) A x B	70 x 35	78 x 39

TRUST MULTIKWIK

Our fittings have smooth and clean internal surfaces and have been designed so they do not require an internal pipe locating sleeve, reducing the chances of blockages.

COMPRESSION WASTE

PIPE CLIP

WP141C | WP142C

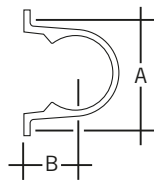

■ High quality mirror chrome finish

90° BEND

WP120C | WP121C

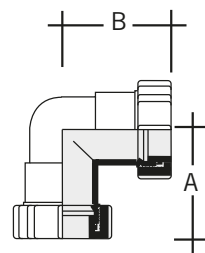

■ High quality mirror chrome finish

92.5° TEE

WP129C

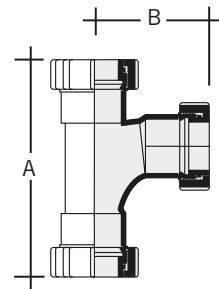

■ High quality mirror chrome finish

PIPE COVER

WP153C | WP154C

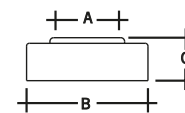

■ High quality mirror chrome finish

EASY BOSS

MKEB4032G | MKEB4032B

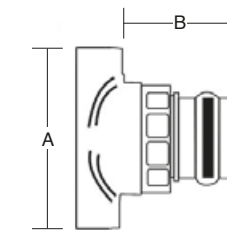
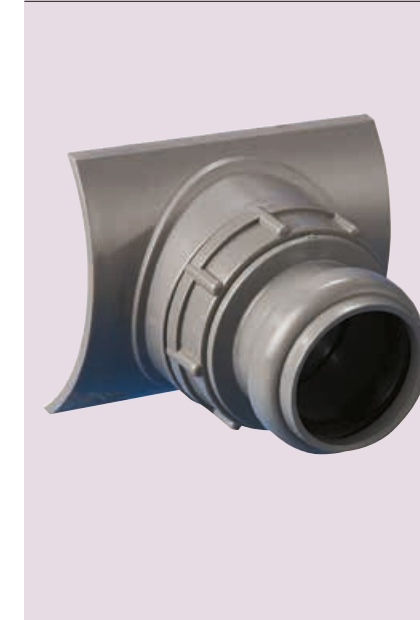

■ Fits 32mm and 40mm push-fit and solvent waste pipes
 ■ For connection (push fit or solvent weld) to 110mm soil stacks



REASONS TO TRUST MULTIKWIK

How to make a simple boss connection...

- 1 Drill 57mm hole
- 2 Ensure seal is in position
- 3 Insert Easy Boss into the hole
- 4 Twist in the Easy Boss connector
- 5 Use a strap wrench and hand tighten
- 6 Insert the pipe

TRUST MULTIKWIK

The Multikwik Easy Boss is tested to a 5m head of water, providing a reliable connection from push fit and solvent waste pipes to a standard 110mm soil stack and can be installed anywhere in a run.

PRODUCT CODE	WP141C	WP142C
SIZE (mm)	32	40
COLOUR	Chrome	Chrome
WEIGHT (KG)	0.01	0.02
DIMENSIONS (mm) A x B x C	76 x 30	82 x 30

PRODUCT CODE	WP120C	WP121C
SIZE (mm)	32	40
COLOUR	Chrome	Chrome
WEIGHT (KG)	0.05	0.06
DIMENSIONS (mm) A x B	55 x 55	60 x 60

PRODUCT CODE	WP129C
SIZE (mm)	40
COLOUR	Chrome
WEIGHT (KG)	0.09
DIMENSIONS (mm) A x B	130 x 75

PRODUCT CODE	WP153C	WP154C
SIZE (mm)	32	40
COLOUR	Chrome	Chrome
WEIGHT (KG)	0.03	0.04
DIMENSIONS (mm) A x B x C	38 x 65 x 19	40 x 65 x 23

PRODUCT CODE	MKEB4032G	MKEB4032B
SIZE (mm)	110	110
COLOUR	Grey	Black
WEIGHT (KG)	0.20	0.20
DIMENSIONS (mm) A x B	105 x 65	105 x 65



Multikwik®
**WC
CONNECTORS**

FLEXIBILITY YOU CAN **TRUST**

At Multikwik we take great pride in plumbing and offer innovative products that are capable of giving you that little bit of extra help.

Thanks to the flexible EVA and reliable TPE seals, the Multikwik WC connectors allow for imperfect pipes and spigots, while still ensuring a watertight joint past the point of installation – ideal for tolerating movement and WC load bearing pressures. The seals and multidepth finns give additional peace of mind for a secure seal.

Multikwik were pioneers 50 years ago, with the introduction of a flexible WC connector and we're proud to say that we are still the name asked for by plumbers. Trust Multikwik to be your first choice for WC connectors.

WC Connectors

Our comprehensive range is one of the largest on the market, and covers spigots of 74mm – 114mm, ensuring an accurate fit, regardless of the make and model of sanitary chinaware.

Selecting the right WC connector

Measure the **OUTER** diameter of your spigot.



Measure the **INNER** diameter of your pipe.



Then take a look at the dimensions provided for the individual connectors to find the best matches.

Know your WC pan spigot

KEY	SIZE	PIPE SUITABILITY	BRITISH STANDARD
PAGE: 62-73	97-108 mm	Modern & New Pans	BS 5503 & BS 5504
PAGE: 73-75	108-114 mm	Old & Syphonic Pans	BS 1213
PAGE: 76-77	76-95 mm	Stainless Steel Pans	—

Know your pipe

KEY	SIZE	PIPE SUITABILITY	BRITISH STANDARD
STANDARD ①	99-105 mm	uPVC / Clay / Cast Iron	BS 4514/BS 4660/ BS 65/BS 416
CAST IRON ②	88-92 mm	Traditional Cast Iron	—
OLD ③	74-77 mm	—	—
COPPER ④	105-108 mm	Copper	—

All WC connectors are made to fit pans conforming to BS 5503 and BS 5504, including ones with bosses.

PROBLEM SOLVED

90° space saver bend
MKBAR90

- Can be cut horizontally and vertically to suit, seals slide back on once cut
- Ideal for replacing old BS1213 'S' trap pans

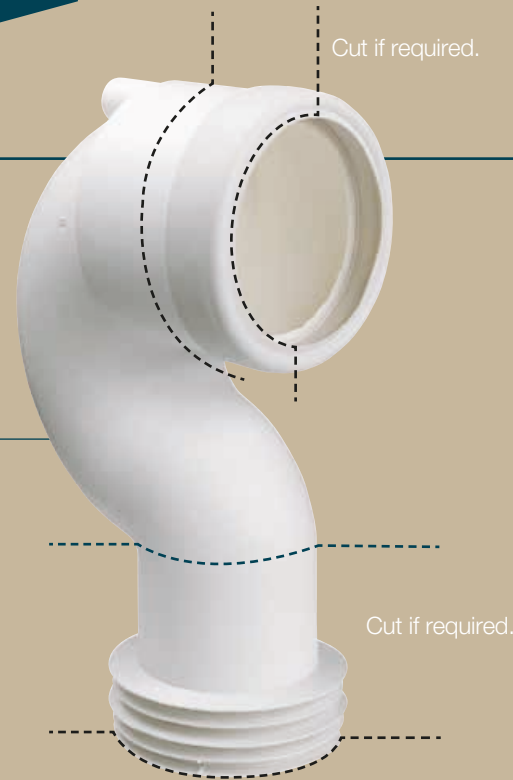

PROBLEM SOLVED

Multiclik flexible straight WC connector
MKC2

- Extends from 225 to 550mm
- Superior quality hose
- Retains its position whatever shape is required
- Ideal for installing back to the wall, floor standing pans



PROBLEM SOLVED

90° bend flexible WC connector
MKC2B90

- Extends from 375 to 710mm
- Converts a 'P' trap into an 'S' trap with adjustment for final connection
- Superior quality hose
- Retains its position whatever shape is required



PROBLEM SOLVED

Soil pipe extension
MKEA

- Can be cut to required length
- Ideal when removing 4" cast iron, clay and PVCu



PROBLEM SOLVED

Multilink
MKL1

- Sleeves the fins of all 99 – 105mm Multikwik WC connector outlets, allowing a direct connection to another WC connector
- Ideal for the most unusual installations



PROBLEM SOLVED

90° bend flexible WC connector with Vent Boss
MKC2BB90

- Extends from 405 to 740mm
- Converts a 'P' trap into an 'S' trap with adjustment for final connection
- Superior quality hose
- Retains its position whatever shape is required



WC CONNECTORS / MODERN

PIPE 1: Standard 99-105mm 2: Cast Iron 88-92mm 3: Old 74-77mm 4: Copper 105-108mm:

STRAIGHT

MKS2 1

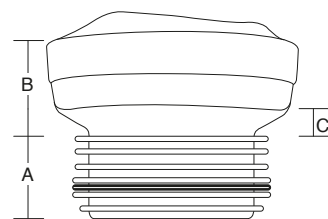

- Known as the No.2 – the plumbers favourite
- This connector is for new style pans only

EXTENDED STRAIGHT

MKS4 1

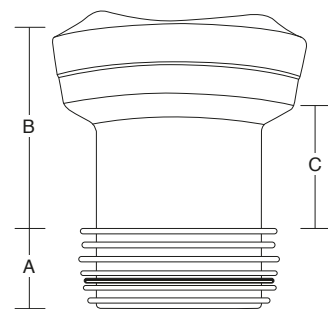

PRODUCT CODE	MKS4
PAN SPIGOT OUTER DIAMETER (mm)	97 – 108
SOIL PIPE INNER DIAMETER (mm)	99 – 105
WEIGHT (KG)	0.19
DIMENSIONS (mm) A x B x C	43 x 105 x 70

LONG ADJUSTABLE STRAIGHT

MKLA1 1

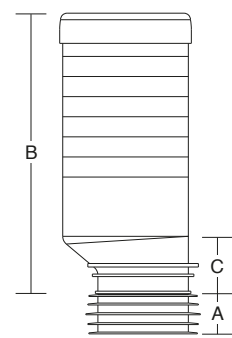

- Can be cut to suit
- This connector is for new style pans only

PRODUCT CODE	MKLA1
PAN SPIGOT OUTER DIAMETER (mm)	97 – 108
SOIL PIPE INNER DIAMETER (mm)	99 – 105
WEIGHT (KG)	0.46
DIMENSIONS (mm) A x B x C	40 x 285 x 255

STRAIGHT – VENT BOSS

MKSB4 1

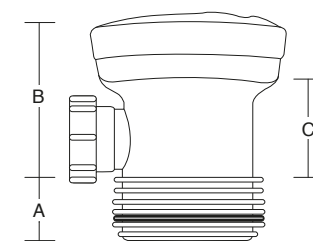

- 40mm vent boss

PRODUCT CODE	MKSB4
PAN SPIGOT OUTER DIAMETER (mm)	97 – 108
SOIL PIPE INNER DIAMETER (mm)	99 – 105
WEIGHT (KG)	0.22
DIMENSIONS (mm) A x B x C	42 x 104 x 70

18MM OFFSET

MKO2 1

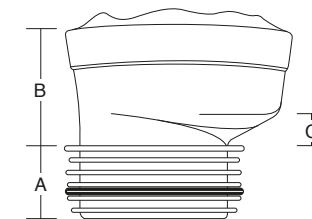

PRODUCT CODE	MKO2
PAN SPIGOT OUTER DIAMETER (mm)	97 – 108
SOIL PIPE INNER DIAMETER (mm)	99 – 105
WEIGHT (KG)	0.17
DIMENSIONS (mm) A x B x C	45 x 70 x 20

REASONS TO TRUST MULTIKWIK

Sealing flanges



When connecting a WC connector to the pan spigot, the sealing flanges must be pushed inside with the pipe.

Don't pull the other sealing flange out over the top of the pan spigot – it may lead to leaks.



MKS1 vs MKS2

It's easy to get it right! When you install a new toilet, in a new build development, you should use a MKS2 WC connector. When you refurbish an old toilet, you need to use a MKS1 WC connector (see page 73).

Use MKS1 on an installation, where it's been DONE!

Use MKS2 on an installation, where it's all NEW!

TRUST MULTIKWIK

Since its inception Multikwik has revolutionised plumbing in the UK. It was one of the first companies to support the use of plastics in plumbing. The innovative EVA WC connectors first introduced to the UK by Multikwik provided plumbers with a solution to a long standing plumbing problem.

WC CONNECTORS / MODERN

KEY: Adjustable

PIPE **1**: Standard 99-105mm **2**: Cast Iron 88-92mm **3**: Old 74-77mm **4**: Copper 105-108mm:

40MM OFFSET

MK04

1

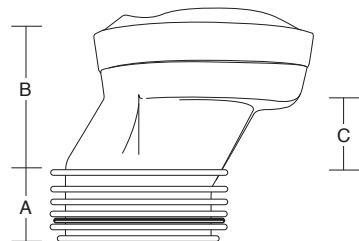

MULTICLIK – FLEXIBLE STRAIGHT

MKC2

1

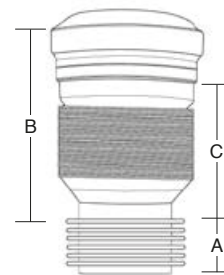

- Extends from 225 to 550mm
- Superior quality hose retains its position whatever shape is required
- Ideal when installing back to the wall, floor standing pans

MULTICLIK 90° BEND

MKC2B90

1

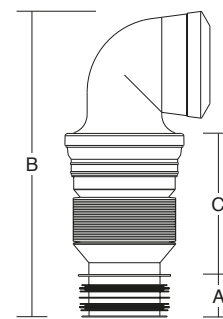

- Extends from 375 to 710mm
- Superior quality hose retains its position whatever shape is required
- Converts a 'P' trap into an 'S' trap with adjustment for final connection

MULTICLIK 90° BEND INCL. BOSS

MKC2BB90

1

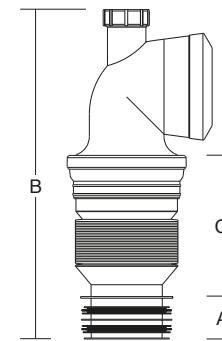

- Extends from 405 to 740mm
- Superior quality hose retains its position whatever shape is required
- Converts a 'P' trap into an 'S' trap with adjustment for final connection
- To be installed in a vertical position

REASONS TO TRUST MULTIKWIK

Multiclik connector



Retains its position whatever shape is required.

Extends from 225 to 550mm.

Flexible ends for excellent joint quality.

PRODUCT CODE	MK04
PAN SPIGOT OUTER DIAMETER (mm)	97 – 108
SOIL PIPE INNER DIAMETER (mm)	99 – 105
WEIGHT (KG)	0.19
DIMENSIONS (mm) A x B x C	43 x 85 x 43

PRODUCT CODE	MKC2
PAN SPIGOT OUTER DIAMETER (mm)	97 – 108
SOIL PIPE INNER DIAMETER (mm)	99 – 105
WEIGHT (KG)	0.37
DIMENSIONS (mm) A x B x C	50 x 170 x 120

PRODUCT CODE	MKC2B90
PAN SPIGOT OUTER DIAMETER (mm)	97 – 108
SOIL PIPE INNER DIAMETER (mm)	99 – 105
WEIGHT (KG)	0.57
DIMENSIONS (mm) A x B x C	50 x 270 x 110

PRODUCT CODE	MKC2BB90
PAN SPIGOT OUTER DIAMETER (mm)	97 – 108
SOIL PIPE INNER DIAMETER (mm)	99 – 105
WEIGHT (KG)	0.59
DIMENSIONS (mm) A x B x C	50 x 265 x 105

TRUST MULTIKWIK

All Multikwik fins have been designed to be multi depth – to give tolerance on connection to pipe – ensuring a reliable connection to all pipe sizes and materials.



WC CONNECTORS / MODERN

PIPE 1: Standard 99-105mm 2: Cast Iron 88-92mm 3: Old 74-77mm 4: Copper 105-108mm:

14° BEND

MKB114

1

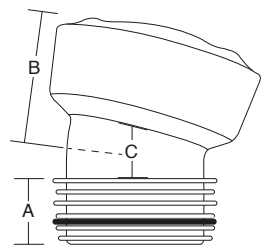

45° BEND

MKB45

1

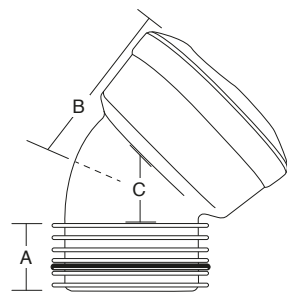

■ Ideal for corner installations

104° BEND

MKB21104

1

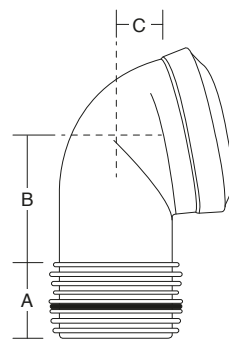

90° BEND

MKB2190

1

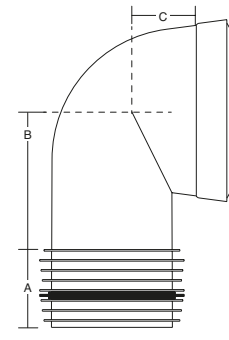

90° BEND – VENT BOSS

MKBB2190

1

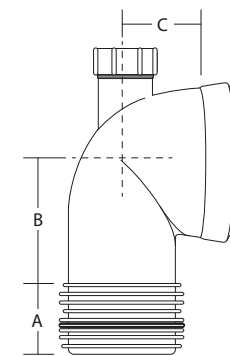

- 40mm vent boss
- Must be used in a vertical position if boss is being used.



REASONS TO TRUST MULTIKWIK

Make sure you know your pans and spigots

Pan dimensions

- 97 – 108mm Modern Pans
- 108 – 114mm Old Pans
- 76 – 96mm Stainless Steel

Spigot sizes

- 1 99 – 105mm Standard
- 2 88 – 92mm Cast Iron
- 3 74 – 77mm Old
- 4 105 – 108mm Copper



Multilink

Multilink is a unique fitting which sleeves the fins of all 99 – 105mm outlet Multikwik pan connectors. Enabling direct connection to be made to the inlet of another pan connector.



See page 79 for Multilink.

PRODUCT CODE	MKB114
PAN SPIGOT OUTER DIAMETER (mm)	97 – 108
SOIL PIPE INNER DIAMETER (mm)	99 – 105
WEIGHT (KG)	0.19
DIMENSIONS (mm) A x B x C	43 x 80 x 30

PRODUCT CODE	MKB45
PAN SPIGOT OUTER DIAMETER (mm)	97 – 108
SOIL PIPE INNER DIAMETER (mm)	99 – 105
WEIGHT (KG)	0.19
DIMENSIONS (mm) A x B x C	43 x 100 x 60

PRODUCT CODE	MKB21104
PAN SPIGOT OUTER DIAMETER (mm)	97 – 108
SOIL PIPE INNER DIAMETER (mm)	99 – 105
WEIGHT (KG)	0.24
DIMENSIONS (mm) A x B x C	60 x 110 x 34

PRODUCT CODE	MKB2190
PAN SPIGOT OUTER DIAMETER (mm)	97 – 108
SOIL PIPE INNER DIAMETER (mm)	99 – 105
WEIGHT (KG)	0.30
DIMENSIONS (mm) A x B x C	60 x 115 x 80

PRODUCT CODE	MKBB2190
PAN SPIGOT OUTER DIAMETER (mm)	97 – 108
SOIL PIPE INNER DIAMETER (mm)	99 – 105
WEIGHT (KG)	0.31
DIMENSIONS (mm) A x B x C	60 x 110 x 65

TRUST MULTIKWIK

Don't worry if your pipe or spigot aren't true – Multikwik WC connectors are made from EVA and are designed to be flexible.

WC CONNECTORS / MODERN

PIPE 1: Standard 99-105mm 2: Cast Iron 88-92mm 3: Old 74-77mm 4: Copper 105-108mm:

90° BEND – TALL

MKB3190

1

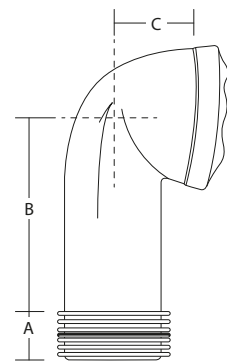

90° BEND – VENT BOSS

MKBB3190

1

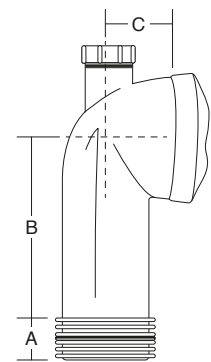

- Includes 40mm compression boss
- Must be used in a vertical position if boss is being used

90° SPACE SAVER BEND

MKBAR90

1

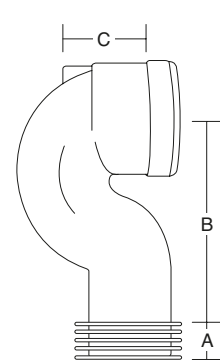

- Ideal when replacing old BS1213 'S' trap pans
- Can be cut to suit both horizontally and vertically

RIGID 18MM OFFSET

MKRO2

1

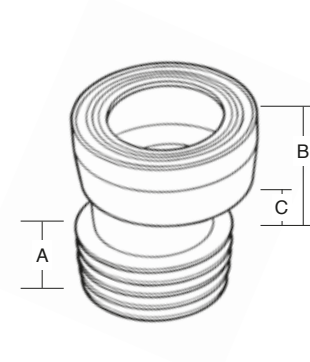

RIGID 14° BEND

MKRB14

1

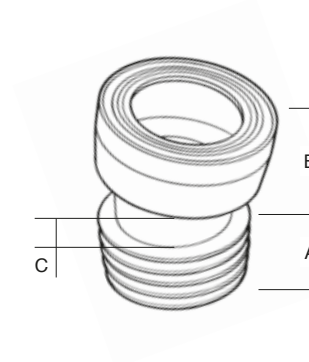

REASONS TO TRUST MULTIKWIK

Space Saver Bend

Can be cut to suit both horizontally and vertically.

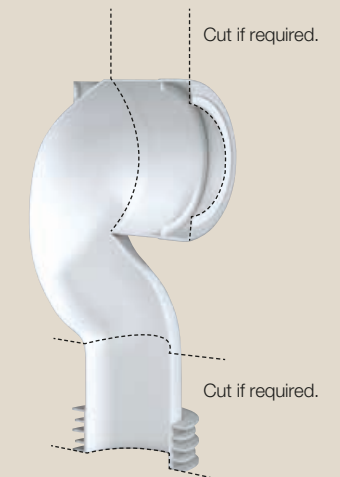

Soil Pipe Extensions

Available for 4", 3½" and 3" a Multikwik Soil Pipe Extension can be cut to required length, removing the unsightly existing pipe within the bathroom.



See page 78 for Pipe Extensions.

TRUST MULTIKWIK

British Standards state that a solid ball of 80mm must pass through pipework unaided. All Multikwik WC connectors including those with boss upstands meet this requirement, reducing the chance of blockage and expensive remedial costs.

PRODUCT CODE	MKB3190
PAN SPIGOT OUTER DIAMETER (mm)	97 – 108
SOIL PIPE INNER DIAMETER (mm)	99 – 105
WEIGHT (KG)	0.36
DIMENSIONS (mm) A x B x C	43 x 200 x 90

PRODUCT CODE	MKBB3190
PAN SPIGOT OUTER DIAMETER (mm)	97 – 108
SOIL PIPE INNER DIAMETER (mm)	99 – 105
WEIGHT (KG)	0.35
DIMENSIONS (mm) A x B x C	43 x 200 x 70

PRODUCT CODE	MKBAR90
PAN SPIGOT OUTER DIAMETER (mm)	97 – 108
SOIL PIPE INNER DIAMETER (mm)	99 – 105
WEIGHT (KG)	0.38
DIMENSIONS (mm) A x B x C	34 x 255 x 91

PRODUCT CODE	MKRO2
PAN SPIGOT OUTER DIAMETER (mm)	97 – 108
SOIL PIPE INNER DIAMETER (mm)	99 – 105
WEIGHT (KG)	0.20
DIMENSIONS (mm) A x B x C	35 x 80 x 35

PRODUCT CODE	MKRB14
PAN SPIGOT OUTER DIAMETER (mm)	97 – 108
SOIL PIPE INNER DIAMETER (mm)	99 – 105
WEIGHT (KG)	0.20
DIMENSIONS (mm) A x B x C	40 x 105 x 40

WC CONNECTORS / MODERN

PIPE 1: Standard 99-105mm 2: Cast Iron 88-92mm 3: Old 74-77mm 4: Copper 105-108mm:

RIGID 90° BEND

MKRB90

1

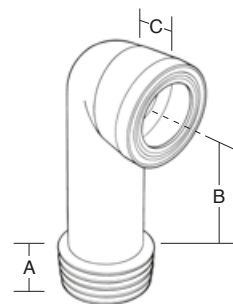

Adjustable length: remove the fined seal and cut with a fine tooth saw

RIGID STRAIGHT

MKRS2

1

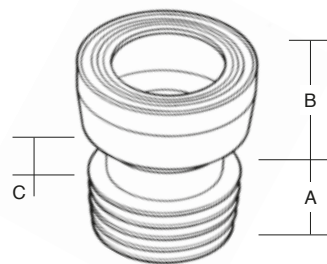

RIGID 100MM OFFSET

MKO100

1

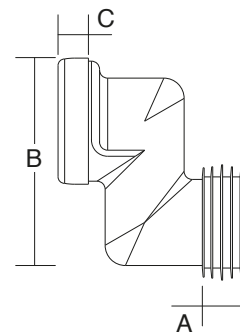

EXTENDED STRAIGHT FOR 3/2" SOIL

MKS7

2

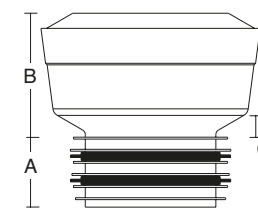

Extension length: 15mm

18MM OFFSET FOR 3/2" SOIL

MK07

2

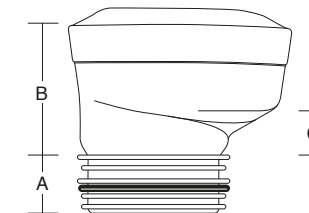

REASONS TO TRUST MULTIKWIK

SEALING FLANGES

When connecting a WC connector to the pan spigot, the sealing flanges must be pushed inside with the pipe.



Don't pull the other sealing flange out over the top of the pan spigot – it may lead to leaks.

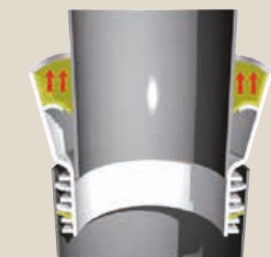

PRODUCT CODE	MKRB90
PAN SPIGOT OUTER DIAMETER (mm)	97 – 108
SOIL PIPE INNER DIAMETER (mm)	99 – 105
WEIGHT (KG)	0.33
DIMENSIONS (mm) A x B x C	37 x 210 x 50

PRODUCT CODE	MKRS2
PAN SPIGOT OUTER DIAMETER (mm)	97 – 108
SOIL PIPE INNER DIAMETER (mm)	99 – 105
WEIGHT (KG)	0.20
DIMENSIONS (mm) A x B x C	37 x 75 x 30

PRODUCT CODE	MKO100
PAN SPIGOT OUTER DIAMETER (mm)	97 – 108
SOIL PIPE INNER DIAMETER (mm)	99 – 105
WEIGHT (KG)	0.26
DIMENSIONS (mm) A x B x C	40 x 207 x 26

PRODUCT CODE	MKS7
PAN SPIGOT OUTER DIAMETER (mm)	97 – 108
SOIL PIPE INNER DIAMETER (mm)	88 – 92
WEIGHT (KG)	0.17
DIMENSIONS (mm) A x B x C	41 x 70 x 15

PRODUCT CODE	MK07
PAN SPIGOT OUTER DIAMETER (mm)	97 – 108
SOIL PIPE INNER DIAMETER (mm)	88 – 92
WEIGHT (KG)	0.15
DIMENSIONS (mm) A x B x C	34 x 77 x 30

TRUST MULTIKWIK

Our Technical team can help you with any questions you may have – just give us a call on 01622 852 695 or send us an email to info@multikwik.com. You can even tweet your question to @multikwik.

WC CONNECTORS / MODERN

18MM OFFSET
OLD BS1213 PANS TO
OVERSIZE SOIL

MK01S

4

14° BEND
FOR OVERSIZE SOIL

MKB114S

4

90° BEND
FOR OVERSIZE SOIL

MKB2190S

4

WC CONNECTORS / OLD

PIPE 1: Standard 99-105mm 2: Cast Iron 88-92mm 3: Old 74-77mm 4: Copper 105-108mm:

STRAIGHT

MKS1

1

STRAIGHT
OLD BS1213 SYPHONIC PANS

MKS1A

1

18MM OFFSET
OLD BS1213 PANS

MK01

1

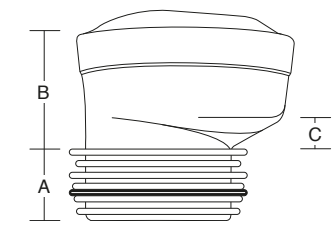
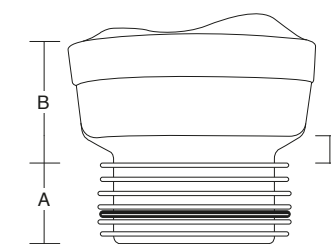
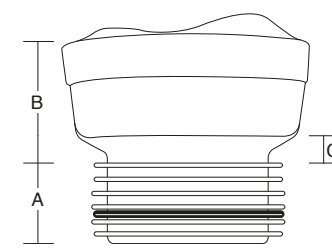
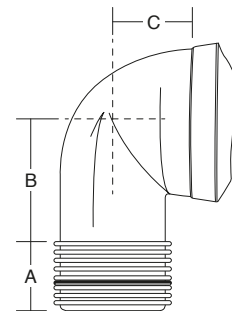
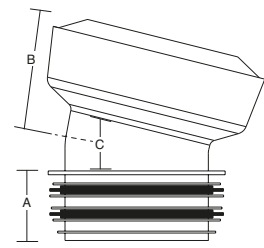
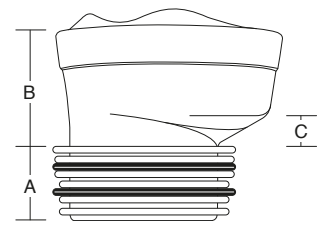

- Known as the No.1 – the plumbers favourite
- This connector is for old style pans only – for new pans use an MKS2 (see page 62)

PRODUCT CODE	MK01S
PAN SPIGOT OUTER DIAMETER (mm)	97 – 108
SOIL PIPE INNER DIAMETER (mm)	105 – 108
WEIGHT (KG)	0.18
DIMENSIONS (mm) A x B x C	45 x 76 x 20

PRODUCT CODE	MKB114S
PAN SPIGOT OUTER DIAMETER (mm)	97 – 108
SOIL PIPE INNER DIAMETER (mm)	105 – 108
WEIGHT (KG)	0.20
DIMENSIONS (mm) A x B x C	43 x 80 x 35

PRODUCT CODE	MKB2190S
PAN SPIGOT OUTER DIAMETER (mm)	97 – 108
SOIL PIPE INNER DIAMETER (mm)	105 – 108
WEIGHT (KG)	0.32
DIMENSIONS (mm) A x B x C	60 x 115 x 80

PRODUCT CODE	MKS1
PAN SPIGOT OUTER DIAMETER (mm)	108 – 114
SOIL PIPE INNER DIAMETER (mm)	99 – 105
WEIGHT (KG)	0.16
DIMENSIONS (mm) A x B x C	44 x 67 x 15

PRODUCT CODE	MKS1A
PAN SPIGOT OUTER DIAMETER (mm)	108 – 114
SOIL PIPE INNER DIAMETER (mm)	99 – 105
WEIGHT (KG)	0.17
DIMENSIONS (mm) A x B x C	40 x 70 x 15

PRODUCT CODE	MK01
PAN SPIGOT OUTER DIAMETER (mm)	108 – 114
SOIL PIPE INNER DIAMETER (mm)	99 – 105
WEIGHT (KG)	0.17
DIMENSIONS (mm) A x B x C	45 x 70 x 25

WC CONNECTORS / OLD

PIPE 1: Standard 99-105mm 2: Cast Iron 88-92mm 3: Old 74-77mm 4: Copper 105-108mm:

90° TIGHT
KNUCKLE BEND
OLD BS1213 PANS

MKB21

1

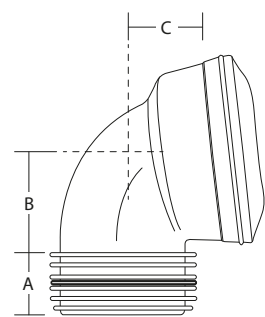

PRODUCT CODE	MKB21
PAN SPIGOT OUTER DIAMETER (mm)	108 – 114
SOIL PIPE INNER DIAMETER (mm)	99 – 105
WEIGHT (KG)	0.24
DIMENSIONS (mm) A x B x C	45 x 80 x 80

90° TIGHT
KNUCKLE BEND
OLD BS1213 PANS

MKB22

1

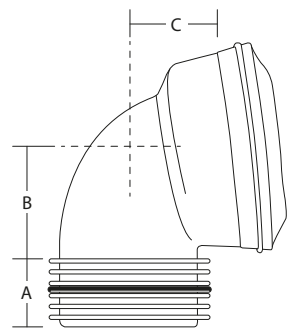

PRODUCT CODE	MKB22
PAN SPIGOT OUTER DIAMETER (mm)	108 – 114
SOIL PIPE INNER DIAMETER (mm)	99 – 105
WEIGHT (KG)	0.24
DIMENSIONS (mm) A x B x C	45 x 80 x 75

STRAIGHT
3½" SOIL

MKS3

2

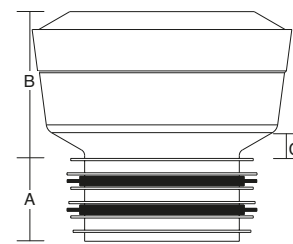

PRODUCT CODE	MKS3
PAN SPIGOT OUTER DIAMETER (mm)	108 – 114
SOIL PIPE INNER DIAMETER (mm)	88 – 92
WEIGHT (KG)	0.16
DIMENSIONS (mm) A x B x C	41 x 70 x 10

18MM OFFSET
OLD BS1213 PANS TO 3½" SOIL

MK03

2

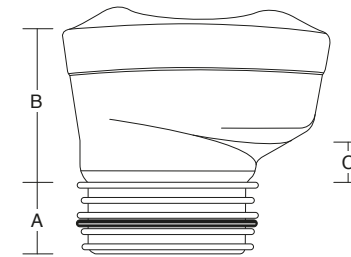

PRODUCT CODE	MK03
PAN SPIGOT OUTER DIAMETER (mm)	108 – 114
SOIL PIPE INNER DIAMETER (mm)	88 – 92
WEIGHT (KG)	0.15
DIMENSIONS (mm) A x B x C	37 x 78 x 30

STRAIGHT
3" SOIL

MKS10

3

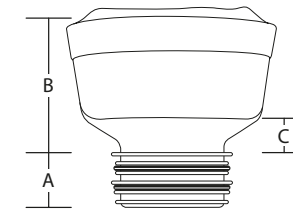

PRODUCT CODE	MKS10
PAN SPIGOT OUTER DIAMETER (mm)	108 – 114
SOIL PIPE INNER DIAMETER (mm)	74 – 77
WEIGHT (KG)	0.16
DIMENSIONS (mm) A x B x C	35 x 86 x 12

90° TIGHT
KNUCKLE BEND
OLD BS1213 PANS TO OVERSIZE SOIL

MKB21S

4

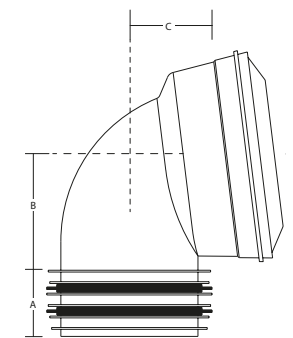

PRODUCT CODE	MKB21S
PAN SPIGOT OUTER DIAMETER (mm)	108 – 114
SOIL PIPE INNER DIAMETER (mm)	105 – 108
WEIGHT (KG)	0.25
DIMENSIONS (mm) A x B x C	45 x 75 x 60

WC CONNECTORS / STAINLESS STEEL

PIPE 1: Standard 99-105mm 2: Cast Iron 88-92mm 3: Old 74-77mm 4: Copper 105-108mm:

STRAIGHT
UNDERSIZE SPIGOTS

MKS5 1

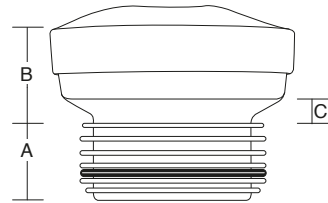

EXTENDED STRAIGHT
UNDERSIZE SPIGOTS

MKS8 1

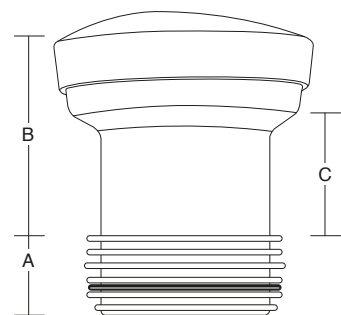

■ Extension length: 59mm

18MM OFFSET
UNDERSIZE SPIGOTS

MK05 1

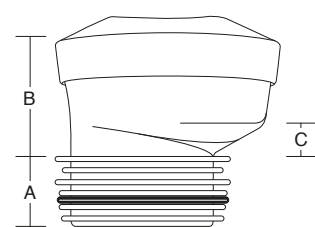

14° BEND
UNDERSIZE SPIGOTS

MKB514 1

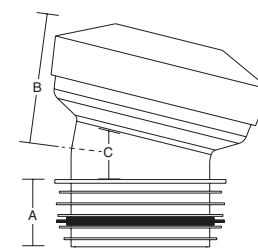

14° BEND
UNDERSIZE SPIGOTS TO 3½" SOIL

MKB614 2

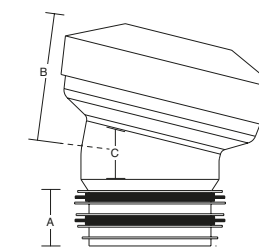

PRODUCT CODE	MKS5
PAN SPIGOT OUTER DIAMETER (mm)	76 – 95
SOIL PIPE INNER DIAMETER (mm)	99 – 105
WEIGHT (KG)	0.22
DIMENSIONS (mm) A x B x C	45 x 55 x 15

PRODUCT CODE	MKS8
PAN SPIGOT OUTER DIAMETER (mm)	76 – 95
SOIL PIPE INNER DIAMETER (mm)	99 – 105
WEIGHT (KG)	0.26
DIMENSIONS (mm) A x B x C	42 x 110 x 70

PRODUCT CODE	MK05
PAN SPIGOT OUTER DIAMETER (mm)	76 – 95
SOIL PIPE INNER DIAMETER (mm)	99 – 105
WEIGHT (KG)	0.24
DIMENSIONS (mm) A x B x C	45 x 72 x 22

PRODUCT CODE	MKB514
PAN SPIGOT OUTER DIAMETER (mm)	76 – 95
SOIL PIPE INNER DIAMETER (mm)	99 – 105
WEIGHT (KG)	0.26
DIMENSIONS (mm) A x B x C	42 x 85 x 40

PRODUCT CODE	MKB614
PAN SPIGOT OUTER DIAMETER (mm)	76 – 95
SOIL PIPE INNER DIAMETER (mm)	88 – 92
WEIGHT (KG)	0.25
DIMENSIONS (mm) A x B x C	37 x 90 x 40

REASONS TO TRUST MULTIKWIK

Need an offset?

Measure from the centre line of your pipe to the centre line of your pan spigot.

Remember, offsets should not be installed in an upwards position. Water should be able to run horizontally or down.



TRUST MULTIKWIK

All Multikwik WC connectors are supplied with a sachet of lubricant to ease the installation – with the exception of our adjustable and rigid connectors.



WC CONNECTORS / ANCILLARIES

PIPE 1: Standard 99-105mm 2: Cast Iron 88-92mm 3: Old 74-77mm 4: Copper 105-108mm:

SOIL PIPE EXTENSION FOR 4" SOIL

MKEA 1

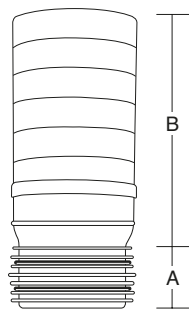

- Can be cut to required length
- Ideal when removing 4" cast iron, clay and PVCu

PRODUCT CODE	MKEA
SOIL PIPE INNER DIAMETER (mm)	99 – 105
WEIGHT (KG)	0.24
DIMENSIONS (mm) A x B	50 x 202

SOIL PIPE EXTENSION FOR 3½" SOIL

MKEB 2

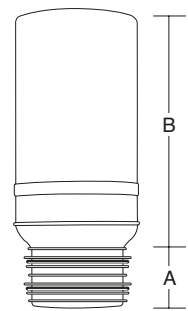

- Can be cut to required length
- Ideal when removing 3½" cast iron

PRODUCT CODE	MKEB
SOIL PIPE INNER DIAMETER (mm)	88 – 92
WEIGHT (KG)	0.22
DIMENSIONS (mm) A x B	50 x 202

SOIL PIPE EXTENSION FOR 3" SOIL

MKEG 3

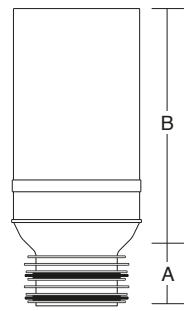

- Can be cut to required length
- Ideal when removing 3" cast iron

PRODUCT CODE	MKEG
SOIL PIPE INNER DIAMETER (mm)	74 – 77
WEIGHT (KG)	0.21
DIMENSIONS (mm) A x B	42 x 210

RIGID SOIL PIPE EXTENSION

MKREXT 1

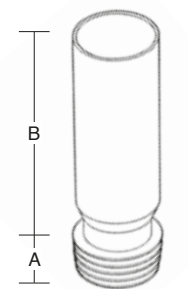

- Adjustable length: remove the fined seal and cut with a fine tooth saw

PRODUCT CODE	MKREXT
PAN SPIGOT OUTER DIAMETER (mm)	97 – 108
SOIL PIPE INNER DIAMETER (mm)	99 – 105
WEIGHT (KG)	0.23
DIMENSIONS (mm) A x B	35 x 264

FLUSH PIPE CONNECTOR

MKFPC1 1

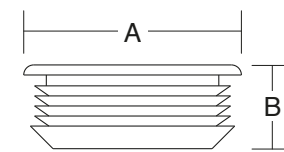

PRODUCT CODE	MKFPC1
SOIL PIPE INNER DIAMETER (mm)	–
WEIGHT (KG)	0.02
DIMENSIONS (mm) A x B	65 x 26

MULTILINK

MKL1 1

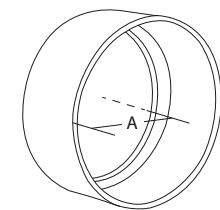

- For connecting 2 or more pan connectors
- Suitable for sleeving the fins of all 99 – 105mm Multikwik outlets

PRODUCT CODE	MKL1
SOIL PIPE INNER DIAMETER (mm)	99 – 105
WEIGHT (KG)	0.04
DIMENSIONS (mm) A	52.5



FLOOR DRAINAGE

ENDURANCE YOU CAN **TRUST**

Multikwik floor drainage solutions give you the support that you need to succeed on a tough job.

There is a solution for commercial high flow rate applications, domestic unobtrusive shower drainage, tiled and vinyl flooring.

Trust Multikwik to give you a choice of floor drainage applications.

Multikwik Linum linear drainage

Linum offers a high specification linear channel, ideal for wet rooms and shower applications. Available in 3 lengths with an integrated trap, the base unit is compact in width to allow for close to wall installation. The Linum range includes a wide range of high specification covers and grids and can achieve a flow rate of 0.8 l/s.

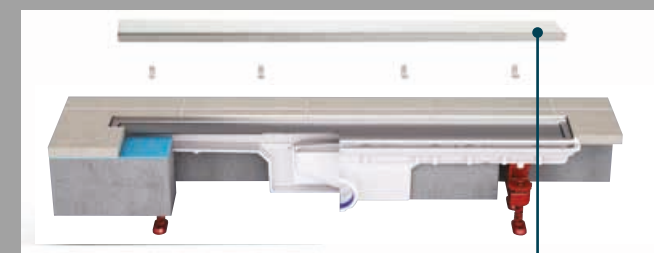
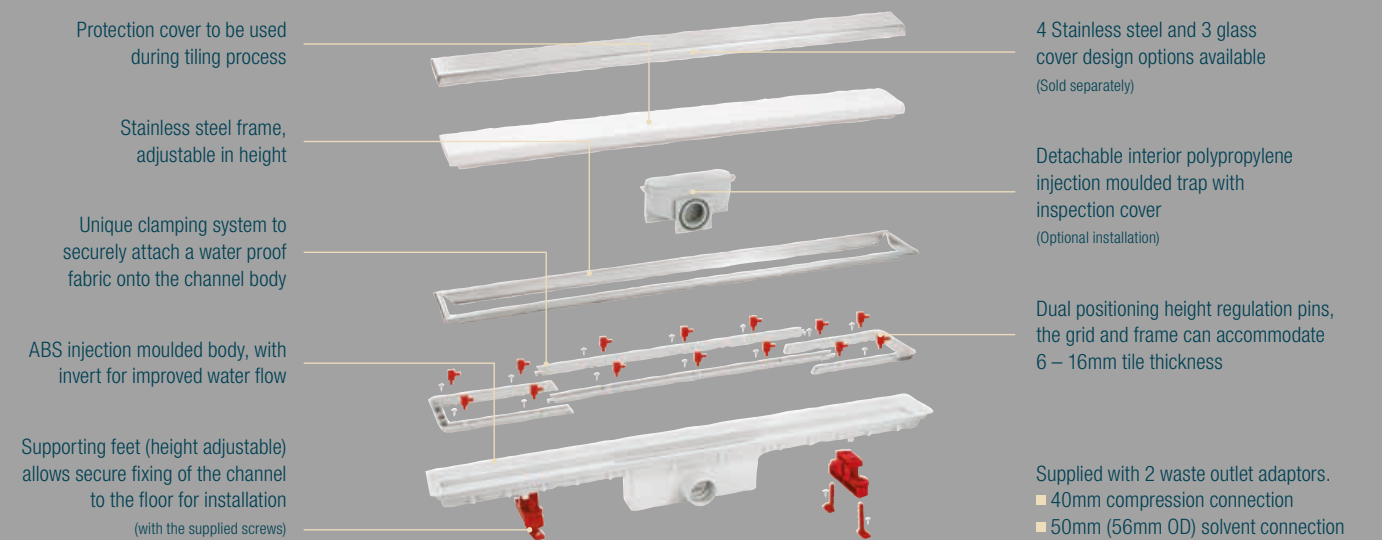

One side of the channel provides a smooth finish. Turn the channel over 180° to obtain a 'fill-in' frame – 2 design options from 1 product.



The perfect finish

Thanks to the innovative design, Linum allows for a perfect finish to be achieved with tiles, marble or other types of non-flexible floor covering. The reversible cover system allows for a smooth top finish or a 'fill-in' finish using the same materials (i.e. tiles) as for the rest of the floor, achieving an unobtrusive effect. The soft grid range is supplied with spacer pins to allow water to drain away.

A wide choice of styles

Choose from the stainless steel grids or the eye catching glass covers in soft white and kohl black.

Multikwik Trapped Shower Gullies

Multikwik has developed a range of compact and adaptable trapped shower gullies for vinyl sheeting and tiled floors that are quick and easy to fit, really versatile, with high performance and great looks when installed. Ideal for care homes, hospitals, leisure facilities, apartment blocks, hotels or private housing.

Versatile

The range offers various options to meet installation needs, with horizontal and vertical outlets, 50mm or 75mm water seal depth, as well as a 50mm to 40mm size adaptor and different height options for the vertical shower gully.

Flow rates

The shower gullies are ideal for commercial applications or domestic power showers with flow rates of up to 1.05 l/s.

Aesthetics

Different grate options are available for both the tiled and vinyl shower gullies, matching any bathroom style.

The dual grate for tiled flooring can also be flipped 180° and filled in with tiles for a truly unobtrusive result.



PROBLEM SOLVED

Vertical shower gully with stainless steel or ABS anti-slip

SG50SW | SG50WV

- Unique locking ring feature prevents unintended access, but allows easy access for maintenance
- Stainless steel or ABS anti-slip lid
- Compact size – saving valuable room when space is at a premium



PROBLEM SOLVED

Linum channel shower drainage with decorative floor grate

Shower body and grate available in various sizes and designs

- Compact, close to wall installation with adjustable overall height and frame height
- Unobtrusive design
- High flow rates



PROBLEM SOLVED

Horizontal shower gully body with dual grate & riser set

SG50HT plus SG1T

- Mix and match: find suitable shower gully body to match grate design of choice
- Dual grate: Two-in-one by flipping 180° with a choice of smooth stainless steel or tiled fill-in-finish
- Riser can be cut in height to suit different tile and floor thicknesses.

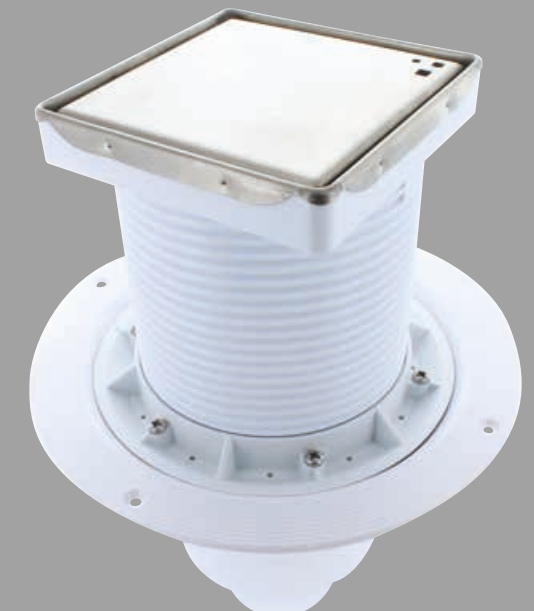

FLOOR DRAINAGE / LINNUM FLOOR DRAINAGE

SHOWER
DRAIN BODY

L13560 | L13570 | L13590

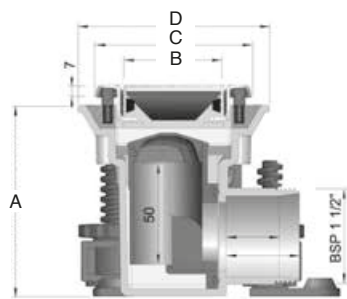

■ Min. height: 115mm; Max. height: 131mm

PRODUCT CODE	L13560	L13570	L13590
SIZE (mm)	650	750	950
COLOUR	Stainless Steel	Stainless Steel	Stainless Steel
WATER SEAL DEPTH (mm)	50	50	50
FLOOR TYPE	Tiled	Tiled	Tiled
WEIGHT (KG)	1.89	2.19	2.77
DIMENSIONS (mm) A x B x C x D	95 x 50 x 71 x 95.5	95 x 50 x 71 x 95.5	95 x 50 x 71 x 95.5

GLASS
FLOOR GRATE

L13563 | L13564

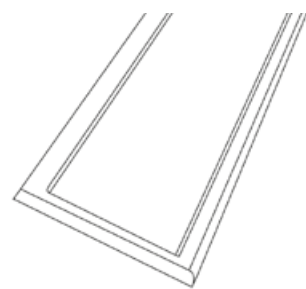
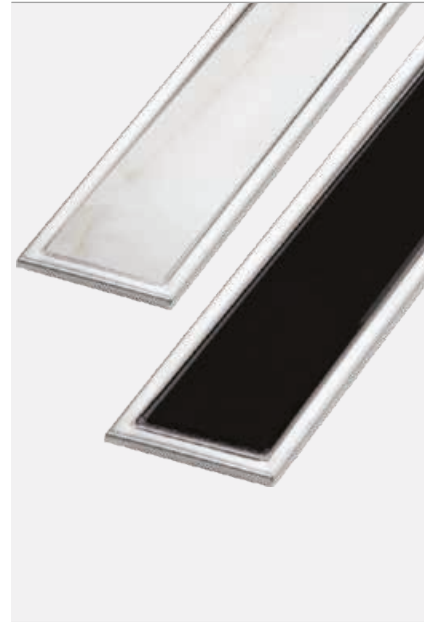

PRODUCT CODE	L13564	L13563
SIZE (mm)	650 x 50	650 x 50
COLOUR	White	Black
FLOOR TYPE	Tiled	Tiled
WEIGHT (KG)	0.53	0.53

SOFT
FLOOR GRATE

L13565 | L13575 | L13595

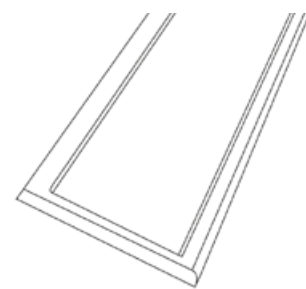

PRODUCT CODE	L13565	L13575	L13595
SIZE (mm)	650 x 50	750 x 50	950 x 50
COLOUR	Stainless Steel	Stainless Steel	Stainless Steel
FLOOR TYPE	Tiled	Tiled	Tiled
WEIGHT (KG)	0.52	0.61	0.76

ELEGANCE
FLOOR GRATE

L13566 | L13576 | L13596

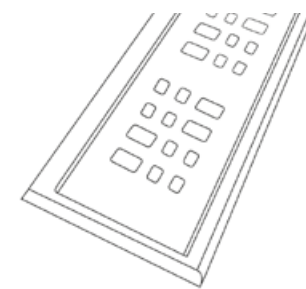
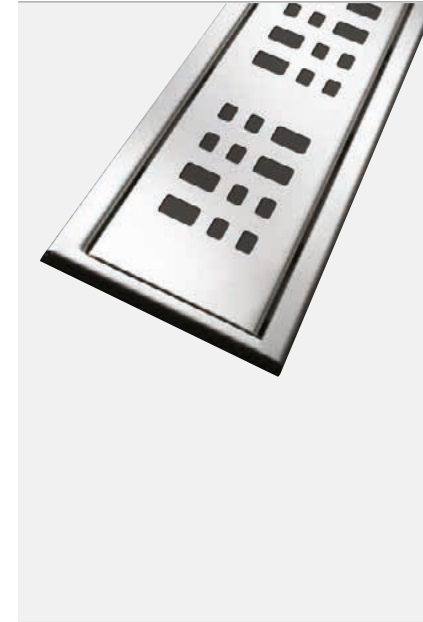

PRODUCT CODE	L13566	L13576	L13596
SIZE (mm)	650 x 50	750 x 50	950 x 50
COLOUR	Stainless Steel	Stainless Steel	Stainless Steel
FLOOR TYPE	Tiled	Tiled	Tiled
WEIGHT (KG)	0.51	0.60	0.75

SQUARE
FLOOR GRATE

L13567 | L13577 | L13597

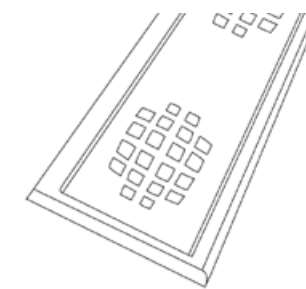
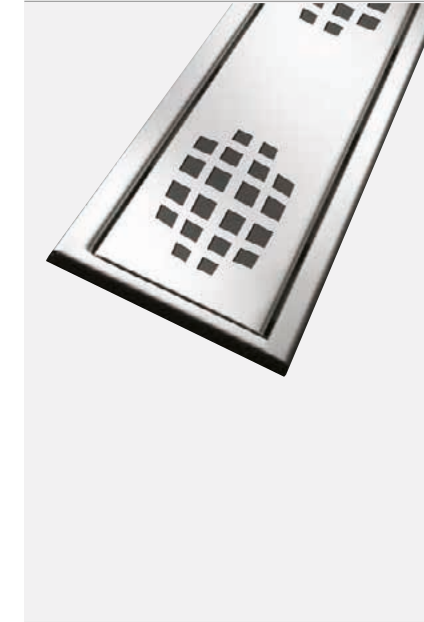

PRODUCT CODE	L13567	L13577	L13597
SIZE (mm)	650 x 50	750 x 50	950 x 50
COLOUR	Stainless Steel	Stainless Steel	Stainless Steel
FLOOR TYPE	Tiled	Tiled	Tiled
WEIGHT (KG)	0.51	0.60	0.75

BUBBLE
FLOOR GRATE

L13569 | L13579 | L13599

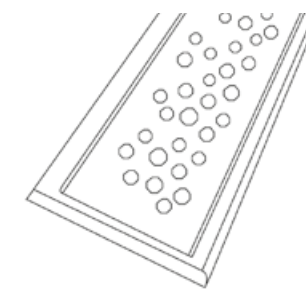

PRODUCT CODE	L13569	L13579	L13599
SIZE (mm)	650 x 50	750 x 50	950 x 50
COLOUR	Stainless Steel	Stainless Steel	Stainless Steel
FLOOR TYPE	Tiled	Tiled	Tiled
WEIGHT (KG)	0.51	0.60	0.75

FLOOR DRAINAGE / LINNUM DRAINAGE

CHANNEL SUPPORT SET – SPARE

TRL426

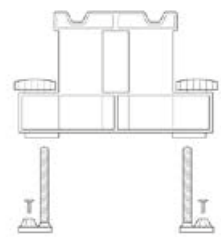

- Single

PRODUCT CODE	TRL426
COLOUR	Red
FLOOR TYPE	Tiled

SHOWER GRID FRAME – SPARE

TRL428 | TRL429 | TRL430



- Stainless steel

PRODUCT CODE	TRL428	TRL429	TRL430
SIZE (mm)	650	750	950
COLOUR	Stainless Steel	Stainless Steel	Stainless Steel
FLOOR TYPE	Tiled	Tiled	Tiled

SHOWER CLAMPING FRAME – SPARE

TRL434 | TRL435 | TRL436



- Plastic
- For use with floor thickness spacer (TRL 478)

PRODUCT CODE	TRL434	TRL435	TRL436
SIZE (mm)	650	750	950
COLOUR	Stainless Steel	Stainless Steel	Stainless Steel
FLOOR TYPE	Tiled	Tiled	Tiled

FLOOR THICKNESS SPACER SET – SPARE

TRL478

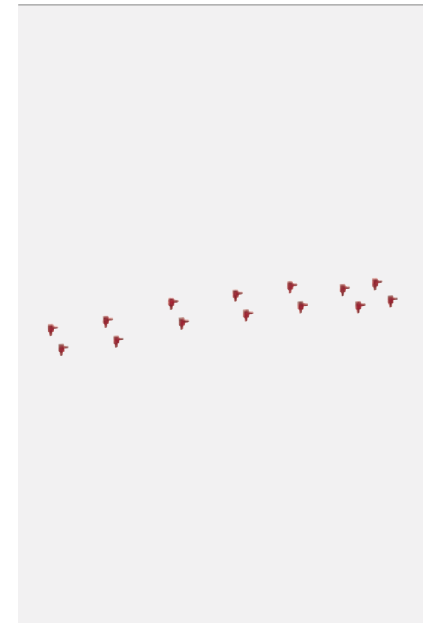

- For use with Linum shower clamping
- Pack of 12
- Accommodates three different heights

PRODUCT CODE	TRL478
COLOUR	Red
FLOOR TYPE	Tiled

REASONS TO TRUST MULTIKWIK

Adjustable feet

- Rotatable legs – allows close to wall installation. Moves drainage point to the back of the wall
- Precise height setting by hand adjustment
- Secure installation through clip, for fixing leg height

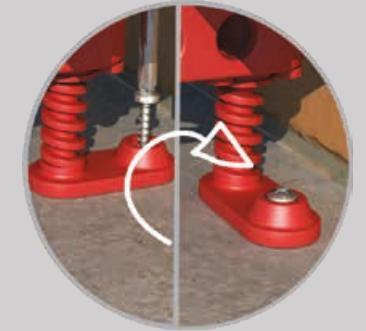

Compact size

- Compact base unit width enables close to wall installations
- Low minimum height of 95mm with height adjustability to perfectly fit installation requirements
- Length options available for different applications for discrete bathroom finish



TRUST MULTIKWIK

Linum offers different glass and stainless steel grates. The Soft floor grate is a two-in-one product: a smooth stainless steel finish or if flipped 180° it can be filled with tiles to match the surrounding tiled floor



Linum linear channel drainage

FLOOR DRAINAGE / TRAPPED SHOWER GULLY – VINYL APPLICATION

HORIZONTAL SHOWER GULLY

SG50SHV | SG75SHV

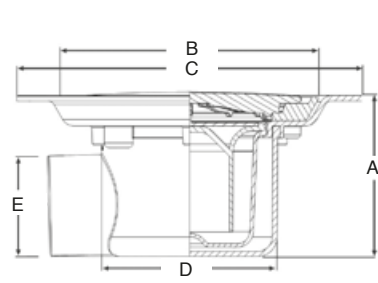

VERTICAL SHOWER GULLY

SG50SVV | SG75SVV

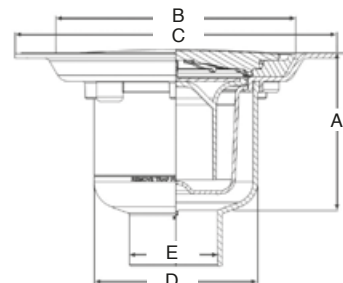

HORIZONTAL SHOWER GULLY – ABS

SG50WHV | SG75WHV

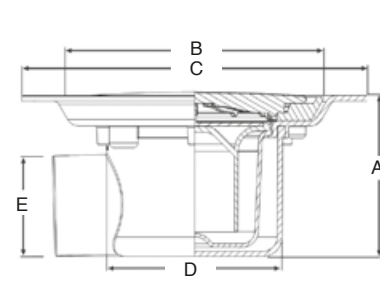

VERTICAL SHOWER GULLY – ABS

SG50WVV | SG75WVV

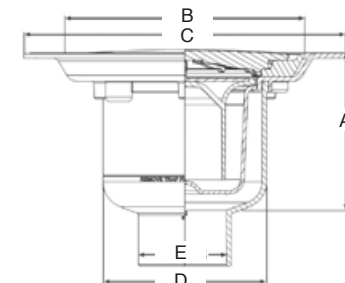

PRODUCT CODE	SG50SHV	SG75SHV
COLOUR	Stainless Steel	Stainless Steel
WATER SEAL DEPTH (mm)	50	75
FLOOR TYPE	Vinyl	Vinyl
WEIGHT (KG)	0.90	1.10
DIMENSIONS (mm) A x B x C x D x E	100 x 161 x 216 x 110 x 55	125 x 101 x 216 x 110 x 55

PRODUCT CODE	SG50SVV	SG75SVV
COLOUR	Stainless Steel	Stainless Steel
WATER SEAL DEPTH (mm)	50	75
FLOOR TYPE	Vinyl	Vinyl
WEIGHT (KG)	0.90	1.10
DIMENSIONS (mm) A x B x C x D x E	110 x 161 x 216 x 110 x 55	134 x 161 x 216 x 110 x 55

PRODUCT CODE	SG50WHV	SG75WHV
COLOUR	White	White
WATER SEAL DEPTH (mm)	50	75
FLOOR TYPE	Vinyl	Vinyl
WEIGHT (KG)	0.90	1.10
DIMENSIONS (mm) A x B x C x D x E	100 x 161 x 216 x 110 x 55	125 x 161 x 216 x 110 x 55

PRODUCT CODE	SG50WVV	SG75WVV
COLOUR	White	White
WATER SEAL DEPTH (mm)	50	75
FLOOR TYPE	Vinyl	Vinyl
WEIGHT (KG)	0.90	1.10
DIMENSIONS (mm) A x B x C x D x E	110 x 161 x 216 x 110 x 55	134 x 161 x 216 x 110 x 55

REASONS TO TRUST MULTIKWIK

Trapped shower gullies for vinyl or tiled flooring

Whether the shower gully is required for vinyl or tiled flooring, Multikwik has a product available for either.

Vinyl

A ready assembled gully with a stainless steel or anti-slip ABS lid, seal depth of 50mm or 75mm and a choice between a horizontal or vertical outlet

Trapped Shower Gully vinyl

- Sheet flooring 1
- Concrete floor 2

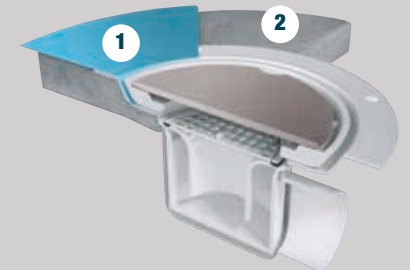

Tile

Horizontal or vertical and 50mm or 75mm water seal depths gully bodies can be combined with one of four grate options – both are sold separately for maximum design flexibility.



Trapped Shower gully tiled

- 1 Floor tiles
- 2 Waterproof tile adhesive
- 3 Waterproofing membrane
- 4 Concrete floor

TRUST MULTIKWIK

Trapped shower gullies for vinyl flooring are usually installed in commercial applications. For more security our vinyl shower gullies have a unique and secure locking ring system – preventing theft and vandalism.



FLOOR DRAINAGE / TRAPPED SHOWER GULLY – TILED APPLICATION

DUAL GRATE & RISER

SG1T

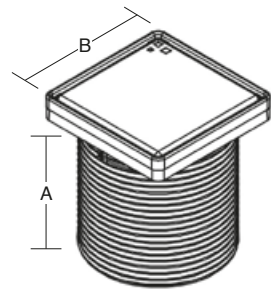

- Riser can be cut between 36.5 – 130mm
- Requires shower gully body

SQUARE GRATE & RISER

SG2T

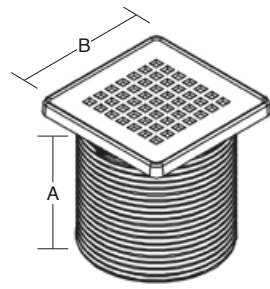

- Riser can be cut between 36.5 – 130mm
- Requires shower gully body

CLASSIC GRATE & RISER

SG3T

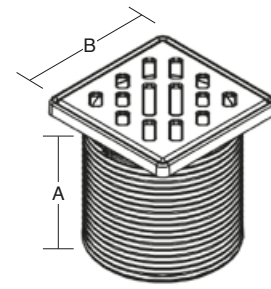

- Riser can be cut between 36.5 – 130mm
- Requires shower gully body

CLASSIC VANDAL RESISTANT GRATE & RISER

SG4T

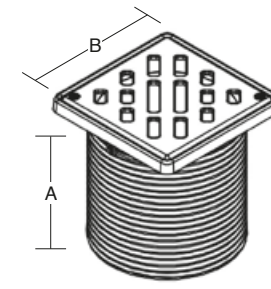

- Riser can be cut between 36.5 – 130mm
- Requires shower gully body
- Screwed anti-vandal grate

VERTICAL SHOWER GULLY BODY

SG50VT | SG75VT

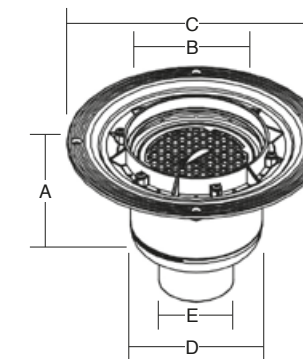

- Requires 'Grate & Riser' set

HORIZONTAL SHOWER GULLY BODY

SG50HT | SG75HT

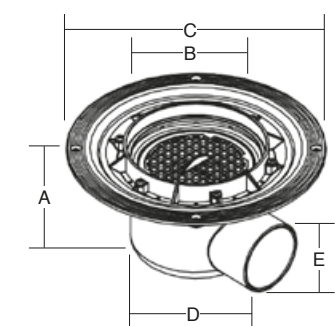

- Requires 'Grate & Riser' set

PRODUCT CODE	SG1T
COLOUR	Stainless Steel
FLOOR TYPE	Tiled
WEIGHT (KG)	0.38
DIMENSIONS (mm) A x B	130 x 120

PRODUCT CODE	SG2T
COLOUR	Stainless Steel
FLOOR TYPE	Tiled
WEIGHT (KG)	0.41
DIMENSIONS (mm) A x B	121 x 121

PRODUCT CODE	SG3T
COLOUR	Stainless Steel
FLOOR TYPE	Tiled
WEIGHT (KG)	0.31
DIMENSIONS (mm) A x B	121 x 121

PRODUCT CODE	SG4T
COLOUR	Stainless Steel
FLOOR TYPE	Tiled
WEIGHT (KG)	0.31
DIMENSIONS (mm) A x B	121 x 121

PRODUCT CODE	SG50VT	SG75VT
COLOUR	White	White
WATER SEAL DEPTH (mm)	50	75
FLOOR TYPE	Tiled	Tiled
WEIGHT (KG)	0.52	0.72
DIMENSIONS (mm) A x B x C x D x E	110 x 120 x 216 x 110 x 55	134 x 120 x 216 x 110 x 55

PRODUCT CODE	SG50HT	SG75HT
COLOUR	White	White
WATER SEAL DEPTH (mm)	50	75
FLOOR TYPE	Tiled	Tiled
WEIGHT (KG)	0.47	0.67
DIMENSIONS (mm) A x B x C x D x E	100 x 120 x 216 x 110 x 55	125 x 120 x 216 x 110 x 55

FLOOR DRAINAGE / CONTINUOUS CHANNEL

END CAP Ø40MM
HORIZONTAL OUTLET

L29036

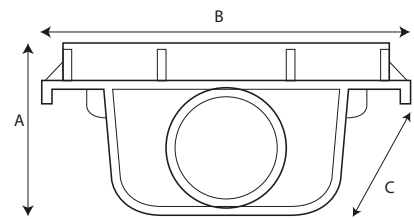

PRODUCT CODE	L29036
SIZE (mm)	40
COLOUR	Grey
FLOOR TYPE	Tiled
DIMENSIONS (mm) A x B x C	45 x 130 x 64

CONTINUOUS CHANNEL

L29142

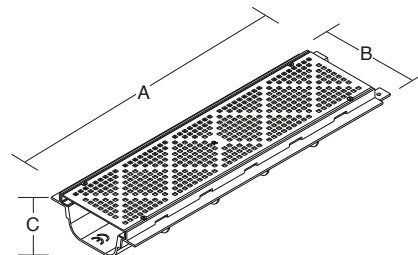

PRODUCT CODE	L29142
SIZE (mm)	40
COLOUR	Stainless Steel
FLOOR TYPE	Tiled
WEIGHT (KG)	1.61
DIMENSIONS (mm) A x B x C	500 x 130 x 64

CONTINUOUS CHANNEL
– WITH OUTLET

L29143

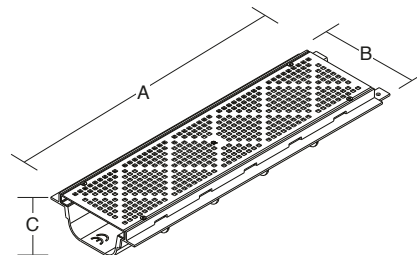

PRODUCT CODE	L29143
SIZE (mm)	50
COLOUR	Stainless Steel
FLOOR TYPE	Tiled
WEIGHT (KG)	1.73
DIMENSIONS (mm) A x B x C	500 x 130 x 64

CONTINUOUS CHANNEL
– WITH MULTI OUTLET

L29158

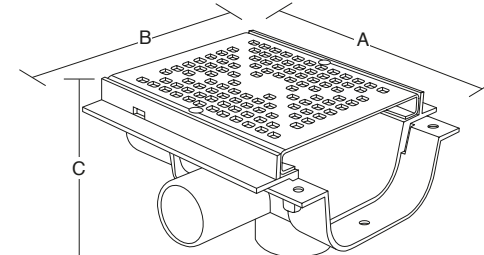

PRODUCT CODE	L29158
SIZE (mm)	40/50
COLOUR	Stainless Steel
FLOOR TYPE	Tiled
WEIGHT (KG)	0.57
DIMENSIONS (mm) A x B x C	150 x 130 x 64

OUTLET ADAPTOR
LINNUM

TRL487 | TRL490



■ To BS EN 1566/5255 solvent waste

PRODUCT CODE	TRL487	TRL490
SIZE (mm)	Ø40 Compression	Ø50 Solvent
COLOUR	Grey	Grey

OUTLET ADAPTOR
CONT CHANNEL

TRL488 | TRL489



■ To BSEN 1566/5255 solvent waste

PRODUCT CODE	TRL488	TRL489
SIZE (mm)	Ø50 Solvent	Ø40 Solvent
COLOUR	Grey	Grey

CUSTOMER INFORMATION

PRICING

For pricing details please refer to the Multikwik Price List.

CE Marking

For the latest copies of the declaration of performance certificates please go to our website: multikwik.com

Product photography

Photographs are for representation only and may vary to the actual product. Colours are a guide only.

Quality

Quality is one of our core principles:

- Products are made with care under an ISO9001 & ISO14001 certified system.
 - Multikwik hold many 3rd party approvals. Where appropriate, there are detailed in the product listing.
 - As part of our on going quality improvement processes we reserve the right to alter our products and ranges without notice.
-

