



# INSPIRATIONS FURNITURE

**William Wilson**  
BATHROOM SHOWROOMS



# INSPIRATIONS

Three beautifully themed ranges to complement all styles in a multitude of sizes and options to suit any bathroom, en-suite or cloakroom.

Individually and imaginatively presented, these ranges unlock the creative potential of each and every bathroom.

## **Fitted Range**

A selection of fully fitted options in standard and reduced depth, available in a range of stunning finishes.

Range Introduction	4-5
Source	6-15
Eden	16-17
Prism	18-21
How to order	22-23
Codes and Prices	24-33

## **Modular Range**

A collection of washbasin and toilet units offering contemporary wall mounted and freestanding solutions.

Range Introduction	34-35
Source	36-43
Codes and Prices	44-45

## **Classic Range**

A beautiful range of traditionally inspired freestanding furniture.

Range Introduction	46-47
Vintage	48-53
Codes and Prices	54-55

## **Features and Benefits**

56-57

## **Terms and Conditions**

58



Proudly designed and  
manufactured in Britain



# FITTED RANGE

Select from a choice of doorstyles and door finishes to suit every home interior, from clean contemporary to country cottage.



Source

A simple yet stylish MFC slab door, the Source doorstyle with its crisp edge profile offers a clean modern look.

Eden

Eden features a pressed Shaker profile, adding a touch of elegance to any bathroom furniture. Back of the door will be white.

Prism

An uber stylish door featuring the new on trend 3D edging giving a slab door a super contemporary feel. Reverse side of this has a matt finish.

## Door Colours for Source

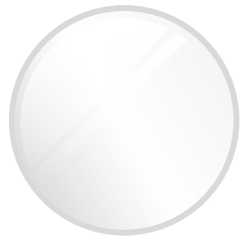

White Gloss



Grey Gloss



Cashmere



Natural Oak



Drift

## Door Colour for Eden

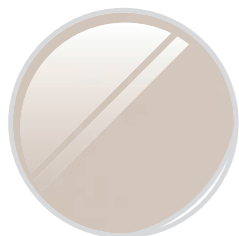

Cashmere Gloss

## Door Colours for Prism

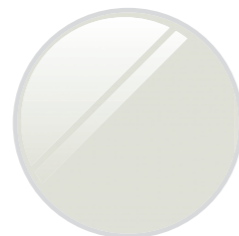

Silver Grey Gloss



Charcoal Grey Gloss

## Laminate Worktop Colours

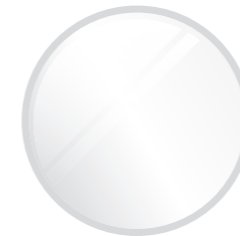

White Gloss



Cashmere

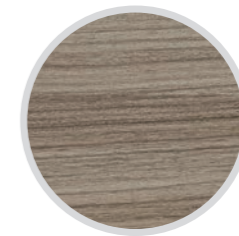

Drift



Natural Oak

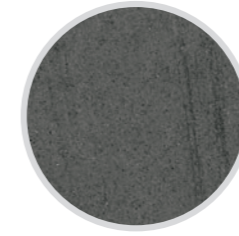

Grey Strata

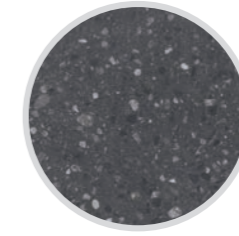

Basalt Grey

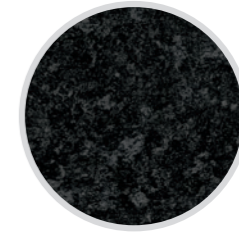

Black Granite Gloss

## Unit Overview

All unit carcasses are in Cashmere with the exceptions marked below which are colour matched to the fascia (\*)

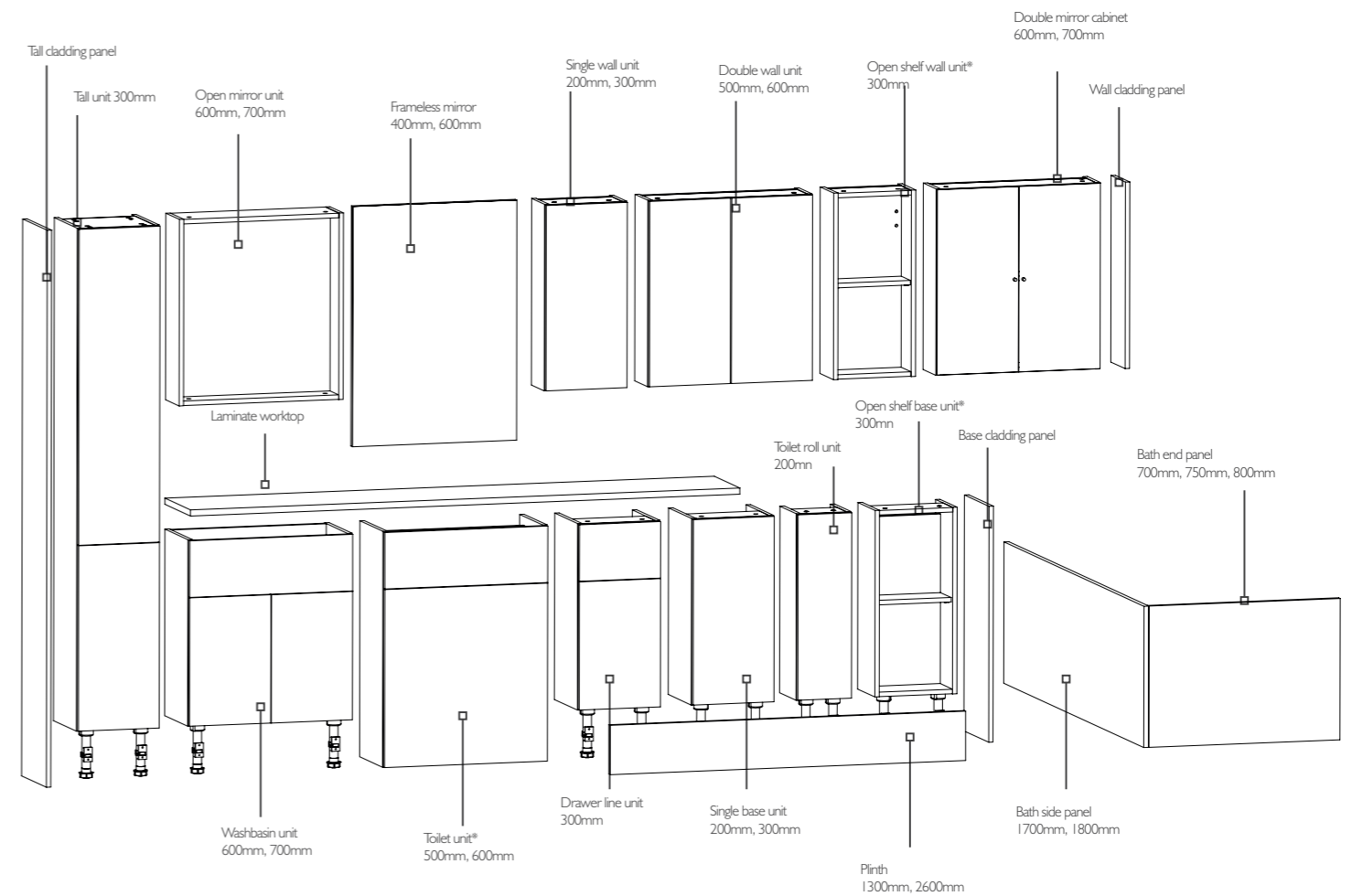

+

# SOURCE

WHITE GLOSS

The stunning White Gloss finish stands out against the dramatic wall colour, adding a fresh feel to any bathroom.

Shown here: Washbasin unit (wall mounted using a base wall hanging kit), mirror cabinet, toilet unit, toilet roll unit, plinth, cladding panels, Grey Strata laminate worktop and Chrome bar handle.

+





+  
**SOURCE**  
CASHMERE

There's a stylish feel to Cashmere with its light neutral tones and soft matt finish. The reduced depth furniture and short projection basin are the perfect solution for a small bathroom with added storage.

Shown here: Washbasin unit, toilet roll unit, toilet unit, mirror cabinet, open shelf wall unit, open mirror unit, cladding panels, plinth, Black Granite Gloss laminate worktop and Chrome Arc handle.

+

+

# SOURCE

GREY GLOSS

Teaming fitted and modular furniture together gives you the best of both worlds, the illusion of a larger room with more floor space and extra storage using fitted furniture.

Shown here: Toilet roll unit, toilet unit, wall open shelf unit, double wall unit, modular wall mounted washbasin unit, modular mirror cabinet, cladding panels, plinth, White Gloss laminate worktop and Brushed Pull handle.

+



+

# SOURCE

NATURAL OAK

+

This simple combination of fitted furniture shown as a freestanding solution suits this small cloakroom space perfectly adding the extra element of storage.

Shown here: Reduced depth washbasin unit, frameless mirror, toilet unit, cladding panels, plinth, Natural Oak laminate worktop and Chrome Round bar handle.



+

# SOURCE

## DRIFT

The striking pattern of Drift is a feature in itself and looks particularly eye catching against a neutral background.

Shown here: Tall unit, washbasin unit, toilet unit, frameless mirror, bath side and end panel, cladding panels, plinth, White Gloss laminate worktop and Chrome Pull handle.

+





+

# EDEN

## CASHMERE GLOSS

Cashmere Gloss combined with Drift adds a touch of luxury to this bathroom. Create extra storage for the whole bathroom by adding wall cabinets.

Shown here: Bath side panel, toilet unit, washbasin unit, drawer line unit, mirror cabinet, single wall unit, cladding panels, plinth, Drift laminate worktop and Chrome Crescent handle.

+



+

# PRISM

SILVER GREY GLOSS

This spacious family bathroom with large window makes the room feel light and airy, teamed with Silver Grey Gloss finish and the striking Basalt Grey laminate worktop. Giving this room style without losing any functionality.

Shown here: Washbasin unit, toilet unit, open mirror unit, double wall unit, cladding panels, plinth, Basalt Grey laminate worktop and Chrome Rectangular handle.

+



+

# PRISM

CHARCOAL GREY GLOSS

A stylish new doorstyle and on-trend finish. Fitted furniture works for whatever awkward size bathroom you have to work in, as seen here fitted around a large window.

Shown here: Bath side and end panel, toilet roll unit, toilet unit, single base units, washbasin units, base open shelf unit, mirror cabinets, wall open shelf unit, cladding panels, plinth, Grey Strata laminate worktop and Chrome Bar handle.

+



# FITTED RANGE - HOW TO ORDER

1. Choose your doorstyle
2. Choose your door finish
3. Choose your worktop
4. Don't forget to select and order your handles
5. Select your units required, these are ordered as fascia packs and carcasses as separate items
6. Don't forget to order cladding panels as all our fitted furniture has Cashmere carcasses with the exception of open shelf base unit, toilet units, toilet roll unit, open mirror unit and open shelf wall unit

## HOW TO USE CLADDING OPTIONS & PLINTHS

### 1. Base cladding

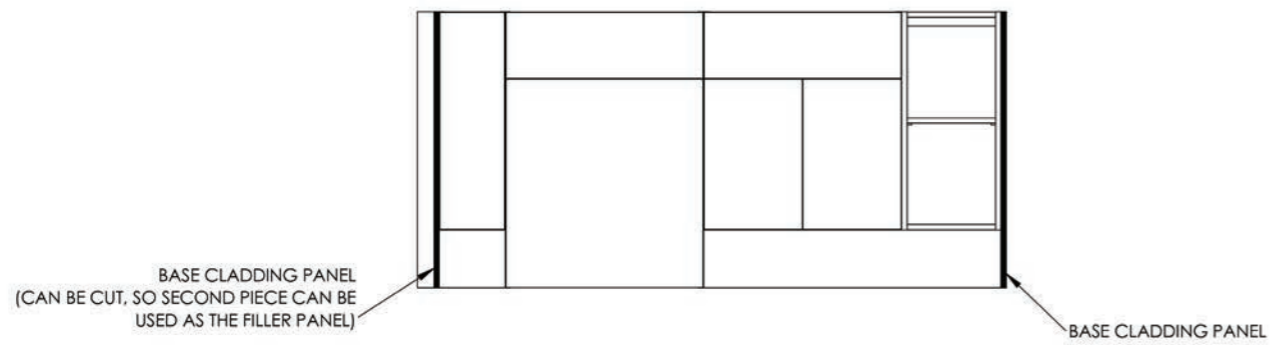

### 2. Wall cladding options

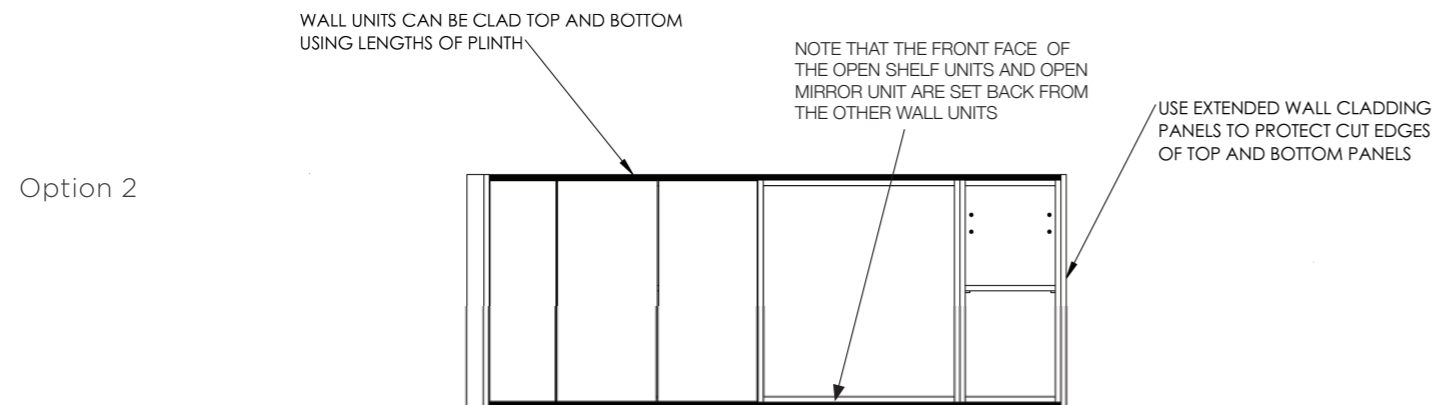
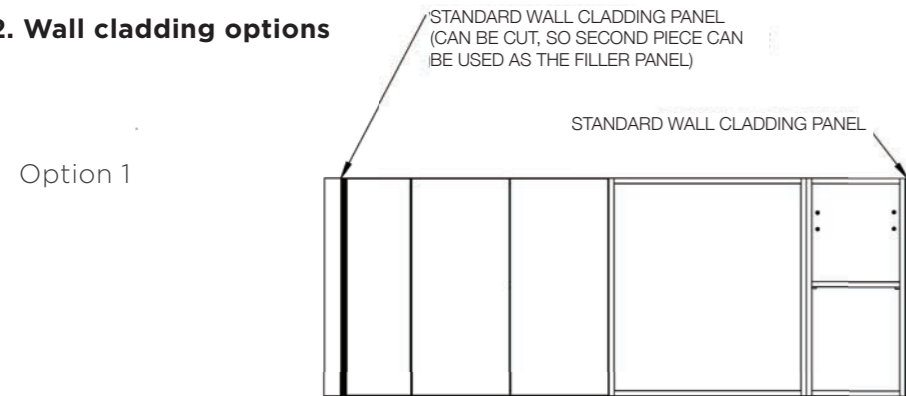

### 3. Tall unit cladding

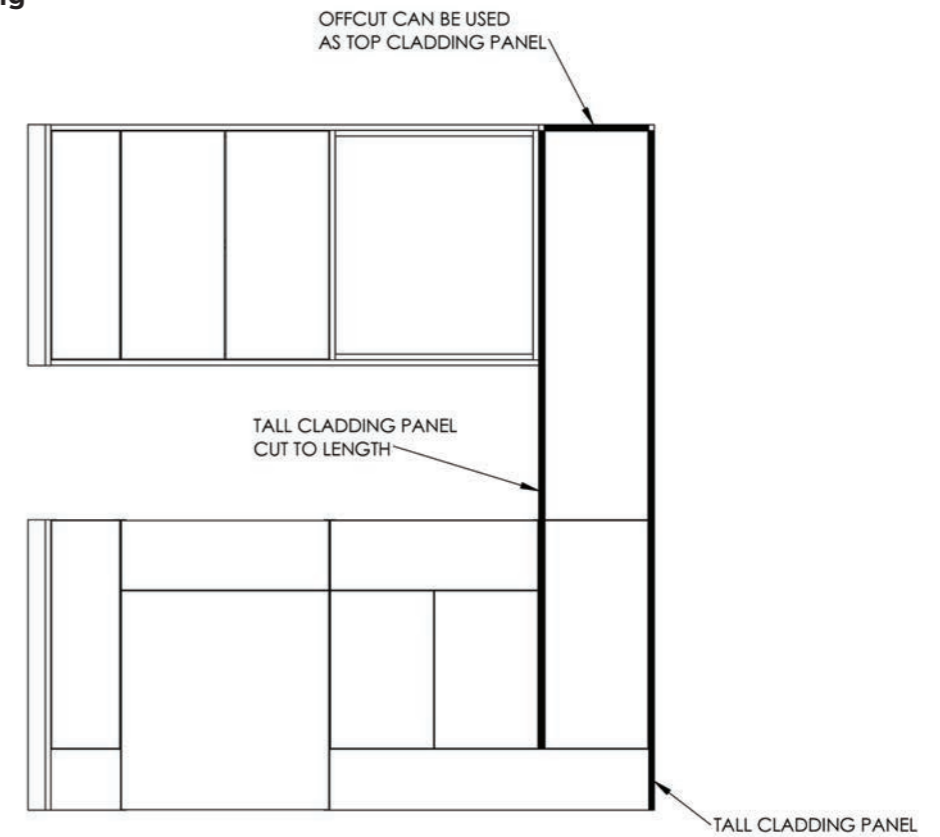

# FITTED RANGE AND OPTIONS

Please order both codes required to complete your unit, this is made up of fascia and carcass code.

## 600mm WASHBASIN UNIT

This unit can be wall mounted, please order a base wall hanging kit. Handles are not included. Cashmere carcass only. One internal carcass shelf.

Style	Colour	Fascia Code	Price	Standard Carcass	Reduced Carcass	Price
Source	White Gloss	EBF1001	£95	EBF2001	EBF2002	£180
	Cashmere	EBF1002				
	Grey Gloss	EBF1003				
	Natural Oak	EBF1004				
	Drift	EBF1005				
Eden	Cashmere Gloss	EBF1006	£165			
Prism	Silver Grey Gloss	EBF1007	£175			
	Charcoal Grey Gloss	EBF1008				



## 500mm FULL HEIGHT BACK-TO-WALL TOILET UNIT

Cistern not included. Carcass matches fascia colour.

Style	Colour	Fascia Code	Price	Standard Carcass	Reduced Carcass	Price
Source	White Gloss	EBF1041	£81	EBF2010	EBF2017	£154
	Cashmere	EBF1042		EBF2011	EBF2018	
	Grey Gloss	EBF1043		EBF2012	EBF2019	
	Natural Oak	EBF1044		EBF2013	EBF2020	
	Drift	EBF1045		EBF2014	EBF2021	
Eden	Cashmere Gloss	EBF1046	£136	EBF2011	EBF2018	
Prism	Silver Grey Gloss	EBF1047	£159	EBF2015	EBF2022	£186
	Charcoal Grey Gloss	EBF1048		EBF2016	EBF2023	



## 700mm WASHBASIN UNIT

This unit can be wall mounted, please order a base wall hanging kit. Handles are not included. Cashmere carcass only. One internal carcass shelf.

Style	Colour	Fascia Code	Price	Standard Carcass	Reduced Carcass	Price
Source	White Gloss	EBF1009	£99	EBF2003	EBF2004	£186
	Cashmere	EBF1010				
	Grey Gloss	EBF1011				
	Natural Oak	EBF1012				
	Drift	EBF1013				
Eden	Cashmere Gloss	EBF1014	£169			
Prism	Silver Grey Gloss	EBF1015	£179			
	Charcoal Grey Gloss	EBF1016				



## 600mm FULL HEIGHT BACK-TO-WALL TOILET UNIT

Cistern not included. Carcass matches fascia colour.

Style	Colour	Fascia Code	Price	Standard Carcass	Reduced Carcass	Price
Source	White Gloss	EBF1049	£85	EBF2024	EBF2031	£160
	Cashmere	EBF1050		EBF2025	EBF2032	
	Grey Gloss	EBF1051		EBF2026	EBF2033	
	Natural Oak	EBF1052		EBF2027	EBF2034	
	Drift	EBF1053		EBF2028	EBF2035	
Eden	Cashmere Gloss	EBF1054	£140	EBF2025	EBF2032	
Prism	Silver Grey Gloss	EBF1055	£163	EBF2029	EBF2036	£192
	Charcoal Grey Gloss	EBF1056		EBF2030	EBF2037	



## SEMI-RECESSED WASHBASINS

Distinct Semi-Recessed Basin

CODE	PRICE
EBF3109	£265

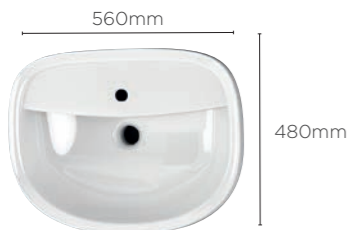

Distinct Short Projection Semi-Recessed Basin

CODE	PRICE
EBF3110	£265



Diversity Semi-Recessed Basin

CODE	PRICE
EBF3112	£165



## BACK-TO-WALL TOILETS

Distinct Back-To-Wall Pan and Soft Close Seat

	CODE	PRICE
PAN	EBF3111	£315
SEAT	EBF3138	£95



Diversity Modern Back-To-Wall Pan and Soft Close Seat

	CODE	PRICE
PAN	EBF3113	£209
SEAT	EBF3139	£90



All prices inclusive of VAT at 20%.

## 200mm TOILET ROLL UNIT

Doors can be fitted left or right handed. Handle is not included. Cashmere carcass only. To be used with standard depth furniture the unit is to be pulled forward. One internal shelf with toilet roll holder fitted above.

Style	Colour	Fascia Code	Price	Reduced Carcass	Price
Source	White Gloss	EBF1017	£55	EBF2039	£170
	Cashmere	EBF1018			
	Grey Gloss	EBF1019			
	Natural Oak	EBF1020			
	Drift	EBF1021			
Eden*	Cashmere Gloss	EBF1022	£79		
Prism	Silver Grey Gloss	EBF1023	£94		£206
	Charcoal Grey Gloss	EBF1024			



\*Door will not have Eden detailing.

## 200mm SINGLE BASE UNIT

Doors can be fitted left or right handed. Handle is not included. Cashmere carcass only. One internal carcass shelf.

Style	Colour	Fascia Code	Price	Standard Carcass	Reduced Carcass	Price
Source	White Gloss	EBF1017	£57	EBF2005	EBF2006	£138
	Cashmere	EBF1018				
	Grey Gloss	EBF1019				
	Natural Oak	EBF1020				
	Drift	EBF1021				
Eden*	Cashmere Gloss	EBF1022	£91			
Prism	Silver Grey Gloss	EBF1023	£101			
	Charcoal Grey Gloss	EBF1024				



\*Door will not have Eden detailing.

## 300mm SINGLE BASE UNIT

Doors can be fitted left or right handed. Handle is not included. Cashmere carcass only. One internal carcass shelf.

Style	Colour	Fascia Code	Price	Standard Carcass	Reduced Carcass	Price
Source	White Gloss	EBF1025	£59	EBF2007	EBF2008	£140
	Cashmere	EBF1026				
	Grey Gloss	EBF1027				
	Natural Oak	EBF1028				
	Drift	EBF1029				
Eden	Cashmere Gloss	EBF1030	£95			
Prism	Silver Grey Gloss	EBF1031	£115			
	Charcoal Grey Gloss	EBF1032				



All prices inclusive of VAT at 20%.

## 300mm DRAWER LINE UNIT

Doors can be fitted left or right handed. Handles are not included. Cashmere carcass only.

Style	Colour	Fascia Code	Price	Standard Carcass	Price
Source	White Gloss	EBF1033	£79	EBF2009	£216
	Cashmere	EBF1034			
	Grey Gloss	EBF1035			
	Natural Oak	EBF1036			
	Drift	EBF1037			
Eden	Cashmere Gloss	EBF1038	£139		
Prism	Silver Grey Gloss	EBF1039	£154		
	Charcoal Grey Gloss	EBF1040			



## 300mm TALL UNIT

Doors can be fitted left or right handed. Handles are not included. Cashmere carcass only.

Style	Colour	Fascia Code	Price	Standard Carcass	Price
Source	White Gloss	EBF1064	£111	EBF2045	£234
	Cashmere	EBF1065			
	Grey Gloss	EBF1066			
	Natural Oak	EBF1067			
	Drift	EBF1068			
Eden	Cashmere Gloss	EBF1069	£196		
Prism	Silver Grey Gloss	EBF1070	£216		
	Charcoal Grey Gloss	EBF1071			



## 300mm OPEN SHELF BASE UNIT

Choice of carcass colour to co-ordinate with furniture. To use in a standard depth run of furniture please pull forward to 10mm less than your fascia.

Colour	Reduced Carcass	Price
White Gloss	EBF3001	£109
Cashmere	EBU3002	
Grey Gloss	EBF3003	
Natural Oak	EBF3004	
Drift	EBU3005	
Silver Grey Gloss	EBF3006	£145
Charcoal Grey Gloss	EBU3007	



## 200mm SINGLE WALL UNIT

Doors can be fitted left or right handed. Handle is not included.  
Cashmere carcass only. One internal carcass shelf.

Style	Colour	Fascia Code	Price	Standard Carcass	Price
Source	White Gloss	EBF1017	£57	EBF2048	£108
	Cashmere	EBF1018			
	Grey Gloss	EBF1019			
	Natural Oak	EBF1020			
	Drift	EBF1021			
Eden*	Cashmere Gloss	EBF1022	£91		
Prism	Silver Grey Gloss	EBF1023	£101		
	Charcoal Grey Gloss	EBF1024			

\*Door will not have Eden detailing.



## 500mm DOUBLE WALL UNIT

Handles are not included. Cashmere carcass only. One internal carcass shelf.

Style	Colour	Fascia Code	Price	Standard Carcass	Price
Source	White Gloss	EBF1072	£116	EBF2046	£129
	Cashmere	EBF1073			
	Grey Gloss	EBF1074			
	Natural Oak	EBF1075			
	Drift	EBF1076			
Eden	Cashmere Gloss	EBF1077	£156		
Prism	Silver Grey Gloss	EBF1078	£216		
	Charcoal Grey Gloss	EBF1079			



## 300mm SINGLE WALL UNIT

Doors can be fitted left or right handed. Handle is not included.  
Cashmere carcass only. One internal carcass shelf.

Style	Colour	Fascia Code	Price	Standard Carcass	Price
Source	White Gloss	EBF1025	£59	EBF2049	£120
	Cashmere	EBF1026			
	Grey Gloss	EBF1027			
	Natural Oak	EBF1028			
	Drift	EBF1029			
Eden	Cashmere Gloss	EBF1030	£95		
Prism	Silver Grey Gloss	EBF1031	£115		
	Charcoal Grey Gloss	EBF1032			



## 600mm DOUBLE WALL UNIT

Handles are not included. Cashmere carcass only. One internal carcass shelf.

Style	Colour	Fascia Code	Price	Standard Carcass	Price
Source	White Gloss	EBF1080	£118	EBF2047	£135
	Cashmere	EBF1081			
	Grey Gloss	EBF1082			
	Natural Oak	EBF1083			
	Drift	EBF1084			
Eden	Cashmere Gloss	EBF1085	£190		
Prism	Silver Grey Gloss	EBF1086	£230		
	Charcoal Grey Gloss	EBF1087			



## 300mm OPEN SHELF WALL UNIT

Choice of carcass colour to co-ordinate with furniture.

Colour	Reduced Carcass	Price
White Gloss	EBF3008	£109
Cashmere	EBF3009	
Grey Gloss	EBF3010	
Natural Oak	EBF3011	
Drift	EBF3012	
Silver Grey Gloss	EBF3013	£145
Charcoal Grey Gloss	EBF3014	

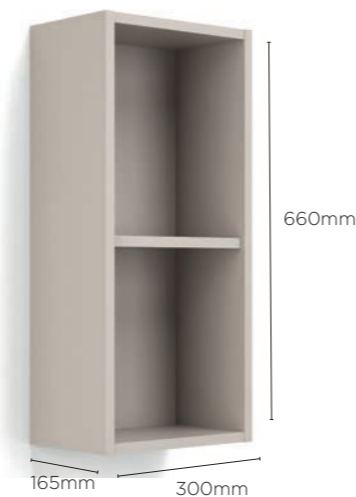

## MIRROR CABINET

Double sided mirror doors. Handles included.  
Cashmere carcass only. One internal carcass shelf.

Size	Fascia Code	Price	Standard Carcass	Price
600 x 165 x 660	EBF1089	£275	EBF2050	£150
700 x 165 x 660	EBF1090	£295	EBF2051	£155



## FRAMELESS MIRROR

Aluminium finish only.

Size	Code	Price
400 x 20 x 850	EBF3136	£175
600 x 20 x 850	EBF3137	£185

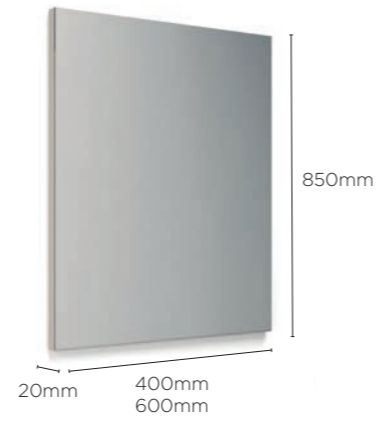

## OPEN MIRROR UNIT

Choice of carcass colour to co-ordinate with furniture.

Colour	Size	Code	Price	Size	Code	Price
White Gloss	600 x 165 x 660	EBF3122	£210	700 x 165 x 660	EBF3129	£225
Cashmere		EBF3123			EBF3130	
Grey Gloss		EBF3124			EBF3131	
Natural Oak		EBF3125			EBF3132	
Drift		EBF3126			EBF3133	
Silver Grey Gloss	600 x 165 x 660	EBF3127	£250	700 x 165 x 660	EBF3134	£265
Charcoal Grey Gloss		EBF3128			EBF3135	

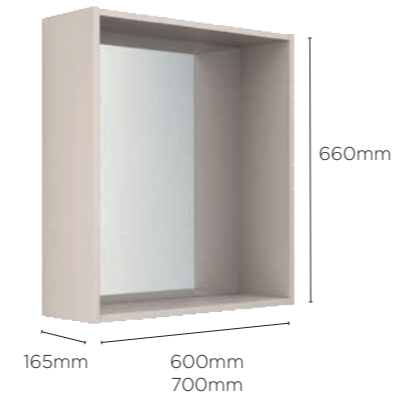

## PLINTH

This can also be used as a filler or cladding panel when required.

Colour	Size	Code	Price	Size	Code	Price
White Gloss	1300 x 16 x 175	EBF3057	£45	2600 x 16 x 175	EBF3064	£79
Cashmere		EBF3058			EBF3065	
Grey Gloss		EBF3059			EBF3066	
Natural Oak		EBF3060			EBF3067	
Drift		EBF3061			EBF3068	
Silver Grey Gloss	1300 x 16 x 175	EBF3062	£70	2600 x 16 x 175	EBF3069	£99
Charcoal Grey Gloss		EBF3063			EBF3070	



## BATH SIDE PANEL

Fixing kit is included.

Style	Colour	Size	Code	Price	Size	Code	Price
Source	White Gloss	1700 x 16 x 500	EXG0233	£152	1800 x 16 x 500	EXG0237	£162
	Cashmere		EXG0230			EXG0234	
	Grey Gloss		EXG00014			EXG00018	
	Natural Oak		EXG0232			EXG0236	
	Drift		EXG0231			EXG0235	
Eden*	Cashmere Gloss	1700 x 16 x 500	EBF3022	£209	1800 x 16 x 500	EBF3030	£219
Prism	Silver Grey Gloss		EBF3023	£219		EBF3031	£229
	Charcoal Grey Gloss	EBF3024	EBF3032				

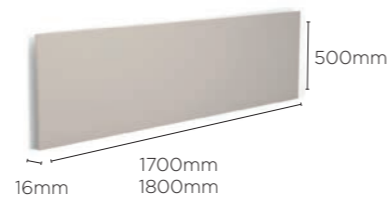

## HANDLES



CHROME KNOB  
EXG0736  
£8



CHROME BAR HANDLE  
EXG0739  
£8



CHROME ROUND BAR  
EBF3116  
£12



CHROME RECTANGULAR KNOB  
EBF3117  
£12

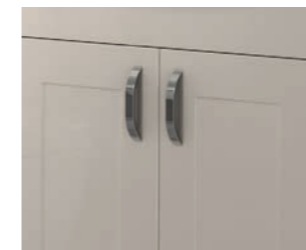

CHROME CRESCENT HANDLE  
EBF3118  
£12

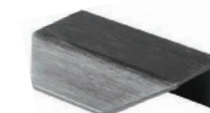

BRUSHED PULL HANDLE  
EBF3119  
£12



CHROME PULL HANDLE  
EBF3120  
£8

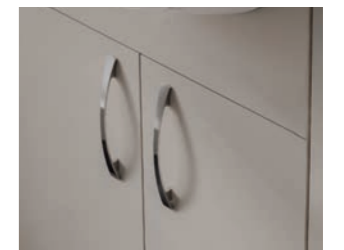

CHROME ARC HANDLE  
EBF3121  
£8

## BATH END PANEL

Style	Colour	Size	Code	Price	Size	Code	Price	Size	Code	Price
Source	White Gloss	684 x 16 x 500	EXG0241	£72	734 x 16 x 500	EXG0245	£79	784 x 16 x 500	EXG0249	£83
	Cashmere		EXG0238			EXG0242			EXG0246	
	Grey Gloss		EXG00022			EXG00026			EXG00030	
	Natural Oak		EXG0240			EXG0244			EXG0248	
	Drift		EXG0239			EXG0243			EXG0247	
Eden*	Cashmere Gloss	684 x 16 x 500	EBF3038	£99	734 x 16 x 500	EBF3046	£109	784 x 16 x 500	EBF3054	£119
Prism	Silver Grey Gloss		EBF3039	£105		EBF3047	£115		EBF3055	£125
	Charcoal Grey Gloss	EBF3040	EBF3048	EBF3056						

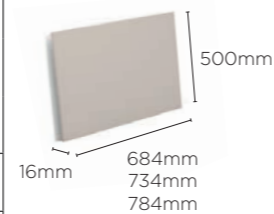

\*Eden panel is 18mm thick

All prices inclusive of VAT at 20%.



## LED DOWNLIGHTS

Only the twin pack comes with a driver.



	CODE	PRICE
LED DOWNLIGHT TWIN PACK	EBF3106	£90

## WALL HANGING KIT

Suitable for use with a washbasin unit.



CODE	PRICE
EBF3108	£12

## WALL CLADDING PANELS

Colour	Size	Code	Price	Size	Code	Price
White Gloss	16 x 175 x 660	EBF3071	£32	16 x 175 x 693	EBF3078	£32
Cashmere		EBF3072			EBF3079	
Grey Gloss		EBF3073			EBF3080	
Drift		EBF3074			EBF3081	
Natural Oak		EBF3075			EBF3082	
Silver Grey Gloss	16 x 175 x 660	EBF3076	£42	16 x 175 x 693	EBF3083	£42
Charcoal Grey Gloss		EBF3077			EBF3084	



## BASE CLADDING PANELS

Colour	Size	Code	Price	Size	Code	Price
White Gloss	16 x 300 x 835	EBF3085	£55	16 x 220 x 835	EBF3092	£55
Cashmere		EBF3086			EBF3093	
Grey Gloss		EBF3087			EBF3094	
Natural Oak		EBF3088			EBF3095	
Drift		EBF3089			EBF3096	
Silver Grey Gloss	16 x 300 x 835	EBF3090	£65	16 x 220 x 835	EBF3097	£65
Charcoal Grey Gloss		EBF3091			EBF3098	

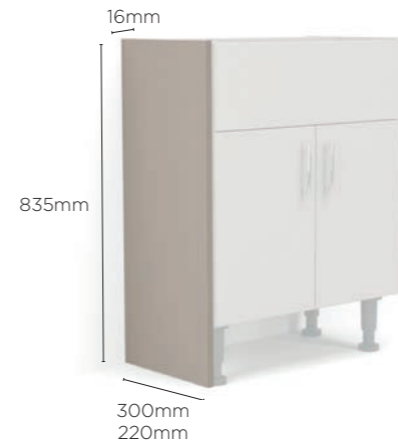

## TALL CLADDING PANELS

Colour	Size	Code	Price
White Gloss	16 x 300 x 1971	EBF3099	£90
Cashmere		EBF3100	
Grey Gloss		EBF3101	
Natural Oak		EBF3102	
Drift		EBF3103	
Silver Grey Gloss	16 x 300 x 1971	EBF3104	£115
Charcoal Grey Gloss		EBF3105	



## 22mm LAMINATE WORKTOPS

Includes an edging strip

Colour	Size	Code	Price	Size	Code	Price
White Gloss	1000 x 230	EBF3140	£75	1000 x 310	EBF3147	£75
Cashmere		EBF3141			EBF3148	
Natural Oak		EBF3142			EBF3149	
Drift		EBF3143			EBF3150	
Black Granite Gloss		EBF3144			EBF3151	
Grey Strata		EBF3145			EBF3152	
Basalt Grey		EBF3146			EBF3153	

Colour	Size	Code	Price	Size	Code	Price
White Gloss	1500 x 230	EBF3154	£105	1500 x 310	EBF3161	£105
Cashmere		EBF3155			EBF3162	
Natural Oak		EBF3156			EBF3163	
Drift		EBF3157			EBF3164	
Black Granite Gloss		EBF3158			EBF3165	
Grey Strata		EBF3159			EBF3166	
Basalt Grey		EBF3160			EBF3167	

Colour	Size	Code	Price	Size	Code	Price
White Gloss	2000 x 230	EBF3168	£169	2000 x 310	EBF3175	£169
Cashmere		EBF3169			EBF3176	
Natural Oak		EBF3170			EBF3177	
Drift		EBF3171			EBF3178	
Black Granite Gloss		EBF3172			EBF3179	
Grey Strata		EBF3173			EBF3180	
Basalt Grey		EBF3174			EBF3181	

Colour	Size	Code	Price	Size	Code	Price
White Gloss	3000 x 230	EBF3182	£185	3000 x 310	EBF3189	£185
Cashmere		EBF3183			EBF3190	
Natural Oak		EBF3184			EBF3191	
Drift		EBF3185			EBF3192	
Black Granite Gloss		EBF3186			EBF3193	
Grey Strata		EBF3187			EBF3194	
Basalt Grey		EBF3188			EBF3195	

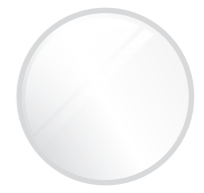

White Gloss

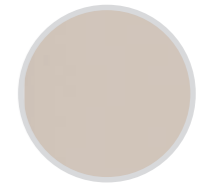

Cashmere



Natural Oak



Drift

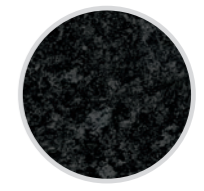

Black Granite Gloss

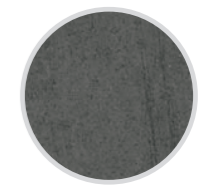

Grey Strata

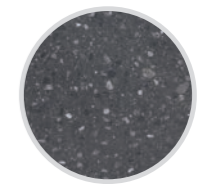

Basalt Grey

# MODULAR RANGE



## SOURCE



A stylish MFC slab door, the Source doorstyle, with its crisp edge profile offers a clean modern look with a dedicated handle.

### Unit Colours



White Gloss   Grey Gloss   Natural Oak   Drift

### Unit Overview

#### Wall Mounted

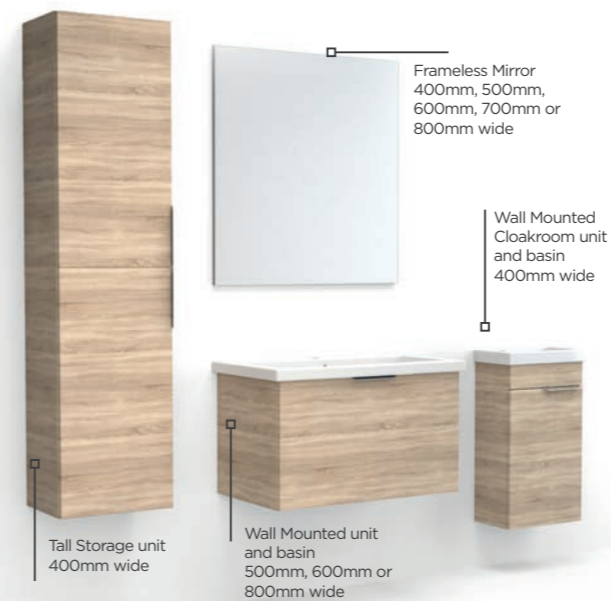

#### Freestanding



# SOURCE

## WHITE GLOSS

The bright, clean look of this furniture in White Gloss makes the room feel light and spacious.

Shown here: Bath side panel, wall mounted unit and basin, mirror cabinet and tall storage unit.

# SOURCE

## WHITE GLOSS

The clean lines of the White Gloss units give this cloakroom a fresh finish.

Shown here: Freestanding cloakroom unit and basin, frameless mirror and full height back-to-wall toilet unit.

+

# SOURCE

GREY GLOSS

A neutral background showcases the stunning Grey Gloss finish in this family bathroom, with practical storage and beautiful surfaces creating a bathroom to envy.

Shown here: Bath end and side panel, wall mounted washbasin unit and basin, mirror cabinet, tall storage unit and full height back-to-wall toilet unit.

+



+

# SOURCE

NATURAL OAK

This fresh and contemporary wall mounted furniture in Natural Oak creates a bright and inviting space.

Shown here: Bath side panel, wall mounted washbasin unit and basin, mirror cabinet and tall storage unit.

+

+

# SOURCE

NATURAL OAK

Achieve a Scandi style with the effect of Natural Oak combined with clean white tiles and a touch of industrial chic.

Shown here: Full height back-to-wall toilet unit, freestanding washbasin unit and basin and mirror cabinet.

+



+

# SOURCE

DRIFT

Ideal for a family bathroom, wall mounted furniture in Drift provides the perfect solution. The stunning characteristic grain of the furniture is complemented by the feature handle and crisp white ceramic basin.

Shown here: Full height back-to-wall toilet unit, tall storage unit, wall mounted washbasin unit and basin, mirror cabinet and bath side and end panel.

+



# MODULAR RANGE AND OPTIONS

Please order both codes required to complete your unit, this is made up of unit code and basin code.

## Wall Mounted Cloakroom Unit

Handle included, not fitted. Basin is universal handed. Right hand illustrated.

Colour	LH Unit Code	RH Unit Code	Price	Basin Code	Price
White Gloss	EBF00005	EBF00009	£190	EBF00001	£135
Grey Gloss	EBF00006	EBF0010			
Natural Oak	EBF00007	EBF00011			
Drift	EBF00008	EBF00012			



## Freestanding Cloakroom Unit and Basin

Handle included, not fitted. Basin is universal handed. Right hand illustrated.

Colour	LH Unit Code	RH Unit Code	Price	Basin Code	Price
White Gloss	EBF00013	EBF00017	£190	EBF00001	£135
Grey Gloss	EBF00014	EBF00018			
Natural Oak	EBF00015	EBF00019			
Drift	EBF00016	EBF00020			



## 500mm Wall Mounted Washbasin Unit

Handle included, not fitted.

Colour	Unit Code	Price	Basin Code	Price
White Gloss	EBF00021	£295	EBF00002	£200
Grey Gloss	EBF00022			
Natural Oak	EBF00023			
Drift	EBF00024			

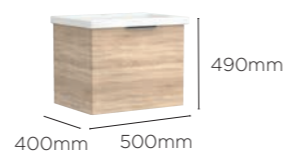

## 600mm Wall Mounted Washbasin Unit

Handle included, not fitted.

Colour	Unit Code	Price	Basin Code	Price
White Gloss	EBF00025	£315	EBF00003	£210
Grey Gloss	EBF00026			
Natural Oak	EBF00027			
Drift	EBF00028			

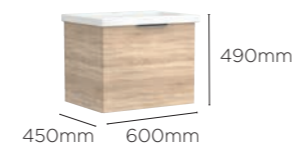

## 800mm Wall Mounted Washbasin Unit

Handle included, not fitted.

Colour	Unit Code	Price	Basin Code	Price
White Gloss	EBF00029	£375	EBF00004	£250
Grey Gloss	EBF00030			
Natural Oak	EBF00031			
Drift	EBF00032			

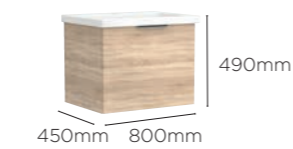

## 500mm Freestanding Double Door Washbasin Unit

Handles included, not fitted.

Colour	Unit Code	Price	Basin Code	Price
White Gloss	EBF00033	£295	EBF00002	£200
Grey Gloss	EBF00034			
Natural Oak	EBF00035			
Drift	EBF00036			



## 600mm Freestanding Double Door Washbasin Unit

Handles included, not fitted.

Colour	Unit Code	Price	Basin Code	Price
White Gloss	EBF00037	£315	EBF00003	£210
Grey Gloss	EBF00038			
Natural Oak	EBF00039			
Drift	EBF00040			



## Full Height Back-To-Wall Toilet Unit

Matching MFC worktop included, Cistern not included.

Colour	Size	Unit Code	Price	Size	Unit Code	Price
White Gloss	510 x 225 x 900	EBF00041	£235	610 x 225 x 900	EBF00045	£255
Grey Gloss		EBF00042			EBF00046	
Natural Oak		EBF00043			EBF00047	
Drift		EBF00044			EBF00048	



## Wall Mounted Tall Storage Unit

Handles included, not fitted. Right hand illustrated.

Colour	LH Unit Code	RH Unit Code	Price
White Gloss	EBF00049	EBF00053	£257
Grey Gloss	EBF00050	EBF00054	
Natural Oak	EBF00051	EBF00055	
Drift	EBF00052	EBF00056	

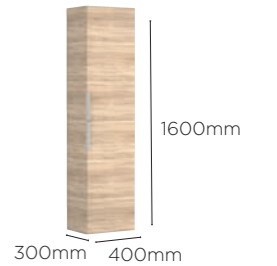

## Double Door Mirror Cabinet

Includes overhead light and shaver socket.

Colour	Size	Unit Code	Price	Size	Unit Code	Price	Size	Unit Code	Price
White Gloss	500 x 160 x 660	EXG0070	£449	600 x 160 x 660	EXG0074	£459	800 x 160 x 660	EXG0078	£485
Grey Gloss		EXG00002			EXG00006			EXG00010	
Natural Oak		EXG0072			EXG0076			EXG0079	
Drift		EXG0073			EXG0077			EXG0080	



## Frameless Mirror

Aluminium finish only.

Size	Code	Price
400 x 20 x 660	EXG00033	£109
500 x 20 x 660	EXG00034	£109
600 x 20 x 660	EXG00035	£120
700 x 20 x 660	EXG00036	£130
800 x 20 x 660	EXG00037	£140



## Bath Side Panel

Colour	Size	Code	Price	Size	Code	Price
White Gloss	1700 x 16 x 500	EXG0233	£152	1800 x 16 x 500	EXG0237	£162
Grey Gloss		EXG00014			EXG00018	
Natural Oak		EXG0232			EXG0236	
Drift		EXG0231			EXG0235	

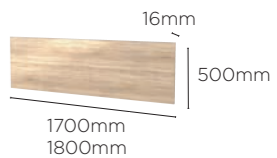

## Bath End Panel

Colour	Size	Code	Price	Size	Code	Price	Size	Code	Price
White Gloss	684 x 16 x 500	EXG0241	£72	734 x 16 x 500	EXG0245	£79	784 x 16 x 500	EXG0249	£83
Grey Gloss		EXG00022			EXG00026				
Natural Oak		EXG0240			EXG0244				
Drift		EXG0239			EXG0243				

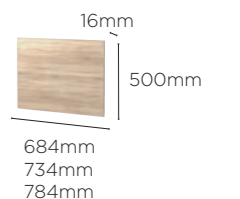

All prices inclusive of VAT at 20%.

# CLASSIC RANGE



## VINTAGE



Featuring an inset detail to the Shaker profile, the Vintage doorstyle adds a touch of elegance to any bathroom.

### Unit Colours



Ivory Earl Grey Graphite

The back of the Vintage door and the internal carcass finish is Earl Grey.

### Unit overview





+

# VINTAGE

IVORY

This freestanding arrangement in subtle Ivory has all the appeal of a traditional bathroom but is also a practical solution with storage.

Shown here: Freestanding washbasin unit with basin, back-to-wall toilet unit and single door mirror cabinet.

+



+

# VINTAGE

## EARL GREY

+

A modern take on a classic Shaker style, this panelled door in heritage painted effect combines all the elegance of traditional bathroom design with a smart, contemporary twist.

Shown here: Bath side and end panel, back-to-wall toilet unit, freestanding washbasin unit with solid composite worktop with ceramic undermount basin and single door mirror cabinet.



+

# VINTAGE

## GRAPHITE

This beautiful grey hue brings a soothing quality to this family bathroom. Paired with patterned floor tiles it completes the traditional styling.

Shown here: Bath side panel, back-to-wall toilet unit, freestanding washbasin unit with solid composite worktop with ceramic undermount basin and single door mirror cabinet.



+

# VINTAGE

## GRAPHITE

Perfect for making a strong statement, Graphite is a bold finish which can be accessorised with complementary or contrasting colours.

Shown here: Freestanding cloakroom unit and basin, frameless mirror and back-to-wall toilet unit.



# CLASSIC RANGE AND OPTIONS

All washbasin units come with an optional plinth

## Freestanding Cloakroom Unit and Mineralcast Basin

Tap hole is always located on the left hand side of the basin. Right hand unit illustrated.

Colour	LH Code	RH Code	Price
Ivory	EXG0702	EXG0705	£362
Earl Grey	EXG0700	EXG0703	
Graphite	EXG0701	EXG0704	



## 500mm Freestanding Washbasin Unit and Mineralcast Basin

Colour	Code	Price
Ivory	EXG0729	£499
Earl Grey	EXG0727	
Graphite	EXG0728	



## 600mm Freestanding Washbasin Unit and Basin

Colour	Code	Price
Ivory	EXG0732	£524
Earl Grey	EXG0730	
Graphite	EXG0731	



## Extra Deep Washbasin Unit with Pressed Worktop

Basin not supplied.

Colour	Code	Price
Ivory	EXG0711	£446
Earl Grey	EXG0709	
Graphite	EXG0710	



## Extra Deep Washbasin Unit With Crystal White Solid Composite Worktop and Ceramic Undermount Basin

Colour	Code	Price
Ivory	EXG0708	£787
Earl Grey	EXG0706	
Graphite	EXG0707	



## Back-To-Wall Toilet Unit With Pressed Worktop

Cistern not included.

Colour	Code	Price
Ivory	EXG0735	£310
Earl Grey	EXG0733	
Graphite	EXG0734	



## Single Door Mirror Cabinet

Colour	LH Unit Code	RH Unit Code	Price
Ivory	EXG0723	EXG0726	£341
Earl Grey	EXG0721	EXG0724	
Graphite	EXG0722	EXG0725	



## Framed Mirror

Colour	Size	Code	Price	Size	Code	Price	Size	Code	Price
Ivory	400 x 18 x 750	EXG0714	£104	500 x 18 x 750	EXG0717	£111	600 x 18 x 750	EXG0720	£121
Earl Grey		EXG0712			EXG0715			EXG0718	
Graphite		EXG0713			EXG0716			EXG0719	



## Bath Side Panel

Colour	Size	Code	Price	Size	Code	Price
Ivory	1700 x 18 x 500	EXG0752	£209	1800 x 18 x 500	EXG0755	£226
Earl Grey		EXG0750			EXG0753	
Graphite		EXG0751			EXG0754	

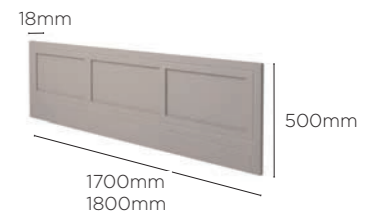

## Bath End Panel

Colour	Size	Code	Price	Size	Code	Price	Size	Code	Price
Ivory	682 x 18 x 500	EXG0743	£104	732 x 18 x 500	EXG0746	£107	782 x 18 x 500	EXG0749	£110
Earl Grey		EXG0741			EXG0744			EXG0747	
Graphite		EXG0742			EXG0745			EXG0748	

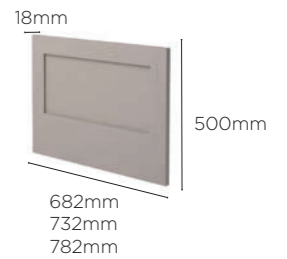

## BACK-TO-WALL TOILETS

### Diversity Modern Back-To-Wall Pan and Soft Close Seat

	CODE	PRICE
PAN	EBF3113	£209
SEAT	EBF3139	£90

### Distinct Back-To-Wall Pan and Soft Close Seat

	CODE	PRICE
PAN	EBF3111	£315
SEAT	EBF3138	£95



## HANDLES



CHROME KNOB  
HANDLE  
EXG0736  
£8



CHROME BAR  
HANDLE  
EXG0739  
£8

# FEATURES AND BENEFITS



## Mirrors

An essential feature in every bathroom, a large mirror is both practical and decorative, making the room appear more spacious.



## Storage

Planning plenty of drawer and shelf space into the overall design ensures the bathroom is easy to keep tidy with uncluttered surfaces.



## Modular Handles

The stunning modular range features a dedicated brushed chrome handle, designed for maximum impact on the stylish drawers and doors.



## Fitted Handles

From the simplest chrome knob through to straight, curved and decorative handles, there are eight stunning designs to choose from.



## Soft Close

Ensuring the bathroom is a peaceful haven, all units with doors and drawers are fitted with soft close hinges as standard.



## Reduced or Standard Depths

Washbasin units and toilet units from the Fitted range, are available in the standard depth of 300mm or the reduced depth of 220mm, ideal for where space is at a premium.



## Fitted Worktops

Opt for a co-ordinating or contrasting effect with our carefully selected range of seven laminate worktops.



## Bath Panels

For a fully co-ordinated look throughout the bathroom, choose matching side and end bath panels.

# TERMS & CONDITIONS

## GENERAL

The colours and finishes in this brochure may vary from the actual products supplied, due to the reproduction of colours in printing. The sizes of all products stated are all approximate.

All bathrooms should be well ventilated using suitable air extraction. Product failures caused as a result of inadequate ventilation are not covered by the terms of our guarantee and warranty. Please refer to your nearest bathroom specialist for detailed advice.

The information contained in this brochure is correct at the time of press. However, we reserve the right to alter materials and specifications in line with our continuing programme of product and service development.

## GENERAL GUARANTEE TERMS

Our general guarantee terms are set out below. Please refer to individual product sections for specific conditions and guarantee terms.

General guarantee:

1. Applies when:

- 1.1 products are installed correctly in accordance with our fitting instructions and are for domestic use in a room with suitable ventilation;
- 1.2 furniture is not used in a wet room environment or in frequent direct contact with water;
- 1.3 Solid Surface products have been stored correctly in accordance with our packaging instructions – specifically these must be stored flat at normal room temperature prior to installation to avoid any distortion.

2. In the event of a product failure within the guarantee period (from the date of purchase) we will supply a free of charge replacement for the failed item. If that part is no longer available, a nearest equivalent replacement will be supplied. Our guarantee is limited to the products supplied and does not cover any associated installation costs, consequential loss or damage claims.

3. The terms of this guarantee do not affect consumer's statutory rights.

4. Any guarantee is limited to the original purchaser, is non-transferable and does not cover the purchase of ex-display items.

5. To obtain replacement parts in accordance with the terms of this guarantee, please contact the supplier.

6. Product guarantees may be invalidated through incorrect care and maintenance procedures.

7. All electrical installations must be carried out by a suitably qualified electrician. Your guarantee does not cover products incorrectly installed.

## BATHROOM FURNITURE

Our furniture has been specifically designed and manufactured for performance in general bathroom use and carries a 5 year guarantee. All bathroom furniture will deteriorate through prolonged periods of exposure to high levels of condensation and all bathrooms must be adequately ventilated using suitable extraction to avoid this. Failure to ensure adequate ventilation may invalidate your guarantee.

Bathroom furniture is not specified or designed for use in areas of high or regular direct contact with water, particularly in wet room environments or where direct and/or regular water contact is prevalent. Any guarantee does not extend to this use.

In respect of furniture containing electrical components, these items are unsuitable for zones 0, 1 & 2 installations. If you are in any doubt, please consult a qualified electrician.

## SOLID SURFACE PRODUCTS

Solid Surface products are fabricated and finished by hand and carry a 5 year guarantee.

## MINERALCAST PRODUCTS

Mineralcast products carry a 5 year guarantee and are supplied with a 2% dimensional tolerance.

## SANITARYWARE

Our sanitaryware carries a lifetime guarantee against manufacturing defects and are supplied with a 2% dimensional tolerance. Installation must be in accordance with the instructions provided and failure to comply with these may invalidate the guarantee.

## TOILET SEATS

A 2 year guarantee applies to all toilet seats and related components. It is the responsibility of the consumer to ensure that suitable cleaning products are used. Do not use abrasive cleaning products or cleaning products that contain chlorine or acids, as these may cause yellowing or peeling of the material. After cleaning, wipe the seat with a well wrung out cloth. Leave the seat and lid up whenever strong cleaning products are left in the bowl of the WC pan to prevent damage from vapours.

## COMMERCIAL APPLICATIONS

A 12 month guarantee applies to all products fitted in a commercial environment.

## OUR ENVIRONMENTAL COMMITMENT

Our manufacturing process is green at heart. Sustainability is high on our agenda and we strive to make the least environmental impact. From the wood we use, the energy we consume, to our transport logistics, we take care to ensure we operate as responsibly as possible.



Utopia Furniture Ltd  
Springvale Avenue  
Springvale Business Park  
Bilston  
Wolverhampton  
WV14 0QL  
Tel:01902 406402



Look for FSC® certified products



Proudly designed and  
manufactured in Britain



# William Wilson

PLUMBING • HEATING • BATHROOM • SUPPLIES

<b>ABERDEEN</b>	Hareness Road, Altens Industrial Estate. AB12 3QA	<b>Tel: 01224 877522</b>
<b>AVIEMORE</b>	Unit 8 Dalfaber Industrial Estate, Dalfaber Drive. PH22 1ST	<b>Tel: 01479 811567</b>
<b>AYR</b>	18/19 Newton Trading Estate, McCalls Avenue. KA8 9AE	<b>Tel: 01292 286381</b>
<b>CUMBERNAULD</b>	5-7 Wardpark Place, Wardpark South. G67 3HX	<b>Tel: 01236 868710</b>
<b>CUPAR</b>	Unit 1, Prestonhall Industrial Estate. KY15 4RD	<b>Tel: 01334 655700</b>
<b>DUNDEE</b>	Unit 7 & 8, Rutherford Road, Dryburgh Industrial Estate. DD2 3XH	<b>Tel: 01382 880044</b>
<b>EDINBURGH</b>	70 Newcraighall Road. EH15 3HS	<b>Tel: 0131 657 5151</b>
<b>ELGIN</b>	7 - 9 Pinefield Parade. IV30 6JQ	<b>Tel: 01343 543181</b>
<b>FORT WILLIAM</b>	Unit 3, Ben Nevis Industrial Estate. PH33 6PR	<b>Tel: 01397 705375</b>
<b>FRASERBURGH</b>	26 North Street. AB43 9DJ	<b>Tel: 01346 514474</b>
<b>GLASGOW</b>	Unit 6, Houston Place, Kingston Bridge Trading Estate. G5 8SG	<b>Tel: 0141 418 2611</b>
<b>GLASGOW</b>	Unit 3c, 790 South Street, Whiteinch. G14 OSY	<b>Tel: 0141 434 1520</b>
<b>INVERNESS</b>	Henderson Road, Longman Industrial Estate. IV1 1SR	<b>Tel: 01463 237391</b>
<b>INVERURIE</b>	Units 1 & 2, Burghmuir Place, Blackhall Industrial Estate. AB51 4FW	<b>Tel: 01467 629853</b>
<b>KIRKCALDY</b>	Caxton Place, Mitchelston Industrial Estate. KY1 3LT	<b>Tel: 01592 653295</b>
<b>KIRKWALL</b>	Sparrowhawk Road, Hatston Industrial Estate. KW15 1GE	<b>Tel: 01856 871282</b>
<b>PERTH</b>	Dunkeld Road. PH1 3AD	<b>Tel: 01738 638323</b>
<b>PORTREE</b>	Unit 4d, Broom Place. IV51 9HL	<b>Tel: 01478 61257</b>
<b>STORNOWAY</b>	Bells Road. HS1 2QT	<b>Tel: 01851 704046</b>
<b>THURSO</b>	Unit 8, Ormlie Industrial Estate. KW14 7QU	<b>Tel: 01847 891685</b>

# William Wilson

BATHROOM SHOWROOMS

<b>ABERDEEN</b>	Hareness Road, Altens Industrial Estate. AB12 3QA	<b>Tel: 01224 335335</b>
<b>AYR</b>	18/19 Newton Trading Estate, McCalls Avenue. KA8 9AE	<b>Tel: 01292 286381</b>
<b>AVIEMORE</b>	Unit 8 Dalfaber Industrial Estate, Dalfaber Drive. PH22 1ST	<b>Tel: 01479 811567</b>
<b>DUNDEE</b>	Unit 7 & 8, Rutherford Road, Dryburgh Industrial Estate. DD2 3XH	<b>Tel: 01382 883555</b>
<b>EDINBURGH</b>	70 Newcraighall Road. EH15 3HS	<b>Tel: 0131 657 7703</b>
<b>ELGIN</b>	7 - 9 Pinefield Parade. IV30 6JQ	<b>Tel: 01343 543181</b>
<b>FRASERBURGH</b>	26 North Street. AB43 9DJ	<b>Tel: 01346 514474</b>
<b>GLASGOW</b>	Unit 6, Houston Place, Kingston Bridge Trading Estate. G5 8SG	<b>Tel: 0141 429 6627</b>
<b>INVERNESS</b>	Henderson Road, Longman Industrial Estate. IV1 1SR	<b>Tel: 01463 245502</b>
<b>INVERURIE</b>	Units 1 & 2, Burghmuir Place, Blackhall Industrial Estate. AB51 4FW	<b>Tel: 01467 629853</b>
<b>KIRKCALDY</b>	Caxton Place, Mitchelston Industrial Estate. KY1 3LT	<b>Tel: 01592 653295</b>
<b>KIRKWALL</b>	Sparrowhawk Road, Hatston Industrial Estate. KW15 1GE	<b>Tel: 01856 871282</b>
<b>PERTH</b>	Dunkeld Road. PH1 3AD	<b>Tel: 01738 638323</b>
<b>PORTREE</b>	Unit 4d, Broom Place. IV51 9HL	<b>Tel: 01478 612577</b>
<b>STORNOWAY</b>	26 Inaclete Road. HS1 2RN	<b>Tel: 01851 704046</b>



<b>ABERDEEN</b>	10 Whitemyres Avenue, Mastrick Industrial Estate. AB16 6HQ	<b>Tel: 01224 663322</b>
-----------------	------------------------------------------------------------	--------------------------

[www.williamwilson.co.uk](http://www.williamwilson.co.uk)