

QUANTUM SE

L 1700MM

W 800MM

	5MM	CARRONITE
QUANTUM SE	✓	✓
L-SHAPED PANEL 1700x800x540	-	✓
FRONT PANEL 1700x540	✓	✓
END PANEL 800x540	✓	✓
SCREEN CFS-1 (H=1400MM)	✓	✓
SCREEN CFS-2 (H=1500MM)	✓	✓

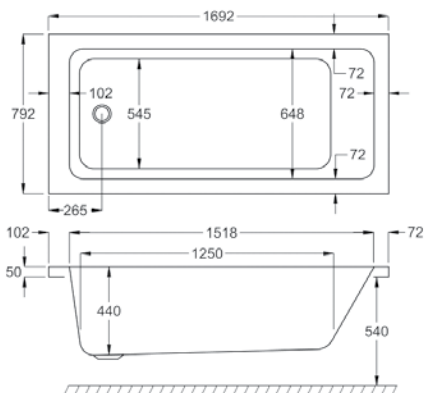
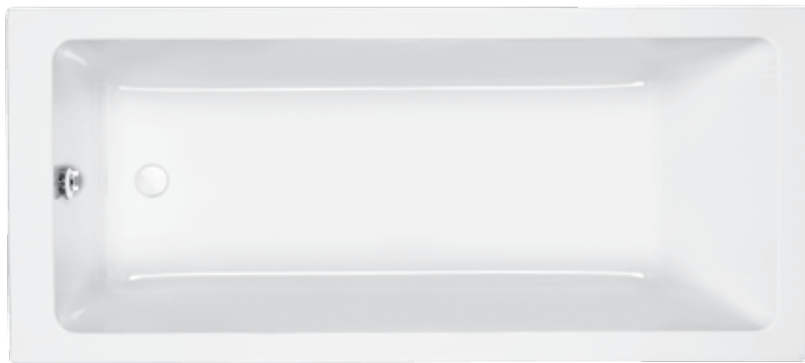

Carronite



Panel



Whirlpool

WATER CAPACITY

267 LTR

This measurement is taken to the overflow

WHIRLPOOL COMPATIBLE

C-LENDA SYSTEMS

1, 2, 3, 4, 5, 6

KIT REFERENCES

STANDARD - AK-03

CARRONITE - AK-03-C