

# PROFILE DUO

L 1700MM

W 700MM

	5MM	CARRONITE
<b>PROFILE DUO</b>	✓	✓
L-SHAPED PANEL 1700x700x515	-	✓
FRONT PANEL 1700x515	✓	✓
END PANEL 700x515	✓	✓
SCREEN CFS-1 (H=1400MM)	✓	✓
SCREEN CFS-2 (H=1500MM)	✓	✓

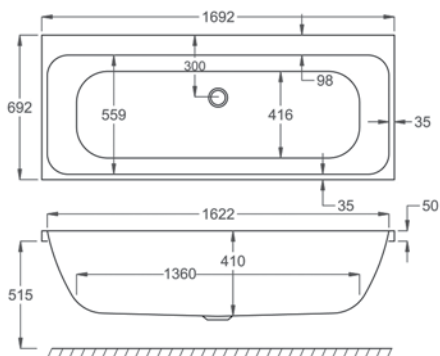

Carronite



Panel

## WATER CAPACITY

205 LTR

This measurement is taken to the overflow

## WHIRLPOOL COMPATIBLE

N/A

## KIT REFERENCES

STANDARD - AK-01

CARRONITE - AK-01-C