

**BI-DIRECTIONAL VALVE WITH FLOW-SELECTABLE FEATURE**

**Installation of valve**

The valve is a bi-directional valve \* and can be installed horizontally or vertically in either the flow or return pipe.

A built in flow direction selection feature can be used to eliminate the risk of water hammer.

**Troubleshooting**

In the unlikely event of water hammer being encountered turn the setting ring (see diagram 4) to the other setting. Alternatively if commissioning the whole system, establish the flow direction through each valve using the diagrams below.

If the flow direction needs to be changed there is no need to remove the valve, simply turn the setting ring.

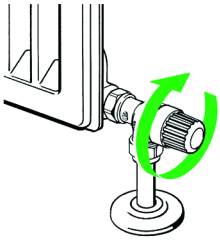

1 Close all radiator valves by turning the valve cover cap clockwise. Leave system to cool.

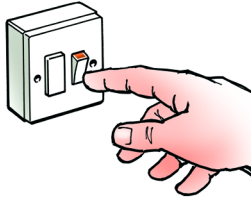

2 Start boiler/heating.

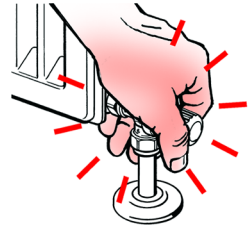

3 Open one valve and determine flow direction. Which pipe heats first?

Keymark reference: This package contains sensor 013G6040, valve 013G6281 (15mm) or valve 013G6283 (8/10 mm)

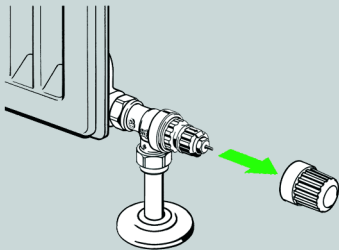

4 Remove cap and turn setting ring according to the drawings - the setting ring is turned by hand only.

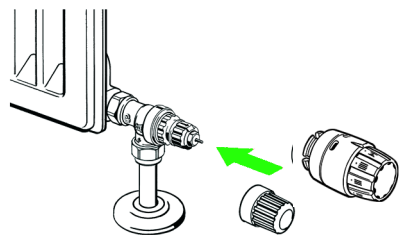
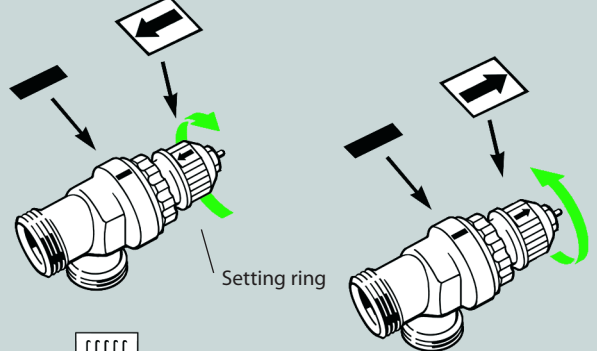

5 Repeat step 3 and 4 until all valves have been set correctly. Sensor may now be fitted or the valve cap temporarily refitted.

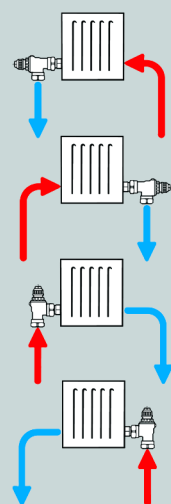
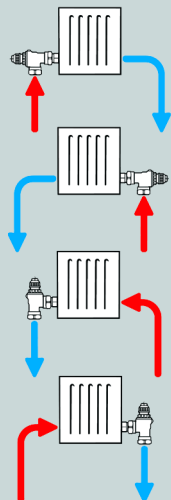

\* Maximum pressure drop should not exceed 0.45 bar



# Installation Guide

## Fitting the Sensor

1. Remove cap from valve and turn sensor to

2. Make sure union nut is turned loosely up towards the sensor body until it is only slightly free of the lower part of the sensor body.

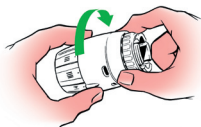

3. Press the sensor firmly onto the valve. Sensor horizontal: ensuring that the scale pointer is at top. Sensor vertical: ensuring that the scale pointer is at the front.

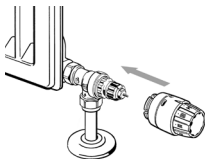

4. Whilst holding the sensor firmly on the valve secure connection by turning union nut clock-wise by hand.

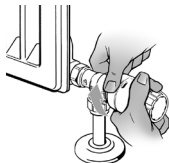

5. Whilst still holding the sensor firmly on the valve fully tighten grey union nut using parrot nose pliers.



6. Set desired room temperature.

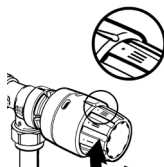

## Removing the Sensor

Turn the sensor to max. position turn union nut anti-clockwise to release locking mechanism (4). The sensor can now be separated from the valve.

# User Guide

## Setting the desired room temperatures

The desired room temperature is set by turning the head. The temperatures obtained are approximately:

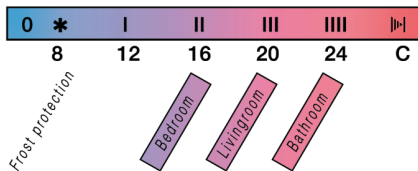

## Do not cover the thermostat

The thermostat opens and closes as determined by the temperature around it. Therefore the sensor must never be hidden behind thick curtains, furniture, etc. Alternatively a thermostat with remote sensor should be used.

## Positive SHUT-OFF feature:

The head can be turned past the \* setting (a slight resistance will be felt) to setting "0" at which point the water flow is shut off completely. After also shutting the lockshield valve the radiator may be drained and removed for maintenance and decoration purposes.

Lockshield valve (type RLV-D) is only included in codes: 013G6005, 013G6006, 013G6007.



Removal of protective cap

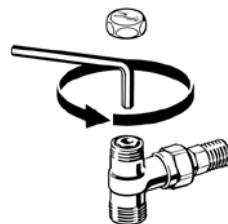

Balancing



## What is a thermostatic radiator valve (TRV)?

... an explanation for householders.

TRVs sense the air temperature around them and regulate the flow of water through the radiator which they are fitted to. They do not control the boiler.

They should be set at a level that gives you the room temperature you want. These settings may have to be different in each room, and you should set the TRVs to suit each room and then leave them to do their job.

Turning a TRV to a higher setting will not make the room heat up any faster. How quickly the room heats up depends on the boiler size and setting, and the radiator size. Turning a TRV to a lower setting will result in the room being controlled at a lower temperature, and saves energy.

TRVs need a free flow of air to sense the temperature, so they must not be covered by curtains or blocked by furniture.

TRVs cannot turn off the boiler when the whole house is warm. To do that, you will need a room thermostat as well. The radiator in the room with the room thermostat should not normally have a TRV, but, if it does, keep the TRV on the maximum setting and adjust the room thermostat as explained with the instructions.