



Professional Price List

Effective from 1st January 2017

For expert advice or to purchase, please contact our Customer Service Team on +44 (0) 1254 775111. Alternatively, we can be contacted via email at sales@shawsofdarwen.com or by fax on +44 (0) 1254 873462.

BELFAST

BS0100010	18"						
(mm)	A:460	B:380	C:205	D:390	E:310	F:165	
(Inches)	A:18	B:15	C:8	D:15	E:12	F:6	
BS0200010	21"						
(mm)	A:535	B:410	C:205	D:465	E:340	F:165	
(Inches)	A:21	B:16	C:8	D:18	E:13	F:6	
BS0300010	24"						
(mm)	A:610	B:410	C:205	D:540	E:340	F:165	
(Inches)	A:24	B:16	C:8	D:21	E:13	F:6	
BS0800010	Metric						
(mm)	A:595	B:460	C:255	D:540	E:380	F:220	
(Inches)	A:24	B:18	C:10	D:21	E:15	F:8	
BS0400010	24" (Deep)						
(mm)	A:610	B:410	C:255	D:540	E:340	F:220	
(Inches)	A:24	B:16	C:10	D:21	E:13	F:8	
BS0600010	30"						
(mm)	A:760	B:460	C:255	D:690	E:380	F:220	
(Inches)	A:30	B:18	C:10	D:27	E:15	F:8	
BS0700010	36"						
(mm)	A:915	B:460	C:255	D:840	E:380	F:220	
(Inches)	A:36	B:18	C:10	D:33	E:15	F:8	

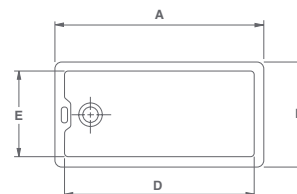

CLEANER

CL0300010	18" Low Back						
(mm)	A:460	B:380	C:205	D:355	E:385	F:305	
(Inches)	A:18	B:15	C:8	D:14	E:15	F:12	
CL0200010	20" Low Back						
(mm)	A:510	B:380	C:230	D:380	E:435	F:305	
(Inches)	A:20	B:15	C:9	D:15	E:17	F:12	
CL0100010	20" High Back						
(mm)	A:510	B:380	C:230	D:535	E:435	F:305	
(Inches)	A:20	B:15	C:9	D:21	E:17	F:12	

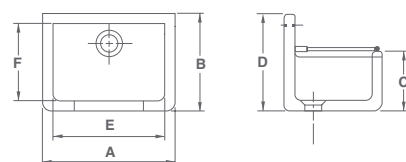

LABORATORY

LB0100010	Type 1						
(mm)	A:360	B:280	C:178	D:280	E:200		
(Inches)	A:14	B:11	C:7	D:11	E:8		
LB0200010	Type 2						
(mm)	A:330	B:330	C:180	D:250	E:250		
(Inches)	A:13	B:13	C:7	D:10	E:10		
LB0400010	Type 3						
(mm)	A:595	B:380	C:230	D:515	E:305		
(Inches)	A:24	B:15	C:9	D:20	E:12		
LB0300010	Type 4						
(mm)	A:460	B:365	C:200	D:375	E:280		
(Inches)	A:18	B:14	C:8	D:15	E:11		

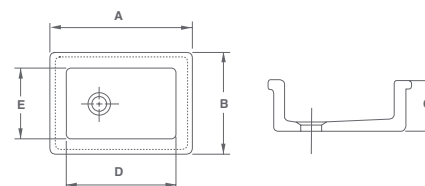

COMBINATION

CO0100010

(mm) 897 x 460 x 240
(Inches) 35 x 18 x 9½

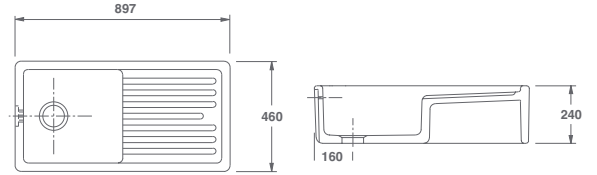

SHELF

SH0100010

(mm) 630 x 547 x 255
(Inches) 24 x 21 x 10

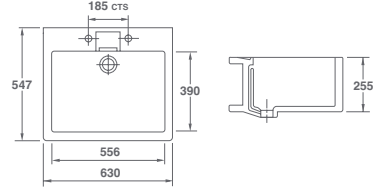

FLORIDA URINAL (Includes brackets)

FU0001TI Top Inlet

(mm) 475 x 277 x 710 (Inches) 18 x 11 x 28

SUGGESTED ACCESSORIES

FT3000035 Top Inlet Spreader

FT3000037 Waste with Connector

FU0002BI Back Inlet

(mm) 475 x 277 x 710 (Inches) 18 x 11 x 28

SUGGESTED ACCESSORIES

FT3000036 Back Inlet Spreader

FT3000037 Waste with Connector

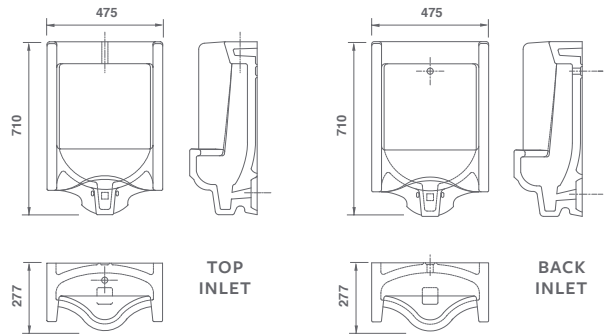

SLAB URINALS

Available as a bespoke item only. To discuss an order please call our Customer Service Team on +44 (0) 1254 775 111

DRAINERS

CD0200010 Small

(mm) 460 x 460 x 50
(Inches) 18 x 18 x 2

SO2900010 Large

(mm) 610 x 460 x 50
(Inches) 24 x 18 x 2

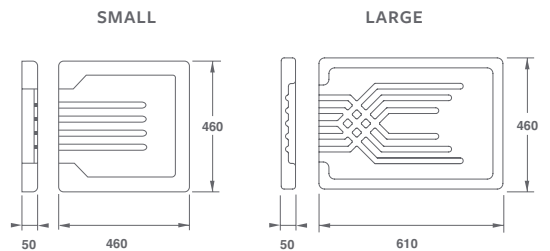

LEGS & BRACKETS

FT0100001 Cleaner

(mm) 355 x 352 x 22
(Inches) 14 x 12 x 1

FT0100002 Belfast

(mm) 406 x 652 x 22
(Inches) 16 x 25 x 1

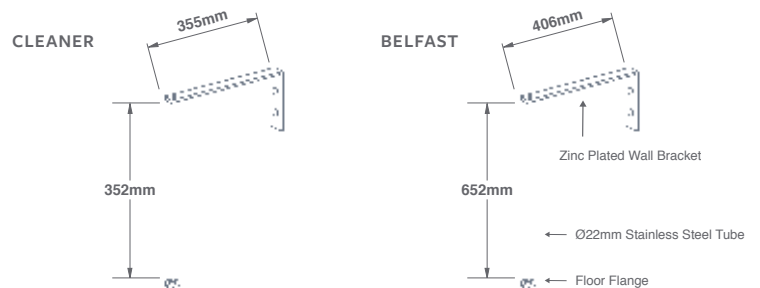

ACCESSORIES

FT8000003 Vulcathene Waste (Slotted)

38mm / 1½"

FT8000002 Vulcathene Waste (Unslotted)

38mm / 1½"

FT8000001 Vulcathene Bottle Trap

38mm / 1½"

FT2100013 1½" Slotted Waste Fitting

38mm / 1½"



FT8000002 / 03



FT8000001



FT2100013