

CT FORCE RANGE

Salamander Pumps 

A new high quality range of brass ended regenerative shower pumps from Salamander. Available as twin or single ended, positive head or universal this range is ideal for boosting hot and/or cold supplies to thermostatic or manual mixer valves, supplying a wide range of shower types and shower heads, individual taps, cisterns and whole house boosting applications.



Features

- Brass ended regenerative pump
 - 1.5, 2.0 and 3.0 Bar performance options
 - Crossover Technology
 - Compact exclusive shaft seal
 - Continuously rated
 - Fully automatic
 - 22mm push fit flexible hoses with integral isolating valves on inlets
 - Pre-wired with 1.5 metre power cable
 - Anti-vibration feet
 - Brass Impeller
 - Patent Protected
 - 5 year warranty
-
- **UK Specification:** Supplied with 22 to 15mm pushfit x 3/4" anti-vibration flexible hoses with integral isolating valves.
 - **ROI Specification:** Supplied with 21 to 15mm pushfit x 3/4" anti-vibration flexible hoses with integral isolating valves.

Pressure vs Flow

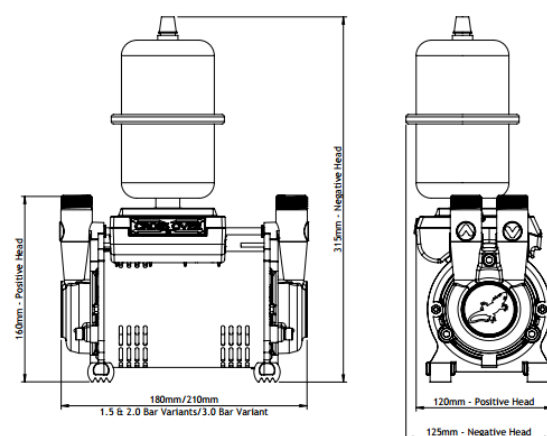
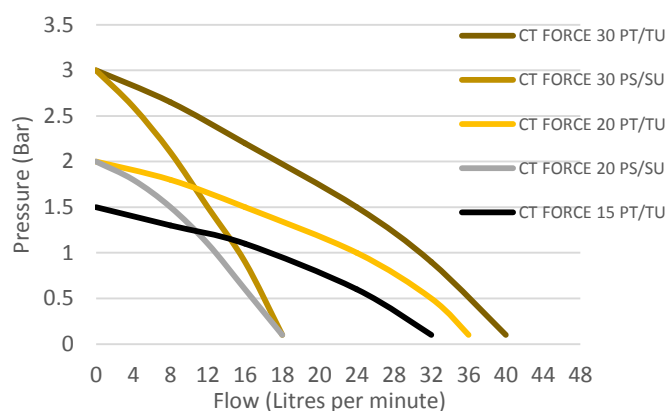

We're here to help before, during and after installation. Get in touch for guidance by calling our Pumpwise team or email tech@salamanderpumps.co.uk

Pumpwise
0191 516 2002

CT FORCE Technical Specification

Pump Model		CT FORCE 15 PT/TU	CT FORCE 20 PT/TU	CT FORCE 30 PT/TU	CT FORCE 20 PS/SU	CT FORCE 30 PS/SU
General	Guarantee	5 years				
	WRAS approval	1210047				
Features	Pump Type	Regenerative				
	Mechanical seal	Nitrile/ Carbon/ Ceramic				
	Anti-vibration feet	✓	✓	✓	✓	✓
	Inlet Isolator(s)	✓	✓	✓	✓	✓
	Flexible Hoses	4	4	4	2	2
Performance	Pressure @ 16lpm (8lpm singles)	1.1 Bar	1.5 Bar	2.2 Bar	1.5 Bar	2.1 Bar
	Pressure @ 8lpm (4lpm singles)	1.3 Bar	1.8 Bar	2.6 Bar	1.8 Bar	2.6 Bar
	Pressure @ Closed Head	1.5 Bar	2.0 Bar	3.0 Bar	2.0 Bar	3.0 Bar
	Maximum Water Temperature	65°C				
	Pressure Vessel Air Pre-Charge	22 psi	28 psi	32 psi	28 psi	32 psi
Connections	Pump connections	¾" BSP				
Flexible hoses	Connections (UK Model)	¾" Female x 22mm Push-Fit x 280mm long, isolating valves on all hoses				
	Connections (ROI Model)	¾" Female x 21mm Push-Fit x 280mm long, isolating valves on all hoses				
Motor	Type	A.C Induction Motor				
	Duty Rating	Continuously Rated				
Electrical	Power supply	230 V				
	Current (full load)	1.95 Amps	2.24 Amps	2.9 Amps	1.25 Amps	1.9 Amps
	Power consumption	457 Watts	531 Watts	690 Watts	304 Watts	410 Watts
	Fuse rating	3 Amps				
	Power cable (pre-wired)	1.5 metres				
Physical	Enclosure Protection (IP Rating)	IPX2				
	Length	180mm	210mm	183mm	213mm	
	Width	120/125mm				
	Height (Excluding Hoses)	160mm/315mm				
	Weight (Excluding Hoses)	4.96/5.53 kg	4.97/5.57 kg	6.22/6.79 kg	4.33/4.96 kg	5.61/6.20 kg

Why Choose a CT **FORCE**?



SOLID STATE SWITCHING

Solid State Switching is the reliable and robust pump activation system used within our products. Where many other shower pump designs rely upon moving parts to activate their pumps, the new Solid State Switching (S3) from Salamander uses an electronic switch that has no moving parts, thus improving reliability, sensitivity, and product life.



NOISE/VIBRATION REDUCTION

Noise/Vibration Reduction has been achieved in Salamander products through design innovation. This includes noise and vibration reducing feet which work in alignment with the natural vibration of the motor. Also, the materials used in the integrated end shield within the pump (MPI) are capable of dampening the vibration of the rotating parts reducing the noise even further.



MOTOR PUMP INTEGRATION



Patent GB2465392B protects Salamanders design of an efficient waterway which combines to create an integrated volute and motor mounting. This makes the pump a lot more compact in size. This means that it is able to be operated in smaller areas and is easily repositioned for installers to fit in tight spaces.



CROSSOVER

Cleverly designed bypass technology which is tight to the pump this adds neatness to the product. The bypass is not loose this gives the water a quicker, efficient and more direct route to pass through both sides of the pump.

FR8 SEAL

Salamanders exclusive compact PTFE seal which eliminates shaft seal stiction and mechanical seal leakage. This prolongs the life of the product and ensures that the owner of the pump has an ultra-efficient product.

PRESSURE VESSEL - UNIVERSAL MODELS

The position in which our pressure vessel is mounted on our universal pumps means that our pump remains compact unlike that of our competitors this offers installers the opportunity to fit our products into tight small spaces. This position is also integral to our crossover technology.