



www.roman-showers.com



At the heart of Roman is the desire to be the best.

It is Roman's vision to lead and innovate in the Showering industry.

To design and manufacture top quality inspirational showering solutions,
which offers choice for all markets.

To expertly manufacture our products in Britain, so they are designed and built to last and offer a lifetime of effortless showering for all. It is our aim to give all our customers exceptional value and service; this ethos runs throughout the culture of the business and cannot be imitated.

“ Great brands always balance
identity, integrity and efficiency. ”
- Matteo Ferrara



Who we are

ROMAN has been designing and manufacturing showering solutions for over 35 years, and is home to the UK's largest shower manufacturing plant. All Roman products are designed and created in Britain, offering the ultimate in quality, precision and craftsmanship. Roman's diverse and versatile collection of products encompasses something for every style and shape bathroom – no matter what the budget.

Highest Quality Materials

Roman only use the finest quality of materials to guarantee unsurpassed quality and certainty in our manufacturing process, ensuring all of our products reach exceptional levels of style and performance. We carefully fabricate and anodise all our aluminium profiles. We use aluminium because it is; light, strong and requires minimal maintenance. The anodising process increases corrosion resistance, product durability and further enhances the material properties. Our specialist anodising offers a bright chrome like finish which is significantly in excess of standard aluminium finishing.

Roman Stone shower trays are manufactured from solid surface and are inherently anti-slip and carry the highest national standard of DIN. Roman's Anti-Slip shower trays combine luxury and durability and add value to the shower tray market.

Glass

All our enclosures feature toughened safety glass. This is a heat treatment to increase the glass strength to make it around 5 times stronger than normal glass. If the glass were to break due to impact, it would shatter into lots of small pieces which are much less dangerous and will help you avoid any cuts or injury. All glass is strictly tested in accordance with EN14428.

Products Designed for All

Innovation and exceptional product design differentiates Roman from the competition. Our products are carefully designed for all. We consider different users' needs to give totally effortless entry to the entire family. Whether you would like door-less entry, level access, handles that can be used with a flat hand, or a wider aperture, we have something that will work with your space all finished with a stylish designer look.

Customer Service

Roman has an in-house customer support network, who are there to offer advice and support for each purchase at every stage; from initial enquiry through to after sales care advice. Roman employs over 20 full time members of staff in our Customer Support Centre and over 40 Technical Service Representatives nationwide who all receive comprehensive training on the manufacture and installation of Roman's collection of products.

Branding

Roman is a reputable and well established UK Brand, now supplying showering products all over the World. Our foundations are strongly rooted in; innovative design, manufacture, quality and customer service. Roman has achieved the leading position in the Market place by consistent and creative product innovation and has produced growth across all UK Market sectors and strong growth in 55 International Markets. Our products are used in some of the finest hotels Worldwide.



Award winning

Product Design & Innovation

Innovation and exceptional product design differentiates Roman from the competition. Our products and ranges have won multiple awards including The Queens Award for Enterprise - International Trade, in 2017.

We have also been identified as one of London Stock Exchange's 1000 Companies to Inspire Britain. We are extremely proud to be recognised as one of the UK's fastest growing and most dynamic small and medium sized businesses.

Roman is included in the FT1000, which is the list of Europe's Fastest Growing Companies, compiled by the Financial Times. We have also been awarded the Bathroom Safety Compliance Award 2018 by the NHIC.



Trust

Buy with confidence

All Roman products are designed and created specifically for the UK showering market, offering the ultimate in quality, precision and craftsmanship. All Roman's manufacturing processes are carried out at our UK Manufacturing Plant and Headquarters and meet and exceed approved UK and European testing standards.

For complete peace of mind, all Roman Shower Enclosures and Bath Screens are accompanied by a fully service backed Truelife Lifetime Guarantee.

For project applications Roman products are available as a BIM file download from:

www.roman-showers/available-downloads.com



Inspiration

Helping you to design your bathroom

Roman products are available on the Virtual Worlds design service. For more information contact Roman Customer Relations 01325 328033

Making your product selection easier. Roman products are available on EQ software. For more information contact Customer Relations on 01325 328033.



Protection

All glass pre-coated

All Roman's enclosures and bath screens are pre-coated with Roman Ultra Care, our own unique glass protection system. (For full details see page 148)

All Roman products are designed and manufactured to present easy cleaning ability to ensure your Roman showering experience lasts for many years.



Roman have an ongoing policy of design, development and improvement and thus reserve the right to modify specification, ranges and prices without prior notice. Images are for illustration purposes only - please refer to your retailer as site conditions will vary or contact Roman Customer Relations on 01325 328033 for installation specifications.

Door Styles

Quadrant

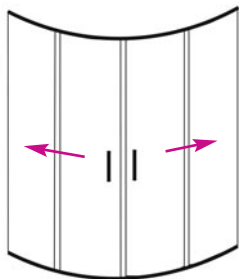

The Quadrant shaped enclosure will sit beautifully in the corner of your bathroom, making it an ideal solution for the smaller bathroom. It incorporates unobtrusive sliding doors.

Sliding Door

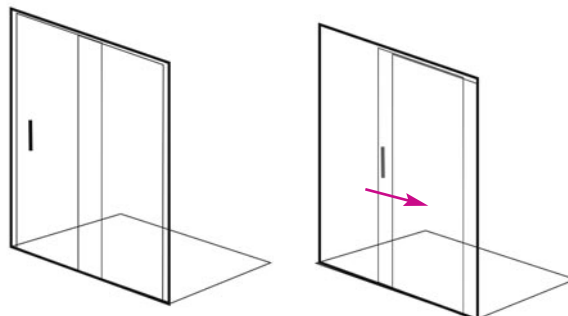

The sliding door action offers wide and easy access, with no protrusion into the bathroom or showering area.

Neo-Angle

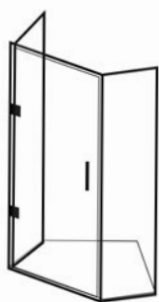

This flexible design allows for inward or outward opening door entry. It presents a unique footprint, to work around existing fixtures and fittings.

Bi-Fold Door

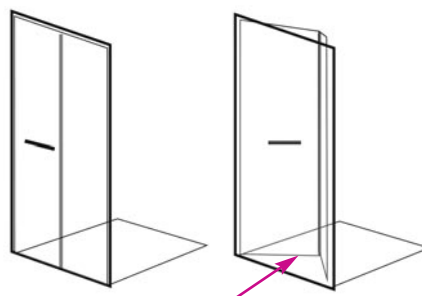

Inward opening door presents a flexible space saving solution. Avoids existing fixtures and fittings in the bathroom area.

Pivot and In-Swing Doors

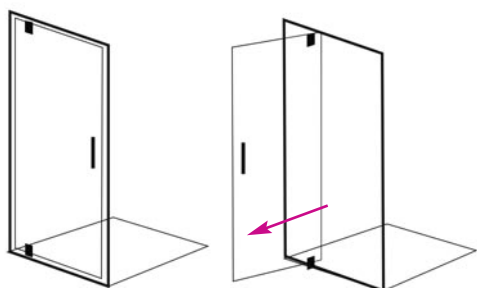

Outward opening door, takes up minimal external space due to the positioning of the hinge point, meaning it protrudes less into the bathroom space.

Hinged Door

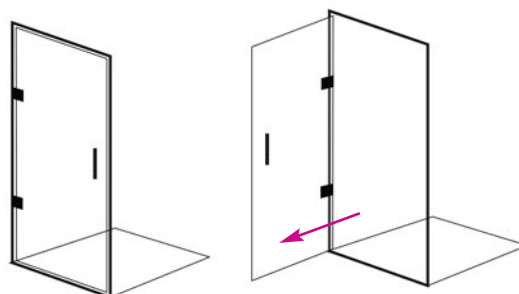

Smooth outward opening door, featuring soft self-close hinges for a superior finish.

For Wetroom Panel styles see pages 96 - 119

Contents

Decem

10mm Sheer Luxury

Pages 8 - 35

Liberty

8mm & 10mm Frameless Hinged and Sliding

Pages 36 - 53

Innov8

8mm Frameless Pivoting and Bi-Fold

Pages 54 - 63

Lumin8

8mm Semi-Frameless

Pages 64 - 79

Embrace

6mm & 8mm Semi-Frameless

Pages 80 - 91

Collage

4mm & 6mm Framed

Pages 92 - 95

Wetrooms

including Select Panels

8mm and 10mm Glass Options

Pages 96 - 119

Shower Trays

Pages 120 - 129

Bath Screens

Pages 130 - 143

Accessories and Product After Care

Pages 144 - 149

Bespoke Service

Page 150

Guarantee Information

Pages 151

10mm Decem

- Sliding Door Enclosures
- Hinged Door Enclosures
- Neo-Angle Enclosures
- Walk-in Enclosures
- Victoriana Glass Design
- Wetroom Panels
- Hinged Bath Screen

Latin for 10, the Decem 10mm thick glass range is the ultimate in showering design.

The Decem range has been meticulously designed and engineered by our Roman Design experts.

Components of the highest quality have been brought together. With 10mm thick toughened glass. Chromed brass hardware with self-closing hinges that offer a superior action and create a positive seal for the door. Made from chromed brass components to give a quality finish and long lasting performance.

Our unique Water Safe System has been engineered to offer the maximum water integrity available for a minimalist designed enclosure. The system will guide the water back into your showering area, to enhance performance.

“ There are three responses to a piece of design – yes, no and Wow!
Wow is the one to aim for. ”

- Milton Glaser



Sliding Door



1200 Alcove Fitting

- Left hand Door DXT12AL
- Grey Shimmer Infinity Shower Tray IAG129G

“Create a luxury showering space with this stunningly visual and superior sliding door function.”



1700 x 800 Corner Fitting

- Left hand Door DXT17L and Side Panel DX2R8
- Shower Tray RLT178
- Shower Basket RSB01



Left Hand



Right Hand

GLASS THICKNESS
10
Millimetres

TOTAL HEIGHT
2020
Millimetres

GLASS PROTECTION
ULTRA CARE
BY ROMAN

TRUELIFE
LIFETIME
GUARANTEE

Features and Benefits:

- Wall profile height 2000mm
- Height to top of door glass 2020mm
- Silent and ultra-smooth running roller bearing system
- Luxury 'soft close' door system
- Chromed brass machined components
- Chromed brass feature handle
- Low profile PVC seals
- Bright silver frame
- 15mm of adjustment in each profile
- Roman Water Safe System to tray or floor
- Please indicate handing (RH or LH) when ordering
- Available with square hardware



Square Hardware



Corner Fitting

Enclosure Size (mm)	Handing	Adjustment (mm)	Door Aperture (mm)	Door Code	Side Panel Code
1200 x 800	Left Hand	1165 - 1180 & 765 - 780	418	DXT12L	DX2R8
1200 x 800	Right Hand	1165 - 1180 & 765 - 780	418	DXT12R	DX2R8
1200 x 900	Left Hand	1165 - 1180 & 865 - 880	418	DXT12L	DX2R9
1200 x 900	Right Hand	1165 - 1180 & 865 - 880	418	DXT12R	DX2R9
1400 x 800	Left Hand	1365 - 1380 & 765 - 780	518	DXT14L	DX2R8
1400 x 800	Right Hand	1365 - 1380 & 765 - 780	518	DXT14R	DX2R8
1400 x 900	Left Hand	1365 - 1380 & 865 - 880	518	DXT14L	DX2R9
1400 x 900	Right Hand	1365 - 1380 & 865 - 880	518	DXT14R	DX2R9
1700 x 800	Left Hand	1665 - 1680 & 765 - 780	668	DXT17L	DX2R8
1700 x 800	Right Hand	1665 - 1680 & 765 - 780	668	DXT17R	DX2R8

Alcove Fitting

Enclosure Size (mm)	Handing	Adjustment (mm)	Door Aperture (mm)	Door Code
1200	Left Hand	1165 - 1190	430	DXT12AL
1200	Right Hand	1165 - 1190	430	DXT12AR
1400	Left Hand	1365 - 1390	530	DXT14AL
1400	Right Hand	1365 - 1390	530	DXT14AR
1700	Left Hand	1665 - 1690	680	DXT17AL
1700	Right Hand	1665 - 1690	680	DXT17AR

Left or Right Handed must be specified

Compatible Trays:	Page
Roman Anti-Slip Trays	122 - 123
Roman Infinity Trays	124 - 125
Roman Low Level Trays	128 - 129
Roman Shield System	147

Decem

Sliding Door

with finger pull handle



1700 x 800 Corner fitting

- Left hand door DXT17FL and Side Panel DX2R8
- Roman Low Level Tray RLT178
- Shower Basket RSB01

“Luxury cushioned close door operation.”

GLASS THICKNESS
10
Millimetres

TOTAL HEIGHT
2020
Millimetres

GLASS PROTECTION
ULTRA CARE
BY ROMAN

TRUELIFE
LIFETIME GUARANTEE

Features and Benefits:

- Wall profile height 2000mm
- Height to top of door glass 2020mm
- Silent and ultra-smooth running roller bearing system
- Luxury 'soft close' door system
- Chromed brass machined components
- Chromed brass finger pull handle
- Low profile PVC seals
- Bright silver frame
- 15mm of adjustment in each profile
- Roman Water Safe System to tray or floor
- Alcove and corner options
- Please indicate handing (RH or LH) when ordering

Both handle options supplied as standard



Finger Pull

Easy Grip

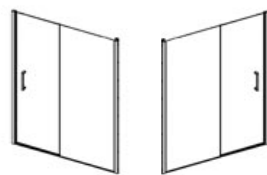

Left Hand

Right Hand

1700 Alcove Fitting

- Left hand door DXT17AFL
- Roman Low Level Tray RLT178
- Shower Basket RSB05

Corner Fitting

Enclosure Size (mm)	Handing	Adjustment (mm)	Door Aperture (mm)	Door Code	Side Panel Code
1200 x 800	Left Hand	1165 - 1180 & 765 - 780	418	DXT12FL	DX2R8
1200 x 800	Right Hand	1165 - 1180 & 765 - 780	418	DXT12FR	DX2R8
1200 x 900	Left Hand	1165 - 1180 & 865 - 880	418	DXT12FL	DX2R9
1200 x 900	Right Hand	1165 - 1180 & 865 - 880	418	DXT12FR	DX2R9
1400 x 800	Left Hand	1365 - 1380 & 765 - 780	518	DXT14FL	DX2R8
1400 x 800	Right Hand	1365 - 1380 & 765 - 780	518	DXT14FR	DX2R8
1400 x 900	Left Hand	1365 - 1380 & 865 - 880	518	DXT14FL	DX2R9
1400 x 900	Right Hand	1365 - 1380 & 865 - 880	518	DXT14FR	DX2R9
1700 x 800	Left Hand	1665 - 1680 & 765 - 780	668	DXT17FL	DX2R8
1700 x 800	Right Hand	1665 - 1680 & 765 - 780	668	DXT17FR	DX2R8

Alcove Fitting

Enclosure Size (mm)	Handing	Adjustment (mm)	Door Aperture (mm)	Door Code
1200	Left Hand	1165 - 1190	430	DXT12AFL
1200	Right Hand	1165 - 1190	430	DXT12AFR
1400	Left Hand	1365 - 1390	530	DXT14AFL
1400	Right Hand	1365 - 1390	530	DXT14AFR
1700	Left Hand	1665 - 1690	680	DXT17AFL
1700	Right Hand	1665 - 1690	680	DXT17AFR

Left or Right Handed must be specified

Compatible Trays:	Page
Roman Anti-Slip Trays	122 - 123
Roman Infinity Trays	124 - 125
Roman Low Level Trays	128 - 129
Roman Shield System	147

Level Access Sliding Door

with finger pull handle



1200 Alcove Fitting

- Left hand Door with Finger Pull handle option DXTLE12AFL
- 1200 x 900 Black Shimmer Infinity Tray IAG129B

“Install with a Roman Anti-Slip Shower Tray
for a totally inclusive showering solution”



1700 x 800 Corner Fitting

- Left Hand Door with Easy Grip Handle DXTLE17CFL and Side Panel DX2R8
- 1700 x 800 Gloss White Infinity Tray IAG178

GLASS THICKNESS
10
Millimetres

TOTAL HEIGHT
2020
Millimetres

GLASS PROTECTION
ULTRA CARE
BY ROMAN

TRUELIFE
LIFETIME GUARANTEE

Features and Benefits:

- Wall profile height 2000mm
- Height to top of door glass 2020mm
- Quick release door function for easy cleaning
- 15mm of adjustment in each wall profile
- Optional aluminium water guard
- Barrier free entry option
- Silent and ultra-smooth running roller bearing system
- Luxury 'soft close' door system
- Chromed brass machined components
- Chromed brass finger pull handle
- Low profile PVC seals
- Bright silver frame
- Alcove and corner options
- Please indicate handing (RH or LH) when ordering

Both handle options supplied as standard



Finger Pull



Easy Grip

Corner Fitting

Enclosure Size (mm)	Handing	Adjustment (mm)	Door Aperture (mm)	Door Code	Side Panel Code
1200 x 800	Left Hand	1165 - 1180 & 765 - 780	418	DXTLE12CFL	DX2R8
1200 x 800	Right Hand	1165 - 1180 & 765 - 780	418	DXTLE12CFR	DX2R8
1200 x 900	Left Hand	1165 - 1180 & 865 - 880	418	DXTLE12CFL	DX2R9
1200 x 900	Right Hand	1165 - 1180 & 865 - 880	418	DXTLE12CFR	DX2R9
1400 x 800	Left Hand	1365 - 1380 & 765 - 780	518	DXTLE14CFL	DX2R8
1400 x 800	Right Hand	1365 - 1380 & 765 - 780	518	DXTLE14CFR	DX2R8
1400 x 900	Left Hand	1365 - 1380 & 865 - 880	518	DXTLE14CFL	DX2R9
1400 x 900	Right Hand	1365 - 1380 & 865 - 880	518	DXTLE14CFR	DX2R9
1700 x 800	Left Hand	1665 - 1680 & 765 - 780	668	DXTLE17CFL	DX2R8
1700 x 800	Right Hand	1665 - 1680 & 765 - 780	668	DXTLE17CFR	DX2R8

Alcove Fitting

Enclosure Size (mm)	Handing	Adjustment (mm)	Door Aperture (mm)	Door Code
1200	Left Hand	1160 - 1190	430	DXTLE12AFL
1200	Right Hand	1160 - 1190	430	DXTLE12AFR
1400	Left Hand	1360 - 1390	530	DXTLE14AFL
1400	Right Hand	1360 - 1390	530	DXTLE14AFR
1700	Left Hand	1660 - 1690	680	DXTLE17AFL
1700	Right Hand	1660 - 1690	680	DXTLE17AFR

Left or Right Handed must be specified

Compatible Trays:	Page
Roman Anti-Slip Trays	122 - 123
Roman Infinity Trays	124 - 125
Roman Low Level Trays	128 - 129
Roman Shield System	147

Decem

Hinged Door

Outward Opening



900 x 900 Corner Fitting

- Door DXL9CA
- Side Panel DXR9
- Roman Low Level Tray RLT9
- Shower Basket RSB07

“ Integrated Water Safe System for unparalleled water integrity. ”



900 Alcove Fitting

- Door DXL9B
- Roman Low Level Tray RLT79
- Shower Basket RSB07

GLASS THICKNESS
10
Millimetres

TOTAL HEIGHT
2000
Millimetres

REVERSIBLE

GLASS PROTECTION
ULTRA CARE
BY ROMAN

TRUELIFE

LIFETIME GUARANTEE

Features and Benefits:

- Self-closing hinges
- Choice of curved or square chromed brass handle and hinges
- Bracing bar for optional usage supplied as standard with corner option
- Integrated 'tray or floor' Water Safe System
- Suitable for installation onto tray or wetroom floor
- 15mm of adjustment in each minimal wall profile for easy installation
- All door and panel sizes are interchangeable to create the enclosure size of your choice



Curved Hardware - A



Square Hardware - B

Please add **A** for Curved Hardware or add **B** for Square hardware to the door code when ordering

Corner Fitting

Size (mm)	Description	Adjustment (mm)	Door Aperture (mm)	Code
760	Door	725 - 740	630	DXL76C
800	Door	765 - 780	670	DXL8C
900	Door	865 - 880	770	DXL9C
1000	Door	965 - 980	870	DXL10C
760	Side Panel	725 - 740	-	DXR76
800	Side Panel	765 - 780	-	DXR8
900	Side Panel	865 - 880	-	DXR9
1000	Side Panel	965 - 980	-	DXR10

Alcove Fitting

Door Size (mm)	Adjustment (mm)	Door Code	In-Line Panel Code
760	720 - 750	710	DXL76
800	760 - 790	750	DXL8
900	860 - 890	850	DXL9
1000	960 - 990	950	DXL10

Compatible Trays:	Page
Roman Anti-Slip Trays	122 - 123
Roman Infinity Trays	124 - 125
Roman Low Level Trays	128 - 129
Roman Shield System	147

Decem

Hinged Door

with one in-line panel

Outward Opening



1200 Alcove Fitting

- Door DXL1HDB
- In-Line Panel DXL1H12
- Roman Low Level Tray RLT129
- Shower Basket RSB07

“Frameless and minimalist design”

GLASS THICKNESS
10
Millimetres

TOTAL HEIGHT
2030
Millimetres



GLASS PROTECTION
ULTRA CARE
BY ROMAN

TRUETIME
LIFETIME
GUARANTEE

Features and Benefits:

- Glass height 2000mm
- Total height with brace bar 2030mm
- Self-closing hinges
- Decem bracing bar for optional usage supplied as standard
- Integrated 'tray or floor' Water Safe System
- Suitable for installation onto tray or wetroom floor
- 15mm of adjustment in each minimal wall profile for easy installation
- Door aperture 630mm
- Additional optional panel bracing is available



Please add **A** for Curved Hardware or add **B** for Square hardware to the door code when ordering



900 x 1200 Corner Fitting

- Door DXL1HDRA
- Side Panel DXHR9
- In-Line Panel DXL1HR12
- Roman Low Level Tray RLT129
- Shower Basket RSB07

Please note: Door aperture/projection is 630mm approx. - enclosure size required is achieved by size of In-Line and Side Panels (this is reflected in Order Codes).

Corner Fitting

Door aperture 630mm

Enclosure Size (mm)	Adjustment (mm)	Door Code	In-Line Panel Code	Side Panel Code
1000 x 800	965 - 980 & 765 - 780	DXL1HDR	DXL1HR10	DXHR8
1000 x 900	965 - 980 & 865 - 880	DXL1HDR	DXL1HR10	DXHR9
1200 x 800	1165 - 1180 & 765 - 780	DXL1HDR	DXL1HR12	DXHR8
1200 x 900	1165 - 1180 & 865 - 880	DXL1HDR	DXL1HR12	DXHR9
1400 x 800	1365 - 1380 & 765 - 780	DXL1HDR	DXL1HR14	DXHR8
1400 x 900	1365 - 1380 & 865 - 880	DXL1HDR	DXL1HR14	DXHR9
1500 x 800	1465 - 1480 & 765 - 780	DXL1HDR	DXL1HR15	DXHR8
1500 x 900	1465 - 1480 & 865 - 880	DXL1HDR	DXL1HR15	DXHR9
1600 x 800	1565 - 1580 & 765 - 780	DXL1HDR	DXL1HR16	DXHR8
1600 x 900	1565 - 1580 & 865 - 880	DXL1HDR	DXL1HR16	DXHR9
1700 x 800	1665 - 1580 & 765 - 780	DXL1HDR	DXL1HR17	DXHR8
1700 x 900	1665 - 1580 & 865 - 880	DXL1HDR	DXL1HR17	DXHR9

Alcove Fitting

Door aperture 630mm

Enclosure Size (mm)	Adjustment (mm)	Door Code	In-Line Panel Code
1000	960 - 990	DXL1HD	DXL1H10
1200	1160 - 1190	DXL1HD	DXL1H12
1400	1360 - 1390	DXL1HD	DXL1H14
1500	1460 - 1490	DXL1HD	DXL1H15
1600	1560 - 1590	DXL1HD	DXL1H16
1700	1660 - 1690	DXL1HD	DXL1H17

Compatible Trays:	Page
Roman Anti-Slip Trays	122 - 123
Roman Infinity Trays	124 - 125
Roman Low Level Trays	128 - 129
Roman Shield System	147

Decem

Hinged Door

with in-line panel and finger pull handle

Inward Opening



1500 x 800 Alcove Fitting

- Door DXL1HD2FB
- In-Line Panel DXL1H15
- Roman Low Level Tray RLT158
- Shower Basket RSB02

“ For when you prefer an inward opening door ”



1500 x 800 Corner Fitting

- Door DXL1HDR2FB
- Side Panel DXHR8
- In-Line Panel DXL1HR15
- Roman Low Level Tray RLT158
- Shower Basket RSB02

GLASS THICKNESS
10
Millimetres

TOTAL HEIGHT
2030
Millimetres

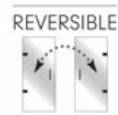

Features and Benefits:

- Glass height 2000mm
- Total height with brace bar 2030mm
- Self-closing hinges
- Square chromed brass hinges
- Finger pull handle
- Decem bracing bar for optional usage supplied as standard
- Integrated 'tray or floor' Water Safe
- 15mm of adjustment in each minimal wall profile for easy installation
- Door aperture 615mm or 515mm (check table below)
- Additional optional panel bracing is available - see pages 100 - 101

Both handle options supplied as standard



Finger Pull



Easy Grip

Please note: Enclosure size required is achieved by size of In-Line and Side Panels (this is reflected in Order Codes).

Corner Fitting

Enclosure Size (mm)	Adjustment (mm)	Door Aperture (mm)	Door Code	In-Line Panel Code	Side Panel Code
1200 x 800	1165 - 1180 & 765 - 780	515	DXL1HDRFB	DXL1HR212	DXHR8
1200 x 900	1165 - 1180 & 865 - 880	515	DXL1HDRFB	DXL1HR212	DXHR9
1400 x 800	1365 - 1380 & 765 - 780	615	DXL1HDR2FB	DXL1HR14	DXHR8
1400 x 900	1365 - 1380 & 865 - 880	615	DXL1HDR2FB	DXL1HR14	DXHR9
1500 x 800	1465 - 1480 & 765 - 780	615	DXL1HDR2FB	DXL1HR15	DXHR8
1500 x 900	1465 - 1480 & 865 - 880	615	DXL1HDR2FB	DXL1HR15	DXHR9
1600 x 800	1565 - 1580 & 765 - 780	615	DXL1HDR2FB	DXL1HR16	DXHR8
1600 x 900	1565 - 1580 & 865 - 880	615	DXL1HDR2FB	DXL1HR16	DXHR9
1700 x 800	1665 - 1680 & 765 - 780	615	DXL1HDR2FB	DXL1HR17	DXHR8
1700 x 900	1665 - 1680 & 865 - 880	615	DXL1HDR2FB	DXL1HR17	DXHR9

Alcove Fitting

Enclosure Size (mm)	Adjustment (mm)	Door Aperture (mm)	Door Code	In-Line Panel Code
1200	1160 - 1190	515	DXL1HDFB	DXL1H212
1400	1360 - 1390	615	DXL1HD2FB	DXL1H14
1500	1460 - 1490	615	DXL1HD2FB	DXL1H15
1600	1560 - 1590	615	DXL1HD2FB	DXL1H16
1700	1660 - 1690	615	DXL1HD2FB	DXL1H17

Compatible Trays:	Page
Roman Anti-Slip Trays	122 - 123
Roman Infinity Trays	124 - 125
Roman Low Level Trays	128 - 129
Roman Shield System	147

Decem

Hinged Door

with two in-line panels

Outward Opening



1200 x 800 Corner Fitting

- Hinged Door DXLHDRA
- In-Line Panel DXLHR12
- Side Panel DXHR8
- Roman Low Level Tray RLT128
- Shower Basket RSB01

“ Create your individual bathroom space
with a choice of hardware available ”



1200 Alcove Fitting

- Door DXLHDB
- In-Line Panel DXLH12
- Roman Low Level RLT129
- Shower Basket RSB02

GLASS THICKNESS
10
Millimetres

TOTAL HEIGHT
2030
Millimetres

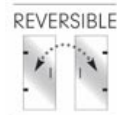

Features and Benefits:

- Glass height 2000mm
- Total height with brace bar 2030mm
- Self-closing hinges
- Choice of curved or square chromed brass handle and hinges
- Decem bracing bar for optional usage supplied as standard
- Integrated 'tray or floor' Water Safe System
- Suitable for installation onto tray or wetroom floor
- 15mm of adjustment in each minimal wall profile for easy installation
- Door aperture 650mm



Please add **A** for Curved Hardware or add **B** for Square hardware to the door code when ordering

Corner Fitting

Door aperture 650mm

Enclosure Size (mm)	Adjustment (mm)	Door Code	In-Line Panel Code	Side Panel Code
1200 x 800	1165 - 1180 & 765 - 780	DXLHDR	DXLHR12	DXHR8
1200 x 900	1165 - 1180 & 865 - 880	DXLHDR	DXLHR12	DXHR9
1400 x 800	1365 - 1380 & 765 - 780	DXLHDR	DXLHR14	DXHR8
1400 x 900	1365 - 1380 & 865 - 880	DXLHDR	DXLHR14	DXHR9
1500 x 800	1465 - 1480 & 765 - 780	DXLHDR	DXLHR15	DXHR8
1500 x 900	1465 - 1480 & 865 - 880	DXLHDR	DXLHR15	DXHR9
1600 x 800	1565 - 1580 & 765 - 780	DXLHDR	DXLHR16	DXHR8
1600 x 900	1565 - 1580 & 865 - 880	DXLHDR	DXLHR16	DXHR9

Please note: Door aperture/projection is 650mm approx - enclosure size required is achieved by size of In-Line and Side Panels (this is reflected in Order Codes). In-Line Panels are in packs of two so one order code required only.

Alcove Fitting

Door aperture 650mm

Enclosure Size (mm)	Adjustment (mm)	Door Code	In-Line Panel Code
1200	1160 - 1190	DXLHD	DXLH12
1400	1360 - 1390	DXLHD	DXLH14
1500	1460 - 1490	DXLHD	DXLH15
1600	1560 - 1590	DXLHD	DXLH16

Please note: In-Line Panels are in packs of two so one order code required only.

Compatible Trays:	Page
Roman Anti-Slip Trays	122 - 123
Roman Infinity Trays	124 - 125
Roman Low Level Trays	128 - 129
Roman Shield System	147

Decem

Hinged Door

with hinged in-line panel

Outward Opening



1200 x 900 Corner Fitting

- Hinged Door DXL2HDRA
- In-Line Panel DXL2HR12
- Side Panel DX1R9
- Roman Shield Wetroom System
- Shower Basket RSB01

“With luxury 10mm thick glass this stunning enclosure will create a luxury showering experience”



1200 Alcove Fitting

- Hinged Door DXL2HDB
- In-Line Panel DXL2H12
- Roman Low Level Tray RLT128

GLASS THICKNESS
10
Millimetres

TOTAL HEIGHT
2030
Millimetres

REVERSIBLE

GLASS PROTECTION
ULTRA CARE
BY ROMAN

TRUELIFE

LIFETIME GUARANTEE

Features and Benefits:

- Glass height 2000mm
- Total height with brace bar 2030mm
- Self-closing hinges
- Choice of curved or square chromed brass handle and hinges
- Decem bracing bar for optional usage supplied as standard
- Integrated 'tray or floor' Water Safe System
- Suitable for installation onto tray or wetroom floor
- 15mm of adjustment in each minimal wall profile for easy installation
- Door aperture: 670mm corner fitting, 650mm alcove fitting



Please add **A** for Curved Hardware or add **B** for Square hardware to the door code when ordering

Corner Fitting

Enclosure Size (mm)	Adjustment (mm)	Door Code	In-Line Panel Code	Side Panel Code
1000 x 760	965 - 980 & 725 - 740	DXL2HDR	DXL2HR10	DX1R76
1000 x 800	965 - 980 & 765 - 780	DXL2HDR	DXL2HR10	DX1R8
1000 x 900	965 - 980 & 865 - 880	DXL2HDR	DXL2HR10	DX1R9
1000 x 1000	965 - 980 & 965 - 980	DXL2HDR	DXL2HR10	DX1R10
1200 x 760	1165 - 1180 & 725 - 740	DXL2HDR	DXL2HR12	DX1R76
1200 x 800	1165 - 1180 & 765 - 780	DXL2HDR	DXL2HR12	DX1R8
1200 x 900	1165 - 1180 & 865 - 880	DXL2HDR	DXL2HR12	DX1R9
1200 x 1000	1165 - 1180 & 965 - 980	DXL2HDR	DXL2HR12	DX1R10

Alcove Fitting

Enclosure Size (mm)	Adjustment (mm)	Door Code	In-Line Panel Code
1000	960 - 990	DXL2HD	DXL2H10
1200	1160 - 1190	DXL2HD	DXL2H12

Compatible Trays:	Page
Roman Anti-Slip Trays	122 - 123
Roman Infinity Trays	124 - 125
Roman Low Level Trays	128 - 129
Roman Shield System	147

Decem

Neo Angle

enclosure

Outward Opening



1200 x 900 Neo Angle

- Neo-Angle Door DXPD8
- Neo-Angle Panels DXP129PAL
- Neo-Angle Shower Tray DNT129L
- Shower Basket RSB01

“ Ingenious angled design fits around existing fixtures and fittings ”



GLASS THICKNESS
10
Millimetres

TOTAL HEIGHT
2008
Millimetres

GLASS PROTECTION
ULTRA CARE
BY ROMAN

TRUELIFE
LIFETIME GUARANTEE

Features and Benefits:

- Wall profile height 2000mm
- Total height to top of bracing 2008mm
- Chromed brass machined components
- Chromed brass self-closing hinges and feature handle
- Low profile PVC seals
- Bright silver frame
- 15mm of adjustment in each profile
- Integrated 'tray or floor' Water Safe System
- Please indicate handing (RH or LH) when ordering
- Door always hinges from the short panel
- Suitable for installation to Neo tray or straight to floor

900 x 900 Neo Angle

- Neo-Angle Door DXPDB
- Neo-Angle Panels DXP9PAL
- Neo-Angle Shower Tray DNT9
- Shower Basket RSB02

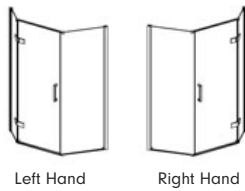

Please note: Door aperture/projection is 660mm - enclosure size required is achieved by size of Neo Panels (this is reflected in Order Codes).

Corner Fitting

Enclosure Size (mm)	Handing	Adjustment (mm)	Door Code	In-Line Panel Code
900 x 900	Left Hand	860 - 875	DXPDB	DXP9PAL
900 x 900	Right Hand	860 - 875	DXPDB	DXP9PAR
1200 x 900	Left Hand	1160 - 1175 & 860 - 875	DXPDB	DXP129PAL
1200 x 900	Right Hand	1160 - 1175 & 860 - 875	DXPDB	DXP129PAR

Neo-Angle Trays:

See page 126 for full details

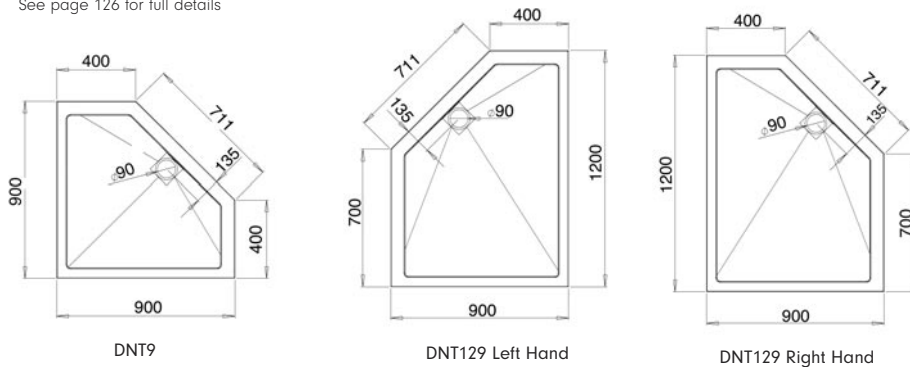

1700 Walk-in

GLASS THICKNESS
10
Millimetres

TOTAL HEIGHT
1950
Millimetres

REVERSIBLE

GLASS PROTECTION
ULTRA CARE
BY ROMAN

TRULIFE

LIFETIME GUARANTEE



Corner Fitting

Additional Features and Benefits:

- 1950mm high + 55mm if installed to dedicated Walk-in Tray
- Bright silver frame
- 10mm of adjustment in each profile

- Walk-in Enclosure with Side Panel SNG
- Walk-In Tray SN178L
- Shower Basket RSB01

“ Perfect bath replacement ”

Walk-In Enclosure

Size (mm)	Description	Aperture (mm)	Code
1700 x 800	Alcove fitting	616	SN
1700 x 800	Corner fitting with side panel	585	SNG

Solid Surface Tray

Size (mm)	Handing	Code
1700 x 800mm	Walk-In Left Hand Tray	SN178-L
1700 x 800mm	Walk-In Right Hand Tray	SN178-R

SN178-L

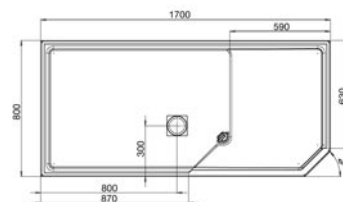

SN178-R

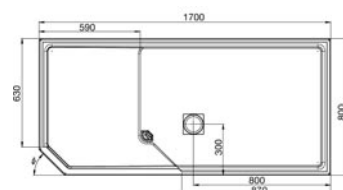



900 x 900 Hinged Door for Corner fitting (left hand)

- Hinged Door and Side Panel VXL9CB and VXR9
- Roman Shower Tray RLT9

“Elegance comes from being as beautiful inside as outside.”

- Coco Chanel

glass design

Available on selected products
See pages 30 - 31 for full details

Decem

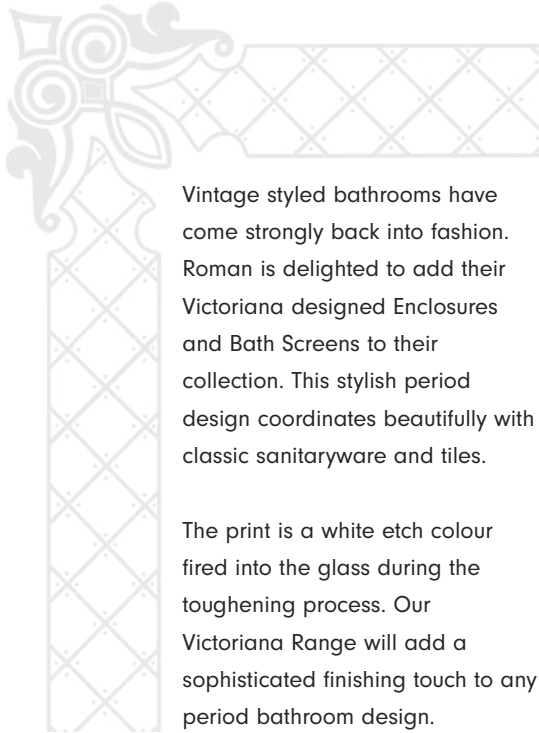

Vintage styled bathrooms have come strongly back into fashion. Roman is delighted to add their Victoriana designed Enclosures and Bath Screens to their collection. This stylish period design coordinates beautifully with classic sanitaryware and tiles.

The print is a white etch colour fired into the glass during the toughening process. Our Victoriana Range will add a sophisticated finishing touch to any period bathroom design.



1200 Wetroom Panel (left hand)

- Wetroom Panel VXFCP12

Victoriana



Hinged Door for Corner Fitting



Hinged Door for Alcove fitting



Neo Angle Enclosure



Hinged Door with In-Line Panel for Corner



Hinged Door with In-Line Panel for alcove



Wetroom Panel



Square Hardware - B



Curved Hardware - A

Please add A for Curved Hardware or add B for Square hardware to the door code when ordering

Please add **A** for Curved Hardware or add **B** for Square hardware to the door code when ordering

Hinged Door for corner fitting - see pages 16 - 17 for full product details

Enclosure Size (mm)	Adjustment (mm)	Door Code	In-Line Panel Code
900 x 900	865 - 880	VXL9C	VXR9

Hinged Door for Corner

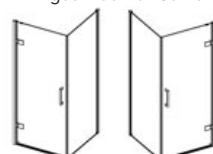

Left Hand Right Hand

Hinged Door for alcove fitting - see pages 16 - 17 for full product details

Enclosure Size (mm)	Adjustment (mm)	Door Code
900	860 - 890	VXL9

Hinged Door for Alcove



Left Hand Right Hand

Hinged Door with In-Line Panel for alcove - see pages 18 - 19 for full product details

Enclosure Size (mm)	Adjustment (mm)	Door Code	In-Line Panel Code
1000*	960 - 990	VXL1HD	VXL1H10
1200*	1160 - 1190	VXL1HD	VXL1H12
1400	1360 - 1390	VXL1HD	VXL1H14
1600	1560 - 1590	VXL1HD	VXL1H16

Hinged Door with Inline Panel for Alcove



Left Hand Right Hand

*In-line Panels on 1000 & 1200 products are clear glass for Alcove and Corner

Hinged Door with In-Line Panel for corner - see pages 18 - 19 for full product details

Enclosure Size (mm)	Adjustment (mm)	Door Code	In-Line Panel Code	Side Panel Code
1000 x 800*	965 - 980 & 765 - 780	VXL1HDR	VXL1HR10	VXHR8
1000 x 900*	965 - 980 & 865 - 880	VXL1HDR	VXL1HR10	VXHR9
1200 x 800*	1165 - 1180 & 765 - 780	VXL1HDR	VXL1HR12	VXHR8
1200 x 900*	1165 - 1180 & 865 - 880	VXL1HDR	VXL1HR12	VXHR9
1400 x 800	1365 - 1380 & 765 - 780	VXL1HDR	VXL1HR14	VXHR8
1400 x 900	1365 - 1380 & 865 - 880	VXL1HDR	VXL1HR14	VXHR9
1600 x 800	1565 - 1580 & 765 - 780	VXL1HDR	VXL1HR16	VXHR8
1600 x 900	1565 - 1580 & 865 - 880	VXL1HDR	VXL1HR16	VXHR9

Hinged Door with Inline Panel for Corner

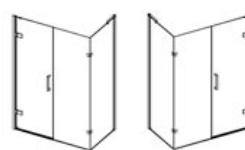

Left Hand Right Hand

*In-line Panels on 1000 & 1200 products are clear glass for Alcove and Corner

Neo Angle Enclosure - see pages 26 - 27 for full product details

Enclosure Size (mm)	Hardware Style	Adjustment (mm)	Door Code	In-Line Panel Code
900 x 900	Square only	860 - 875	VXPDB	VXP9PA
1200 x 900	Square only	1160 - 1175 & 860 - 875	VXPDB	VXP129PA

Neo Angle Enclosure



Left Hand Right Hand

N.B. 900 Neo panels are clear glass

Wetroom Panel - see pages 32 - 33 for full product details

Enclosure Size (mm)	Description	Adjustment (mm)	Panel Code
900	Exposed Fix Wetroom Panel	865 - 880	VXFCP9
1200	Exposed Fix Wetroom Panel	1165 - 1180	VXFCP12
200	Return Panel (clear glass)	+25 to above	VXFCPL2
400	Return Panel (clear glass)	+25 to above	VXFCPL4

Wet Room Panel

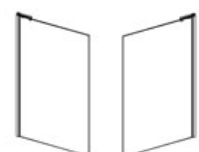

Left Hand Right Hand

PLEASE NOTE: All Victoriana products are handed due to the print of the design being on the outside of the glass so are not reversible. Please check the handing you require from the illustrations below and state left or right handing when placing your order.

Contemporary wetroom showering

A collection of opulent open plan wetroom showering options, which stand at 2000mm high with luxury 10mm thick glass. The glass panels offer the option of either a minimalist concealed fix wall profile or a contemporary exposed fix wall profile. They can be accompanied with a fixed deflector panel to increase water integrity and can be installed onto a low level shower tray or straight to floor



1200 Corner Panel with Return Panel

- Corner Panel DXFCP12
- 'L' Return Panel DXFCPL2
- Roman Shield Wetroom System
- Shower Basket RSB05

“Simplicity is the ultimate sophistication”

- Leonardo da Vinci

GLASS THICKNESS
10
Millimetres

TOTAL HEIGHT
2030
Millimetres

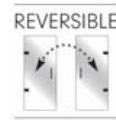

Corner Panel

Exposed Wall Profile

Features and Benefits:

- Glass Height - 2000mm
- Total Height 2030mm with brace bar
- Surface mounted profile
- Bracing bar for optional usage supplied as standard
- Suitable for installation onto tray or wetroom floor
- Optional 'L' shaped return panel
- Due to the nature of the product water integrity cannot be guaranteed - please consult your installer



1200 Corner Panel

- Corner Panel DXFCP12
- Gloss Infinity Tray IAG129
- Shower Basket RSB05



Enclosure Size (mm)	Description	Style	Adjustment (mm)	Code
800	Corner Panel	Exposed	765 - 780	DXFCP8
900	Corner Panel	Exposed	865 - 880	DXFCP9
1000	Corner Panel	Exposed	965 - 980	DXFCP10
1200	Corner Panel	Exposed	1165 - 1180	DXFCP12
240	'L' Return Panel	-	+25 to above	DXFCPL2
440	'L' Return Panel	-	+25 to above	DXFCPL4

Compatible Trays:	Page
Roman Anti-Slip Trays	122 - 123
Roman Infinity Trays	124 - 125
Roman Low Level Trays	128 - 129
Roman Shield System	147

Corner Panel

Concealed Wall Profile



1200 Corner Panel

- Corner Panel DXFCP12CF
- 'L' Return Panel DXFCPL2
- Roman Shield Wetroom System
- Shower Basket RSB05

“ This minimalist piece will instantly create a boutique showering space. ”



GLASS THICKNESS
10
Millimetres

TOTAL HEIGHT
2000
Millimetres



Features and Benefits:

- Concealed wall profile supplied
- Suitable for installation onto tray or wetroom floor
- Optional 'L' shaped return panel
- LBBK4590 bracing bar can be ordered if required for additional support
- Due to the nature of the product water integrity cannot be guaranteed - please consult your installer

1200 Corner Panel

- Corner Panel DXFCP12CF
- Gloss Infinity Tray IAG129
- Shower Basket RSB05

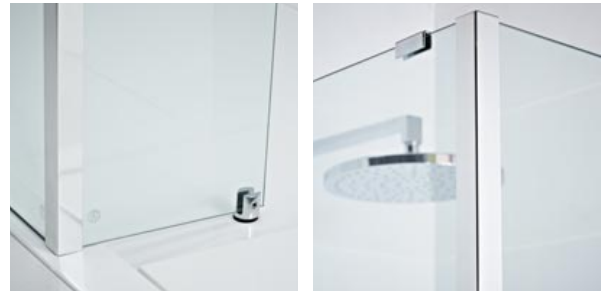

LBBK4590 Brace Bar

Corner Panel with concealed wall profile

Enclosure Size (mm)	Description	Fitting Type	Adjustment (mm)	Code
800	Corner Panel	Concealed	722 - 740	DXFCP8CF
900	Corner Panel	Concealed	822 - 840	DXFCP9CF
1000	Corner Panel	Concealed	922 - 940	DXFCP10CF
1200	Corner Panel	Concealed	1122 - 1140	DXFCP12CF
230	'L' Return Panel	-	+17 to above	DXFCPL2
430	'L' Return Panel	-	+17 to above	DXFCPL4
1060 (Max)	Bracing Bar	-	Cut to suit	LBBK4590

Please note: In-Line Panels are in packs of two so one order code required only.

Compatible Trays:	Page
Roman Anti-Slip Trays	122 - 123
Roman Infinity Trays	124 - 125
Roman Low Level Trays	128 - 129
Roman Shield System	147

10mm
&
8mm

Liberty

Frameless Collection

- Hinged Door Enclosures
- Sliding Door Enclosures

Choose glass thickness; Choose frame colour; Choose inward or outward opening; Choose silicone free wall fixing

The Liberty Collection is freed from the shackles of traditional bathroom design, with its ultra-modern and minimalist focus.

The striking minimalist look is captured with options such as door hinged straight from wall with optically clear seals.

This modern collection features a unique hydro-active wall profile sealing tape system technology, to increase water integrity, whilst also keeping with the minimalist design.

This leading collection of design led shower enclosures is perfectly completed with frame finish options of bright silver chrome, brushed nickel or matt black finish on all components.

The minimalist nature of the product means if the shower head is directed at seal and component interfaces, some water may escape from the showering area. The product will perform as intended under normal showering conditions.

“Colour does not add a pleasant quality to design - it reinforces it.”
- Pierre Bonard



What will your colour be...?



Liberty

Sliding One Door

Alcove Fitting

Available Spring 2019



1200 Alcove Fitting - Brushed Nickel finish

- Right Hand Door KT1D12RN
- 1200 x 800 Anti-Slip Tray RST128

“Revolutionary minimalist sliding styling”

Features and Benefits:

- Quick release door function for easy cleaning
- Barrier free entry option
- Silent and ultra-smooth running roller bearing system
- Soft cushioned close system
- Unique sealing tape system technology to reduce the need for silicone
- Choice of silver chrome, brushed nickel or matt black finish
- Beautifully styled corner joints
- Silicone free wall fixing system

GLASS
THICKNESS
8
Millimetres

TOTAL
HEIGHT
2000
Millimetres

GLASS
PROTECTION
**ULTRA
CARE**
BY ROMAN

TRUELIFE
**LIFETIME
GUARANTEE**



1200 Alcove Fitting - Brushed Nickel finish

- Right Hand Door KT1D12RN
- 1200 x 800 Anti-Slip Tray RST128

Please note: Handing must be specified for the correct codes to be ordered.

Alcove Fitting

Add your preferred colour letter to codes

Enclosure Size (mm)	Handing	Adjustment (mm)	Door Code
1200	Left Hand	1166 - 1194	KT1D12L
1200	Right Hand	1166 - 1194	KT1D12R
1400	Left Hand	1366 - 1394	KT1D14L
1400	Right Hand	1366 - 1394	KT1D14R
1500	Left Hand	1466 - 1494	KT1D15L
1500	Right Hand	1466 - 1494	KT1D15R
1700	Left Hand	1666 - 1694	KT1D17L
1700	Right Hand	1666 - 1694	KT1D17R

Colour options for hardware:



Chrome
add S
to codes

Brushed Nickel
add N
to codes

Matt Black
add B
to codes

Compatible Trays:	Page
Roman Anti-Slip Trays	122 - 123
Roman Infinity Trays	124 - 125
Roman Low Level Trays	128 - 129
Roman Shield System	147

Liberty

Sliding One Door

Corner Fitting

Available Spring 2019



1700 x 800 Corner Fitting - Matt Black finish

- Right Hand Door KT1D17RCB Side Panel KTR1C8B
- 1700 x 800 Matt White Anti-Slip Tray RST178

Door open

“Beautifully styled curved corner joints”



GLASS THICKNESS
8
Millimetres

TOTAL HEIGHT
2000
Millimetres

GLASS PROTECTION
ULTRA CARE
BY ROMAN

TRULIFE
LIFETIME GUARANTEE

Features and Benefits:

- Quick release door function for easy cleaning
- Barrier free entry option
- Silent and ultra-smooth running roller bearing system
- Soft cushioned close system
- Unique sealing tape system technology to reduce the need for silicone
- Choice of silver chrome, brushed nickel or matt black finish
- Beautifully styled corner joints
- Silicone free wall fixing system



1700 x 800 Corner Fitting

- Right Hand Door KT1D17RCB and Side Panel KTR1C8B
- 1700 x 800 Matt White Anti-Slip Tray RST178

Colour options for hardware:



Chrome
add S
to codes

Brushed Nickel
add N
to codes

Matt Black
add B
to codes

Please note: Handing must be specified for the correct codes to be ordered.

Corner Fitting

Add your preferred colour letter to codes

Enclosure Size (mm)	Handing	Adjustment (mm)	Door Code	Side Panel Code
1200 x 800	Left Hand	1173 - 1187 & 773 - 787	KT1D12LC	KTR1C8
1200 x 800	Right Hand	1173 - 1187 & 773 - 787	KT1D12RC	KTR1C8
1200 x 900	Left Hand	1173 - 1187 & 873 - 887	KT1D12LC	KTR1C9
1200 x 900	Right Hand	1173 - 1187 & 873 - 887	KT1D12RC	KTR1C9
1400 x 800	Left Hand	1373 - 1387 & 773 - 787	KT1D14LC	KTR1C8
1400 x 800	Right Hand	1373 - 1387 & 773 - 787	KT1D14RC	KTR1C8
1400 x 900	Left Hand	1373 - 1387 & 873 - 887	KT1D14LC	KTR1C9
1400 x 900	Right Hand	1373 - 1387 & 873 - 887	KT1D14RC	KTR1C9
1500 x 800	Left Hand	1473 - 1487 & 773 - 787	KT1D15LC	KTR1C8
1500 x 800	Right Hand	1473 - 1487 & 773 - 787	KT1D15RC	KTR1C8
1500 x 900	Left Hand	1473 - 1487 & 873 - 887	KT1D15LC	KTR1C9
1500 x 900	Right Hand	1473 - 1487 & 873 - 887	KT1D15RC	KTR1C9
1700 x 800	Left Hand	1673 - 1687 & 773 - 787	KT1D17LC	KTR1C8
1700 x 800	Right Hand	1673 - 1687 & 773 - 787	KT1D17RC	KTR1C8
1700 x 900	Left Hand	1673 - 1687 & 873 - 887	KT1D17LC	KTR1C9
1700 x 900	Right Hand	1673 - 1687 & 873 - 887	KT1D17RC	KTR1C9

Compatible Trays:	Page
Roman Anti-Slip Trays	122 - 123
Roman Infinity Trays	124 - 125
Roman Low Level Trays	128 - 129
Roman Shield System	147

Two Sliding Doors

Available Spring 2019



1700 x 800 Corner Fitting - Brushed Nickel finish

- Door KT2D17C1N and KTR2C8N
- 1700 x 800 Matt White Anti-Slip Tray RST178

“ Ultra-smooth and silent running action ”



GLASS THICKNESS
8
Millimetres

TOTAL HEIGHT
2000
Millimetres

REVERSIBLE

GLASS PROTECTION
ULTRA CARE
BY ROMAN

TRULIFE

Features and Benefits:

- Quick release door function for easy cleaning
- Barrier free entry option
- Silent and ultra-smooth running roller bearing system
- Soft cushioned close system
- Unique sealing tape system technology to reduce the need for silicone
- Choice of silver chrome, brushed nickel or matt black finish
- Beautifully styled corner joints
- Silicone free wall fixing system



1700 Alcove Fitting - Brushed Nickel finish

- Door KT2D17N
- 1700 x 800 Matt White Anti-Slip Tray RST178

Alcove Fitting

Add your preferred colour letter to codes

Enclosure Size (mm)	Adjustment (mm)	Door Code
1700	1666 - 1694	KT2D17
1800	1766 - 1794	KT2D18

Colour options for hardware:



Chrome
add S
to codes

Brushed Nickel
add N
to codes

Matt Black
add B
to codes

Corner Fitting

Add your preferred colour letter to codes

Enclosure Size (mm)	Adjustment (mm)	Door Code	Side Panel Code
1700 x 800	1673 - 1687 & 773 - 787	KT2D17C1	KTR2C8
1700 x 900	1673 - 1687 & 873 - 887	KT2D17C1	KTR2C9
1800 x 800	1773 - 1787 & 773 - 787	KT2D18C1	KTR2C8

Compatible Trays:	Page
Roman Anti-Slip Trays	122 - 123
Roman Infinity Trays	124 - 125
Roman Low Level Trays	128 - 129
Roman Shield System	147

Two Sliding Doors

with two in-line panels and two side panels

Available Spring 2019



1800 x 800 3 Sided Enclosure - Matt Black finish

- Door KT2D18C2B and Side Panel KTR3C8B x2
- 1800 x 800 Matt White Anti-Slip Tray RST178

“ Everything is designed -
few things are designed well ”

Colour options for hardware:



Chrome
add S
to codes

Brushed Nickel
add N
to codes

Matt Black
add B
to codes

GLASS
THICKNESS
8
Millimetres

TOTAL
HEIGHT
2000
Millimetres



GLASS
PROTECTION
**ULTRA
CARE**
BY ROMAN

TRUELIFE
**LIFETIME
GUARANTEE**

Features and Benefits:

- Quick release door function for easy cleaning
- Barrier free entry option
- Silent and ultra-smooth running roller bearing system
- Soft cushioned close system
- Unique sealing tape system technology to reduce the need for silicone
- Choice of silver chrome, brushed nickel or matt black finish
- Beautifully styled corner joints
- Silicone free wall fixing system



3 Sided Enclosure

Add your preferred colour letter to codes

Enclosure Size (mm)	Side Panel Adjustment (mm)	Door Code	Side Panel Code	Side Panel Code
1700 x 800	773 - 787	KT2D17C2	KTR3C8	KTR3C8
1700 x 900	873 - 887	KT2D17C2	KTR3C9	KTR3C9
1800 x 800	773 - 787	KT2D18C2	KTR3C8	KTR3C8

Compatible Trays:	Page
Roman Anti-Slip Trays	122 - 123
Roman Infinity Trays	124 - 125
Roman Low Level Trays	128 - 129
Roman Shield System	147

Liberty

Hinged Door

with side panel for corner fitting

Outward Opening



900 x 900 Corner Fitting - Chrome finish

- 8mm Door KL913CS and Side Panel KR913S
- 900 x 900 Roman Low Level Tray RLT90
- Shower Basket RSB01

“Door hinged straight from the wall for a sleek minimalist look”



900 x 900 Corner Fitting - Chrome finish

- 8mm Door KL913CS and Side Panel KR913S
- 900 x 900 Roman Low Level Tray RLT90
- Shower Basket RSB01

GLASS THICKNESS
10
Millimetres

GLASS THICKNESS
8
Millimetres

TOTAL HEIGHT
2000
Millimetres

REVERSIBLE

GLASS PROTECTION
ULTRA CARE
by ROMAN

TRULIFE
LIFETIME GUARANTEE

Features and Benefits:

- Hinged from wall
- New clear and minimal seals
- New minimal easy fix wall profile system
- Outward Opening only
- Choice of colour finishes for hardware
- Unique sealing tape system technology to reduce the need for silicone
- Integrated 'tray or floor' Water Safe System
- Designed for installation to straight vertical walls
- Silicone Free Wall Fixing

Colour options for hardware:



Chrome
add S
to codes

Brushed Nickel
add N
to codes

Matt Black
add B
to codes



Add your preferred colour letter to codes

Glass Thickness (mm)	Description	Size (mm)	Adjustment (mm)	Aperture (mm)	Order Code
8	Hinged Door for Corner	760	0	720	KL7613C
8	Hinged Door for Corner	800	0	760	KL813C
8	Hinged Door for Corner	900	0	860	KL913C
8	Hinged Door for Corner	1000	0	960	KL1013C
8	Side Panel	760	733 - 747	-	KR7613
8	Side Panel	800	773 - 787	-	KR813
8	Side Panel	900	873 - 887	-	KR913
8	Side Panel	1000	973 - 987	-	KR1013
10	Hinged Door for Corner	760	0	720	TL7613C
10	Hinged Door for Corner	800	0	760	TL813C
10	Hinged Door for Corner	900	0	860	TL913C
10	Hinged Door for Corner	1000	0	960	TL1013C
10	Side Panel	760	733 - 747	-	TR7613
10	Side Panel	800	773 - 787	-	TR813
10	Side Panel	900	873 - 887	-	TR913
10	Side Panel	1000	973 - 987	-	TR1013

Compatible Trays:	Page
Roman Anti-Slip Trays	122 - 123
Roman Infinity Trays	124 - 125
Roman Low Level Trays	128 - 129
Roman Shield System	147

Hinged Door

with one in-line panel

Inward or Outward Opening



1000 Alcove Fitting - Brushed Nickel finish

- 8mm Door KL1HD13N and In-Line Panel KL1H1013N
- Roman Low Level Tray RLT108
- Shower Basket RSB02

“ It presents you with the choice of a brushed nickel, silver chrome or matt black finish on all components including the elongated sleek hinges, designer handle and bracing bar. ”



GLASS THICKNESS
10
Millimetres

GLASS THICKNESS
8
Millimetres

TOTAL HEIGHT
2000
Millimetres



Features and Benefits:

- Hinged from wall
- New clear and minimal seals
- New minimal easy fix wall profile system
- Adjustable hinges for Inward or Outward opening door
- Choice of colour finishes for hardware
- Unique sealing tape system technology to reduce the need for silicone
- Integrated 'tray or floor' Water Safe System
- Designed for installation to straight vertical walls
- Silicone Free Wall Fixing

1200 x 900 Corner Fitting - Brushed Nickel finish

- 8mm Door KL1HDR13N, In-Line Panel KL1HR1213N and Side Panel KHR913N
- Gloss Infinity Tray IAG129
- Shower Basket RSB02

Colour options for hardware:



Chrome
add S
to codes

Brushed Nickel
add N
to codes

Matt Black
add B
to codes

Alcove Fitting

Add your preferred colour letter to codes

Glass Thickness (mm)	Enclosure Size (mm)	Adjustment (mm)	Aperture (mm)	Door Code	In-Line Panel Code
8	760	733 - 747	500	KL1HD213	KL1H7613
8	800	773 - 787	500	KL1HD213	KL1H813
8	900	873 - 887	640	KL1HD13	KL1H913
8	1000	973 - 987	640	KL1HD13	KL1H1013
8	1200	1173 - 1187	640	KL1HD13	KL1H1213
8	1400	1373 - 1389	640	KL1HD13	KL1H1413
8	1600	1573 - 1587	640	KL1HD13	KL1H1613
10	760	733 - 747	500	TL1HD213	TL1H7613
10	800	773 - 787	500	TL1HD213	TL1H813
10	900	873 - 887	640	TL1HD13	TL1H913
10	1000	973 - 987	640	TL1HD13	TL1H1013
10	1200	1173 - 1187	640	TL1HD13	TL1H1213
10	1400	1373 - 1389	640	TL1HD13	TL1H1413
10	1600	1573 - 1587	640	TL1HD13	TL1H1613



Corner Fitting

Add your preferred colour letter to codes

Glass Thickness (mm)	Enclosure Size (mm)	Adjustment (mm)	Aperture (mm)	Door Code	Side Panel Code	In-Line Panel Code
8	1000 x 800	773 - 787	667	KL1HDR13	KL1HR1013	KHR813
8	1000 x 900	873 - 887	667	KL1HDR13	KL1HR1013	KHR913
8	1200 x 800	773 - 787	667	KL1HDR13	KL1HR1213	KHR813
8	1200 x 900	873 - 887	667	KL1HDR13	KL1HR1213	KHR913
8	1400 x 800	773 - 787	667	KL1HDR13	KL1HR1413	KHR813
8	1400 x 900	873 - 887	667	KL1HDR13	KL1HR1413	KHR913
8	1600 x 800	773 - 787	667	KL1HDR13	KL1HR1613	KHR813
10	1000 x 800	773 - 787	667	TL1HDR13	TL1HR1013	THR813
10	1000 x 900	873 - 887	667	TL1HDR13	TL1HR1013	THR913
10	1200 x 800	773 - 787	667	TL1HDR13	TL1HR1213	THR813
10	1200 x 900	873 - 887	667	TL1HDR13	TL1HR1213	THR913
10	1400 x 800	773 - 787	667	TL1HDR13	TL1HR1413	THR813
10	1400 x 900	873 - 887	667	TL1HDR13	TL1HR1413	THR913
10	1600 x 800	773 - 787	667	TL1HDR13	TL1HR1613	THR813

Compatible Trays:	Page
Roman Anti-Slip Trays	122 - 123
Roman Infinity Trays	124 - 125
Roman Low Level Trays	128 - 129
Roman Shield System	147

Liberty

Hinged Door

with two in-line panels

Inward or Outward Opening



1600 Alcove Fitting - Chrome finish

- 8mm Door KLHD13S and In-Line Panel KLH1613S
- 1600 x 800 Gloss Infinity Tray IAG168
- Shower Basket RSB01

“Cleverly use the alcove space in your bathroom with the frameless hinged door with two in-line panels.”



GLASS THICKNESS
10
Millimetres

GLASS THICKNESS
8
Millimetres

TOTAL HEIGHT
2000
Millimetres



Features and Benefits:

- Hinged from In-Line Panel
- New clear and minimal seals
- New minimal easy fix wall profile system
- Adjustable hinges for Inward or Outward opening door
- Choice of colour finishes for hardware
- Unique sealing tape system technology to reduce the need for silicone
- Integrated 'tray or floor' Water Safe System
- Designed for installation to straight vertical walls
- Silicone Free Wall Fixing

1600 x 800 Corner Fitting - Chrome finish

- 8mm Door KLHDR13S, In-Line Panel KLHR1613S and Side Panel KHR813S
- 1600 x 800 Gloss Infinity Tray IAG168
- Shower Basket RSB01

Colour options for hardware:



Chrome
add **S**
to codes

Brushed Nickel
add **N**
to codes

Matt Black
add **B**
to codes

Alcove Fitting

Add your preferred colour letter to codes

Glass Thickness (mm)	Enclosure Size (mm)	Adjustment (mm)	Aperture (mm)	Door Code	In-Line Panel Code
8	1200	1166 - 1194	653	KLHD13	KLH1213
8	1400	1366 - 1394	653	KLHD13	KLH1413
8	1600	1566 - 1594	653	KLHD13	KLH1613
10	1200	1166 - 1194	653	TLHD13	TLH1213
10	1400	1366 - 1394	653	TLHD13	TLH1413
10	1600	1566 - 1594	653	TLHD13	TLH1613

Compatible Trays:	Page
Roman Anti-Slip Trays	122 - 123
Roman Infinity Trays	124 - 125
Roman Low Level Trays	128 - 129
Roman Shield System	147

Corner Fitting

Add your preferred colour letter to codes

Glass Thickness (mm)	Enclosure Size (mm)	Adjustment (mm) Door and In-Line Panel	Adjustment (mm) Side Panel	Door Aperture (mm)	Door Code	Side Panel Code	In-Line Panel Code
8	1200 x 800	1173 - 1187	773 - 787	653	KLHDR13	KLHR1213	KHR813
8	1200 x 900	1173 - 1187	873 - 887	653	KLHDR13	KLHR1213	KHR913
8	1400 x 800	1373 - 1387	773 - 787	653	KLHDR13	KLHR1413	KHR813
8	1400 x 900	1373 - 1387	873 - 887	653	KLHDR13	KLHR1413	KHR913
8	1600 x 800	1573 - 1587	773 - 787	653	KLHDR13	KLHR1613	KHR813
8	1600 x 900	1573 - 1587	873 - 887	653	KLHDR13	KLHR1613	KHR913
10	1200 x 800	1173 - 1187	773 - 787	653	TLHDR13	TLHR1213	THR813
10	1200 x 900	1173 - 1187	873 - 887	653	TLHDR13	TLHR1213	THR913
10	1400 x 800	1373 - 1387	773 - 787	653	TLHDR13	TLHR1413	THR813
10	1400 x 900	1373 - 1387	873 - 887	653	TLHDR13	TLHR1413	THR913
10	1600 x 800	1573 - 1587	773 - 787	653	TLHDR13	TLHR1613	THR813
10	1600 x 900	1573 - 1587	873 - 887	653	TLHDR13	TLHR1613	THR913

Liberty

Hinged Door

with hinged in-line panel

Outward Opening



1200 x 900 Corner Fitting - Matt Black finish

- 8mm Door KL2HDR13B, In-Line Panel KL2HR1213B, Side Panel K1R913B
- 1200 x 900 Black Shimmer Infinity Tray IAG129B
- Shower Basket RSB03

“Keep your bathroom at the forefront of fashion with the luxuriously minimalist Liberty Collection.”



GLASS THICKNESS
10
Millimetres

GLASS THICKNESS
8
Millimetres

TOTAL HEIGHT
2000
Millimetres

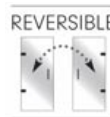

GLASS PROTECTION
ULTRA CARE
BY ROMAN

TRUELIFE
LIFETIME GUARANTEE

Features and Benefits:

- Hinged from In-Line Panel
- New clear and minimal seals
- New minimal easy fix wall profile system
- Choice of colour finishes for hardware
- Unique sealing tape system technology to reduce the need for silicone
- Integrated 'tray or floor' Water Safe System
- Designed for installation to straight vertical walls
- Outward opening only
- Silicone Free Wall Fixing

Colour options for hardware:



Chrome
add S
to codes

Brushed Nickel
add N
to codes

Matt Black
add B
to codes

1200 Alcove Fitting - Chrome finish

- 8mm Door KL2HD13S and In-Line Panel KL2H1213S
- 1200 x 900 Gloss White Infinity Tray IAG129
- Shower Basket RSB03

Alcove Fitting Outward or Inward Opening Add your preferred colour letter to codes

Glass Thickness (mm)	Enclosure Size (mm)	Adjustment (mm)	Door Aperture (mm)	Door Code	In-Line Panel Code
8	1000	970 - 994	760	KL2HD13	KL2H1013
8	1200	1170 - 1194	760	KL2HD13	KL2H1213
10	1000	970 - 994	760	TL2HD13	TL2H1013
10	1200	1170 - 1194	760	TL2HD13	TL2H1213



Matt Black finish

Corner Fitting Outward Opening only Add your preferred colour letter to codes

Glass Thickness (mm)	Enclosure Size (mm)	Adjustment (mm) Door and In-Line Panel	Adjustment (mm) Side Panel	Door Aperture (mm)	Door Code	Side Panel Code	In-Line Panel Code
8	1000 x 760	973 - 987	733 - 747	760	KL2HDR13	KL2HR1013	K1R7613
8	1000 x 800	973 - 987	773 - 787	760	KL2HDR13	KL2HR1013	K1R813
8	1000 x 900	973 - 987	873 - 887	760	KL2HDR13	KL2HR1013	K1R913
8	1000 x 1000	973 - 987	973 - 987	760	KL2HDR13	KL2HR1013	K1R1013
8	1200 x 760	1173 - 1187	733 - 747	760	KL2HDR13	KL2HR1213	K1R7613
8	1200 x 800	1173 - 1187	773 - 787	760	KL2HDR13	KL2HR1213	K1R813
8	1200 x 900	1173 - 1187	873 - 887	760	KL2HDR13	KL2HR1213	K1R913
8	1200 x 1000	1173 - 1187	973 - 987	760	KL2HDR13	KL2HR1213	K1R1013
10	1000 x 760	973 - 987	733 - 747	760	TL2HDR13	TL2HR1013	T1R7613
10	1000 x 800	973 - 987	773 - 787	760	TL2HDR13	TL2HR1013	T1R813
10	1000 x 900	973 - 987	873 - 887	760	TL2HDR13	TL2HR1013	T1R913
10	1000 x 1000	973 - 987	973 - 987	760	TL2HDR13	TL2HR1013	T1R1013
10	1200 x 760	1173 - 1187	733 - 747	760	TL2HDR13	TL2HR1213	T1R7613
10	1200 x 800	1173 - 1187	773 - 787	760	TL2HDR13	TL2HR1213	T1R813
10	1200 x 900	1173 - 1187	873 - 887	760	TL2HDR13	TL2HR1213	T1R913
10	1200 x 1000	1173 - 1187	973 - 987	760	TL2HDR13	TL2HR1213	T1R1013

Compatible Trays:	Page
Roman Anti-Slip Trays	122 - 123
Roman Infinity Trays	124 - 125
Roman Low Level Trays	128 - 129
Roman Shield System	147

8mm Innov8

Frameless Collection

- Pivot Doors
- Bi-Fold Doors
- Wetroom Panels

The Innov8 Collection encompasses elegantly minimalist frameless Pivot Door and Bi-Fold Door Enclosures. These frameless enclosures lead the way in minimal, inclusive and stylish design trends, presenting a distinctively modern collection.

Innov8's outstanding differential is the low threshold (reduced height of the bottom rail), allowing level entry access into the shower enclosure. The elimination of the top rail and profiles (when configured with a side or in-line panel) and the low threshold, encapsulates the minimalist styling, whilst still retaining the water integrity and adjustments of a standard shower enclosure.

The minimalist nature of the product means if the shower head is directed at seal and component interfaces, some water may escape from the showering area. The product will perform as intended under normal showering conditions.

“ Design is not just what it looks like
and feels like. Design is how it works. ”

- Steve Jobs



Pivot Door

Outward Opening



900 x 900 Corner Fitting

- Door N2F913CS
- Side Panel N2R913S
- Roman Low Level Tray RLT9
- Shower Basket RSB07

“A minimalist design with its frameless look presenting inclusivity for all users with its low threshold”



900 Alcove Fitting

- Door N2F913S
- Roman Low Level Tray RLT9
- Shower Basket RSB07

GLASS THICKNESS
8
Millimetres

TOTAL HEIGHT
1967
Millimetres

REVERSIBLE

GLASS PROTECTION
ULTRA CARE
BY ROMAN

TRUELIFE
LIFETIME GUARANTEE

Features and Benefits:

- Glass Height 1950mm
- Height to top of pivot tube 1967mm
- Bright Silver frame
- Chromed brass machined components
- Chromed brass feature handle
- Low profile PVC seals
- 20mm of adjustment in each profile
- No top rail
- Can be installed for outward opening
- Full length pivoting tube
- Side Panels supplied with optional bracing

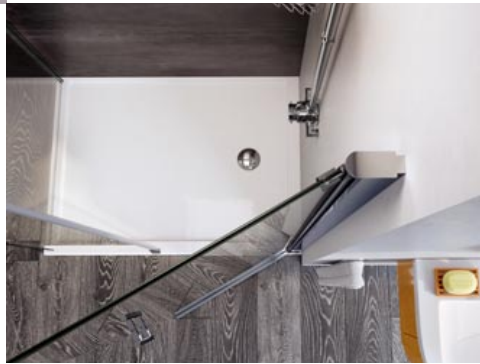

Corner Fitting

Enclosure Size (mm)	Description	Adjustment (mm)	Door Aperture (mm)	Code Required
760	Door	715 - 735	630	N2F7613CS
800	Door	755 - 775	670	N2F813CS
900	Door	855 - 875	770	N2F913CS
760	Side Panel	715 - 735	-	N2R7613S
800	Side Panel	755 - 775	-	N2R813S
900	Side Panel	855 - 875	-	N2R913S

Alcove Fitting

Enclosure Size (mm)	Description	Adjustment (mm)	Door Aperture (mm)	Code Required
760	Door	710 - 750	600	N2F7613S
800	Door	750 - 790	640	N2F813S
900	Door	850 - 890	740	N2F913S

Compatible Trays:	Page
Roman Anti-Slip Trays	122 - 123
Roman Infinity Trays	124 - 125
Roman Low Level Trays	128 - 129
Roman Shield System	147

Pivot Door

with In-Line Panel

Inward or Outward Opening



1200 Alcove Fitting

- Door N2F1HD13S
- In-Line Panel N2H1213S
- Anti Slip Tray RST129
- Shower Basket RSB02

“ This frameless Pivot Door introduces a distinctive minimalist look, inclusive design and supreme functionality ”



1200 x 900 Corner Fitting

- Door N2F1HDR13S
- Side Panel N2HR913S
- In-Line Panel N2HR1213S
- Anti Slip Tray RST129
- Shower Basket RSB02

GLASS THICKNESS
8
Millimetres

TOTAL HEIGHT
1967
Millimetres

REVERSIBLE

GLASS PROTECTION
ULTRA CARE
BY ROMAN

TRUETIME
LIFETIME GUARANTEE

Features and Benefits:

- Glass Height 1950mm
- Height to top of pivot tube 1967mm
- Bright Silver frame
- Chromed brass machined components
- Chromed brass feature handle
- Low profile PVC seals
- 20mm of adjustment in each profile
- No top rail
- Can be installed for outward opening
- Full length pivoting tube
- In-Line Panels supplied with optional bracing



Corner Fitting

Enclosure Size (mm)	Adjustment (mm) Door and In-Line	Adjustment (mm) Side Panel	Door Aperture (mm)	Door Code	Side Panel Code	In-Line Panel Code
1000 x 800	955 - 975	755 - 775	585	N2F1HDR13S	N2HR813S	N2HR1013S
1000 x 900	955 - 975	855 - 875	585	N2F1HDR13S	N2HR913S	N2HR1013S
1200 x 800	1155 - 1175	755 - 775	585	N2F1HDR13S	N2HR813S	N2HR1213S
1200 x 900	1155 - 1175	855 - 875	585	N2F1HDR13S	N2HR913S	N2HR1213S
1400 x 800	1355 - 1375	755 - 775	640	N2F2HDR13S	N2HR813S	N2HR1413S
1400 x 900	1355 - 1375	855 - 875	640	N2F2HDR13S	N2HR913S	N2HR1413S
1500 x 800	1455 - 1475	755 - 775	640	N2F2HDR13S	N2HR813S	N2HR1513S
1500 x 900	1455 - 1475	855 - 875	640	N2F2HDR13S	N2HR913S	N2HR1513S

Alcove Fitting

Enclosure Size (mm)	Adjustment (mm)	Door Aperture (mm)	Door Code	In-Line Panel Code
1000	950 - 990	585	N2F1HD13S	N2H1013S
1200	1150 - 1190	585	N2F1HD13S	N2H1213S
1400	1350 - 1390	640	N2F2HD13S	N2H1413S
1500	1450 - 1490	640	N2F2HD13S	N2H1513S

Compatible Trays:	Page
Roman Anti-Slip Trays	122 - 123
Roman Infinity Trays	124 - 125
Roman Low Level Trays	128 - 129
Roman Shield System	147

Bi-Fold Door

Inward Opening



900 x 900 Corner Fitting

- Door N2V913CS
- Side Panel N2R913S
- Roman Tray RLT90

“Roman has once again innovated to remove top and bottom framing.”

GLASS THICKNESS
8
Millimetres

TOTAL HEIGHT
1967
Millimetres

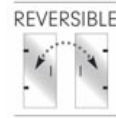

GLASS PROTECTION
ULTRA CARE
by ROMAN

TRUELIFE
LIFETIME
GUARANTEE

Features and Benefits:

- Frameless inward opening doors
- Bright silver profile
- Chromed brass hinges
- Chromed brass top caps
- Clear seals
- No top rail
- Elimination of the bottom rail creating level access entry



900 Alcove Fitting

- Door N2V913S
- Roman Tray RLT90



900 x 900 Corner Fitting closed

- x2 Doors N2V913CS

Corner Fitting (Door and Side Panel)

Enclosure Size (mm)	Description	Adjustment (mm)	Door Aperture (mm)	Code
760	Bi-Fold Door	715 - 735	620	N2V7613CS
800	Bi-Fold Door	755 - 775	660	N2V813CS
900	Bi-Fold Door	855 - 875	760	N2V913CS
1000	Bi-Fold Door	955 - 975	860	N2V1013CS
760	Side Panel	715 - 735	-	N2R7613S
800	Side Panel	755 - 775	-	N2R813S
900	Side Panel	855 - 875	-	N2R913S
1000	Side Panel	955 - 975	-	N2R1013S

Alcove Fitting

Enclosure Size (mm)	Description	Adjustment (mm)	Door Aperture (mm)	Door Code
760	Bi-Fold Door	710 - 750	590	N2V7613S
800	Bi-Fold Door	750 - 790	630	N2V813S
900	Bi-Fold Door	850 - 890	730	N2V913S
1000	Bi-Fold Door	950 - 990	830	N2V1013S

Corner Fitting (2 Bi-Fold Doors)

Enclosure Size (mm)	Adjustment (mm)	Door Aperture (mm)	Door Code
800 x 800	755 - 775	660	N2V813CS
900 x 900	855 - 875	760	N2V913CS
1000 x 1000	955 - 975	860	N2V1013CS



Open

Compatible Trays:	Page
Roman Anti-Slip Trays	122 - 123
Roman Infinity Trays	124 - 125
Roman Low Level Trays	128 - 129
Roman Shield System	147

Please note: This 2 door configuration is for a wetroom fitting solution only and is not recommended for fitting to a shower tray

Bi-Fold Door

with in-line panel

Inward Opening



1400 Alcove Fitting

- Door N2VHD13S
- In-Line Panel N2H1413S
- Roman Anti-Slip Tray RST149

“ The minimalist and flexible design of this frameless enclosure presents inclusivity for all users with its level access entry and no height restriction. ”

Features and Benefits:

- Frameless inward opening doors
- Bright silver profile
- Chromed brass hinges
- Chromed brass top caps
- Clear seals
- No top rail and elimination of the bottom rail creating level access entry

GLASS THICKNESS
8
Millimetres

TOTAL HEIGHT
1967
Millimetres

REVERSIBLE

GLASS PROTECTION
ULTRA CARE
BY ROMAN

TRUELIFE

LIFETIME GUARANTEE



1400 x 900 Corner Fitting

- Door N2VHDR13S
- Side Panel N2HR913S
- In-Line Panel N2HR1413S
- Roman Anti-Slip Tray RST149

Corner Fitting

Enclosure Size (mm)	Adjustment (mm) Door	Adjustment (mm) Side Panel	Aperture (mm)	Door Code	In-Line Panel Code	Side Panel Code
1200 x 800	1155 - 1175	755 - 775	630	N2VHDR13S	N2VHR1213S	N2HR813S
1200 x 900	1155 - 1175	855 - 875	630	N2VHDR13S	N2VHR1213S	N2HR913S
1400 x 800	1355 - 1375	755 - 775	630	N2VHDR13S	N2HR1413S	N2HR813S
1400 x 900	1355 - 1375	855 - 875	630	N2VHDR13S	N2HR1413S	N2HR913S
1500 x 800	1455 - 1475	755 - 775	630	N2VHDR13S	N2HR1513S	N2HR813S
1500 x 900	1455 - 1475	855 - 875	630	N2VHDR13S	N2HR1513S	N2HR913S

Alcove Fitting

Enclosure Size (mm)	Adjustment (mm)	Aperture (mm)	Door Code	In-Line Panel Code
1200	1150 - 1190	630	N2VHD13S	N2VH1213S
1400	1350 - 1390	630	N2VHD13S	N2H1413S
1500	1450 - 1490	630	N2VHD13S	N2H1513S

Compatible Trays:	Page
Roman Anti-Slip Trays	122 - 123
Roman Infinity Trays	124 - 125
Roman Low Level Trays	128 - 129
Roman Shield System	147

8mm
&
6mm

Lumin8

Semi-Frameless Collection

This compelling and contemporary collection of showering solutions meets all your requirements, whilst bringing an inviting touch of luxury into your bathroom.

Meticulously designed to solve a variety of space restrictions in the bathroom, whilst providing an effortless showering experience for the whole family.

Detail is fundamental with the Lumin8 Range to create a unique style with the highest quality. From the individual 'wrap around' chromed top caps, to the robust 8mm thick glass. From the pre-coated glass protection, to the elegant height of 1950mm. From the clear, low profile seals, to the bright silver profiles for a modern finish. Smooth running 'quick release' door system providing easy access for cleaning.



“ Good design is making something intelligible and memorable.
Great design is making something memorable and meaningful. ”

- Dieter Rams

One Door Quadrant

with sliding door



1200 x 900 Curved Quadrant

- One Door Offset Quadrant V8SQ91213S
- Roman Low Level Tray RLQ129R (Right Hand)
- Shower Basket RSB02

“An ideal solution for smaller bathrooms as it will sit beautifully in the corner of your bathroom, with an unobtrusive sliding door.”



900 x 900 Curved Quadrant

- One Door Quadrant V8SQ913S
- Roman Low Level Tray RLO90
- Shower Basket RSB02

GLASS THICKNESS
8
Millimetres

TOTAL HEIGHT
1950
Millimetres

REVERSIBLE

GLASS PROTECTION
 ULTRA CARE
BY ROMAN

TRULIFE
 LIFETIME GUARANTEE

Features and Benefits:

- Chromed brass handle
- Bright silver frame
- 'Minimal' low profile seals
- Smooth running 'quick release' roller bearings
- 25mm vertical adjustment in each profile
- Tray Compatibility: Tray or straight to floor using Roman Shield Wetroom System



900 x 1200 Curved Quadrant

- One Door Offset Quadrant V8SQ91213S
- Roman Low Level Tray RLO129L (Left Hand)
- Shower Basket RSB02



Enclosure Size (mm)	Description	Adjustment (mm)	Door Aperture (mm)	Code
800 x 800	One Door Quadrant	750 - 775	425	V8SQ813S
900 x 900	One Door Quadrant	850 - 875	525	V8SQ913S
800 x 900	One Door Offset Quadrant	750 - 775 & 850 - 875	425	V8SQ8913S
800 x 1000	One Door Offset Quadrant	750 - 775 & 950 - 975	425	V8SQ81013S
800 x 1200	One Door Offset Quadrant	750 - 775 & 1150 - 1175	425	V8SQ81213S
900 x 1200	One Door Offset Quadrant	850 - 875 & 1150 - 1175	525	V8SQ91213S

NB: Offset size enclosures - door always sits on curved/short edge of tray as illustrated.

Compatible Trays:	Page
Roman Anti-Slip Trays	122 - 123
Roman Infinity Trays	124 - 125
Roman Low Level Trays	128 - 129
Roman Shield System	147

Two Door Quadrant

sliding doors



900 X 1200 Offset Curved Quadrant

- Two Door Offset Quadrant V8Q91213S
- Roman Low Level Tray RLQ129R (Right Hand)
- Shower Basket RSB07

“The two sliding doors are an intelligent space saving tactic, whilst offering an indulgent showering area.”



GLASS THICKNESS
8
Millimetres

TOTAL HEIGHT
1950
Millimetres

REVERSIBLE

GLASS PROTECTION
ULTRA CARE
BY ROMAN

TRUELIFE

LIFETIME GUARANTEE

Features and Benefits:

- Chromed brass handles
- Bright silver frame
- 'Minimal' low profile seals
- Smooth running 'quick release' roller bearings
- 25mm vertical adjustment in each profile
- Tray Compatibility: Tray or straight to floor using Roman Shield Wetroom System

900 x 900 Curved Quadrant

- Two Door Quadrant V8Q913S
- Roman Low Level Tray RLO9
- Shower Basket RSB02



Enclosure Size (mm)	Description	Adjustment (mm)	Aperture (mm)	Code
800 x 800	Two Door Quadrant	750 - 775	330	V8Q813S
800 x 900	Two Door Offset Quadrant	750 - 775 & 850 - 875	420	V8Q8913S
900 x 900	Two Door Quadrant	850 - 875	500	V8Q913S
800 x 1000	Two Door Offset Quadrant	750 - 775 & 950 - 975	420	V8Q81013S
800 x 1200	Two Door Offset Quadrant	750 - 775 & 1150 - 1175	420	V8Q81213S
900 x 1200	Two Door Offset Quadrant	850 - 875 & 1150 - 1175	510	V8Q91213S

NB: Offset size enclosures - door always sits on curved/short edge of tray as illustrated.

Compatible Trays:	Page
Roman Anti-Slip Trays	122 - 123
Roman Infinity Trays	124 - 125
Roman Low Level Trays	128 - 129
Roman Shield System	147

Pivot Door

Outward Opening



1000 Alcove Fitting

- Pivot Door V8F1013S
- Roman Low Level Tray RLT100
- Shower Basket RSB06



1000 x 800 Corner Fitting

- 1000mm Pivot Door V8F1013S and 800mm Side Panel V8GL813S
- Roman Low Level RLT108
- Shower Basket RSB06



Features and Benefits:

- Chromed brass hinges
- Chromed brass handle
- Bright silver frame
- 'Minimal' low profile seals
- Pivot Door must be hinged from the wall
- 25mm vertical adjustment in each profile
- Tray Compatibility: Tray or straight to floor using Roman Shield Wetroom System

Corner or Alcove fitting

Size (mm)	Description	Adjustments (mm)	Aperture (mm)	Code
760	Pivot Door	700 - 750	465	V8F7613S
800	Pivot Door	740 - 790	505	V8F13S
900	Pivot Door	840 - 890	605	V8F913S
1000	Pivot Door	940 - 990	705	V8F1013S
700	Side Panel	640 - 690	-	V8GL713S
760	Side Panel	710 - 735	-	V8GL7613S
800	Side Panel	750 - 775	-	V8GL813S
900	Side Panel	850 - 875	-	V8GL913S
1000	Side Panel	950 - 975	-	V8GL1013S
200	In-Line Panel	+ 200mm to door sizes	-	V8HL213S
300	In-Line Panel	+ 300mm to door sizes	-	V8HL313S
1950 (height)	Extension Profile	-	-	VZEX2S

Compatible Trays:	Page
Roman Anti-Slip Trays	122 - 123
Roman Infinity Trays	124 - 125
Roman Low Level Trays	128 - 129
Roman Shield System	147

GLASS THICKNESS
8
Millimetres

TOTAL HEIGHT
1950
Millimetres

REVERSIBLE

GLASS PROTECTION
ULTRA CARE
BY ROMAN

TRUELIFE

LIFETIME GUARANTEE

Pivot Door

with In-Line Panel

Features and Benefits:

- Chromed brass hinges
- Chromed brass handle
- Bright silver frame
- 'Minimal' low profile seals
- Pivot Door must be hinged from the wall
- 25mm vertical adjustment in each profile
- Tray Compatibility: Tray or straight to floor using Roman Shield Wetroom System



1200 Alcove Fitting

- 1000mm Pivot Door V8F1013S with 200mm In-Line Panel V8HL213S
- Gloss Infinity Tray IAG128
- Shower Basket RSB06



1200 x 800 Corner Fitting

- 1000mm Pivot Door V8F1013S with 200mm In-Line Panel V8HL213S and 800mm Side Panel V8GL813S
- Gloss Infinity Tray IAG128
- Shower Basket RSB06

“ This outward opening door takes up minimal external space due to the positioning of the hinge point, meaning it protrudes less into the bathroom. ”

Corner or Alcove fitting

Size (mm)	Description	Adjustments (mm)	Aperture (mm)	Code
760	Pivot Door	700 - 750	465	V8F7613S
800	Pivot Door	740 - 790	505	V8F13S
900	Pivot Door	840 - 890	605	V8F913S
1000	Pivot Door	940 - 990	705	V8F1013S
200	In-Line Panel	+ 200mm to door sizes	-	V8HL213S
300	In-Line Panel	+ 300mm to door sizes	-	V8HL313S
700	Side Panel	640 - 690	-	V8GL713S
760	Side Panel	710 - 735	-	V8GL7613S
800	Side Panel	750 - 775	-	V8GL813S
900	Side Panel	850 - 875	-	V8GL913S
1000	Side Panel	950 - 975	-	V8GL1013S
1950 high	Extension Profile	-	-	VZEX2S

Compatible Trays:	Page
Roman Anti-Slip Trays	122 - 123
Roman Infinity Trays	124 - 125
Roman Low Level Trays	128 - 129
Roman Shield System	147

Lumin8

Inswing Door

with in-line panel

Outward Opening



1200 Alcove Fitting

- Door V8KH1213S
- 1200 x 800 Black Shimmer Infinity Tray IAG128B
- Shower Basket RSB02

“ This cleverly designed Inswing Door features a large opening without significant protrusion into the bathroom space. ”

GLASS THICKNESS
8
Millimetres

TOTAL HEIGHT
1950
Millimetres

REVERSIBLE

GLASS PROTECTION
ULTRA CARE
BY ROMAN

TRUELIFE

LIFETIME GUARANTEE

Features and Benefits:

- Chromed brass hinges
- Chromed brass handle
- Bright silver frame
- Inswing Door must be hinged from the wall
- Reversible for right or left hand fixing
- Tray Compatibility: Tray or straight to floor using Roman Shield Wetroom System



1000x 800 Corner Fitting

- Door V8K1013S Side Panel V8GL813S
- 1000 x 800 Roman Low level Tray RLT108
- Shower Basket RSB02



1200 Alcove Fitting

- Door V8KH1213S
- 1200 x 800 Black Shimmer Infinity Tray IAG128B
- Shower Basket RSB02



Size (mm)	Description	Adjustments (mm)	Aperture (mm)	Code
760	Inswing Door	700 - 750	540	V8K7613S
800	Inswing Door	740 - 790	580	V8K813S
900	Inswing Door	840 - 890	680	V8K913S
1000	Inswing Door	940 - 990	780	V8K1013S
1200*	Inswing Door	1140 - 1190	580	V8KH1213S
700	Side Panel	640 - 690	-	V8GL713S
760	Side Panel	710 - 735	-	V8GL7613S
800	Side Panel	750 - 775	-	V8GL813S
900	Side Panel	850 - 875	-	V8GL913S
1000	Side Panel	950 - 975	-	V8GL1013S
1950 high	Extension Profile	-	-	VZEX2S
200	In-Line Panel	+ 200mm to door sizes	-	V8HL213S
300	In-Line Panel	+ 300mm to door sizes	-	V8HL313S

In-Line Panels can be used with the Inswing Door

*Please note the 1200mm Inswing Door is a Door/In-Line Panel combination as image above

Compatible Trays:	Page
Roman Anti-Slip Trays	122 - 123
Roman Infinity Trays	124 - 125
Roman Low Level Trays	128 - 129
Roman Shield System	147

Level Access Sliding Door



1200 Alcove Fitting

- Sliding Door V8TLE1213SL (left hand)
- Roman Level Tray RLT128
- Shower Basket RSB07

Left hand opening - Closed position

“ Make your bathroom totally inclusive with this sliding door, as the bottom rail can be completely barrier free, creating true level access. ”

GLASS THICKNESS
8
Millimetres

TOTAL HEIGHT
1950
Millimetres

GLASS PROTECTION
ULTRA CARE
BY ROMAN

TRUELIFE
LIFETIME GUARANTEE



Left hand opening - Open position

Features and Benefits:

- Frame: Silver
- Optional bottom rail
- Easy release door function
- Compatible with Lumin8 Side Panels
- Left or Right handing must be specified
- Tray compatibility: Tray or straight to floor using Roman Shield Wetroom System

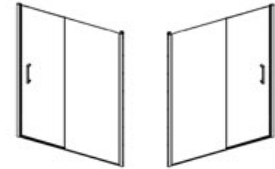

Left Hand

Right Hand

Corner or Alcove fitting

Please indicate left or right handing when ordering (add R or L to code)

Size (mm)	Description	Adjustments (mm)	Aperture (mm)	Code
1000	Level Access Sliding Door	940 - 990	360	V8TLE1013S
1100	Level Access Sliding Door	1040 - 1090	410	V8TLE1113S
1200	Level Access Sliding Door	1140 - 1190	460	V8TLE1213S
1400	Level Access Sliding Door	1340 - 1390	560	V8TLE1413S
1500	Level Access Sliding Door	1440 - 1490	610	V8TLE1513S
1700	Level Access Sliding Door	1640 - 1690	710	V8TLE1713S
700	Side Panel	640 - 690	-	V8GL713S
760	Side Panel	710 - 735	-	V8GL7613S
800	Side Panel	750 - 775	-	V8GL813S
900	Side Panel	850 - 875	-	V8GL913S
1000	Side Panel	950 - 975	-	V8GL1013S
1950 high	Extension Profile	-	-	VZEX2S

Compatible Trays:	Page
Roman Anti-Slip Trays	122 - 123
Roman Infinity Trays	124 - 125
Roman Low Level Trays	128 - 129
Roman Shield System	147

Sliding Door



1200 Alcove Fitting

- 1200mm Sliding Door V8T1213S
- Gloss Infinity Tray IAG128
- Shower Basket RSB06

“ It exudes luxury with the effortless door action and generous door opening. ”



1200 x 800 Corner Fitting

- 1200mm Sliding Door V8T1213S and 800mm Side Panel V8GL813S
- Gloss Infinity Tray IAG128
- Shower Basket RSB06

GLASS THICKNESS
8
Millimetres

TOTAL HEIGHT
1950
Millimetres



GLASS PROTECTION
ULTRA CARE
BY ROMAN

TRUELIFE
LIFETIME
GUARANTEE

Features and Benefits:

- Chromed brass handle
- Bright silver frame
- Minimal low profile seals
- Smooth running 'quick release' roller bearings
- 25mm vertical adjustment in each profile
- Tray Compatibility: Tray or straight to floor using Roman Shield Wetroom System

Corner or Alcove fitting

Size (mm)	Description	Adjustments (mm)	Aperture (mm)	Code
1000	Sliding Door	940 - 990	360	V8T1013S
1100	Sliding Door	1040 - 1090	410	V8T1113S
1200	Sliding Door	1140 - 1190	460	V8T1213S
1400	Sliding Door	1340 - 1390	560	V8T1413S
1500	Sliding Door	1440 - 1490	610	V8T1513S
1700	Sliding Door	1640 - 1690	710	V8T1713S
700	Side Panel	640 - 690	-	V8GL713S
760	Side Panel	710 - 735	-	V8GL7613S
800	Side Panel	750 - 775	-	V8GL813S
900	Side Panel	850 - 875	-	V8GL913S
1000	Side Panel	950 - 975	-	V8GL1013S
1950 high	Extension Profile	-	-	VZEX2S
200	In-Line Panel	+ 200mm to door sizes	-	V8HL213S
300	In-Line Panel	+ 300mm to door sizes	-	V8HL313S

Compatible Trays:	Page
Roman Anti-Slip Trays	122 - 123
Roman Infinity Trays	124 - 125
Roman Low Level Trays	128 - 129
Roman Shield System	147

Bi-Fold Door

Inward Opening



800 Alcove Fitting

- Bi-Fold Door V8V13S
- Roman Low Level Tray RLT80
- Shower Basket RSB06

“Practical inward opening doors present an extremely flexible space saving solution”



GLASS THICKNESS
6
Millimetres

TOTAL HEIGHT
1950
Millimetres

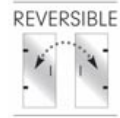

Features and Benefits:

- Chromed brass hinges
- Chromed brass handle
- Bright silver frame
- 25mm vertical adjustment in each profile
- Tray Compatibility: Tray or straight to floor using Roman Shield Wetroom System

800 x 800 Corner Fitting

- 800mm Bi-Fold Door V8V13S and 800mm Side Panel V8GL813S
- Roman Low Level Tray RLT80
- Shower Basket RSB06



Corner or Alcove fitting

Size (mm)	Description	Adjustments (mm)	Aperture (mm)	Code
760	Bi-Fold Door	700 - 750	460	V8V7613S
800	Bi-Fold Door	740 - 790	500	V8V13S
900	Bi-Fold Door	840 - 890	600	V8V913S
1000	Bi-Fold Door	940 - 990	700	V8V1013S
1200	Bi-Fold Door	1140 - 1190	900	V8V1213S
700	Side Panel	640 - 690	-	V8GL713S
760	Side Panel	710 - 735	-	V8GL7613S
800	Side Panel	750 - 775	-	V8GL813S
900	Side Panel	850 - 875	-	V8GL913S
1000	Side Panel	950 - 975	-	V8GL1013S
1950 high	Extension Profile	-	-	VZEX2S
200	In-Line Panel	+ 200mm to door sizes	-	V8HL213S
300	In-Line Panel	+ 300mm to door sizes	-	V8HL313S

N.B. 1000 and 1200 door options are one piece fully framed.

Compatible Trays:	Page
Roman Anti-Slip Trays	122 - 123
Roman Infinity Trays	124 - 125
Roman Low Level Trays	128 - 129
Roman Shield System	147

6mm

&
8mm

Embrace

Semi-Frameless Collection

Imaginative, urbane and innovative showering solutions designed to maximise space.

Our Embrace Collection brings together an innovative and stylish collection of shower enclosures and wetroom panels offering high performance and design benefits at an extremely competitive price. This exclusive range is available in an array of styles and shapes with bi-fold, hinged, quadrant, pivot, sliding doors and bath screens.

Specifications:

- All models feature exquisite chromed hardware and concealed fittings.
- All enclosures in the range are fully approved for use with power showers.
- Models that feature handle entry, present an elegant ergonomic bolt through handle which can be operated from inside and outside the unit.
- All Embrace enclosures and bath screens are supplied pre-coated with Roman Ultra Care - to aid glass protection from day one.

“ I strive for two things in design: simplicity and clarity. Great design is born of those two things. ”

- Lindon Leader

GLASS THICKNESS
6
Millimetres

TOTAL HEIGHT
1900
Millimetres

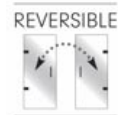

One Door Quadrant



900 x 1200 One Door Quadrant

- One Door Quadrant ESQ91213S
- Offset Roman Low Level Tray RLQ129R (right hand)

Features and Benefits:

- Silver frame
- Vertical adjustment: 25mm
- Smooth running roller bearing
- 'Quick release' system for easy cleaning
- Tray compatibility: 550mm radius

“A fusion of elegant styling and practical functionality”

Size (mm)	Description	Adjustments (mm)	Aperture (mm)	Code
800 x 800	One Door	760 - 785	410	ESQ813S
900 x 900	One Door	860 - 885	505	ESQ913S
800 x 900	One Door Offset	760 - 785 & 860 - 885	505	ESQ8913S
1000 x 800	One Door Offset	760 - 785 & 960 - 985	495	ESQ81013S
800 x 1200	One Door Offset	760 - 785 & 1160 - 1185	470	ESQ81213S
900 x 1200	One Door Offset	860 - 885 & 1160 - 1185	470	ESQ91213S

Compatible Trays:	Page
Roman Anti-Slip Trays	122 - 123
Roman Infinity Trays	124 - 125
Roman Low Level Trays	128 - 129
Roman Shield System	147

Two Door Quadrant

with Sliding Doors



900 x 900 Two Door Quadrant

- Two Door Curved Quadrant EQ913S
- Roman Low Level Tray RLQ90
- Shower Basket RSB05

“ Avoid bathrooms fittings with these central opening doors ”

Features and Benefits:

- Frame: Silver
- Vertical adjustment: 50mm
- Smooth running roller bearings
- 'Quick release' system for easy cleaning
- Tray compatibility: 550mm radius

Compatible Trays:	Page
Roman Anti-Slip Trays	122 - 123
Roman Infinity Trays	124 - 125
Roman Low Level Trays	128 - 129
Roman Shield System	147

Size (mm)	Description	Adjustments (mm)	Aperture (mm)	Code
800 x 800	Twin Door	760 - 785	315	EQ813S
900 x 900	Twin Door	860 - 885	485	EQ913S
760 x 900	Twin Door	720 - 745 & 860 - 885	400	EQ76913S
1000 x 1000	Twin Door	960 - 985	485	EQ1013S
800 x 900	Twin Door Offset	760 - 785 & 860 - 885	405	EQ8913S
800 x 1000	Twin Door Offset	760 - 785 & 960 - 985	435	EQ81013S
800 x 1200	Twin Door Offset	760 - 785 & 1160 - 1185	440	EQ81213S
900 x 1200	Twin Door Offset	860 - 885 & 1160 - 1185	530	EQ91213S

Hinged Door

GLASS THICKNESS
8
Millimetres

TOTAL HEIGHT
1900
Millimetres

REVERSIBLE

GLASS PROTECTION

ULTRA CARE
BY ROMAN

TRULIFE

LIFETIME GUARANTEE

Outward Opening



900 Alcove Fitting

- Door EL913S
- 900 x 900mm Roman Low Level RLT9
- Shower Basket RSB05



900 x 900 Corner Fitting

- Hinged Door EL913S
- Frameless Side Panel EGL913S
- Roman Low Level Tray RLT90
- Shower Basket RSB01

“ Perfect door for out of true walls ”

Features and Benefits:

- Frame: Silver
- Vertical adjustment: 50mm
- Ball catch closing mechanism
- Outward opening doors must be hinged from the wall
- Tray compatibility: Tray or straight to floor using Roman Shield Wetroom System

Corner or Alcove fitting

Size (mm)	Adjustments (mm)	Aperture (mm)	Code
760	710 - 760	530	EL7613S
800	750 - 800	570	EL13S
900	850 - 900	670	EL913S
1000	950 - 1000	770	EL1013S

For the full range of compatible Embrace Frameless Side Panels and In-Line Panels see page 89

Compatible Trays:	Page
Roman Anti-Slip Trays	122 - 123
Roman Infinity Trays	124 - 125
Roman Low Level Trays	128 - 129
Roman Shield System	147

Level Access Sliding Door



Right Hand

1200 Alcove Fitting

- Sliding Door ETLE1213SR (right hand)
- Infinity Shower Tray IA128
- Shower Basket RSB07

“This enclosure is ideal for the whole family with its barrier free bottom rail options, spacious door opening and stylish ergonomic handle”

GLASS THICKNESS
6
Millimetres

TOTAL HEIGHT
1900
Millimetres

GLASS PROTECTION
ULTRA CARE
BY ROMAN

TRUELIFE
LIFETIME GUARANTEE



Right Hand

1700 x 800 Corner Fitting

- Sliding Door ETLE1713SR (right hand)
- Side Panel EGL813S
- Infinity Shower Tray RST178
- Shower Basket RSB07

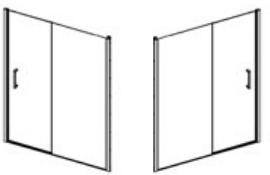

Left Hand Right Hand

Features and Benefits:

- Frame: Silver
- Optional bottom rail
- Easy release door function
- Compatible with Embrace Side Panels
- Left or Right handing must be specified
- Tray compatibility: Tray or straight to floor using Roman Shield Wetroom System

Corner or Alcove fitting

Please indicate left or right handing when ordering (add R or L to code)

Size (mm)	Adjustments (mm)	Aperture (mm)	Code
1000	950 - 1000	350	ETLE1013S
1100	1050 - 1100	400	ETLE1113S
1200	1150 - 1200	450	ETLE1213S
1400	1350 - 1400	550	ETLE1413S
1700	1650 - 1700	700	ETLE1713S

For the full range of compatible Embrace Frameless Side Panels and In-Line Panels see page 89

The minimalist nature of the product means if the shower head is directed at seal and component interfaces, some water may escape from the showering area. The product will perform as intended under normal showering conditions.

Compatible Trays:	Page
Roman Anti-Slip Trays	122 - 123
Roman Infinity Trays	124 - 125
Roman Low Level Trays	128 - 129
Roman Shield System	147

Sliding Door



1200 Corner Fitting

- Sliding Door ET1213S
- 900mm Frameless Side Panel EGL913S
- Roman Low Level Tray RLT129
- Shower Basket RSB03

Features and Benefits:

- Frame: Silver
- PVC vertical seals
- Adjustable smooth running bearings
- 'Quick release' mechanism
- Tray compatibility: Tray or straight to floor using Roman Shield Wetroom System

Compatible Trays:	Page
Roman Anti-Slip Trays	122 - 123
Roman Infinity Trays	124 - 125
Roman Low Level Trays	128 - 129
Roman Shield System	147

“Sliding doors are a key space saving feature”

Corner or Alcove fitting

Size (mm)	Adjustment (mm)	Aperture (mm)	Code
1000	950 - 1000	350	ET1013S
1100	1050 - 1100	400	ET1113S
1200	1150 - 1200	450	ET1213S
1400	1350 - 1400	550	ET1413S
1700	1650 - 1700	700	ET1713S

For the full range of compatible Embrace Frameless Side Panels and In-Line Panels see page 89

Pivot Door

GLASS THICKNESS
6
Millimetres

TOTAL HEIGHT
1900
Millimetres

REVERSIBLE

GLASS PROTECTION
ULTRA CARE
BY ROMAN

TRUELIFE

LIFETIME GUARANTEE

Outward Opening



900 x 900 Corner Fitting

- Pivot Door EF913S
- Side Panel EGL913S
- Roman Low Level Tray RLT90
- Shower Basket RSB06

Features and Benefits:

- Frame: Silver
- Magnetic door closing
- PVC vertical seals
- Reduced opening into room due to hinge position
- Outward opening doors must be hinged from the wall
- Tray compatibility: Tray or straight to floor using Roman Shield Wetroom System

“Ideal space saving solution as the position of the hinge point means less protrusion into the bathroom”

Compatible Trays:	Page
Roman Anti-Slip Trays	122 - 123
Roman Infinity Trays	124 - 125
Roman Low Level Trays	128 - 129
Roman Shield System	147

Size (mm)	Adjustment (mm)	Aperture (mm)	Code
760	715 - 760	455	EF7613S
800	755 - 800	495	EF13S
900	855 - 900	595	EF913S

For the full range of compatible Embrace Frameless Side Panels and In-Line Panels see page 89

Embrace

Bi-Fold Door

GLASS THICKNESS
6
Millimetres

TOTAL HEIGHT
1900
Millimetres

REVERSIBLE

GLASS PROTECTION
ULTRA CARE
BY ROMAN

TRUELIFE

LIFETIME GUARANTEE

Inward Opening

Features and Benefits:

- Frame: Silver
- Smooth running roller bearings
- Tray compatibility: Tray or straight to floor using Roman Shield Wetroom System

“The in-fold design of the Embrace Bi-Fold Door creates more useable space and minimal bathroom intrusion.”



1200 Alcove Fitting

- Bi-Fold Door EV1213S
- Roman Low Level Tray RLT129
- Shower Basket RSB02



900 x 900 Corner Fitting

- Bi-Fold Door EV913S
- Side Panel EGL913S
- Roman Low Level Tray RLT90
- Shower Basket RSB05

Size (mm)	Adjustments (mm)	Aperture (mm)	Code
760	715 - 760	470	EV7613S
800	755 - 800	510	EV13S
900	855 - 900	610	EV913S
1000	955 - 1000	710	EV1013S
1200	1155 - 1200	910	EV1213S

Compatible Trays:	Page
Roman Anti-Slip Trays	122 - 123
Roman Infinity Trays	124 - 125
Roman Low Level Trays	128 - 129
Roman Shield System	147

For the full range of compatible Embrace Frameless Side Panels and In-Line Panels see page 89

Side Panels

In-Line Panels

Neo-Angle Panels

GLASS THICKNESS
6
Millimetres

GLASS THICKNESS
8
Millimetres

TOTAL HEIGHT
1900
Millimetres

REVERSIBLE

GLASS PROTECTION
ULTRA CARE
BY ROMAN

TRUELIFE
LIFETIME GUARANTEE

Features and Benefits:

- Frame: Silver
- Compatible with Embrace corner posts and extension profiles
- In-Line and Neo-Angle Panels are 8mm thick glass offering extra rigidity



Side Panel

- Embrace 900mm Pivot Door EF913S
- 900mm Side Panel EGL913S



In-Line Panel

- Embrace 760mm Bi-Fold Door EV7613S
- 400mm In-Line Panel EHL413S



Neo Panel Pack

- Embrace 760mm Bi-Fold Door EV7613S
- 1200 x 900mm Neo Angle Pack EP1213S

For Neo-Angle tray information see page 126

Size (mm)	Description	Adjustment (mm)	Glass Thickness (mm)	Product Suitability Code	Order Code
700	Side Panel	660 - 685	6	EF/EL/EV/ET/ETLE	EGL713S
760	Side Panel	720 - 745	6	EF/EL/EV/ET/ETLE	EGL7613S
800	Side Panel	760 - 785	6	EF/EL/EV/ET/ETLE	EGL813S
900	Side Panel	860 - 885	6	EF/EL/EV/ET/ETLE	EGL913S
1000	Side Panel	960 - 985	6	EF/EL/EV/ET/ETLE	EGL1013S
200	In-Line Panel	950 - 1000	8	EF76/EV76	EHL213S
300	In-Line Panel	1050 - 1100	8	EF76/EV76/EL76	EHL313S
400	In-Line Panel	1150 - 1200	8	EF/EV/EL	EHL413S
800	In-Line Panel	1532 - 1582	8	EV9/EL9/EF9	EHL813S
900 x 900	Neo Panel Pack	17 each side	8	EV76/EF76	EP913S*
1200 x 900	Neo Panel Pack	17 each side	8	EV76/EF76	EP1213S*
EZEXS	Extension profile	35 (extra)		EF/EV/EL/ET/E1T	EZEXS

*For use with Bi-fold and Pivot Doors
Please note that other configurations are available for In-Line Panels.

Contact Customer Services 01325 328035

Compatible Trays:	Page
Roman Anti-Slip Trays	122 - 123
Roman Infinity Trays	124 - 125
Roman Low Level Trays	128 - 129
Roman Shield System	147

Embrace

Trapezium

FOR REALLY AWKWARD BATHROOMS!



- Embrace Trapezium EAF13S01
- Shower Tray LAT1L
- Shower Basket RSB06

“ The inward opening solutions
to window problems ”

GLASS THICKNESS
8
Millimetres

GLASS THICKNESS
6
Millimetres

TOTAL HEIGHT
1900
Millimetres

REVERSIBLE

GLASS PROTECTION
ULTRA CARE
BY ROMAN

TRULIFE
LIFETIME
GUARANTEE

This ultimate space saving enclosure has been designed to overcome the most common UK bathroom problem; restrictions presented by a window, door position, or other bathroom furniture. The angled design and unique footprint uses the space economically to work around existing fittings, whilst only taking up space on a single wall. It also incorporates an inward opening Bi-Fold Door.



Features and Benefits:

- 6mm glass door
- 8mm glass Side Panels
- Frame: Silver
- Vertical adjustment: 25mm each profile
- Adjustment: 17mm in each profile
- Tray compatibility: LAT1 left or right handing

- Embrace Trapezium EAF13S01
- Shower Tray LAT1L
- Shower Basket RSB06

EAF13S01 on a
Left Hand Tray LAT1L



Dimensions: 1180 x 780mm:

- 760mm Door
- 900mm Angled Panel
- 760mm Side Panel

Roman Stone Tray

For best performance we recommend the use of Roman Trapezium Tray. Must indicate left or right handing of the tray e.g. LAT1L

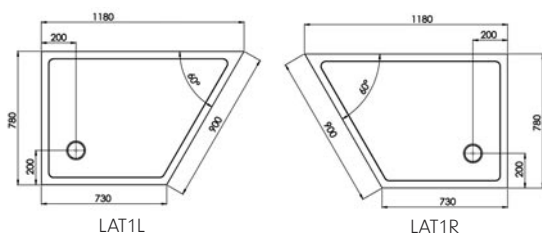

Description	Code
Trapezium Enclosure	EAF13S01
Left Hand Roman Stone Tray	LAT1L
Right Hand Roman Stone Tray	LAT1R

6mm
&
4mm

- Sliding Door Enclosures
- Bi-Fold Doors
- Side and In-Line Panels

Collage

Framed Collection

Affordable showering with uncompromised quality

Our Collage collection delivers a sense of subtle luxury to your bathroom, encompassing a shower concept to meet all your requirements - without compromising on quality. Innovative and affordable product designs meet contemporary and minimal styling.

“Success isn't something you achieve
by accident, but rather by design”

- David H. Murdoch

Bi-fold Door

GLASS THICKNESS
4
Millimetres

TOTAL HEIGHT
1900
Millimetres

REVERSIBLE

GLASS PROTECTION
ULTRA CARE
BY ROMAN

TRULIFE
LIFETIME GUARANTEE

Inward Opening



1200 x 700 Corner Fitting

- Bi-Fold Door C2V1213S
- Side Panel C2GM713S
- Roman Low Level Tray RLT127
- Shower Basket RSB06



1200 Alcove Fitting

- Bi-Fold Door C2V1213S
- Roman Low Level Tray RLT127
- Shower Basket RSB06

Features and Benefits:

- Frame: Silver
- Fully framed door with magnetic closing mechanism and cushioned seals
- Full length integral handle on inside and outside of door
- Precision roller bearing mechanism for smooth sliding action
- Tray compatibility: Tray or straight to floor using Roman Shield Wetroom System

Compatible Trays:	Page
Roman Anti-Slip Trays	122 - 123
Roman Infinity Trays	124 - 125
Roman Low Level Trays	128 - 129
Roman Shield System	147

“ Precision roller bearings for smooth sliding action ”

Size (mm)	Adjustment (mm)	Door Aperture (mm)	Code
700	650 - 705	470	C2V713S
760	680 - 735	500	C2V7613S
760/800	740 - 795	560	C2V13S
900	830 - 885	650	C2V913S
1000	940 - 995	760	C2V1013S
1200	1145 - 1200	965	C2V1213S

For the full range of compatible Collage Side Panels, In-Line Panels and Extension profiles see page 95

GLASS THICKNESS
4
Millimetres

TOTAL HEIGHT
1900
Millimetres

REVERSIBLE

GLASS PROTECTION
ULTRA CARE
by ROMAN

TRUELIFE
LIFETIME GUARANTEE

Sliding Door



Features and Benefits:

- Frame: Silver
- Fully framed door with magnetic closing mechanism and cushioned seals
- Full length integral handle on inside and outside of door
- Precision roller bearing mechanism for smooth sliding action
- Tray compatibility: Tray or straight to floor using Roman Shield Wetroom System

1200 x 700 Corner Fitting

- Sliding Door C2T1213S
- Side Panel C2GM713S
- Roman Low Level Tray RLT127
- Shower Basket RSB01

“The Collage sliding doors are perfect for confined or awkward spaces as they do not protrude out into the bathroom.”

Door Size (mm)	Adjustment (mm)	Door Aperture (mm)	Code
1200	1140 - 1195	450	C2T1213S

Compatible Trays:	Page
Roman Anti-Slip Trays	122 - 123
Roman Infinity Trays	124 - 125
Roman Low Level Trays	128 - 129
Roman Shield System	147

For the full range of compatible Collage Side Panels, In-Line Panels and Extension profiles see page 95

GLASS THICKNESS
6
Millimetres

TOTAL HEIGHT
1900
Millimetres



Side Panels

In-Line Panels

Features and Benefits:

- Frame: Silver
- All Collage Doors are suitable for all Collage Side Panels and In-Line Panels
- Outward opening doors must be hinged from the wall



- Collage 760/800mm Bi-Fold Door C2V13S
- 400mm Frameless In-Line Panel C2HM413S
- 700mm Frameless Side Panel C2GM13S
- Shower Basket RSB03



- Sliding Door C2T1213S
- Side Panel C2GM13S
- Shower Basket RSB01

Size (mm)	Panel Type	Adjustments (mm)	To suit tray size	Door compatibility code	Order Code
700	Side Panel	630 - 685	700mm side	C2V/C2T	C2GM713S
760	Side Panel	690 - 745	760mm side	C2V/C2T	C2GM7613S
800	Side Panel	730 - 785	800mm side	C2V/C2T	C2GM13S
900	Side Panel	830 - 885	900mm side	C2V/C2T	C2GM913S
1000	Side Panel	930 - 985	1000mm side	C2V/C2T	C2GM1013S
1200	Side Panel	1130 - 1185	1200mm side	C2V/C2T	C2GM1213S
200	In-Line Panel	940 - 1040	1000mm side	C2V7	C2HM213S
300	In-Line Panel	1030 - 1130	1100mm side	C2V76	C2HM313S
400	In-Line Panel	1145 - 1245	1200mm side	C2V	C2HM413S
-	Extension Profile	35mm extra	N/A	N/A	C2ZEXS

Please note that other configurations are available for In-Line Panels. Contact Customer Service 01325 328033.

10mm
&
8mm

Wetroom Panels

Wetroom Ranges

Straight Panels:

- Select
- Liberty
- Innov8
- Embrace
- Collage

Curved Panels:

- Lumin8
- Embrace

For Roman Shield Wetroom System
see page 147

Wetroom shower panels are a more open alternative to a shower enclosure, which usually consist of just one glass panel. This can either be positioned in a corner or on a straight wall. Wetroom panels can be installed onto a shower tray, or installed straight down to floor.

The Roman Wetroom Collection offers a variety of heights, shapes, glass thicknesses and price points – with a multitude of design options to choose from.

“Perfection is achieved not when there is nothing more to add, but when there is nothing left to take away.”

- Antoine de Saint-Exupery



Select Wetroom Solutions

Straight Panels

The perfect way to create a wetroom - tailored to your own style

Roman's Select Collection features our Wetroom Panel options, which can be fitted to our low level shower trays or straight to floor to create a true wetroom. We present a number of panel sizes and options, to help you create your perfect bathroom sanctuary. Included are the various configurations that are available to suit you and your bathroom.

All Panels are 2000mm high and available in either 8mm glass thickness or 10mm glass thickness.

Selecting your configuration

Select the size of panel you require in either 8 or 10mm glass thickness; select your configuration; select between a fixed or pivoting deflector panel; and select your desired bracing bars.



- Corner Panel
• Low Level Brace kit
- x2 Corner Panels
• x2 Low Level Brace kits
- x2 Corner Panels
• Low Level Brace kit
• Side Panel Brace kit
- Corner Panel (in Alcove)
• Low Level Brace kit
- Corner Panel
• Floor to Ceiling Brace kit
- x2 Corner Panels
• x2 Floor to Ceiling Brace kit
- Corner Panel
• Ceiling Brace kit
- Corner Panel
• Pivoting Deflector Panel
• High Level Brace kit
- x2 Corner Panels
• Fixed Deflector
• Low Level Brace kit
- x2 Corner Panel
• Glass to Glass Panel
• Deflector Panel
• Low Level Brace kit
- Linear Panel
• x2 Floor to Ceiling Brace kit
- Linear Panel
• x2 Low Level Brace kit
- Linear Panel
• x2 Pivoting deflector panels
• x2 Low Level Brace kit

This is just a selection of configurations which can be created using either 8mm or 10mm Select glass panels.

Please see pages 99 - 103 for more information

All panels are 2000mm in height

No brace bars included - please see pages 100 to select your style of Bracing required.

For Panel and Tray Packs see page 103.

- Due to the nature of the product water integrity cannot be guaranteed - please consult your installer

8mm Glass

10mm Glass

Description

Actual Width (mm) Order Code

Actual Width (mm) Order Code

Corner Panel (includes wall fixing kit allowing +/- 7.5mm of vertical adjustment). For brace bar options see page 100

400 Corner Panel	365mm	V8SP413S	350mm	V10SP413S
500 Corner Panel	465mm	V8SP513S	450mm	V10SP513S
600 Corner Panel	565mm	V8SP613S	550mm	V10SP613S
700 Corner Panel	665mm	V8SP713S	650mm	V10SP713S
760 Corner Panel	725mm	V8SP7613S	710mm	V10SP7613S
800 Corner Panel	765mm	V8SP813S	750mm	V10SP813S
900 Corner Panel	865mm	V8SP913S	850mm	V10SP913S
1000 Corner Panel	965mm	V8SP1013S	950mm	V10SP1013S
1100 Corner Panel	1065mm	V8SP1113S	1050mm	V10SP1113S
1200 Corner Panel	1165mm	V8SP1213S	1150mm	V10SP1213S
1400 Corner Panel	1365mm	V8SP1413S	1350mm	V10SP1413S

Deflector Panel (includes fixed or pivoting corner fixing kit) see page 102 for more details. For brace bar options see pages 100

200 Fixed Deflector Panel	226mm	V8SPL213S	226mm	V10SPL213S
200 Pivoting Deflector Panel	243mm	V8SPM213S	243mm	V10SPM213S
300 Pivoting Deflector Panel	343mm	V8SPM313S	343mm	V10SPM313S
400 Pivoting Deflector Panel	443mm	V8SPM413S	443mm	V10SPM413S

Linear Panel (includes freestanding floor fixing kit). For brace bar options see pages 100

1000 Linear Panel	955mm	V8LP1013S	940mm	V10LP1013S
1100 Linear Panel	1067mm	V8LP1113S	1040mm	V10LP1113S
1200 Linear Panel	1167mm	V8LP1213S	1140mm	V10LP1213S
1400 Linear Panel	1355mm	V8LP1413S	1340mm	V10LP1413S

Glass to Glass Panel (includes fixing kit). For brace bar options see pages 100

600 Glass to Glass Panel	567mm	V8FP613S	556mm	V10FP613S
700 Glass to Glass Panel	667mm	V8FP713S	656mm	V10FP713S
760 Glass to Glass Panel	727mm	V8FP7613S	716mm	V10FP7613S
800 Glass to Glass Panel	767mm	V8FP813S	756mm	V10FP813S
900 Glass to Glass Panel	867mm	V8FP913S	856mm	V10FP913S
1000 Glass to Glass Panel	967mm	V8FP1013S	956mm	V10FP1013S
1100 Glass to Glass Panel	1067mm	V8FP1113S	1056mm	V10FP1113S
1200 Glass to Glass Panel	1167mm	V8FP1213S	1156mm	V10FP1213S

Compatible Trays:	Page
Roman Anti-Slip Trays	122 - 123
Roman Infinity Trays	124 - 125
Roman Low Level Trays	128 - 129
Roman Shield System	147

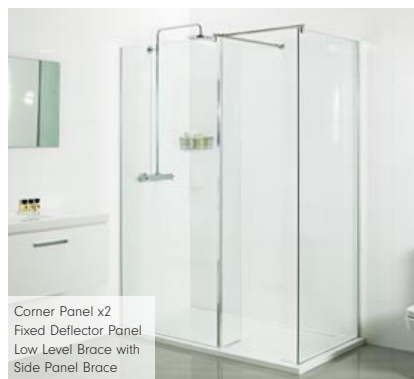
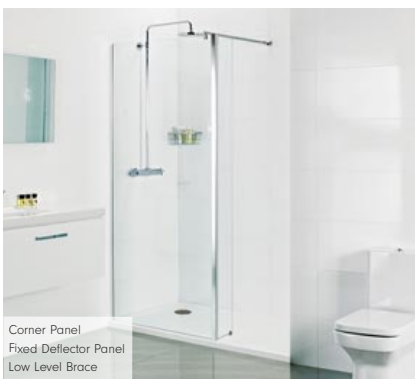

Brace Bars

Straight Panels

Roman provides a number of different styles of bracing bars, which can be used with 8mm and 10mm glass thicknesses. We offer all configurations that may be required and they can be cut and trimmed to the size required during installation to allow maximum flexibility and use of space. Bracing kits are used to provide added support for the glass and ensure that it is securely fitted in place.

We have something to suit the enclosure style, your bathroom area and your preference, to present the highest level of stability.



Round Brace Bars



Key:

1. Low Level Brace Kit *
2. Side Panel Brace Kit (for use with LBBK4590*)
3. Ceiling Brace Kit
4. Floor to Ceiling Brace Kit
5. High Level Brace Kit

Description	For use with glass thickness	Size (mm) Max	Adjustment (mm) Min	Code
Low Level Brace Kit*	6mm / 8mm / 10mm	1030	Cut to suit	LBBK4590
Side Panel Brace Kit (use with LBBK4590)	6mm / 8mm / 10mm	1000	Cut to suit	LBBKT90
Ceiling Brace Kit	6mm / 8mm / 10mm	1030	Cut to suit	LBBKC50
Floor to Ceiling Brace Kit	8mm	2700 high	Cut to suit	RF2C8KIT
High Level Brace Kit	6mm / 8mm / 10mm	1135	Cut to suit	FBBK10

*For use straight back to wall or can be cut to 45° if required for corner fixing as illustrated in 1 and 1(b).
N.B. Adjustments are measured from the wall to the inside of the glass.



Square Brace Bars



Key:

1. Low Level Brace Kit *
2. Side Panel Brace Kit (for use with LBBK4590SQ*)
3. Ceiling Brace Kit
4. Floor to Ceiling Brace Kit

Description	For use with glass thickness	Size (mm) Max	Adjustment (mm) Min	Code
Low Level Brace Kit*	6mm / 8mm / 10mm	1030	Cut to suit	LBBK4590SQ
Side Panel Brace Kit (use with LBBK4590SQ)	6mm / 8mm / 10mm	1000	Cut to suit	LBBKT90SQ
Ceiling Brace Kit	6mm / 8mm / 10mm	1030	Cut to suit	LBBKC50SQ
Floor to Ceiling Brace Kit	8mm	2700 high	Cut to suit	RF2C8KITSQ

*For use straight back to wall or can be cut to 45° if required for corner fixing as illustrated in 1 and 1(b).
N.B. Adjustments are measured from the wall to the inside of the glass.

Deflector Panels

Fixed or Pivoting

Straight Panels



1400 x 900 Corner Fitting

- Corner Panel V8SP1413S (x2)
- Pivoting Deflector Panel V8SPM213S
- Brace Bars LBBK4590SQ, LBBKT90SQ
- Infinity Shower Tray IA149
- Shower Basket RSB01



Pivoting Panel

Features and Benefits:

- Retro Fitable
- Improve water integrity
- Rotates through 180°
- Smooth pivot motion
- Stows when not in use to improve access

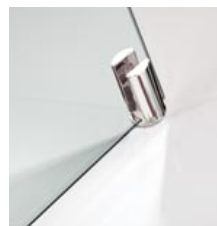

Adjustable Foot

Due to the nature of the product water integrity cannot be guaranteed - please consult your installer



Fixed Panel

Features and Benefits:

- Retro Fitable
- Improve water integrity
- Panel Foot adjusts from 4mm to 29mm to accommodate high and low level trays
- Panel foot is chromed brass with soft rubber base
- Panel foot is cut down on site to suit the shower tray

Panels & Trays Packs

Alcove or Corner



Alcove Pack

Alcove Package includes:

1 Panel, Wall Fixing Kit,
1 Brace Bar (LBBK4590),
Tray and 90mm Waste



Corner Pack

Corner Package includes:

2 Panels, Wall Fixing Kits,
2 Brace Bars (LBBK4590 & LBBKT90),
Tray and 90mm Waste

Tray included with the pack is a Roman Acrylic Capped Stone low level 40mm in height.

For full tray details see pages 128

Description	Tray Size (mm)	8mm Glass Thickness		10mm Glass Thickness	
		Order code	Order Code	Order Code	Order Code
Alcove Panel Pack	1400 x 900	V8W149AS	V10W149AS		
Alcove Panel Pack	1500 x 800	V8W158AS	V10W158AS		
Alcove Panel Pack	1600 x 800	V8W168AS	V10W168AS		
Alcove Panel Pack	1700 x 800	V8W178AS	V10W178AS		
Corner Panel Pack	1400 x 900	V8W149CS	V10W149CS		
Corner Panel Pack	1500 x 800	V8W158CS	V10W158CS		
Corner Panel Pack	1600 x 800	V8W168CS	V10W168CS		
Corner Panel Pack	1700 x 800	V8W178CS	V10W178CS		

Compatible Trays:	Page
Roman Anti-Slip Trays	122 - 123
Roman Infinity Trays	124 - 125
Roman Low Level Trays	128 - 129
Roman Shield System	147

Wetrooms

Liberty

Black Grid

Wetroom Panels with Matt Black finish

Straight Panels



1600 x 800 - Corner Fitting

- Corner Panel KLCP9GPB
- Corner Panel KLCP8GPB
- Brace Bars LBBKC50SQB x 2
- Infinity Shower Tray IA168

“The best way to predict the future is to create it”

- Abraham Lincoln



GLASS THICKNESS
10
Millimetres

TOTAL HEIGHT
2000
Millimetres



Features and Benefits:

- Frame: Matt Black
- Vertical adjustment: $\pm 7.5\text{mm}$
- Tray compatibility: Tray or straight to floor using Roman Shield Wetroom System
- Unique sealing tape system technology to reduce the need for silicone
- Due to the nature of the product water integrity cannot be guaranteed - please consult your installer
- Glass filled paint fired into the glass during toughening
- Silicone Free Wall Fixing

1600 x 800 Corner Fitting

- Corner Panel KLCP9GPB
- Corner Panel KLCP8GPB
- Pivoting Deflector Panel KLSPM3GPB
- Brace Bar LBBKC50SQB
- Infinity Shower Tray IA168



Panels

Size (mm)	Description	Adjustment (mm)	Code
757	Black Grid Corner Panel	$\pm 7.5\text{mm}$	KLCP8GPB
857	Black Grid Corner Panel	$\pm 7.5\text{mm}$	KLCP9GPB
957	Black Grid Corner Panel	$\pm 7.5\text{mm}$	KLCP10GPB
1057	Black Grid Corner Panel	$\pm 7.5\text{mm}$	KLCP11GPB
1157	Black Grid Corner Panel	$\pm 7.5\text{mm}$	KLCP12GPB
243	Black Grid Pivoting Deflector Panel		KLSPM3GPB

Brace Bars

Size (mm)	Description	Adjustment (mm)	Code
1030 max	Square Low Level Brace Bar Kit	Cut to Suit	LBBK4590SQB
1030 max	Square Ceiling Brace Kit	Cut to Suit	LBBKC50SQB

Compatible Trays:	Page
Roman Anti-Slip Trays	122 - 123
Roman Infinity Trays	124 - 125
Roman Low Level Trays	128 - 129
Roman Shield System	147

Liberty

Wetroom Panels

with Matt Black finish and clear glass

Straight Panels



1600 x 800 Tray

- Corner Panel KLCP813B
- Pivoting Deflector Panel KLSPM313B
- Brace Bar LBBKC50SOB
- Infinity Shower Tray IA168

GLASS THICKNESS
10
Millimetres

TOTAL HEIGHT
2000
Millimetres

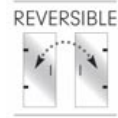

GLASS PROTECTION
ULTRA CARE
BY ROMAN

TRUELIFE
LIFETIME
GUARANTEE

Features and Benefits:

- Frame: Matt Black
- Vertical adjustment: ± 7.5 mm
- Tray compatibility: Tray or straight to floor using Roman Shield Wetroom System
- Unique sealing tape system technology to reduce the need for silicone
- Due to the nature of the product water integrity cannot be guaranteed - please consult your installer
- Silicone Free Wall Fixing



1200 Corner Panel

- Corner Panel KLCP1213B
- Brace Bar LBBK4590SQB

Panels

Size (mm)	Description	Adjustment (mm)	Code
757	Clear Glass Corner Panel	± 7.5 mm	KLCP813B
857	Clear Glass Corner Panel	± 7.5 mm	KLCP913B
957	Clear Glass Corner Panel	± 7.5 mm	KLCP1013B
1057	Clear Glass Corner Panel	± 7.5 mm	KLCP1113B
1157	Clear Glass Corner Panel	± 7.5 mm	KLCP1213B
243	Clear Glass Pivoting Deflector Panel		KLSPM313B

Brace Bars

Size (mm)	Description	Adjustment (mm)	Code
1030 max	Square Low Level Brace Bar Kit	Cut to Suit	LBBK4590SQB
1030 max	Square Ceiling Brace Kit	Cut to Suit	LBBKC50SQB

Compatible Trays:	Page
Roman Anti-Slip Trays	122 - 123
Roman Infinity Trays	124 - 125
Roman Low Level Trays	128 - 129
Roman Shield System	147

Bi-Fold Wetroom Panels

Straight Panels



1000 Wetroom Panel
• N2VC1013S

“This innovative wetroom panel creates a large and open space to enter the showering area.”



Folded position

GLASS THICKNESS
8
Millimetres

TOTAL HEIGHT
1967
Millimetres



GLASS PROTECTION
ULTRA CARE
BY ROMAN

TRUELIFE
LIFETIME
GUARANTEE

Features and Benefits:

- Frameless inward/outward folding panels
- Bright silver profile
- Chromed brass hinges
- Chromed brass top caps
- Clear seals
- No top rail
- Elimination of the bottom rail creating level access entry
- Due to the nature of the product water integrity cannot be guaranteed - please consult your installer

Folding positions:

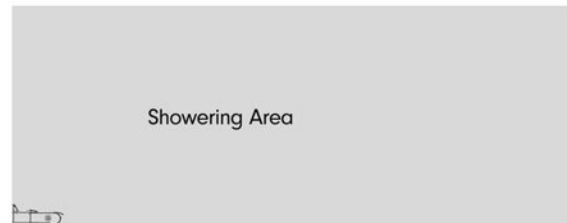
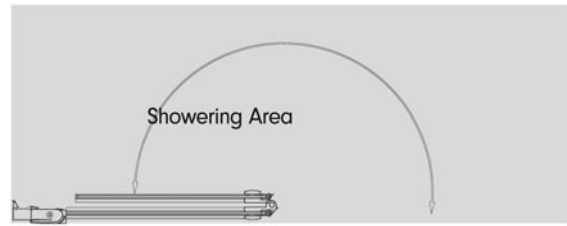

Panel Size (mm)	Adjustment (mm)	Order Code
800	760 - 780	N2VC813S
900	860 - 880	N2VC913S
1000	960 - 980	N2VC1013S

Compatible Trays:	Page
Roman Anti-Slip Trays	122 - 123
Roman Infinity Trays	124 - 125
Roman Low Level Trays	128 - 129
Roman Shield System	147

Embrace

Wetroom Panels

Straight Panels



Corner Panel

- Embrace 900mm Corner Panel ESP913S
- Roman Shield Wetroom System
- Shower Basket RSB01



Linear Panel

- Embrace 927mm Linear Panel ELLP1013S
- Roman Shield Wetroom System
- Shower Basket RSB04



900 Corner Panel

- Embrace 200mm Pivoting L Panel ESPM213S fitted to Embrace 1100mm Corner Wetroom Panel ESP1113S and Wetroom Panel ESP813S
- Glass Infinity Tray IAG168
- Shower Basket RSB01

“Roman’s wetroom panels offer style and sophistication with a seamless glass panel and sleek chrome profile.”



LBBK4590 brace bar



LBBK4590 brace bar cut to 45°

GLASS
THICKNESS
8
Millimetres

TOTAL
HEIGHT
2000
Millimetres

GLASS
PROTECTION
**ULTRA
CARE**
BY ROMAN

TRUELIFE
**LIFETIME
GUARANTEE**

Features and Benefits:

- Frame: Silver
- LBBK4590 brace bar supplied
- Two LBBK4590 brace bars supplied with Linear Panels
- Chromed top caps
- Maximum distance from wall when using bracing 1060mm
- ESP - reversible for left or right hand fixing
- Due to the nature of the product water integrity cannot be guaranteed - please consult your installer
- Tray compatibility: Tray or straight to floor using Roman Shield Wetroom System

Wetroom Panels

Size (mm)	Description	Adjustments (mm)	Code
600	Corner Panel	578 - 603	ESP613S
700	Corner Panel	678 - 703	ESP713S
800	Corner Panel	778 - 803	ESP813S
900	Corner Panel	878 - 903	ESP913S
1000	Corner Panel	978 - 1003	ESP1013S
1100	Corner Panel	1078 - 1103	ESP1113S
1200	Corner Panel	1178 - 1203	ESP1213S
1400	Corner Panel	1378 - 1403	ESP1413S
827	Linear Panel	35 in wall cup	ELLP913S
927	Linear Panel	35 in wall cup	ELLP1013S
1127	Linear Panel	35 in wall cup	ELLP1213S
1327	Linear Panel	35 in wall cup	ELLP1413S

For alternative styles of bracing bars please see pages 100 - 101

Compatible Trays:	Page
Roman Anti-Slip Trays	122 - 123
Roman Infinity Trays	124 - 125
Roman Low Level Trays	128 - 129
Roman Shield System	147

Pivoting 'L' Panel

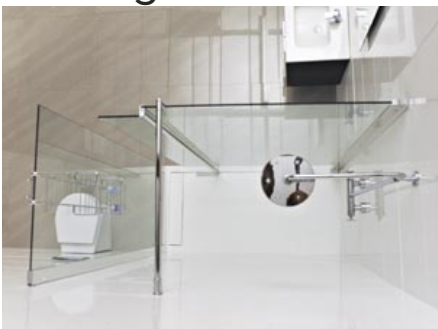

Additional Features and Benefits:

- Retro-fit panel suitable for all ESP and ELLP panels
- Rotates through 180°
- Smooth pivoting motion
- Chromed decorative top caps

Pivoting 'L' Panel

Size (mm)	Adjustments (mm)	Code
200	n/a	ESPM213S
300	n/a	ESPM313S
400	n/a	ESPM413S
600	578 - 603	ESP613S
800	778 - 803	ESP813S
900	878 - 903	ESP913S

Where fitting with return panel is required please use one of the following

Collage

Reduced Height Panels

Suitable when ceiling height is limited

Straight Panels



1200 Corner Panel

- Corner Panel CSP1213S with Standard Brace Bar FBBK10
- Matt Infinity Tray IA128
- Shower Basket RSB01

Retro Fit Return Panel Kit*





GLASS THICKNESS
8
Millimetres

TOTAL HEIGHT
1830
Millimetres

REVERSIBLE

GLASS PROTECTION
ULTRA CARE
BY ROMAN

TRUELIFE
LIFETIME GUARANTEE

Features and Benefits:

Corner and Linear Panels

- Frame: Silver
- Vertical adjustment: 30mm each profile
- Tray compatibility: Tray or straight to floor using Roman Shield Wetroom System

Return Panel

- Panel foot adjusts from 8mm to 64mm to accommodate high and low level trays
- Panel foot is chromed brass with soft rubber base
- Panel foot is cut down on site to suit the shower tray
- Return panel width is 218mm
- Return panels available as an 'add on' kit CSPL213S
- All sizes suitable for wetroom floor installation

900 Linear Panel

- Linear Panel CLLP913S with Brace Bars FBBK10
- Roman Low Level Tray RLT127
- Shower Basket RSB05

Corner and Linear Panel

Size (mm)	Description	Adjustments (mm)	Brace Bars	Code
200	Corner Panel	247 - 277	Not included	CSP213S
600	Corner Panel	577 - 607	Not included	CSP613S
700	Corner Panel	655 - 685	Not included	CSP713S
800	Corner Panel	792 - 822	Not included	CSP813S
900	Corner Panel	892 - 922	Not included	CSP913S
1000	Corner Panel	992 - 1022	Inc. FBBK10	CSP1013S*
1200	Corner Panel	1192 - 1222	Inc. FBBK10	CSP1213S*
1400	Corner Panel	1392 - 1422	Inc. FBBK10	CSP1413S*
850	Linear Panel	N/A	Inc. Two FBBK10	CLLP913S*
950	Linear Panel	N/A	Inc. Two FBBK10	CLLP1013S*

* includes FBBK10 brace bar kit allowing adjustment of up to 1140mm from wall

Corner Panel + 'L' Shaped Panel

Size (mm)	Description	Adjustments (mm)	To suit tray size	Code
800 x 200	Corner + Return Panel	799 - 829	900mm and above	CSPL813S
900 x 200	Corner + Return Panel	899 - 929	1000mm and above	CSPL913S
1000 x 200	Corner + Return Panel	999 - 1029	1100mm and above	CSPL1013S
1200 x 200	Corner + Return Panel	1199 - 1229	1400mm and above	CSPL1213S
218	*Retro Fit Return Panel Kit for use with any Collage Corner or Linear Panel			CSPL213S

* includes FBBK10 brace bar kit allowing adjustment of up to 1140mm from wall

Compatible Trays:	Page
Roman Anti-Slip Trays	122 - 123
Roman Infinity Trays	124 - 125
Roman Low Level Trays	128 - 129
Roman Shield System	147

Lumin8

Colossus

Curved Panels



1700 Colossus

- 1700mm Colossus V8C13S
- Shower Tray FC1R (right hand)
- Shower Basket RSB06



1450 Colossus with 1 Side Panel

- 1450mm Colossus V8CG213S
- Shower Tray FCT1R (right hand)
- Shower Basket RSB06



“ The perfect bath replacement product ”



1600 Colossus with Side Panel

- 1600mm Colossus V8GP13S

GLASS THICKNESS
8
Millimetres

REVERSIBLE

GLASS PROTECTION
ULTRA CARE
BY ROMAN

TRULIFE
LIFETIME GUARANTEE

Features and Benefits:

- Bright silver frame
- 25mm vertical adjustment
- Chrome top caps
- Tray Compatibility: Suitable for dedicated tray or straight to floor using Roman Shield Wetroom System
- Due to the nature of the product water integrity cannot be guaranteed - please consult your installer

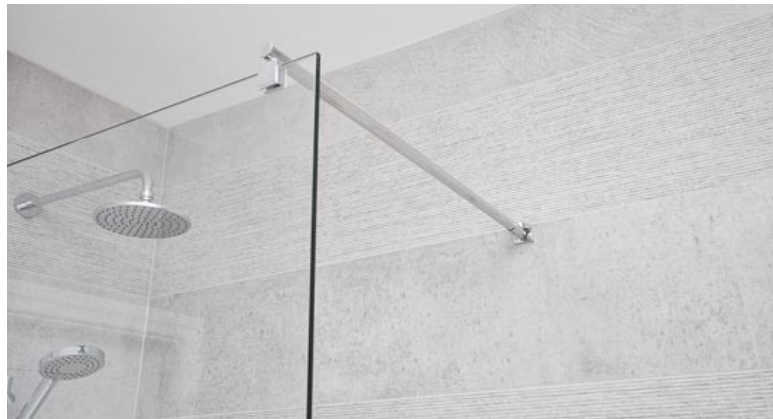

Tray Size (mm)	Description	Fixed Panel (mm)	Height (mm)	Adjustments (mm)	Aperture (mm)	Tray Compatibility Code	Order Code
1700	Colossus	1202	1950	25	478	FC1	V8C13S
1700	Colossus + 1 Side Panel	1202	1950	25	456	FC1	V8CG13S
1700	Colossus + Return Panel	1202	1950	25	456	FC1	V8CGM13S
1700	Colossus + 2 Side Panels	1202	1950	25	456	FC1	V8CGR13S
1600	Curved Panel With Towel Rail	775	2000	25	791	V8GT	V8GP13S
800	Optional Side Panel	706	2000	25	762	V8GT	V8GPA
1450	Colossus	963	1950	25	475	FCT1	V8C213S
1450	Colossus + 1 Side Panel	963	1950	25	442	FCT1	V8CG213S
1450	Colossus + Return Panel	963	1950	25	442	FCT1	V8CGM213S
1450	Colossus + 2 Side Panels	963	1950	25	442	FCT1	V8CGR213S

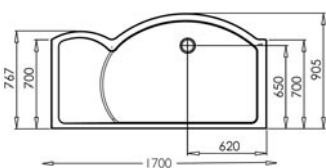

1700 FC1L - Left Hand Low Level Tray

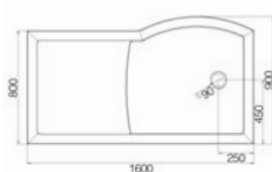

1600 V8GTL - Left Hand Low Level Tray

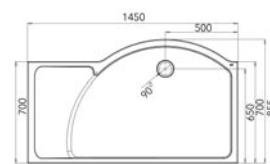

1450 FCT1L - Left Hand Low Level Tray

Tray handing must be specified - for tray colours and pricing please see page 127

Lumin8

Curved Wetroom Panel

Curved Panels



1400 Curved Panel with Side Panel

- 1400mm V8HP13S
- Side Panel V8HPA
- Tray V8HTL (left hand)

“ The curved glass sits perfectly in the specially designed tray. ”

GLASS THICKNESS
8
Millimetres

TOTAL HEIGHT
2030
Millimetres



GLASS PROTECTION
ULTRA CARE
BY ROMAN

TRUELIFE
LIFETIME GUARANTEE



1400 Curved Panel

- 1400mm V8HP13S
- Tray V8HTL (left hand)

Features and Benefits:

- Glass height 2000mm
- Height to top of brace bar 2030mm
- 25mm Vertical Adjustment
- Chrome top caps
- Tray Compatibility: Suitable for dedicated tray or straight to floor using Roman Wetroom System.
- Due to the nature of the product water integrity cannot be guaranteed - please consult your installer

Panel Size (mm)	Tray Size (mm)	Description	Adjustment (mm)	Tray Size (mm)	Code
806	1400	Lumin8 Curved Panel	25	1400	V8HP13S
663	900	Lumin8 Optional Side Panel	25	900	V8HPA

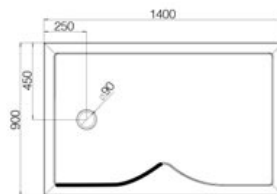

1400 V8HTL - Left Hand Low Level Tray

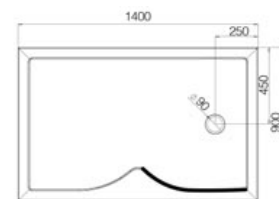

1400 V8HTR - Right Hand Low Level Tray

Tray handing must be specified - for tray colours and pricing please see page 127

Embrace

Curved Wetroom Panel

designed to suit any rectangular tray

Curved Panels



1200 x 800 Corner Fitting

- Embrace 700mm Curved Wetroom Panel ESPC713S
- Roman Low Level Tray RLT128
- Shower Basket RSB03

GLASS THICKNESS
10
Millimetres

TOTAL HEIGHT
2030
Millimetres

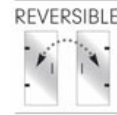

“ I think there is always a need for pure design.
With pure design, you don't need so much decoration.”
- Jil Sander



Corner Fitting

- 800mm Curved Wetroom Panel ESPC813S
- Corner Wetroom Panel ESP713S
- Roman Low Level Tray RLT128
- Shower Basket RSB03

Features and Benefits:

- Glass Height 2000mm
- Height with brace bar 2030mm
- Frame: Silver
- Bright silver frame with 25mm of adjustment
- Chromed brass adjustable panel foot included
- Chromed top caps
- For use in alcove or corner with additional panel
- Due to the nature of the product water integrity cannot be guaranteed - please consult your installer
- Tray compatibility: Tray or straight to floor using Roman Shield Wetroom System



Adjustable foot

Size (mm)	Description	Suit Tray Size:					Adjustment (mm)	Order Code
		1100	1200	1400	1500	1600		
700	Curved Panel	460	560	N/A	N/A	N/A	615 - 640	ESPC713S
800	Curved Panel	N/A	390	590	N/A	N/A	785 - 810	ESPC813S
900	Curved Panel	N/A	N/A	490	590	690	885 - 910	ESPC913S

Where fitting with Corner Panel is required for corner installation (illustrated above) please use one of the following:

Size (mm)	Description	Adjustment (mm)	Order Code
600	Corner Panel	578 - 603	ESP613S
700	Corner Panel	678 - 703	ESP713S
800	Corner Panel	778 - 803	ESP813S
900	Corner Panel	878 - 903	ESP913S

Compatible Trays:	Page
Roman Anti-Slip Trays	122 - 123
Roman Infinity Trays	124 - 125
Roman Low Level Trays	128 - 129
Roman Shield System	147

Trays

- Anti-Slip Trays
- Infinity Trays
- Shimmer Trays
- Neo-Angle Trays
- Lumin8 trays
- Roman Low Level Trays

Our diverse range of trays and wetroom solutions offer the user a choice of installations depending on the desired finish.

Our range of level access shower trays is manufactured from solid surface material, and cleverly create a simulated wetroom look. These solid surface trays are available in a range of sizes, and incorporates our Infinity Tray range which has a single angle flow to waste with a stylish load bearing solid surface waste cover. Our Infinity Tray collection also presents true originality with our low level Shimmer Trays, featuring a stunning shimmer finish. These unique designs include black, grey and white shimmer finishes. The standard acrylic capped stone shower trays are also available in a selection of heights, shapes and sizes.

“Design is a constant challenge to balance comfort with luxe, the practical with the desirable”

Donna Karan

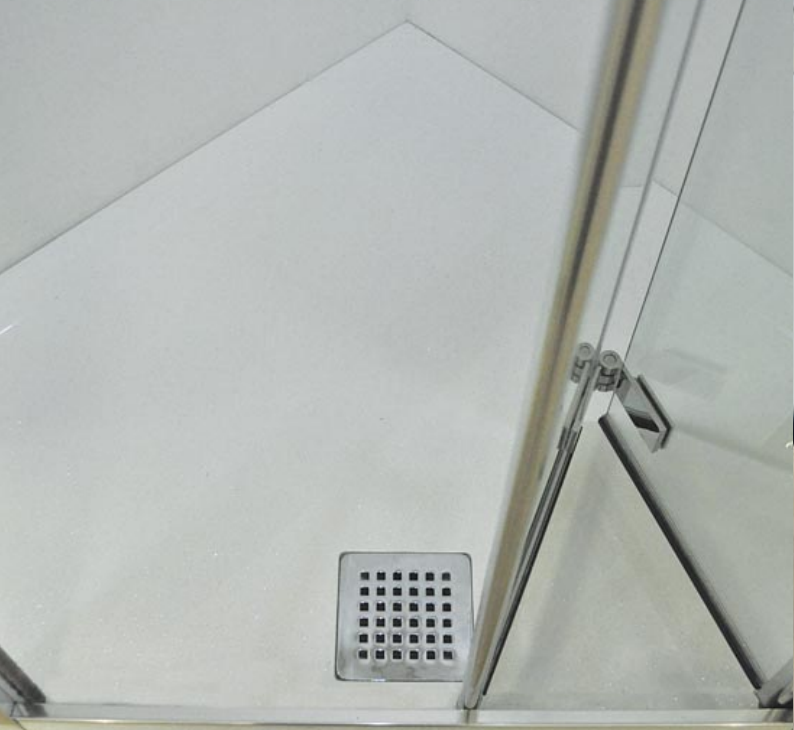

Anti-Slip Trays



Features and Benefits:

- Ultra low 50mm profile
- Manufactured using Roman Stone solid surface technology
- One angle of slope to waste to maximise flow rating
- Fast flow waste included
- Solid Surface Plinth and Leg Set available if required
- Chrome plated domed waste



Anti Slip Trays

Matt Trays have been tested to:

BS7976-2:2002+A1:2013 - Slip potential - low DIN 51097:1992 Class C



Grey Anti-Slip Tray

“ Matt finish cannot wear - permanent anti-slip ”



1000 x 800mm

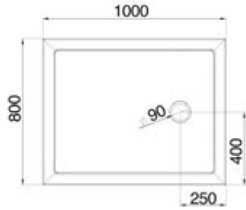

1200 x 800mm

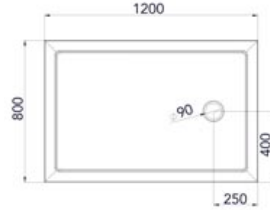

1200 x 900mm

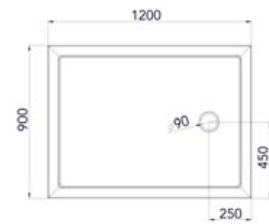

1300 x 800mm

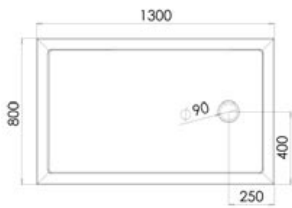

1400 x 900mm

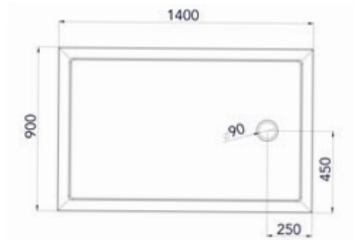

1500 x 800mm

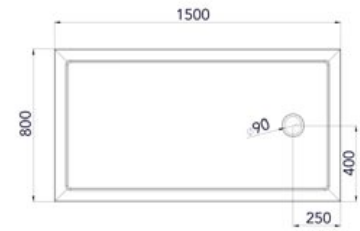

1600 x 700mm

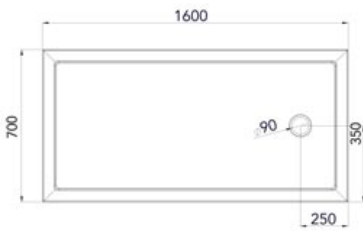

1600 x 800mm

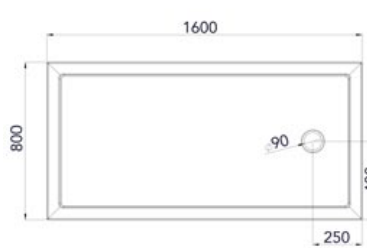

1700 x 800mm



Tray with Leg Kit

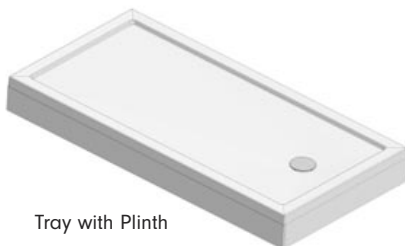

Tray with Plinth

Tray Size (mm)	Description	Finish	White Tray Code	Grey Tray Code
1000 x 800	Anti-Slip Tray	Matt	RST108	RST108MG
1200 x 800	Anti-Slip Tray	Matt	RST128	RST128MG
1200 x 900	Anti-Slip Tray	Matt	RST129	RST129MG
1300 x 800	Anti-Slip Tray	Matt	RST138	RST138MG
1400 x 900	Anti-Slip Tray	Matt	RST149	RST149MG
1500 x 800	Anti-Slip Tray	Matt	RST158	RST158MG
1600 x 700	Anti-Slip Tray	Matt	RST167	RST167MG
1600 x 800	Anti-Slip Tray	Matt	RST168	RST168MG
1700 x 800	Anti-Slip Tray	Matt	RST178	RST178MG
PLINTH AND LEG SET				
Standard Riser Kit			RSTRK01	RSTRK02



Infinity Trays

Level Access Installation

Anti-Slip options*

Our Infinity Trays offer a breakthrough in technology as they can be installed straight to joists so that once the floor tiles are laid it creates level entry access into the shower area. Manufactured from Roman Stone, the Infinity Trays are strong and durable. This product provides the added reassurance of a tray, with the minimalist design and level access of a wetroom. The waste is suitable for power shower systems and carries away 25 litres of water per minute.

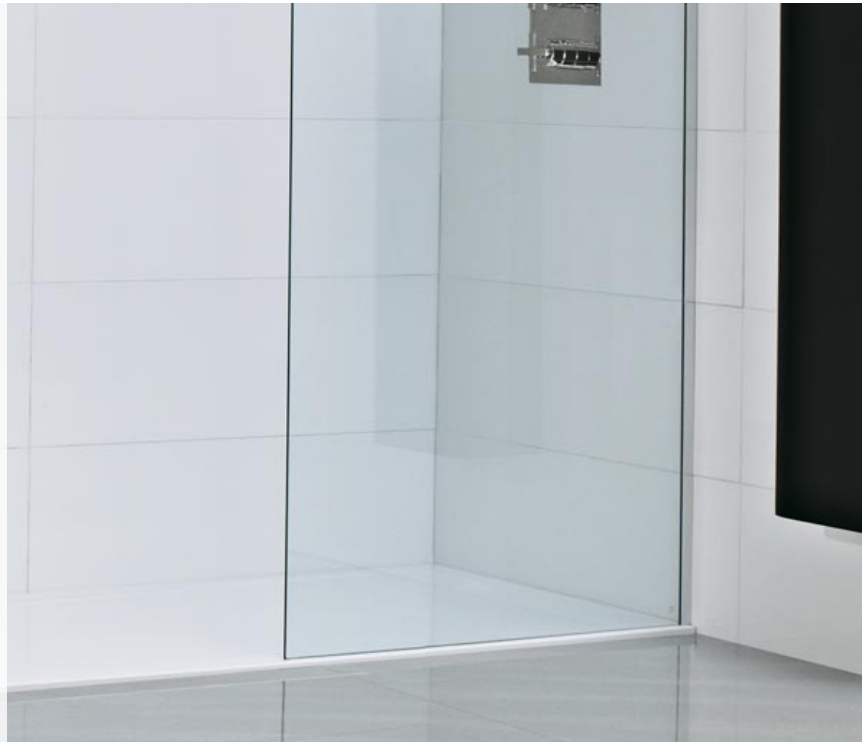

Features and Benefits:

- Ultra low profile 40mm nominal height
- Gloss or Matt* finish available in white
- Shimmer options in gloss only
- Manufactured using Roman Stone Solid Surface Technology
- One angle of slope to waste to maximise flow rating
- Fast flow waste included, fully concealed with solid surface cover piece
- Due to the nature of the product water integrity cannot be guaranteed when fitting with a wetroom panel. Please consult your installer

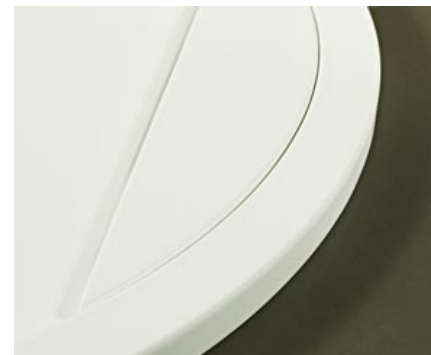

* Anti Slip Trays
 Matt Trays have been tested to:
 BS7976-2:2002+A1:2013 - Slip potential - low DIN 51097:1992 Class C

Shimmer Trays

Exclusive additions to our Infinity Tray collection are original low level shower trays, featuring a stunning shimmer finish. These unique additions include a black, grey and white shimmer finishes.

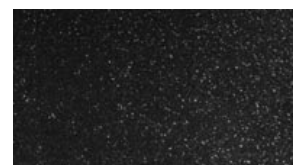

Black Shimmer

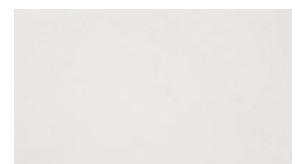

White Shimmer

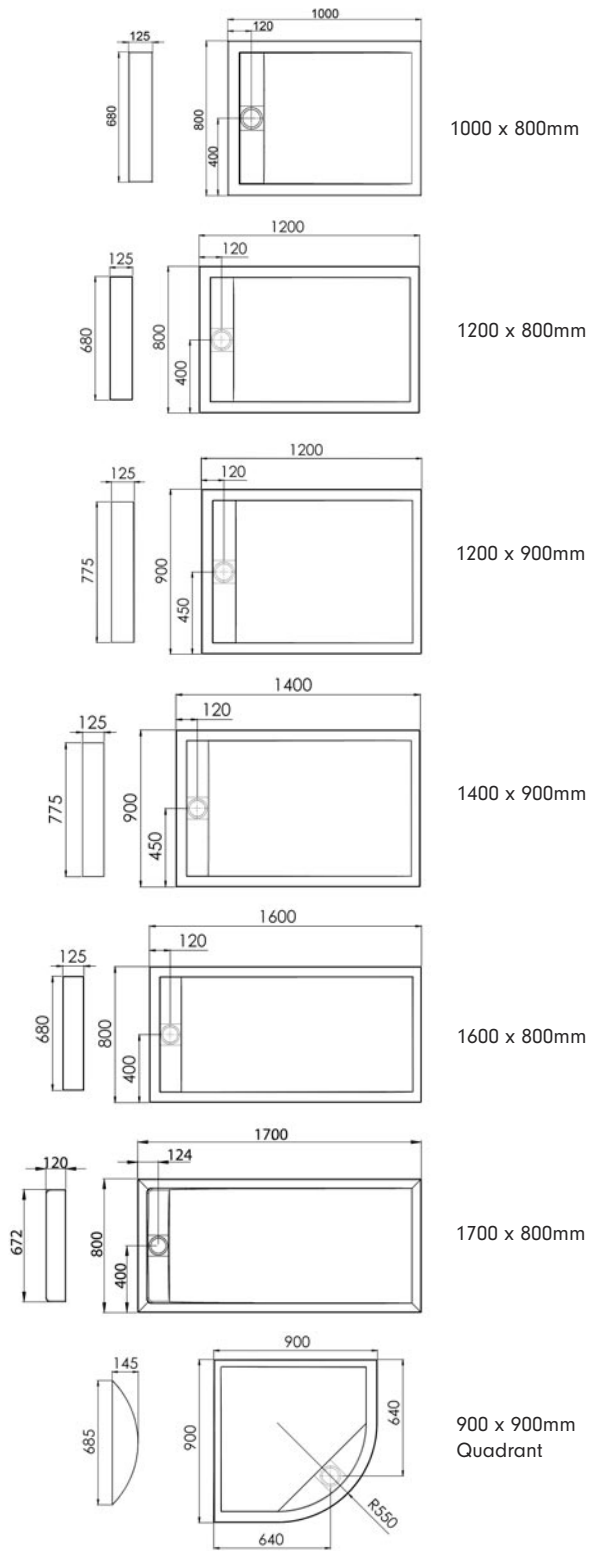

Size (mm)	Colour	Finish	Code
RECTANGLE			
1000 x 800	White	Matt	IA108*
1000 x 800	White	Gloss	IAG108
1000 x 800	Shimmer Black	Gloss	IAG108B
1000 x 800	Shimmer White	Gloss	IAG108W
1000 x 800	Shimmer Grey	Gloss	IAG108G
<hr/>			
1200 x 800	White	Matt	IA128*
1200 x 800	White	Gloss	IAG128
1200 x 800	Shimmer Black	Gloss	IAG128B
1200 x 800	Shimmer White	Gloss	IAG128W
1200 x 800	Shimmer Grey	Gloss	IAG128G
<hr/>			
1200 x 900	White	Matt	IA129*
1200 x 900	White	Gloss	IAG129
1200 x 900	Shimmer Black	Gloss	IAG129B
1200 x 900	Shimmer White	Gloss	IAG129W
1200 x 900	Shimmer Grey	Gloss	IAG129G
<hr/>			
1400 x 900	White	Matt	IA149*
1400 x 900	White	Gloss	IAG149
1400 x 900	Shimmer Black	Gloss	IAG149B
1400 x 900	Shimmer White	Gloss	IAG149W
1400 x 900	Shimmer Grey	Gloss	IAG149G
<hr/>			
1600 x 800	White	Matt	IA168*
1600 x 800	White	Gloss	IAG168
1600 x 800	Shimmer Black	Gloss	IAG168B
1600 x 800	Shimmer White	Gloss	IAG168W
1600 x 800	Shimmer Grey	Gloss	IAG168G
<hr/>			
1700 x 800	White	Matt	IA178*
1700 x 800	White	Gloss	IAG178
1700 x 800	Shimmer Black	Gloss	IAG178B
1700 x 800	Shimmer White	Gloss	IAG178W
1700 x 800	Shimmer Grey	Gloss	IAG178G
<hr/>			
QUADRANT			
900 x 900	White	Matt	IA9Q*
900 x 900	White	Gloss	IAG9Q
900 x 900	Shimmer Black	Gloss	IAG9QB
900 x 900	Shimmer White	Gloss	IAG9QW
900 x 900	Shimmer Grey	Gloss	IAG9QG

Neo-Angle Trays



Features and Benefits:

- Ultra low profile
- Gloss or Matt* finish available in white
- Shimmer options in gloss only
- Manufactured using Roman Stone Solid Surface Technology

Anti-Slip options*

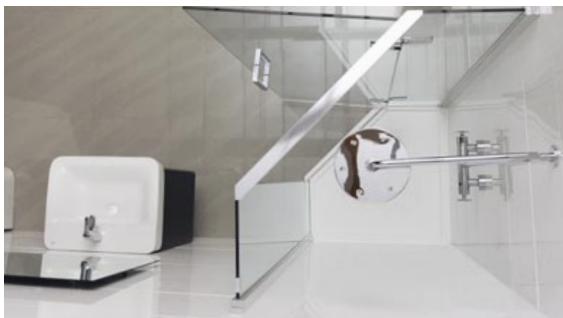

DNT9



DNT129 Right Hand

DNT129 Left Hand

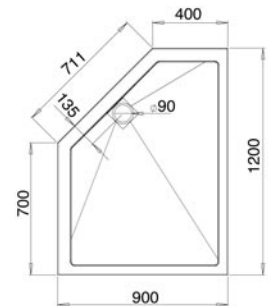
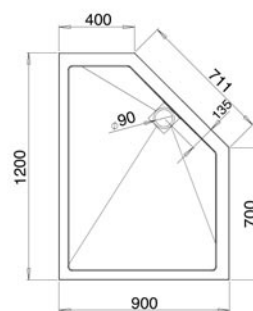
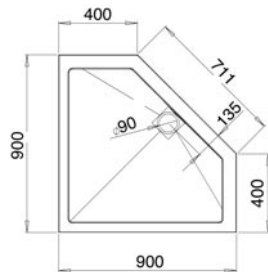

“25 litres per minute drainage”

Waste Dimensions

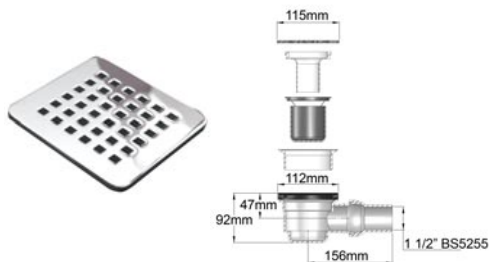

Size (mm)	Tray Colour	Finish	Code
900	White	Matt	DNT9*
900	White	Gloss	DNTG9
1200 x 900 LH	White	Matt	DNT129L*
1200 x 900 LH	White	Gloss	DNTG129L
1200 x 900 RH	White	Matt	DNT129R*
1200 x 900 RH	White	Gloss	DNTG129R

900	Shimmer Black	Gloss	DNT9B
1200 x 900 LH	Shimmer Black	Gloss	DNT129LB
1200 x 900 RH	Shimmer Black	Gloss	DNT129RB

900	Shimmer White	Gloss	DNT9W
1200 x 900 LH	Shimmer White	Gloss	DNT129LW
1200 x 900 RH	Shimmer White	Gloss	DNT129RW

900	Shimmer Grey	Gloss	DNT9G
1200 x 900 LH	Shimmer Grey	Gloss	DNT129LG
1200 x 900 RH	Shimmer Grey	Gloss	DNT129RG



* Anti Slip Trays
Matt Trays have been tested to:
BS7976-2:2002+A1:2013 - Slip potential - low DIN 51097:1992 Class C

Lumin8 Trays

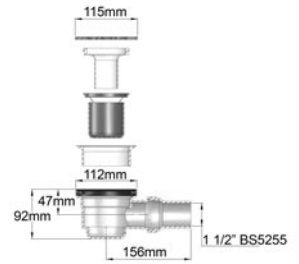

Lumin8 Tray Waste Dimensions

Features and Benefits:

- Ultra low profile
- 50mm nominal height
- Roman Stone Solid Surface Technology
- Gloss gel coated surface and matt satin options
- Includes chrome grid waste and fast flow trap
- Suitable for use with power shower systems rated up to 25 litres per minute

All Lumin8 Trays are right or left handed depending upon requirements. Please ensure you order the correct code for the handing required.

LH = Left Hand RH = Right Hand

Anti-Slip options*



* Anti Slip Trays

Matt Trays have been tested to:
BS7976-2:2002+A1:2013 -Slip potential - low DIN 51097:1992 Class C

Lumin8 Colossus Tray

(see pages 114 - 115 for Lumin8 Colossus details)

Lumin8 1450 Colossus Tray

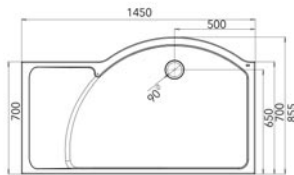

Left Hand FCT1L

Lumin8 1600 Colossus Tray

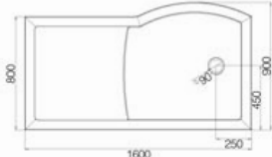

Left Hand V8GT

Lumin8 1700 Colossus Tray

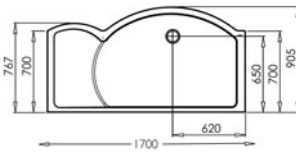

Left Hand - FC1L

Size (mm)	Tray Colour	Finish	Code
1700 x 700 LH	White	Matt	FC1L*
1700 x 700 RH	White	Matt	FC1R*
1700 x 700 LH	White	Gloss	FCG1L
1700 x 700 RH	White	Gloss	FCG1R
1700 x 700 LH	Shimmer Black	Gloss	FCG1LB
1700 x 700 RH	Shimmer Black	Gloss	FCG1RB
1700 x 700 LH	Shimmer White	Gloss	FCG1LW
1700 x 700 RH	Shimmer White	Gloss	FCG1RW
1700 x 700 LH	Shimmer Grey	Gloss	FCG1LG
1700 x 700 RH	Shimmer Grey	Gloss	FCG1RG

1600 x 800 LH	White	Matt	V8GTLW*
1600 x 800 LH	Grey	Matt	V8GTLG*
1600 x 800 RH	White	Matt	V8GTRW*
1600 x 800 RH	Grey	Matt	V8GTRG*

1450 x 700 LH	White	Matt	FCT1L*
1450 x 700 RH	White	Matt	FCT1R*
1450 x 700 LH	White	Gloss	FCTG1L
1450 x 700 RH	White	Gloss	FCTG1R
1450 x 700 LH	Shimmer Black	Gloss	FCTG1LB
1450 x 700 RH	Shimmer Black	Gloss	FCTG1RB
1450 x 700 LH	Shimmer White	Gloss	FCTG1LW
1450 x 700 RH	Shimmer White	Gloss	FCTG1RW
1450 x 700 LH	Shimmer Grey	Gloss	FCTG1LG
1450 x 700 RH	Shimmer Grey	Gloss	FCTG1RG

Lumin8 Curved Panel Tray

(see pages 116 - 117 for Lumin8 Colossus details)

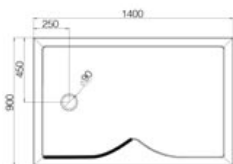

Left Hand - V8HTL

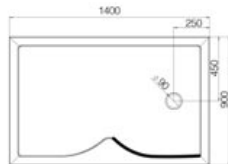

Right Hand - V8HTR

Size (mm)	Tray Colour	Finish	Code
1400 x 900 LH	White	Matt	V8HTLW*
1400 x 900 LH	Grey	Matt	V8HTLG*
1400 x 900 RH	White	Matt	V8HTRW*
1400 x 900 RH	Grey	Matt	V8HTRG*

Roman Trays

Acrylic Capped Stone

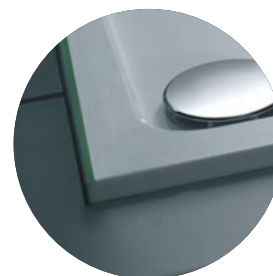

Chrome plated domed waste

Features and Benefits:

- Low profile - only 40mm in height
- Available with optional leg kits to create raised version
- Manufactured from a composite resin capped acrylic
- Gloss finish
- Height of panel kits 95mm
- 90mm Domed Waste included



Square



Rectangle



The power shower approved, easy clean, 90mm rapid drain outlet works with the sleek lines of the tray, allowing up to 32 litres of water to be carried away per minute. Manufactured from composite resin capped acrylic it is easy to install as it offers the option of flat to floor or raised on legs installation.

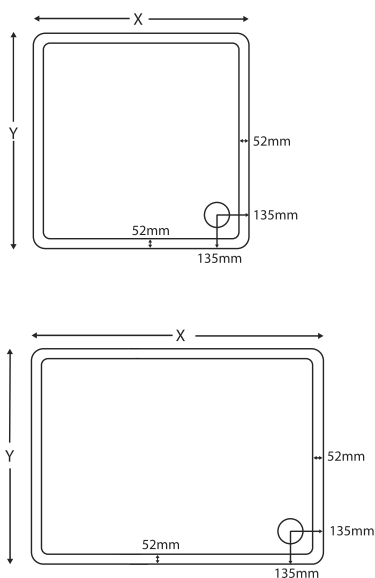

Size (mm)	X	Y	Tray Code	Optional Riser Kit Code
Roman Square Tray				
760mm	x	760mm	RLT76	RTPK03
800mm	x	800mm	RLT80	RTPK03
900mm	x	900mm	RLT90	RTPK03
1000mm	x	1000mm	RLT100	RTPK04
Roman Rectangle Tray				
900mm	x	760mm	RLT79	RTPK03
1000mm	x	760mm	RLT107	RTPK03
1000mm	x	800mm	RLT108	RTPK03
1000mm	x	900mm	RLT109	RTPK03
1100mm	x	800mm	RLT118	RTPK03
1100mm	x	900mm	RLT119	RTPK03
1200mm	x	760mm	RLT127	RTPK03
1200mm	x	800mm	RLT128	RTPK03
1200mm	x	900mm	RLT129	RTPK03
1400mm	x	900mm	RLT149	RTPK04
1500mm	x	800mm	RLT158	RTPK04
1600mm	x	800mm	RLT168	RTPK04
1700mm	x	800mm	RLT178	RTPK04
1800mm	x	800mm	RLT188	RTPK04
Riser Kits and Waste				
1200mm Square / Rectangle Panel Kit + feet				RTPK03
1800mm Rectangle Panel Kit + feet				RTPK04
Roman Tray Waste (90mm)				RTW



Riser Panel Kit shown with legs and front panel



Quadrant

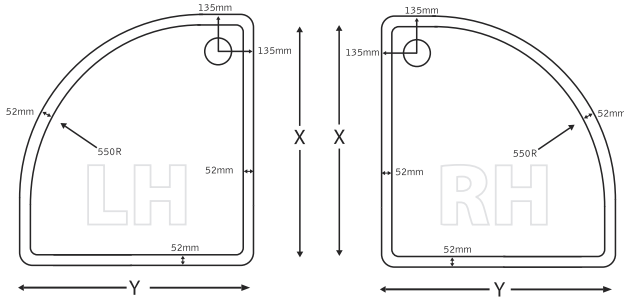
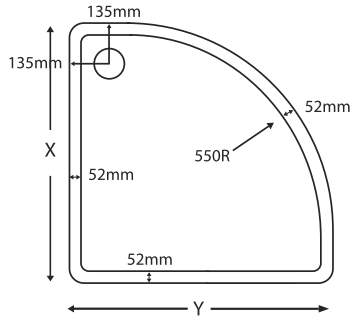

* Left or right handing must be specified



Size (mm)		Tray Code	Optional Riser Kit Code
X	Y		
Roman Quadrant Tray			
800mm	x 800mm	RLQ80	RTPK01
900mm	x 800mm LH	RLQ89L*	RTPK01
900mm	x 800mm RH	RLQ89R*	RTPK01
900mm	x 900mm	RLQ90	RTPK01
900mm	x 760mm LH	RLQ976L*	RTPK02
900mm	x 760mm RH	RLQ976R*	RTPK02
1000mm	x 1000mm	RLQ100	RTPK01
1000mm	x 800mm LH	RLQ108L*	RTPK02
1000mm	x 800mm RH	RLQ108R*	RTPK02
1200mm	x 800mm LH	RLQ128L*	RTPK02
1200mm	x 800mm RH	RLQ128R*	RTPK02
1200mm	x 900mm LH	RLQ129L*	RTPK02
1200mm	x 900mm RH	RLQ129R*	RTPK02
Riser Kits and Waste			
Quadrant Panel Kit + feet			RTPK01
Off Set Quadrant Panel Kit + feet			RTPK02
Roman Tray Waste (90mm)			RTW

Anti-Slip Kit

by Roman



Anti Slip Advantages:

- Added reassurance in wet showers
- Easy to apply - after tray installation
- Hygienic and low maintenance
- Resilient and durable
- Solvent free
- Colourless

Possible Areas of Use:

- Shower trays
- Retirement homes and nursing homes
- Clinics and rehabilitation facilities
- Only for use with Roman Acrylic Capped Stone Trays

Description	Code
Anti Slip Coating Pack	RTAS01

Bath Screens

Bath Screens continue to be a very popular choice as around 65% of UK bathrooms have showering facilities over the bath, due to the shrinking size of UK bathroom and the growing popularity of multiple bathrooms in the family home.

Many homes in the UK now have two or three bathrooms, which tend to be smaller and more compact as opposed to a spacious family bathroom. Due to this Bath Screens have increased in popularity as they are often specified for the main family bathroom to give an additional showering facility, which helps to overcome the morning rush to the shower. Combi-boilers and higher pressure plumbing systems have now created a demand for power shower approved bath screens.

Roman's extensive range of Bath Screens offers something to suit everyone's requirements and style of bathroom. We offer a range of sizes, shapes, glass thicknesses and styles designed to fit around any existing bathroom fixtures and fittings. Our range includes power shower approved bath screens for a superior showering experience, which incorporate a unique seal system for added water integrity.

“ I strive for simplicity and believe simplicity is beauty ”
- Allan Alder

Decem

Hinged Bath Screen

GLASS THICKNESS
10
Millimetres

TOTAL HEIGHT
1500
Millimetres

REVERSIBLE

GLASS PROTECTION
ULTRA CARE
BY ROMAN

TRULIFE

LIFETIME GUARANTEE

Outward Opening



- Bath Screen DXBLB
- Shower Basket RSB02

Features and Benefits:

- Self-closing hinges
- Choice of curved or straight chromed brass hinges
- Outward opening for ease of cleaning
- Integrated 'bathtop' Water Safe System for excellent water integrity
- Suitable for use with power showers
- 15mm of adjustment in each minimal wall profile for easy installation

Square Hardware



Curved Hardware



“Luxury 10mm thick toughened glass”

Bath Screen Width (mm)	Hardware Style	Adjustment (mm)	Code
830	Curved	815 - 830	DXBLA
830	Square	815 - 830	DXBLB

Innov8

Folding Bath Screen

with Black Wall Profile

Outward Opening

Available Spring 2019



• Innov8 Frameless Folding Bath Screen N2BV213BL (left hand)

Features and Benefits:

- Adjustment 885 - 910mm
- Outward opening (hinges stop at 90° to avoid contact with basins and furniture)
- Optional Bracing Bar included
- Bath top aluminium seal for added water integrity
- Power shower approved
- Left or right handing must be specified

“Introducing the new matt black metal finish on this stunning hinged bath screen”

Description	Handing	Width (mm)	Adjustments (mm)	Code
Hinged Bath Screen	Left Hand	910	885 - 910	N2BV213BL
Hinged Bath Screen	Right Hand	910	885 - 910	N2BV213BR

Lumin8

Frameless Bath Screens

Outward Opening

GLASS THICKNESS
8
Millimetres

TOTAL HEIGHT
1500
Millimetres

GLASS PROTECTION
ULTRA CARE
BY ROMAN

TRUELIFE
LIFETIME
GUARANTEE



Features and Benefits:

- Chromed brass hinges
- Bright silver frame
- Power shower approved with unique seal system
- 25mm vertical adjustment in each profile
- Glass pre-coated with Roman Ultra Care
- V8B13S - reversible for left or right hand fixing
- V8BL13S - left or right handing must be specified

“Designed to work around existing fixtures and fittings”

- Lumin8 Frameless Bath Screen V8B13S
- Shower Basket RSB06



- Lumin8 Frameless Hinged Bath Screen V8BL13SR (right hand)
- Shower Basket RSB06



- Lumin8 Bath Screen V8B28S



- Lumin8 Fixed Bath Screen V8BS13S
- Shower Basket RSB06

*Please indicate left or right handing when ordering e.g. V8BL13SL or V8BL13SR

Description	Width (mm)	Glass	Adjustments (mm)	Code
Frameless Bath Screen	835	Clear	810 - 835	V8B13S
Frameless Hinged Bath Screen	835	Clear	810 - 835	V8BL13S*
Frameless Bath Screen	835	Victoriana	810 - 835	V8B28S
Frameless Fixed Bath Screen	800	Clear	783 - 808	V8BS13S

Lumin8

Hinged Bath Screens

Inward Opening



Features and Benefits:

- Frame: Silver
- Vertical adjustment: 25mm
- Horizontal PVC seal and vertical magnetic seals
- Inward opening only
- Fixed panel and pivoting screen
- Bath top aluminium seal for added water integrity
- Suitable for use with power showers
- Left or right handing must be specified

Lumin8 Folding Bath Screen in closed position.



- Lumin8 Folding Bath Screen OBV13SL
- Shower Basket RSB05



“As used in top hotels all over the world”

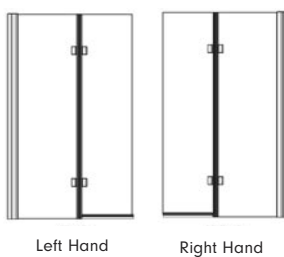

Bath Screen Width open (mm)	Bath Screen Width closed (mm)	Adjustment (mm)	Code
910	520	885 - 910	OBV13S

Must indicate left or right handing of bath screen e.g. OBV13SR or OBV13SL.

Lumin8

Hinged Bath Screen

GLASS THICKNESS
8
Millimetres

TOTAL HEIGHT
1500
Millimetres

GLASS PROTECTION
ULTRA CARE
BY ROMAN

TRUELIFE
LIFETIME GUARANTEE

Outward Folding

Features and Benefits:

- Adjustment 885 - 910mm
- Outward opening (hinges stop at 90° to avoid contact with basins and furniture)
- Optional Bracing Bar included
- Bath top aluminium seal for added water integrity
- Power shower approved
- Left or right handing must be specified

“8mm thick glass for a substantial finish and minimalist framing for a designer look”



• Lumin8 Outward Folding Bath Screen OBV213SL



OBV213SL - Left Hand illustration

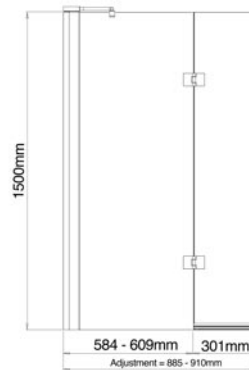

Choose the screen which best suits your bathroom requirements

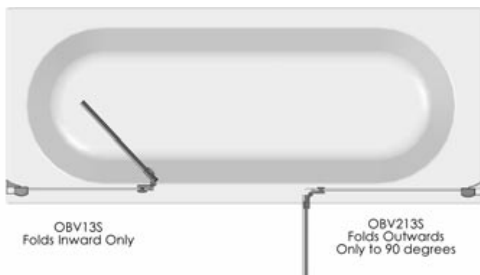

Please note this outward opening panel stops at 90° to avoid colliding with any furniture - ideal for small compact bathrooms and hotel rooms

Bath Screen	Bath Screen	Adjustment	Code
Width open (mm)	Width closed (mm)	(mm)	
910	620	885 - 910	OBV213S

Must indicate left or right handing of bath screen e.g. OBV13SR or OBV13SL

GLASS THICKNESS
8
Millimetres

TOTAL HEIGHT
1500
Millimetres

REVERSIBLE

GLASS PROTECTION
ULTRA CARE
BY ROMAN

TRUELIFE

LIFETIME GUARANTEE

Lumin8

Pivoting Bath Screen

Inward Opening



• Lumin8 Inward Folding Bath Screen V8BV13B

GLASS THICKNESS
8
Millimetres

TOTAL HEIGHT
1500
Millimetres

REVERSIBLE

GLASS PROTECTION
ULTRA CARE
BY ROMAN

TRUELIFE

LIFETIME GUARANTEE

Inward Opening



• Lumin8 Inward Folding Bath Screen V8BV13S

Features and Benefits:

- Bright silver or Matt Black frame
- 25mm vertical adjustment in each profile



“ Its discreet inward folding panel ensures it avoids contact with all existing bathroom furniture ”

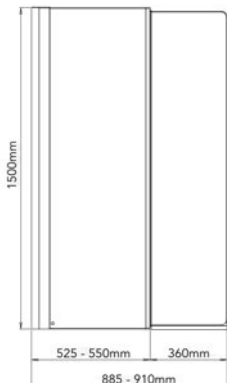

Description	Width Open (mm)	Width Closed (mm)	Adjustments (mm)	Code
Chrome Frame	885 - 910	525 - 550	885 - 910	V8BV13S
Black Frame	885 - 910	525 - 550	885 - 910	V8BV13B

Embrace

Bath Screen

Inward and Outward Opening



- Embrace Bath Screen EB13S
- Shower Basket RSB04

Features and Benefits:

- Frame: Silver
- Unique sealing system between vertical and horizontal aluminium
- Suitable for use with power showers
- EB213S suitable for use with smaller baths (i.e. 1500mm)



- Embrace Fixed Bath Screen EBS13S
- Shower Basket RSB04

Description	Width (mm)	Glass	Adjustments (mm)	Code
Inward and outward opening	820	Clear	810 - 835	EB13S
Inward and outward opening	700	Clear	678 - 703	EB213S
Fixed Bath Screen	800	Clear	787 - 812	EBS13S

Embrace

Bath Screen

GLASS THICKNESS
6
Millimetres

TOTAL HEIGHT
1500
Millimetres

REVERSIBLE

GLASS PROTECTION

ULTRA CARE
BY ROMAN

TRULIFE

LIFETIME GUARANTEE

Inward Opening



• Embrace Inward folding Bath Screen EBV213S

“Perfect solution for over the bath showering”

Features and Benefits:

- Frame: Silver
- Width: open 525 - 550mm/closed 885 - 910mm
- Frameless with radius glass
- Suitable for use with power showers
- Optional brace bar included

Description	Width (mm)	Adjustments (mm)	Code
Inward Folding Screen	910	885 - 910	EBV213S

Embrace

Bath Screen

Inward and Outward Opening



• Embrace Folding Bath Screen EBV13S

Features and Benefits:

- Frame: Silver
- A. Width: 920mm when fully open
- B. Width: 520mm when in closed position 1
- C. Width: 450mm when in closed position 2
- D. Width: 430mm when in closed position 3
- Vertical adjustment: 25mm
- Full length magnetic PVC seals
- Unique sealing system between the vertical and horizontal aluminium
- Suitable for use with power showers
- Optional brace bar included

“It features a unique sealing system to ensure areas prone to leakage remain water tight whilst allowing 180° movement of the glass panel”

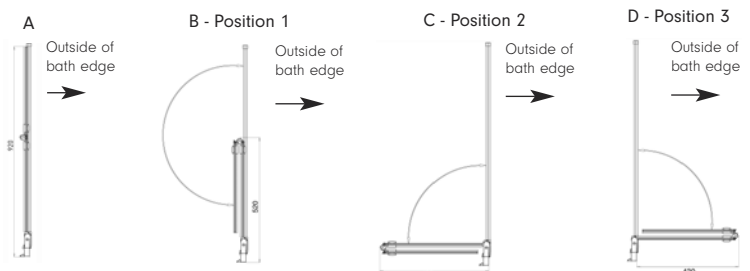

Description	Width (mm)	Adjustments (mm)	Code
Folding Screen	920	895 - 920	EBV13S

Collage

Curved Bath Screen

GLASS THICKNESS
5
Millimetres

TOTAL HEIGHT
1500
Millimetres

REVERSIBLE

GLASS PROTECTION
ULTRA CARE
BY ROMAN

TRULIFE

LIFETIME GUARANTEE

Inward and Outward Opening

Features and Benefits:

- Frame: Silver or white
- Suitable for all standard bath mixer and electric showers
- Not recommended for use with pumped or pressurised systems
- Vertical and horizontal PVC seals



- Collage Curved Bath Screen CB13S
- Shower Basket RSB02



- Shower Basket RSB02

“An elegant curved design for over the bath showering.”

Description	Frame	Adjustments (mm)	Code
Screen with curved corner	Silver	810 - 825	CB13S
Screen with curved corner	White	810 - 825	CB13W

GLASS THICKNESS
8
Millimetres

TOTAL HEIGHT
1500
Millimetres

REVERSIBLE

GLASS PROTECTION
ULTRA CARE
BY ROMAN

TRULIFE

LIFETIME GUARANTEE

Lumin8

Mini Fixed Bath Screen

Curved Rail



• Lumin8 Mini Fixed Screen with Curved Rail V8CC213S

V8CC113S - The Mini-Fixed Screen complements an existing curtain rail installation and reduces splashing around the back of the curtain and water seepage along the top end of the bath.

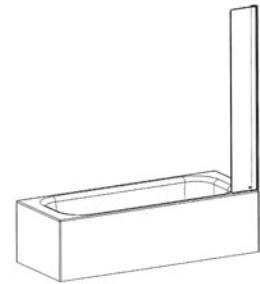

V8CC213S - The Mini-Fixed Screen complete with curtain rail (no curtain included) and wall attachments ensures a watertight shield to retain water in the bath. The curtain is held in place at the top and is less likely to allow water leakage out of the bath area. Rail length to suit 1700mm bath maximum.

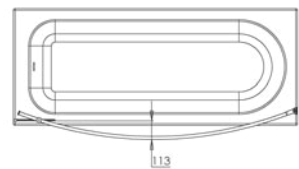

“If you do it right, it will last forever.”
- Massimo Vignelli

Features and Benefits:

- Frame: Silver
- Suitable for all standard bath mixer and electric showers (non-pumped)
- To be used in conjunction with shower curtains (no hooks or curtain supplied)
- Curved rail to increase showering comfort with a curtain

Description	Adjustment (mm)	Code
Mini-Fixed Panel	243 - 257	V8CC113S
Mini-Fixed Panel with Curtain Rail	243 - 257	V8CC213S

Jupiter

Bath Screens

GLASS THICKNESS
5
Millimetres

TOTAL HEIGHT
1360
Millimetres

REVERSIBLE

GLASS PROTECTION
ULTRA CARE
BY ROMAN

TRULIFE

LIFETIME GUARANTEE

Inward and Outward Opening



• Jupiter Standard Bath Screen JBL13S



• Jupiter Curved Bath Screen JB13W

Features and Benefits:

- Suitable for all standard bath mixer and electric showers
- Not recommended for use with pumped or pressurised systems
- Colourless vertical and horizontal PVC seals
- Rotates through 180° for access
- Supplementary sealing kit available for added water integrity

Description	Frame	Adjustments (mm)	Code
Standard Bath Screen	Silver	810 - 825	JBL13S
Standard Bath Screen	White	810 - 825	JBL13W
Curved Bath Screen	Silver	810 - 825	JB13S
Curved Bath Screen	White	810 - 825	JB13W
Supplementary Sealing Kit			BSP001

Accessories



“ Practical and stylish storage ”



RSB01

- Double Hanging Basket with Hooks
- Available Chrome or Matt Black



Spacers supplied so basket can be hung directly onto the glass edge

RSB02

- Large Curved Corner Basket
- Available Chrome or Matt Black



RSB03

- Chrome Stepped Soap Basket



RSB04

- Chrome large 'L' Shaped Corner Basket





RSB05

- Double Corner Basket with Hooks RSB05
- Available Chrome or Matt Black



RSB06

- Chrome large Rectangular Basket



RSB07

- Double Rectangular 'single wall' Basket with Hooks
- Available Chrome or Matt Black



RSB0100

- Roman Shower Blade (includes spare blade part)
- Available Chrome or Matt Black



Description

Double Hanging Basket with Hooks

Dimensions (mm)

D: 125mm W: 220mm H: 765mm

Chrome Finish Code

RSB01

Large Curved Corner Basket

D: 224mm W: 296mm H: 73mm

RSB02

Stepped Soap Basket

D: 131mm W: 260mm H: 57mm & 29mm

RSB03

Large 'L' Shaped Corner Shower Basket

D: 115/125mm W: 255/270mm H: 99mm

RSB04

Double Corner Shower Basket with Hooks

D: 224mm W: 293mm H: 399mm

RSB05

Large Rectangular Shower Basket

D: 120mm W: 260mm H: 95mm

RSB06

Double Rectangular 'single wall' Shower Basket with Hooks

D: 106mm W: 215mm H: 391mm

RSB07

Roman Shower Blade (includes spare blade part)

-

RSB0100

Matt Black Finish Code

RSB01B

RSB02B

RSB05B

RSB07B

RSB0100B

Mirrors

Our bold industrial style window mirrors will make a statement in any room. These mirrors encapsulate factory chic with an elegant twist presenting a fabulous accent for the industrial trend. The mirrors feature printed glass and are suitable to be used in any room including bathrooms. The mirrors are made with 6mm safety backed glass.

Cleaning and care guidance:

Treat them like any other mirrored surface, use a lint free cloth and a purposely manufactured cleaning agent, designed for mirrors. Don't use anything abrasive.

Available Spring 2019



Description	Code
Square Black Grid Mirror	MIR01
Arched Black Grid Mirror	MIR02

Choosing the right wetroom system

**ROMAN
SHIELD**
Wetroom System

TRUELIFE
10 YEAR
GUARANTEE



The Roman Shield Wetroom System - winner of the KBB Readers' Design Award 2009



Winner of the Homebuilding and Renovating Magazine Best Bathroom Product 2011

Total area to be tanked = a + b + c.

a & b = showering area (floor to ceiling coverage.)

NOTE:

Tanking for the showering area should be applied 100mm past the showering area walls into the splash zone. (E.g. 0.9 x 0.9m showering area = tanking wall to ceiling: 1 x 1m).

c = floor coverage * the entire floor should be tanked with a turn up of 0.1m onto the walls.

EXAMPLE:

(showering area 0.9 x 0.9m, room height of 2m and floor size 2m x 2m)

a = 1 x 2 = 2m² b = 1 x 2 = 2m² c = 2 x 2 = 4m²

Total area to be tanked = 8.0m²*

* The entire floor area should be tanked with a turn up of 0.1m onto the walls - you will need to allow extra in your calculation for this.

Roman Shield requirement:

Based on the above calculation one RSH01 – Roman tanking kit will be required covering 10m².

NOTE:

The Roman Shield tape is supplied in a 15m roll and is used to seal all wall to wall and wall to floor joints as well as screw heads. Calculate how much you will need based on your room size and number of joints to cover.

If you wish to use any optional extras such as the internal corners (RSH02) or external corners (RSH04) please calculate based on your site requirements.

The above calculation is for guidance only, coverage of the tanking kit will vary depending on application technique used (roller/brush) and site conditions.

To calculate the Roman Shield tanking coverage:

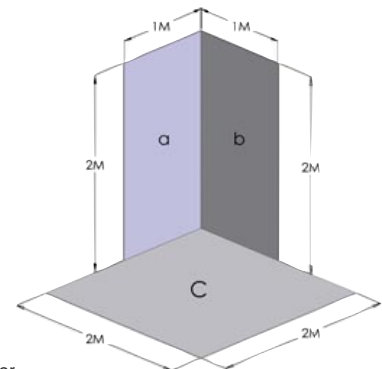

For our 9 Easy Steps Guide to installing a wetroom you can view a short video podcast guide at www.roman-showers.com or scan the QR code to view video directly on your smart phone



Tanking Kits

Roman Shield Tanking Kit 1: (Covers approx. 10m²)

Product Code RSH01

Includes:

- 2ltr of Primer
- 15m of Roman Shield Tape
- 1 self-adhesive Shower Outlet Sleeve (drain mat)
- 9kg of Roman Tanking Compound
- Installation Instructions & Guarantee Card

Roman Shield Tanking Kit 2: (Covers approx. 10m²)

Product Code RSH12

Includes:

- RSH01 Tanking Kit 1 (see above)
- RSH02 Internal Corners x4
- RSH04 External Corners x2
- RSH06 Pipe Sleeves x2

Glass Protection



The ultimate Bathroom Protector on glass

All Roman's enclosures and bath screens are pre-coated with Roman Ultra Care, our own unique glass protection system. Pre-coated glass protection systems will always diminish in their effectiveness over time, depending on how often the shower is used and how often it is cleaned. Unlike other systems, Roman Ultra Care in a bottle can be used in tandem with the pre-coat to build up the effectiveness and make it stronger the more you clean.

Roman Ultra Care is an award winning bathroom protector and has a 10 year track record for successfully protecting Roman's extensive product range. When applied to the glass of an enclosure or bath screen it creates a chemical barrier which provides protection against the build-up of grime, limescale and stains. The protective barrier means water glides off the glass with ease. This results in the protected surface remaining easy to clean by simply applying a mild detergent and wiping with a damp cloth or using a Roman Shower Blade.

By topping up the glass protection system with Roman Ultra Care in a bottle every time you clean, you can significantly reduce the amount of time required to clean your enclosure and bathroom surfaces. Most importantly, you can considerably prolong the life of your Roman product and at the same time do your bit for the environment by eliminating the use of harsh and damaging cleaning products.



RUCO3 - 750ml Bottle code

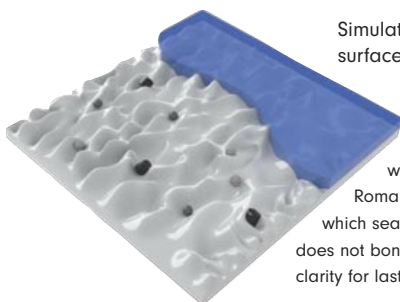

Simulation of glass surface magnified

All glass surfaces have a non smooth finish which can attract the build-up of particles. Roman Ultra Care provides an invisible protective film which seamlessly seals the surface to ensure this build-up does not bond to the glass and the glass retains its optical clarity for lasting sparkle.



Before coating

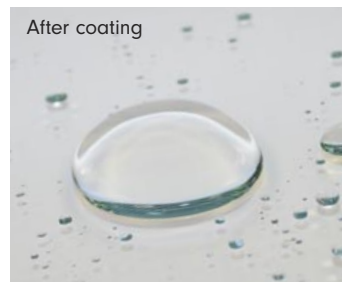

After coating

Ongoing After Care

To maintain the long lasting sparkle of your Roman enclosure or bath screen and aid the Ultra Care pre-coated glass protection; Roman Ultra Care can be purchased in a user friendly 750ml sized bottle. This can be purchased from your local Roman Bathroom Retailer, or alternatively from www.romanathome.com (UK only).

Roman Ultra Care is not limited to the cleaning and protection of your shower enclosure or bath screen, it can also be used to protect other bathroom surfaces, which are not pre-coated, including glass, tiles, aluminium frames, taps, trays, sinks and baths.

Simply wipe down your bathroom surfaces after use and apply Roman Ultra Care with a soft cloth. Roman Ultra Care can be used weekly as part of your bathroom cleaning routine.

The more you apply Roman Ultra Care the more protection you create for your enclosure, therefore your enclosure will maintain its high quality finish for longer. Without using Roman Ultra Care, your pre-coated glass protection will diminish over time.

Important information to help you maintain your Roman product:

Ensure you clean your product using a mild detergent diluted in water and then polish off using a soft damp cloth. Apply a coat of Roman Ultra Care after each clean to build-up the protective film on the surface.

If you live in a hard water area, periodically clean your product using a 50/50 solution of white vinegar and water. The solution should be left on the enclosure for approximately 5 minutes then rinsed off using warm water.

1. Do not use acidic based products which are unsuitable for cleaning enamel surfaces.
2. Do not use abrasive cleaners or cleaners containing bleach or solvents, these products will adversely affect the finish of the aluminium profiles.
3. Do not use scouring pads, powder or any sharp instruments when cleaning your Roman enclosure.

(minimum quantity for stockists 12 bottles (RUC13))

For details of your nearest stockist please contact Roman Customer Relations on 01325 328033 or buy online at www.romanathome.com



Winner of the House Beautiful Best Cleaning Product Award 2009

Make cleaning your bathroom easy with our

Shower, Tile and Bath

Restoration and Maintenance Kit

Restore discoloured glass and maintain the sparkle of your bathroom



3 Step System includes:



Ultra Scrub

Surface Stain Cleanser

Designed to effectively and easily clean your bathroom surfaces, including Glass, Porcelain, Ceramics and other hard surfaces. Developed to remove the build-up of minerals, rust, soaps, oils and limescale but without damaging the surface.



Ultra Shield

Glass and Surface Stain Cleanser

Formulated to clean and protect. Ultra Shield can be used on your bathroom surfaces to create a water, soil and stain repellent barrier coating which prevents water, soil and grime from sticking for easier cleaning. This barrier is renewed with each use.



Ultra Care

Glass and Surface Protector

For a long lasting sparkle on bathroom and shower surfaces. Ultra Care is the ultimate surface protector that repels the build-up. Also available in large bottle for ongoing aftercare.

For details of your nearest stockist please contact Roman Customer Relations on 01325 328033 or buy online at www.romanathome.com

Protecting the Environment

Roman is committed to caring for the environment and as a reflection of this commitment we became fully accredited with ISO 14001 certification in 2009. We see looking after the environment as an important part of being a UK business and UK manufacturer. As a business we care for the environment in two ways - by improving our systems to reduce our carbon footprint and impact on the environment. We strive for continual improvement in this area.

For more information on how we are taking care of the environment visit our website: www.roman-showers.com and view our full list of ecodentials.



As well as considering the environment during the manufacture of our products, we are also mindful of how our products can impact on the environment after they leave us. The addition of our Ultra Care Pre-coated Glass Protection means that dirt, grime and soap scum are washed away during the shower use. This means the use of harsh chemicals during the cleaning process can be eliminated and less water is required during the cleaning process.



All Roman Shower Enclosures and Bath Screens and Trays are manufactured in the UK.



EMS 523823



Roman brochures are printed on stock sourced from responsible forests.



All waste is segregated into recyclables and non-recyclables. 93% of all waste is recycled - landfill reduced to 7% of total waste generated.

Recycling your product

Packaging

As an ISO14001 Registered Company, Roman takes recycling very seriously at all levels. All cardboard is already manufactured from recycled paper, but our packaging itself is designed for recycling. Please ensure that the cardboard packaging is taken to a local cardboard recycling point or to a local recycling depot.

End of Life (EOL)

EOL recycling is taken into account from the initial design stages to ensure all aspects of the Roman products can be recycled for future use. The Aluminium, Brass Alloys, Glass (and Solid Surface Material with Roman Stone Trays) can be easily recycled at your local Licensed Recycling Centre (LRC). If you are unable to access an LRC, then Roman can arrange to coordinate a pick-up of your product for a modest transport charge.



All Roman Shower Enclosures, Bath Screens and Trays are manufactured in the UK.
All vehicles with Euro 5 compliance engine vehicles saving 22% on emissions.
Company car policy has been updated so only vehicles with less than 125 grams of CO₂'s per Kilometre can be used in the fleet.
Overall company CO₂ reduction since 2009 is 20%.

Roman's Bespoke Service allows you to build a made to measure shower enclosure, wetroom panel or bath screen, to perfectly suit your available space.

Roman offers a Bespoke Service on many of our products. So if you are looking to install a shower enclosure into an awkward or unusual space, we have the perfect solution. Roman's Bespoke Service allows you to tailor the height and width of your product, we have the option of clear, frosted or printed glass. Glass can be cut at an angle or shaped, for example angled glass can allow for a sloping roof, to make adding a showering facility to a loft conversion or under your stairs, easy.



- Made to measure items which fit almost anywhere
- All products made in accordance with your own measurements
- We endeavour to provide fast and efficient answers to all your questions
- Cost effective solutions
- Many designs to suit all tastes
- Measure and fit service available

Bespoke Services available:

- Reduced height
- Reduced width
- Clear, frosted or printed glass
- Angled/Shaped glass

To order a Bespoke Service all you have to do is simply choose which product you would like, then follow these six easy steps:

1. Take your drawings to your nearest retailer who will fax them to Roman. For your nearest retailer contact Roman Customer Relations on 01325 328033 or visit www.roman-showers.com
2. Roman will then send a quotation to your retailer for them to discuss with you
3. If you are happy with this quotation Roman will produce a drawing to illustrate what your final product will look like. Note: Roman will make all drawings in accordance to your measurements and unless otherwise requested, an adjustment allowance will be included. Please specify your adjustment allowance prior to ordering.
4. Roman will then fax the drawing to your retailer who will pass this on to you. This drawing will be in the form of a fax back agreement for you to sign*.
5. Once Roman receives the agreement work will begin on your product.
6. You will receive your product within 5-6 weeks.

*Once this agreement is signed you will be liable for any changes should you cancel your order.

For full pricing details and ordering process please go to:

www.roman-showers.com/roman-customers/available-downloads/

Consumer Guide

Roman shower enclosures have been tested and fully conform to the scope and relevant characteristics of BS EN14428:2015 (Shower Enclosures - Functional requirements and test methods), to meet the requirements of the mandate given under the EU Construction Product Directive (89/106/EEC).

As a result of full compliance to the directive and harmonized standard; Roman shower enclosures carry the 'CE' mark and are accompanied by a declaration of performance. (Available to view on www.roman-showers.com)

The CE marking indicates Roman shower enclosures conform to all essential requirements of European health and safety and environmental protection legislation. The conformity is mandatory, and allows Roman products to be legally placed on the market anywhere in the European Economic Area.

Additionally all Roman trays fully conform to EN14527:2016.



Important Product Details

- ◆ Enclosures and screens carry a Lifetime manufacturer's guarantee if products are installed according to the installation instructions - see guarantee criteria to the right.
- ◆ Simple and clear installation instructions are included with all Roman Products.
- ◆ Roman products are available for Virtual Worlds design service. For more information contact Roman Customer Relations on 01325 328033.
- ◆ Any guarantee variations are indicated separately.
- ◆ All guarantee forms supplied with installation instructions must be completed and returned to Roman within 60 days to validate the lifetime guarantee otherwise only a statutory 12 month guarantee will apply.
- ◆ All Roman Bath Screens and Enclosures are manufactured using toughened safety glass which complies to BSEN12150.
- ◆ All Roman Bath Screens and Enclosures are tested in accordance with BSEN14428 - shower enclosures, functional requirements and test methods.
- ◆ Roman's toughened glass is completely safe for use in our shower enclosures and bath screens; providing our products are installed according to our guidelines.
- ◆ It is important to note, that the glass must not be mounted or 'pinched' in such a way that would cause a stress point to develop in the glass. In addition, it must not be subjected to any sharp impact or severe temperature fluctuation which may also cause a stress point to develop in the glass.
- ◆ Roman's toughened glass is physically and thermally significantly stronger than standard glass. However a significant impact (or stress as outlined above) can cause toughened glass to break. In the event of breakage, toughened glass will break safely into small fragments in line with all relevant standards.
- ◆ All heights quoted for enclosures and bath screens are from the top of the shower tray or bath.
- ◆ All fixings are hidden on Roman products.
- ◆ The term "Silver" and "Nickel" describes the colour of the aluminium finish. No silver metal is included in any Roman products.
- ◆ All fixings and pivot pins are manufactured from stainless steel - this adds great strength and durability to Roman products.
- ◆ All seals and gaskets on Roman products are manufactured from colourless PVC.
- ◆ Roman over-bath products are not designed for baths with shaped or stepped fronts or integral soap dishes.
- ◆ The design rights of these products are owned by Roman Limited. All rights reserved.
- ◆ For compatibility of Roman enclosures with steam generators please contact Roman Customer Relations for advice on 01325 328033.
- ◆ Where indicated that products are suitable for use with steam generators, this refers to the performance of the product components. We do not however suggest that the product will have complete steam integrity.
- ◆ Due to the nature of wetroom panel products, water integrity cannot be guaranteed. Please consult your installer.

Guarantee

Roman Ltd. guarantees all Shower Enclosures and Bath Screens against faulty materials or manufacture for LIFE, provided they have been installed, used and maintained in accordance with our instructions.

All Roman product guarantees must be completed and returned within 60 days of purchase to validate the relevant guarantee. Failure to meet this deadline will result in a statutory 1 year guarantee on all products.

Should a claim arise, Roman Ltd. Customer Relations will investigate the issue. As part of this investigation we request that the following conditions be satisfied:

1. Proof of purchase at the time of the claim.
2. The guarantee applies to the original purchaser only and is non transferable.
3. The product has been fitted/installed in accordance with Roman Ltd. fixing instructions, local bylaws and general good plumbing practice
4. The product has been maintained and cared for in accordance with our instructions (including regular and appropriate cleaning).

If in our opinion the product has been modified, misused, neglected, wilfully or accidentally damaged, we can accept no responsibility for failure.

Roman Ltd. or its representatives must be given the opportunity to inspect the product in the installed condition.

Should any products included in the Lifetime guarantee be used for Commercial use i.e. leisure clubs, schools, hospitals, student accommodation, hotels or residential homes, only a 5 year guarantee will be applicable.

If in our opinion the product fails due to faulty materials or manufacture and that the conditions above have been met, Roman Ltd. will arrange for a specialist Roman Technical Sales Representative to repair or replace that item at our option.

Roman Ltd. believes in continuous improvement. If in our opinion the product has failed under the terms of the Guarantee and a replacement is offered but identical goods are no longer available, Roman Ltd. will replace it with our nearest equivalent product. For countries outside of the UK and Republic of Ireland, where a product has failed due to faulty materials or manufacture, a replacement product or product part will be offered only.

Should Roman Ltd. carry out work as a result of a claim but subsequently it is revealed that the product has been abused or improperly installed, we reserve the right to charge the customer for the expense incurred.

The liability of Roman Ltd. is limited to the product supplied by Roman Ltd. and does not extend to consequential loss or damage arising from the defective product.

This Guarantee, which is effective for products purchased after February 1st 2006, states our entire liability and is offered to customers acquiring our products as consumers, not in the course of trade or business. Ex displays or products reinstalled from their original position are not covered under this guarantee.

Non glass or metallic parts (e.g. seals) are subject to normal wear and tear through usage and are therefore covered on all products for 1 year from installation.

Roman Ultra Care pre-coat is not covered by this guarantee and it must be maintained by applying Ultra Care from a bottle on an ongoing basis.

Roman products not included in the lifetime guarantee include Roman Stone Shower Trays, Roman Accessories and Roman Shield® tanking products which are covered for 10 years. Roman Acrylic Capped Trays are covered for one year. Commercial projects with specific guarantee requirements can be subject to negotiation and agreement on a project by project basis. Any such agreements must be confirmed in writing prior to product supply or commencement in project works.

This guarantee does not affect your statutory rights.

This guarantee is wholly applicable in the U.K. and Republic of Ireland - export conditions as indicated

Roman Ltd
Whitworth Avenue, Aycliffe Business Park,
County Durham, DL5 6YN
Tel: 01325 311318 Fax: 01325 319889
www.roman-showers.com

UK:

Roman Limited,
Whitworth Avenue,
Aycliffe Business Park,
County Durham,
DL5 6YN,
England, UK.

GENERAL RECEPTION:
Phone +44 (0) 1325 311318

UK CUSTOMER RELATIONS:
Phone +44 (0) 1325 328033
Email: custserv@roman-showers.com

UK SALES:
Phone +44 (0) 1325 328034
Email: orders@roman-showers.com

INTERNATIONAL SALES/CUSTOMER RELATIONS:
Phone: +44 (0) 1325 328033
Email: international@roman-showers.com
www.roman-showers.com/international

ASIA PACIFIC:

Roman Asia Sdn Bhd (091603K)
No.6, Jalan Olivin, Taman Industri Sungai Purun,
43500 Semenyih, Selangor, Malaysia

Asia Sales:
Tel: +60 (0) 3 8723 1211
Email: romanasia@roman-showers.com
www.roman-showers.com/international/roman-asia/

ROMAN IRELAND:

W10F
Ladytown Business Park
Naas
County Kildare
Ireland

Ireland Sales:
Tel: +353 (0) 45 408 118
Email: irelandsales@roman-showers.com
www.roman-showers.com/international/roman-ireland-information/

www.roman-showers.com



ROMAN
at Home

www.romanathome.com