

# SALUS<sup>®</sup>

C O N T R O L S

Model: EP110

Single channel programmable controller



Installation Manual

Product Compliance .....	3
Safety Information .....	3
Box content .....	3
Introduction .....	4
Features .....	4
Installation .....	5
Button functions and LCD icons .....	7
Operations .....	8
Functions .....	14
Factory Reset .....	16
Technical Info .....	17
Warranty .....	18

## Product compliance

This product complies with the essential requirements and other relevant provisions of the following EU Directives: 2014/30/EU, 2014/35/EU and 2011/65/EU. Please check [www.saluslegal.com](http://www.saluslegal.com) for the full information.

## Safety Information

Use in accordance with the EU and national regulations. For indoor use only. Keep your device completely dry. This product must be installed by a competent person and in accordance with all the EU and national regulations.



**Always isolate the AC Mains supply before installing or working on any components that require 230 VAC 50Hz supply.**

## Box content

The box includes the EP110 controller, 2X screws and plugs and the Quick Guide installation manual.



EP110 Controller



2x screws and plugs



Quick Guide Installation

## Introduction

A programmable heating controller is used to switch the heating system and/or hot water in your home as needed. It works by controlling the heating boiler according to a series of programmed settings that take effect at different times of the day. The controller can be set up to 3 programs per day, with complementary Boost actions and can operate in five different modes. Three different sets of time can be set for each day of week, resulting in a total of 21 settings applicable to the device.

When connected to a system with a non-programmable (digital) thermostat, it can switch off/on the boiler and control the heating and/or hot water in your system in a programmed manner. You can use the controller in a fully pumped and controlled system, where heating and hot water can be operated independently or in gravity-fed water system, where the central heating cannot be operated without hot water.

The heating system will not work if the programmer has switched it off. The controller does not detect the temperature or adjust the heating mode in your house, it just tells the boiler when to switch Off/On depending on our individual time settings.

With the controller you don't have to worry about switching On/Off your system manually. All you need to do it so set up the schedules that fit your needs. The controller can be used on your system to control either the central heating OR the hot water.

## Features

- Single Channel Programmer for Central Heater or Hot Water
- 12 or 24 hour clock format
- 5+2 or 24 h individual program with 3 settings per day
- Boost function
- Holiday function
- Advance function
- Memory backup



# Installation

## Wiring and terminal description

230 VAC

Terminal	Description	Backplate
N	Mains Neutral	
L	Mains Live	
1	NC (Output)	
2	Not Used	
3	Switch Live (Output)	
4	230V Common (via Link)	
	Earth Parking (no electrical connection)	

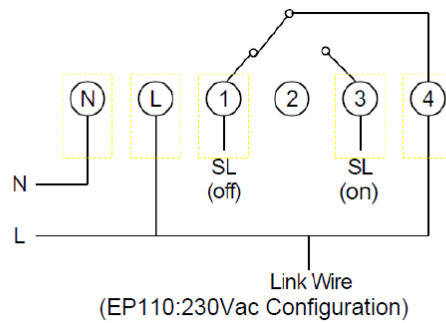

Volt free application. **Note:** Please remove red link wire (like the one in the picture above) for this application.

Volt Free

Terminal	Description	Backplate
N	Mains Neutral	
L	Mains Live	
1	Not Used	
2	Not Used	
3	Volt Free Connection	
4	Volt Free Connection	
	Earth Parking (no electrical connection)	

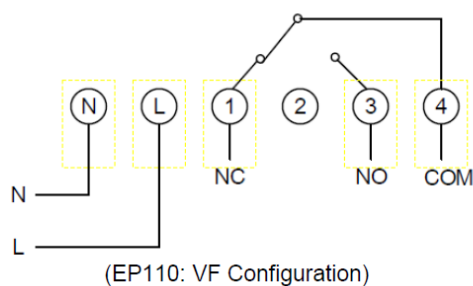

## Wall mounting

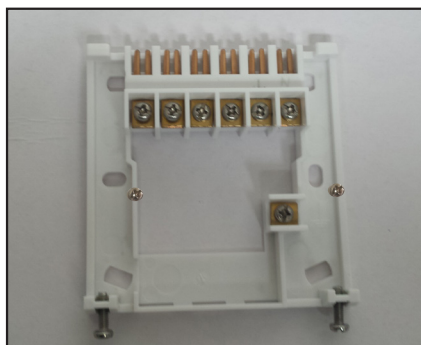

Fix the backplate to the wall.



Align the front housing at the top edge.



Fit the front housing. Press lightly.

## Jumper settings

The jumpers are found on the rear of your controller and can be used to change the settings for the program type or internal backup memory battery. If you want to change the position of your jumpers, please note that you will need to reset your device. The default position for the jumpers set a 5+2 program type and keep the internal backup battery off.

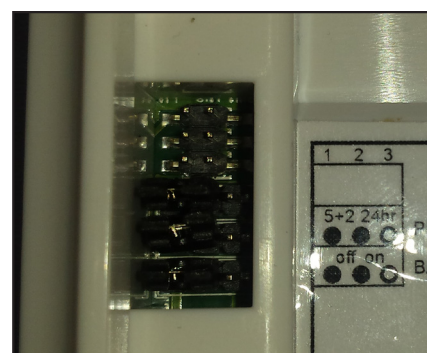

EP110 Switching Bridges				
Switch	Feature	Setting		Default
Program	5-2 days program or 24h program	5-2 <input checked="" type="radio"/> <input type="radio"/> <input type="radio"/>	24H <input type="radio"/> <input checked="" type="radio"/> <input checked="" type="radio"/>	5-2 days program
Memory Backup	Disable/enable the internal backup battery	OFF <input checked="" type="radio"/> <input type="radio"/> <input type="radio"/>	ON <input type="radio"/> <input checked="" type="radio"/> <input checked="" type="radio"/>	Internal backup battery disabled

**Note:** Changes to the jumper settings should only be made by the engineer carrying out the installation or another qualified person. The installer should select the jumper positions required if changes need to be made to the factory default settings. These jumpers are found on the rear of the controller.

## Button functions and LCD icons



Key	Function
Mode	Press to select ON/ONCE/AUTO/ADV/OFF.
+1Hr	Press to enter/cancel Boost override function by setting Boost hours.
Select	Press to select the setting of clock/date/week day, etc.
Set	Press to confirm the setting.
Up arrow	Press to increase clock/day, press and hold to enter fast advance.
Down arrow	Press to decrease clock/day, press and hold to enter fast advance.
	Press to activate backlight.
	Hardware reset
	Press and hold button for 3 seconds to activate Holiday mode.
Select + Set	Press and hold buttons to enter clock setting mode.

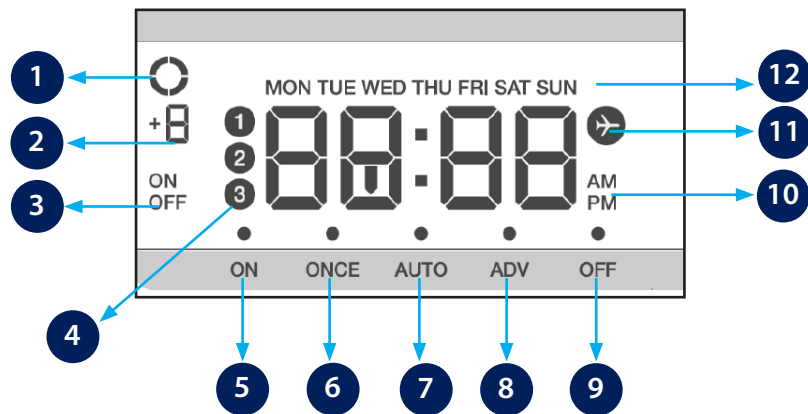

- 1 Showing when relay is On
- 2 Boost hours
- 3 Daylight Saving Time On/Off
- 4 Program number
- 5 ON Mode Active (controller runs continually)
- 6 ONCE Mode Active (controller runs for 1 period a day)
- 7 Auto Mode Active (controller runs in Auto)
- 8 ADV Mode Active (controller runs in advance override)
- 9 OFF Mode Active (controller is off)
- 10 AM/PM
- 11 Holiday mode on
- 12 Days of the week



## Initial power up

After power up or after RESET is pressed, the programmer is reset to factory default settings. During system reset, all LCD icons and segments are turned on for 2 seconds and all keys are blocked. After 2 seconds and all keys are released, the programmer is initialized. First the software version is shown and after that the typical reset display is shown. The time should be 12:00am.



## Default settings

Function	Status after Reset
Operation Mode	Normal mode
Clock	12:00 AM
AM/PM indicator	AM
Date	January 1, 2016
Daylight Saving Time(DST)	On
Program	Factory default 5+2
Program Number indicator	Off
SET indicator	Off
PROG indicator	Off
Mode indicator(s)	"Off"
Output Relay	Off
CH/HW indicator(s)	Off



## Setting time and date

The first thing you will have to do is to set the time and date on your controller. First you will need to set up the time and then the date. To enter clock setting mode, press and hold **Select** and **Set** buttons for 3 seconds. Please follow the instructions below.



Press and hold the indicated buttons together for 3 sec.

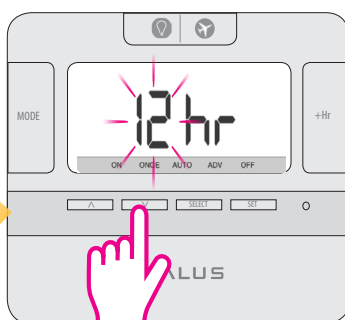

Choose your clock format  
Press Up/Down arrow for 12/24 hr format.



Choose your clock format  
Press Up/Down arrow for 12/24 hr format.

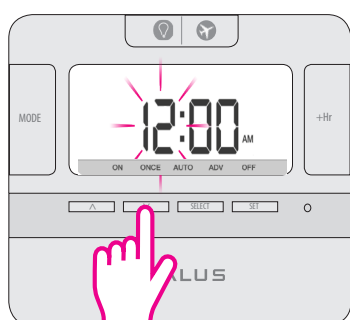

Press Up or Down to set the hour. Press Select to confirm.

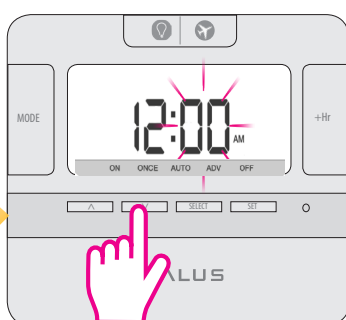

Press Up or Down to set the minutes. Press Select to confirm.

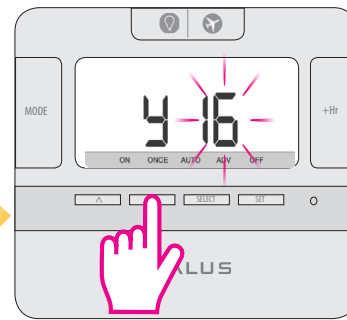

Press Up or Down to set the year. Press Select to confirm.

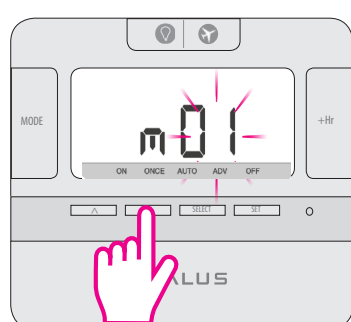

Press Up or Down to set the month. Press Select to confirm.

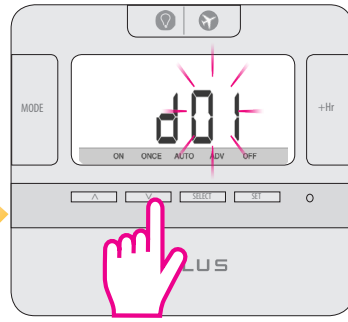

Press Up or Down to set the day. Press Select to confirm.

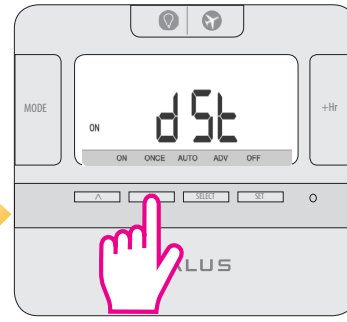

Press Up or Down to set the Daylight Saving Time On or Off. Press Set to confirm.

When Daylight saving time is enabled, the clock will automatically change from Greenwich Mean Time (GMT) to British Summer Time (BST) on the last Sunday in March. The clock will automatically change back to GMT on the last Sunday in October.

## Operating Modes

EP110 can operate in 5 different modes, described in the table below. EP110 can be set to control either the boiler OR the hot water. You can choose on which one of the channels you connect the controller. To access operating modes, please press **Mode** key.

Operation Mode	Function
ON	Continuously on
ONCE	On for 1 period a day, from Program 1 ON to Program 3 OFF
AUTO	Automatic program control
ADV	When device is in Auto or Once mode, press the MODE button for 3 sec for selecting Advance (ADV). This will move the unit into the next program. When the ADV function ends the device will return to normal program.
OFF	Continuously off

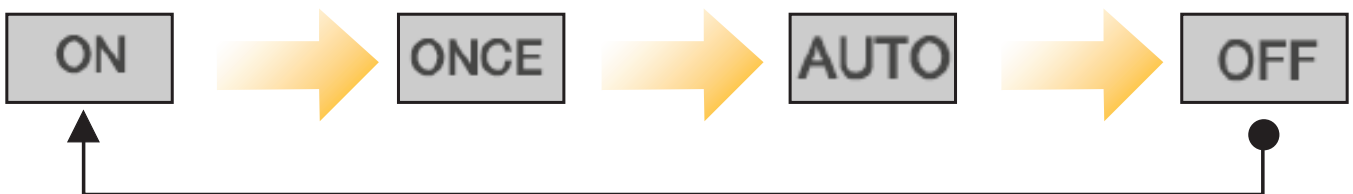

For activating the functions described above, press the **MODE** button. The operating mode is cycled in the below sequence:

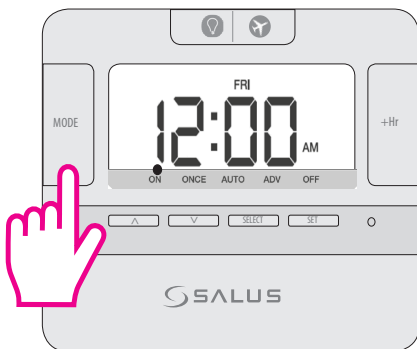

### ON Mode



Pressing the Mode key once activates the ON Mode. In ON mode, the controller gives the boiler the ON command, so the heating or the hot water will run continuously.

The circle icon  will be rotating in a sequence when the relay output is ON. 

### ONCE Mode



Pressing the Mode key twice activate the ONCE Mode. In ONCE mode, the controller gives the boiler the command to run only for one period per day (from program 1 ON to program 3 OFF)

## ON Mode

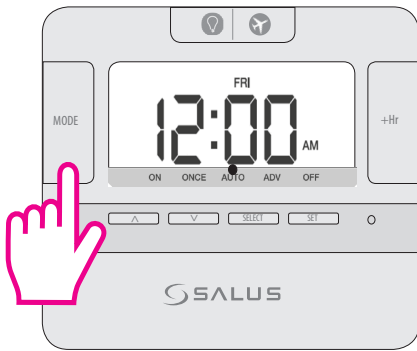

Pressing the Mode key 3 times activates the AUTO. In AUTO mode, the controller gives the boiler the ON/OFF command depending on your schedule.

## OFF Mode

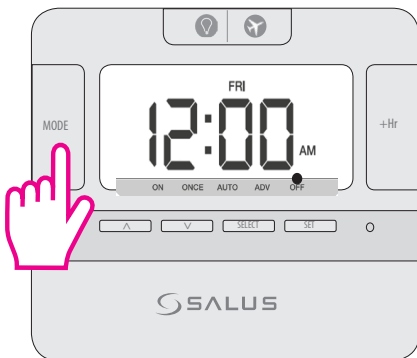

Pressing the Mode key 4 times activates the OFF Mode. In OFF mode, the controller gives the boiler the OFF command, so the heating or the hot water will be turned off.

## ADV Mode

**Note:** In ONCE or AUTO mode, by long pressing the MODE button, the controller will switch automatically to ADV. You can cancel the ADV by long pressing the MODE key. The device will then return to ONCE or AUTO mode. You can't select ADV by pressing Mode key.



Long press Mode while  
in Auto or Once

When in Auto mode selecting ADV, the controller will simply toggle the current auto setting (ON or OFF). For example, if the current program is set as:

08:00 ON → 09:00 OFF → 10:00 ON → 11:00 OFF

Selecting ADV between 8:00 and 8:59 will change the output to OFF, from 9:00 onwards back to AUTO (which is also OFF). Selecting ADV between 9:00 and 09:59 will change the output to ON, from 10:00 onwards back to AUTO (which is also ON). If the ADV puts the relay ON then the boost would apply immediately at the next OFF change, if the ADV puts the relay OFF then the boost would apply immediately and turn the relay ON.

08:00 OFF → 10:00 ON → 12:00 OFF → 14:00 ON

If ADV occurs at 08:30 and the relay is ON from 08:30 to 12:00. During this period, if at 08:45 +1Hr (Boost) is pressed, the relay will be ON from 08:30 to 12:00. Boost is applied immediately ie. from 08:45 to 09:45 at the next change, ie. 12:00. If ADV occurred at 10:30 the relay will be ON from 10:00, OFF from 10:30 (ADV) to 14:00 if no +1Hr Override. During ADV, if at 10:45 +1Hr (Boost) is pressed, the relay will go ON again at 10:45 (boost starts), OFF at 11:45 (Boost ends) until ends at 14:00, then ON again at 14:00.

## Programming the EP110

2 types of programs can be set:

- 5+2 (Mo to Fri same and Sat, Sun same)
- Different programs for each 24h.

There are 3 different time sets for each day.

5-2 Days Program	Individual Days Program
Weekdays 3 sets of time/channel Weekends 3 sets of time/channel <b>Total: 6 settings/week</b>	1 Day 3 sets of time/channel  <b>Total: 21 settings/week</b>

### Setting the 5+2 program



Press Set to start programming.

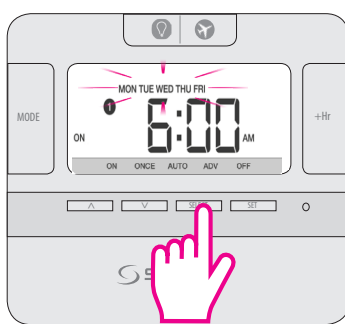

Press Up or Down to select weekdays or weekends. Press Select to confirm.

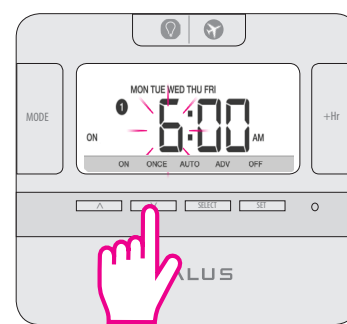

Press Up or Down to set start time for prog 1. Press Select to confirm.

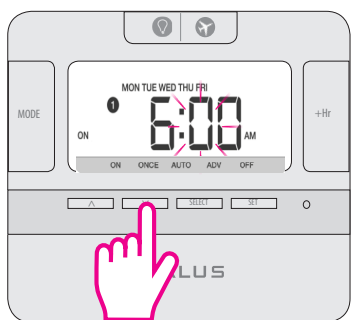

Press Up or Down to set the minutes. Press Select to confirm.

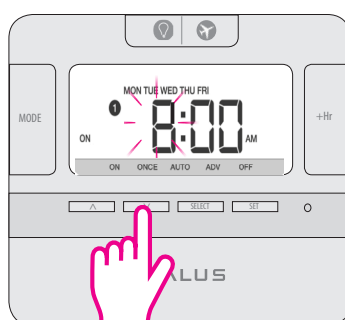

Press Up or Down to set end time for prog 1. Press Select to confirm.

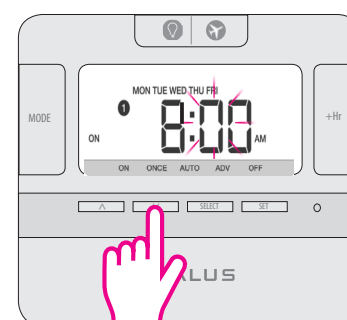

Press Up or Down to set the minutes. Press Select to confirm.

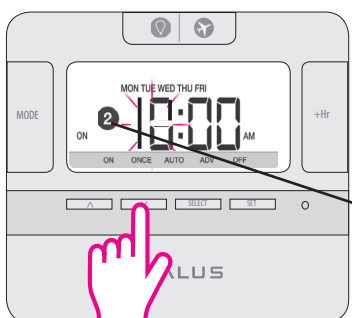

Press Up or Down to set start time for prog 2. Press Select to confirm.

Once you have finished setting the start/end time for the first program, the device will jump into the second program, and then into third and afterwards into Sat-Sun. Please follow the same steps for each of the 3 programs. Press **SET** at any time to confirm the setting and return for program set selection.

## Setting different programs for each 24h

Note: Don't forget to move the jumpers to 24h in order to have the individual program active. After that please follow the same instructions as for the 5-2 days program.



Press Set to start programming.

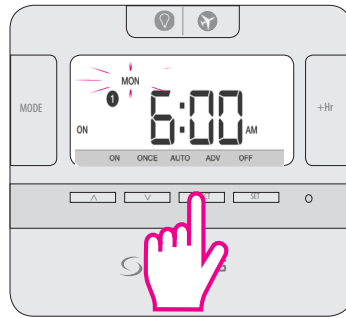

Monday will flash. Press Select to confirm.

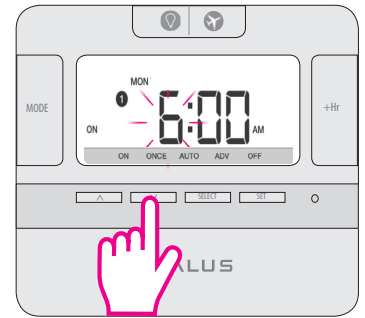

Press Up or Down to set start time for prog 1. Press Select to confirm.

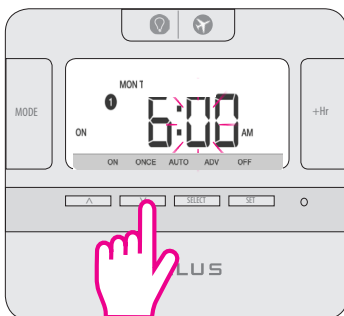

Press Up or Down to set the minutes. Press Select to confirm.

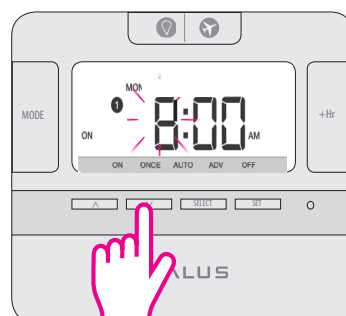

Press Up or Down to set end time for prog 1. Press Select to confirm.

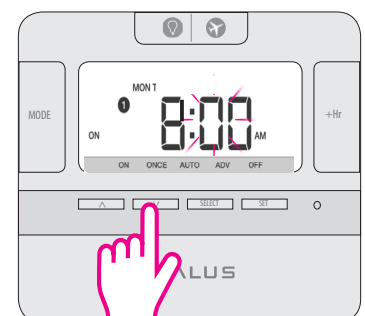

Press Up or Down to set the minutes. Press Select to confirm.

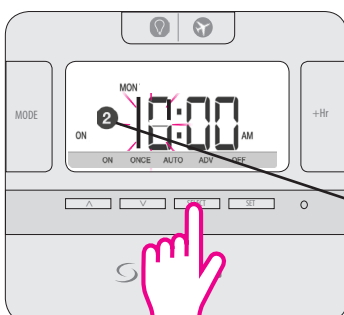

Press Up or Down to set start time for prog 2. Press Select to confirm.

Once you have finished setting the start/end time for the first program, the device will jump into the second program, and then into third and afterwards into next day. Please follow the same steps for each of the 3 programs. Press **SET** at any time to confirm the setting and return for program set selection.

## Temporary Override

### Boost Override (+1Hr override)

Boost Override (+1Hr override) is available in ONCE/AUTO/OFF modes. Boost mode can be activated even in ADV mode. When boost mode is activated, ADV is canceled. Press **+1Hr** at current mode to activate the Boost Override (+1Hr override) setting mode. Boost mode increases the time of the active program by 1-9 hours. The new setting hour “+x” (x=last boost hour+1 hour) is displayed. Subsequent press of **+1Hr** will increase the duration by 1 hour. Maximum duration is 9 hours. If the number rolls back to blank, this will disable the Boost Override.

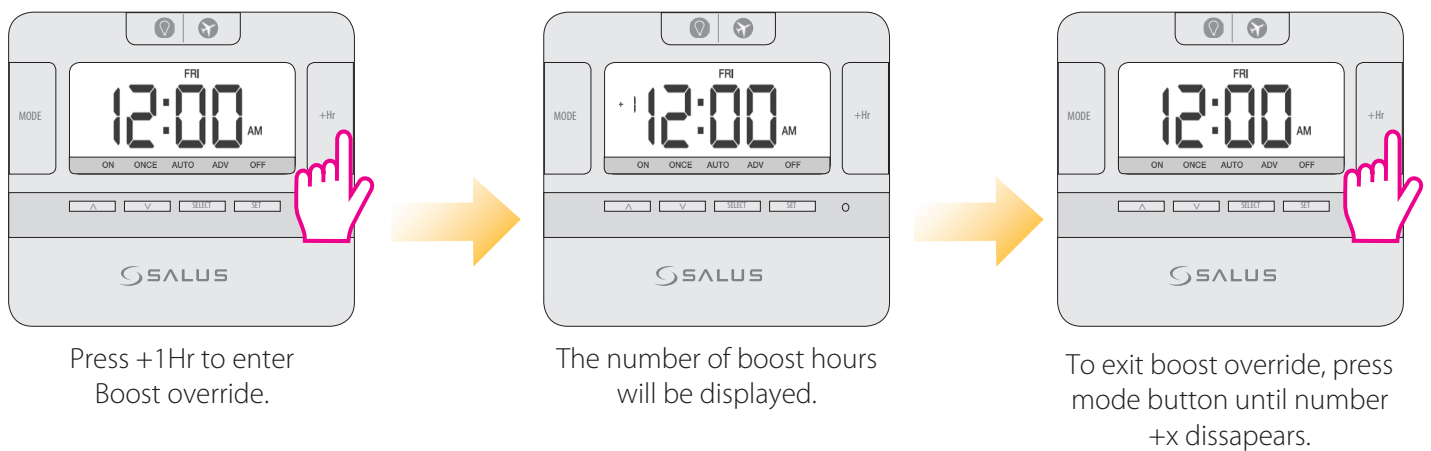

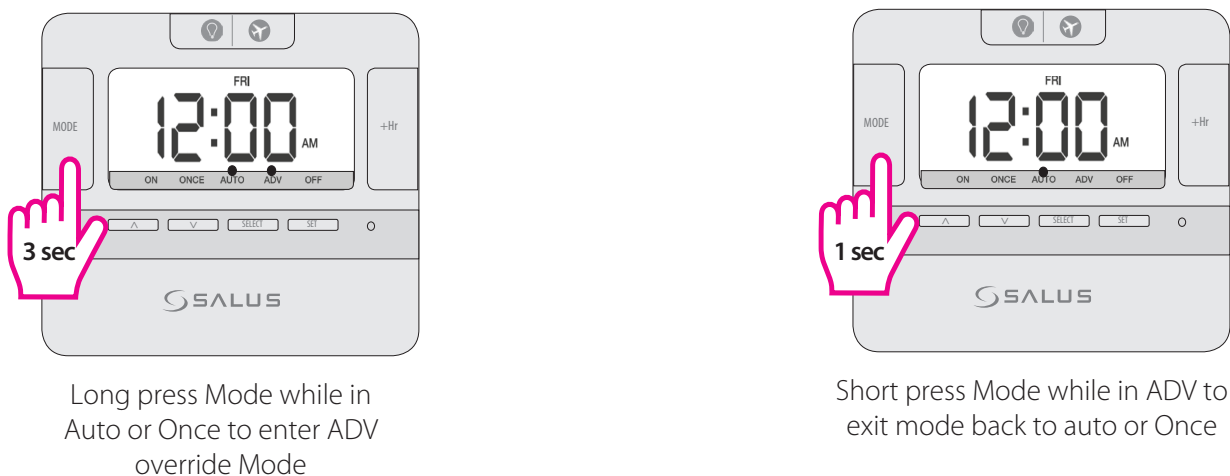

### ADV Override

ADV only works in AUTO or ONCE mode. During ADV, press **MODE** once to cancel ADV and go back to AUTO /ONCE mode after LCD backlight is turned off. +1Hr override and ADV cannot co-exist in same channel. During ADV mode, when **+1Hr** is pressed, override mode will cancel ADV mode then change to Boost mode. If +1Hr override (Boost) is running, then ADV is selected, ADV will be activated and the previous +1Hr override will be cancelled.



## Holiday Override

During the period of holiday override, relay should be always Off.

Press and hold  at current mode for 3 seconds to activate the Holiday Override setting mode. The plane icon will be displayed on the LCD and the user's only option will be to set the number of holiday days (up to 31). To exit Holiday Override and turn On the relay, long press the  key.

### Enter Holiday Mode

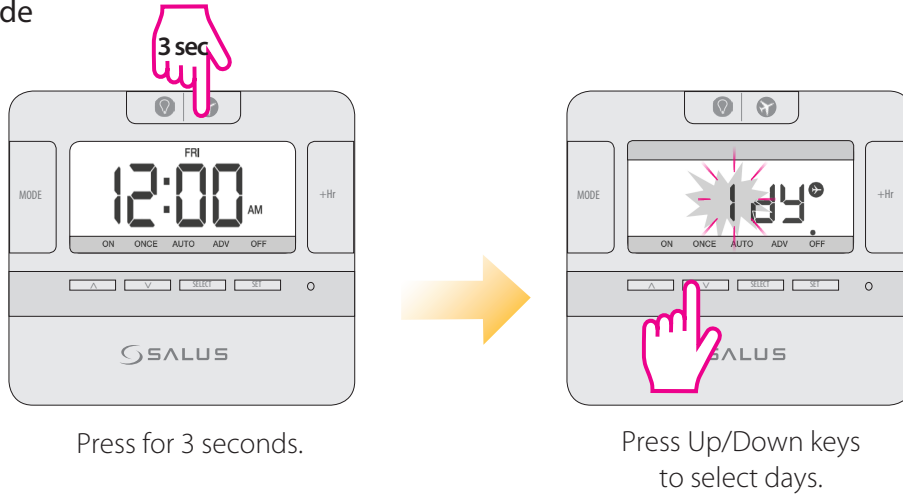

### Exit Holiday Mode

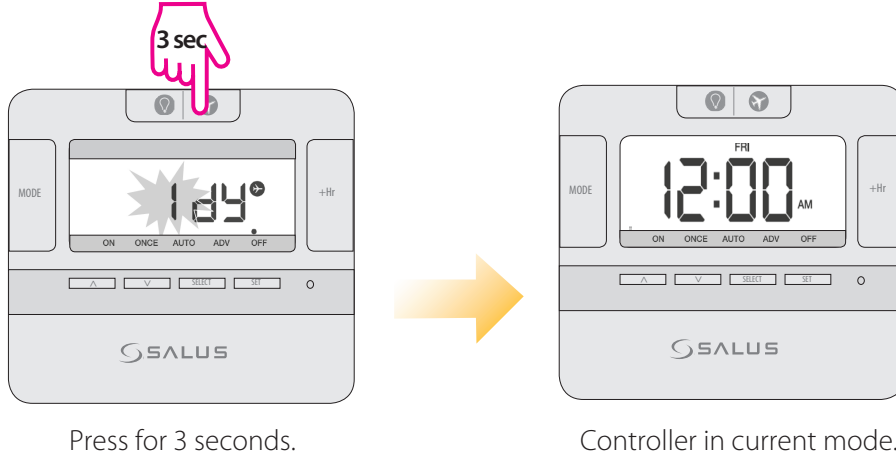

## LCD Backlight

If AC is powered, LCD backlight is activated when  or any key is pressed. The backlight will be turned off in 15 seconds after all keys are released.



## Factory Reset

If you want to return to the factory settings please press the Reset button once (use a pin for this action).



Press reset button.

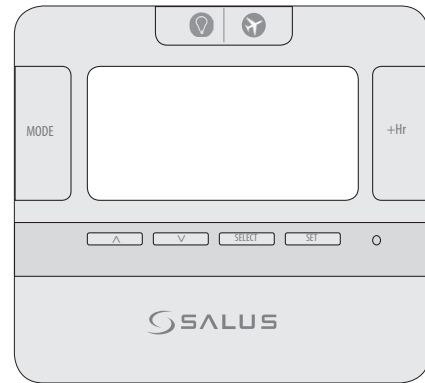

LCD will turn OFF.

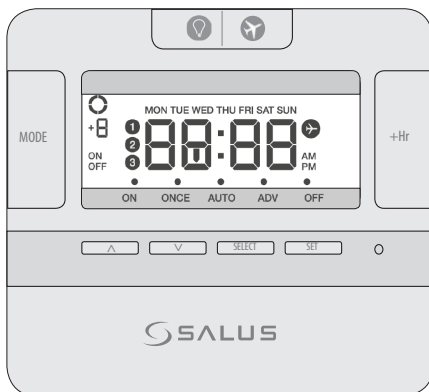

All icons will be displayed.



Software version.



Normal Mode.

<b>Product Specification</b>	
Model:	EP110
Type:	Surface Mounted Wired Single Channel Programmable Timer
Memory Backup	Lithium battery (CR2032 x1pc)
Power control	
Rating	230V/50Hz/3(1)A
Relay	SPDT
Protection Rating:	IP 30
Environment	
Operating Temperature/ Humidity:	0°C ~ 50°C, 10% – 90% non-condensing
Storage Temperature/ Humidity	-20°C~- 60°C, 10% – 90% non-condensing
Programs	
Program	5-2 or 24hr individual program (selectable by jumper), 3 settings/day, with holiday override.
Boost Override	Yes, max 9 hours(selectable by software)
Holiday Override	Yes, max 31 days (selectable by software)
Clock	
Clock Format	12 or 24 hour (selectable by software)
Clock Accuracy	+/-1 min/month
Daylight Saving Time (DST)	Yes, Clock automatically adjusted if DST is enabled.

## Warranty

SALUS Controls warrants that this product will be free from any defect in materials or workmanship, and shall perform in accordance with its specification, for a period of two years from the date of installation. SALUS Controls sole liability for breach of this warranty will be (at its option) to repair or replace the defective product.

Customer Name: .....

Customer Address: .....

..... Post Code: .....

Tel No: ..... Email: .....

Company Name: .....

Tel No: ..... Email: .....

Installation Date: .....

Installer Name: .....

Installer Signature: .....

SALUS Controls PLC

SALUS House

Dodworth Business Park South,  
Whinby Road, Dodworth,  
Barnsley S75 3SP, UK.

Sales: T: +44 (0) 1226 323961  
E: sales@salus-tech.com

Technical: T: +44 (0) 1226 323961  
E: tech@salus-tech.com

[www.salus-controls.com](http://www.salus-controls.com)



SALUS Controls is a member of the Computime Group

Maintaining a policy of continuous product development, SALUS Controls plc reserves the right to change specification, design and materials of products listed in this brochure without prior notice.

For the latest PFD Instruction Manual, go to [www.salus-manuals.com](http://www.salus-manuals.com)