



UK MANUFACTURER

[www.wirquin.co.uk](http://www.wirquin.co.uk)

**Celmac Macdee**  
*wirquin wirquin*

Sanitary Equipment Specialist



## CONTENTS

The Wirquin Group.....	4
Brands.....	5
Technology.....	6
Quality.....	7
Services.....	9

### Product Range:

<b>TOILET SEATS.....</b>	<b>11</b>
Thermoset.....	14
Thermoplastic.....	25
Mouldwood.....	31
Special Needs.....	35
Decor.....	40
Spares & Accessories.....	41
<b>FLUSHING.....</b>	<b>43</b>
Flush valves.....	44
Siphons.....	50
Inlet valves.....	53
Concealed Cisterns.....	57
Exposed Cisterns.....	62
Urinal.....	67
Spares & Accessories.....	70

<b>FRAMES.....</b>	<b>75</b>
Chrono.....	76
Intramuros.....	78
PPX.....	80
2 in 1.....	81
Push Plates.....	82

<b>WETROOMS.....</b>	<b>85</b>
Venisio Expert.....	86
Venisio Slim.....	89
Venisio - Linear Channel.....	90
Venisio - Square Drain.....	94

<b>SHOWER.....</b>	<b>97</b>
Shower Waste 90.....	98
Shower Waste 50.....	106
Flush Grated 60.....	108
Flush Grated 72.....	109
Flush Grated 85.....	110
Shower Tray Feet.....	111

<b>BATH.....</b>	<b>113</b>
Cable Operated.....	113
Quick Clac & Rotary.....	116
Plug & Chain.....	117

<b>BASIN.....</b>	<b>121</b>
Space Saving Traps.....	121
Bottle Traps.....	123
Quick Clac Wastes.....	126
Captive Wastes.....	128
Flush Grated Wastes.....	129
Plug & Chain Wastes.....	130

<b>SINK.....</b>	<b>133</b>
Space Saving Traps.....	133
Sink Kits.....	135
Undersink Plumbing Kits.....	136
Combination Wastes.....	137
Basket Strainers.....	138
Belfast Sink Wastes.....	139

<b>WASTES SPARES &amp; ACCESSORIES.....</b>	<b>141</b>
Shower Tray Feet.....	141
Waste Connectors.....	142
Adaptors & Chains.....	143
Backnuts & Plugs.....	144

<b>WASTE, PIPE &amp; PAN CONNECTORS.....</b>	<b>145</b>
Jollyflex Extendable.....	146
Jollyflex Flexible.....	148
Rigid.....	149
Short Connectors.....	150
Magicflex®.....	151
Waste Connectors.....	153

## INTERNATIONALLY RENOWNED SANITARY EQUIPMENT SPECIALIST

A family business founded in 1977 by Daniel Le Coënt, WIRQUIN manufactures sanitaryware products and accessories for the bathroom, toilet and kitchen.

The company has grown steadily for 39 years. In 2014 Wirquin achieved a turnover of more than 130 million Euros. This is generated by 1,400 Talents® driven by their corporate values: team spirit, respect, sharing and performance. Always at the forefront of innovation, the group designs 15 new products a year making life easier for the end user, helping installers to be more professional and improving stock rotation for the distributors. To achieve this the Group invests 5% of its annual turnover in Research and Development.

As the company has grown, Wirquin has strengthened its roots in France while developing its international subsidiaries. Today the Group has 10 subsidiaries worldwide, including 6 factories.

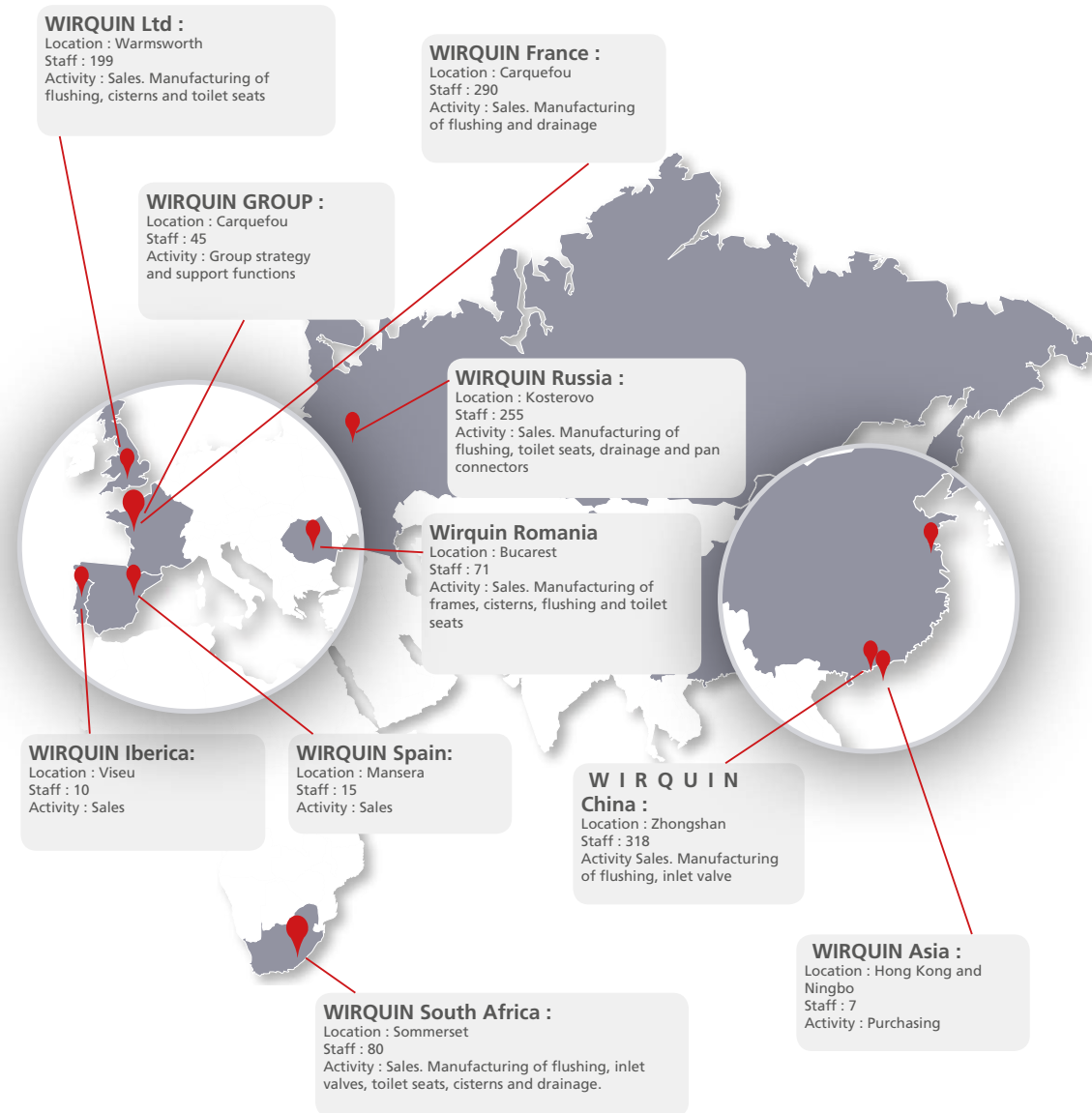

## WIRQUIN LTD.

Wirquin Ltd. based in Doncaster, Yorkshire, offers the renowned brands **Celmac Wirquin** and **Macdee Wirquin**.

### Celmac – Tried and trusted since 1890

**Celmac**  
*wirquin*

Celmac Wirquin is a leading toilet seat manufacturer in the UK. It produces over one million pieces per year to a wide range of design and technical specifications. Celmac has produced toilet seats since 1890 and is historically renowned for the 1930s black crescent school seat with the gap in the front (Crescent) as well as for setting the British Standard with the BS1254 Type 1 (Sonata) and the BS1254 Type 2 (Emerald) which are still manufactured today. Alongside the more traditional designs, Celmac also offers contemporary seat designs including bespoke colours and images.

Celmac Wirquin offers a wide range of thermoset, thermoplastic and mouldwood toilet seats for the home, high traffic areas and special needs. There is also a choice of hinge types to suit all requirements whether it be plastic, stainless steel (guaranteed to be non-corrosive), adjustable, top fix, quick release and/or soft close.

### Macdee since 1976 – Make it easy, Make it Macdee

**Macdee**  
*wirquin*

Macdee Wirquin provides installers with a wide range of flushing mechanisms, frames, cisterns, wastes, traps, connectors, wetroom solutions and accessories. It's world renowned products are designed and produced with the installer and end user in mind - ensuring they are quick and easy to install, cost effective, robust, reliable and guaranteed to last.

A full range of flushing valves, inlet valves, siphons and kits are WRAS approved and meet, if not exceed, British Standards and customers' requirements to save water and money.



*"From traditional to contemporary..."*

## ■ LEADING INNOVATIVE TECHNOLOGY

Wirquin products are innovatively designed and manufactured to be quick and easy to install, reliable, high performing, robust and water saving.

### Research & Development

Innovation is a fundamental part of the Wirquin ethos. As a leader in its field, Wirquin invests 5% of its annual turnover into Research and Development. Our R&D team continually analyses the market and listens to customer feedback in order to conceive and develop leading high spec plumbing solutions.

## ■ MADE IN BRITAIN

Wirquin is proud to manufacture Celmac Wirquin and Macdee Wirquin products in the UK that meet and set industry standards. Our factory in Doncaster includes:

- ▶ CAD design
- ▶ Injection moulding
- ▶ Compression moulding
- ▶ Assembly
- ▶ Packing and distribution
- ▶ Quality testing
- ▶ Sales & Aftersales



MADE IN  
THE UK



## ■ QUALITY

Because Wirquin is committed to quality, our products and customer relations are made to last.

With thorough product testing being critical to ensure problem-free installation and use, Wirquin recently invested in a 100m<sup>2</sup> new laboratory with a team of 12 technicians. The UK production site also has a dedicated quality assurance team that tests and continually monitors products for their quality and performance.

### Guarantees

Products come with a 2-year, 5-year or 10-year guarantee.

### WIRQUIN Ltd Has been certified ISO9001 for more than 15 years

Through rigorous analysis of our management system, this approach ensures the quality of the processes we have implemented. The objective of ISO9001 is to increase customer satisfaction, enabling us to provide a level of quality that corresponds to their needs and requirements.

### Industry Membership

Wirquin's commitment to the plumbing industry is reinforced by our membership of the British Manufacturers Association (BMA).

## ■ RECOGNISED EXCELLENCE

Wirquin has won numerous industry awards for its innovative products and customer service. The most recent awards include the KBB Award for Innovation, Chamber Business Awards for Innovation, Export, Corporate, Social and Environmental Responsibility and a customer award for the Most Improved Supplier of the Year.



## ■ ENVIRONMENTAL RESPONSIBILITY

Wirquin strives to minimise the environmental impact of its activities. Ongoing reviews of our manufacturing and distribution methods ensure the reduction of our energy use and an increase in recycling.

In 2015, Wirquin Ltd achieved the ISO14001 Environmental Management Systems accreditation – the international standard for a reduced impact on the environment.

The company also achieved FSC (Forest Stewardship Council) accreditation for its wood based products including Celmac toilet seats. Using the FSC logo certifies that the products are from responsible sources, environmentally friendly, socially beneficial and economically viable.

### Water Saving and Sustainability

At Wirquin we recognise the importance of saving water and work hard to ensure that, wherever possible, our products and new innovations are recognised and accredited by the leading bodies and associations in our industry.

A large range of Macdee Wirquin products are approved by the **Water Regulatory Advisory Scheme (WRAS)** to meet the requirements of the Water Supply (Water Fittings) Regulations in England, Wales and Northern Ireland, and the Scottish Byelaws to ensure they are water saving and 'of an appropriate quality and standard'.

A range of Macdee Wirquin products carry the **Waterwise Mark** for their water saving credentials.

Certain water saving devices are on the **Water Technology List (WTL)** for their ability to not only help reduce water bills but businesses can claim against their water saving investment under the Enhanced Capital Allowance (ECA) Water Scheme. Look out for the WTL logo to recognise approved products.

## ■ CORPORATE RESPONSIBILITY

Wirquin supports numerous international, national and local charities. Wirquin employees worldwide are proud to be partnering with the World Toilet Organization to fight against the global sanitation crisis. Throughout the year they are raising awareness and funds to support sustainable sanitation projects such as clean and safe toilets in Cambodian floating villages.





## CUSTOMER SERVICE

From innovative design to installation and beyond – we are dedicated to your success.

### Customer Focus

Wirquin works closely with customers of all sizes from distributors (OEM, trade, export, DIY, retail) to installers and the end user. Every customer is offered tailored product knowledge, technical advice, installation solutions, trainings, experience, innovation and great customer support throughout each and every project.

### Sales Team



Products can be quickly and easily ordered through our dedicated UK Sales Team by telephone, fax, EDI or email.

### National Sales Team

Our experienced Regional Business Development Managers are located around the UK and Ireland to offer advice on the extensive range of products and ensure customers feel supported during the selection and ordering process, installation and beyond. For your nearest Regional Business Development Manager, please contact the Sales Team.

### Technical Support and After Sales Team



Our Technical Support and After Sales teams can assist with specification choices, as well as regularity compliance and installation advice. We will get back to you within 24 business hours.

### Minimum Order



For the UK mainland, please note that there is a minimum order value of £150 carriage paid to any one delivery point. Certain products can be ordered in pallet quantities.

### Delivery



With Wirquin, ordering could not be simpler. We aim for orders to be delivered within 1.5 days to ensure strong customer satisfaction. By constantly analysing our performance, Wirquin strives to set the gold standard in customer satisfaction.

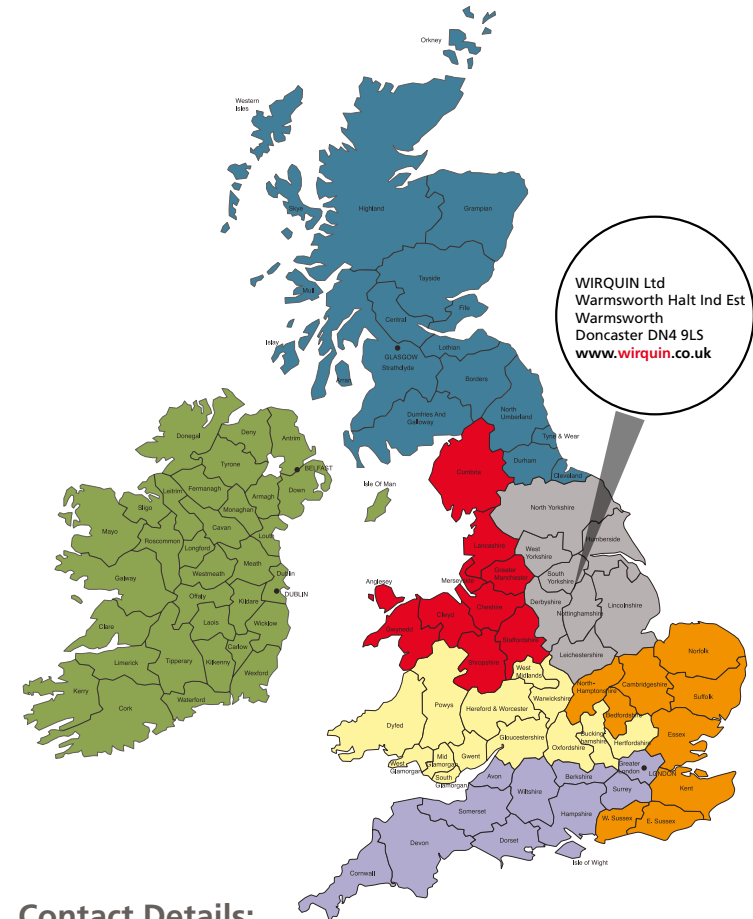

### Contact Details:

Telephone: +44 (0)333 222 4488

Fax: +44 (0)130 231 2251

Email: [sales@wirquin.co.uk](mailto:sales@wirquin.co.uk)

[aftersales@wirquin.co.uk](mailto:aftersales@wirquin.co.uk)

[www.wirquin.co.uk](http://www.wirquin.co.uk)

## ■ WIRQUIN FOR YOU 24/7

Wirquin has a new website offering you tailored information and advice to meet your specific requirements.

You will find:

- ▶ Easy product selection
- ▶ Installation videos
- ▶ Installation tips and advice
- ▶ Technical product specifications



Installation videos

Clear and easy navigation



Download technical information

Easy product selection

Supplier locator

Commercial leaflet



[www.wirquin.co.uk](http://www.wirquin.co.uk)

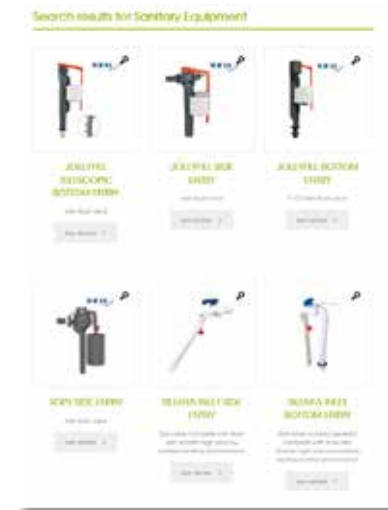

# TOILET SEATS

THERMOSET TOILET SEATS

THERMOPLASTIC TOILET SEATS

MOULDWOOD TOILET SEATS

SPECIAL NEEDS TOILET SEATS

DECOR TOILET SEATS

SPARES & ACCESSORIES

**Celmac**  
*wirquin*

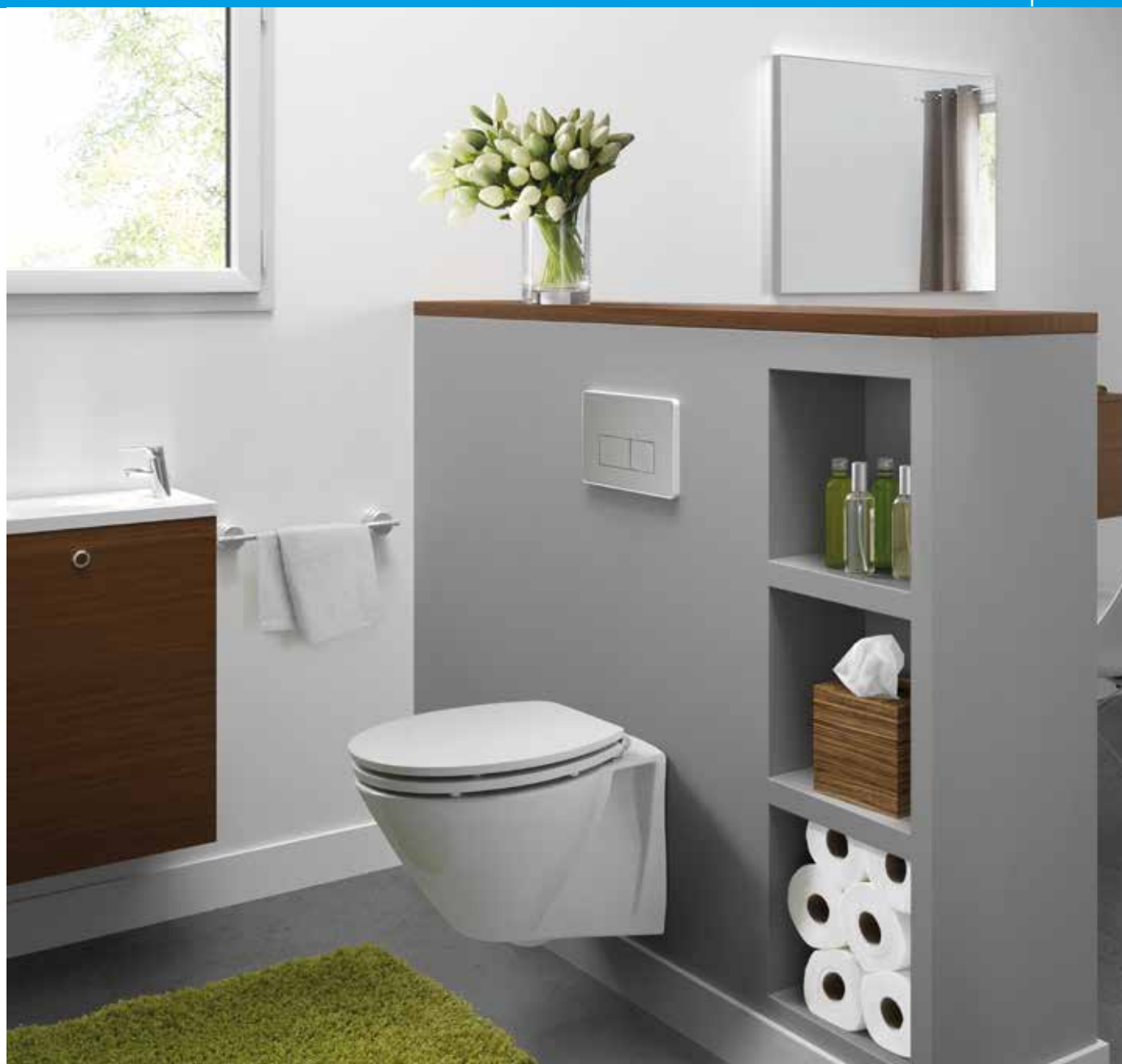

## CELMAC WIRQUIN SPECIFICATIONS TO MATCH ANY NEEDS

### COVER

Celmac Wirquin offers a very wide range of covers. Our different shapes include dished, domed or flat and can come in slim sandwich, semi or full wrap options.

### HINGE

With hinges and their component parts being integral to the function of every toilet seat, we have developed a range that is adjustable, flexible and securely fitted.

With a variety of fitting options including; bottom fixing, blind hole fixing and quick release to ensure ease of installation every time.

We focus on effective application and endurance testing as well as guaranteeing 304 grade stainless steel across all of our stainless steel hinges.

### SEAT

Celmac Wirquin seats are ergonomically designed for comfort with buffers to stabilise the seat to the pan.

Where most toilet seats have 2 or 4 buffers, Celmac Wirquin also offers additional locating buffers mainly dedicated to the requirements of Doc M.

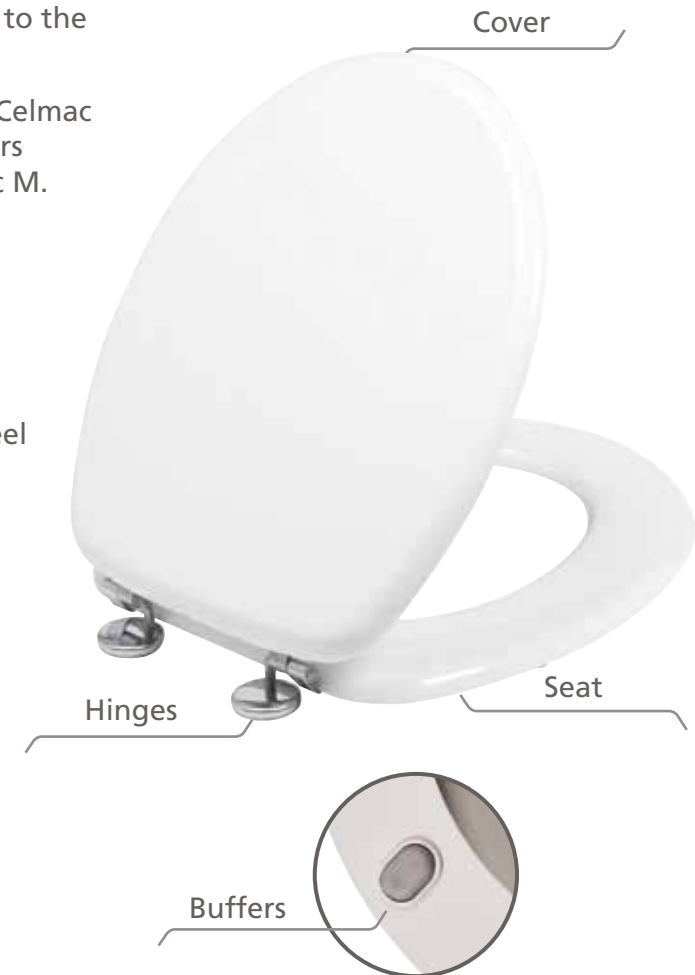

**Education:** Some dedicated seats are specially designed to fit 12" school pans.



**Antiviral:** Celmac Wirquin offers anti-viral options dedicated to hospitals or care homes.



**Special Needs:** Celmac Wirquin offers dedicated toilet seats to meet the requirements of the less able.



#### Hinge Type

Bottom fixing is a traditional type of fitting where the underside of the mounting hold is accessible to allow the tightening of the hinge fixings.



Top fixing is required when there is a limited/no access to the underside of the hinge mounting holes (back to wall pans).



Quick release for easy removal of the seat without tools, enabling thorough cleaning for maximum hygiene



Soft close incorporating specialist dampers for a gentle, quiet closing action, offering added safety. No more trapped fingers.

## FIT FOR ALL | HOW TO SELECT YOUR PERFECT CELMAC WIRQUIN SEAT

### STEP 1

First consider the application of the seat and the environment where it will be installed. It will help you choosing your material. Check material properties on each material description page.

### STEP 3

Then select the shape of your bowl to find out which seats will fit appropriately.



Traditional rounded shape.



D-Shape



Bespoke shape.  
For information please contact the sales office

### STEP 2

Now you need to think about the size of your seat. There are different measurements to consider.

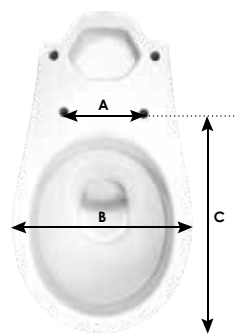

- A: Distance between the middle of the 2 holes in the pan
- B: Width of the pan
- C: Projection from the middle of the 2 holes up to the front of the pan.

### STEP 4

Finally, decide which seat design and hinge type best suits your requirements.  
Overlying cover: often referred as Sandwich style  
Wrap over covers  
Dished design  
Domed design

## PAN MATRIX

Discover our pan matrix on our website

[WWW.CELMAC-WIRQUIN.CO.UK](http://WWW.CELMAC-WIRQUIN.CO.UK)

1. Select your manufacturer
2. Select your suite
3. Find your matching seat



Melody toilet seat with Ideal Standard (Sandringham 21)

## THERMOSET MATERIAL

- ▶ **Resilient:** Extremely strong, durable and hardwearing material
- ▶ **Resistant to scratches, flames and chemicals**
- ▶ **Natural anti-viral properties**
- ▶ **Ceramic white**



### MELODY 1.5KG

- Mediumweight white thermoset
- Universal shape
- Contemporary overlaying cover



### VIP 2.3KG

- Heavyweight white thermoset
- Universal shape
- Contemporary overlaying cover































### SONATA 2.3KG

- Heavyweight white thermoset
- Universal shape
- Traditional design

The original seat that set the British Standard 1254 Type 1

Thermoset material, a dense plastic noted for its incredible strength and durability. Such resilient and anti-viral properties make it ideal for high traffic areas such as hospitals and building developments.

## THERMOSET

Product	Weight	Shape Cover	Hinge material	Hinge option	Specification	Page number
Calypso	1.3kg	Traditional dished	Plastic		Ideal for medium traffic areas	18
Fusion	1.5kg	Semi wrap over cover	Stainless steel	   	Medium weight thermoset toilet seat	24
Magnum	1.5kg	Flat sandwich	Plastic or stainless steel		Entry level thermoset toilet seat	21
Tamar	1.5kg	Flat sandwich	Plastic or stainless steel		Available in different colours	20
Melody	1.5kg	Dished sandwich	Plastic or stainless steel		Entry level thermoset toilet seat	19
Neptune	1.6kg	Shell shape	Plastic		Shell traditional design	19
Saxon	1.6kg	Traditional dished	Plastic or stainless steel		Ideal for medium to high traffic areas	17
<b>NEW</b> Lyric	1.7kg	Fully wrap over	Plastic		Entry level thermoset toilet seat	21
Concerto	2.1kg	Domed sandwich	Stainless steel		Medium level thermoset toilet seat	24
<b>NEW</b> Disco	2.1kg	D-Shape full wrap over	Stainless steel	  	Trendy D-Shape seat	23
Maestro	2.1kg	D-Shape semi wrap over	Stainless steel	   	D-Shape - Ideal for back to wall pans	23
<b>NEW</b> Svelt	2.1kg	D-Shape slim	Stainless steel	  	Slim modern D shape	22
Sonata	2.3kg	Traditional dished	Plastic or stainless steel	 	Doc M version available	16
VIP	2.3kg	Dished cover	Stainless steel	   	High quality thermoset toilet seat	22



**Soft close:** allows the seat and cover to close gently and quietly, preventing noise and trapped fingers.



**Quick release:** tool free, quick and easy removal of the toilet seat for better hygiene thanks to its ease of cleaning.



**Top fix:** fitting of the seat from the top. Required when restricted or no access (back to wall pans).



**Bottom fix:** fitting of the seat from the bottom of the pan.

**SONATA**



- ▶ The seat which set the **BS1254 Type 1 standard**.
- ▶ Heavyweight thermoset seat option.
- ▶ Ergonomically designed seat for extra comfort.
- ▶ Flat underside for easy cleaning.
- ▶ Strong, durable, and scratch resistant.
- ▶ Seat only option and DOC M version also available.
- ▶ Nominal Weight: **2.3 kg seat & cover** - 1.6 kg seat only.



**SINCE 1966**

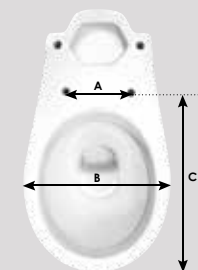

A - Hole centres: 130-177mm  
 B - Width: 370mm  
 C - Seat projection: 400-435mm



Description	Packaging	Colour	Reference	Hinge	Multiple/boxed	EAN code
Seat & cover with colour matched plastic hinge	Individually boxed	White	SSO11WH	FDP11WH	90/Pallet	5012158010232
	Individually boxed	Black	SSO11BL	FDP11BL	90/Pallet	5012158653484
	Pack of 5	White	SSO21WH	FDP11WH	120/Pallet	5024139038968
	Pack of 5	Black	SSO21BL	FDP11BL	120/Pallet	5012158010133
Seat only option	Individually boxed	White	SSO51WH	FDP11WH	90/Pallet	5012158667122
	Individually boxed	Black	SSO51BL	FDP11BL	90/Pallet	5012158666828
Seat & cover with stainless steel hinge	Individually boxed	White	SSO12WH	FSS11SS	90/Pallet	5012158669409
	Individually boxed	Black	SSO12BL	FSS11SS	90/Pallet	5012158669362
Seat only option	Individually boxed	White	SSO53WH	FSS11SS	120/Pallet	5012158669416
	Individually boxed	Black	SSO53BL	FSS11SS	120/Pallet	5012158669379
Seat & cover with top fix stainless steel hinge	Individually boxed	White	SSO15WH	FBH11SS	90/Pallet	5012158669409
	Individually boxed	Black	SSO15BL	FBH11SS	90/Pallet	5012158669362
Seat only option	Individually boxed	White	SSO55WH	FBH11SS	120/Pallet	5012158669416
	Individually boxed	Black	SSO55BL	FBH11SS	120/Pallet	5012158669379
Anti viral seat & cover with stainless steel hinge	Individually boxed	White	SSO1QWY	FD211SS	90/Pallet	5024139035837
	Individually boxed	Innas Blue	SSO1QIB	FD211SS	90/Pallet	5024139039279
Seat only option	Individually boxed	White Anti viral	SSO5QWY	FD211SS	120/Pallet	5024139035844
	Individually boxed	Innas Blue Anti viral	SSO5QIB	FD211SS	120/Pallet	5024139034298





**SAXON**



- ▶ Medium weight thermoset seat option.
- ▶ Plastic or stainless steel hinge options.
- ▶ Strong and durable.
- ▶ Chemical, flame, and scratch resistant.
- ▶ Flat underside for easy cleaning.
- ▶ Universal fitting.
- ▶ Ideal for contract purposes in medium to high traffic areas.
- ▶ Nominal Weight: **1.6 kg seat & cover** - 0.95 kg seat only

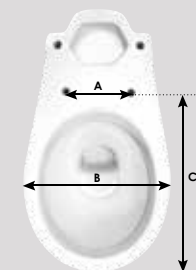

A - Hole centres: 134-184mm  
B - Width: 376mm  
C - Seat projection: 441-457mm



Description	Colour	Hinge	Reference	EAN code	Packaging	Multiple/boxed
Seat and cover with colour matched plastic hinge	White	FDP11WH	SSA11WH	5012158653866	Individually boxed	90/Pallet
	Black	FDP11BL	SSA11BL	5012158655785	Individually boxed	90/Pallet
	White 5 Pack	FDP11WH	SSA21WH	5012158030230	Pack of 5	150/Pallet
	Black 5 Pack	FDP11BL	SSA21BL	5012158030131	Pack of 5	150/Pallet
Seat only with colour matched plastic hinge	White	FDP11WH	SSA51WH	5012158666422	Individually boxed	90/Pallet
	Black	FDP11BL	SSA51BL	5012158665968	Individually boxed	90/Pallet
Seat and cover with stainless steel hinge	White	FSS11SS	SSA12WH	5012158669324	Individually boxed	90/Pallet
	Black	FSS11SS	SSA12BL	5012158669287	Individually boxed	90/Pallet
Seat only with stainless steel hinge	White	FSS13SS	SSA53WH	5012158669331	Individually boxed	90/Pallet
	Black	FSS13SS	SSA53BL	5012158669294	Individually boxed	90/Pallet



FDP11WH



FSS13SS



FDP11BL



FSS11SS

CALYPSO



- ▶ Lightweight, cost effective thermoset option.
- ▶ Adjustable colour matched plastic hinge (including rod).
- ▶ Available as a seat only option.
- ▶ Universal fitting.
- ▶ Ideal for contract purposes in medium traffic areas.
- ▶ Nominal Weight: **1.3 kg seat & cover** - 0.70 kg seat only

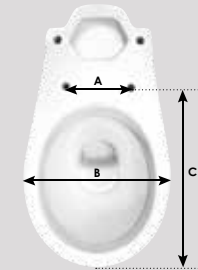

A - Hole centres: 130-178mm  
 B - Width: 370mm  
 C - Seat projection: 425-441mm



FDP11WH



FDP11BL

Description	Colour	Hinge	Reference	EAN code	Packaging	Multiple/boxed
Seat and cover with colour matched plastic hinge	White	FDP11WH	SCA11WH	5012158689414	Individually boxed	90/Pallet
	Black	FDP11BL	SCA11BL	5012158080174	Individually boxed	90/Pallet
	White 5 Pack	FDP11WH	SCA21WH	5012158650537	Pack of 5	150/Pallet
	Black 5 Pack	FDP11BL	SCA21BL	5012158650261	Pack of 5	150/Pallet
Seat only option	White 5 Pack seat only	FDP11WH	SCA61WH	5024139039064	Pack of 5	150/Pallet

## MELODY



- ▶ Medium weight thermoset seat option.
- ▶ Universal shape designed to fit modern sanitaryware shapes.
- ▶ Dished-design overlaying cover.
- ▶ Durable and scratch resistant.
- ▶ Nominal Weight: **1.5 kg**



FDR11WH



FDR11SS

Description	Hinge	Reference	EAN code	Packaging	Multiple/boxed
Seat and cover with colour matched plastic hinge - White	FDR11WH	SME11WH	5012158686147	Individually boxed	90/Pallet
Seat and cover with stainless steel hinge - White	FDR11SS	SME18WH	5012158690663	Individually boxed	90/Pallet

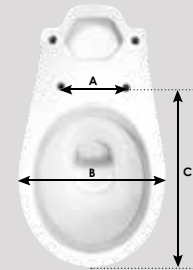

A - Hole centres: 145-185mm  
B - Width: 357mm  
C - Seat projection: 405-420mm

## NEPTUNE



- ▶ Mediumweight thermoset seat option.
- ▶ Universal shape designed to fit modern sanitaryware shapes.
- ▶ Shell sandwich cover design.
- ▶ Strong, durable & scratch resistant.
- ▶ Nominal Weight: **1.6 kg**



FDP11WH

Description	Hinge	Reference	EAN code	Packaging	Multiple/boxed
Seat and cover with colour matched plastic hinge	FDP11WH	SNE11WH	5027681005914	Individually boxed	90/Pallet

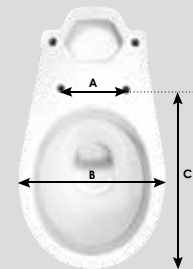

A - Hole centres: 125-170mm  
B - Width: 365mm  
C - Seat projection: 425-440mm

TAMAR



- ▶ Medium weight thermoset seat option.
- ▶ Adjustable colour matched plastic hinge (including rod).
- ▶ Available in various colours.
- ▶ Designed to fit traditional style UK sanitaryware.
- ▶ Overlaying cover design.
- ▶ Durable and scratch resistant.
- ▶ Nominal Weight: **1.5 kg**



Description	Colour	Hinge	Reference	EAN code	Packaging	Multiple/boxed
Seat and cover with colour matched plastic hinge	White	FDP11WH	STA11WH	5012158667535	Individually boxed	90/Pallet
	Black	FDP11BL	STA11BL	5012158674984	Individually boxed	90/Pallet
Seat and cover with stainless steel hinge	Champagne	FCS11SS	STA14CH	5012158667467	Individually boxed	90/Pallet
	Whisper Grey	FCS11SS	STA14WG	5012158670665	Individually boxed	90/Pallet



STA11BL



STA14CH



STA14WG

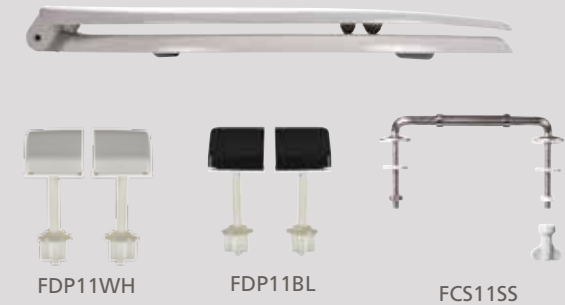

**LYRIC**



- ▶ Medium weight seat option.
- ▶ Adjustable colour matched plastic hinge (including rod).
- ▶ Designed to fit traditional style UK sanitaryware.
- ▶ Flat wrap-over design cover.
- ▶ Durable and scratch resistant.
- ▶ Nominal Weight: **1.7 kg**



FDP11WH

Description	Hinge	Reference	EAN code	Packaging	Multiple/boxed
Seat and cover with colour matched plastic hinge - White	FDP11WH	SLY11WH	5012158671891	Individually boxed	90/Pallet

**MAGNUM**



- ▶ Medium weight thermoset seat option
- ▶ Short projection seat for modern pans
- ▶ Stainless steel hinge
- ▶ Nominal Weight **1.5 kg**



SF520



FDR11SS



FDR11WH

Description	Hinge	Reference	EAN code	Packaging	Multiple/boxed
Seat and cover with plastic adjustable hinge - White	FDR11WH	20120219	5017134132403	Individually boxed	90/Pallet
Seat and cover with stainless steel adjustable hinge - White	FDR11SS	SMG18WH	5024139039972	Individually boxed	90/Pallet
Seat and cover with stainless steel top fix hinge	SF520	SMG1TH	5024139040060	Individually boxed	90/Pallet

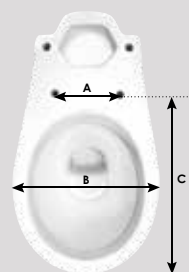

A - Hole centres: 130-178mm  
 B - Width: 370mm  
 C - Seat projection: 425-441mm

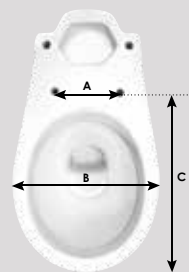

A - Hole centres: 145-185mm  
 B - Width: 357mm  
 C - Seat projection: 405-420mm

**THERMOSET TOILET SEATS**

**THERMOPLASTIC TOILET SEATS**

**MOULDWOOD TOILET SEATS**

**SPECIAL NEEDS TOILET SEATS**

**DECOR TOILET SEATS**

**SPARES & ACCESSORIES**

**VIP**



- ▶ Heavyweight thermoset seat option.
- ▶ Universal shape designed to fit modern sanitaryware shapes.
- ▶ Smooth surfaces for easy cleaning.
- ▶ High quality stainless steel hinge options.
- ▶ Strong, durable & scratch resistant.
- ▶ Nominal Weight: **2.3 kg**



Description	Hinge	Reference	EAN code	Packaging	Multiple/boxed
Seat and cover with stainless steel hinge - white	FMN11SS	SVP11WH	5024139038838	Individually boxed	90/Pallet
Seat and cover with stainless steel top fix hinge - White	FOR12SS	SVP1TWH	5024139039347	Individually boxed	90/Pallet
Seat and cover with stainless steel hinge - White	FSP15SS	SVP1SWH	5024139039422	Individually boxed	90/Pallet

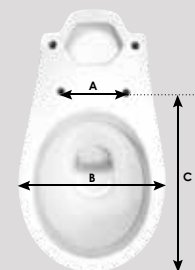

A - Hole centres: 135-175mm  
 B - Width: 380mm  
 C - Seat projection: 410-450mm

**SVELT**



- ▶ Heavy weight thermoset seat option
- ▶ Slim D shape
- ▶ Pre assembled soft close hinge
- ▶ Nominal Weight **2.1 kg**



Description	Hinge	Reference	EAN code	Packaging	Multiple/boxed
Seat and cover with stainless steel hinge - White	Pre assembled	20721439	3375537213689	Individually boxed	1/4/90

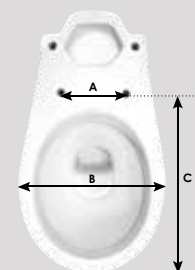

A - Hole centres: 160-195mm  
 B - Width: 358mm  
 C - Seat projection: 425-430mm

## MAESTRO



- ▶ Heavyweight thermoset seat option.
- ▶ Designed to suit 'D' shaped pans.
- ▶ Concealed adjustable stainless steel hinges.
- ▶ Top Fix and soft close hinge options available.
- ▶ Wrap-over cover design.
- ▶ Strong, durable & scratch resistant.
- ▶ Nominal Weight: **2.1 kg**



Description	Hinge	Reference	EAN code	Packaging	Multiple/boxed
Seat and cover with stainless steel hinge - White	FDR11SS	SMA18WH	5012158690717	Individually boxed	90/Pallet
Seat and cover with top fix - White	SF520	SMA15WH	5024139038562	Individually boxed	90/Pallet
Seat and cover with stainless steel soft close top fix hinges - White	FMASTSS	SMA15WH	5024139040053	Individually boxed	90/Pallet



## DISCO



- ▶ Heavyweight thermoset seat option.
- ▶ Designed to suit D-Shaped pans.
- ▶ Wrap over cover design.
- ▶ Pre assembled top fix, quick release and soft close.
- ▶ Nominal Weight **2.1 kg**



Description	Hinge	Reference	EAN code	Packaging	Multiple/boxed
Seat and cover with soft close stainless steel hinge	Pre assembled	20721512	3375537214419	Individually boxed	1/4/90



## FUSION



- ▶ Medium weight thermoset seat option.
- ▶ Universal shape designed to fit modern sanitaryware.
- ▶ Concealed adjustable stainless steel hinges.
- ▶ Top Fix hinge options available.
- ▶ Domed wrap-over cover design.
- ▶ Smooth surfaces for easy cleaning.
- ▶ Strong, durable & scratch resistant.
- ▶ Nominal Weight: **1.5 kg**



Description	Hinge	Reference	EAN code	Packaging	Multiple/boxed
Seat and cover with stainless steel hinge - White	FMN11SS	SFU11WH	5024139033642	Individually boxed	90/Pallet
Seat and cover with stainless steel top fix, quick release and soft close hinge - White	FSXSTSS	SFU1SWH	5024139039828	Individually boxed	90/Pallet



## CONCERTO



- ▶ Heavyweight thermoset seat option.
- ▶ Classic domed overlaying cover design.
- ▶ Smooth, easy to clean underside.
- ▶ Strong, durable, and scratch resistant.
- ▶ Nominal Weight **2.1 kg**

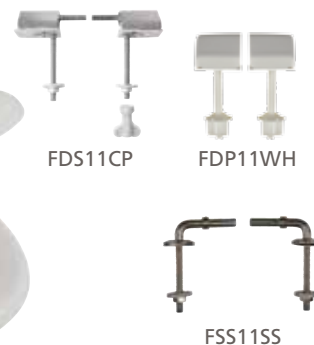

Description	Hinge	Reference	EAN code	Packaging	Multiple/boxed
Seat and cover with colour matched plastic hinge - White	FDP11WH	SCO11WH	5012158090272	Individually boxed	90/Pallet
Seat and cover with stainless steel hinge - White	FSS11SS	SCO12WH	5012158692018	Individually boxed	90/Pallet
Seat and cover with C/P brass smooth close hinge - White	FDS11CP	SCO1SWH	5024139038234	Individually boxed	90/Pallet





## THERMOPLASTIC MATERIAL

- ▶ Shatterproof
- ▶ Longlasting
- ▶ Cost Effective
- ▶ 100% recyclable



### \* INTERNATIONAL 1KG

- Lightweight white thermoplastic
- Universal shape
- Contemporary overlaying cover



### \*\* EMERALD 1.8KG

- Mediumweight white thermoplastic
- Universal shape
- Contemporary cover

The original seat that set the British Standard 1254 Type 2











### \*\*\* TANGO 1.7KG

- Mediumweight white thermoplastic
- Universal shape
- Wrap over cover



Thermoplastic material is a tough polypropylene. It is the perfect choice for a wide range of everyday applications - especially when the priority is cost effectiveness.

## THERMOPLASTIC

Product	Weight	Shape Cover	Hinge material	Hinge option	Specification	Page number
<b>NEW</b> Neon	0.9kg	Overlaying	Plastic		Entry level toilet seat	28
International	1kg	Overlaying	Plastic		Cost effective toilet seat	28
<b>NEW</b> Flamenco	1.3kg	Overlaying	Plastic or Stainless Steel		Available with Stainless Steel hinge	30
Sapphire	1.5kg	Overlaying	Pre-assembled		Cost effective toilet seat	29
Tango	1.7kg	Wrap over	Pre-assembled	  	High quality toilet seat	30
Emerald	1.8kg	Overlaying	Pre-assembled	 	The seat that set the BS1254 Type 2	27



**Soft close:** allows the seat and cover to close gently and quietly, preventing noise and trapped fingers.



**Quick release:** tool free, quick and easy removal of the toilet seat for better hygiene thanks to its ease of cleaning.



**Top fix:** fitting of the seat from the top. Required when restricted or no access (back to wall pans).



**Bottom fix:** fitting of the seat from the bottom of the pan.

EMERALD



- ▶ Long lasting and hardwearing polypropylene material.
- ▶ Supplied with pre-assembled adjustable hinges.
- ▶ **The original seat which set the British Standard - BS1254 Type 2.**
- ▶ Universal fit compatible with most modern and traditional pottery.
- ▶ **1.8kg Nominal Weight**



SINCE  
1992

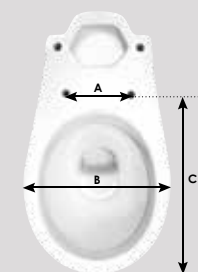

A - Hole centres: 145-175mm  
B - Width: 380mm  
C - Seat projection: 430-460mm

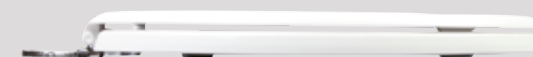

Description	Colour	Hinge	Reference	EAN code	Packaging	Multiple/boxed
Seat and cover with colour matched plastic hinge	White	Pre-assembled	SEM11WH	5017134106527	Individually boxed	100/Pallet
	Black	Pre-assembled	SEM11BL	5017134106428	Individually boxed	100/Pallet
Seat and cover top fix metal hinge	White	Pre-assembled	SEM18WH	5017134116212	Individually boxed	100/Pallet
	Black	Pre-assembled	SEM18BL	5017134116236	Individually boxed	100/Pallet



Matching Plastic hinge



Topfix chrome plated hinge

**NEON**



- ▶ New cost effective lightweight seat.
- ▶ Ideal for refurbishment.
- ▶ Fixed plastic hinge.
- ▶ Contemporary overlaying cover.
- ▶ Nominal Weight: **0.9 kg**



**NEW**

Description	Hinge	Reference	EAN code	Packaging	Multiple/boxed
Seat and cover with plastic hinge - White	214841	SON11WH	501713412014	Individually boxed	90/Pallet
Seat and cover with plastic hinge - Pack of 10 - White	214841	SNP21WH	5017134117208	Pack of 10	90/Pallet

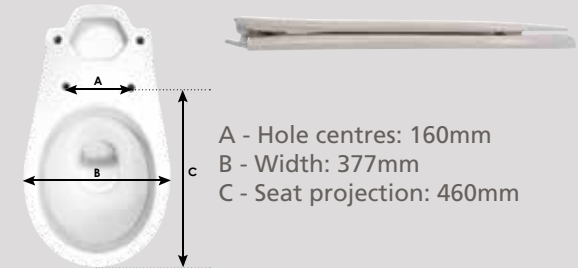

**INTERNATIONAL**



- ▶ Long lasting and hardwearing polypropylene material.
- ▶ Supplied with adjustable colour match plastic hinges.
- ▶ Designed to fit modern sanitaryware.
- ▶ 4 seat buffers and 2 cover buffers for comfort and stability.
- ▶ Aesthetically pleasing narrow design for contemporary pottery.
- ▶ Lightweight cost effective option.
- ▶ Nominal Weight: **1 kg**



Description	Colour	Hinge	Reference	EAN code	Packaging	Multiple/boxed
Seat and cover with colour matched plastic hinge	White	PP121	SNL11WH	5017134116649	Individually boxed	100/Pallet
	Black	PP121BL	SNL11BL	5024139038272	Individually boxed	100/Pallet

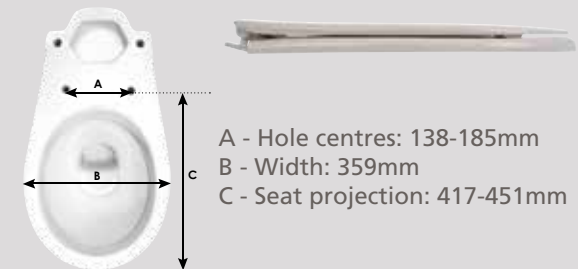

SAPPHIRE



- ▶ Long lasting and hardwearing polypropylene material.
- ▶ Supplied with pre-assembled adjustable plastic hinges.
- ▶ Quick Release hinge function for easy cleaning.
- ▶ Available in a range of colours with matching colour plastic hinges.
- ▶ Overlaying cover with dished design.
- ▶ Nominal Weight: **1.5 kg**

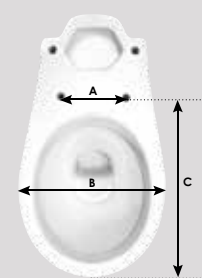

A - Hole centres: 134-178mm  
 B - Width: 376mm  
 C - Seat projection: 441-457mm



Description	Colour	Hinge	Reference	EAN code	Packaging	Multiple/boxed
Seat and cover with colour matched plastic hinge	White	Pre-assembled	SSP11WH	5017134106763	Individually boxed	100/Pallet
	Black	Pre-assembled	SSP11BL	5017134106633	Individually boxed	100/Pallet
	Champagne	Pre-assembled	SSP11CH	5017134106657	Individually boxed	100/Pallet
	Soft Cream	Pre-assembled	SSP11SC	5017134106725	Individually boxed	100/Pallet
	Whisper Grey	Pre-assembled	SSP11WG	5017134106756	Individually boxed	100/Pallet
	Blue	Pre-assembled	SSP11BU	5017134106640	Individually boxed	100/Pallet
	Turquoise	Pre-assembled	SSP11TU	5017134106732	Individually boxed	100/Pallet
	Pink	Pre-assembled	SSP11PI	5017134106718	Individually boxed	100/Pallet



SSP11BL



SSP11CH



SSP11SC



SSP11WG



SSP11TU



SSP11PI

## FLAMENCO



- ▶ Long lasting and hardwearing polypropylene material.
- ▶ Available with plastic or stainless steel hinge.
- ▶ Designed to fit modern sanitaryware.
- ▶ Nominal Weight: **1.4 kg**



140300



140306

Description	Hinge	Reference	EAN code	Packaging	Multiple/boxed
Seat and cover - white plastic hinge	140300	20120224	5017134132519	Individually boxed	90/Pallet
Seat and cover - stainless steel hinge	140306	20120225	5017134132502	Individually boxed	90/Pallet

**NEW**

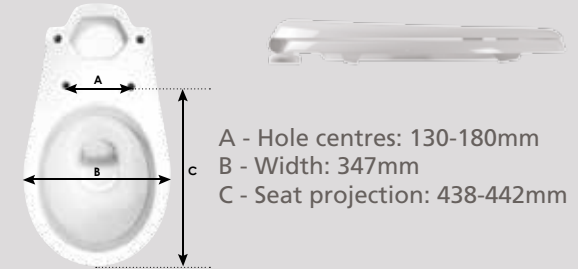

A - Hole centres: 130-180mm  
 B - Width: 347mm  
 C - Seat projection: 438-442mm

## TANGO



- ▶ Long lasting and hardwearing polypropylene material.
- ▶ Supplied pre-assembled with soft close, quick release, top fix plastic hinge.
- ▶ Attractive and stylish domed wrap-over cover design.
- ▶ Nominal Weight: **1.7 kg**

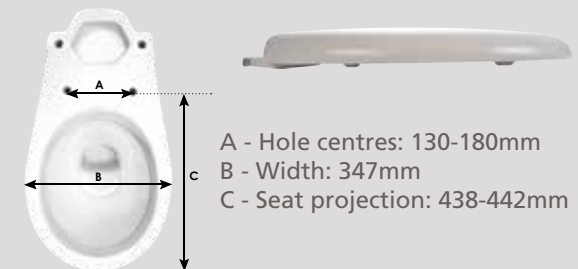

A - Hole centres: 130-180mm  
 B - Width: 347mm  
 C - Seat projection: 438-442mm

Description	Hinge	Reference	EAN code	Packaging	Multiple/boxed
Seat and cover with plastic soft close hinge - White	Pre-assembled	STG11WH	5012158689681	Individually boxed	72/Pallet



**MOULDWOOD MATERIAL**Guarantee  
**2**  
years

- ▶ Heavyweight
- ▶ High gloss paint finish
- ▶ Cost Effective

**\* WOODY/PARAMOUNT 2.5KG**

- Entry level Mouldwood toilet seat
- Plastic hinge - universal shape
- Successfully tested for 20,000 open/close cycles

**\*\* WOODY 2.5KG**

- Universal shape
- Stainless steel hinges - unique to the market
- Successfully tested for 20,000 open/close cycles





**\*\*\* WOODY LUX 2.8KG**

- High strength compressed wood with a white high gloss finish
- Soft close hinges
- Universal shape
- Successfully tested for 20,000 open/close cycles





Mouldwood is THE consumers choice. Its weight and shiny finish makes it an attractive key seat.

## MOULDWOOD

Guarantee  
**2** 

Product	Weight	Hinge material	Hinge option	Specification	Page number
Woody Paramount	2.5 kg	Plastic		Cost effective mouldwood option	33
Woody Stainless Steel	2.5 kg	Stainless Steel		Unique stainless steel hinges	33
Woody Lux	2.6 kg	Stainless Steel		Luxurious soft close hinges	33
Cavalcade	2.6 kg	Chrome Plated		Bar hinge. Ideal for traditional pans	34
Diplomat	3.4 kg	Stainless Steel		Bevelled shape with soft close hinges	34

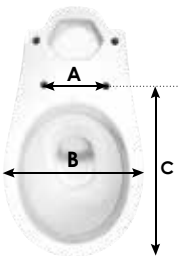

MOULDWOOD TOILET SEATS			
			
NAMES	<b>WOODY PARAMOUNT</b>	<b>WOODY</b>	<b>WOODY LUX</b>
REFERENCE	21230001	21230004	20719569
CODE EAN13	3375539049736	3375537127320	3375537194971
PACKAGING	Individually boxed	Individually boxed	Individually boxed
MULTIPLE / BOXED	1/5/80	1/4/64	1/4/64
WEIGHT	2.7 kg	2.5 kg	2.8 kg
COLOUR	White	White	White
DESCRIPTION	Seat & cover with plastic hinge - White	Seat & cover with <b>stainless steel</b> hinge	Seat & cover with <b>soft close stainless steel</b> hinge
FEATURES	<ul style="list-style-type: none"> <li>▶ Adjustable plastic hinges.</li> <li>▶ Longlasting.</li> <li>▶ Compressed wood.</li> <li>▶ Universal fitting.</li> </ul>	<ul style="list-style-type: none"> <li>▶ High gloss finish.</li> <li>▶ Adjustable stainless steel hinges.</li> <li>▶ Universal fitting.</li> <li>▶ Seat made of mouldwood.</li> </ul>	<ul style="list-style-type: none"> <li>▶ Glossy paint finish.</li> <li>▶ Adjustable stainless steel soft close hinges.</li> <li>▶ Universal fitting.</li> <li>▶ Seat made of high-strength compressed wood</li> </ul>
DESCRIPTION	 <p>A - Hole centres: 130-164mm B - Width: 375mm C - Seat projection: 425-440mm</p>	 <p>A - Hole centres: 140-175mm B - Width: 376mm C - Seat projection: 400mm</p>	 <p>A - Hole centres: 123-175mm B - Width: 370mm C - Seat projection: 418-431mm</p>

## CAVALCADE

Guarantee **2** years

- ▶ Manufactured from Mouldwood material with a high gloss finish.
- ▶ High quality chrome plated brass 'bar' hinge.
- ▶ Universal fitting.
- ▶ 4 buffers for additional stability.
- ▶ Nominal Weight **2.6 kg**



Description	Hinge	Reference	EAN code	Packaging	Multiple/boxed
Seat and cover with C/P brass hinge - White	Pre-assembled	SCL11WH	5024139031853	Individually boxed	1/5/80

## DIPLOMAT

Guarantee **2** years

- ▶ Contemporary design.
- ▶ High quality finish: polished acrylic paint.
- ▶ Chrome plated Soft close hinges.
- ▶ Longlasting.
- ▶ Universal fitting.
- ▶ Nominal Weight: **3.4 kg**



Description	Hinge	Reference	EAN code	Packaging	Multiple/boxed
Soft close mouldwood seat with a polished acrylic finish	Pre-assembled	20719794	3375537197217	Individually boxed	1/4/64

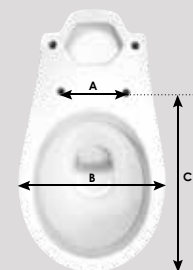

A - Hole centres: 90-185mm  
 B - Width: 360mm  
 C - Seat projection: 400-450mm

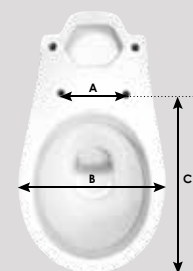

A - Hole centres: 130-177mm  
 B - Width: 370mm  
 C - Seat projection: 430-435mm

## SPECIAL NEEDS



Product	Weight	Seat only option	Specification	Page number
Commode	0.4kg	Yes	Supplied without hinge	37
Crescent Junior	1.3kg	Yes	Designed to fit 12" school pans	37, 38
<b>NEW</b> Family	1.5kg	Yes	Integrated child reducer	39
P72	1.5kg	Yes	Designed to fit 12" school pans	37, 38
Celeste Plus	2.3kg	Yes	Ideal for hospitals and care homes	36
Celeste Pro	2.3kg	Yes	Ideal for hospitals and care homes	36
Crescent Adult	2.7kg	Yes	Gap front designed for public toilets	37, 38

THERMOSET TOILET SEATS

THERMOPLASTIC TOILET SEATS

MOULDWOOD TOILET SEATS

SPECIAL NEEDS TOILET SEATS

DECOR TOILET SEATS

SPARES & ACCESSORIES

AVAILABLE IN BLUE & RED



NAMES	<b>CELESTE PLUS</b>	<b>CELESTE PRO</b>
REFERENCE	SCK11WY	SCI11WY
CODE EAN13	5024139036834	5024139038753
PACKAGING	Individually boxed	Individually boxed
MULTIPLE / BOXED	90/Pallet	90/Pallet
WEIGHT	2.3 kg	2.3 kg
COLOUR	White	White
DESCRIPTION	Seat and cover with C/P brass hinge	Seat and cover with C/P brass hinge
SUITABLE FOR THE ELDERLY AND PEOPLE WITH SPECIAL NEEDS	<ul style="list-style-type: none"> <li>▶ Heavyweight seat option.</li> <li>▶ Manufactured using anti-viral material, ideal for hospitals and care homes.</li> <li>▶ Sturdy chrome plated brass hinges.</li> <li>▶ Hinge reference: SF298</li> <li>▶ Ergonomically designed seat for maximum comfort.</li> <li>▶ Adjustable locating buffers which eliminate lateral movement in the seat.</li> <li>▶ Available as a seat only option or with overlaying cover.</li> <li>▶ Nominal Weight:                             <ul style="list-style-type: none"> <li>- 2.3 kg (Seat &amp; Cover).</li> <li>- 1.2 kg (Seat Only).</li> </ul> </li> </ul>	<ul style="list-style-type: none"> <li>▶ Heavyweight seat option.</li> <li>▶ Manufactured using anti-viral material, ideal for hospitals and care homes.</li> <li>▶ Sturdy, chrome plated brass hinges with Top Fixing.</li> <li>▶ Hinge reference: FCI11CP</li> <li>▶ Ergonomically designed seat for maximum comfort.</li> <li>▶ Adjustable locating buffers which eliminate lateral movement in the seat.</li> <li>▶ Available as a seat only option or with overlaying cover.</li> <li>▶ Nominal Weight:                             <ul style="list-style-type: none"> <li>- 2.3 kg (Seat &amp; Cover).</li> <li>- 1.2 kg (Seat Only).</li> </ul> </li> </ul>

Additional references	Colour	Reference	EAN code	Colour	Reference	EAN code
Anti viral seat and cover with C/P brass hinge	Innas Blue	SCK11IB	5024139037152	Innas Blue	SCI11IB	5024139038746
	Red	SCK11RE	5024139037152	Red	SCI11RE	5024139039293
Seat only	White Anti viral	SCK51WY	5024139037398	White Anti viral	SCI51WY	5024139038777
	Innas Blue Anti viral	SCK51IB	5024139039309	Innas Blue Anti viral	SCI51IB	5024139038760
	Innas Red Anti viral	SCK51RE	5024139039316	Innas Red Anti viral	SCI51RE	5024139039330

CELESTE PLUS



- 4 buffers on the seat including 2 locating buffers for more stability
- 2 buffers on the cover

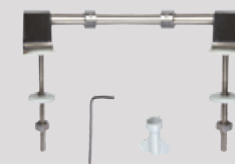

SF298

- Solid brass adjustable hinge
- Stainless steel fittings



A - Hole centres: 150-160mm  
 B - Width: 370mm  
 C - Seat projection: 375mm

CELESTE PRO



- 4 buffers on the seat including 2 locating buffers for more stability
- 2 buffers on the cover
- Increased height (15mm)



FCI11CP

- Solid brass adjustable hinge
- Stainless steel fittings



A - Hole centres: 150-160mm  
 B - Width: 370mm  
 C - Seat projection: 430-445mm

## FAMILY

Guarantee  
**2**  
years

- ▶ Soft close. No more trapped fingers.
- ▶ Integral child seat with magnetic closure.
- ▶ Successfully tested for 10 000 open and close cycles.
- ▶ Nominal Weight: **1.5 kg**

Description	Hinge	Reference	EAN code	Packaging	Multiple/boxed
Soft close toilet seat with integrated child reducer	Pre-assembled	20719572	3375537195008	Individually boxed	1/5/80



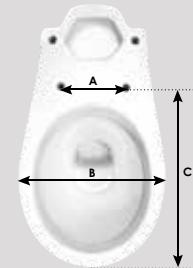

NEW



A - Hole centres: 138-185mm  
 B - Width: 385mm  
 C - Seat projection: 430-440mm



			
<p><b>NAMES</b></p> <p><b>CRESCENT JUNIOR</b></p>	<p><b>NAMES</b></p> <p><b>CRESCENT ADULT</b></p>	<p><b>NAMES</b></p> <p><b>P72 MINI</b></p>	<p><b>NAMES</b></p> <p><b>COMMODE</b></p>
<p><b>REFERENCE</b></p> <p>SCJ51WH</p>	<p><b>REFERENCE</b></p> <p>SCR12WH</p>	<p><b>REFERENCE</b></p> <p>SMP11WH</p>	<p><b>REFERENCE</b></p> <p>SCM60BL</p>
<p><b>CODE EAN13</b></p> <p>5012158691820</p>	<p><b>CODE EAN13</b></p> <p>5012158669034</p>	<p><b>CODE EAN13</b></p> <p>5012158663773</p>	<p><b>CODE EAN13</b></p> <p>5017134106381</p>
<p><b>PACKAGING</b></p> <p>Individually boxed</p>	<p><b>PACKAGING</b></p> <p>Individually boxed</p>	<p><b>PACKAGING</b></p> <p>Individually boxed</p>	<p><b>PACKAGING</b></p> <p>Individually boxed</p>
<p><b>MULTIPLE / BOXED</b></p> <p>90/Pallet</p>	<p><b>MULTIPLE / BOXED</b></p> <p>90/Pallet</p>	<p><b>MULTIPLE / BOXED</b></p> <p>90/Pallet</p>	<p><b>MULTIPLE / BOXED</b></p> <p>100/Pallet</p>
<p><b>WEIGHT</b></p> <p>1.3 kg</p>	<p><b>WEIGHT</b></p> <p>2.7 kg</p>	<p><b>WEIGHT</b></p> <p>1.5 kg</p>	<p><b>WEIGHT</b></p> <p>0.4 kg</p>
<p><b>COLOUR</b></p> <p>White</p>	<p><b>COLOUR</b></p> <p>White</p>	<p><b>COLOUR</b></p> <p>White</p>	<p><b>COLOUR</b></p> <p>Black</p>
<p><b>DESCRIPTION</b></p> <p>Seat only with gap front seat</p>	<p><b>DESCRIPTION</b></p> <p>Seat and cover with gap front seat</p>	<p><b>DESCRIPTION</b></p> <p>Seat and cover for 12" school pans</p>	<p><b>DESCRIPTION</b></p> <p>No hinge</p>
<p> <b>MADE IN THE UK</b></p> <p> <ul style="list-style-type: none"> <li>▶ Designed to fit 12" school pans.</li> <li>▶ Gap front design ideal for school.</li> <li>▶ Anti-viral/bacterial option.</li> <li>▶ Rigid &amp; stable.</li> <li>▶ Chemical, flame and scratch resistant.</li> <li>▶ Suitable for high traffic areas.</li> <li>▶ Nominal Weight: 1.3 Kg</li> </ul> </p> <p>           A - Hole centres: 130-180mm            B - Width: 305mm            C - Seat projection: 385mm         </p> 	<p> <ul style="list-style-type: none"> <li>▶ Heavyweight seat option.</li> <li>▶ Plastic or stainless steel hinge options.</li> <li>▶ Gap front design ideal for public toilets.</li> <li>▶ Anti-viral option, ideal for hospitals and care homes.</li> <li>▶ 4 buffers for extra stability.</li> <li>▶ Very strong and durable.</li> <li>▶ Chemical, flame and scratch resistant.</li> <li>▶ Available as a seat only option or with overlaying cover.</li> <li>▶ Universal fitting.</li> <li>▶ Nominal Weight:               <ul style="list-style-type: none"> <li>- 2.7 kg (Seat &amp; Cover).</li> <li>- 1.55 kg (Seat Only).</li> </ul> </li> </ul> </p> <p>           A - Hole centres: 134-184mm            B - Width: 387mm            C - Seat projection: 424-440mm         </p>	<p> <ul style="list-style-type: none"> <li>▶ Designed to fit 12" school pans.</li> <li>▶ Anti-viral/bacterial option.</li> <li>▶ Rigid &amp; stable.</li> <li>▶ Chemical, flame, and scratch resistant.</li> <li>▶ Suitable for high traffic areas.</li> <li>▶ Other hinge options available for this model</li> <li>▶ Nominal Weight: 1.5 kg</li> </ul> </p> <p>           A - Hole centres: 127-152mm            B - Width: 350mm            C - Seat projection: 391mm         </p>	<p> <ul style="list-style-type: none"> <li>▶ Easy to clean.</li> <li>▶ Cost effective.</li> </ul> </p> <p>           A - Hole centres: 130-180mm            B - Width: 347mm            C - Seat projection: 390-405mm         </p>

## CRESCENT JUNIOR



Description	Colour	Hinge	Reference	EAN code	Packaging	Multiple/boxed
Seat only with colour matched plastic hinge	White	FDP11WH	SCJ51WH	5012158691820	Individually boxed	90/Pallet
Seat only with colour matched plastic hinge	Black	FDP11BL	SCJ51BL	5012158661922	Individually boxed	90/Pallet
Seat only with stainless steel hinge	White	FSS13SS	SCJ53WH	5012158669102	Individually boxed	90/Pallet
Seat only with stainless steel hinge	Black	FSS13SS	SCJ53BL	5012158669089	Individually boxed	90/Pallet
Seat only with stainless steel hinge	Red	FSS13SS	SCJ53RE	5012158688431	Individually boxed	90/Pallet
Anti viral seat only with stainless steel hinge	White	FSS13SS	SCJ53WY	5012158689643	Individually boxed	90/Pallet

## P72 MINI



Description	Colour	Hinge	Reference	EAN code	Packaging	Multiple/boxed
Seat and cover with colour matched plastic hinge	White	FDP11WH	SMP11WH	5012158663773	Individually boxed	90/Pallet
Seat & cover with stainless steel hinge	White	FCS11SS	SMP14WH	5012158671310	Individually boxed	90/Pallet
	Anti Viral White	FCS11SS	SMP14WY	5024139035851	Individually boxed	90/Pallet
Seat only	Anti Viral White	FCS11SS	SMP54WY	5024139035868	Individually boxed	90/Pallet

## CRESCENT ADULT



Description	Colour	Hinge	Reference	EAN code	Packaging	Multiple/boxed
Seat and cover with stainless steel hinge	White	FSS11SS	SCR12WH	5012158669034	Individually boxed	90/Pallet
Seat and cover with stainless steel hinge	Black	FSS11SS	SCR12BL	5012158668990	Individually boxed	90/Pallet
Seat only with colour matched plastic hinge	White	FDP11WH	SCR51WH	5012158650988	Individually boxed	90/Pallet
Seat only with colour matched plastic hinge	Black	FDP11BL	SCR51BL	5012158655846	Individually boxed	90/Pallet
Seat only with stainless steel hinge	White	FSS13SS	SCR53WH	5012158669041	Individually boxed	90/Pallet
Seat only with stainless steel hinge	Black	FSS13SS	SCR53BL	5012158669003	Individually boxed	90/Pallet
Anti viral seat and cover with stainless steel hinge	Anti Viral White	FD211SS	SCR1QWY	5024139035820	Individually boxed	90/Pallet
Anti viral seat only with stainless steel hinge	Anti Viral White	FD211SS	SCR5QWY	5024139035813	Individually boxed	90/Pallet

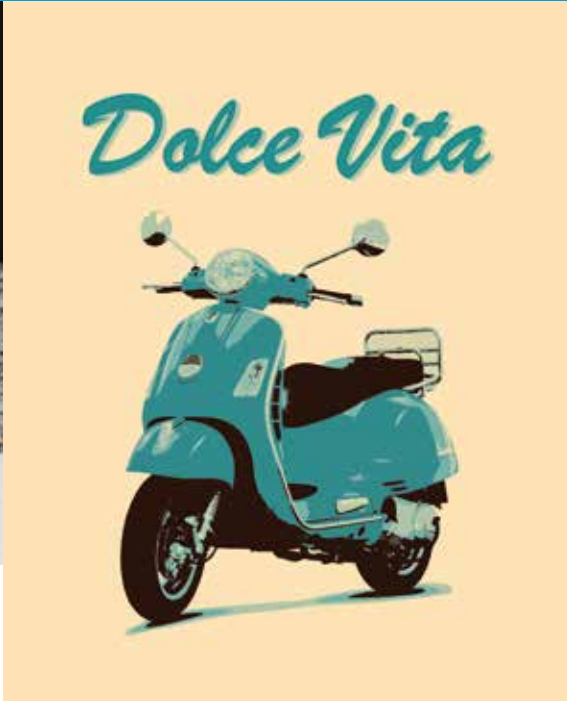

Ask for your personalised quotation at:  
[sales@wirquin.co.uk](mailto:sales@wirquin.co.uk)  
 or call 0044 333 222 4488

DESIGN YOUR OWN EXCLUSIVE SEAT

MADE IN THE UK



- ▶ Exclusive design service
- ▶ Low MOQ : 300
- ▶ Available within 12 to 14 weeks from artwork approval
- ▶ High quality thermoset toilet seat with soft close option available



Code	Hinge description	Hinge characteristics						Hinge functions				Thermoset														
		Plastic	Stainless steel	Chrome plated	Fixed	Cranked	Adjustable	Bottom fix	Top Fix	Quick Release	Soft Close	Calypso	Concerto	Fusion	Lyric	Maestro	Magnum	Melody	Neptune	Saxon	Sonata	Svelt	Tamar	Disco	VIP	
214841	White plastic bottom fixing	x			x			x																		
FDP11BL	Black plastic hinge bottom fixing	x					x	x			x									x	x			x		
FDP11WH	White plastic bottom fixing	x					x	x			x			x				x	x	x				x		
FDR11WH	White plastic bottom fixing	x					x	x								x	x									
PP121	White plastic bottom fixing	x						x																		
PP121BL	Black plastic bottom fixing	x						x																		
FMASTSS	3045 stainless steel TF QR & SC		x				x		x	x	x				x											
FSP15SS	3045 stainless steel TF QR & SC		x				x		x	x	x															x
FSXSTSS	304 stainless steel TF QR & SC		x				x		x	x	x			x												
FBH11SS	304 stainless steel Top fixing		x				x		x															x		
FCS11SS	304 Stainless steel bottom fixing		x			x			x																x	
FD211SS	304 Stainless steel bottom fixing		x				x	x																x		
FDR11SS	304 Stainless steel bottom fixing		x				x	x						x	x	x										
FMN11SS	304 Stainless steel bottom fixing		x				x	x						x												x
FOR12SS	304 stainless steel Top fixing		x				x		x																	x
FSS11SS	304 Stainless steel bottom fixing		x				x	x					x							x	x					
FSS13SS	304 Stainless steel bottom fixing		x				x	x												x						
SF520	304 stainless steel Top fixing		x				x		x						x											
FDP11SS	304 Stainless steel bottom fixing		x					x																		
FDS11CP	Chrome plated bottom fixing			x				x		x		x														
FCI11CP	Chrome plated bottom fixing			x				x																		
SF298	Chrome plated bottom fixing			x				x																		
Pre assembled on seat Not available as spare																									x	x

THERMOSET  
TOILET SEATSTHERMOPLASTIC  
TOILET SEATSMOULDWOOD  
TOILET SEATSSPECIAL NEEDS  
TOILET SEATSDECOR  
TOILET SEATS

## SPARES &amp; ACCESSORIES

Code	Hinge description	Hinge characteristics						Hinge functions			Thermoplastic						Special needs				Mouldwood							
		Plastic	Stainless steel	Chrome plated	Fixed	Cranked	Adjustable	Bottom fix	Top Fix	Quick Release	Soft Close	Emerald	Flamenco	International	Neon	Sapphire	Tango	Celeste Plus	Celeste Pro	Crescent Adult	Crescent Junior	Family	P72	Cavalcade	Diplomat	Woody Paramount	Woody	Woody Lux
214841	White plastic bottom fixing	x		x			x							x														
FDP11BL	Black plastic hinge bottom fixing	x				x	x																					
FDP11WH	White plastic bottom fixing	x				x	x											x	x			x						
FDR11WH	White plastic bottom fixing	x				x	x				x																	
PP121	White plastic bottom fixing	x					x					x																
PP121BL	Black plastic bottom fixing	x					x					x																
FMASTSS	3045 stainless steel TF QR & SC		x			x		x	x	x																		
FSP1SSS	3045 stainless steel TF QR & SC		x			x		x	x	x																		
FSXSTSS	304 stainless steel TF QR & SC		x			x		x	x	x																		
FBH11SS	304 stainless steel Top fixing		x			x		x																				
FCS11SS	304 Stainless steel bottom fixing		x			x		x																				
FD211SS	304 Stainless steel bottom fixing		x			x	x												x									
FDR11SS	304 Stainless steel bottom fixing		x			x	x				x																	
FMN11SS	304 Stainless steel bottom fixing		x			x	x																					
FOR12SS	304 stainless steel Top fixing		x			x		x																				
FSS11SS	304 Stainless steel bottom fixing		x			x	x												x			x						
FSS13SS	304 Stainless steel bottom fixing		x			x	x												x	x								
SF520	304 stainless steel Top fixing		x			x		x																				
FDP11SS	304 Stainless steel bottom fixing		x				x													x								
FDS11CP	Chrome plated bottom fixing			x			x		x																			
FCI11CP	Chrome plated bottom fixing			x			x											x										
SF298	Chrome plated bottom fixing			x			x										x											
Pre assembled on seat Not available as spare											x			x	x								x	x	x	x	x	

# FLUSHING

FLUSH VALVES

SIPHONS

INLET VALVES

CONCEALED CISTERNS

EXPOSED CISTERNS

URINAL FLUSHING

SPARES AND ACCESSORIES

**Macdee**  
*wirquin*



# The NEW Revolution in the Flushing World



## Quick Fit

Thanks to its patented system, Quick Fit attaches directly over existing close coupled installations without removing the cistern.

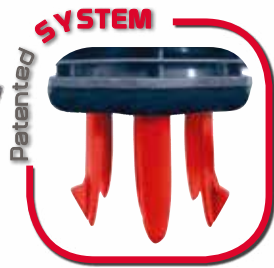

DUAL FLUSH CABLE OPERATED FLUSH VALVE

Guarantee  
**10**  
years

QUICK FIT

DUAL  
FLUSH



EASYCLIP SYSTEM

Quick assembly and servicing



CHROME BUTTON

Suitable for lid holes from Ø14 to Ø58mm



TELESCOPIC  
OVERFLOW

Height adjustable

BUTYL SEAL

Instant seal



QUICK FIT DUAL  
FLUSH VALVE



DESCRIPTION	2" dual flush mechanism
REFERENCE	10721505
EAN CODE	3375537214341
PACKAGING	Boxed
BOXED QUANTITY	1 / 12
HEIGHT OF CISTERNS (mm)	270 TO 440 mm
DIAMETER OF COVER HOLE	14 to 58 mm
CONTROL SYSTEM	Cable control
MAIN CHARACTERISTICS	<ul style="list-style-type: none"> <li>▶ Time saving: no need to remove the cistern to change the flush valve.</li> <li>▶ Innovative seal: Butyl seal ensures a perfect secure fit instantly.</li> <li>▶ Suitable for close coupled cisterns only.</li> </ul>
TECHNICAL DRAWING	

# FLUSH VALVES

## JOLLYFLUSH DUAL FLUSH

Extensive array of flush valves to suit all cistern types, perfect for both new build and retro-fit. The flush mechanism is easy to install with its flexible cable makes it suitable for even the slimmest cisterns.

Dual flush offers water saving with full and half flush options to save water and money. WRAS approved and tested to over 200,000 cycles.



## JOLLYFLUSH SINGLE FLUSH







Easy to use single push button, simple full flush everytime



## JOLLYFLUSH DOC M

Single flush mechanism with raised button. Suitable for people with limited dexterity.

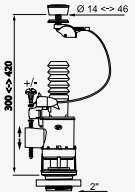
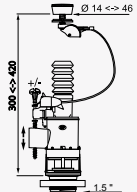
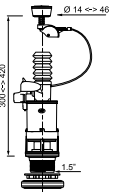
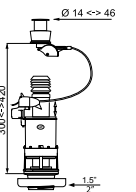
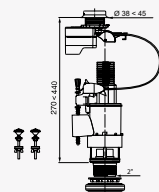
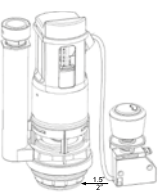

	JOLLYFLUSH TOP OR FRONT DUAL FLUSH VALVES				TOP OR FRONT SINGLE FLUSH VALVES		JOLLYTRONIC	KAYLA CABLE OPERATED DUAL FLUSH OUTLET VALVE
								
DESCRIPTION	2" dual flush mechanism		1 1/2" dual flush mechanism		1 1/2" flush mechanism	2" & 1 1/2" DOC M flush mechanism EASY FLUSH	2" no touch flushing valve	2" to 1 1/2" flushing valve front or top flush
REFERENCE	10120209	14010401	10120210	14000001	12000001	12050002	10120021	DVA0100
EAN CODE	5017134132304	3375537139736	5017134132311	3375539046421	3375536037385	3375537160860	5017134129168	5017134115376
PACKAGING	Boxed	Bag	Boxed	Bag	Bag	Bag	Boxed	Boxed
MULTIPLE / BOXED QUANTITY	8 / 240	1 / 30	8 / 240	1 / 35	1 / 36	1 / 15	1 / 100	N/A
HEIGHT OF CISTERNS (mm)	300 to 420		300 to 420		300 to 420	300 to 420	300 to 420	300 to 420
FLUSH RATE L/sec	2.2 WRAS: 1.85		1.9 WRAS: 1.85		1.9 WRAS: 1.85	1.9 WRAS: 1.85 (1 1/2") 2.2 WRAS: 1.85 (2")	2.2 WRAS: 1.85	1.9 WRAS: 1.85 (1 1/2") 2.2 WRAS: 1.85 (2")
DIAMETER OF COVER HOLE	14 to 46 mm		14 to 46 mm		14 to 46 mm	14 to 46 mm	38 to 45 mm	16 to 38 mm
MECHANISM BASE (INCHES)	2"		1.5"		1.5"	2" & 1.5"	2"	2" & 1.5"
WATER SAVING	DUAL FLUSH		DUAL FLUSH		SINGLE FLUSH	SINGLE FLUSH	ECO FLUSH	DUAL FLUSH
CONTROL SYSTEM	CABLE CONTROL		CABLE CONTROL		CABLE CONTROL	CABLE CONTROL	CABLE CONTROL	CABLE CONTROL
TOP OR FRONT MECHANISM	TOP OR FRONT		TOP OR FRONT		TOP OR FRONT	TOP OR FRONT	TOP OR FRONT	TOP OR FRONT
MAIN CHARACTERISTICS	Adjustable overflow (240 to 270mm).		Adjustable overflow (240 to 270mm).		Adjustable overflow (240 to 270mm).	Ideal for people with limited mobility. Raised button for easy flush. Adjustable overflow (240 to 270mm).	Battery operated no touch infrared flushing valve	Multi full and part flush settings, adjustable overflow (190-330mm)
TECHNICAL DRAWING								





**KAYLA PNEUMATIC DUAL FLUSH OUTLET VALVES**

- ▶ Water saving dual flushing valve
- ▶ Adjustable Full and part flush volume settings
- ▶ Adjustable internal overflow, making it ideal for both new and retrofit installations
- ▶ Removable top for easy cleaning and replacement
- ▶ Flushpipe stops on the base for correct installation
- ▶ Easy clean seal for quick maintenance
- ▶ Suitable for use with our Pneu-Compact Cisterns
- ▶ WRAS approved





**KAYLA PNEUMATIC SINGLE FLUSH OUTLET VALVES**



DESCRIPTION	1 1/2" dual flush valve complete with Kara 72mm chrome dual flush push button	2" dual flush valve complete with Kara 72mm chrome dual flush push button	1 1/2" dual flush valve complete with Kara 50mm chrome dual flush push button	2" dual flush valve only No button	1 1/2" dual flush valve only No button	1 1/2" single flush valve complete with Kara 72mm single flush chrome low profile push button	2" single flush valve complete with Kara 72mm single flush chrome low profile push button	1 1/2" single flush valve only No button
REFERENCE	DVA0400	DVA0500	DVA0410	DVA5200	DVA5150	DVA0401	DVA0501	DVA5350
EAN CODE	5017134119176	5017134116472	5017134119190	5017134119459	5017134120028	5017134119190	5017134119206	5017134120462
PACKAGING	Bag	Bag	Bag	Bag	Bag	Bag	Bag	Bag
FLUSH RATE L/sec	2.1	2.1	2.1	2.1	2.1	2.1	2.1	2.1
MECHANISM BASE INCHES	1.5"	2"	1.5"	2"	1.5"	1.5"	2"	1.5"
WATER SAVING	Dual Flush	Dual Flush	Dual Flush	Dual Flush	Dual Flush	Single Flush	Single Flush	Single Flush
BUTTON DESIGN	 SYG610CP	 SYG610CP	 SYG611CP	See page 60 for buttons	See page 60 for buttons	 SYG608CP	 SYG608CP	See page 60 for buttons

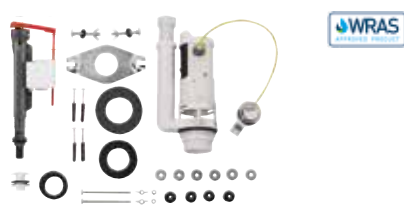
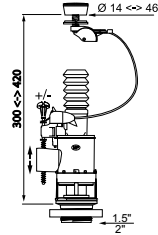
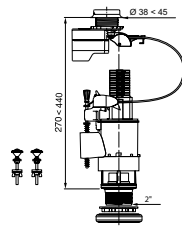
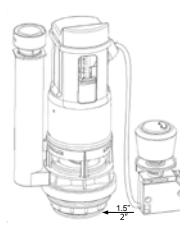

# FLUSH VALVES KITS

	JOLLYFLUSH TOP OR FRONT ACCESS DUAL FLUSH VALVES		JOLLYTRONIC KIT	KAYLA CABLE OPERATED DUAL FLUSH OUTLET VALVE
				
DESCRIPTION	1 1/2" & 2" dual flush mechanism + Jollyfill telescopic adjustable inlet valve		2" No touch bottom entry flushing mechanism + Jollyfill telescopic adjustable inlet valve	1 1/2" & 2" Universal bottom entry cistern fitting pack
REFERENCE	10120208	14010402	10120022	AV068
EAN CODE	5017134132298	3375537159475	5017134129175	5017134119169
PACKAGING	Boxed	Bag	Boxed	Boxed
MULTIPLE / BOXED QUANTITY	6 / 120	1 / 10	1 / 100	N/A
HEIGHT OF CISTERNS (mm)	300 to 420		300 to 420	300 to 420
FLUSH RATE L/sec	1.9 WRAS: 1.85 (1 1/2") 2.2 WRAS: 1.85 (2")		2.2 WRAS: 1.85	1.9 WRAS: 1.85 (1 1/2") 2.2 WRAS: 1.85 (2")
DIAMETER OF COVER HOLE	14 to 46 mm		38 to 45 mm	16 to 38 mm
MECHANISM BASE (INCHES)	2" & 1.5"		2"	2" & 1.5"
WATER SAVING	DUAL FLUSH		ECO STOP	DUAL FLUSH
CONTROL SYSTEM	CABLE CONTROL		CABLE CONTROL	CABLE CONTROL
TOP OR FRONT MECHANISM	TOP OR FRONT		TOP OR FRONT	TOP OR FRONT
MAIN CHARACTERISTICS	UNIVERSAL FLUSH KIT Complete replacement kit for 99% of bottom entry close coupled cisterns. Extendable overflow (240 to 270mm). Adjustable JOLLYFILL telescopic, delayed action, space saving, inlet valve.		Advanced no touch eco flushing kit that operates via a no touch infrared signal. Adjustable JOLLYFILL telescopic, delayed action, inlet valve.	Universal flush kit. Complete replacement kit for 99% of bottom entry close coupled cisterns. Extendable overflow and multi full and part flush settings. Adjustable JOLLYFILL telescopic, delayed action, space saving, inlet valve.
TECHNICAL DRAWING				

## SIPHONS

### MACDEE MOTION

- ▶ Unique all-in-one universal dual flush siphon
- ▶ Most compact siphon on the market
- ▶ Widest range of height options on the market
- ▶ Fastest flush rate on the market
- ▶ Adjustable flush volumes

Guarantee  
**10**  
years







Description	Reference	EAN code	Packaging	Multiple/boxed
Siphon only	10120045	5017134129820	Box	8/240
Universal Kit	10120046	5017134129823	Box	6/120

### MACDEE MOTION



- ▶ 27 x Macdee Motion Siphons
- ▶ Delivered pre-assembled, fitted and dispatched with protective sleeve
- ▶ Order code: 10120073

METRO RAPID - SINGLE FLUSH			OBLONG	ROUND	SQUARE	D-SHAPE
3 PIECE SIPHON PACKAGING: BAG MULTIPLE/BOXED QUANTITY: 01/10 CONTROL SYSTEM: LEVER						
HEIGHT	C-LINK					
7.5"	2 1/4"	REFERENCE	DSY8725	DSY7125	DSY7925	DSD7125
		EAN CODE	5017134105209	5017134105025	5017134105124	5017134104622
8"	2 1/4"	REFERENCE	DSY8825	DSY7225	DSY8025	DSD8225
		EAN CODE	5017134105216	5017134105032	5017134105131	5017134104639
8.5"	2 1/4"	REFERENCE	DSY8875	DSY7275	-	-
		EAN CODE	5017134119589	5017134115154	-	-
9"	2 1/4"	REFERENCE	DSY8925	DSY7325	DSY8125	DSD9325
		EAN CODE	5017134105223	5017134105049	5017134105148	5017134104646
9.5"	2 1/4"	REFERENCE	DSY9025	DSY7425	DSY8225	DSD9425
		EAN CODE	5017134105230	5017134105056	5017134105155	5017134104653
10"	4 3/8"	REFERENCE	DSY9138	-	-	DSD1538
		EAN CODE	5017134105247	-	-	5017134104592
10.5"	4 3/8"	REFERENCE	DSY9238	-	-	DSD1638
		EAN CODE	5017134105254	-	-	5017134104608
NOTE: For internal overflow measure from the base of the cistern to the waterline and add 1", ensuring that the measurement is a minimum of 10mm below any aperture in the cistern to decide what height siphon is required for the installation.			<ul style="list-style-type: none"> <li>▶ Ideal for use in standard size cisterns</li> <li>▶ Metro Rapid has an easy to remove upper section allowing easy maintenance / replacement without the need to remove the cistern</li> <li>▶ Flush volumes can be varied between 6/7/9 litres making it suitable for replacement installations</li> <li>▶ All siphons come complete with siphon backnut, coupling nut, sealing washer and low level flush pipe seal as standard</li> <li>▶ Complete with internal overflow</li> <li>▶ WRAS approved</li> </ul>	<ul style="list-style-type: none"> <li>▶ Ideal for use with compact narrow cisterns where space may be an issue</li> <li>▶ Metro Rapid has an easy to remove upper section allowing easy maintenance / replacement without the need to remove the cistern</li> <li>▶ All siphons supplied complete with siphon backnut, coupling nut, sealing washer and low level flush pipe seal as standard</li> <li>▶ Complete with internal overflow</li> <li>▶ WRAS approved</li> </ul>	<ul style="list-style-type: none"> <li>▶ Square shaped siphon is ideal for installation in narrow yet deep cisterns</li> <li>▶ Metro Rapid has an easy to remove upper section allowing easy maintenance / replacement without the need to remove the cistern</li> <li>▶ All siphons come complete with siphon backnut, coupling nut, sealing washer and low level flush pipe seal as standard</li> <li>▶ Complete with internal overflow</li> <li>▶ WRAS approved</li> </ul>	<ul style="list-style-type: none"> <li>▶ Well suited for installation in slimline cisterns</li> <li>▶ Metro Rapid has an easy to remove upper section allowing easy maintenance / replacement without the need to remove the cistern</li> <li>▶ All siphons come complete with siphon backnut, coupling nut, sealing washer and low level flush pipe seal as standard</li> <li>▶ Complete with internal overflow</li> <li>▶ WRAS approved</li> </ul>

**METRO SINGLE FLUSH**

- ▶ The Metro range is a well established siphon offering a high level of reliability
- ▶ On the Metro, flush volume can be varied between 6/7/9 litres, making it suitable for replacement installations
- ▶ All siphons come complete with siphon backnut, coupling nut, sealing washer and low level flush pipe seal as standard
- ▶ Complete with internal overflow
- ▶ WRAS approved



**DUAL FLUSH**



DESCRIPTION	7 1/2" one piece siphon complete with 2 1/4 metal c-link and low level flushpipe seal	8" one piece siphon complete with 2 1/4 metal c-link and low level flushpipe seal	8 1/2" one piece siphon complete with 2 3/4 metal c-link and low level flushpipe seal	9" one piece siphon complete with 2 1/4 metal c-link and low level flushpipe seal	9 1/2" one piece siphon complete with 2 1/4 metal c-link and low level flushpipe seal	10" one piece siphon complete with 4 3/8 metal c-link and low level flushpipe seal
REFERENCE	DSY0125	DSY0225	DSY0275	DSY0325	DSY0425	DSY0538
EAN CODE	5017134104769	5017134104776	5017134120097	5017134104783	5017134104790	5017134104813
PACKAGING	Bag	Bag	Bag	Bag	Bag	Bag
MULTIPLE / BOXED QUANTITY	01/10	01/10	01/10	01/10	01/10	01/10
MECHANISM BASE INCHES	1.5	1.5	1.5	1.5	1.5	1.5
WATER SAVING	6-7-9	6-7-9	6-7-9	6-7-9	6-7-9	6-7-9
CONTROL SYSTEM	Lever	Lever	Lever	Lever	Lever	Lever

DESCRIPTION	<b>7 1/2" dual flush siphon</b>
REFERENCE	10717905
EAN CODE	3375537178643
PACKAGING	Bag
MULTIPLE / BOXED QUANTITY	01/12
FLUSH RATE L/sec	2.1
MECHANISM BASE (INCHES)	1.5
WATER SAVING	Dual Flush
CONTROL SYSTEM	Lever
MAIN CHARACTERISTICS	Water saving. Internal overflow. Ideal for use in traditional cisterns. WRAS approved.

NOTE: For internal overflow measure from the base of the cistern to the waterline and add 1", ensuring that the measurement is a minimum of 10mm below any aperture in the cistern to decide what height siphon is required for the installation.

# INLET VALVES

## INLET FLOAT VALVE







Macdee by WIRQUIN have a variety of inlet float valves to suit all cistern sizes, for either bottom entry or side entry. These high performing valves are WRAS approved and within the range there are telescopic valve options and narrow tank solutions.



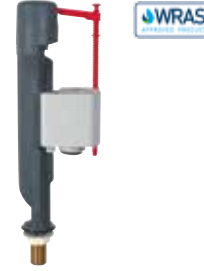

## JOLLYFILL TELESCOPIC BOTTOM ENTRY

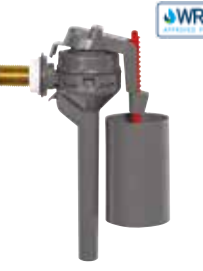

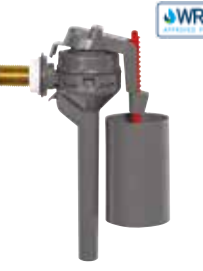
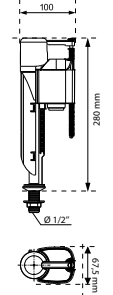
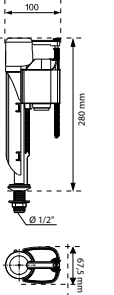
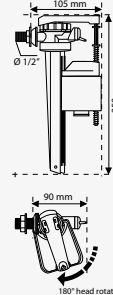
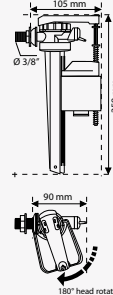
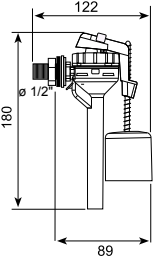
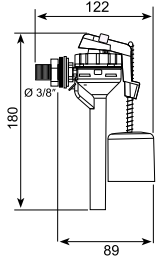

DESCRIPTION	Inlet float valve		Inlet float valve		Inlet float valve
REFERENCE	10120029	16110201	10120028	16110101	16110011
EAN CODE	501713429434	3375537150434	5017134129311	3375537151691	3375537150441
PACKAGING	Boxed	Bag	Boxed	Bag	Bag
MULTIPLE / BOXED QUANTITY	1 / 24	1 / 36	1 / 24	1 / 36	1 / 36
INLET TAIL	1/2" brass		1/2" plastic		3/8" brass
FILLING RATE AT 0,1 BAR	3.1 L/mn		3.1 L/mn		1.6 L/mn
WORKING RANGE	0.1 up to 16 bar		0.1 up to 16 bar		0.1 up to 16 bar
RESISTANT TO PEAKS OF PRESSURE	Up to 20 bars		Up to 20 bars		Up to 20 bars
WATER SAVING DELAYED ACTION	Yes		Yes		Yes
MAIN CHARACTERISTICS	Patented clutch system against over tightening. Ultra quiet (17 decibels). Anti-siphoning. Eliminates water hammer. Water saving .				
TECHNICAL DRAWING					

	JOLLYFILL BOTTOM ENTRY		JOLLYFILL SIDE ENTRY				TOPY SIDE ENTRY	
								
DESCRIPTION	9 1/2" Inlet float valve	9 1/2" Inlet float valve	Inlet float valve		Inlet float valve		Inlet float valve	Inlet float valve
REFERENCE	16100006	16100007	10120033	16300101	10120034	16300201	16300601	16300501
EAN CODE	3375537136759	3375537147724	5017134129526	3375537150151	5017134129533	3375537150410	3375537160815	3375537161140
PACKAGING	Bag	Bag	Boxed	Bag	Boxed	Bag	Bag	Bag
MULTIPLE / BOXED QUANTITY	1 / 36	1 / 36	1 / 24	1 / 36	1 / 24	1 / 36	1 / 60	1 / 72
INLET END	1/2" plastic	1/2" brass	1/2" plastic		1/2" brass		1/2" plastic	3/8" brass
FILLING RATE AT 0,1 BAR	4.1 L/mn	4.1 L/mn	3.8 L/mn		3.8 L/mn		1.5 L/mn	1.3 L/mn
WORKING RANGE	0.1 up to 16 bar	0.1 up to 16 bar	0.1 up to 16 bar		0.1 up to 16 bar		0.1 up to 16 bar	0.1 up to 16 bar
RESISTANT TO PEAKS OF PRESSURE	Up to 20 bars	Up to 20 bars	Up to 20 bars		Up to 20 bars		Up to 20 bars	Up to 20 bars
WATER SAVING DELAYED ACTION	Yes	Yes	Yes		Yes		No	No
MAIN CHARACTERISTICS	Ultra quiet (17 decibels). Anti-siphoning. Eliminates water hammer.		180° head rotation ideal for narrow tanks. Ultra quiet (17 decibels). Anti-siphoning. Eliminates water hammer.				Ultra compact.	Special for Uni Compact cistern. Ultra compact.
TECHNICAL DRAWING								

	<b>SILENTA INLET SIDE ENTRY</b>		<b>SILENTA INLET BOTTOM ENTRY</b>				
							
			<ul style="list-style-type: none"> <li>▶ BS1212: Part 3</li> <li>▶ Supplied with high and low pressure seating and backnut</li> <li>▶ Height variation: bottom entry pedestal</li> <li>▶ 8 ½" to 10" and arm length 7 ¼" to 8 ¼".</li> </ul>				
DESCRIPTION	Ball valve complete with 8 1/4" lever arm diverter high and low pressure seating and backnuts	Ball valve complete with 9 1/4" lever arm diverter high and low pressure seating and backnuts	Ball valve 8 1/2" cranked pedestal complete with 7 1/4" lever arm diverter high and low pressure seating washer and backnut	Ball valve 9 1/2" cranked pedestal complete with 7 1/4" lever arm diverter high and low pressure seating washer and backnut	Ball valve 8 1/2" cranked pedestal complete with 8 1/4" lever arm diverter high and low pressure seating washer and backnut	Ball valve 9 1/2" cranked pedestal complete with 8 1/4" lever arm diverter high and low pressure seating washer and backnut	Ball valve 10" cranked pedestal complete with 8 1/4" lever arm diverter high and low pressure seating washer and backnut
REFERENCE	DVS1082	DVS1092	DVS3872	DVS3972	DVS3882	DVS3982	DVS3182
EAN CODE	5017134105452	5017134105469	5017134105520	5017134105551	5017134105537	5017134105568	5017134105506
PACKAGING	Bag	Bag	Bag	Bag	Bag	Bag	Bag
MULTIPLE / BOXED QUANTITY	01/75	01/75	01/50	01/50	01/50	01/50	01/50
INLET END	1/2" plastic	1/2" Plastic	1/2" plastic	1/2" plastic	1/2" plastic	1/2" plastic	1/2" plastic
FILLING RATE AT 0,1 BAR	1.5L/min	1.5L/min	1.5L/min	1.5L/min	1.5 L/mn	1.5L/min	1.5L/min
FUNCTIONING RANGE	0-1 to 14 bar	0-1 to 14 bar	0-1 bar to 14	0-1 bar to 14	0-1 bar to 14	0-1 bar to 14	0-1 bar to 14
MAIN CHARACTERISTICS	UK manufactured, complete with fittings, quick and easy to install.		UK manufactured, complete with fittings, quick and easy to install pedestal.				

# BALL FLOATS

SUPERFLOAT						
						
DESCRIPTION	4 1/2" spherical float with 5/16" BSW brass insert, packed and sold in 10s	4 1/2" spherical float with plastic threads, packed and sold in 10s	4 1/2" cylindrical float with plastic threads, packed and sold in 10s	5" spherical float with 5/16" BSW brass insert	6" spherical float with 5/16" BSW brass insert	8" spherical float with 3/8" BSW brass insert
REFERENCE	DBS0420	DBS0450	DBC0440	DBS0540	DBS0640	DBS1300
EAN CODE	5017134102864	5017134102901	5017134102796	5017134102918	5017134102949	5017134103014
PACKAGING	Bag	Bag	Bag	Bag	Bag	Bag
MULTIPLE / BOXED QUANTITY	10	10	10	01/50	01/50	01/20

SUPERFLOAT				
				
DESCRIPTION	8" spherical float with 7/16" BSW brass insert	10" spherical float with 1/2" BSW brass insert	10" spherical float with 9/16" BSW brass insert	12" spherical float with 5/8" BSW brass insert
REFERENCE	DBS0840	DBS1400	DBS1040	DBS1240
EAN CODE	5017134102987	5017134103021	5017134102994	5017134103007
PACKAGING	Bag	Bag	Bag	Bag
MULTIPLE / BOXED QUANTITY	01/20	01/10	01/10	01/05



## CONCEALED CISTERNS



The concealed cistern range from Macdee by WIRQUIN offers solutions for both in-wall and bathroom furniture applications.

The cisterns offer easy access for maintenance purposes and WIRQUIN have some of the most compact units in the market. WIRQUIN'S concealed cisterns come with a large array of push button, push plate and lever solutions for you to choose from.

Bespoke options are also available from WIRQUIN should you require a bespoke solution.

### DUO COMPACT CONCEALED CISTERN

- ▶ Most compact cistern on the market
- ▶ Water saving flushing valve 6/4 + 4/2.6 litre
- ▶ Front and top access for easy maintenance
- ▶ Fully pre-assembled complete with isolation valve
- ▶ Internal overflow
- ▶ Ideal for bathroom furniture and in wall installations
- ▶ Lid fixing screws supplied for additional security
- ▶ Optional front access chrome finish fascia plate available
- ▶ W - 336mm x H - 320mm x D - 140mm
- ▶ WRAS approved flushing and inlet valve\*
- ▶ JOLLYFILL delayed action inlet valve



CDC52/53CP



DESCRIPTION	ASSEMBLED DUO COMPACT			UNASSEMBLED DUO COMPACT	
	Concealed 1 1/2" cable operated dual flush valve and chrome button front & top access side entry cistern	Concealed 2" cable operated dual flush valve and chrome button front & top access side entry cistern	Front access chrome fascia plate	Concealed 1 1/2" cable operated dual flush valve and chrome button, top access only	Concealed 2" cable operated dual flush valve and chrome button, top access only
REFERENCE	CDC52CP	CDC53CP	CDF01CP	CDC40CP	CDC41CP
EAN CODE	5017134120486	5017134117837	5024139037817	5017134119817	5017134119824
PACKAGING	Box	Box	Boxed	Box	Box
PALLET	1 / 54	1 / 54	N/A	1 / 54	1 / 54





**UNI COMPACT**

- ▶ Front or top fix button operation
- ▶ Ideal for bathroom furniture
- ▶ (left or right hand feed)
- ▶ Reversible inlet valve positioning
- ▶ Complete with isolation valve
- ▶ Water saving flushing valve (6/4 & 4/2.6 litre flush)
- ▶ Suitable for bottom or side feed
- ▶ WRAS approved flushing and inlet valves\*
- ▶ W - 340mm x H - 350mm x D - 130mm



DESCRIPTION	Dual flush concealed cistern with 2" cable operated dual flush valve with chrome push button	Dual flush concealed cistern with moon chrome dual flush plate	Moon Chrome dual flush push plate
REFERENCE	UCD01CP	UCD02CP	50718122
EAN CODE	5017134120509	5017134120516	3375537180813
PACKAGING	Box	Box	Box
PALLET	1/60	1/60	N/A

BUTTON DESIGN			
---------------	--	--	--



**PNEU COMPACT I**

- ▶ Water saving flushing valve
- ▶ Full flush volume settings to achieve 6, 5 and 4 litre flushing
- ▶ Internal overflow
- ▶ JOLLYFILL delayed action inlet valve
- ▶ Fully assembled
- ▶ Ideal for modern day furniture and in wall installations
- ▶ Complete with Kara 50mm single flush push button
- ▶ W - 336mm x H - 320mm x D - 140mm
- ▶ WRAS approved inlet & outlet valves\*



DESCRIPTION	<b>Pneumatic single flush front and top access side entry 1 1/2" outlet cistern</b>	<b>Pneumatic single flush front and top access bottom entry 1 1/2" outlet cistern</b>
REFERENCE	CPL41CP	CPL43CP
EAN CODE	5017134114546	5017134120219
PACKAGING	Box	Box
PALLET	1/54	1/54

**PNEU COMPACT II**

- ▶ Water saving flushing valve
- ▶ Full and part flush volume settings to achieve 6/3, 5/3 and 4/2.6 litre flush
- ▶ Fully assembled
- ▶ Internal overflow
- ▶ WRAS approved inlet and outlet valves\*
- ▶ W - 336mm x H - 320mm x D - 140mm



DESCRIPTION	<b>Pneumatic dual flush front and top access side entry 2" outlet cistern</b>	<b>Pneumatic dual flush front and top access bottom entry 2" outlet cistern</b>	<b>Pneumatic dual flush front and top access side entry 1 1/2" outlet cistern</b>	<b>Pneumatic dual flush front and top access bottom entry 1 1/2" outlet cistern</b>	<b>Pneumatic dual flush front and top access side inlet 2" outlet cistern with Kara 72mm button</b>
REFERENCE	CPL61CP	CPL62CP	CPL51CP	CPL52CP	CPL63CP
EAN CODE	5017134119435	5017134119473	5017134120240	5017134120257	5017134119497
PACKAGING	Box	Box	Box	Box	Box
PALLET	1/54	1/54	1/54	1/54	1/54

**PNEUMATIC DUAL FLUSH BUTTONS / PUSH PLATES\***

- ▶ Compatible with our Kayla dual flush pneumatic valve
- ▶ Easy to install push plates and buttons
- ▶ Ideal for both bathroom furniture or in wall installations
- ▶ Easy clean for additional hygiene
- ▶ Compatible with Pneu Compact II cisterns



SYG612MF



SYG610CP



SYG611CP

DESCRIPTION	Kara 72mm Chrome dual flush push button*	Kara 50mm Chrome dual flush push button*	Caspia Chrome dual flush push plate*	Caspia Matt dual flush push plate*	Caspia Brushed Stainless Steel finish dual flush push plate*
REFERENCE	SYG610CP	SYG611CP	SYG612CP	SYG612MF	SYG612BS
EAN CODE	5017134119343	5017134119350	5017134119138	5017134119145	5017134128765

\*Compatible with Kayla dual flush pneumatic flush valve only.

**KARA PNEUMATIC SINGLE FLUSH PUSH BUTTONS\*\***

- ▶ Compatible with our Kayla single flush pneumatic valve
- ▶ Ideal for both bathroom furniture or in wall installations
- ▶ Easy clean for additional hygiene
- ▶ Compatible with Pneu Compact I cisterns
- ▶ Ideal for high traffic areas



DESCRIPTION	72mm Chrome single flush push button**	50mm Chrome single flush push button**
REFERENCE	SYG608CP	SYG609CP
EAN CODE	5017134119367	5017134119374

\*\*Compatible with Kayla single flush pneumatic valve only.

**HIDEAWAY CONCEALED DUAL FLUSH METRO RAPID**

- ▶ Water saving 6/4 litre dual flush Metro Rapid siphon
- ▶ Available with either side or bottom entry inlet valves
- ▶ Internal overflow
- ▶ Metro Rapid allows easy maintenance without removing the cistern
- ▶ The Hideaway concealed cistern is a traditional cistern which is ideal for installations behind deep ducted walls
- ▶ WRAS products included
- ▶ W - 505mm x H - 312mm x D - 146mm

DESCRIPTION	Concealed dual flush Metro Rapid siphon operated side entry top access dual overflow cistern complete with 210mm chrome lever	Concealed dual flush Metro Rapid siphon operated bottom entry top access dual overflow cistern complete with 210mm chrome lever
REFERENCE	CFH14DF	CFH16DF
EAN CODE	5017134119633	5017134119640
PACKAGING	Box	Box
PALLET	1/40	1/40



CFH14DF

## HIDEAWAY CONCEALED SINGLE FLUSH

- ▶ Allows flush volumes to be varied between 6/7/9 litres ideal for both new and replacement installations.
- ▶ Available with either side or bottom entry inlet valve.
- ▶ Internal overflow.
- ▶ Varying length levers available to suit installation and different wall thickness.
- ▶ WRAS products included.
- ▶ W - 505mm x H - 312mm x D - 146mm



CFH14CP

DESCRIPTION	Concealed single flush siphon operated side entry top access internal overflow cistern (excluding lever)	Concealed single flush siphon operated side entry top access internal overflow cistern complete with 210mm chrome lever	Concealed single flush siphon operated side entry top access internal overflow cistern complete with 340mm chrome lever	Concealed single flush siphon operated bottom entry top access internal overflow cistern (excluding lever)	Concealed single flush siphon operated bottom entry top access internal overflow cistern complete with 210mm chrome lever
REFERENCE	CFH2000	CFH14CP	CFH15CP	CFH2100	CFH16CP
EAN CODE	5017134101409	5017134101348	5017134101355	5017134101416	5017134101379
PACKAGING	Box	Box	Box	Box	Box
PALLET	1/40	1/40	1/40	1/40	1/40

## HIDEAWAY AUTOMATIC

- ▶ Used with urinals where a concealed auto flush option is required
- ▶ Different flush volume options available ranging from 1 gallon to 3 gallons
- ▶ Suitable for both new and replacement installations
- ▶ Compatible with our extensive range of urinal pipework and spreaders
- ▶ W - 505mm x H - 312mm x D - 146mm



DESCRIPTION	Concealed cistern complete with 1 gallon/4.5 litres auto siphon and petcock	Concealed cistern complete with 2 gallon/9 litres auto siphon and petcock	Concealed cistern complete with 3 gallon/13.6 litres auto siphon and petcock
REFERENCE	CFH0900	CFH1000	CFH0800
EAN CODE	5017134101317	5017134101324	5017134101300
PACKAGING	Box	Box	Box
PALLET	1/40	1/40	1/40

## EXPOSED CISTERNS

WIRQUIN have a complete range of exposed cisterns suitable for all applications in today's market. The range includes both low level and high level systems and WIRQUIN are also able to create new bespoke cisterns to satisfy your individual requirements.

The range is suitable for any type of industry from residential to commercial, whether it be new build or retro-fit.

### ELAN LOW AND HIGH LEVEL

- ▶ Allows flush volumes to be varied between 6/7/9 litres making it ideal for both new and replacement installations
- ▶ Internal overflow, no need for external pipework
- ▶ Low level option comes complete with chrome lever + 14" X 9" flushpipe
- ▶ High level option comes complete with cord and pull
- ▶ W - 505mm x H - 327mm x D - 150mm

DESCRIPTION	White low level side entry internal overflow 6/7/9 litre siphon chrome lever and 14 x 9 flushpipe	White low level bottom entry internal overflow 6/7/9 litre siphon chrome lever and 14 x 9 flushpipe	White high level side entry internal or overflow 6/7/9 litre siphon high level cord and pull
REFERENCE	CFE41WH	CFE51WH	CFE02WH
EAN CODE	5018787380029	5018787350022	5018787340023
PACKAGING	Box	Box	Box
PALLET	1/40	1/40	1/40



CFE41WH

### ELAN LOW AUTOMATIC

- ▶ Different flush volume options available ranging from 1 gallon to 3 gallons
- ▶ Used with urinals where exposed auto flush option is required
- ▶ Suitable for new and replacement installations
- ▶ Compatible with our extensive range of urinal pipework and spreaders

DESCRIPTION	White cistern complete with 1 gallon/4.5 litres auto siphon and petcock	White cistern complete with 2 gallon/9 litres auto siphon and petcock	White cistern complete with 3 gallon/13.6 litres auto siphon and petcock
REFERENCE	CFE09WH	CFE10WH	CFE08WH
EAN CODE	5018787390028	5018787400024	5018787370020
PACKAGING	Box	Box	Box
PALLET	1/40	1/40	1/40



### CONCORD LOW AND HIGH LEVEL

- ▶ Allows flush volumes to be varied between 6/7/9 litres, making it ideal for both new and replacement installations
- ▶ Internal overflow only
- ▶ Low level option comes complete with chrome lever + 14 x 9 flushpipe
- ▶ High level option complete with cord and pull
- ▶ W - 455mm x H - 318mm x D - 155mm



CCD41WH

DESCRIPTION	White low level side entry internal overflow 6/7/9 litre siphon chrome lever and 14 x 9 flushpipe	White low level bottom entry internal overflow 6/7/9 litre siphon chrome lever and 14 x 9 flushpipe	White high level side entry internal overflow 6/7/9 litre siphon complete with cord and pull
REFERENCE	CCD41WH	CCD51WH	CCD02WH
EAN CODE	5018787720023	5018787730022	5018787760029
PACKAGING	Box	Box	Box
PALLET	1/56	1/56	1/56

### CONCORD AUTOMATIC

- ▶ 1 and 2 gallon flush volumes available
- ▶ Used with urinals where exposed auto flush option is required
- ▶ Suitable for new and replacement installations
- ▶ Compatible with our extensive range of urinal pipework
- ▶ W - 455mm x H - 318mm x D - 155mm



DESCRIPTION	White cistern complete with 1 gallon/4.5 litres auto siphon and petcock	Concord white cistern complete with 2 gallon/9 litres auto siphon and petcock
REFERENCE	CCD09WH	CCD10WH
EAN CODE	5018787700025	5018787740021
PACKAGING	Box	Box
PALLET	1/56	1/56



CCR02WH







**RHINO HEAVY DUTY LOW AND HIGH LEVEL**

- ▶ Made from heavy duty anti vandal plastic resin with high gloss finish providing an aesthetically pleasing, durable anti vandal cistern
- ▶ Metro Rapid allows easy maintenance without removing the cistern
- ▶ Allows flush volumes to be varied between 6/7/9 litres making it ideal for both new and replacement installations
- ▶ Internal overflow
- ▶ A proven solution for contract and specification applications and heavy traffic areas
- ▶ Low level option complete with chrome metal lever as standard
- ▶ Lid fixing screws supplied for additional security
- ▶ High level complete with metal chain and wooden pull
- ▶ W - 515mm x H - 290mm x D - 190mm

DESCRIPTION	Rhino white low level side entry internal overflow 6/7/9 litre Metro Rapid siphon chrome lever and 14 x 9 flushpipe	Rhino white low level bottom entry internal overflow 6/7/9 litre Metro Rapid siphon chrome lever and 14 x 9 flushpipe	Rhino white high level side entry internal overflow 6/7/9 litre Metro Rapid siphon high level cord and pull
REFERENCE	CCR41WH	CCR51WH	CCR02WH
EAN CODE	5018787040022	5018787180025	5017134113259
PACKAGING	Box	Box	Box
MULTIPLE / BOXED QUANTITY	1/56	1/56	1/56













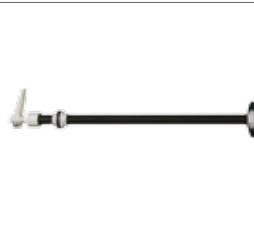

CISTERN LEVERS





							
DESCRIPTION	Chrome Victorian White ceramic and chrome plated on metal lever	Chrome Sofia 105mm chrome plated on metal fingertip lever	Chrome Sofia 115mm chrome plated on plastic lever	Chrome Paris 105mm chrome plated on metal fingertip lever	Plastic universal adjustable arm complete with grub screw	Brass adjustable arm complete with grub screw	Metal 200mm x 5/16" extension bar for concealed ducted levers
REFERENCE	DCA01WH	DCA01CP	DCA15CP	DCC05CP	DCA1700	DCA2400	LMZ2000
EAN CODE	5017134103106	5017134103076	5017134103380	5017134128826	5017134103403	5017134103434	5017134128833

DOC M CISTERN LEVERS

HIDEAWAY CISTERN LEVERS

					
DESCRIPTION	Wave chrome plated on metal	Chrome Enable 110mm chrome plated on metal easy use lever	Hideaway 210mm chrome lever kit - suitable for wall thickness of up to 210mm	Hideaway 340mm chrome lever kit - suitable for wall thickness of up to 340mm	Hideaway 420mm chrome lever kit - suitable for wall thickness of up to 420mm
REFERENCE	10717504	DCA52CP	DCA66CP	DCA67CP	DCA39CP
EAN CODE	3375537174850	5017134128840	5017134103625	5017134103656	5017134103533

FLUSHPIPES							
							
DESCRIPTION	White 14" x 9" low level flushpipe	White 18" x 18" low level flushpipe	White 24" x 18" low level flushpipe	White 24" x 24" low level flushpipe	White 5" 6" two piece high level (backwall) flushpipe	White 7" 0" two piece high level (backwall) flushpipe	White 7" 0" three piece high level (sidewall) flushpipe
REFERENCE	DFP01WH	DFP05WH	DFP08WH	DFP09WH	DFP10WH	DFP11WH	DFP12WH
EAN CODE	5017134104011	5017134104172	5017134104196	5017134104202	5017134104226	5017134104233	5017134104240

FLUSHPIPES					
					
DESCRIPTION	White extended 2" to 1 1/2" flushpipe (352mm x 510mm) complete with flush bung	Chrome on brass 13" x 8" low level flushpipe and shroud	Chrome on brass 5" 6" two piece high level (backwall) flushpipe complete with chrome shroud and pipeclip	Flexible 2" flushpipe (white)	Flexible 1 1/2" flushpipe (white)
REFERENCE	DFP215WH	PET16CP	PET17CP	59050001	59050101
EAN CODE	5017134128376	5017134128383	5024139034496	3375539053832	3375539076497

## URINAL FLUSHING









Extensive range of offset pipework to fit most cisterns and bowls.

URINAL BOWL PIPEWORK (EXCLUDING SPREADERS)				
Number of bowls and offset required	60mm cistern offset	74mm cistern offset	90mm cistern offset	110mm cistern offset
1 x no offset	UFA01CP	UFA11CP	UFA21CP	-
1 x 23mm offset	UFA02CP	UFA12CP	UFA22CP	UFA32CP
2 x no offset	-	UFB11CP	UFB21CP	-
2 x 23mm offset	UFB02CP	UFB12CP	UFB22CP	UFB32CP
2 x 38mm offset	-	UFB13CP	UFB23CP	-
3 x no offset	-	UFC11CP	UFC21CP	-
3 x 23mm offset	UFC02CP	UFC12CP	UFC22CP	UFC32CP
3 x 38mm offset	-	UFC13CP	UFC23CP	-
4 x no offset	-	-	UFD21CP	-
4 x 23mm offset	-	UFD12CP	UFD22CP	-







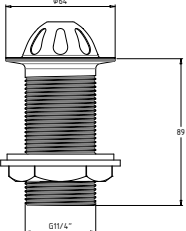
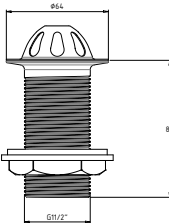
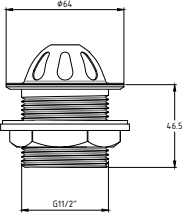
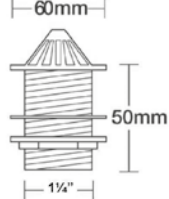
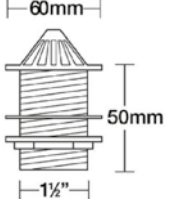
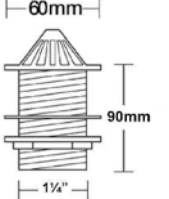
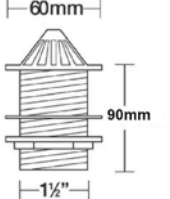





3 bowl pipework. Product Reference: UFC23CP

















	BRASS BODY			PLASTIC BODY				
								
DESCRIPTION	1 1/4" unslotted, stainless steel dome, 63mm flange, plastic backnut	1 1/2" unslotted, stainless steel dome, 63mm flange, plastic backnut	1 1/2" unslotted, stainless steel dome, 63mm flange, plastic backnut	1 1/2" unslotted, 60mm flange plastic backnut, anti splash	1 1/4" unslotted, 60mm flange, plastic backnut	1 1/2" unslotted, 60mm flange, plastic backnut	1 1/4" unslotted, 60mm flange, plastic backnut	1 1/2" unslotted, 60mm flange, plastic backnut
REFERENCE	WUS01SS	WUS02SS	WUS03SS	On Enquiry	WUS51WH	WUS52WH	WUS53WH	WUS54WH
EAN CODE	5024139089021	5024139096814	5024139008879	On Enquiry	5024139006370	5024139006363	7654321019680	7654321019697
PACKAGING	Box	Box	Box	Bag	Bag	Bag	Bag	Bag
MULTIPLE / BOXED QUANTITY	01/50	01/50	01/60	01/10	01/10	01/10	01/10	01/10
TAIL LENGTH mm	87 mm	86 mm	44 mm	44 mm	48 mm	48 mm	88 mm	88 mm
TECHNICAL DRAWING								

# SPARES & ACCESSORIES













## FLUSHING ACCESSORIES

											
DESCRIPTION	White blanking off plug complete with washer and backnut, packed and sold in 10's	Chrome plated blanking off plug complete with washer and backnut and sold in 10's	Close coupling kit (1 1/2" outlet) complete with close coupling washer	Stepped conical close coupling washer (rubber) 1 1/2"	Plain conical close coupling washer (rubber) 1 1/2"	Close coupling washer 120mm x 57mm x 20mm (foam) 1 1/2" outlet	Close coupling washer 99mm x 57mm x 20mm (foam) 1 1/2" outlet	Close coupling washer 110mm x 70mm x 20mm (foam) 2" outlet	Galvanised cistern support brackets (pair)	Close coupling washer for 2" outlet	Bolted close coupling kit
REFERENCE	DCA45WH	DCA45CP	DCP1400	DCA3200	DCA3210	DCA2800	DCA2801	DCA2803	DCA4600	M32	10717751
EAN CODE	5017134103557	5017134103540	5017134103731	5017134103496	5017134103502	5017134103465	5017134103472	5017134128871	5017134103564	3375530070210	3375537160891













## SIPHON SPARES

														
DESCRIPTION	Metro Rapid or Metro one siphon diaphragm washer - oblong	Metro Rapid diaphragm washer - Square	Metro Rapid diaphragm washer - Round	Metro Rapid diaphragm washer - D Shape	Metro siphon 1 1/2" back nut	Metro siphon 1 1/2" base sealing washer	Metro siphon 1 1/2" coupling nut	Low level flushpipe sealing washer	Metro 2 1/4" metal c-link	Metro 3 1/2" metal c-link	Metro 4 3/8" metal c-link	5" siphon diaphragm washer	Metro Rapid spares kit	Metro flush volume selector
REFERENCE	DSY1300	DSB4100	DSB4200	DSY3900	DSY1500	DSY1600	DSY1700	DFP1400	DSY1900	DSY2000	DSY2100	DSY3600	DSA5000	DSA5900
EAN CODE	5017134104868	5017134128888	5017134128895	5017134128901	5017134104875	5017134104882	5017134104899	5017134104264	5017134128918	5017134128925	5017134128932	5017134128949	5017134104585	50171341228956

	SILENTA INLET ACCESSORIES			JOLLYFILL/TOPY SPARE
				
DESCRIPTION	Silenta ball valve diaphragm washer	Silenta ball valve high pressure seating	Silenta ball valve low pressure seating	Jollyfill and Topy diaphragm washer (sold in 5s)
REFERENCE	DVA1100	DVA1200	DVA1300	10717797
EAN CODE	5017134128970	5017134128987	5017134128994	3375537177646

	FLUSHING ACCESSORIES											
												
DESCRIPTION	Flushpipe universal push over connector	15mm snap on pipe clips (100's)	22mm snap on pipe clips (100's)	1/2" tap and ball valve washers (100's)	3/4" tap and ball valve washer (100's)	3/4" overflow rubber washer	2 3/8" x 1 11/16" x 1 1/4" lavatory washer (sold in 100's)	3 3/4" x 1 15/16" x 1 1/2" bath washer (sold in 100's)	3 1/2" x 1 15/16" x 1 1/2" sink washer (sold in 100's)	Universal top hat spacers 3/4" to 1/2" (sold in 100's)	278mm bottom entry pisa overflow	Universal Bung
REFERENCE	DFC1800	DPA0300	DPA0400	DPA0900	DPA1000	DPA1100	DPA1200	DPA1500	DPA1600	DPA1700	POF0400	59180004
EAN CODE	5017134103816	5017134104325	5017134104332	5017134104387	5017134104394	5017134104400	5017134104417	5017134104448	5017134104455	5017134104462	5017134106008	3375537160884





**FLUSHING VALVE ACCESSORIES**

												
DESCRIPTION	Overflow washer for flushing (sold in 5s)	Jollyflush dual flush chrome push button (grey cable) (sold in 5s)	Dual flush chrome push button (For white, green or blue cable generation)	Kara 72mm Chrome dual flush push button*	Kara 50mm Chrome dual flush push button*	Single flush chrome push button	Doc M single flush chrome push button	72mm Chrome single flush push button**	Grey cable for MW2 and Jollyflush flushing valve	White cable for MWS flushing valve	Green cable for MWS flushing valve	Blue cable for MWS flushing valve for furniture
REFERENCE	10717748	10717795	19008001	SYG610CP	SYG611CP	19007001	10717796	SYG608CP	19080001	19080002	19080004	19080003
EAN CODE	3375537177158	3375537177622	3375539046223	5017134119343	5017134119350	3375539046216	3375537177639	5017134119367	3375537162505	3375537162512	3375537162499	3375537162529

\*Compatible with Kayla dual flush pneumatic flush valve only.

\*\*Compatible with Kayla single flush pneumatic valve only.

**HIDEAWAY CISTERN ACCESSORIES**

						
DESCRIPTION	Metro Rapid dual flush 8 1/2" oblong with 7 1/2" bend with 3" c-link and low level fixing kit	Hideaway side entry inlet valve	Hideaway bottom entry inlet valve	Hideaway 210mm chrome lever kit - suitable for wall thickness of up to 210mm	Hideaway 340mm chrome lever kit - suitable for wall thickness of up to 340mm	Hideaway 420mm chrome lever kit - suitable for wall thickness of up to 420mm
REFERENCE	DSY70DF	DVF5100	DVF5200	DCA66CP	DCA67CP	DCA39CP
EAN CODE	5017134119671	5017134105384	5017134105391	5017134103625	5017134103656	5017134103533



**ELAN CISTERN ACCESSORIES**

						
DESCRIPTION	8 1/2" one piece siphon complete with 3 1/2" metal c-link badge lid fixing kit and low level fixing pack	Side entry inlet valve	Bottom entry inlet valve	115mm chrome on plastic cistern lever	High level lever repair kit complete with nylon cord and pull	High level lever repair kit complete with metal chain and wooden pull
REFERENCE	DSY2138	DVF5100	DVF5200	DVA15CP	DCA1010	DCA1070
EAN CODE	5017134104929	5017134105384	5017134105391	5017134103380	5017134103250	5017134103311

**TANK ACCESSORIES**

						
DESCRIPTION	4 Gallon/18 litre tank - excluding jacket lid - Byelaw kit	4 Gallon/18 litre tank lid	4 Gallon/18 litre tank installation jacket	4 Gallon/18 litre tank lid - installation jacket and by-law 30 kit	Byelaw 30 kit complete with screened breather and warning pipe unit 1 1/4" dip tube bend rubber grommet for vent expansion pipe (England & Wales)	Byelaw 60 kit complete with screened breather and warning pipe unit 1 1/4" dip tube bend rubber grommet for vent expansion pipe (Scotland)
REFERENCE	TTR0400	TLR0400	TJR0400	TBR0400	TBL3000	TBL6000
EAN CODE	5017134107258	5017134107067	5017134106985	5017134106824	5017134128857	5017134128864

**CONCORD CISTERN ACCESSORIES**

							
DESCRIPTION	Concord 8" one piece siphon complete with 3" metal c-link badge and low level fixing kit	Concord side entry inlet valve	Concord bottom entry inlet valve	115mm chrome on plastic cistern lever	Concord fulcrum arm and bracket high level metal chain with wooden pull	High level metal chain and wooden pull	Concord fulcrum arm and bracket
REFERENCE	DSY4150	DVS1082	DVS3972	DCA15CP	DCA09CP	DCA1000	DCA1100
EAN CODE	5017134128772	5017134105452	5017134128789	5017134103380	5017134111613	5017134103243	5017134103328

# www.wirquin.co.uk

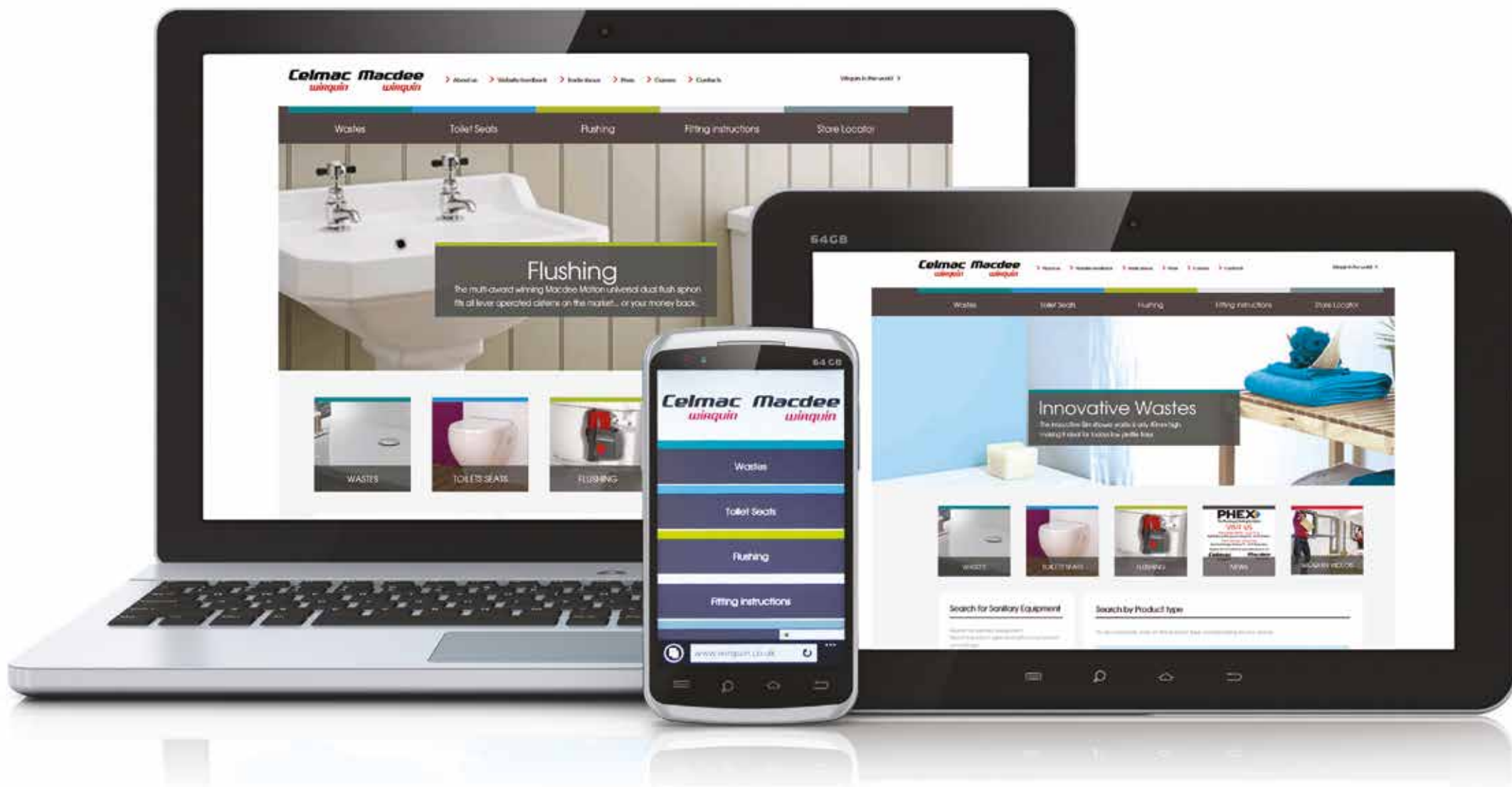

# WC Frames

CHRONO

INTRAMUROS

PPX

2 IN 1

PUSH PLATES

**Macdee**  
*wirquin*



CHRONO



► Innovative technology for a record installation time

**EASY ADJUSTMENT**

of the push plate to the thickness of the support with no need for tools or cutting



**INNOVATIVE INSULATION SYSTEM**

Ecological double-skin anti-condensation cistern (free from polystyrene foam)

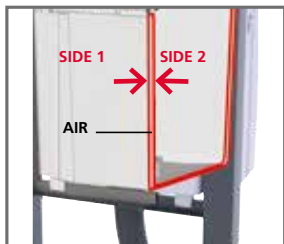

**SIMPLE HEIGHT ADJUSTMENT**

Height adjustable legs with integrated braking system

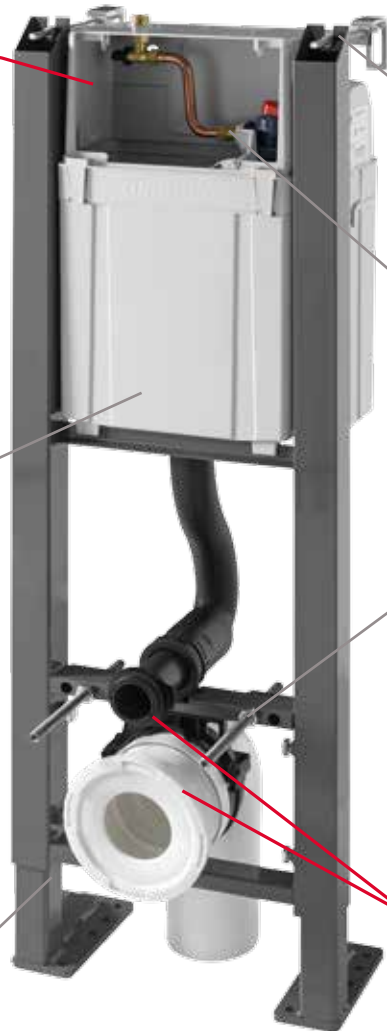

**INSTALLATION WITHOUT MOVING THE PRODUCT**

Simple adjustment when fixing to wall even if uneven

**EASY ACCESS TO THE CISTERN**

Large front access panel for easy servicing

**ULTRA-FAST INSTALLATION**

Hexagonal-imprinted threaded rods

**EASY PAN INSTALLATION**

No measuring or cutting of pan or flush pipe

The Chrono frame can be installed up to twice as fast thanks to its pre-assembled components and intuitive fitting procedure.

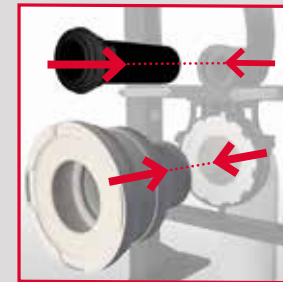

\*Complete with WRAS approved fittings



**CHRONO**



DESCRIPTION	Chrono Frame
REFERENCE	55720181
EAN CODE	3375537201044
PACKAGING	Box
MULTIPLE / BOXED QUANTITY	01/01
PALLET QUANTITY	10
INSTALLATION	Wall & Floor
HEIGHT ADJUSTABLE	1063mm - 1278mm
LOAD TESTED TO	400 kg
JOLLYFLUSH CONTROL SYSTEM	Cable
WATER SAVING	Dual flush 6/4 L

TECHNICAL DRAWING	
-------------------	--

## INTRAMUROS 1060



## ACOUSTIC INSULATION

The cistern is insulated with polystyrene and a Jollyfill inlet valve to ensure a quiet flush and fill

## DURABLE

Epoxy coated steel frame



## ACCESSIBLE

Easy installation as all components are accessible in the cistern (lid is not preassembled)

## UNIVERSAL

Wall and floor mounting

## SECURE

The pan connector is fixed using a 2 point support system on the metal structure

- It avoids vibrations

## QUICK ASSEMBLY WITH A GUARANTEED RESULT

The Intramuros 1060 wall hung frame, manufactured from high quality materials, offers a universal solution compatible with most installations.

Intramuros 1060 is quick to assemble with easy access for maintenance.

## ► HIGH PERFORMANCE

Complete with a water saving flush mechanism (3/6l) WRAS approved. The flush volumes can be optimised (2.7l/4l). Complete with Jollyfill delayed action inlet valve, very quiet, very quick and resists pressure peaks of up to 20 bars. Supplied with ½" isolation valve. Perfect for use with the Ecostop flush plate.

## ► ROBUST

The Wirquin WC Frame complies to the 400kg load bearing standard.



## ► DESIGN

A range of push plates in a stylish design in ABS and aluminium.



\*Complete with WRAS approved fittings



**INTRAMUROS 1060**



**INTRAMUROS SIMPLY ADJUSTABLE**



DESCRIPTION	Wall hung WC frame	Adjustable (after installation) wall hung WC frame	WC frame finishing board
REFERENCE	50717639	55718765	55718653
EAN CODE	3375537176182	3375537187126	3375537186020
PACKAGING	Box	Box	Box
MULTIPLE / BOXED QUANTITY	1/1	1/1	1/1
PALLET QUANTITY	10	7	50
INSTALLATION	Wall & floor mounted	Wall & floor mounted	-
HEIGHT ADJUSTABLE	1018mm - 1178mm	1090mm - 1140mm	-
LOAD TESTED TO	400kg	400kg	-
JOLLYFLUSH CONTROL SYSTEM	Cable	Cable	-
WATER SAVING	Dual flush 6/3L or 4/2.6L	Dual flush 6/3L or 4/2.6L	-
TECHNICAL DRAWING			



## PPX



DESCRIPTION	Compact WC Frame
REFERENCE	55718835
EAN CODE	8713381018145
PACKAGING	Box
MULTIPLE / BOXED QUANTITY	1/1
PALLET QUANTITY	10
INSTALLATION	Wall & floor mounted
HEIGHT ADJUSTABLE	958mm - 1178mm
LOAD TESTED TO	400 kg
JOLLYFLUSH CONTROL SYSTEM	Cable
WATER SAVING	Dual flush 6/4 L

## TECHNICAL DRAWING

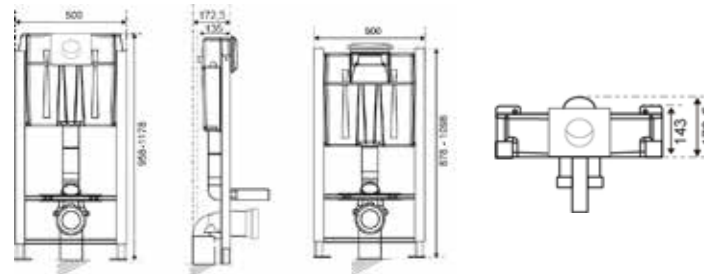









**2 IN 1: LOW & BIDET FRAME**







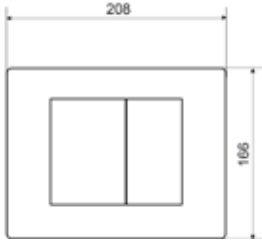
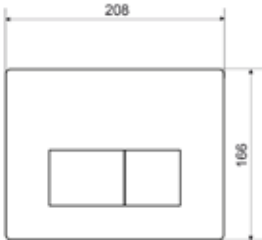
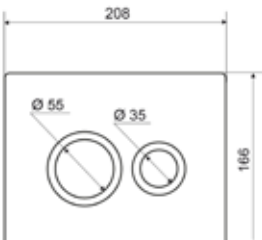



DESCRIPTION	Low level WC & bidet frame
REFERENCE	50717863
EAN CODE	3375537178292
PACKAGING	Box
MULTIPLE / BOXED QUANTITY	1/1
PALLET QUANTITY	80
INSTALLATION	Wall & floor mounted
HEIGHT ADJUSTABLE	280mm - 440mm
LOAD TESTED TO	400kg
JOLLYFLUSH CONTROL SYSTEM	Suitable with all the Macdee concealed cisterns range

TECHNICAL DRAWING	
-------------------	--

	ESSENTIAL		DESIGN		HOOPS		
							
DESCRIPTION	<b>Shiny White</b>	<b>Matt Chrome</b>	<b>Shiny White</b>	<b>Brushed Aluminium</b>	<b>Shiny White</b>	<b>Matt Black</b>	<b>Brushed Aluminium</b>
REFERENCE	55720347	55720349	55720350	55720351	55721304	55721306	55721305
EAN CODE	3375537202720	3375537202744	3375537202751	3375537202768	3375537212330	3375537212354	3375537212347
PACKAGING	Box	Box	Box	Box	Box	Box	Box
MULTIPLE / BOXED QUANTITY	01/30	01/30	01/30	01/30	01/06	01/06	01/06
WATER SAVING	Dual Flush	Dual Flush	Dual Flush	Dual Flush	Dual Flush	Dual Flush	Dual Flush
TECHNICAL DRAWING							

- Suitable for both domestic and commercial applications
- Only compatible with the Chrono frame

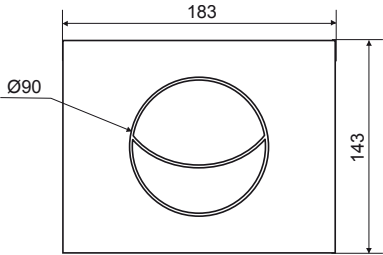
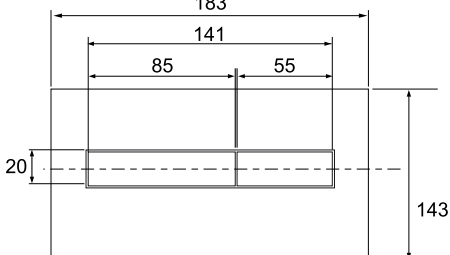
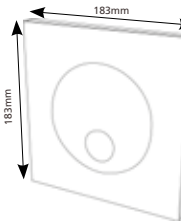
	MOON				LINE				ECOSTOP SENSOR
									
DESCRIPTION	Shiny Chrome	Shiny White	Matt Chrome	Shiny Black	Shiny Chrome with Matt Buttons	Matt Chrome	Matt White & Black	Matt White	Detection of presence, Brushed Metal
REFERENCE	50718122	50718328	50718580	50718471	50717686	50717753	50717687	50717752	55718612
EAN CODE	337537180813	337537182879	337537185290	337537184293	3375537176540	3375537177202	3375537176557	3375537177196	3375537185610
PACKAGING	Box	Box	Box	Box	Box	Box	Box	Box	Box
MULTIPLE / BOXED QUANTITY	01/16	01/16	01/16	01/16	01/16	01/16	01/16	01/16	01/09
WATER SAVING	Dual flush	Dual flush	Dual flush	Dual flush	Dual flush	Dual flush	Dual flush	Dual flush	Dual flush
TECHNICAL DRAWING									

- ▶ Suitable for both domestic and commercial applications
- ▶ Only compatible with PPX and Intramuros frames and Uni Compact cistern

# www.wirquin.co.uk

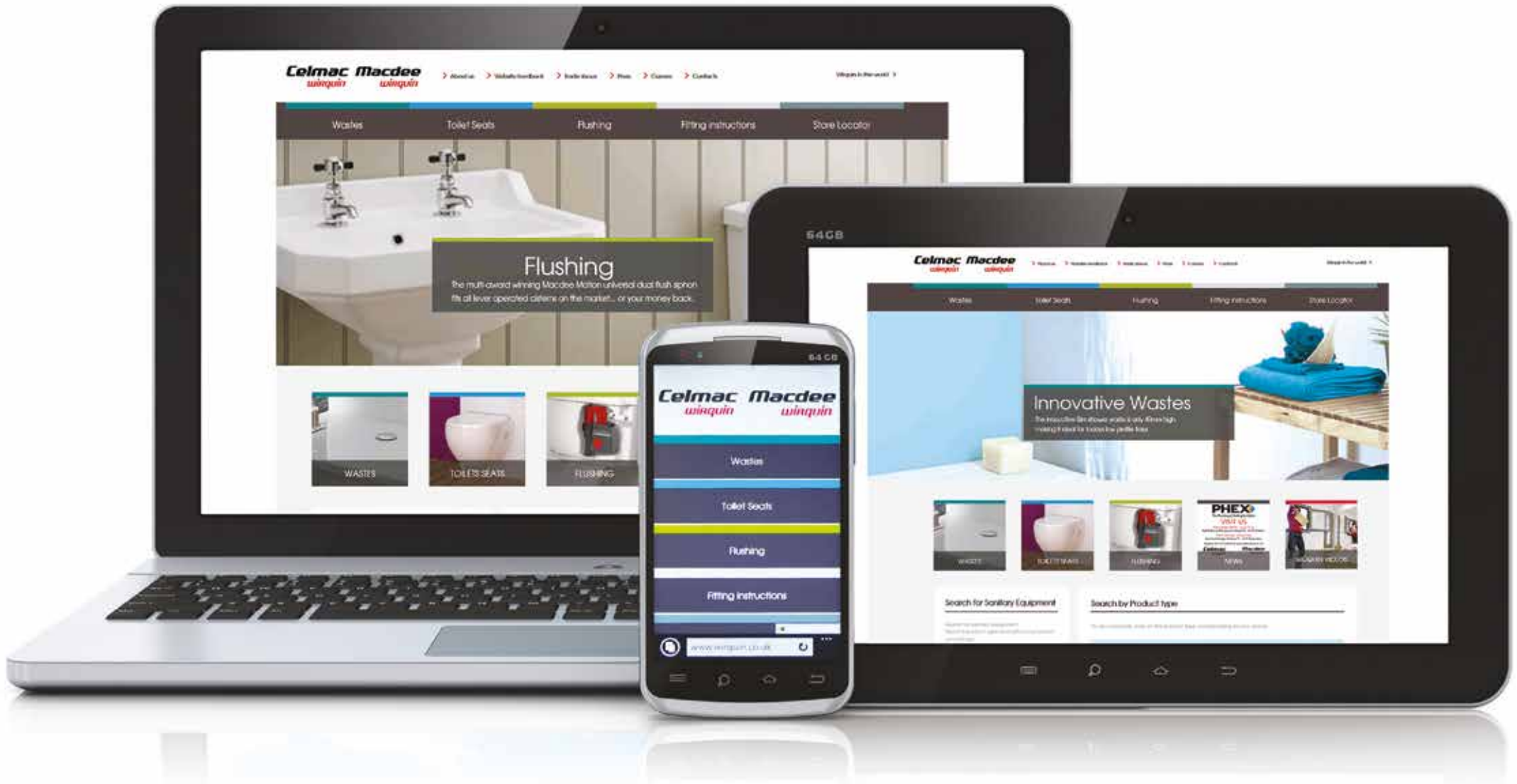

# WETROOMS

VENISIO EXPERT

VENISIO SLIM

VENISIO - LINEAR CHANNEL

VENISIO - SQUARE DRAIN

**Macdee**  
*wirquin*



# Perfect Match

## Venisio Expert



### Choice of finish

- ▶ Stainless steel grid
- ▶ Tiled

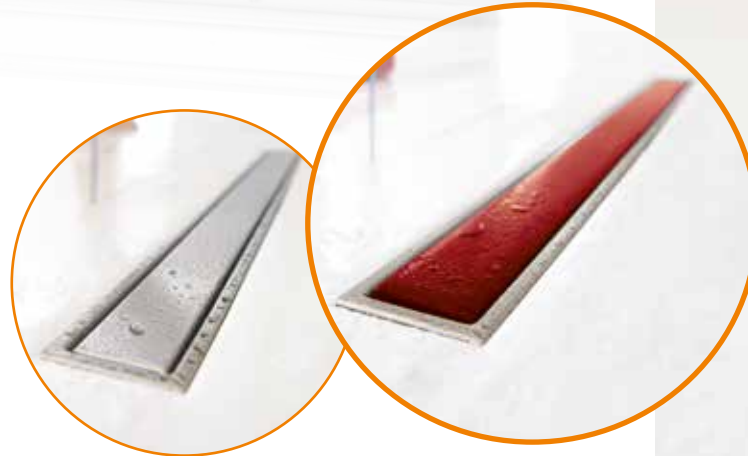

## WETROOMS

## VENISIO EXPERT

Guarantee  
**5**  
years

Channel for walk-in shower

Reversible finish grid

Self-contained trough with trap

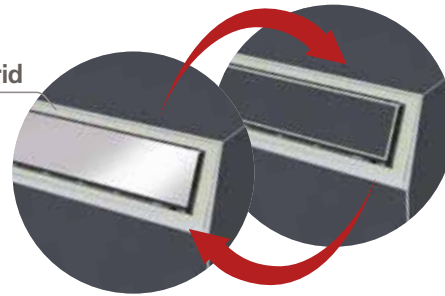
Stainless steel  
grid & frame

**89 mm**

Ø 43 male    Ø 50 male    Ø 50 female    Ø 43 female    Ø 50 male    Ø 50 female    Ø 43 male

## THE NEW GENERATION OF SHOWER CHANNEL COMBINING DESIGN, FINISHING & PERFORMANCE

Thanks to its self-contained trough with trap, VENISIO EXPERT provides the advantages essential for a walk-in shower range:

- ▶ Reduced dimensions: only 89mm below floor
- ▶ Ultra high flow rate: up to 79L/mn (under 20mm of water)
- ▶ 50mm water seal
- ▶ Reversible finish grid: brushed stainless steel or tile finish
- ▶ Self contained trough with trap: direct access to the trap from above
- ▶ Supplied with waterproofing sheet: secured by adhesion and screws to ensure a watertight seal
- ▶ Perfect finish: stainless steel grid and frame to prevent corrosion
- ▶ Height adjustable: even after tiling has been completed
- ▶ Installation DVD provided to enable easy installation

VENISIO EXPERT



DESCRIPTION	Linear channel			
REFERENCE	30718077	30718078	30718079	30718606
EAN CODE	3375537180363	3375537180370	3375537180387	3375537185559
PACKAGING	Box	Box	Box	Box
MULTIPLE / BOXED QUANTITY	01	01	01	01
LENGTH	700 mm	800 mm	900 mm	1100 mm
HEIGHT	89 mm			
DEPTH OF SEAL	50 mm			
FLOW RATE IN L/MN (UNDER 20mm OF WATER)	Up to 79 L/mn			
OUTLET	2 x Ø43 mm male + 1 x Ø43 mm female			
GRID	Brushed Stainless Steel or Tile Finish			
TECHNICAL DRAWING				



WETROOMS



VENISIO SLIM

All the technology of the EXPERT solution with the practicality of the SLIM

VENISIO SLIM	
REFERENCE	On Enquiry
EAN CODE	On Enquiry
PACKAGING	Box
MULTIPLE / BOXED QUANTITY	01
Channel LENGTH	300mm / 500mm / 700 mm
HEIGHT	50 - 110 mm
DEPTH OF SEAL	Waterless silicon membrane
FLOW RATE IN L/MN (UNDER 20mm OF WATER)	35 L/mn
OUTLET	Ø40-43 (female) compression / Ø43 / 1 1/2" (male) solvent weld
GRID	Brushed Stainless Steel or Tile Finish
TECHNICAL DRAWING	

COMPACT SIZE TO FIT IN THE TIGHTEST OF SPACES

VENISIO SLIM, the new wetroom channel, ideal for installing walk-in showers in renovation projects thanks to its unobtrusive slimline profile, with a height of just 50mm.

- ▶ Extra flat: only 50mm beneath floor
- ▶ Height adjustable: fine-tune the height of the channel using the adjustable supports
- ▶ Totally waterproof: supplied with butyl seal
- ▶ Compatible with tiles with a thickness between 8 – 16mm
- ▶ Reversible finish grid: brushed stainless steel or tile finish
- ▶ Easy to maintain: top access silicon membrane seal with removable hair filter



# Combining Style & Efficiency

## Venisio - Linear Channel



### Choice of Stainless Steel Grids



## WETROOMS

## VENISIO - LINEAR CHANNEL

Guarantee  
**5**  
years

Channel for walk-in shower

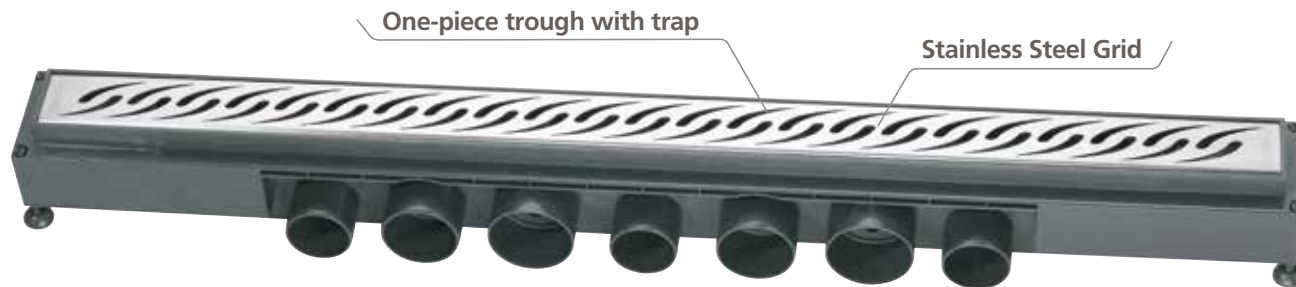

## THE NEW GENERATION OF SHOWER CHANNEL COMBINING STYLE & EFFICIENCY

Thanks to its self-contained trough with trap, VENISIO - LINEAR CHANNEL provides the advantages essential for a walk-in shower range:

- ▶ Reduced dimensions: only 80mm below floor
- ▶ Ultra high flow rate: up to 84L/mn (under 15mm of water)
- ▶ 50mm water seal
- ▶ Self contained trough with trap: for direct access to the trap from above
- ▶ Supplied with an anti-cracking sealing flap
- ▶ Height adjustable: height and channel levels are adjusted using feet mounted on a swivel joint
- ▶ Available in several versions
  - Complete pack (channel & grid)
    - 700 mm
    - 800 mm
    - 900 mm
  - Channel only (grids available separately)
    - 700 mm
    - 800 mm
    - 900 mm
- ▶ Complete pack also available

VENISIO - LINEAR CHANNEL



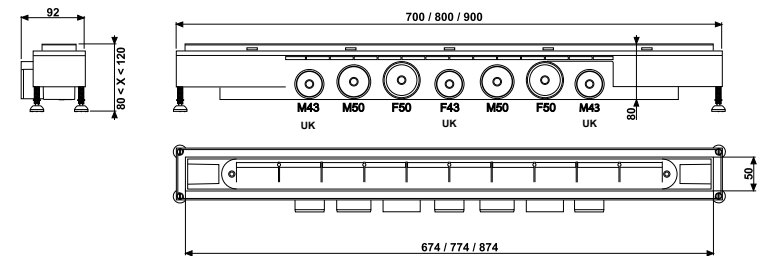
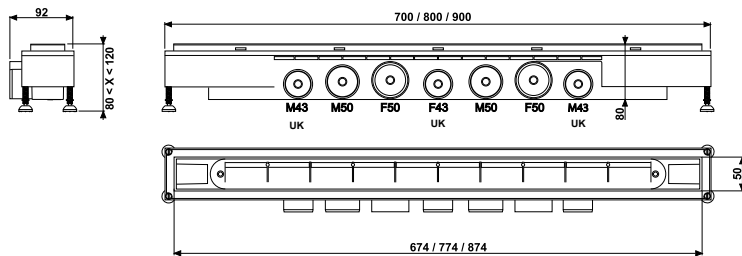

DESCRIPTION	Complete pack			Channel only		
REFERENCE	30717888	30717889	30717890	30717891	30717892	30717893
EAN CODE	3375537178544	3375537178551	3375537178568	3375537178575	3375537178582	3375537178599
PACKAGING	Box	Box	Box	Box	Box	Box
MULTIPLE / BOXED QUANTITY	01/04	01/04	01/04	01/04	01/04	01/04
LENGTH	700 mm	800 mm	900 mm	700 mm	800 mm	900 mm
HEIGHT	80 mm			80 mm		
DEPTH OF SEAL	50 mm			50 mm		
FLOW RATE IN L/MN (UNDER 15mm OF WATER)	Up to 84 L/mn			Up to 84 L/mn		
OUTLET	3 x outlets: 1 x 1/2" female + 2 x 1/2" male (Ø43mm for UK only)			3 x outlets: 1 x 1/2" female + 2 x 1/2" male (Ø43mm for UK only)		
GRID	Brushed stainless steel			-		

TECHNICAL DRAWING



## GRIDS FOR VENISIO - LINEAR CHANNEL

	GRID DESIGN	LENGTH	REFERENCE CODE	EAN CODE
	Style	700mm	30717763	3375537177301
		800mm	30717764	3375537177318
		900mm	30717765	3375537177325
	Griffe	700mm	30717766	3375537177332
		800mm	30717767	3375537177349
		900mm	30717768	3375537177356
	Flower	700mm	30717769	3375537177363
		800mm	30717770	3375537177370
		900mm	30717771	3375537177387



# The Essential Floor Drain

## Venisio - Square Drain



### Choice of Grids



## WETROOMS

## VENISIO - SQUARE DRAIN

Drain for walk-in shower

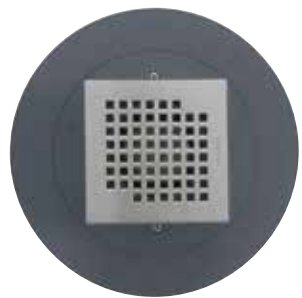

With Stainless Steel Grid



With Tileable Grid





Without Grid

## THE ESSENTIAL FLOOR DRAIN

- ▶ Reduced dimensions: only 77mm below floor
- ▶ High flow rate: up to 57L/mn (under 15mm of water)
- ▶ 50mm water seal
- ▶ Self contained drain with trap: direct access to the trap from above
- ▶ Supplied with a sealing flap for optimum sealing
- ▶ Height adjustable thanks to the booster:
  - 33mm - 100mm for stainless steel grid version
  - 43mm - 114mm for tileable grid version
- ▶ Available in several versions
  - Complete pack: with stainless steel grid
  - Complete pack: with tileable grid
  - Without grid (grids available separately)

VENISIO - SQUARE DRAIN

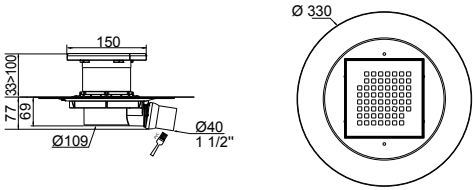
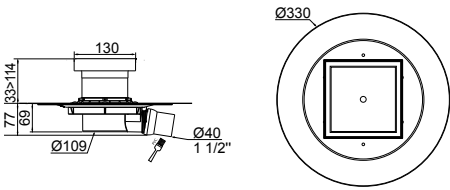
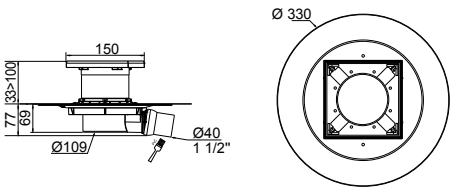
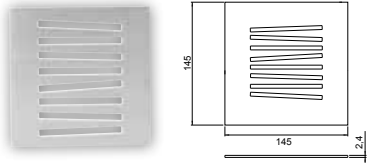
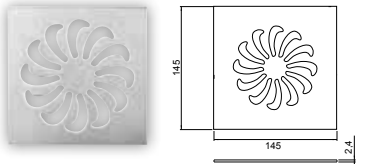
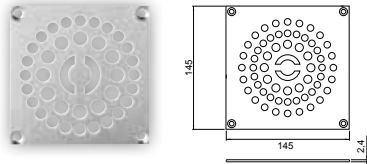
			
DESCRIPTION	Drain with Stainless Steel Grid	Drain with Tileable Grid	Drain without Grid
REFERENCE	30718105	30718107	30718109
EAN CODE	3375537180646	3375537180660	3375537180684
PACKAGING	Box	Box	Box
MULTIPLE	01	01	01
HEIGHT	110 mm to 177 mm	120 mm to 191 mm	110 mm to 177 mm
DEPTH OF SEAL	50 mm	50 mm	50 mm
FLOW RATE IN L/MN (UNDER 15mm OF WATER)	Up to 48 L/mn	Up to 57 L/mn	Up to 48 L/mn
GRID	Brushed Stainless Steel	Tile Option Only	Select from below
TECHNICAL DRAWING			
			
DESCRIPTION	Slatted Grid	Flowered Grid	Lockable Grid
REFERENCE	30718111	30718112	30718113
EAN CODE	3375537180707	3375537180714	3375537180721
PACKAGING	Box	Box	Box
MULTIPLE	01	01	01



# SHOWER

SHOWER WASTES Ø90

SHOWER WASTES Ø50

FLUSH GRATED Ø60

FLUSH GRATED Ø72

FLUSH GRATED Ø85

SHOWER TRAY FEET

**Macdee**  
*wirquin*



**SLIM**

▶ The flattest shower waste on the market

# Discover The new **SLIM** family



STAINLESS STEEL GRID   CHROMED METAL DOME   CHROMED ABS DOME



The SLIM range is specially designed to be fitted to the flattest trays on the market, in Ø90 thanks to its low height:

**ONLY 40 MM!**

The silicon membrane guarantees excellent flow rates and acts as a vapour barrier and air admittance valve.



# SHOWER Ø90 SLIM



The flattest shower waste on the market

- ▶ Anti back-siphoning system
- ▶ No smell guarantee: the membrane replaces the water trap
- ▶ Easy to maintain: Top access membrane with removable hair filter
- ▶ High performance flow rate

### 3 STYLISH DESIGNS

- ABS chrome dome
- Metal dome
- Brushed stainless steel grid

### FITS ALL SIZES

- 2 possible types of outlet:
- Ø 40 - 43 (female) compression
  - Ø 43 / 1 1/2" (male) solvent weld

### HIGH PERFORMANCE

- Flow rates upto 33.6 L/mn under 15mm of water

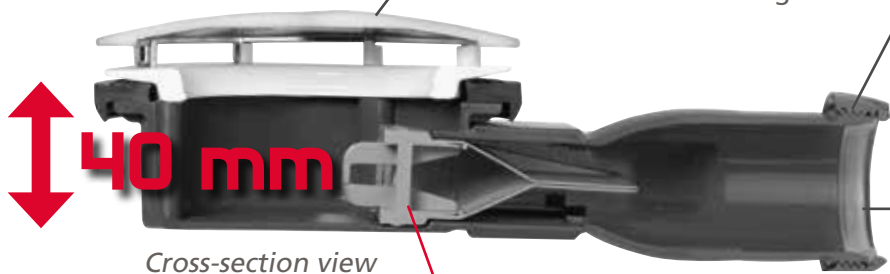

Cross-section view

### MEMBRANE-TYPE SIPHON

- Accessible from above
- Water seal option available

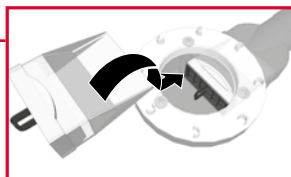

Tip: For stoneware trays or trays with conical drain holes, an adaptor is available.

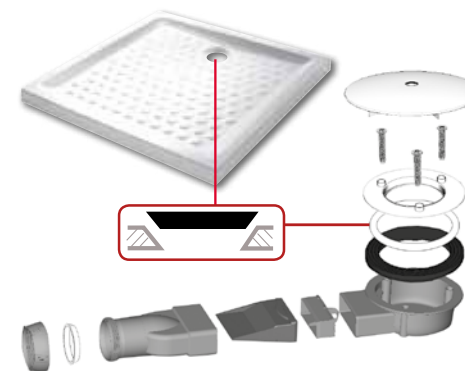

### Counter Top Display



REFERENCE	30120199
HEIGHT	213 mm
WIDTH	250 mm
DEPTH	140 mm



- > Free with an order of 12 x Slim (limited to 1 per customer)
- > Delivered in a protective sleeve
- > Includes a pre-fitted Slim shower waste with ABS Dome

SLIM Ø90



DESCRIPTION	<b>STAINLESS STEEL GRID</b>	<b>METAL DOME</b>	<b>ABS DOME</b>	<b>ABS DOME</b>
REFERENCE	30120191	30120190	30120015	30120026
EAN CODE	5017134132168	5017134132175	5017134123021	5017134123014
PACKAGING	Box	Box	Box	Box
MULTIPLE / BOXED QUANTITY	01/12	01/12	01/12	01/12
HEIGHT mm	40 mm	40 mm	40 mm	40 mm
FLOW RATE L/MN (UNDER 15mm OF WATER)	27 L/mn	28 L/mn	34 L/mn	24 L/mn
GRID / DOME	Brushed Stainless Steel Grid	Metal Chrome Dome	ABS Chrome Dome	ABS Chrome Dome
TECHNICAL DRAWING				

**JAMES Ø90 - COMPRESSION**

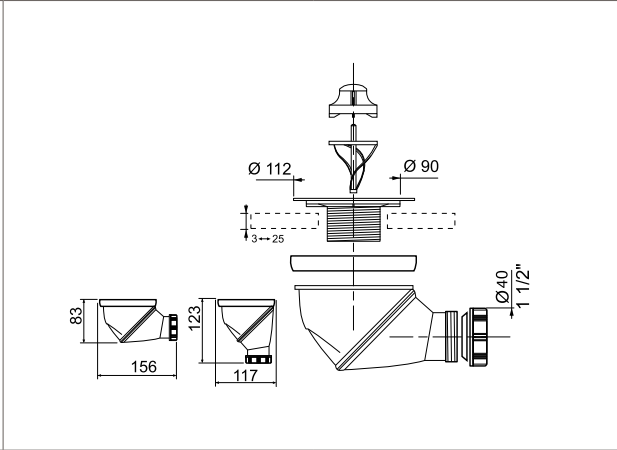
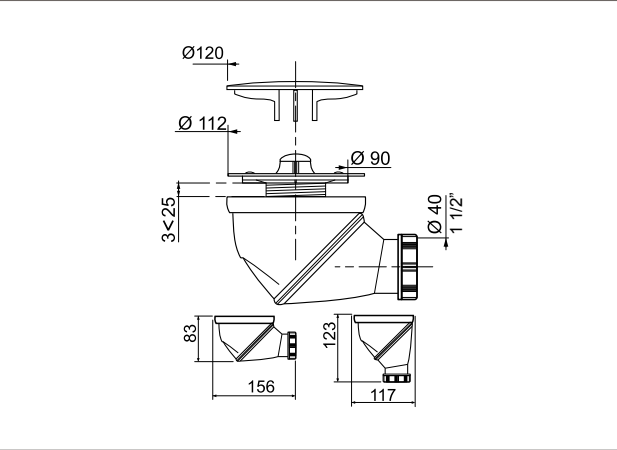
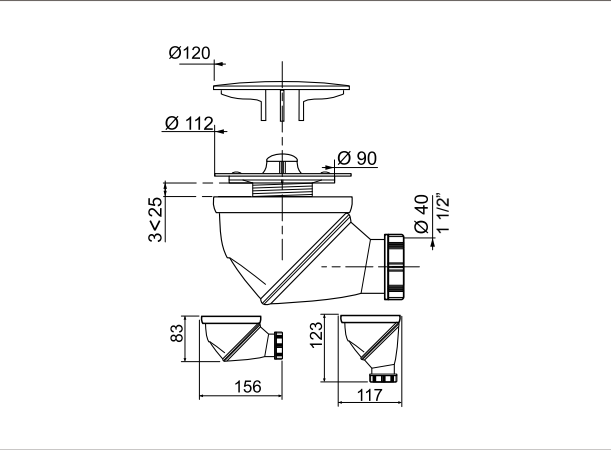
						
DESCRIPTION	Multi-positioning shower waste with compression outlet					
REFERENCE	30717455	30717456	30717459		On Enquiry	
EAN CODE	3375537174522	3375537174539	3375537174560		On Enquiry	
PACKAGING	Bag	Box	Box		Box	
MULTIPLE / BOXED QUANTITY	01/45	01/06	01/26		On Enquiry	
HEIGHT mm	83 mm horizontal position 123 mm vertical position		83 mm horizontal position 123 mm vertical position		83 mm horizontal position 123 mm vertical position	
DEPTH OF SEAL mm	50 mm		50 mm		50 mm	
FLOW RATE IN L/MN (UNDER 15mm OF WATER)	31 L/mn horizontal position 35 L/mn vertical position		31 L/mn horizontal position 35 L/mn vertical position		27 L/mn horizontal position 35 L/mn vertical position	
GRID / DOME	ABS Chrome Grid		ABS Chrome Dome		Metal Chrome Dome	
TECHNICAL DRAWING						

**JAMES Ø90 - SOLVENT WELD**



DESCRIPTION	Multi-positioning shower waste with solvent weld outlet		
REFERENCE	34230102	34230101	34230701
EAN CODE	3375539071751	3375539059162	3375537151882
PACKAGING	Bag	Box	Box
MULTIPLE / BOXED QUANTITY	01/50	01/24	01/26
HEIGHT mm	83 mm horizontal position 123 mm vertical position		83 mm horizontal position 123 mm vertical position
DEPTH OF SEAL mm	50 mm		50 mm
FLOW RATE IN L/MN UNDER 15ml OF WATER	31 L/mn horizontal position 35 L/mn vertical position		30 L/mn horizontal position 40 L/mn vertical position
GRID / DOME	ABS Chrome Grid		ABS Chrome Dome
TECHNICAL DRAWING			

**TWISTO Ø90**



DESCRIPTION	<b>Self Cleaning Vortex Shower Waste</b>		
REFERENCE	34040601	34040501	34070501
EAN CODE	3375539069505	3375539063428	337553713073
PACKAGING	Bag	Bag	Bag
MULTIPLE / BOXED QUANTITY	01/18	01/25	01/28
HEIGHT mm	90 mm	90 mm	90 mm
DEPTH OF SEAL mm	50 mm	50 mm	50 mm
FLOW RATE L/MN (UNDER 15mm OF WATER)	32 L/mn	32 L/mn	32 L/mn
GRID / DOME	ABS Chrome Dome	Brushed Stainless Steel Grid	Metal Chrome Dome
TECHNICAL DRAWING			



**TOURBILLON Ø90**



DESCRIPTION	Top access shower waste		Top access shower waste with flexi hose
REFERENCE	34060501	34080101	30719800
EAN CODE	3375537128433	337553741385502	3375537197255
PACKAGING	Bag	Bag	Box
MULTIPLE / BOXED QUANTITY	01/30	01/50	01/16
HEIGHT mm	78 mm	78 mm	78 mm
DEPTH OF SEAL mm	50 mm	50 mm	50 mm
FLOW RATE IN L/MN	32 L/mn	33 L/mn	33 L/mn
GRID / DOME	ABS Chrome Grid	ABS Chrome Dome	ABS Chrome Dome
TECHNICAL DRAWING			



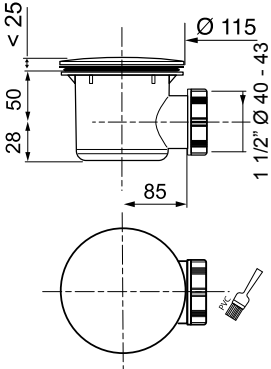
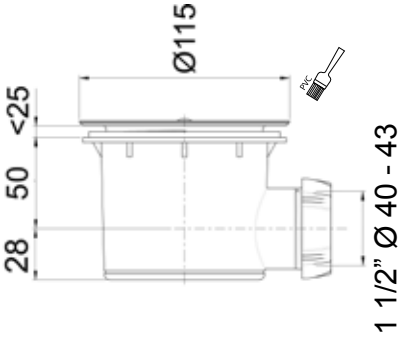
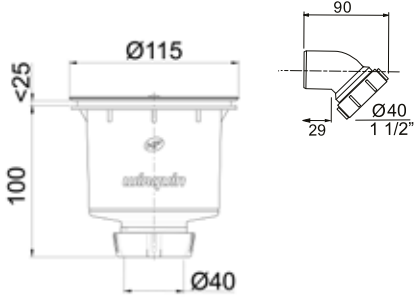

TOURBILLON Ø90

			
DESCRIPTION	Top access shower waste	Top access shower waste	Top access shower waste with vertical compression outlet
REFERENCE	On Enquiry	On Enquiry	On Enquiry
EAN CODE	On Enquiry	On Enquiry	On Enquiry
PACKAGING	Bag	Bag	Box
MULTIPLE / BOXED QUANTITY	On Enquiry	On Enquiry	On Enquiry
HEIGHT mm	78 mm	78 mm	100 mm
DEPTH OF SEAL mm	50 mm	50 mm	50 mm
FLOW RATE IN L/MN	28 L/mn	29 L/mn	31 L/mn
GRID / DOME	Metal Chrome Dome	Stainless Steel Grid	Stainless Steel Grid
TECHNICAL DRAWING			

## JAMES Ø50



DESCRIPTION	Multi-positioning shower waste with compression outlet		Multi-positioning shower waste with solvent weld outlet	
REFERENCE	30717457	30717458	30717266	34210101
EAN CODE	3375537174546	3375537174553	3375537172665	3375539059179
PACKAGING	Bag	Box	Bag	Box
MULTIPLE / BOXED QUANTITY	01/30	01/06	01/40	01/24
HEIGHT mm	83 mm horizontal position 123 mm vertical position		83 mm horizontal position 123 mm vertical position	
DEPTH OF SEAL mm	50 mm		50 mm	
FLOW RATE IN L/MN (UNDER 120mm OF WATER)	51 L/mn horizontal position 83 L/mn vertical position		51 L/mn horizontal position 83 L/mn vertical position	
GRID / DOME	ABS Chrome Grid		ABS Chrome Grid	
TECHNICAL DRAWING				

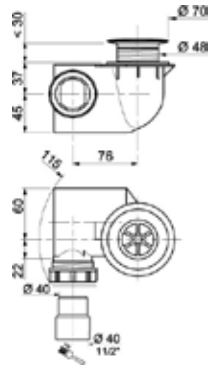
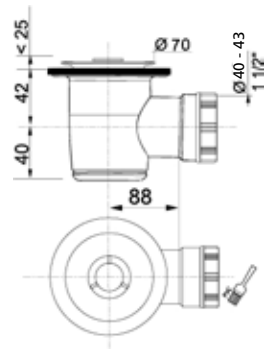
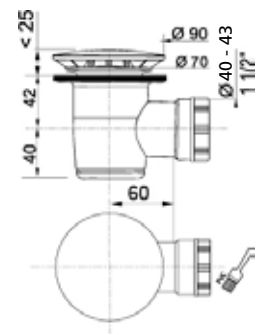

	TYPHOON Ø50	TOURBILLON Ø50	
			
DESCRIPTION	Self-cleaning vortex shower waste	Top access shower waste with compression and solvent weld outlet	
REFERENCE	SP815399	34020201	34020001
EAN CODE	3375536024590	3375537144815	3375537144785
PACKAGING	Bag	Bag	Bag
MULTIPLE / BOXED QUANTITY	01/60	01/81	01/72
HEIGHT mm	83 mm	82 mm	82 mm
DEPTH OF SEAL mm	2 x 25 mm	50 mm	50 mm
FLOW RATE IN L/MN (UNDER 120mm OF WATER)	33 L/mn	22 L/mn	22 L/mn
GRID / DOME	ABS Chrome Grid	ABS Chrome Grid	ABS Chrome Dome
TECHNICAL DRAWING			

FLUSH GRATED SHOWER WASTE Ø60



DESCRIPTION	1 1/4" Chrome plated brass, unslotted, plastic backnut	1 1/4" Chrome plated brass, unslotted, metal backnut	1 1/4" Chrome plated brass, slotted, plastic backnut	1 1/4" Chrome plated brass, slotted, metal backnut
REFERENCE	WFS02CP	WFS12CP	WFS03CP	WFS13CP
EAN CODE	5024139093776	5024139063069	5024139087836	5024139074652
PACKAGING	Box	Box	Box	Box
MULTIPLE / BOXED QUANTITY	01/64	01/40	01/64	01/64
TAIL LENGTH mm	85 mm	89 mm	85 mm	89 mm
TECHNICAL DRAWING				

FLUSH GRATED SHOWER WASTE Ø72

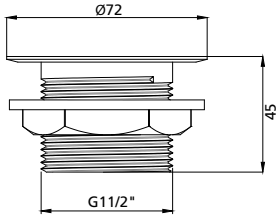
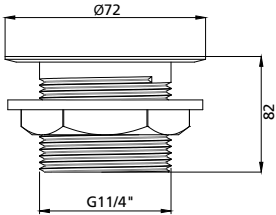
				
DESCRIPTION	1 1/2" Chrome plated brass, unslotted, metal backnut	1 1/2" Chrome plated brass, unslotted, plastic backnut	1 1/2" Plastic body, stainless steel waste, unslotted, plastic backnut	1 1/4" Plastic body, stainless steel waste, unslotted, plastic backnut
REFERENCE	WFS64CP	WFS54CP	WFS34SS	WFS22SS
EAN CODE	5024139083098	5024139054616	5024139088062	5024139008695
PACKAGING	Box	Box	Box	Box
MULTIPLE / BOXED QUANTITY	01/60	01/60	01/200	01/200
TAIL LENGTH mm	40 mm	41.5 mm	45 mm	82 mm
TECHNICAL DRAWING				

FLUSH GRATED SHOWER WASTE Ø85



DESCRIPTION	1 1/2" Chrome plated brass, unslotted, metal backnut	1 1/2" Chrome plated brass, slotted, plastic backnut	1 1/2" Chrome plated brass, unslotted, plastic backnut
REFERENCE	WFS67CP	WFS58CP	WFS57CP
EAN CODE	5024139101402	5024139069924	5024139101341
PACKAGING	Box	Box	Box
MULTIPLE / BOXED QUANTITY	01/36	01/33	01/36
TAIL LENGTH mm	85 mm	83 mm	88 mm
TECHNICAL DRAWING			

# SHOWER TRAY FEET



► 450kg Weight Capacity Shower Tray Feet

- **ROBUST:** Each foot withstands 450kg
- **HEIGHT ADJUSTABLE:** From 58mm – 172mm with height graduation marks for accurate setting
- **STABILITY:** Anti-slip stabilising base for an optimal installation
- **INCREASED SAFETY:** Each foot has four floor fixing points

REFERENCE	30719767
EAN CODE	3375537196944
PACKAGING	Bag
QUANTITY	Pack of 4

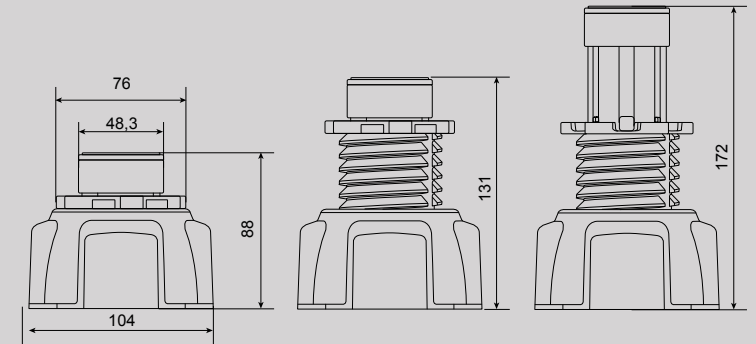

► Easy height adjustment

### ✓ TIP:

By removing the extension leg, the tray can be installed with a minimum height of on 58mm.



ADJUSTABLE FROM 58mm to 172mm

104mm wide base: To increase reliability and easy floor installation.

# www.wirquin.co.uk

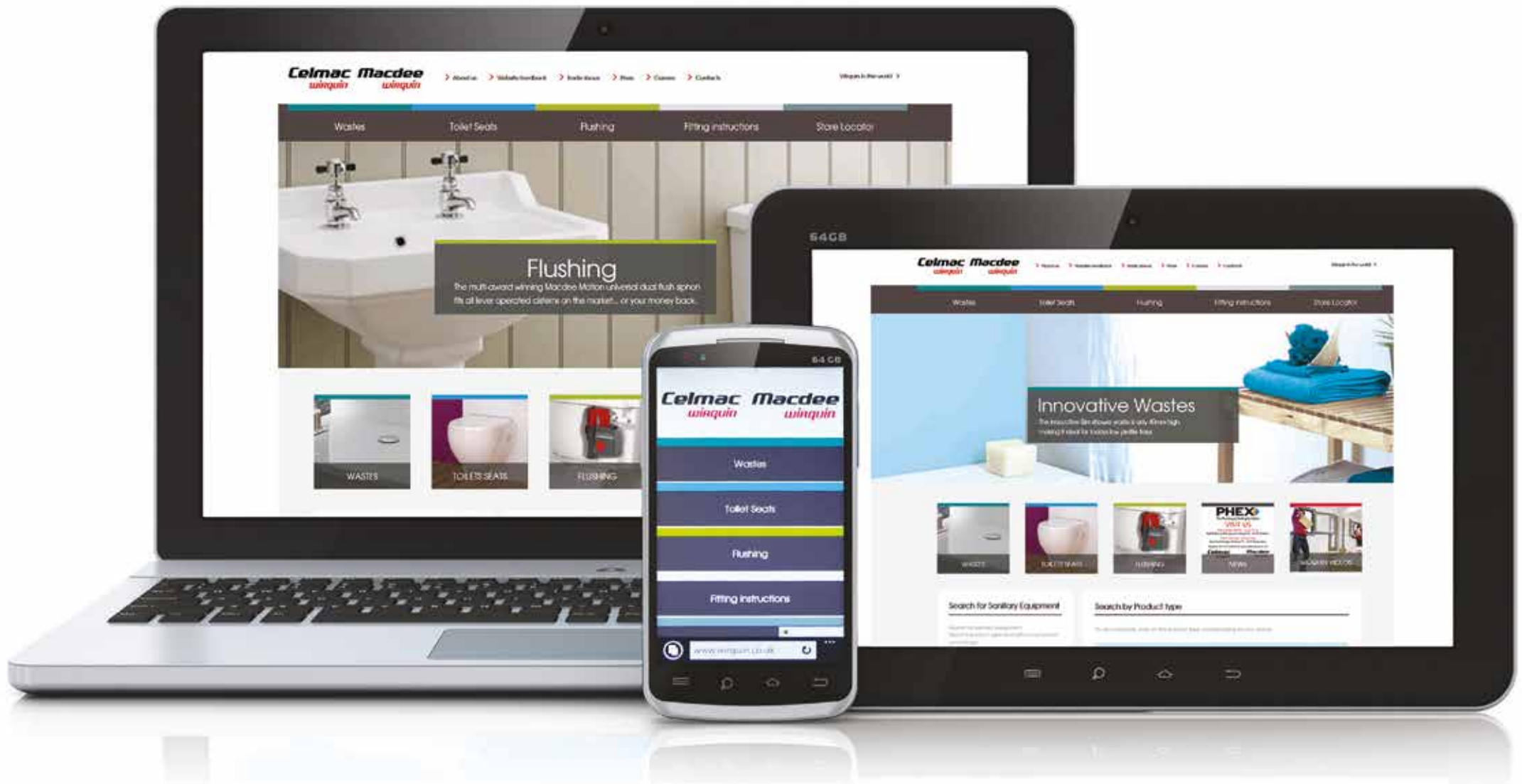



# Discover The new SB600 & Elton



**Metal/ABS Finish  
NEW ELTON**



**Metal Finish  
NEW SB600**



## CABLE BATH WASTE SB600 & ELTON



A high quality range, with different finishes, to suit any need

- ▶ A high quality range of cable bath wastes with technical performances higher than standard requirements
- ▶ High resistance stainless steel cable inside the flexible overflow tube for easier installation
- ▶ Trap with fastest flow rate on the market Cable opening-closing system with unique clutch control operation (lifetime guaranteed)\*

\*In normal conditions of use

### DESIGN HANDLE

Round and square options

### DOME OR INTERIOR PLUG

### STAINLESS STEEL GRID

### CABLE OPENING-CLOSING SYSTEM

90° Rotation

### 700 MM CABLE LENGTH

### EASY SET UP

The auto-centring washer retains the waste in position under the bath when the grid is being installed

### SPACE SAVING TRAP

- only 108mm under bath
- high flow rate 63 L/mn





## SPACE SAVING COBRA TRAP

- ▶ Fastest flow rate on the market - 63 L/m
- ▶ Self cleaning trap guaranteed not to block
- ▶ Space saving - only 108mm under bath





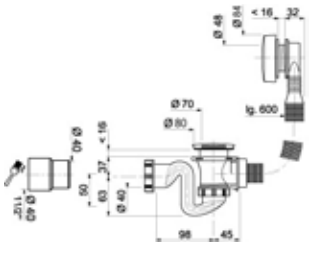
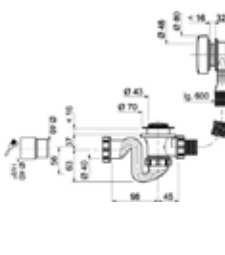
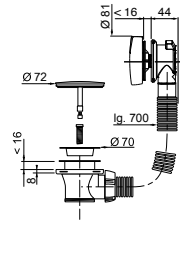
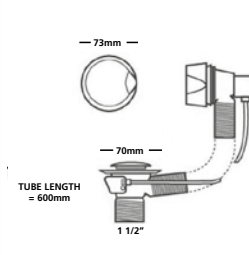
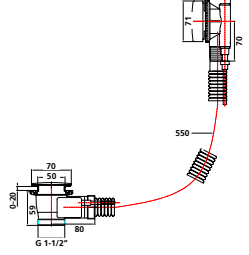

- ▶ Flexible head with 40° movement for easy installation
- ▶ Only 2 connections points – 50% less chance of leak than a traditional 4 joint waste
- ▶ Depth of seal 56mm

CABLE OPERATED



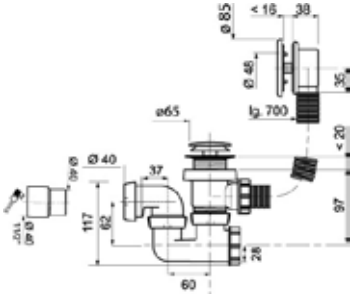
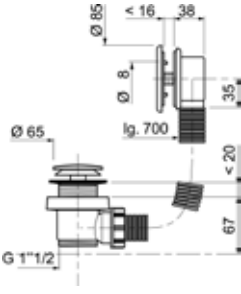
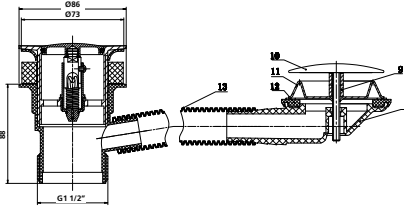
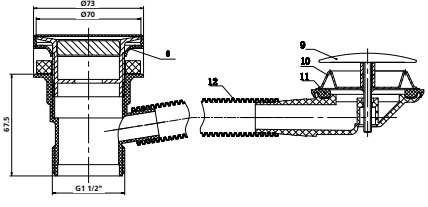

						
DESCRIPTION	SB600		Elton	ABS chrome plated pop up waste with ABS chrome plated overflow	Metal chrome plated pop up waste with brass chrome plated overflow	Metal chrome plated pop up waste with metal chrome plated overflow
REFERENCE	34590302	34590301	30717610	30720414	34480001	30719934
EAN CODE	3375537166046	3375539056215	3375537175901	3375537203390	3375536037958	5017134118995
PACKAGING	Bag	Box	Bag	Bag	Bag	Box
MULTIPLE / BOXED QUANTITY	01/12	01/12	01/12	01/12	01/12	01/24
OVERFLOW LENGTH mm	700 mm		700 mm	700 mm	700 mm	600 mm
HANDLE	Metal Chrome Plated		ABS Chrome Plated	ABS Chrome Plated		Brass Chrome Plated
PLUG	Metal Chrome Plated		Metal Chrome Plated	ABS Chrome Plated		Metal Chrome Plated
TECHNICAL DRAWING						

QUICK CLAC OPERATED

ROTARY OPERATED

				
DESCRIPTION	Quick Clac waste with trap	Quick Clac waste without trap	Quick Clac waste without trap	Rotary waste without trap
REFERENCE	SP760399G	SP760099	WHO95CP	WHO94CP
EAN CODE	33755336010487	3375536003953	5017134118360	5024139033550
PACKAGING	Bag	Bag	Box	Box
MULTIPLE / BOXED QUANTITY	01/30	01/12	01/24	01/24
OVERFLOW LENGTH mm	700 mm	700 mm	700 mm	700 mm
HANDLE	ABS Chrome Plated	ABS Chrome Plated	Metal Chrome Plated	Metal Chrome Plated
PLUG	Stainless Steel Mushroom Plug	Stainless Steel Mushroom Plug	Metal Chrome Plated	Metal Chrome Plated
TECHNICAL DRAWING				

PLUG & CHAIN

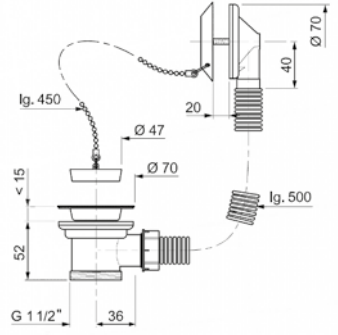
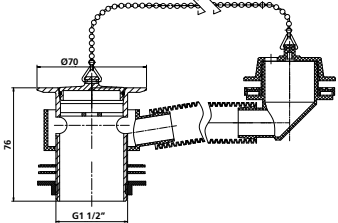
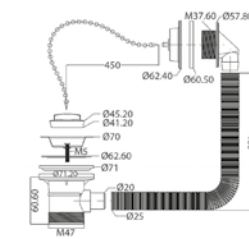
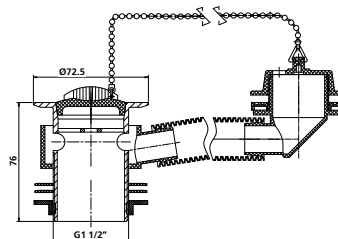
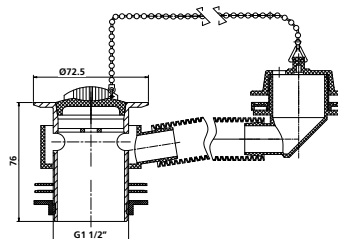
					
DESCRIPTION	Chained bath waste without trap	Chrome plated bath waste, tidi metal plug and overflow face, 18" chain	Chrome plated bath waste, metal plug and plastic overflow face, 18" chain	Chrome plated plastic bodied bath waste with metal plug, 18" ball chain	Chrome plated waste poly plug, and plastic overflow face, 18" chain
REFERENCE	SP5500	WHO01CP	WHO32CP	WHO72CP	WHO31CP
EAN CODE	3375530114211	5024139352057	5024139089991	5024139006127	5024139056108
PACKAGING	Box	Box	Box	Bag	Box
MULTIPLE / BOXED QUANTITY	01/55	01/18	01/18	01/18	01/18
OVERFLOW LENGTH mm	500	460	460	460	460
PLUG	Ø47 mm Length chain = 450 mm	Ø45 mm Length chain = 460 mm	Ø45 mm Length chain = 460 mm	Ø45 mm Length chain = 460 mm	Ø45 mm Length chain = 460 mm
TECHNICAL DRAWING					



**PLUG & CHAIN**

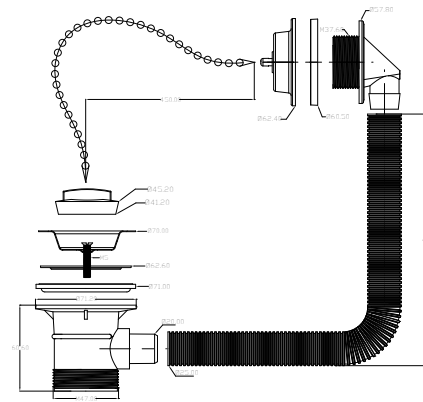

DESCRIPTION	Plastic body waste with poly plug, 18" ball chain and overflow	Plastic body waste with poly plug, 18" ball chain and overflow	Plastic body waste with poly plug, 18" ball chain and overflow, D pack and sold in 20's
REFERENCE	WHO73BA	WHO73SS	WHO74SS
EAN CODE	5024139065933	5024139071743	5024139090201
PACKAGING	Bag	Box	Bag
MULTIPLE / BOXED QUANTITY	01/50	01/30	01/20
OVERFLOW LENGTH mm	455	455	455
PLUG	Ø45 mm Length chain = 460 mm	Ø45 mm Length chain = 460 mm	Ø45 mm Length chain = 460 mm

TECHNICAL DRAWING

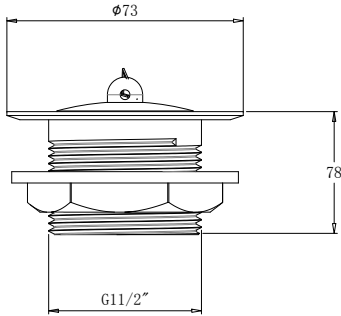
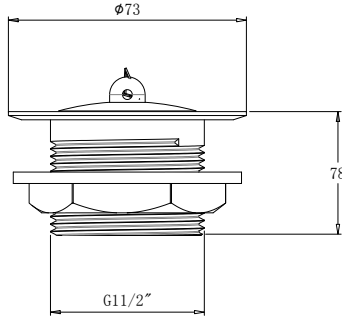
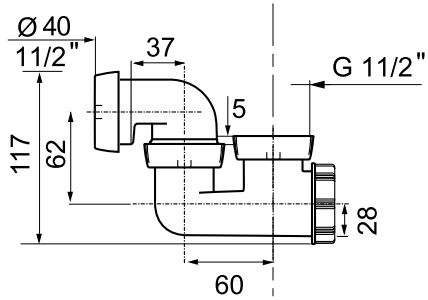

	POLY PLUG & CHAIN WITH METAL BODY		BATH TRAP
			
DESCRIPTION	Chrome plated bath waste, with poly plug, 18" ball chain, S hook, plastic backnut	Chrome plated bath waste, with poly plug only, plastic backnut	SP602 waste trap with swivelling outlet
REFERENCE	WHK03CP	WHS03CP	30717611
EAN CODE	5024139088789	5024139073105	3375537175918
PACKAGING	Box	Box	Bag
MULTIPLE / BOXED QUANTITY	01/60	01/60	01/70
PLUG	Ø45 mm Length chain = 460 mm	Ø45 mm No chain	-
DEPTH OF SEAL mm	-	-	50
FLOW RATE IN L/MN	-	-	54
TECHNICAL DRAWING			

# www.wirquin.co.uk

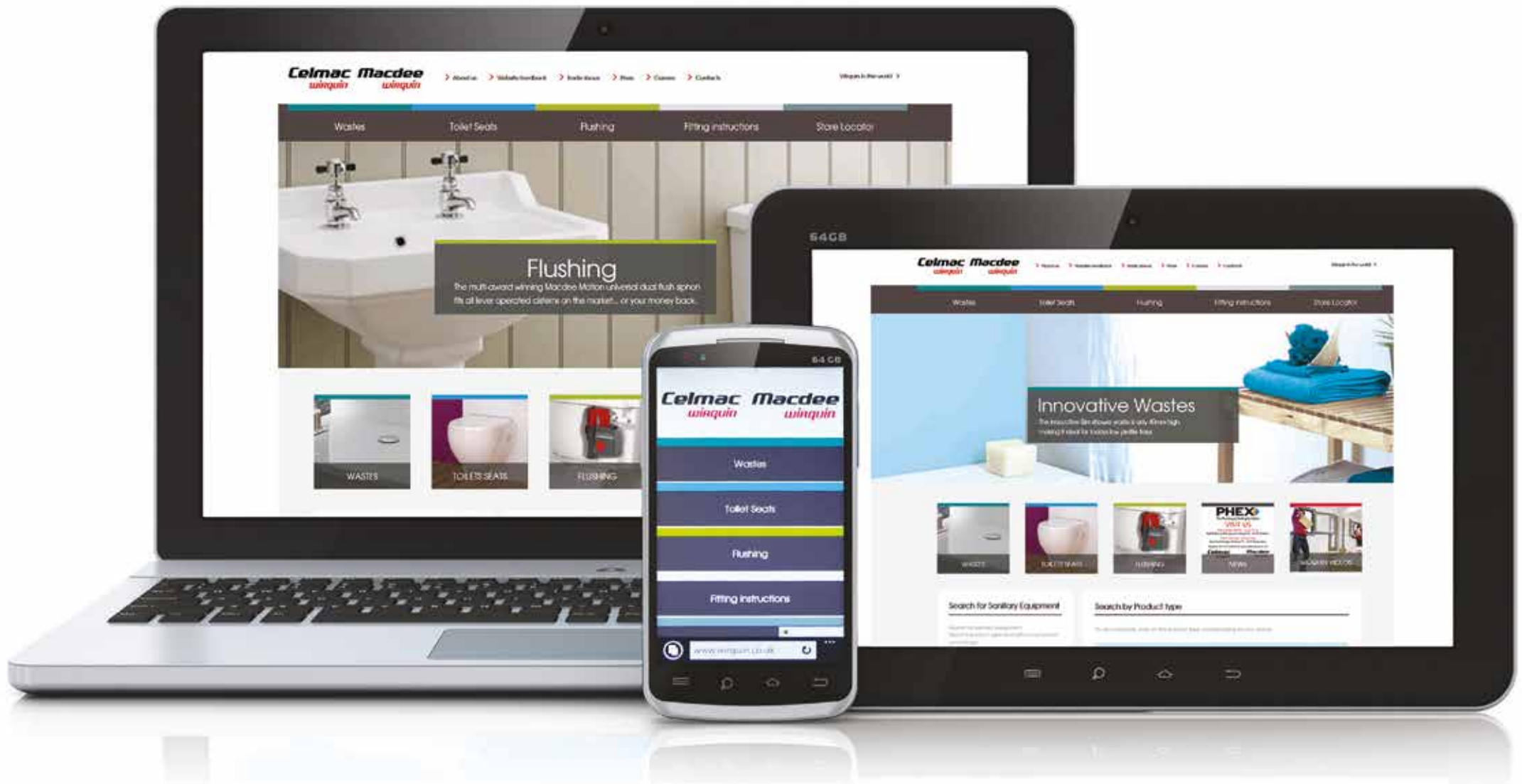



SENZO



Waterless Membrane Trap

- ▶ Extra flat space saving technology
- ▶ Absolute flexibility for easy and quick installation
- ▶ Horizontal or vertical installation
- ▶ Anti-back siphoning

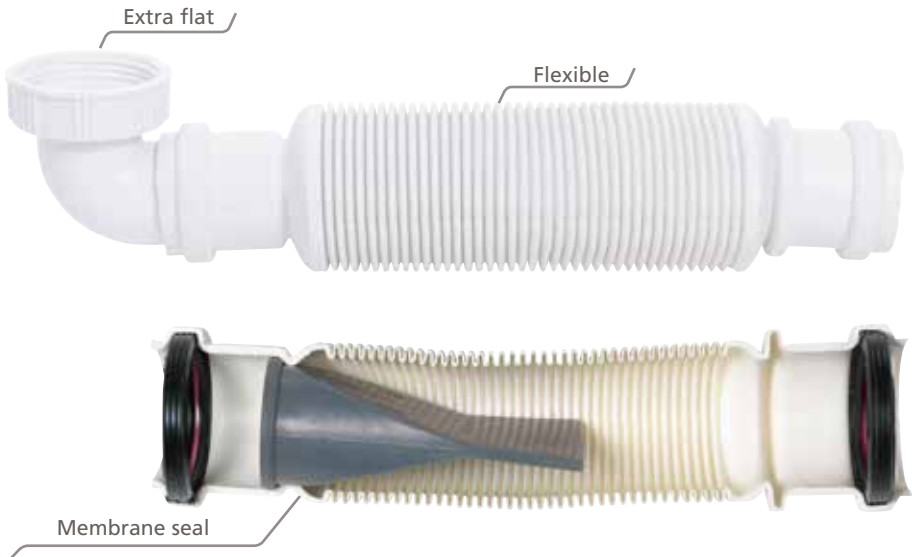

ALL IN ONE BOTTLE TRAP



Universal Bottle Trap

- ▶ All in one outlet: The only universal bottle trap that fits all sink and basin outlets
- ▶ Compact design including the 50mm water seal: Space saving and complies with British regulations
- ▶ Complete solution including the Quick Clac waste: A convenient and modern solution
- ▶ Suitable for 32-43mm push fit



SPACE SAVING TRAPS







DESCRIPTION	Senzo - flexible waterless trap, push fit outlet	Senzo - flexible waterless trap for pedestal installation, push fit outlet	Compact - maleable, double water seal trap
REFERENCE	31560006	30717469*	31980201
EAN CODE	3375537160167	3375537174669	3375539043307
PACKAGING	Bag	Bag	Bag
MULTIPLE / BOXED QUANTITY	01/50	01/35	01/40
DEPTH OF SEAL mm	-	-	2 x 25 mm
FLOW RATE IN L/MN (UNDER 15mm OF WATER)	38 L/mn	70 L/mn in vertical position	38 L/mn
HEIGHT mm	54 mm	231 mm	84 mm
TECHNICAL DRAWING			

\*See Spares & Accessories section for adaptor





**ALL-IN-ONE BOTTLE TRAP**

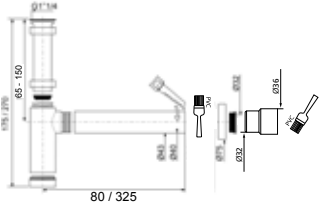
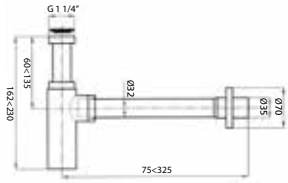
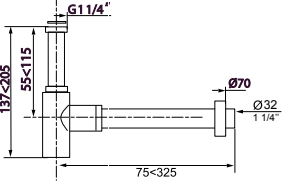
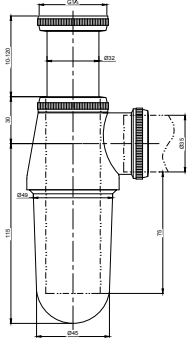
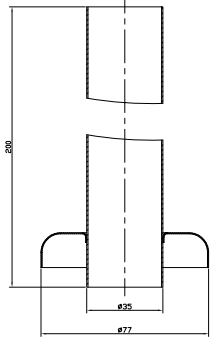

DESCRIPTION	All in one bottle trap	All in one bottle trap with chrome plated Quick Clac plug	All in one bottle trap with white Quick Clac plug and chrome face overflow
REFERENCE	31180002	30717371	30717367
EAN CODE	3375537140435	3375537173730	337537173693
PACKAGING	Bag	Bag	Bag
MULTIPLE / BOXED QUANTITY	01/60	01/36	01/24
DEPTH OF SEAL mm	50 mm	50 mm	50 mm
FLOW RATE IN L/mn (UNDER 15mm OF WATER)	41 L/mn	41 L/mn	41 L/mn
HEIGHT mm	125 < 170 mm	123 < 193 mm	153 < 223 mm
TECHNICAL DRAWING			

	ABS	BRASS			
					
DESCRIPTION	Teos - chrome plated 1 1/4" ABS bottle trap, 75mm waterseal	Lineis - chrome plated 1 1/4" brass bottle trap, 75mm waterseal	Lineis - chrome plated 1 1/4" brass bottle trap	Chrome plated 1 1/4" brass bottle trap	Chrome plated brass extension tube (to suit PBT41CP)
REFERENCE	30120250	30120018	30718070	PBT41CP	PET11CP
EAN CODE	5017134132533	5017134129069	3375537180295	5017134116793	5024139058133
PACKAGING	Bag	Box	Box	Box	Bag
MULTIPLE / BOXED QUANTITY	01/12	01/12	01/12	01/20	01/60
DEPTH OF SEAL mm	75 mm	75 mm	50 mm	75 mm	-
FLOW RATE IN L/MN (UNDER 15mm OF WATER)	42 L/mn	42 L/mn	42 L/mn	40 L/mn	-
HEIGHT mm	185 < 275 mm	162 < 230 mm	137 < 205 mm	160 < 230 mm	200 mm
TECHNICAL DRAWING					



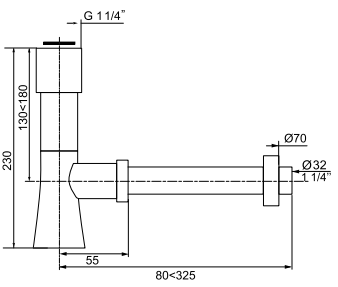
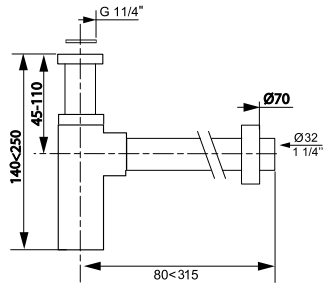
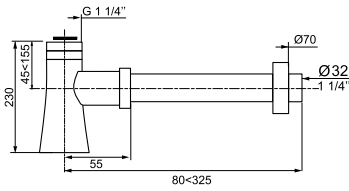
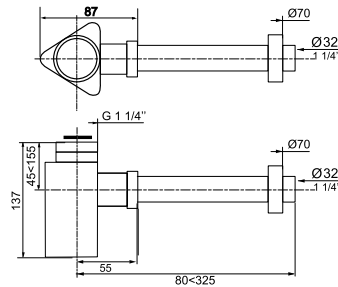
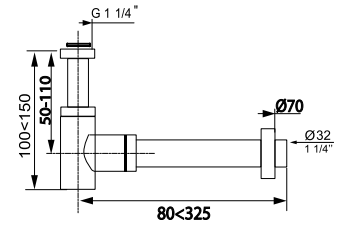

## BRASS

					
DESCRIPTION	Conical - large, chrome plated 1 1/4" brass bottle trap	Caries - chrome plated 1 1/4" square brass bottle trap	Conical - chrome plated 1 1/4" brass bottle trap	Triangular - chrome plated 1 1/4" brass bottle trap	Mini Lineis - chrome plated 1 1/4" brass bottle trap
REFERENCE	30718074	30718069	30718075	30718076	30718071
EAN CODE	3375537180332	3375537180288	3375537180349	3375537180356	3375537180301
PACKAGING	Box	Box	Box	Box	Box
MULTIPLE / BOXED QUANTITY	01/16	01/08	01/12	01/12	01/18
DEPTH OF SEAL mm	50 mm	50 mm	40 mm	40 mm	10 mm
FLOW RATE IN L/MN (UNDER 15mm OF WATER)	55 L/mn	53 L/mn	45 L/mn	45 L/mn	40 L/mn
HEIGHT mm	130 < 180 mm	140 < 250 mm	45 < 155 mm	45 < 155 mm	100 < 150 mm
TECHNICAL DRAWING					



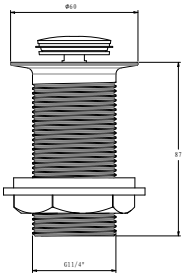
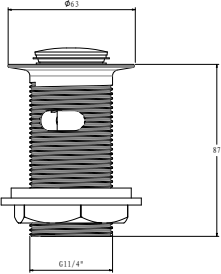
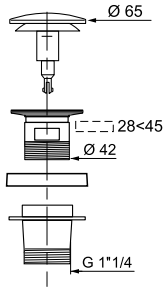
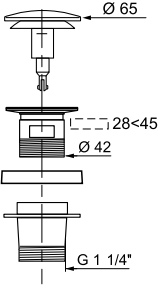

**QUICK CLAC WASTES**

				
DESCRIPTION	Chrome plated, unslotted, mushroom head, metal plated backnut	Chrome plated, slotted, mushroom head, metal plated backnut	Chrome plated, unslotted, mushroom head, plastic backnut	Chrome plated, slotted, mushroom head, plastic backnut
REFERENCE	32140001	32140101	32140301	WBK11CP
EAN CODE	3375539058196	3375537135356	3375537147915	5017134118940
PACKAGING	Box	Box	Box	Box
MULTIPLE / BOXED QUANTITY	01/40	01/40	01/36	01/36
HEIGHT mm	75 mm	75 mm	86 mm	86 mm
TECHNICAL DRAWING				

## QUICK CLAC WASTES

				
DESCRIPTION	Chrome plated unslotted, standard plug, metal backnut	Chrome plated slotted, standard plug, metal backnut	Chrome plated Quick Clac waste with white plastic body and shroud	Chrome plated Quick Clac waste with chrome plated plastic body and shroud
REFERENCE	WBK94CP	WBK95CP	SP50299	32500301
EAN CODE	5024139027207	5024139025371	3375536001690	3375537147915
PACKAGING	Box	Box	Bag	Box
MULTIPLE / BOXED QUANTITY	01/36	01/36	01/84	01/32
HEIGHT mm	87 mm	87 mm	100 mm	100 mm
TECHNICAL DRAWING				

CAPTIVE WASTES

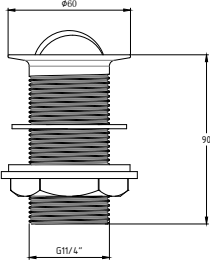
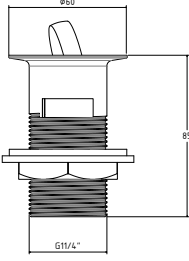
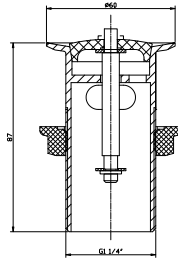
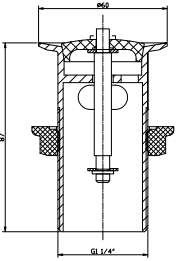
				
DESCRIPTION	Chrome plated, unslotted, rotary metal plug, metal backnut	Chrome plated, slotted, rotary metal plug, metal backnut	Chrome plated, slotted, poly plug with retaining bar, plastic backnut	Chrome plated, slotted, metal plug with retaining bar, plastic backnut
REFERENCE	WBK96CP	WBK97CP	WBS04CP	WBS44CP
EAN CODE	5024139033543	5024139033536	5024139088918	5024139070579
PACKAGING	Box	Box	Box	Box
MULTIPLE / BOXED QUANTITY	01/45	01/45	01/60	01/45
HEIGHT mm	90 mm	85 mm	87 mm	87 mm
TECHNICAL DRAWING				













## FLUSH GRATED WASTES

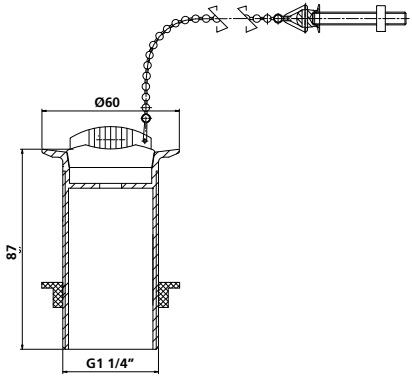
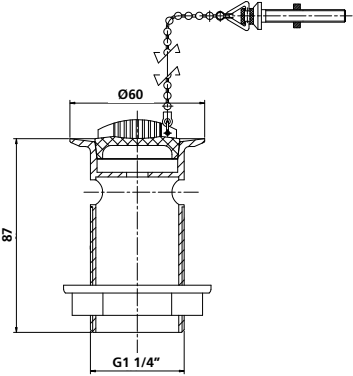
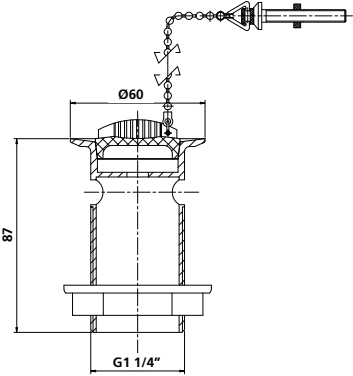
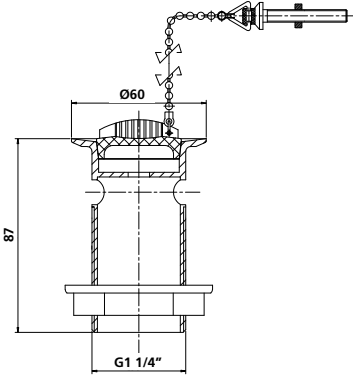

DESCRIPTION	1 1/4" Chrome plated brass, unslotted, plastic backnut	1 1/4" Chrome plated brass, unslotted, metal backnut	1 1/4" Chrome plated brass, slotted, plastic backnut	1 1/4" Chrome plated brass, slotted, metal backnut
REFERENCE	WFS02CP	WFS12CP	WFS03CP	WFS13CP
EAN CODE	5024139093776	5024139063069	5024139087836	5024139074652
PACKAGING	Box	Box	Box	Box
MULTIPLE / BOXED QUANTITY	01/64	01/40	01/64	01/64
HEIGHT mm	85 mm	89 mm	85 mm	89 mm
TECHNICAL DRAWING				

PLUG & CHAIN

				
DESCRIPTION	Chrome plated, unslotted, poly plug, 10" ball chain, plastic backnut	Chrome plated, slotted, poly plug, 10" ball chain, plastic backnut	Chrome plated, slotted, poly plug, 10" ball chain, plastic backnut, 2 washers	Chrome plated slotted with metal 10" ball chain plastic backnut
REFERENCE	WBK01CP	WBK02CP	WBK04CP	WBK42CP
EAN CODE	5024139077677	5024139063960	5024139093936	5024139092663
PACKAGING	Box	Box	Box	Box
MULTIPLE / BOXED QUANTITY	01/60	01/60	01/60	01/60
HEIGHT mm	87 mm	87 mm	87 mm	87 mm
TECHNICAL DRAWING				

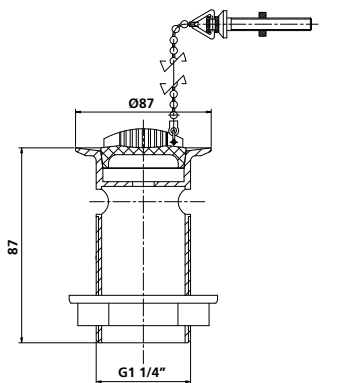
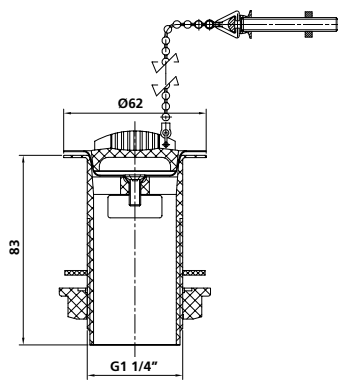
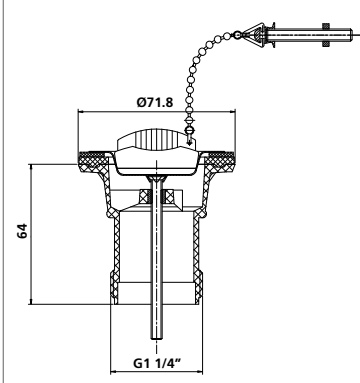
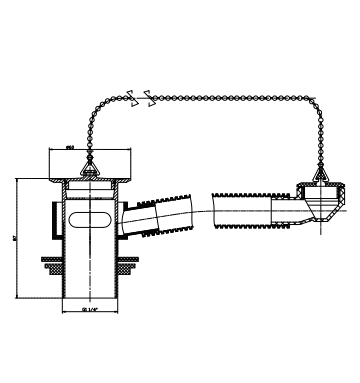
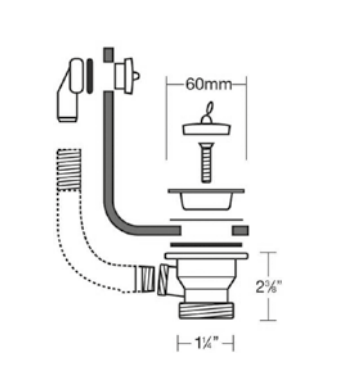
	PLUG & CHAIN			PLUG & CHAIN WITH OVERFLOW	
					
DESCRIPTION	Chrome plated, slotted, poly plug, 10" ball chain, metal backnut	Plastic body, slotted, poly plug, 10" ball chain, plastic backnut	Plastic body, unslotted, poly plug, 10" ball chain, plastic backnut	Chrome plated vanity waste with metal plug, ball chain and overflow	Plastic body basin vanity waste with poly plug, ball chain and overflow
REFERENCE	WBK22CP	WBK83SS	WBK85SS	WBV02CP	WBV21BA
EAN CODE	5024139092380	5024139085825	5024139004758	5024139091680	5024139080448
PACKAGING	Box	Bag	Bag	Box	Bag
MULTIPLE / BOXED QUANTITY	01/52	01/60	01/100	01/32	01/50
OVERFLOW LENGTH mm	-	-	-	230	230
HEIGHT mm	87 mm	83 mm	64 mm	87 mm	61 mm
TECHNICAL DRAWING					

## METAL BODY WASTES



DESCRIPTION	Chrome plated waste, unslotted poly plug, plastic backnut	Chrome plated waste slotted poly plug, plastic backnut	Chrome plated waste, slotted, poly plug, metal backnut
REFERENCE	WBS01CP	WBS02CP	WBS22CP
EAN CODE	5024139074041	5024139096876	5024139061669
PACKAGING	Box	Box	Box
MULTIPLE / BOXED QUANTITY	01/60	01/60	01/60
HEIGHT mm	87 mm	87 mm	89 mm
TECHNICAL DRAWING			

SENZO







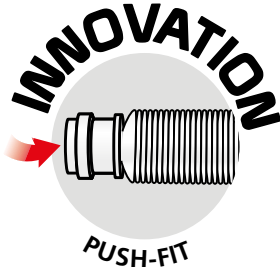



Waterless Membrane Trap

- ▶ Extra flat space saving technology
- ▶ Absolute flexibility for easy and quick installation
- ▶ Horizontal or vertical installation
- ▶ Anti-back siphoning

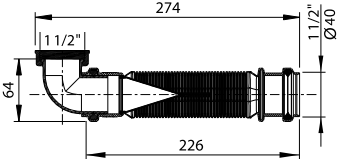
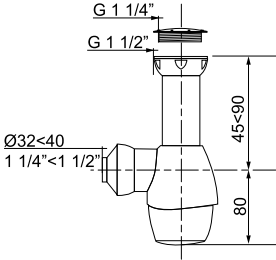
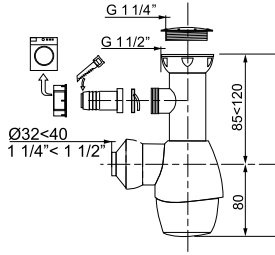
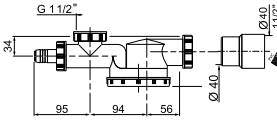
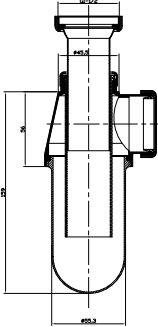

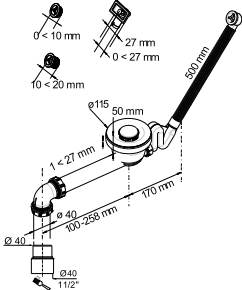
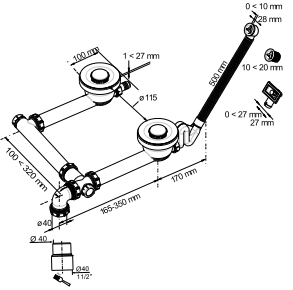
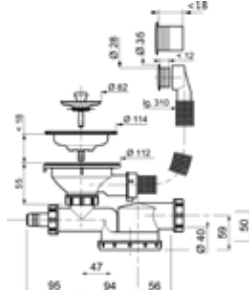
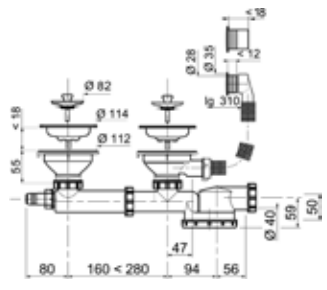

## SPACE SAVING TRAPS

					
DESCRIPTION	Senzo-flexible waterless trap, push fit outlet	All in one bottle trap	All in one bottle trap with washing machine connection	Espace	Chrome plated 1 1/2" brass bottle trap
REFERENCE	31160005	31180002	31190002	31000201	PBT42CP
EAN CODE	3375537160150	3375537140435	3375537140442	3375539056192	5024139089809
PACKAGING	Bag	Bag	Bag	Bag	Box
MULTIPLE / BOXED QUANTITY	01/40	01/60	01/40	01/60	01/20
DEPTH OF SEAL mm	-	50 mm	50 mm	50 mm	75 mm
FLOW RATE IN L/MN	38 L/mn	62 L/mn	62 L/mn	42 L/mn	42 L/mn
HEIGHT mm	64 mm	125 < 170 mm	165 < 200 mm	95 mm	185 < 265 mm
TECHNICAL DRAWING					

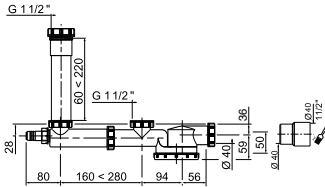
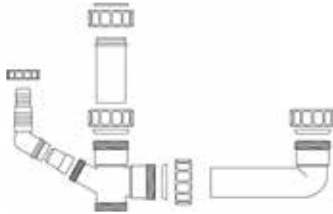
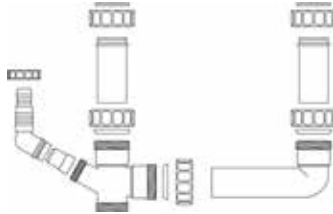

	HOPY	HOPY	ESPACE	ESPACE
				
DESCRIPTION	90mm complete set for single sink, chrome plated face	90mm complete set for double sink, chrome plated face	90mm set for single sink with a chrome plated face, extra flat trap	90mm set for double sink with a chrome plated face, extra flat trap
REFERENCE	30717614	30717615	TM110099	TM210099
EAN CODE	3375537175949	3375537175956	3375536010333	3375536010340
PACKAGING	Bag	Bag	Bag	Bag
MULTIPLE / BOXED QUANTITY	01/20	01/20	01/30	01/20
WASTE	Quick Clac	Quick Clac	Stainless steel basket	Stainless steel basket
OVERFLOW GRID	2 round & 1 rectangular supplied	Round	Round	Round
DEPTH OF SEAL mm	50 mm	50 mm	50 mm	50 mm
FLOW RATE IN L/MN	44 L/mn	44 L/mn	36 L/mn	39 L/mn
HEIGHT UNDER SINK mm	100 mm	100 mm	143 mm	143 mm
CENTRE DISTANCE mm	-	100 < 320 mm	-	160 < 280 mm
TECHNICAL DRAWING				

## UNDERSINK PLUMBING KITS





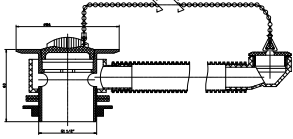
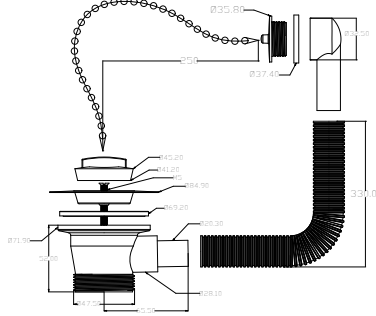

			
DESCRIPTION	Espace for 1 1/2" or 2 bowl sinks with washing machine outlet	One and a half bowl sink with washing machine outlet	Two bowl sink with washing machine outlet
REFERENCE	33000203	WSU0100	WSU0200
EAN CODE	3375539056253	5017134129120	7654321019284
PACKAGING	Bag	Bag	Bag
MULTIPLE / BOXED QUANTITY	1/30	01/10	01/10
CONNECTION FOR	1 1/2 or double sink	1 1/2 or double sink	Double sink
CENTRE DISTANCE mm	160 < 280 mm	110 < 280 mm	110 < 280 mm
TECHNICAL DRAWING			





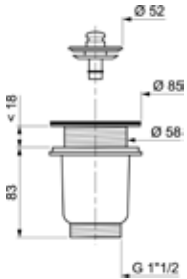
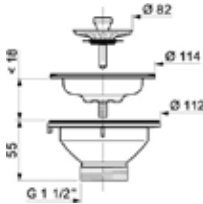
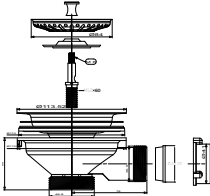
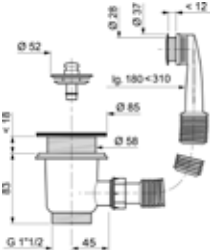
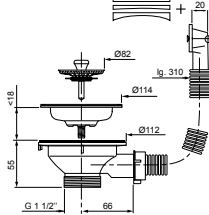
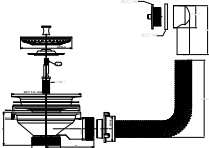

## SINK COMBINATION WASTES

								
DESCRIPTION	1 1/2" Chromed metal waste, poly plug, chromed plastic overflow face	1 1/2" Plastic waste, poly plug, black plastic overflow face	1 1/2" Plastic waste, poly plug, black plastic overflow face	1 1/2" Plastic waste, poly plug, black plastic overflow face, D pack	1 1/2" Plastic waste, poly plug, chromed plastic overflow face	1 1/2" Plastic waste, poly plug, chromed plastic overflow face, D pack	1 1/4" Plastic waste, poly plug, chromed plastic overflow face	
REFERENCE	WSO32CP	WSO33BA	WSO33SS	WSO32SS	WSO51SS	WSO53SS	WSO50SS	
EAN CODE	5024139092946	5024139083999	5024139069603	5024139070043	5024139068842	5024139074843	5024139078223	
PACKAGING	Box	Bag	Box	Bag	Box	Bag	Box	
MULTIPLE / BOXED QUANTITY	01/18	01/50	01/30	01/20	01/30	01/20	01/30	
OVERFLOW LENGTH mm	330 mm	330 mm	330 mm	330 mm	330 mm	330 mm	330 mm	
PLUG	Ø45 mm Length chain = 255 mm	Ø45 mm Length chain = 255 mm	Ø45 mm Length chain = 255 mm	Ø45 mm Length chain = 255 mm	Ø45 mm Length chain = 255 mm	Ø45 mm Length chain = 255 mm	Ø45 mm Length chain = 255 mm	
TECHNICAL DRAWING								

## BASKET STRAINERS

						
DESCRIPTION	Stainless steel basket strainer waste without overflow	Stainless steel basket strainer waste without overflow	Stainless steel basket strainer waste with overflow connection	Stainless steel basket strainer waste with overflow	Stainless steel basket strainer waste with continental overflow	Stainless steel basket strainer waste with overflow
REFERENCE	SP2460050	SP2480050	WSB02SS	SP2470050	32440001	WSB70SS
EAN CODE	3375536019787	3375536019800	5024139064172	3375536019794	3375537128471	5024139058867
PACKAGING	Bag	Bag	Box	Bag	Bag	Box
MULTIPLE / BOXED QUANTITY	01/70	01/60	01/30	01/42	01/65	01/30
SINK SIZE mm	60 mm	90 mm	90 mm	60 mm	90 mm	90 mm
TECHNICAL DRAWING						

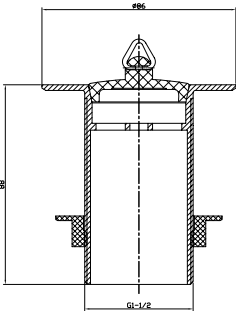
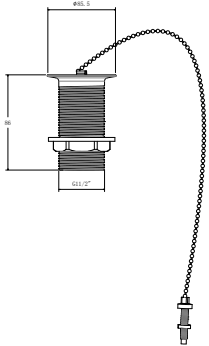
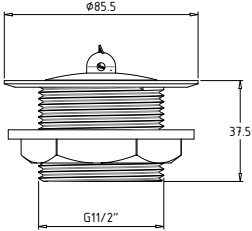
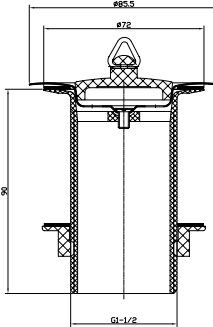
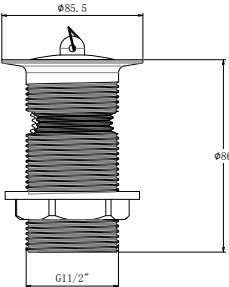
BELFAST SINK					
					
DESCRIPTION	1 1/2" Chrome plated brass, unslotted, poly plug, plastic backnut	1 1/2" Chrome plated brass, unslotted, poly plug, ball and chain, plastic backnut and stay	1 1/2" Chrome plated brass, unslotted, poly plug, plastic backnut	1 1/2" Plastic, unslotted, poly plug, plastic backnut	1 1/2" Chrome plated brass, slotted, poly plug, plastic backnut
REFERENCE	WSS23CP	WSK23CP	WSS21CP	WSS11SS	WSS25CP
EAN CODE	5024139101372	5024139082879	5024139094568	5024139093479	5024139069900
PACKAGING	Box	Box	Box	Box	Box
MULTIPLE / BOXED QUANTITY	01/60	01/36	01/60	01/60	01/36
HEIGHT mm	89	89	89	89	89
TECHNICAL DRAWING					

# www.wirquin.co.uk

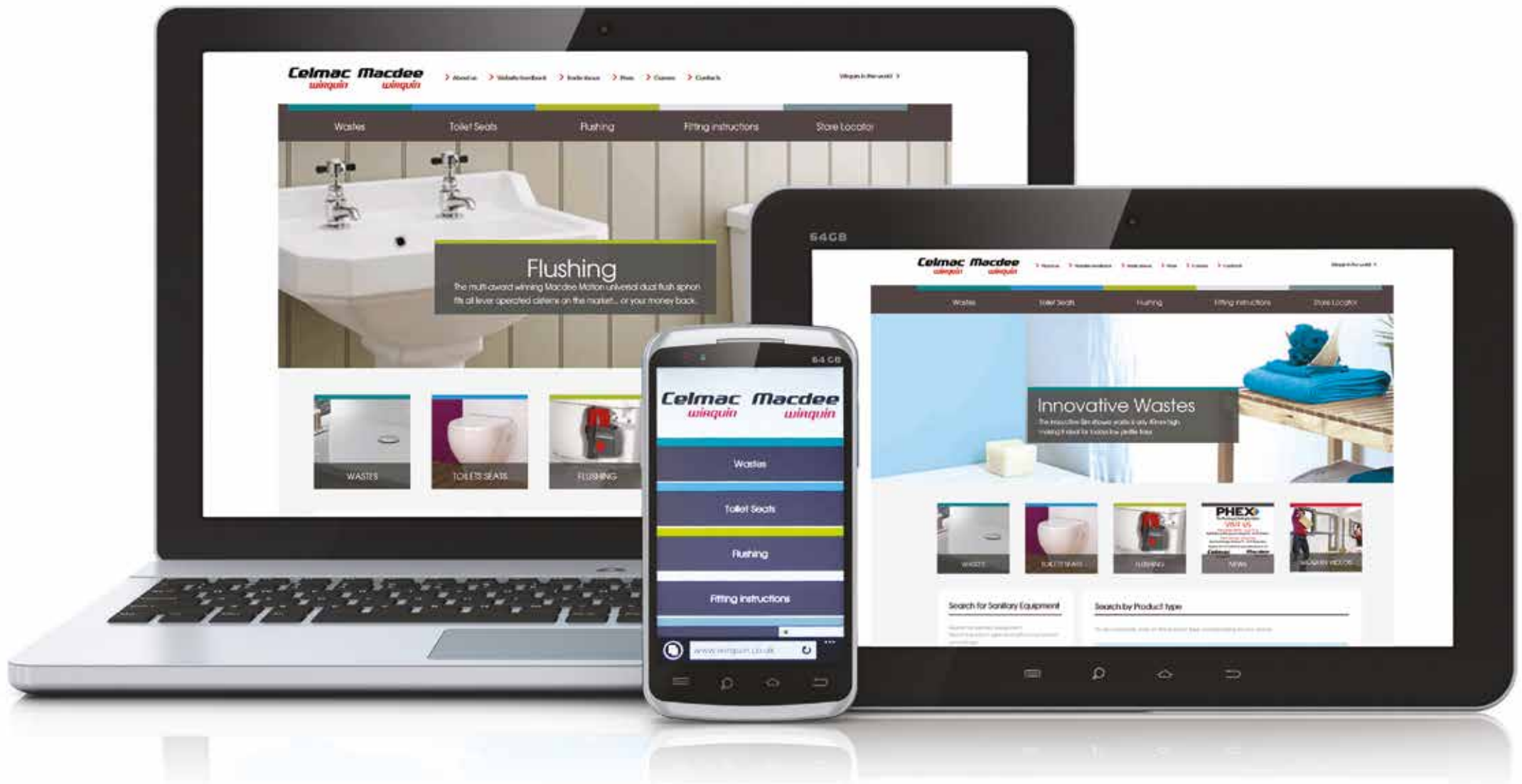

## SHOWER TRAY FEET



### ► 450kg Weight Capacity Shower Tray Feet

- **ROBUST:** Each foot withstands 450kg
- **HEIGHT ADJUSTABLE:** From 58mm – 172mm with height graduation marks for accurate setting
- **STABILITY:** Anti-slip stabilising base for an optimal installation
- **INCREASED SAFETY:** Each foot has four floor fixing points

REFERENCE	30719767
EAN CODE	3375537196944
PACKAGING	Bag
QUANTITY	Pack of 4

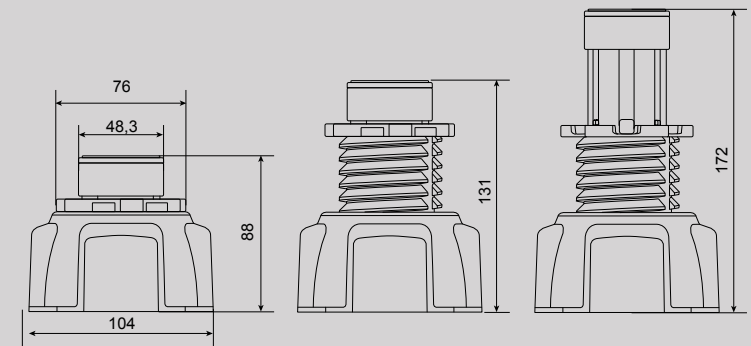

► Easy height adjustment

### ✓ TIP:

By removing the extension leg, the tray can be installed with a minimum height of on 58mm.



ADJUSTABLE FROM 58mm to 172mm



**104mm wide base:** To increase reliability and easy floor installation.

WASTE CONNECTORS





DESCRIPTION	<b>Ø1 1/4" extendable connector X Ø32mm outlet, supplied with fixing hook - 270 to 700mm</b>	<b>Ø1 1/2" extendable connector X Ø40mm outlet, supplied with fixing hook - 270 to 720mm</b>
REFERENCE	73130001	73150001
EAN CODE	3375536033578	3375536033592
PACKAGING	Box	Bag
MULTIPLE / BOXED QUANTITY	01/120	01/100
TECHNICAL DRAWING		

## ADAPTORS

				
DESCRIPTION	Ø40mm to Ø1 1/2" - EU to UK conversion adaptor	Ø32mm to Ø1 1/4" - EU to UK conversion adaptor	Ø40mm - 1 1/2" UK bent compression adaptor	1 1/4" compression adaptor fit for pedestal installations (for vertical drainage)
REFERENCE	39452001	39452002	83114774	30720532
EAN CODE	3375539056208	3375537162970	5024139039934	3375537204557
PACKAGING	Bulk	Bulk	Bag	Bag
MULTIPLE / BOXED QUANTITY	01/440	01/350	01/25	01/25



## CHAINS

			
DESCRIPTION	10" Basin ball chain & stay, chrome	18" Bath ball chain & S hook, chrome	18" Bath oval link chain & S hook, chrome
REFERENCE	QBK01CP	QHK01CP	QHK11CP
EAN CODE	5024139075758	5024139093141	5024139076328
PACKAGING	Bag	Bag	Bag
MULTIPLE / BOXED QUANTITY	01/100	01/500	01/500

## BACKNUTS

				
DESCRIPTION	1 1/4" plastic backnut small flange, black	1 1/4" metal backnut small flange, self colour	1 1/2" metal backnut medium flange, self colour	1 1/2" metal backnut large flange, self colour
REFERENCE	QKD14BL	QKD20SS	QKD23SS	QKD25SS
EAN CODE	5024139054098	5024139074645	5024139060914	5024139092540
PACKAGING	Loose	Loose	Loose	Loose
MULTIPLE / BOXED QUANTITY	01/250	01/250	01/250	01/250

## PLUGS

									
DESCRIPTION	Bath or basin Quick Clac plug, stainless steel	1 3/4" Bath pop up plug, chrome	1 1/4" Basin pop up plug, chrome	1 1/4" Poly plug, black	1 1/4" Metal plug, chrome	1 1/2" Poly plug, black	1 1/2" metal bath and Sink plug, chrome	Tap hole stopper, plastic chrome	Tap hole stopper, plastic white
REFERENCE	SP9260	QHP13CP	QBP13CP	QBP01BL	QBP11CP	QHP01BL	QHP11CP	QTH01CP	QTH01WH
EAN CODE	3375536004745	5024139066343	5024139090676	5024139059239	5024139056948	5024139084804	5024139082114	5024139356222	5024139356253
PACKAGING	Bag	Bag	Bag	Loose	Bag	Loose	Bag	Bag	Bag
MULTIPLE / BOXED QUANTITY	10/240	01/90	01/160	01/1500	01/600	01/500	01/600	01/400	01/400



# WASTE, PIPE & PAN CONNECTORS

## WC PAN CONNECTORS

- JOLLYFLEX EXTENDABLE
- JOLLYFLEX FLEXIBLE
- RIGID
- SHORT CONNECTORS

## MAGICFLEX®

## WASTE CONNECTORS

**Macdee**  
*wirquin*



## WC PAN CONNECTORS



### JOLLYFLEX

The Jollyflex range of flexible and extendable pan connectors has been cleverly designed to make installation easier and faster.

- ▶ Eliminates the need to use two different solid pipes to make a joint
- ▶ Negates the need to cut rigid pipes
- ▶ Removable fins, allowing universal connection (solvent weld and push fit)

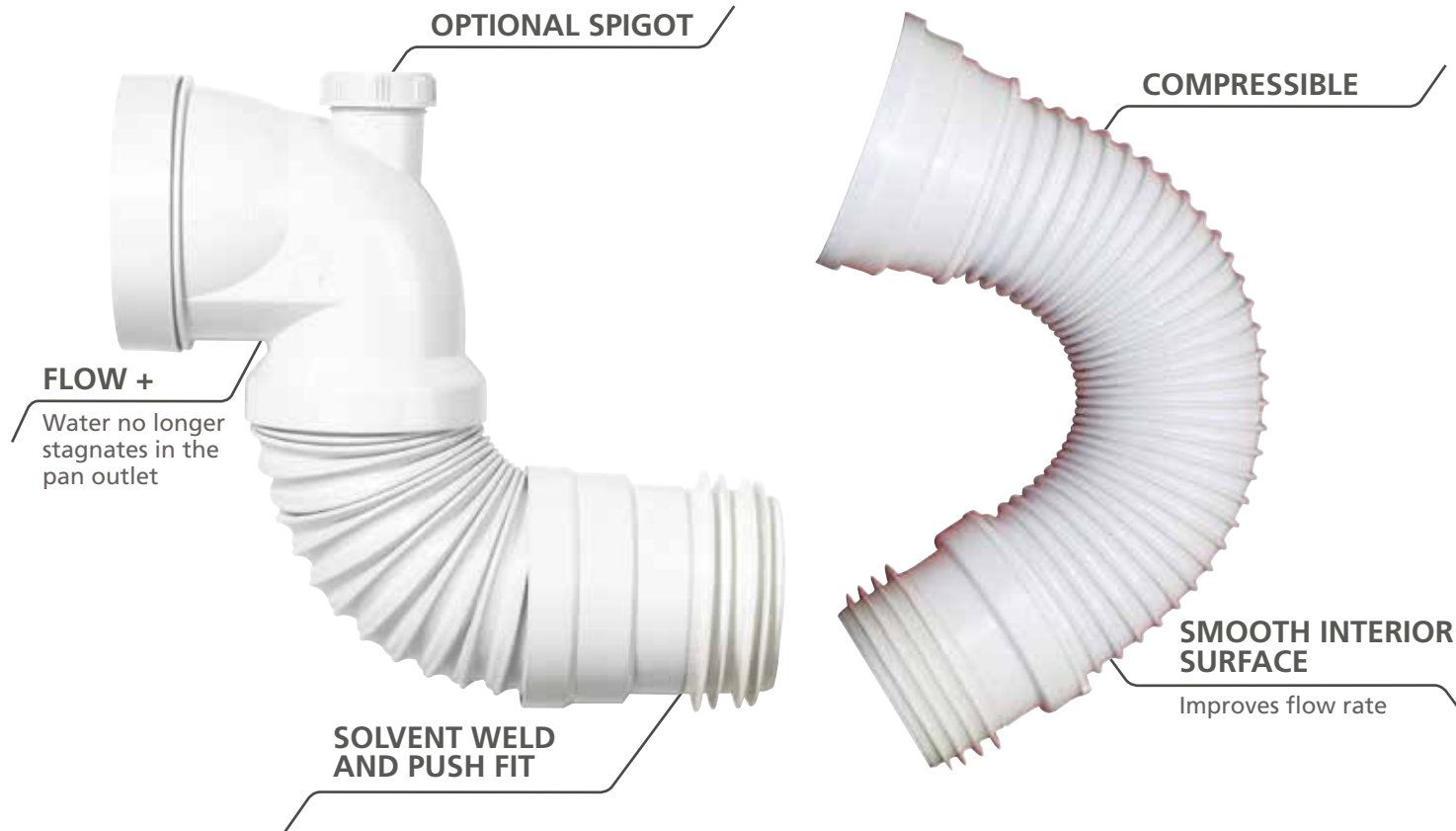

## JOLLYFLEX EXTENDABLE

- ▶ Maintains the desired shape and angle of inclination
- ▶ Provides both an extendable and flexible solution



- ▶ 90° elbow option
  - ▶ Combines the advantages of the extendable and the rigid pan connectors
  - ▶ FLOW + - With its unique internal design, water no longer stagnates in the pan outlet

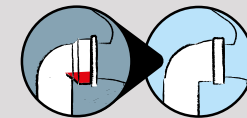





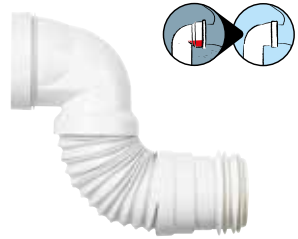
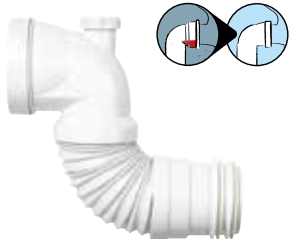

- ▶ Extendable from;
  - ▶ 205mm to 510mm
  - ▶ 290mm to 640mm
  - ▶ 310mm to 780mm

## JOLLYFLEX FLEXIBLE

- ▶ Provides a compressible solution from;
  - ▶ 320mm to 215mm
  - ▶ 390mm to 240mm
  - ▶ 420mm to 280mm
  - ▶ 540mm to 320mm
  - ▶ 580mm to 360mm

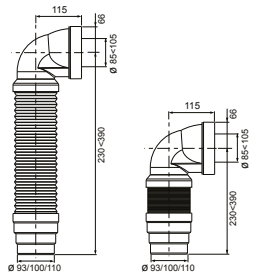
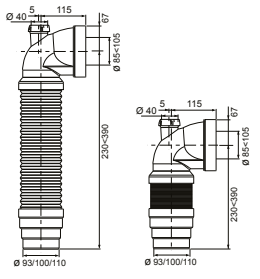
JOLLYFLEX EXTENDABLE

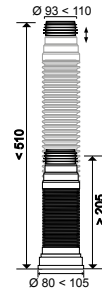
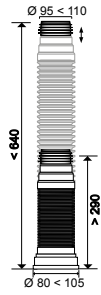





					
DESCRIPTION	90° Extendable elbow pan connector with fin	90° Extendable elbow pan connector with fin and spigot	Extendable pan connector with fin	Extendable pan connector with fin	Extendable pan connector with fin
REFERENCE	70718878	70718879	71260101	71230000	70975042
EAN CODE	3375537188185	3375537188192	3375537142224	3375539070389	4620016492635
PACKAGING	Film	Film	Film	Film	Film
MULTIPLE / BOXED QUANTITY	01/16	01/16	01/16	01/28	01/20
LENGTH mm	230mm < 390mm	230mm < 390mm	310mm < 780mm	205mm < 510mm	290mm < 640mm
PAN OUTLET mm	Ø85 < Ø105	Ø85 < Ø105	Ø80 < Ø105	Ø80 < Ø105	Ø80 < Ø105
DRAIN CONNECTOR mm	Push fit Ø104 < Ø110 Solvent weld Ø93 / Ø100 / Ø110	Push fit Ø104 < Ø110 Solvent weld Ø93 / Ø100 / Ø110	Push fit Ø104 < Ø110 Solvent weld Ø93 / Ø100 / Ø110	Push fit Ø93 < Ø110	Push fit Ø95 < Ø110
TECHNICAL DRAWING					





JOLLYFLEX FLEXIBLE

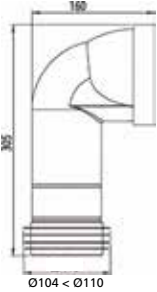
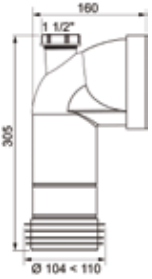
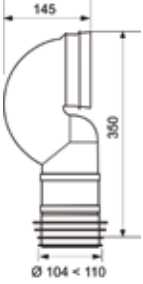
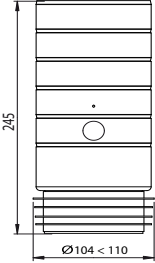
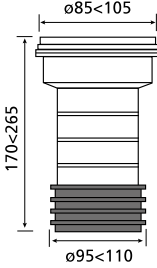
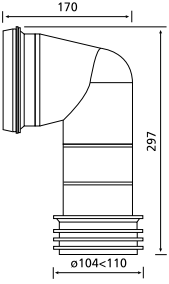

DESCRIPTION	Flexible extra short version - 215 to 320mm	Flexible short version - 240 to 390mm	Flexible long version - 320mm to 540mm	Flexible short version - 240 to 390mm	Flexible long version - 320 to 540mm
REFERENCE	71080201	71080101	71080001	RWAH1099	71000003
EAN CODE	3375539050046	3375536038979	3375536038986	3375530287700	3375536036234
PACKAGING	Film	Film	Film	Film	Film
MULTIPLE / BOXED QUANTITY	01/20	01/15	01/12	01/15	01/12
LENGTH mm	215mm < 320mm	240mm < 390mm	320mm < 540mm	280mm < 420mm	360mm < 580mm
PAN OUTLET mm	Ø80 < Ø105	Ø80 < Ø105	Ø80 < Ø105	Ø80 < Ø105	Ø80 < Ø105
DRAIN CONNECTOR mm	Push fit Ø104 < Ø110	Push fit Ø104 < Ø110	Push fit Ø104 < Ø110	Solvent weld Ø103 / Ø106 / Ø110	Solvent weld Ø103 / Ø106 / Ø110
TECHNICAL DRAWING					

RIGID

						
DESCRIPTION	90° Pan connector with fins	90° Pan connector with fins and spigot	Swan neck pan connector with fins	Pan connector extension piece with fins	Pan connector extension piece with fins	90° Pan connector with fins
REFERENCE	71240001	71240101	71240201	71250001	On Enquiry	70719117
EAN CODE	3375537130672	3375537130689	3375537130696	3375537130702	On Enquiry	5017134106077
PACKAGING	Bulk	Bulk	Bulk	Bulk	Bag	Bag
MULTIPLE / BOXED QUANTITY	01/16	01/20	01/16	01/30	01/30	01/12
LENGTH mm	305mm	305mm	350mm	90mm < 245mm	170mm < 265mm	297mm
PAN OUTLET mm	Ø80 < Ø105	Ø80 < Ø105	Ø85 < Ø105	-	Ø85 < Ø105	Ø85 < Ø110
DRAIN CONNECTOR mm	Push fit Ø104 < Ø110	Push fit Ø104 < Ø110	Push fit Ø104 < Ø110	Push fit Ø104 < Ø110	Push fit Ø95 < Ø110	Push fit Ø104 < Ø110
TECHNICAL DRAWING						

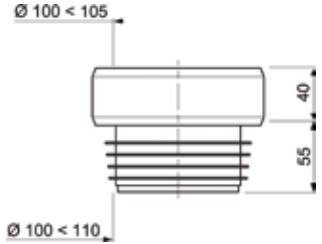
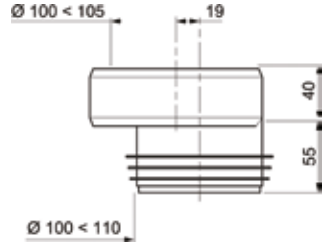
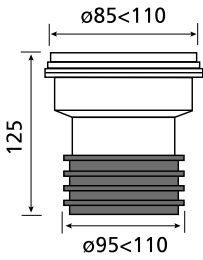
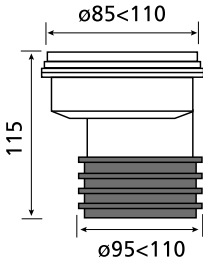
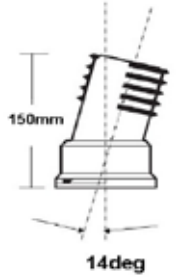
	ONE PIECE		THREE PIECE		
					
DESCRIPTION	Straight pan connector with fins	19mm Offset pan connector with fins	Straight pan connector with fins	20mm Offset pan connector with fins	14° Angled pan connector with fins
REFERENCE	71150000	71160000	70719116	On Enquiry	70719941
EAN CODE	3375536018476	3375536022367	5017138106114	On Enquiry	5017134106091
PACKAGING	Bulk	Bulk	Bag	Box	Bag
MULTIPLE / BOXED QUANTITY	01/60	01/60	01/30	01/50	01/30
LENGTH mm	95mm	95mm	125mm	115mm	150mm
PAN OUTLET mm	Ø100 < Ø105	Ø100 < Ø105	Ø85 < Ø110	Ø85 < Ø110	Ø85 < Ø110
DRAIN CONNECTOR mm	Push fit Ø100 < Ø110	Push fit Ø100 < Ø110	Push fit Ø95 < Ø110	Push fit Ø95 < Ø110	Push fit Ø95 < Ø110
TECHNICAL DRAWING					

PIPE CONNECTORS



MAGICFLEX®

THE FLEXIBLE PVC CONNECTOR

- ▶ **No more angle calculations!**  
Thanks to its flexible structure, it can take on the desired angle from 0° to 180° and on two different levels in the space available.
- ▶ **It can compensate for misalignment between two tubes.**  
It can be compressed for installation on pipes already in place, or in places with difficult access. Its flexible body absorbs contraction and expansion.
- ▶ **Manufactured in PVC, Magicflex® connectors can resist detergents** (bleach, washing-up liquid, washing powder, drain unblocker, etc.)
- ▶ **The same grey colour as used in PVC waste systems, it can be unobtrusively fitted into the installation.**

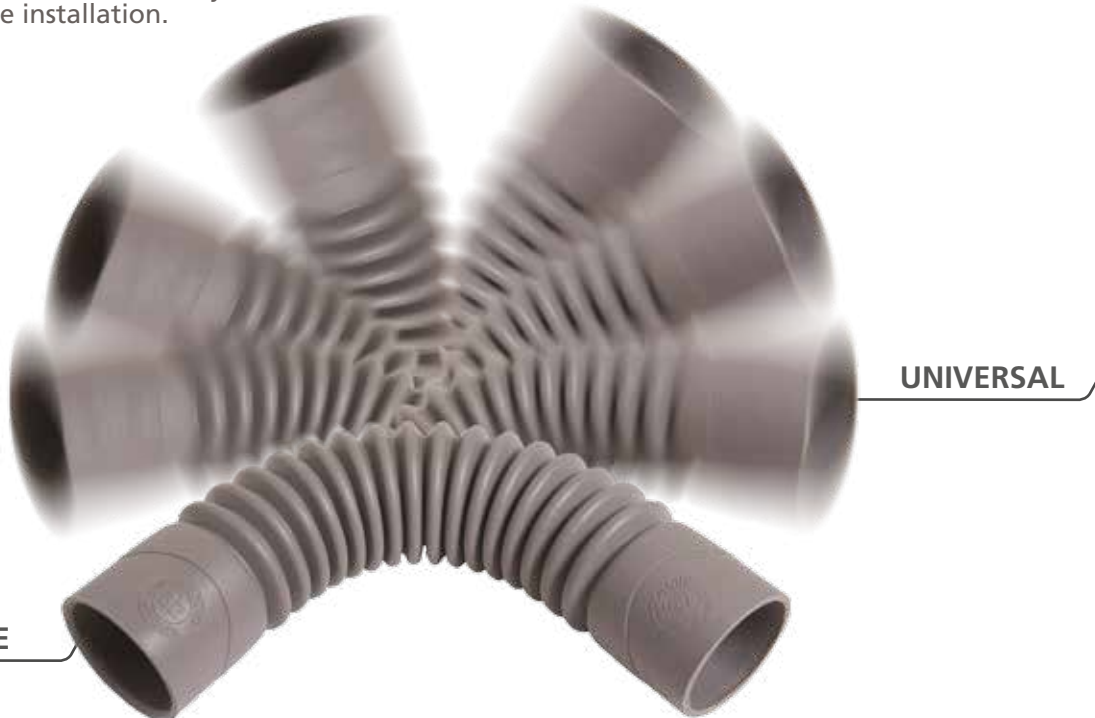
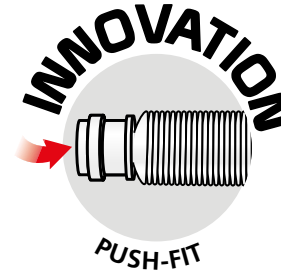





AVAILABLE IN SEVERAL VERSIONS



- ▶ 1 ½" and 1 ¼" solvent weld: Female-Female.
- ▶ 1 ½" and 1 ¼" push-fit: Female-Female.

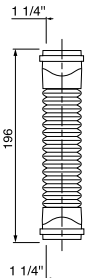
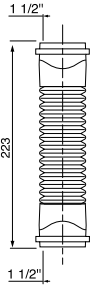
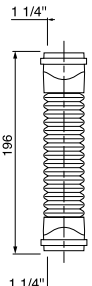
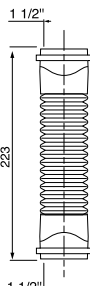
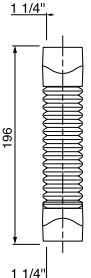
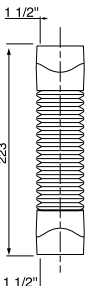
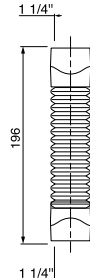
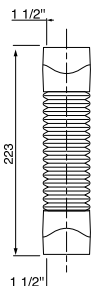
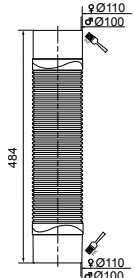

	PUSH FIT				SOLVENT WELD				
									
DESCRIPTION	1 1/4" Flexible elbow, female-female, grey	1 1/2" Flexible elbow, female-female, grey	1 1/4" Flexible elbow, female-female, white	1 1/2" Flexible elbow, female-female, white	1 1/4" Flexible elbow, female-female, white	1 1/2" Flexible elbow, female-female, white	1 1/4" Flexible elbow, female-female, grey	1 1/2" Flexible elbow, female-female, grey	4" Flexible elbow soil pipe, male to female, grey
REFERENCE	79019101	79020101	79019401	79020201	79009007	79008006	79009301	79008301	79007001
EAN CODE	3375539057908	3375539057953	3375537127245	3375537127238	3375539051968	3375539051951	3375537127214	3375537127221	3375539042713
PACKAGING	Bulk	Bulk	Bulk	Bulk	Bulk	Bulk	Bulk	Bulk	Bulk
MULTIPLE / BOXED QUANTITY	10/120	10/70	10/120	10/70	10/150	10/90	10/150	10/90	01/15
DIAMETER	1 1/4"	1 1/2"	1 1/4"	1 1/2"	1 1/4"	1 1/2"	1 1/4"	1 1/2"	Ø100/Ø110
TECHNICAL DRAWING									



WASTE CONNECTORS



DESCRIPTION	<b>Ø1 1/4" extendable connector X Ø32mm outlet, supplied with fixing hook - 270 to 700mm</b>	<b>Ø1 1/2" extendable connector X Ø40mm outlet, supplied with fixing hook - 270 to 720mm</b>
REFERENCE	73130001	73150001
EAN CODE	3375536033578	3375536033592
PACKAGING	Box	Bag
MULTIPLE / BOXED QUANTITY	01/120	01/100
TECHNICAL DRAWING		

# www.wirquin.co.uk

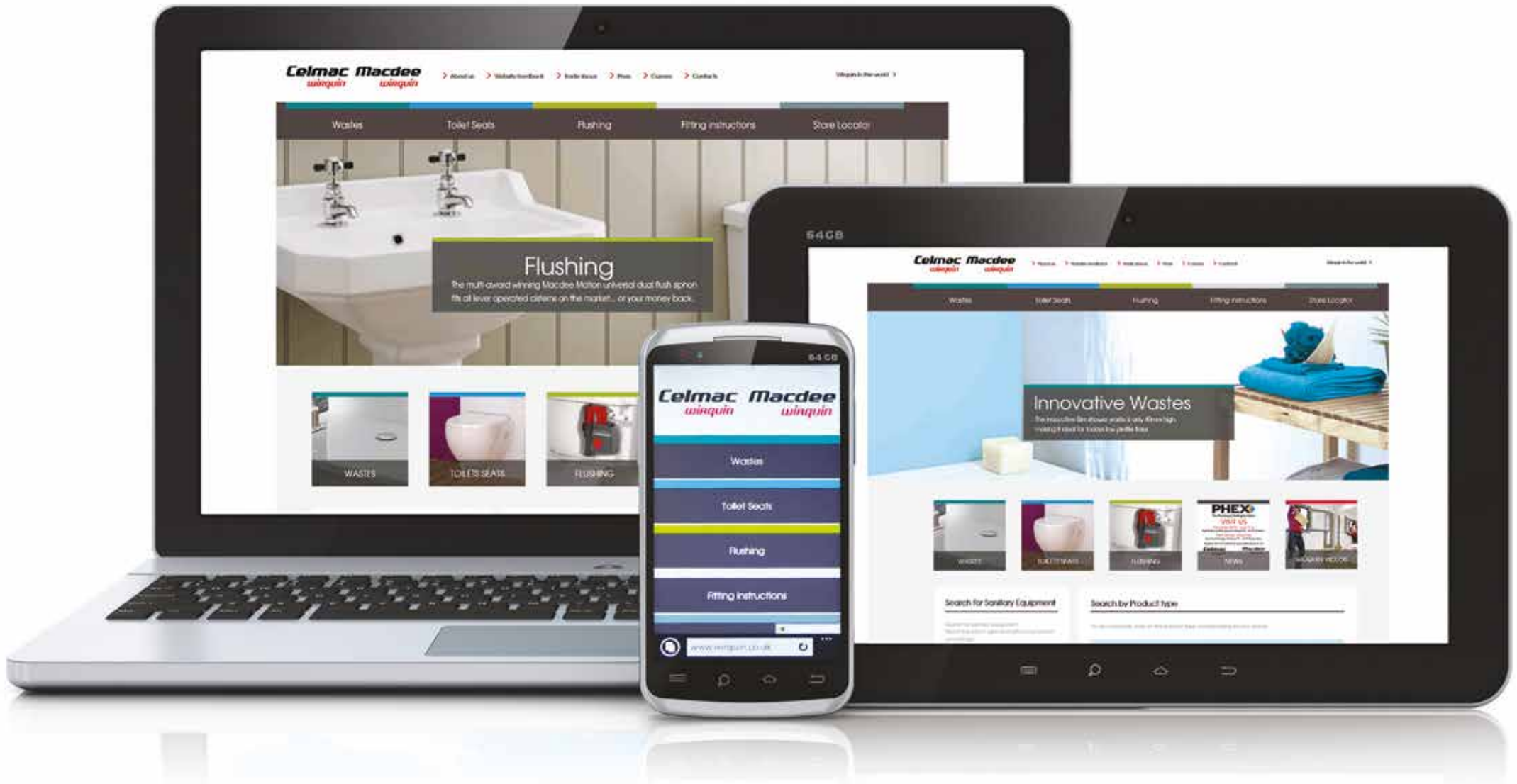

# TERMS & CONDITIONS

## 1. GENERAL

For General Terms & Conditions please refer to our website [www.wirquin.co.uk/legal-notices.html](http://www.wirquin.co.uk/legal-notices.html)

## 2. ELECTRONIC TRADING

- 2.1 If the Company and Customer agree that electronic trading between them shall be a basis for order processing and invoicing then the Standard Interchange Agreement (3rd Edition December 1993 as amended or revised from time to time) of the Electronic Commerce Association (or any successor body or association) shall be incorporated into the contract by reference. If and to the extent of any conflict or inconsistency between these conditions and the Standard Interchange Agreement, the former shall prevail.
- 2.2 Electronic orders shall be valid if all the information agreed between the Customer and the Company as being required is properly set out in the agreed format and the order is transmitted by the Customer to the Company by reference to the correct identification code and is received by the Company when collecting its electronic mail from the relevant system.
- 2.3 Each valid electronic order will be deemed to be accepted by the Company unless the Company communicates rejection of the order to the Customer by electronic or other means (including telephone) within two working days of receipt. Acceptance of an order shall constitute a contract for sale and purchase to which these conditions and the Standard Interchange Agreement shall apply.

## 3. DELIVERY

For General Terms & Conditions please refer to our website [www.wirquin.co.uk/legal-notices.html](http://www.wirquin.co.uk/legal-notices.html)

## 4. RISK AND TITLE

- 4.1 Risk in the Products shall pass to the Customer upon delivery and the Customer is then solely responsible for all loss, damage or deterioration to the Products.
- 4.2 Title to the Products shall not pass to the Customer until either:-
- 4.2.1 The Company has received in full (in cash or cleared funds) all monies payable (whether or not due) to the Company under this and any other contracts for Products once agreed between the Company and the Customer including contracts made after this contract; or
- 4.2.2 when the Company serves on the Customer notice in writing specifying that title in the Products or any part thereof has passed; or
- 4.2.3 the Customer resells the Products, in which case title to the Products shall pass to the Customer at the time specified in clause 4.5.
- 4.3 Until title has passed to the Customer the Company may require the Customer to deliver up to the Company all Products in respect of which the Company has title and if the Customer fails to do so forthwith the Company's officers, employees, representatives or agents shall be entitled to enter upon any premises where such Products are kept for the purpose of recovering the same.
- 4.4 Until title to the Products has passed to the Customer pursuant to these conditions the Customer shall:
- 4.4.1 possess the Products as fiduciary agent and bailee of the Company;
- 4.4.2 store the Products separately from all other goods held by the Customer not owned by the Company;
- 4.4.3 maintain the Products in satisfactory condition and ensure that they are fully insured on an all risks basis for their full price from the date of delivery;

- 4.4.4 ensure that the Products are clearly identifiable as belonging to the Company;
- 4.4.5 not remove, deface or obscure any identifying mark or packaging on or relating to the Products;
- 4.4.6 give the Company such information relating to the Products as the Company may require from time to time;
- 4.4.7 notify the Company immediately if it becomes subject to any of the events listed in clause 16; and
- 4.4.8 permit the Company to enter upon any premises where such Products are kept for the purpose of satisfying itself that this condition is being complied with by the Customer.
- 4.5 Subject to clause 4.6, the Customer may resell or use the Products in the ordinary course of its business (but not otherwise) before the Company receives payment for the Products. However, if the Customer resells the Products before that time:
- 4.5.1 it does so as principal and not as the Company's agent; and
- 4.5.2 title to the Products shall pass from the Company to the Customer immediately before the time at which resale by the Customer occurs.
- 4.6 If before title to the Products passes to the Customer the Customer becomes subject to any of the events listed in clause 16, then, without limiting any other right or remedy the Company may have:
- 4.6.1 the Customer's right to resell the Products or use them in the ordinary course of its business ceases immediately; and
- 4.6.2 the Company may at any time:
- 4.6.2.1 require the Customer to deliver up all Products in its possession which have not been resold, or irrevocably incorporated into another product; and
- 4.6.2.2 if the Customer fails to do so promptly, enter any premises of the Customer or of any third party where the Products are stored in order to recover them.

## 5. CANCELLATION AND AMENDMENT

No contract can be amended or cancelled except with the Company's approval in writing and should such approval be given the Customer shall indemnify the Company against any costs losses or expenses resulting from any cancellation or amendment.

## 6. PRICES

- 6.1 The price of the Products shall be the price set out in the Company's most up to date price list.
- 6.2 Unless otherwise agreed in writing all prices are net for delivery (ex-works) and VAT and any other applicable taxes are payable in addition.
- 6.3 Unless otherwise stipulated by the Company in writing prices are payable in Sterling or if the Sterling currency shall cease to exist when the contract is made, shall be payable in such currency as replaces the Sterling currency.
- 6.4 The Company shall be entitled at any time by giving notice in writing, before delivery to make a reasonable adjustment to the price in the event of any alteration in quantity, design or specification requested by the Customer.
- 6.5 The Company reserves the right at any time prior to delivery by giving notice in writing to increase the price if:
- 6.5.1 there is any increase in the cost of materials labour transport or utilities or if the costs of the Company are increased by any other factor beyond the reasonable control of the Company (including but not limited to foreign exchange fluctuations, increases in taxes and duties); or
- 6.5.2 there is any delay caused by any instructions of the Customer or failure of the Customer to give the Company adequate or accurate information or instructions.

6.6 The Customer shall be liable to the Company for any demurrage costs incurred in the event of vehicles being unduly delayed at the point of delivery.

## 7 TERMS OF PAYMENT

7.1 Unless otherwise agreed by the Company in writing payment shall be made within 30 days from the date of invoice and the Company shall be entitled to issue invoices in the month in which the Products are delivered or would have been delivered save for postponement otherwise then due to default on the part of the Company. Time for payment of the price is of the essence of the contract.

7.2 No disputes arising under this contract (or any other contract between the Company and the Customer) shall serve to permit payment by the Customer of sums due to the Company to be delayed nor shall such disputes interfere with or prevent the Customer from making prompt payment in full and cleared funds. The Customer shall not be entitled to make any deduction from sums owing to the Company by reason of any such dispute.

7.3 In the event of default in payment by the Customer the Company shall be entitled without prejudice to any other right or remedy:

7.3.1 to immediately suspend without notice all further deliveries on this or any other contracts between the Company and the Customer; and/or

7.3.2 to charge interest on a daily basis from the due date until actual payment (after as well as before judgement) on any amount outstanding at the rate of 4% per annum above the base rate of HSBC Bank plc from time to time; and/or

7.3.3 to serve notice on the Customer requiring immediate payment for all Products supplied by the Company under this and all other contracts between them whether or not payment is otherwise due or invoiced.

7.4 The Company reserves the right to request a financial guarantee in respect of any order placed by a Customer and the Company may at its option delay or refuse any such order until an acceptable form of guarantee is provided by the Customer.

## 8 SPECIFICATIONS

For General Terms & Conditions please refer to our website [www.wirquin.co.uk/legal-notices.html](http://www.wirquin.co.uk/legal-notices.html)

## 9 LOSS SHORTAGES AND DAMAGE APPARENT ON DELIVERY INSPECTIONS

9.1 The Customer shall have no claim for loss, shortages or damage on delivery which are or would be apparent on inspection unless the Customer:

9.1.1 Unpacks and inspects the Products as soon as reasonably practicable following receipt;

9.1.2 notifies the Company of any loss, shortages or damage (otherwise then by a qualified signature on the delivery note) within 48 hours of receipt; and

9.1.3 demonstrates to the satisfaction of the Company that such loss, shortages or damage occurred prior to delivery.

9.2 The Customer shall have no rights in respect of loss, shortages or damage unless the Company is given reasonable opportunity to inspect the Products and investigate any complaint before any use of or alteration to or interference with the Products.

9.3 On a valid complaint made in accordance with this Clause 9 the Customer shall be entitled (in the case of notified shortages) to receive within a reasonable time a delivery of Products equivalent to the shortfall and (in the case of defects) the Company at its option shall repair, replace or provide a credit for the price of the affected Products but the Company shall have no further liability whatsoever. If a complaint of loss, shortages or damage on delivery is not made to the Company in accordance with this Clause 9 then the Products shall be deemed to be delivered complete and undamaged in accordance with the contract and the Customer shall be bound to pay for the same accordingly.

9.4 Loss, shortages or damage in a delivery or any instalment delivery shall not be a ground for termination by the Customer of the contract or the remainder of the contract (as the case may be).

## 10 WARRANTY

For General Terms & Conditions please refer to our website [www.wirquin.co.uk/legal-notices.html](http://www.wirquin.co.uk/legal-notices.html)

## 11 LIABILITY

11.1 The Company does not limit or exclude its liability under these conditions for:

11.1.1 breach of the terms implied under Section 12 of the Sale of Goods Act 1979 (good title) (as amended by the Sale and Supply of Goods Act 1994);

11.1.2 death or personal injury caused by its negligence or the negligence of its employees, agents or subcontractors (as applicable) as defined in the Unfair Contract Terms Act 1977;

11.1.3 fraud or fraudulent misrepresentation;

11.1.4 defective products under the Consumer Protection Act 1987; or

11.1.5 any matter in respect of which it would be unlawful for the Company to exclude or restrict liability.

11.2 Save as provided under Clauses 9, 10 and 11.1;

11.2.1 the Company shall have no liability to the Customer;

11.2.2 the Company's total liability, whether in respect of one claim or in the aggregate shall not exceed the contract price payable under this contract for the supply of Products to be provided under it.

11.3 The Customer acknowledges that the limitation of the Company's liability is reasonable in all the circumstances and the Customer agrees that it is its own responsibility to insure adequately to cover any loss or damage in excess of the aforesaid limit of the Company's liability. Subject to reaching agreement on terms, the Company and the Customer may determine an increased level of liability which is to be accepted in Writing by the Company to cover, in particular specific types of loss or damage which both parties reasonably foresee and anticipate.

11.4 In this clause 11 the term "liability" means any form of liability or loss whatsoever including but not limited to loss whether in misrepresentation under contract, common law, equity, tort and any breach of statutory provision whether or not based on negligence or breach of any express or implied duty, or otherwise for any loss other than strictly direct losses (meaning for these purposes the increased costs of purchasing products from a third party or the cost of remedial repair work) and specifically consequential, financial or economic loss whether direct or indirect including but not limited to any incidental costs of dismantling, fitting or other ancillary work required in connection with the provision of a repair or replacement, any loss of production, profits, contracts, loss of use or anticipated savings and any claims made against the Customer by any third party are excluded.

11.5 To the extent that any liability of the Company is expressed to be limited or excluded by these conditions the Customer shall indemnify the Company in respect thereof.

## 12 CONFIDENTIAL INFORMATION ETC

For General Terms & Conditions please refer to our website [www.wirquin.co.uk/legal-notices.html](http://www.wirquin.co.uk/legal-notices.html)

## 13 INTELLECTUAL PROPERTY INDEMNITIES

For General Terms & Conditions please refer to our website [www.wirquin.co.uk/legal-notices.html](http://www.wirquin.co.uk/legal-notices.html)

## 14 CUSTOMER'S DRAWINGS

For General Terms & Conditions please refer to our website [www.wirquin.co.uk/legal-notices.html](http://www.wirquin.co.uk/legal-notices.html)

## 15 COMPANY LITERATURE

The information contained in the advertising, sales, samples, technical and other descriptive literature issued by the Company including any illustrations performance details, examples or installations and methods of assembly and all other information and data in such literature are based on experience and upon trials under test conditions and are approximate and provided for general guidance only. No such information or data shall form part of the contract unless it is specifically referred to in the quotation or order acknowledgement or the Customer shall have complied in respect thereof with Clause 1.11.

## 16 TERMINATION

- 16.1 Without prejudice to any other rights or remedies of the Company, the Company shall be entitled in any of the following circumstances to terminate (in whole or in part) with immediate effect by giving written notice of this and any other contract whenever made between the Company and the Customer and/or to suspend deliveries and/or to receive upon demand payment of all monies payable under any such contracts whether or not otherwise due:
- 16.1.1 the Customer makes or proposes any voluntary arrangement with its creditors or enters into negotiation with its creditors with a view to rescheduling its debts;
  - 16.1.2 the Customer becomes subject to an administration order or an application is made to court or becomes bankrupt or goes into liquidation;
  - 16.1.3 a creditor or an encumbrancer of the Customer takes possession or a receiver is appointed (or a person is able to appoint a receiver) of the whole or any part of the property or assets of the Customer;
  - 16.1.4 the Customer suspends, or threatens to suspend, payment of its debts, or becomes unable to satisfy its debts as they fall due, or is deemed unable to pay its debts within the meaning of the Insolvency Act 1986;
  - 16.1.5 the Customer ceases, suspends or threatens to cease or suspend to carry on all or a substantial part of its business;
  - 16.1.6 a petition is filed, a notice is given, a resolution is passed, or an order is made, for or in connection with the winding up of the Customer;
  - 16.1.7 the Company reasonably believes that any of the events mentioned above or any equivalent or similar event under any relevant laws in any other jurisdiction to which the Customer or any connected person is subject has or may occur;
  - 16.1.8 the Customer or any connected person commits any breach of this or any other contract whenever made between the Customer and the Company; or
  - 16.1.9 if the Customer fails to pay any amount due under this Contract on the due date for payment.
- 16.2 On termination of the Contract for any reason the Customer shall immediately pay to the Company all of the Company's outstanding unpaid invoices and interest.
- 16.3 Termination of the Contract, however arising, shall not affect any of the parties' rights, remedies, obligations and liabilities that have accrued as at termination.

## 17 FORCE MAJEURE

For General Terms & Conditions please refer to our website [www.wirquin.co.uk/legal-notices.html](http://www.wirquin.co.uk/legal-notices.html)

## 18 TOOLS

For General Terms & Conditions please refer to our website [www.wirquin.co.uk/legal-notices.html](http://www.wirquin.co.uk/legal-notices.html)

## 19 CONSUMER PROTECTION ACT 1987

For General Terms & Conditions please refer to our website [www.wirquin.co.uk/legal-notices.html](http://www.wirquin.co.uk/legal-notices.html)

## 20 HEALTH & SAFETY

For General Terms & Conditions please refer to our website [www.wirquin.co.uk/legal-notices.html](http://www.wirquin.co.uk/legal-notices.html)

## 21 NOTICES

For General Terms & Conditions please refer to our website [www.wirquin.co.uk/legal-notices.html](http://www.wirquin.co.uk/legal-notices.html)

## 22 GENERAL (LAW AND JURISDICTION)

The contract shall be governed and interpreted exclusively according to the Laws of England.

For General Terms & Conditions please refer to our website [www.wirquin.co.uk/legal-notices.html](http://www.wirquin.co.uk/legal-notices.html)

May 2016



# *wirquin*

WIRQUIN LTD  
Warmsworth Halt Industrial Estate  
Warmsworth  
Doncaster  
DN4 9LS  
UK

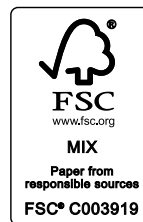

Descriptions and illustrations contained in this catalogue are produced for the sole purpose of giving an approximate indication of the nature of the products to which they refer. They shall not form part of any contract nor have any contractual force. We also reserve the right to modify products and specifications at any time without notice.

sales@wirquin.co.uk [www.wirquin.co.uk](http://www.wirquin.co.uk)

