

Oil-fired boilers



Your heating and hot water in safe hands.

Discover more with Worcester.



A boiler is at the heart of the home...

This brochure will help you make all the right choices for comfort and warmth to reliably meet your needs both now and into the future.

Why choose Worcester?	4-5
Heating and hot water: the key facts.	6-9
ErP labelling.	11
Which heating and hot water system is best for me and my lifestyle?	13-17
Greenstar combi boilers.	19-21
Greenstar system boilers.	22-25
Greenstar regular boilers.	27-29
Greenstore hot water storage.	31
Worcester – keeping you in control.	32-34
Worcester controls range.	35-37
Greenstar external boilers.	38
Keeping your system working efficiently.	40-41
How to get a Worcester boiler installed in your home.	42
Worcester – supporting you from the start.	44-45
Other technologies from Worcester for your home.	46-47
Other products from Bosch.	49
Comparison tables and technical information.	50-51

***“They have great build quality,
good aftersales support and
they’re easy to install.”***

Which? 2015/2016 Survey



By Appointment to
Her Majesty The Queen
Boiler Manufacturer
Worcester, Bosch Group
T/A Bosch Thermotechnology Ltd.
Worcester

A percentage of the profits made by Worcester is donated to charities and good causes by the Robert Bosch Foundation, a non-profit charitable trust which owns 92% of the Bosch Group.



Why should Worcester be your next boiler choice?

Worcester is the choice for millions of quality and value focused homeowners. In a recent Worcester customer satisfaction survey it has been revealed that we are also the choice of professional tradesmen too, with 9 out of 10 heating engineers choosing Worcester to provide warmth and hot water for their homes and families.

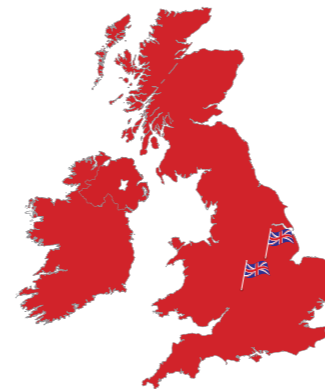

UK based and proud

Dedicated manufacturing plants in Worcester and Clay Cross, Derbyshire.



50 years and counting

Manufacturing to the highest standards for over 50 years.



Part of the Bosch Group

All Worcester products are manufactured with Bosch levels of quality and reliability as standard.



Experts in every field

From design to manufacture, everyone at Worcester is an expert in their particular field.

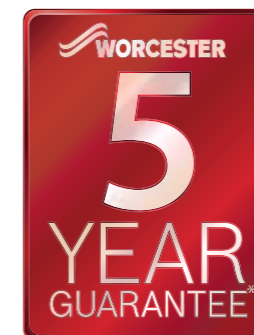

5 year guarantee

Every Greenstar boiler is currently guaranteed for 5 years as standard*.



Royal Warrant

We are honoured to have received a Royal Warrant in recognition of supplying goods to Her Majesty The Queen.

* Terms and conditions apply.

In the last few years, new boiler technology has made a huge difference. Old boilers can be as little as 60% efficient, whilst condensing boilers can achieve over 90% efficiency, helping you to reduce fuel bills.

Heating and hot water: the key facts.

Most of us think of central heating as a modern invention but it in fact dates back to a warm air system developed in Roman times. It wasn't until the 1960s, however, that central heating fired by a boiler started to take off and by the early 1980s it was regarded as a basic requirement for UK homes.

Boilers have come a very long way since then. Advances in technology and changes to regulations mean that they are now far more energy-efficient and are much more suited to a variety of homes and lifestyles.

A leap in efficiency

Given that boilers account for about 60%* of a household's annual energy costs, how efficient they are has a big effect on bills. With older oil boilers, a considerable amount of heat that could be used to generate heating and hot water is lost. Generally the older they are, the more heat they lose, making them increasingly expensive to run.

Some very old boilers can only achieve 60% efficiency and even relatively newer ones are only 70-75% efficient, which means that as much as 30%* of your heating and hot water fuel requirement

could be wasted. An added problem is that many of the older boiler types have no proper controls, further reducing your boiler's efficiency.

EFFICIENCY COMPARISON	
Greenstar Heatslave II or Danesmoor	over 90%
Old boiler	up to 60%

In the last few years, new 'condensing technology' has been incorporated into boilers. Essentially this enables some of the heat that would otherwise escape from a boiler to be captured and re-used. As a standard rule the better the boiler quality, the more it captures. For example, our Greenstar condensing boilers are more

than 90% efficient, so over 90p of every £1 you spend on fuel for your boiler is used for your heating and hot water. On top of this, intelligent controls can also make a difference by enabling much smarter, more cost-effective management of your heating and hot water system.

Making it official

To ensure that everyone benefits from boiler efficiency – including the environment – regulations were introduced in 2007 making it compulsory for virtually every newly installed oil boiler to be of a condensing design (typically C-rated or above). Regulations went even further in 2010 and since then all new boilers must now be A-rated (the most energy efficient and environmentally friendly).





Every boiler needs to be maintained and serviced so it makes sense to consider the lifetime running costs along with the initial purchase price.

Lifestyle flexibility

With a wide range of boiler types on the market you can be sure to find one to suit your home and lifestyle. Each boiler has its own installation requirements, so talking to an expert is important. They will look at things like the size of your property, mains water pressure, the number of bathrooms or showers, if you have a loft and whether you want to free up space.

Another consideration is how you use your heating and hot water and if it might change, such as if your family is growing. Gaining expertise from the right company, such as Worcester, will help to make this process simple, whilst also ensuring you receive a boiler that meets all your needs, both now and into the future.

Wise choices

A new boiler will always vastly improve efficiency but it can be a sizeable investment, so it's important to choose wisely. Much like buying any other large appliance, it makes sense to look beyond the purchase price, and to consider the durability of parts and maintenance costs.

The better the boiler quality, the more reliable it will be, so opting for one from an established manufacturer will ensure you receive high performance as well as choice. By discussing everything with experts like your Worcester installer, you'll make certain of the best long-term value for money, giving you financial peace of mind as well as comfort and warmth.

Smaller carbon footprint

Domestic boilers currently account for 21%* of the UK's total CO₂ emissions so the greater their efficiency, the more kind they are to the environment. Greenstar condensing boilers, for example, achieve dramatically reduced emissions of CO₂, making their carbon footprint smaller than the average for boilers of this kind. Carbon emissions – as well as energy bills – can fall even lower if a new boiler links to a solar hot water system or intelligent control.

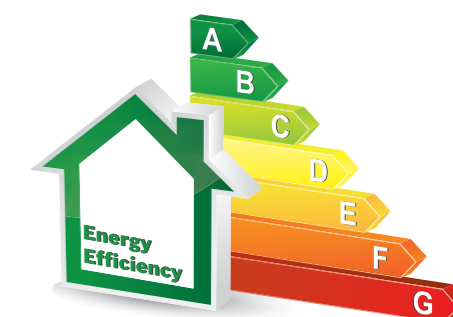

If you decide to sell your home in the future, you will need to produce an Energy Performance Certificate (EPC). A high-efficiency condensing boiler will boost your EPC rating, making your home more attractive to buyers.

* Source: Energy Saving Trust.



ErP labels are already a common sight on washing machines, televisions and other appliances in electrical retailers. From 2015 these labels now apply to heating products and systems.

Energy related Product (ErP) labelling.

The ErP Directive is a new regulation set by the European Union and is designed to drive improvements in the efficiency and performance of heating and hot water products.

Its purpose is to ensure that you as homeowners are aware of the energy efficiency levels of your heating appliances. The ErP Directive will help the UK and other European governments reduce carbon emissions. This will improve the overall efficiency of UK properties, whilst also helping you to reduce your energy bills.

The ErP regulations cover boilers, water heaters and other heating appliances up to 400kW (a typical domestic boiler ranges from 9-40kW).

What is Energy Labelling?

Energy Labelling involves adding a label to a product. It is your installer's responsibility to ensure that you receive the energy label with the heating appliance they offer you and if they have a showroom that the Energy Label is visible on products.

The new Energy Labelling Directive will introduce new efficiency classes from A++ to G on top of the existing SEDBUK rating for products in the UK.

Most high efficiency boilers fall within the A band, which requires them to achieve more than 90% seasonal efficiency, while renewable technologies such as heat pumps typically sit within the A+ or A++ bands (depending on the temperature they deliver).

More details on ErP and the information which is included on a label can be found at: worcester-bosch.co.uk/ErP

What about controls?

The ErP Directive also includes controls, which are defined using 'classes'. These run from Class 1 (a simple on/off room thermostat) through to Class 8 (multi-sensor room control for use with modulating heating appliances).

Each control class equates to certain percentage uplift in system efficiency e.g. a Class 6 weather compensating control and room thermostat will improve your heating system's efficiency by 4%.



To ensure you benefit from the highest levels of efficiency we always suggest you check that your quote includes an ErP compliant high efficiency boiler.



Which heating and hot water system is best for me and my lifestyle?

Deciding which boiler will make an efficient and practical fit with your home and your lifestyle can be confusing. The following pages explain the main system types, how they work, their advantages, and what kind of homes they work best in.

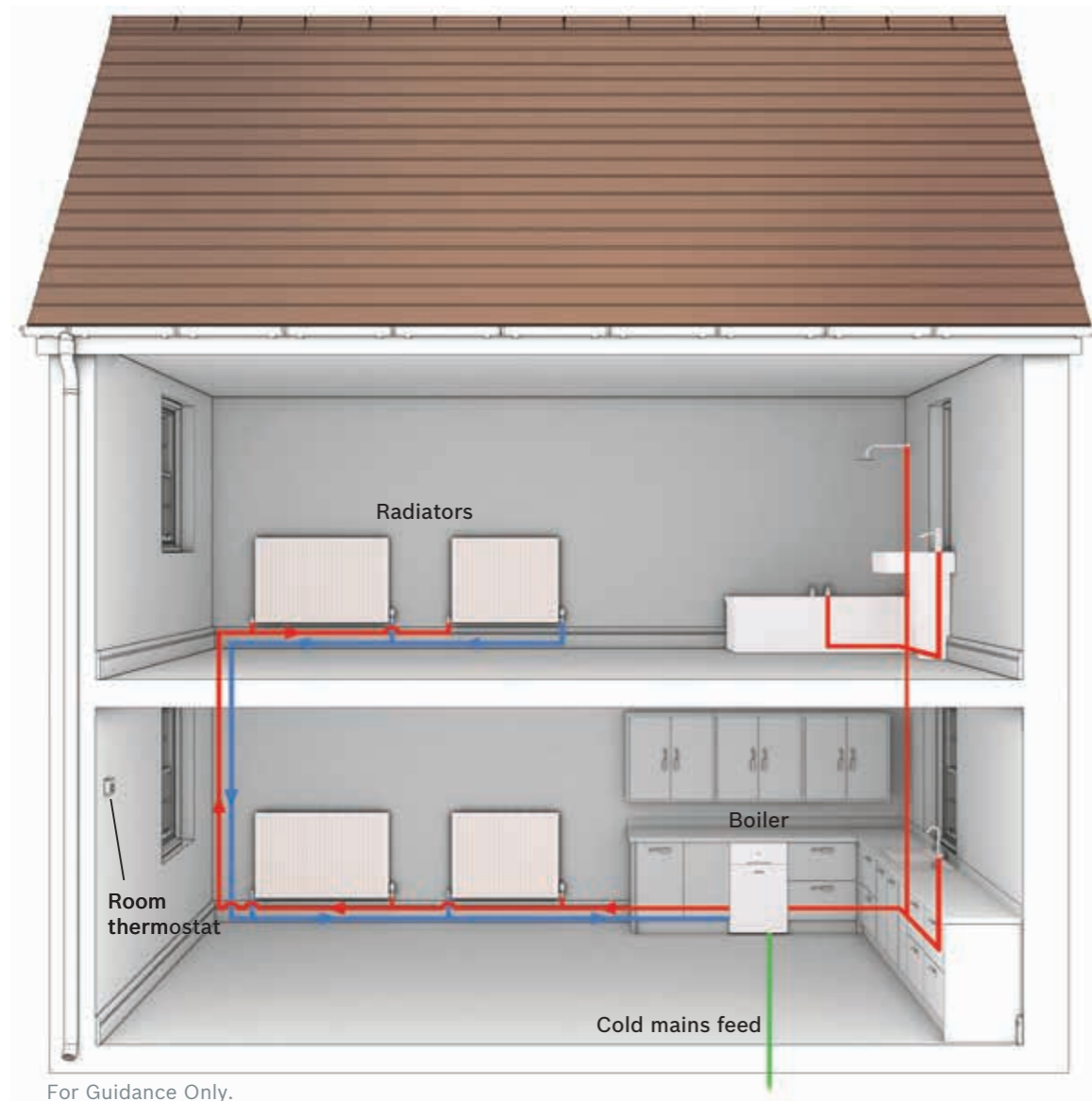

Typical combination boiler heating system.

A combination or 'combi' boiler is both a high efficiency water heater and a central heating boiler in a single compact unit. Combi boilers heat water directly from the mains when you turn on a tap, so you won't need a hot water storage cylinder or a cold water storage tank in the roof space. They are also very cost-effective and energy-efficient as water is heated instantly rather than being heated and then stored in a cylinder.

An added benefit is that hot water is delivered at mains pressure, which means that you could get a powerful shower without the need for a separate pump.

Go to pages
19-21 to see the
Greenstar
combi range

Advantages

- Ideal where there is little or no loft space
- No need for a hot water cylinder allows increased living space
- No cold water storage tank frees up a loft for conversion
- No risk of loft pipework freezing
- Less pipework in the home makes installation typically cheaper

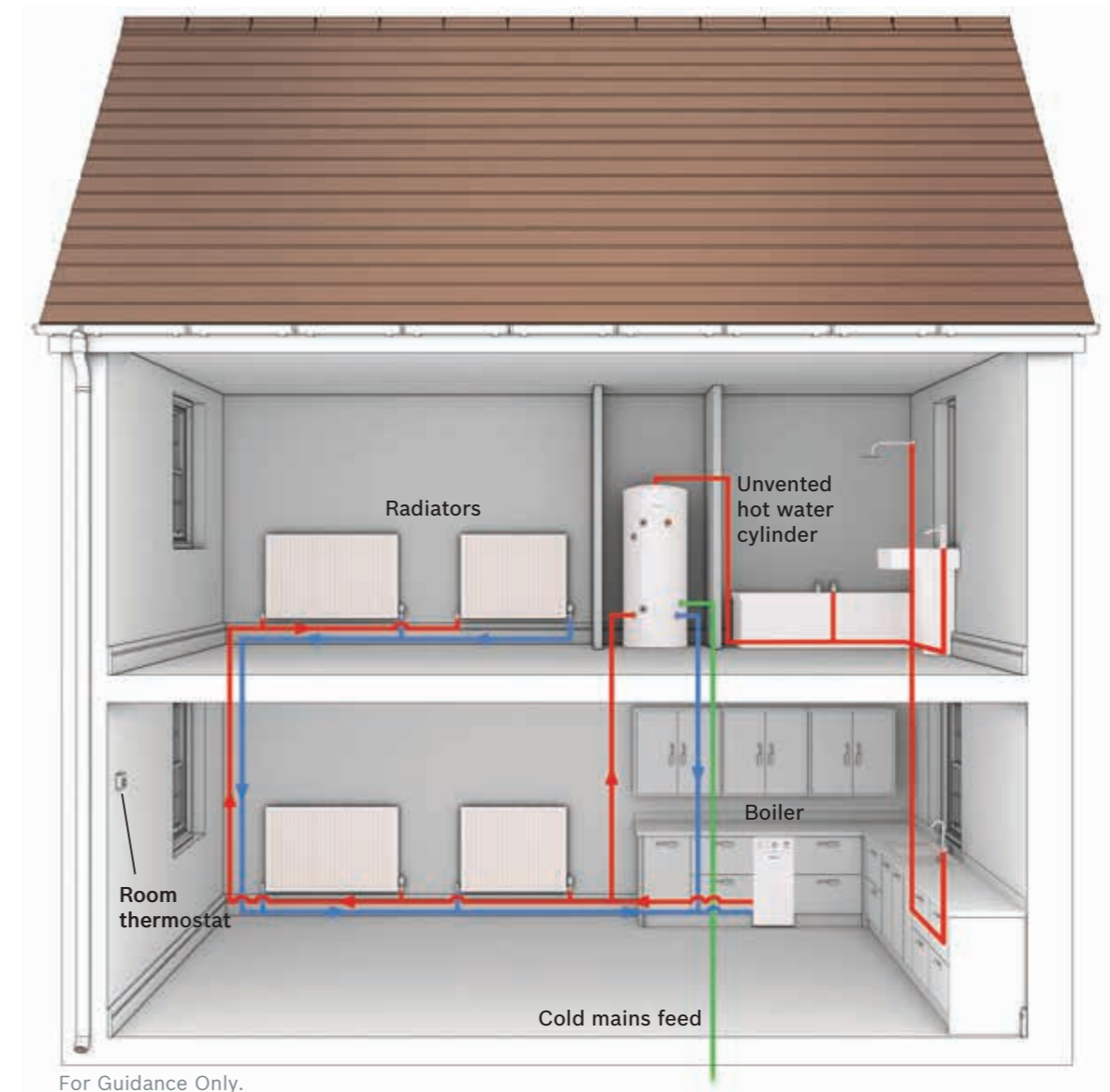

Typical system boiler heating system.

System boilers require a cylinder for storing hot water, however the major heating and hot water system components are built into the boiler itself, making it quicker and easier to install.

In addition, there is no need for a tank in the loft, so it can be an option in a home with little or no loft space or where the space is earmarked for a conversion. These boilers are also compatible with solar hot water systems, which deliver environmental benefits as well as lower energy bills.

Go to pages
22-25 to see the
Greenstar
system range

Advantages

- Ideal for homes with more than one bathroom
- Constant supply of hot water to any number of taps at the same time
- No need for a loft tank, freeing up space and eliminating worries about leaks or frost damage
- Built-in components makes installation quicker and neater
- Compatible with solar hot water systems

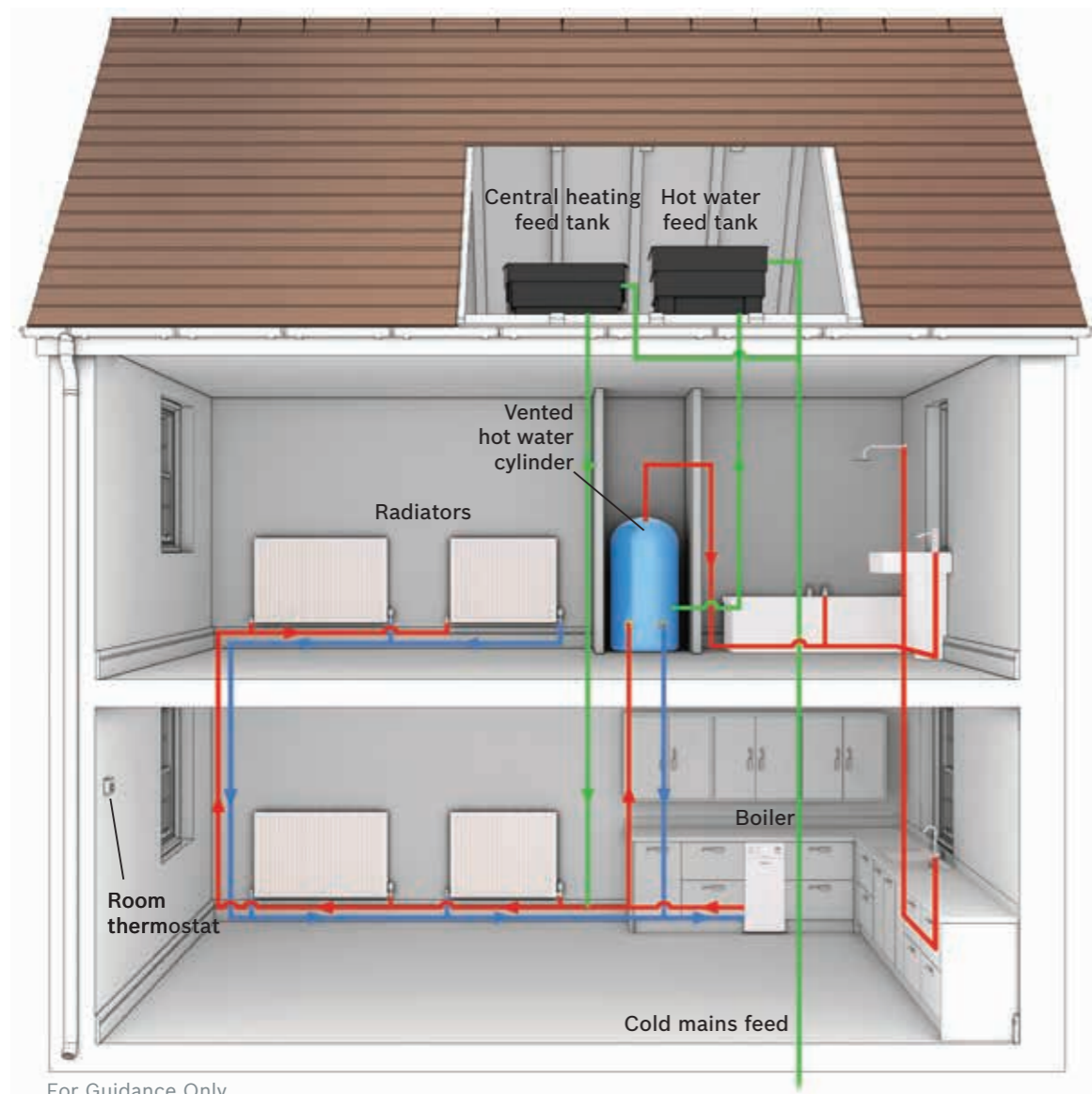

For Guidance Only.

Typical regular boiler heating system.

Go to pages 27-30 to see the Greenstar regular range

Regular boilers (sometimes known as traditional, conventional or heat only boilers) are ideally suited to homes that already have a traditional heating and hot water system which is linked to a separate hot water cylinder. These boilers also need a cold water storage tank in the loft to feed the hot water cylinder as well as a tank that maintains the water level of the central heating system. A regular boiler may be the best option for replacing an existing boiler if the property has an older radiator system, as it might not be able to cope with the higher water pressure that is delivered by system or combi boilers.

Advantages

- Perfect for homes where a lot of hot water is used at the same time
- Ideal where there is more than one bathroom
- A good option in areas where water pressure is low
- Compatible with solar hot water systems for a lower carbon footprint and lower energy costs

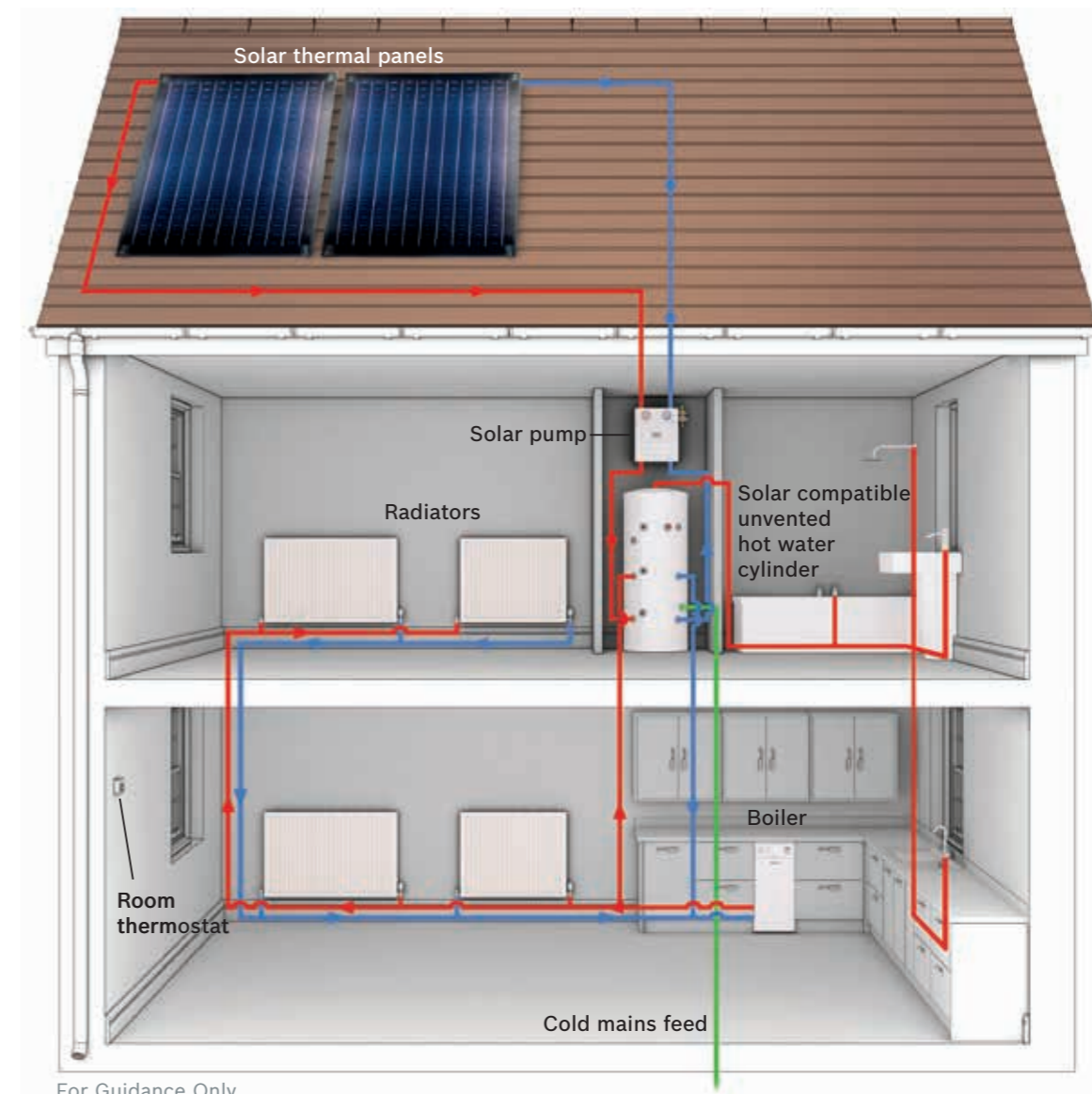

For Guidance Only.

Typical system or regular boiler heating system with solar thermal hot water.

Go to page 46 to find out about Greenskies solar thermal

System and regular boilers are perfect partners for Worcester Greenskies solar hot water systems (also known as solar thermal). In a solar thermal system, the panels harness heat from the sun, which is used to heat the water stored in a solar compatible hot water cylinder. The boiler is linked to the system and automatically starts up if the water in the cylinder falls below the required temperature, ensuring you have all the hot water you need, all year round.

Effective even on cloudy days and during shorter winter daylight hours, a solar thermal system will typically meet around 60%* of your home's hot water requirements, which could mean considerable savings on your energy bills as well as dramatically reduced carbon emissions.

Advantages

- Typically generates 'free' energy for over half of your hot water needs, giving you lower energy bills
- Particularly beneficial for homes with large families or high hot water usage
- Works in the winter months and on cloudy days
- Compatible with all Worcester regular and system boilers
- Reduces your carbon footprint
- Government funding could be available

* Source: Energy Saving Trust.



Combi boilers are very reliable as well as highly energy-efficient making them economical to run.

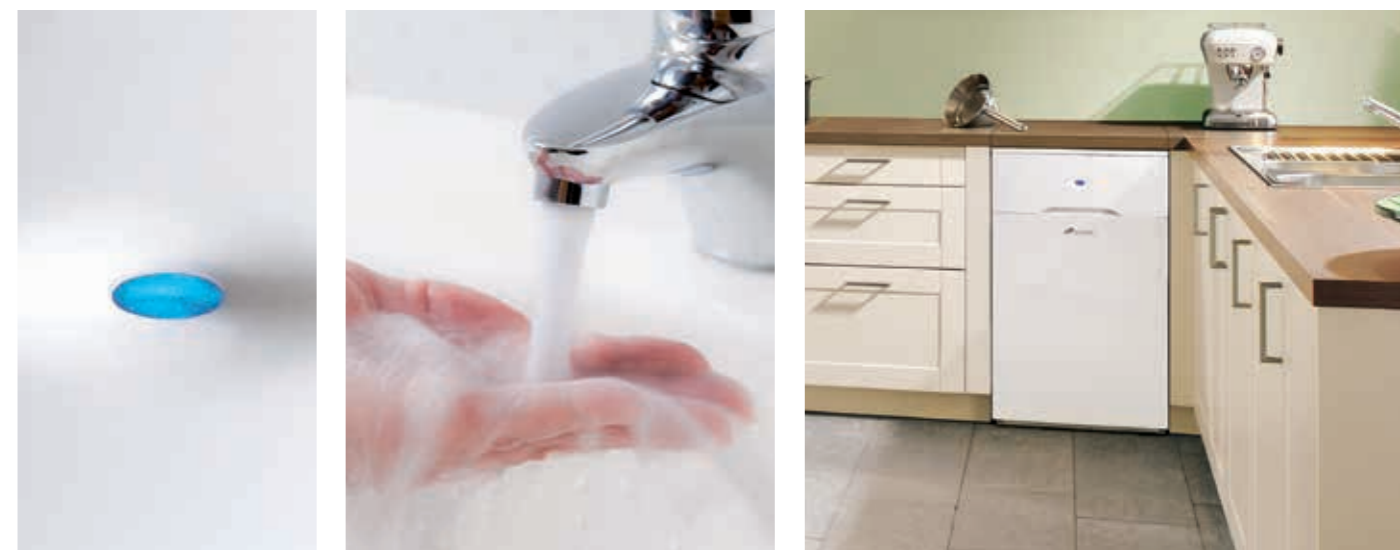

Greenstar combi boilers.

Combi boilers are the most popular heating and hot water solution in the UK. Over 15 million have been fitted across the country and they are now the preferred choice for most householders and installers. Worcester was the pioneer of the combi boiler in the UK, with the Greenstar range developed to suit virtually all homes.

Energy saving and convenient

All Worcester Greenstar combis are designed and manufactured to provide high levels of performance and operating efficiency. This is achieved through features such as the 'keep hot' facility (which ensures hot water is almost instantly available) and the Heatslave II's in-built thermal store which enables the boiler to provide instant hot water for prolonged periods.

What is a thermal store?

A thermal store is a small tank integrated in the Greenstar Heatslave II combi, with the store containing the same water that is found in your radiators. By storing heat within the hot water store, the Heatslave II can instantly heat (via a heat exchanger) the cold water that enters the boiler and then passes to your hot tap or shower, increasing your hot water comfort.

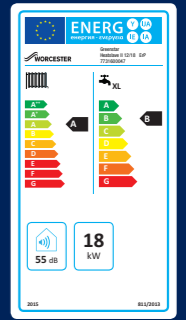

Further technical and ErP information for the Greenstar combi range can be found on page 50-51.

Greenstar Heatslave II series

The high performance floor-standing Greenstar Heatslave II series is the UK's most popular oil-fired combi boiler. With its sleek modern design, it is perfectly suited to installation anywhere in your home, including in a kitchen where it has been designed to slide neatly under a standard kitchen work top. Larger output models are available to suit the needs of two bathroom homes. Its easy-to-use features include a unique slide-out control panel, which allows simple boiler adjustment and programming from the front of the boiler.

MODEL	12/18	18/25	25/32
Central heating output	18kW	25kW	32kW
Hot water flow rate	15 ltr/min	18 ltr/min	22 ltr/min

All figures are maximums

- Precise heating and hot water control
- A range of models to meet the needs of smaller homes as well as two bathroom properties
- Suitable for kitchen installation. Can be installed under a work surface
- Compatible with a range of optional controls for greater efficiency and comfort
- Works with water heated by green sources such as solar energy and wood fired boilers for increased efficiency
- Concealed controls – ideal for families with young children.

Greenstar Heatslave II External series

The Greenstar Heatslave II External series is ideal when you want a combi boiler but don't have the indoor space or prefer to have it outside. The robust design ensures that even in harsh weather conditions, heating performance is maintained and the boiler components are fully protected.

MODEL	12/18	18/25	25/32
Central heating output	18kW	25kW	32kW
Hot water flow rate	15 ltr/min	18 ltr/min	22 ltr/min

All figures are maximums

- All the same performance features as the **Heatslave II plus**:
- A robust, durable external cabinet that blends in with the garden
 - IP45 Ingress Protection – ensures the boiler is protected from water, dust and external elements
 - Built-in frost thermostat automatically protects the appliance from freezing.

Worcester Heatslave II control range

The Greenstar Heatslave II and Heatslave II External boilers both feature Worcester's latest boiler control unit. Neatly concealed within a slide open draw, the control interface not only allows you to intelligently manage heating and hot water production, but it also allows you to take advantage of an efficiency boosting plug-in control from Worcester.

Fitting a Worcester control will enable you to:

- Precisely manage your system
- Fine tune comfort levels
- Control heating and hot water 7 days a week
- Ensure comfort and efficiency with Weather Compensation[†]
- Avoid wiring through your home – no wiring required[^]
- Easy to read your control – backlit displays[^].

For further information see pages 32-37 and for control compatibility see page 51.

[†] With optional weather sensor
[^] Comfort controls only

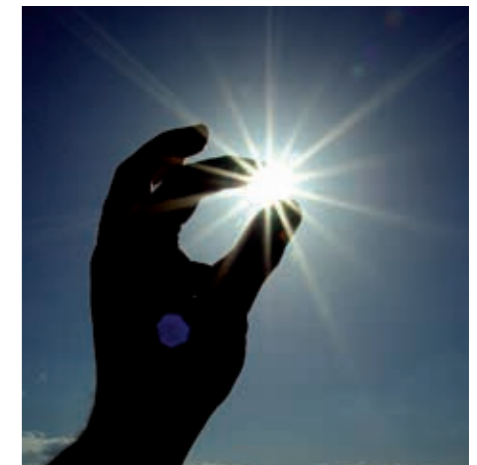

Greenstar Heatslave II combi boilers will accept pre-heated hot water from renewable sources such as solar thermal, helping to lower fuel bills and protect the environment. For further information speak to your installer.

Why a Heatslave II combi boiler?

1. Heating and hot water from one unit
2. Thermal store allows high volumes of instant hot water
3. Frees up space – no need for separate pump or tanks
4. Compatible with a wide range of controls
5. No risk of frozen pipes or tanks, or leaks in the loft
6. Less components and pipework usually means faster installation



We always recommend you consult a qualified OFTEC installer prior to choosing your boiler.

System boilers provide plenty of hot water to multiple taps at the same time and do not need any tanks in the loft.



Greenstar system boilers.

Greenstar system boilers are known for their high quality and reliability, making them robust enough to stand up to the highest of heating and hot water demands.

Efficient and economical

Highly efficient and economical to run, Worcester system boilers incorporate many of the heating and hot water components found in a traditional heating system, making installation less disruptive and neater.

Space saving and attractive

The market leading compact dimensions of Greenstar Danesmoor System boilers means that they can fit perfectly into many locations, with a choice of kitchen, utility and external models allowing your boiler to be installed in a location that suits your lifestyle and property.

Perfect partners

Greenstar Danesmoor System boilers can be used with an optional control to maximise comfort and energy savings, and are also perfectly matched to our comprehensive range of Greenstore hot water cylinders. Choosing a complete Worcester system will ensure you will have a highly efficient solution and give you the opportunity to get a comprehensive 5 year guarantee across your entire system*.

System boilers are also compatible with our Greenskies solar hot water systems, which can be installed at the same time as the boiler or easily retrofitted in the future to reduce your energy bills even further.

* Terms and conditions apply.



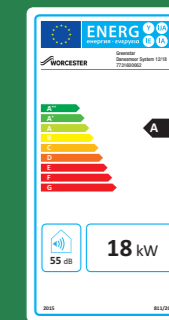

Further technical and ErP information for the Greenstar system range can be found on page 50-51.

Greenstar Danesmoor System series

The compact and highly efficient Greenstar Danesmoor System series is ideal for small, medium and large sized homes with a heating system that includes stored hot water. With visible heating controls and system pressure gauge, and the option for a plug-in programmer it is ideal for installation in a busy part of the house such as a kitchen.

MODEL	12/18	18/25	25/32
Central heating output	18kW	25kW	32kW

All figures are maximums

- Perfect for a kitchen or utility room
- Quiet in operation
- Optional 7-day twin channel digital programmer available for greater comfort and energy efficiency
- Compatible with Worcester Greenskies solar and Worcester Greensource air to water heat pumps for greener, lower cost hot water and heating.

Greenstar Danesmoor System Utility series

As a utility option these Danesmoor boilers feature the same compact dimensions and highly efficient operation of the Greenstar Danesmoor System but the heating temperature control and system pressure gauge are positioned behind the front panel. Just like its counterpart, this boiler is suitable for small, medium and large homes.

MODEL	12/18	18/25	25/32
Central heating output	18kW	25kW	32kW

All figures are maximums

- Perfect for a kitchen or utility room
- Concealed controls – ideal for families with young children
- Quiet in operation
- Compatible with Worcester Greenskies solar and Worcester Greensource air to water heat pumps for greener, lower cost hot water and heating.

Greenstar Danesmoor System External series

The high efficiency Greenstar Danesmoor System External series is a perfect choice where space in your house is at a premium. The boiler is contained in a robust cabinet that protects the boiler in all weathers.

MODEL	12/18	18/25	25/32
Central heating output	18kW	25kW	32kW

All figures are maximums

- All the same performance features as the Danesmoor System internal models plus:
- A robust external cabinet design ensures full weatherproofing
 - IP45 Ingress Protection ensures high performance even in harsh weather conditions
 - Added protection against freezing
 - Compatible with Worcester Greenskies solar and Worcester Greensource air to water heat pumps for greener, lower cost hot water and heating.



Worcester system boilers and Greenstore unvented hot water cylinders offer the perfect combination for plentiful, efficient hot water.

Why a system boiler?

1. Hot water supplied evenly to all taps at the same time
2. Optional plug-in control (Danesmoor System series)
3. Energy efficient for lower fuel bills
4. No risk of pipes or tanks in the loft leaking or freezing
5. No need for separate pump and loft tanks
6. Compatible with Greenskies solar hot water systems



We always recommend you consult a qualified OFTEC installer prior to choosing your boiler.

Want hot water provided by the sun?

For more information on **Greenskies solar thermal panels** see page 46 or visit our website.

For more information on **Greenstore cylinders** see pages 30-31.





Regular boilers meet all the heating demands of every size of home and are an ideal energy-efficient replacement for an existing boiler.



Greenstar regular boilers.

With quality and reliability at the heart of every Worcester regular boiler, they are robust enough to deliver efficient heating and hot water year after year.

Modern efficiencies and choice

With over 90% efficiency, Greenstar regular boilers will help reduce your energy bills and your carbon footprint. They can enhance heating and hot water performance in all sizes of homes, including those with two or more bathrooms, and where mains water pressure is low. For added choice Greenstar regular boilers come in a wide range of models. They are also designed to be installed in a range of indoor and outdoor locations and are suited to a variety of heating requirements.

Solar-compatible

All of our oil-fired regular boilers are compatible with our Greenskies solar hot water systems, which can help you to reduce your energy bills whilst also benefitting the environment.

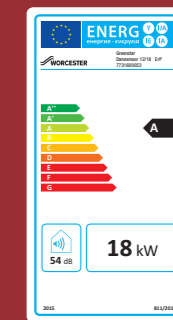

Further technical and ErP information for the Greenstar regular range can be found on page 50-51.

Greenstar Danesmoor series

Designed to fit neatly between standard kitchen units, the Greenstar Danesmoor series is a highly efficient solution for any small, medium and large home which is not connected to a mains gas supply.

MODEL	12/18	18/25	25/32
Central heating output	18kW	25kW	32kW

All figures are maximums

- Ideal for small to large size homes
- Highly efficient
- Quiet in operation
- Optional 7-day twin channel digital programmer available for greater comfort and energy efficiency
- Compatible with Worcester Greenskies solar and Worcester Greensource air to water heat pumps for greener, lower cost hot water and heating.

Greenstar Danesmoor Utility series

Danesmoor Utility boilers feature the same compact dimensions of the Danesmoor regular, allowing it to fit neatly between standard kitchen units. However, the hot water temperature control and system pressure gauge are behind the front panel. Like its counterpart, these boilers are suitable for small, medium and large homes.

MODEL	12/18	18/25	25/32
Central heating output	18kW	25kW	32kW

All figures are maximums

- Ideal for small to large size homes
- Highly efficient
- Quiet in operation
- Compatible with Worcester Greenskies solar and Worcester Greensource air to water heat pumps for greener, lower cost hot water and heating.

Greenstar Utility (High Output) series

The Greenstar Utility series has been designed to provide a high output energy efficient solution for large homes and light commercial properties. They are intended for installation in a utility area or a dedicated plant room.

MODEL	32/50	50/70
Central heating output	50kW	70kW

All figures are maximums

- Ideal for homes with a high heating and hot water requirement
- Highly efficient
- Quiet in operation
- Compatible with Worcester Greenskies solar and Worcester Greensource air to water heat pumps for greener, lower cost hot water and heating.

Greenstar Danesmoor External series

The Greenstar Danesmoor External series is an ideal choice for homes where indoor space is at a premium. Available in a wide range of central heating outputs, the boilers perfectly meet the needs of smaller, medium and larger properties.

MODEL	12/18	18/25	25/32
Central heating output	18kW	25kW	32kW

All figures are maximums

- All the same performance features as the Danesmoor internal models plus:
- A robust external cabinet design ensures full weatherproofing
 - IP45 Ingress Protection ensures high performance even in harsh weather conditions
 - Added protection against freezing
 - Compatible with Worcester Greenskies solar and Worcester Greensource air to water heat pumps for greener, lower cost hot water and heating.



Greenskies solar thermal panels and Worcester regular boilers are perfect partners for efficient hot water.

Why a regular boiler?

1. Compatible with older pipework and radiators
2. Options for very compact spaces
3. Ideal for properties with multiple bathrooms
4. High efficiency for lower energy bills and reduced carbon footprint
5. Simple and straightforward installation
6. Compatible with Greenskies solar hot water systems

Want hot water provided by the sun?

For more information on **Greenskies solar thermal panels** see page 46 or visit our website.

For more information on **Greenstore cylinders** see pages 30-31.



We always recommend you consult a qualified OFTEC installer prior to choosing your boiler.



Super efficient cylinders can help lower your energy bills and carbon emissions. They are highly insulated to reduce heat loss and energy wastage.

Greenstore cylinders – transforming hot water storage.

When a system or regular boiler is installed, there will always be a requirement for a hot water cylinder. Hot water is provided by taking heat from the boiler and pumping it through the central heating system to the cylinder where the heat is transferred via the cylinder's heat exchange coils. This water is then stored ready to be passed through taps and showers when required.

Older, non-insulated cylinders tend to lose a considerable amount of heat and are likely to have a build-up of limescale, which reduces efficiency and makes water heat-up times longer. Even insulated cylinders over 10 years old lose more heat than modern ones.

Greenstore unvented cylinders have been designed to offer significant performance improvements over traditional cylinders. They combine rapid re-heat times with high heat retention and are guaranteed for 25 years*. They also come in a wide range of capacities, from 90 to 300 litres, so you can be sure of a size that's exactly right for your home and lifestyle.



Greenstore unvented cylinders: made for modern living

The Greenstore unvented cylinder range is a perfect complement for Greenstar regular or system boilers. Hot water is supplied at mains pressure for powerful showers and fast bath filling, and multiple taps can be used at the same time without the hot water running out. If your mains water pressure is low, you can still benefit from the high performance, fast re-heat times and energy savings of Greenstore cylinders. A trained Worcester installer will be able to provide solutions to increase your water performance if needed.

Greenstore unvented solar cylinders: the future-proof choice

Greenstore solar-compatible unvented cylinders are specifically designed to work with our Greenskies solar water heating systems. With all the same benefits as our standard unvented range, they enable you to add solar water heating to your system at a later date with no need to replace the cylinder. Available in five capacities, from 150 to 300 litres, they provide highly efficient storage for both boiler and solar-heated hot water.

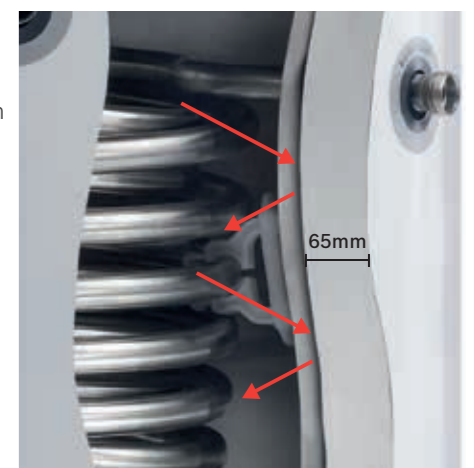

With 65mm of Expanded Polystyrene, the insulation level on Greenstore cylinders is one of the thickest in the UK market.



Worcester keeps you in control.



Boiler controls make a big difference to your heating system. With our condensing boilers already operating at peak efficiency, our range of controls give you an additional way of boosting your system's overall performance.

The type of boiler you have will affect which type of control you will be able to have in your home. In a system or regular heating system, your choice can be more limited due to the integration of a hot water tank in your system. For this, Worcester offers the ideal solution in the form of the Digital 7-day plug in programmer which allows you to easily adjust your heating and hot water.

However, with the latest range of Heatslave II combi boilers you can go one step further. The Heatslave II series feature

an intelligent pull-out interface which allows you to precisely adjust your heating and hot water as standard. It also enables you to utilise one of our Comfort or Intelligent controls, bringing energy saving and comfort increasing features such as Weather Compensation to oil boilers, something that is typically unavailable for oil boilers in the UK.



Worcester controls are designed to not only enhance a boiler's efficiency but incorporate features that work around your lifestyle.

Controls for a heating and hot water system typically include two main elements: a time clock or programmer and a room thermostat. Here we explain the different types that we offer and what they do. We also highlight what load and weather compensation mean – two key features of Worcester intelligent and smart controls.

Timers and programmers

A boiler timer is a basic device that allows you to set specific times for your central heating system to come on and turn off, with the same times typically repeated every day. A boiler programmer allows you to set your heating (and sometimes hot water) to switch on and off at different times, and on different days of the week.



Digital programmer.

Room thermostats

A room thermostat monitors the air temperature and enables you to set the level you find comfortable. If the room temperature drops below this level, the thermostat switches your boiler on and if it gets too hot in the room, it turns it off.

Programmable room thermostats

A programmable room thermostat is both a boiler programmer and a room thermostat; it allows you to set different room temperatures for different times of the day and night. When programmed correctly, it prevents the system from having to heat your home from a cold start, with the boiler simply 'topping up' the temperature, which saves energy and improves comfort.

We also offer a range of wireless programmable room thermostats. These are a good option if you prefer not to have wires running between your thermostat and boiler or if the boiler is not readily accessible, such as in a loft space or garage.



Programmable room thermostat.

Load compensation

The load compensation feature adjusts the temperature of the heat going to your radiators. When a room is cold the temperature will be high, but as the room warms up and less heat is needed, it lowers the temperature so that comfort is maintained but energy use is reduced.

Weather compensation

The weather compensation feature also adjusts the temperature of the heat going to your radiators. However, it does so in keeping with the outside temperature. An outdoor sensor or an internet location post code search (Worcester Wave only) allows the control to monitor the weather, with the radiators running hotter if temperatures outside drop, ensuring a comfortable home whatever the weather.



Outdoor weather sensor.



Combi boiler controls

Digital programmer

- ① **Greenstar Comfort plug-in programmer**
- Simple menu navigation
 - Heating programme visualisation bar
 - Control heating and hot water 7 days a week.

Intelligent digital programmers and thermostats

- ② **Greenstar Comfort I RF wireless room thermostat and plug-in programmer**
- All the features of the **Comfort** plus...
- Wireless system – no wiring required
 - Extremely reliable Radio Frequency (RF) signal.

- ③ **Greenstar Comfort II RF wireless programmable room thermostat**
- All the features of the **Comfort** and **Comfort I** plus...
- 6 adjustable heating temperatures per day
 - Programmers can be set at the room thermostat rather than on the boiler
 - Back lit display.

- ④ **Greenstar Sense I wired room thermostat**
- Perfect replacement for less energy efficient wired room thermostats
 - Simple to use
 - Load compensation enables 3% system efficiency improvement

Weather sensor

- ⑤ **Worcester outdoor weather sensor**
- Weather compensation feature for greater energy efficiency.

System and regular boiler controls

Digital programmer

- ⑥ **Digital plug-in 7-day twin channel programmer**
- A simple-to-use Worcester control device
 - Plugs into the boiler fascia panel
 - Offers 3 separate time periods for both heating and hot water
 - Holiday mode – heating and hot water settings on hold whilst you are away then resume normally.

Why use a boiler control?

1. Significant improvements to your system's overall performance
2. Efficient management of your energy usage
3. Potential to lower energy bills
4. Heating and hot water precisely when you want them
5. Freedom to choose times and temperatures to suit your lifestyle
6. A choice of clever features to optimise system performance

To see which control is compatible with your preferred boiler, please see page 51.



See our YouTube channel for more information - youtube.com/WorcesterBoschGroup

Robust, fully insulated cabinets provide complete protection for the boilers and ensure optimum performance even in extreme weather conditions.

Greenstar external oil boilers – the space saving option.

If the floor space in your home is limited or if you prefer to have a boiler that is sited outside, the Greenstar external boiler range is a perfect choice. As highly efficient as indoor models and with a robust, fully insulated cabinet they provide optimum performance even in extreme weather conditions.

The boilers are designed to prevent water, dust and other external elements getting inside, whilst a built-in frost thermostat provides an additional safeguard for all the internal components.

Finished in a muted green colour, the boilers blend in with your garden or outdoor space. A durable anti-corrosion coating makes sure that they keep their pristine looks and their quiet operation means that they won't intrude when you are outside.

For your peace of mind, the boilers and their controls are accessed using a special tool ensuring that the cabinets are tamper-resistant and childproof.

Combi, system or regular boiler choices

Whether you want a combi, system or regular external boiler, there's a Greenstar model to suit your preferences and lifestyle.

The Greenstar Heatslave II External combi boilers come in a choice of three central heating outputs and offer hot water flow rates of up to 22 litres per minute depending on the model. For added flexibility Greenstar Heatslave II External boilers can be used with the Greenstar Comfort controls range, which can be mounted inside your property for complete ease of adjustment.

Greenstar Danesmoor system and regular external boilers are also available in three different central heating output options and are compatible with Worcester Greenskies solar and Worcester Greensource air to water heat pumps for greener, lower cost hot water and heating.





In addition to fitting a system filter it is always recommended (as per Building Regulations) that your central heating system is flushed and cleansed to remove any system contaminants before your new boiler is installed.

Keeping your system working efficiently.

Good water quality.

Over time, central heating system water accumulates harmful dirt and debris, such as rust and solder fragments shed by older radiators and boilers, as well as limescale deposits from mains water, all of which can cause considerable problems.

Reduced efficiency

Condensing boilers are precision-engineered and designed to run with clean water in the system. When system water becomes contaminated it can quickly cause radiator blockages as well as damage to key components in the boiler and heating system. This leads to a loss of radiator heat, increased system noise and potentially failures. It also means a shorter life for the overall system and a dramatic reduction in the boiler's efficiency, which affects comfort and adds to your energy bills.

A perfect safeguard

The Worcester Greenstar System Filter has been specifically designed to combat the damaging effects of system debris and pollutants by capturing contaminants before they reach your boiler. Using powerful and innovative magnet-based technology, it is instantly effective at protecting the performance of your heating and hot water system, ensuring a warm and quieter, blockage free system.

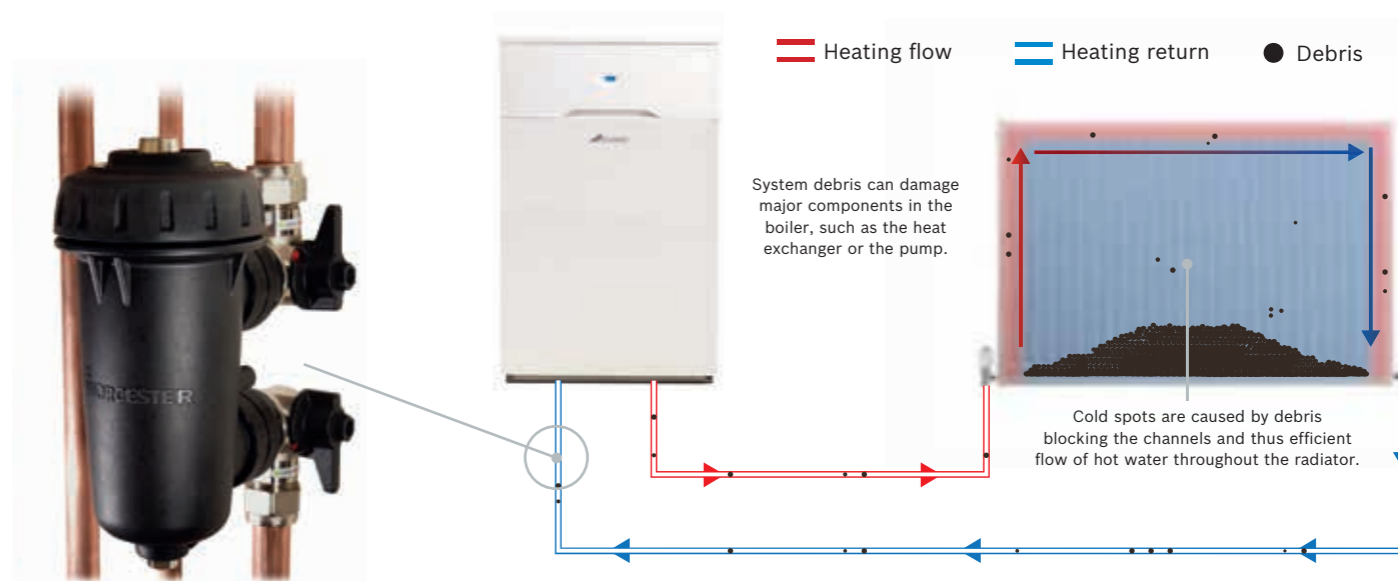

The Greenstar System Filter simply connects to the pipework flowing back to the boiler to filter out debris and dirt before it causes damage or radiator blockages.

This image illustrates how debris in a system can build up in the bottom of radiators and block the efficient flow of water around the system, eventually affecting the radiator's heat distribution and your comfort.



See our YouTube channel for more information -
youtube.com/WorcesterBoschGroup

With over 7,500 OFTEC registered installers in the UK, finding a local professional installer is simple.

How can I get a Worcester boiler installed?

Modern heating systems are sophisticated and complex, and it's vital to have them professionally installed, which is why **we don't sell our products direct to householders.**

There are three straightforward ways to find local professional installers...



The internet

You can do a general search for local OFTEC registered installers on the internet. Some might have a showroom, giving you the opportunity to meet them first before you make a home visit appointment.

For your peace of mind, all OFTEC registered installers carry an ID card, which you should ask to see when they arrive.



OFTEC registered installers

You can search for OFTEC registered installers on the OFTEC website at oftec.co.uk. You can find local professionals by entering your postcode.

This will allow you to check individuals and companies to see if they are registered and includes information on what OFTEC registered engineers are and why it's important to use them.



Worcester Accredited Installers

Worcester Accredited Installers are installation companies that we consider to be reputable, quality-conscious and provide value for money. They must have attended our training courses and hold all the required approvals for carrying out work at your home, such as Gas Safe or OFTEC accreditation, before we list them.

As well as advising, installing and providing servicing and maintenance, some also offer extended guarantees on our products.

To find a local Worcester Accredited Installer simply go to the 'Find an Installer' page at worcester-bosch.co.uk and enter your postcode.



Guaranteed products as well as the help and advice you need for complete peace of mind.



Supporting you from the start.

When you choose Worcester, you'll be in the company of millions of people across the UK who value the quality, reliability and comfort of our boilers.

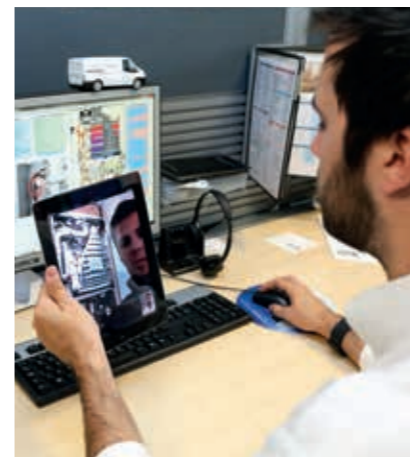

Our guarantee

Every one of our products is manufactured to the highest quality standards and undergoes stringent and continuous testing.

We want you to have the same confidence in our boilers as we do, which is why they come with a full parts and labour guarantee including a 10 year guarantee* on the primary heat exchanger – the heart of the boiler. We also currently guarantee the boiler as a whole for a minimum of 5 years as standard*.

When you buy one of our boilers, don't forget to register your guarantee, which you can do quickly and easily online at worcester-bosch.co.uk/registration or by telephone on **0330 123 2552**.

Service and support

Whether you are thinking about buying a Greenstar boiler or you've owned one for a long time, we are always here to help.

Our award-winning support team can advise you on any aspect of your boiler. Friendly and knowledgeable, they'll give you all the help you need, from choosing the right controls to technical queries, such as combining your boiler with renewable systems like solar water heating. We also have over 300 service engineers working across the country to ensure that our products always deliver high performance year after year.

We also publish a useful heating and hot water 'handy hints' guide, which includes helpful tips for boilers, radiators, controls and system care. You can download the guide at worcester-bosch.co.uk/handyhints or call our brochure line on **0330 123 9119** for a printed copy.



Greenstar oil-fired boilers come with a 10 year guarantee* on the secondary heat exchanger as standard.

Other technologies from Worcester for your home.

Greenstar gas-fired boilers



In addition to oil-fired boilers, we also manufacture a range of award winning, high-efficiency gas-fired Greenstar boilers which are also available as LPG models.

“Quality build and great aftersales service – extremely reliable products across the range.”

Which? September 2015/2016 Survey.

Greenstore ground source heat pumps



Ground source heat pumps work by drawing renewable energy from the ground and converting it into low cost, low carbon heating and hot water all year round.

For every single kilowatt of electricity used to power high efficiency Greenstore ground source heat pumps, the system can generate four kilowatts of energy for the home, which can mean significant savings on your energy bills.

Available in a range of capacities, they are designed to be the sole source of heat generation. They are suitable for well-insulated homes of all types and ages.

Greenskies solar thermal panels



Greenskies solar hot water panels absorb solar energy and convert it to heat.

Effective even on a cloudy day, they can provide up to 60%* of your home’s hot water requirements from a clean, renewable source.

They can be installed on or in a sloping roof, on a flat roof or even on a wall or floor, and come with a range of optional controls to enhance efficiency.

*Source: Energy Saving Trust.

Greenstore air to air heat pump



Designed for optimum efficiency, air to air heat pumps can generate up to five kilowatts of heat from every one kilowatt of electricity used to power them.

Air to air heat pumps generate hot air for distribution around the home. They can also act as an air cooler during the summer and feature advanced air purification technology, which is particularly beneficial to allergy sufferers.

In addition to our oil-fired boiler range we offer heating and hot water solutions that use renewable sources. We also look after homes that are supplied by mains gas or LPG, with our award-winning, high performance gas-fired boilers.



*Worcester’s range of products can be viewed on our website at worcester-bosch.co.uk
Brochures can be downloaded or ordered by calling 0330 123 9119.*



Other products from Bosch for your home and garden.

White goods

Bosch appliances are built with precision German engineering to deliver quality and efficient performance. From large home appliances such as washing machines and ovens to small appliances from kettles to vacuum cleaners, Bosch has consistently been recognised for the highest levels of quality and reliability.

This year and for the 4th year running Bosch has received the prestigious award of Which? Best Home Appliance Brand.

See more at bosch-home.co.uk



Lawn and garden

Bosch is the largest brand within the Garden Power market and is at the forefront of driving forward product innovation and development. With a complete range of tools and accessories to suit most gardening needs, you can be sure to experience effortless gardening that will help you make your outdoor living area your own.



See more at bosch-garden.com

Power tools

The Bosch Group is the world leader for power tools. By continually innovating and launching new power tools for DIY'ers and professionals alike, Bosch has become renowned for quality, reliability and precision.

With many new tool introductions every year, including award-winning cordless tools and lightweight lithium-ion technology, you can be sure to find the right tools for your next project.



See more at bosch-do-it.com

These handy comparison tables list some key technical information about our products.



	Floor standing	Height (mm)	Width (mm)	Depth (mm)	ErP – Seasonal Space Heating energy efficiency class	ErP – Water Heating energy efficiency class	SEDBUK 2009 value (%)	Domestic hot water flow rate (litres per min)*	Maximum central heating output (kW)
COMBI BOILERS									
Heatslave II 12/18	•	855	520	600	A	B	89.4	15	18
Heatslave II 18/25	•	855	520	600	A	B	89.2	18	25
Heatslave II 25/32	•	855	520	600	A	B	89.0	22	32
Heatslave II External 12/18	•	950	640	770	A	B	89.4	15	18
Heatslave II External 18/25	•	950	640	770	A	B	89.2	18	25
Heatslave II External 25/32	•	950	640	770	A	B	89.0	22	32
SYSTEM BOILERS									
Danesmoor System 12/18	•	855	370	600	A	N/A	91.1	N/A	18
Danesmoor System 18/25	•	855	370	600	A	N/A	90.9	N/A	25
Danesmoor System 25/32	•	855	370	600	A	N/A	90.7	N/A	32
Danesmoor System Utility 12/18	•	855	370	600	A	N/A	91.1	N/A	18
Danesmoor System Utility 18/25	•	855	370	600	A	N/A	90.9	N/A	25
Danesmoor System Utility 25/32	•	855	370	600	A	N/A	90.7	N/A	32
Danesmoor System External 12/18	•	950	565	780	A	N/A	91.1	N/A	18
Danesmoor System External 18/25	•	950	565	780	A	N/A	90.9	N/A	25
Danesmoor System External 25/32	•	950	565	780	A	N/A	90.7	N/A	32
REGULAR BOILERS									
Danesmoor 12/18	•	855	370	600	A	N/A	91.1	N/A	18
Danesmoor 18/25	•	855	370	600	A	N/A	90.9	N/A	25
Danesmoor 25/32	•	855	370	600	A	N/A	90.7	N/A	32
Danesmoor Utility 12/18	•	855	370	600	A	N/A	91.1	N/A	18
Danesmoor Utility 18/25	•	855	370	600	A	N/A	90.9	N/A	25
Danesmoor Utility 25/32	•	855	370	600	A	N/A	90.7	N/A	32
Utility 32/50	•	1,012	520	815	B	N/A	90.7	N/A	50
Utility 50/70	•	1,012	520	815	B	N/A	90.5	N/A	70
Danesmoor External 12/18	•	950	565	780	A	N/A	91.1	N/A	18
Danesmoor External 18/25	•	950	565	780	A	N/A	90.9	N/A	25
Danesmoor External 25/32	•	950	565	780	A	N/A	90.7	N/A	32

* Maximum hot water to provide an average 40°C temperature rise on a 90 litre draw off.

ⓘ Worcester Greenstar oil-fired appliances are designed for use with 28 sec kerosene only.



We always recommend you consult a qualified OFTEC installer prior to choosing your boiler.

Greenstar boiler controls compatibility^

	COMBINATION		SYSTEM	REGULAR
	Heatslave II	Heatslave II External	Danesmoor System	Danesmoor
Digital 7-day twin channel programmer			•	•
Comfort	•	•*		
Comfort I	•	•*		
Comfort II	•	•*		
Sense I	•	•†		
Weather sensor	•	•		

* All compatible controls should be used with Comfort wall plate kit.

† Must be used with a proprietary 230V timer.

^ Please note this table does not apply when retrofitting a control. Please speak to your installer.

	GREENSTORE UNVENTED CYLINDERS						
	Greenstore SC-90	Greenstore SC-120	Greenstore SC-150	Greenstore SC-180	Greenstore SC-210	Greenstore SC-250	Greenstore SC-300
Height	835mm	1,035mm	1,285mm	1,490mm	1,665mm	1,860mm	2,155mm
Diameter	570mm	570mm	570mm	570mm	570mm	570mm	570mm
Weight – dry	26kg	31kg	36kg	40kg	44kg	48kg	54kg
Volume domestic hot water	93 litres	123 litres	161 litres	191 litres	216 litres	246 litres	292 litres
Standing heat loss – 24hr	1.008kWh/24hrs	1.296kWh/24hrs	1.632kWh/24hrs	1.824kWh/24hrs	1.944kWh/24hrs	2.136kWh/24hrs	2.304kWh/24hrs
ErP energy efficiency class/ Standing heat loss	B / 42W	C / 54W	C / 68W	C / 76W	C / 81W	C / 89W	C / 96W

	GREENSTORE SOLAR COMPATIBLE UNVENTED CYLINDERS				
	Greenstore TC-150	Greenstore TC-180	Greenstore TC-210	Greenstore TC-250	Greenstore TC-300
Height	1,285mm	1,490mm	1,665mm	1,860mm	2,155mm
Diameter	570mm	570mm	570mm	570mm	570mm
Weight – dry	41kg	45kg	50kg	54kg	60kg
Volume domestic hot water	157 litres	187 litres	211 litres	241 litres	287 litres
Dedicated solar volume	65 litres	65 litres	105 litres	115 litres	115 litres
Standing heat loss – 24hr	1.632kWh/24hrs	1.824kWh/24hrs	1.944kWh/24hrs	2.136kWh/24hrs	2.304kWh/24hrs
ErP energy efficiency class/ Standing heat loss	C / 68W	C / 76W	C / 81W	C / 89W	C / 96W



We always recommend you consult a qualified OFTEC installer prior to choosing your boiler.

Useful numbers

Consumer Technical Helpline (Pre & Post Sales)

Tel: 0330 123 3366

Fax: 01905 752741

Email: technical-advice@uk.bosch.com

Brochures

Email: brochure-request@uk.bosch.com

or download instantly from our website

or telephone 0330 123 9119

Customer Service

Service Enquiries

Email: service-enquiries@uk.bosch.com

or telephone 0330 123 9559

Guarantee Registration

To register your Worcester guarantee,

please visit our website

worcester-bosch.co.uk/registration

or telephone 0330 123 2552

Share

We would love to see your new boiler and heating system.

Follow us on:  **@Heatingyourhome**

Tag your boiler pictures with: **#WarmAtHeart**

We are also on:



worcester-bosch.co.uk

Calls to and from Bosch Thermotechnology Ltd may be recorded for training and quality assurance purposes. Worcester, Bosch Group is a brand name of Bosch Thermotechnology Ltd.

This brochure is accurate at the date of printing, but may be superseded and should be disregarded if specification and/or appearances are changed in the interest of continued improvement. The statutory rights of the consumer are not affected.



By Appointment to
Her Majesty The Queen
Boiler Manufacturer
Worcester, Bosch Group
T/A Bosch Thermotechnology Ltd.
Worcester

