



ILLUSION RANGE

The Dudley Illusion range of support frames are ideal for use with most wall-hung sanitaryware.

They also provide a proven solution behind panelling and tiles and in fitted bathroom furniture.

SAVING WATER

Illusion A and V frames incorporate an integral Vantage cistern that can be quickly and easily converted to deliver 6/4, 5/3 or 4/2.6 litre dualflush to support the Code for Sustainable Homes, BREEAM and other initiatives.

Illusion Universal, Compact Universal and Freestanda frames can be installed in conjunction with any Dudley concealed cistern to provide a bespoke water saving solution.

SAVING TIME AND MONEY

Illusion frames have been specifically designed to simplify installation and minimise the associated costs.

Wall fixing brackets can be fixed at any angle through 180° whilst floor fixing brackets can be fixed through 360°.

This allows Illusion frames to be quickly fitted against flat walls and into corners or furniture.

UNRIVALLED FLEXIBILITY

A vast range of pushbuttons, push plates, levers and touch-free electronic sensors is available to provide the perfect finishing touch to any project.

Please refer to pages 23-26 for details.

Finding the perfect frame for every project.

	ILLUSION A (PAGE 37)	ILLUSION V (PAGE 38)	ILLUSION UNIVERSAL (PAGE 39)	ILLUSION COMPACT UNIVERSAL (PAGE 39)	ILLUSION FREESTANDA (PAGE 40)	ILLUSION BASIN (PAGE 41)	ILLUSION BIDET (PAGE 40)	SENTINEL (PAGE 41)
WALL-HUNG WC PAN	•	•	•	•	•			•
INTEGRAL CISTERN	•	•						
WALL-HUNG BASIN						•		
WALL-HUNG BIDET							•	

DUDLEY ILLUSION A™

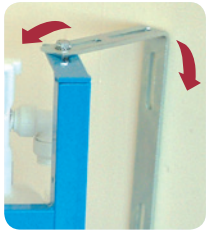

Reversible wall brackets can be fixed through 180°.

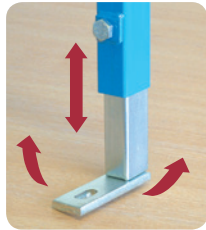

Legs are quickly and easily adjusted.

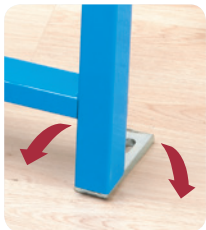

Floor brackets rotate through 360°.



Passes 400Kg load test.



Cistern approved by European Water Label Scheme.



USES

- Wall-hung WC pan support frame designed for use against flat walls and in corners.
- Ideal for most domestic and commercial applications.

FEATURES

- Unique design enables frame height to be set between 820mm and 1120mm for unrivalled installation flexibility.
- **Height adjustable.**
- Legs adjust to offer WC pan height fixing flexibility.

- Wall and floor fixing brackets can be fixed through 180 degrees and 360 degrees respectively to simplify installation.
- Strong steel tubular section construction.
- Blue painted finish and galvanised wall and floor brackets.
- Passes 400Kg load test based on EN 997.
- Flushbend and WC pan connector clamps.
- Integral factory fitted Dudley Vantage cistern (see page 19).
- Floor and WC pan fixing bolts included.

WATER-SAVING

VANTAGE CISTERN

- Provides 6/4 litre dualflush and quickly and easily converts before or after installation to 5/3 or 4/2.6 litre dualflush.
- 6 litre single flush also available.
- Delay fill Hydroflo inlet valve only allows cistern to start refilling once flushing is complete.
- European Water Label Scheme approved.
- Supports Code for Sustainable Homes and BREEAM.

OPTIONS

- Polystyrene cistern insulation jacket.
- Odour-extracting Panfan.

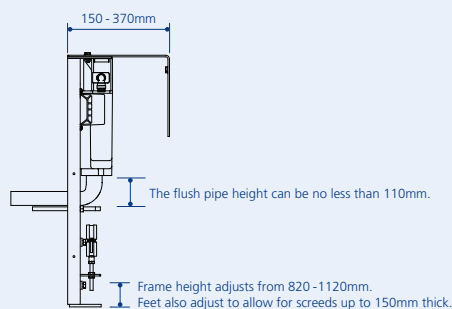
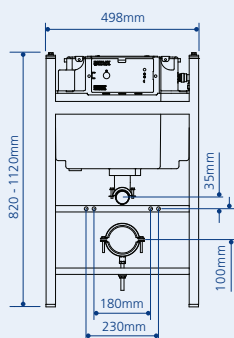

Can be supplied with a wide range of pushbuttons, push plates and electronic sensors. See pages 23-26 for details and dimensions.

The Illusion A frame can also be supplied with an integral Phantom lever operated cistern - please enquire.

DUDLEY ILLUSION V™

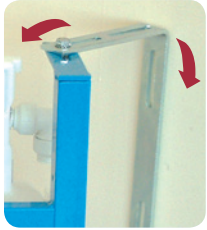

Reversible wall brackets can be fixed through 180°.

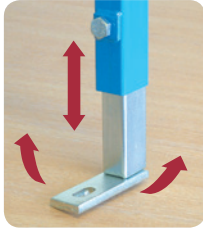

Legs are quickly and easily adjusted.

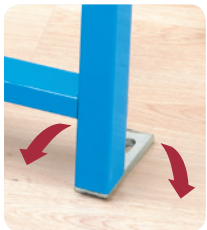

Floor brackets rotate through 360°.



Passes 400Kg load test.



Cistern approved by European Water Label Scheme.



USES

- Wall-hung WC pan support frame designed for use against flat walls and in corners.
- Ideal for most domestic and commercial applications.

FEATURES

- Wall and floor fixing brackets can be fixed through 180 degrees and 360 degrees respectively to simplify installation.
- Legs adjust to offer WC pan height fixing flexibility.

- Strong steel tubular section construction.
- Blue painted finish and galvanised wall and floor brackets.
- Passes 400Kg load test based on EN 997.
- Flushbend and WC pan connector clamps.
- Integral factory fitted Dudley Vantage cistern (see page 19).
- Floor and WC pan fixing bolts included.

WATER-SAVING

Vantage cistern

- Provides 6/4 litre dualflush and quickly and easily converts before or after installation to 5/3 or 4/2.6 litre dualflush.
- 6 litre single flush also available.
- Delay fill Hydroflo inlet valve only allows cistern to start refilling once flushing is complete.
- European Water Label Scheme approved.
- Supports Code for Sustainable Homes and BREEAM.

OPTIONS

- Polystyrene cistern insulation jacket.
- Odour-extracting Panfan.

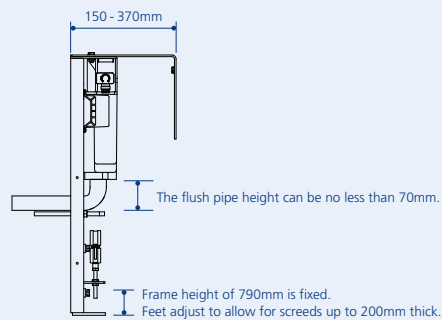
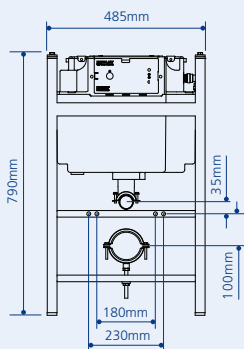

Can be supplied with a wide range of pushbuttons, push plates and electronic sensors. See page 23-26 for details and dimensions.

DUDLEY ILLUSION UNIVERSAL™



DUDLEY ILLUSION COMPACT UNIVERSAL™

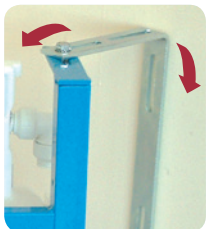
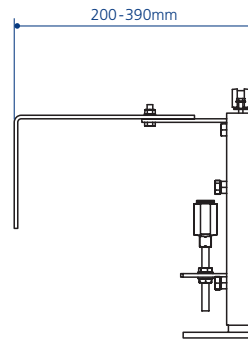
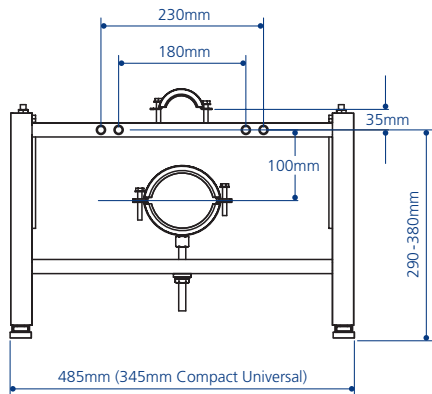
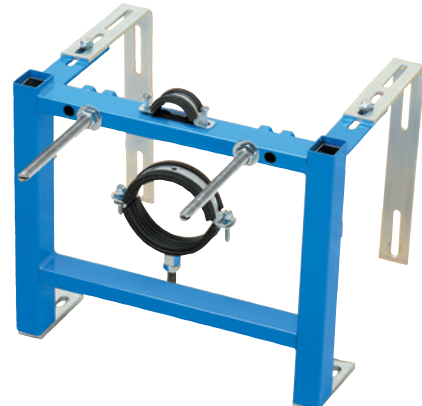

Reversible wall brackets can be fixed through 180°.

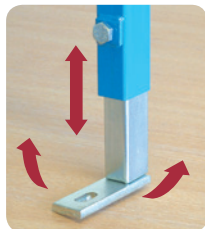

Legs are quickly and easily adjusted.

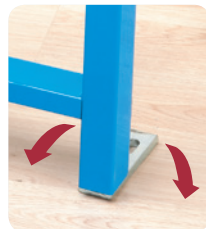

Floor brackets rotate through 360°.



Passes 400Kg load test.

USES

- Wall-hung WC pan support frame designed for use against flat walls and in corners.
- Ideal for most domestic and commercial applications. With a width of just 345mm, the Compact Universal is perfect for bathroom furniture and other confined spaces.

FEATURES

- Wall and floor fixing brackets can be fixed through 180 degrees and 360 degrees respectively to simplify installation.
- Legs adjust to offer WC pan height fixing flexibility.
- Strong steel tubular section construction.
- Blue painted finish and galvanised wall and floor brackets.
- Passes 400Kg load test based on EN 997.

- Flushbend and WC pan connector clamps.
- Floor and WC pan fixing bolts included.

OPTIONS

- Can be installed in conjunction with all Dudley concealed cisterns to provide a tailor made solution for every project.

DUDLEY ILLUSION FREESTANDA™

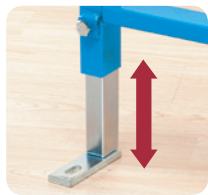

Legs are quickly and easily adjusted.



Passes 400Kg load test.

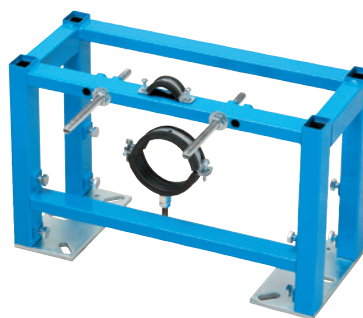

USES

- Free-standing wall-hung WC pan support frame designed for use where no solid rear wall fixing is available.
- Can be used against flat walls and in corners.
- Ideal for most domestic and commercial applications.

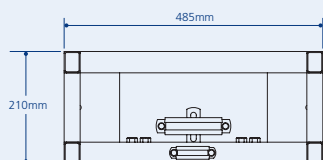

FEATURES

- Sturdy floor fixing brackets remove the need for rear wall fixing.
- Legs adjust to offer WC pan height fixing flexibility.
- Strong steel tubular section construction.

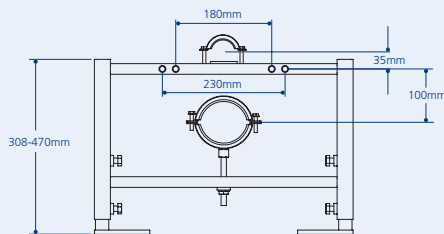

- Blue painted finish and galvanised wall and floor brackets.
- Passes 400Kg load test based on EN 997.
- Flushbend and WC pan connector clamps.
- Floor and WC pan fixing bolts included.

OPTIONS

- Can be installed in conjunction with all Dudley concealed cisterns to provide a tailor made solution for every project.

DUDLEY ILLUSION BIDET™



Reversible wall brackets can be fixed through 180°.

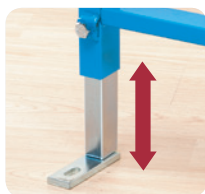

Legs are quickly and easily adjusted.

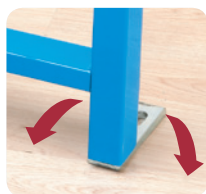

Floor brackets rotate through 360°.



Passes 400Kg load test.

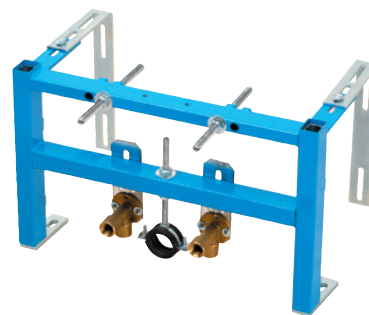

USES

- Wall-hung bidet support frame designed for use against flat walls and in corners.

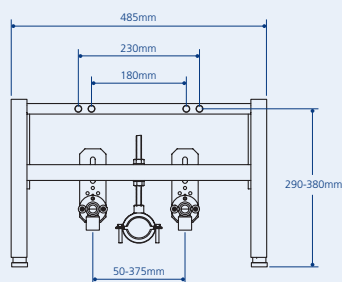

- Ideal for most domestic and commercial applications.

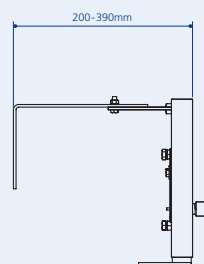

FEATURES

- Wall and floor fixing brackets can be fixed through 180 degrees and 360 degrees respectively to simplify installation.
- Legs adjust to offer bidet height fixing flexibility.
- Strong steel tubular section construction.
- Blue painted finish and galvanised wall and floor brackets.
- Passes 400Kg load test based on EN 997.
- Floor and bidet fixing bolts included.

DUDLEY ILLUSION BASIN™



Reversible wall brackets can be fixed through 180°.

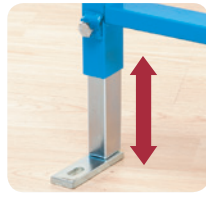

Legs are quickly and easily adjusted.

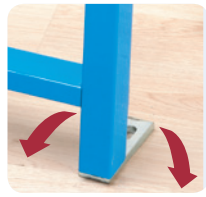

Floor brackets rotate through 360°.

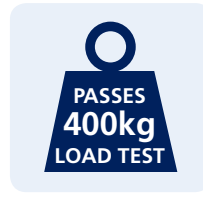

Passes 400Kg load test.



USES

- Wall-hung basin support frame designed for use against flat walls and in corners.

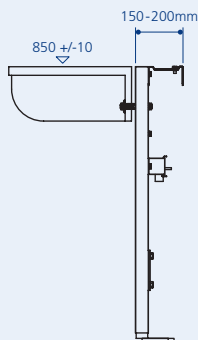

- Ideal for most domestic and commercial applications.

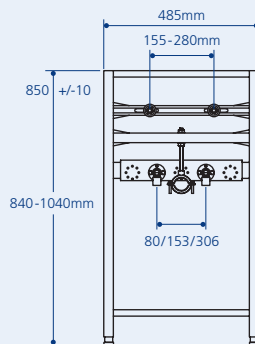

FEATURES

- Wall and floor fixing brackets can be fixed through 180 degrees and 360 degrees respectively to simplify installation.
- Legs adjust to offer basin height fixing flexibility.
- Strong steel tubular section construction.
- Blue painted finish and galvanised wall and floor brackets.
- Passes 400Kg load test based on EN 997.
- Floor and basin fixing bolts included.

DUDLEY ILLUSION SENTINEL™



Vertical slot provides pan height fixing flexibility.



Passes 400Kg load test.

USES

- Wall-hung WC pan support brackets.
- Ideal for most domestic and commercial applications.

FEATURES

- Strong cast iron construction.
- Vertical slot offers WC pan height fixing flexibility.
- Grey painted finish.
- Passes 400Kg load test based on EN 997.
- Floor and WC pan fixing bolts available as optional extras.

