

Data sheet: Wilo-Yonos MAXO 25/0,5-10

Pump curves

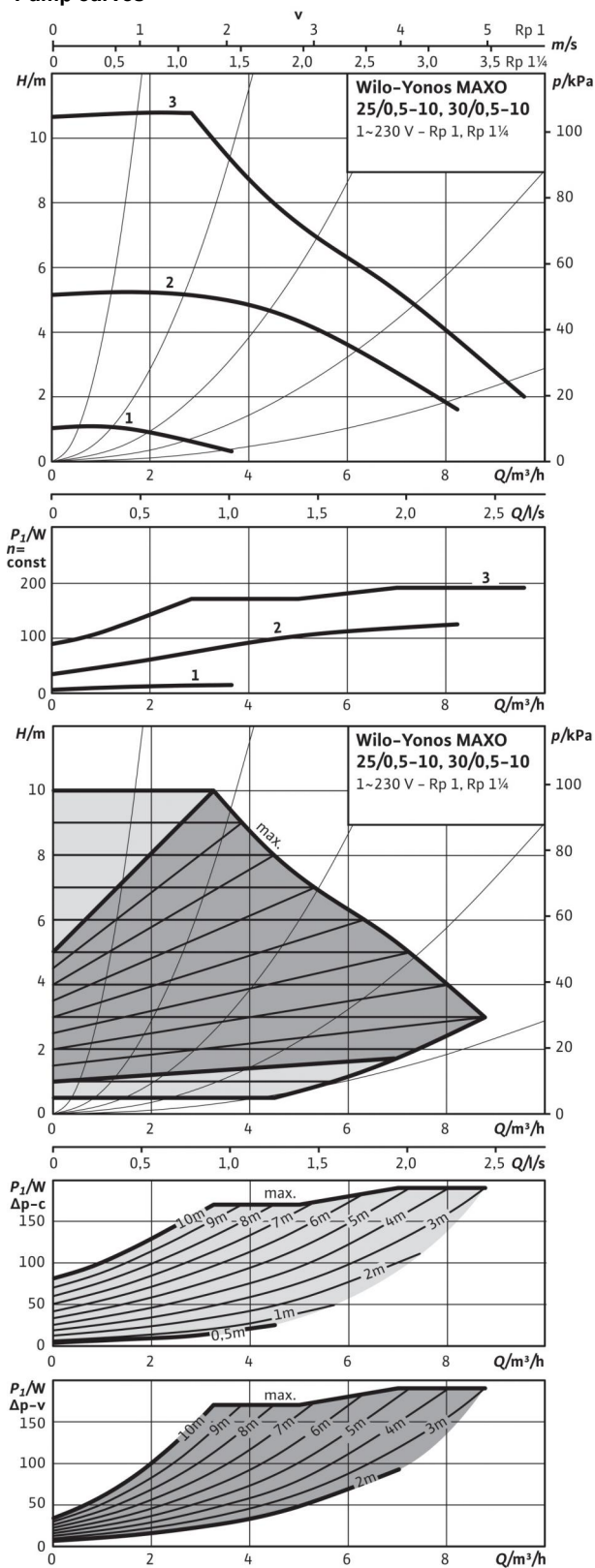

Approved fluids (other fluids on request)

Heating water (in accordance with VDI 2035)
Water-glycol mixtures (max. 1:1; above 20% admixture, the pumping data must be checked)

Permitted field of application

Temperature range at max. ambient temperature +40 °C
Maximum permissible operating pressure P_{max}

Pipe connections

Threaded pipe union
Thread
Overall length l_0

Motor/electronics

Energy efficiency index (EEI)
Electromagnetic compatibility
Emitted interference
Interference resistance
Speed control
Protection class
Insulation class
Mains connection
Rated power P_2
Speed n
Power consumption P_1
Current consumption I
Motor protection
Threaded cable connection PG

Materials

Pump housing
Impeller
Pump shaft
Bearing

Minimum suction head at suction port for avoiding cavitation at water pumping

Temperature
Minimum suction head at 50 / 95 / 110 °C

Information for order placements

Make
Type
Art no.
Weight approx. m

•	
•	
-20...+110 °C	
10 bar	
Rp 1	
G 1½	
180 mm	
≤ 0.20	
EN 61800-3	
EN 61000-6-3	
EN 61000-6-2	
Frequency converter	
IP X4D	
F	
1~230 V, 50/60 Hz	
140.00 W	
1000 - 4450 rpm	
5 - 190 W	
0.08 - 1.3 A	
integrated	
M20x1.5	
Grey cast iron (EN-GJL-200)	
Plastic (PPE - 30% GF)	
Stainless steel (X30CR13)	
Carbon, metal impregnated	
3 / 10 / 16 m	
Wilo	
Yonos MAXO 25/0,5-10	
2120640	
4.5 kg	

Data sheet: Wilo-Yonos MAXO 25/0,5-10

Dimension drawing

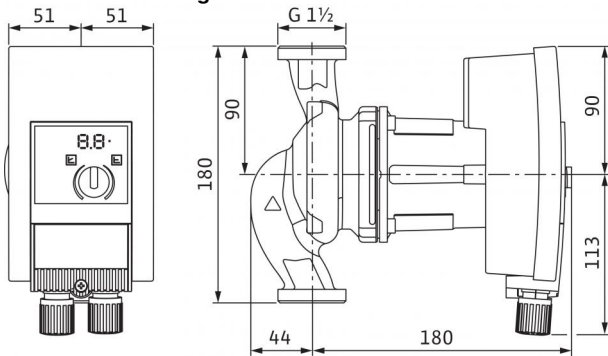

Terminal diagram

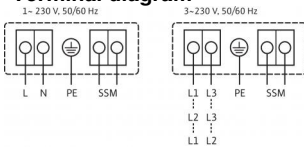

SSM:

Collective fault signal

(NC contact in accordance with VDI 3814, load capacity 1 A, 250 V ~)

For function see chapter "Consulting guide"