

20
16



Enclosures

THE BOLD LOOK
OF **KOHLER**®

Enhancing your home, improving your life

Choosing and planning a new bathroom is an exciting, creative experience. It's a rare opportunity to transform one of the most important parts of your home – where you can relax, refresh and revitalise, and where your daily routine begins and ends.

KOHLER® began designing bathroom products nearly 140 years ago, and we've seen a lot change in that time. In fact, we've been at the forefront of innovation, and our showering products lead the way. From the sleek, award-winning Torsion®, to the highly configurable Minima® NG, we offer a wide range of shower enclosure options.

We've earned a reputation for iconic design and uncompromising quality. With everything from shower doors to shower trays, our wide selection lets you easily upgrade your existing bathroom or custom design a new one.

Table of Contents

Minima® NG	05
Minima® NG Made-to-Measure	23
Torsion®	35
Skyline®	55
Walk-In/Dividers	83
Bath Screens	93
Shower Trays	97

KOHLER Quality.

Kohler develops, tests and handcrafts shower enclosures that last a lifetime. Through hard work and no compromise, we have built a reputation as solid as every product we create. We're passionate about what we do and proud of our heritage. Yet we're always looking ahead and ready to evolve. We embrace design innovation whilst never sacrificing the quality and craftsmanship of the Kohler brand, since 1873.

Minima[®]NG

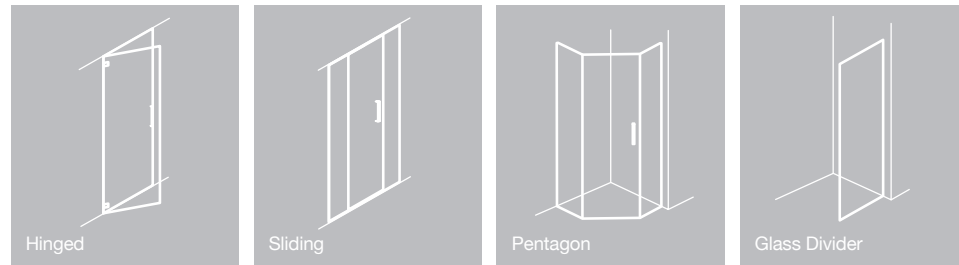

Torsion[®]



Skyline[®]

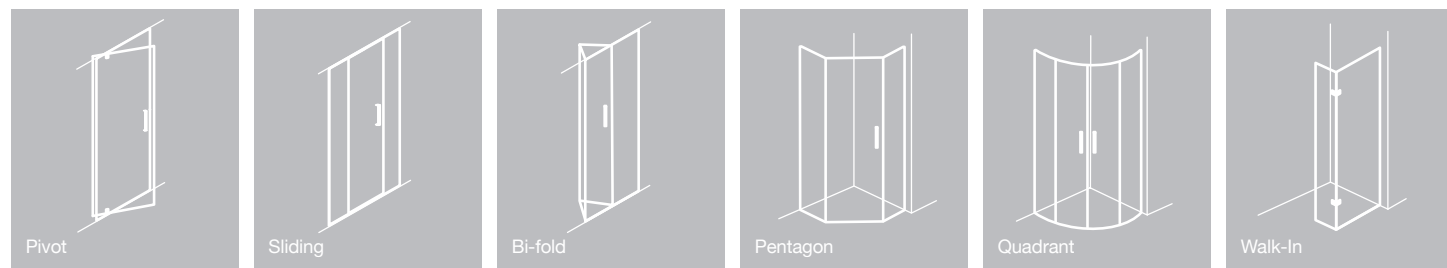

Walk-In

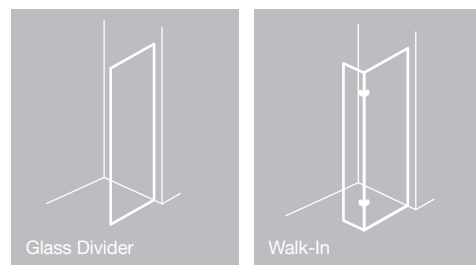

	MINIMA [®] NG PAGE 5	TORSION [®] PAGE 35	SKYLINE [®] PAGE 55	WALK-IN & DIVIDERS PAGE 83
Bi-fold door			● See page 63	
Bi-fold enclosure			● See page 65	
Bi-fold pentagon			● See page 67	
Divider Panel	● See page 13			● See page 85
Hinged door	● See page 7	● See page 43		
Hinged enclosure	● See page 9	● See page 45		
Hinged pentagon	● See page 11	● See page 47		
In-swing door		● See page 37		
In-swing enclosure		● See page 39		
In-swing pentagon		● See page 41		
Pivot door			● See page 57	
Pivot enclosure			● See page 59	
Pivot pentagon			● See page 61	
Sliding door	● See page 17	● See page 49	● See page 69	
Sliding enclosure	● See page 19	● See page 51	● See page 71	
Quadrant		● See page 53	● See page 77	
Walk-in			● See page 79	● See page 87

Icon Key

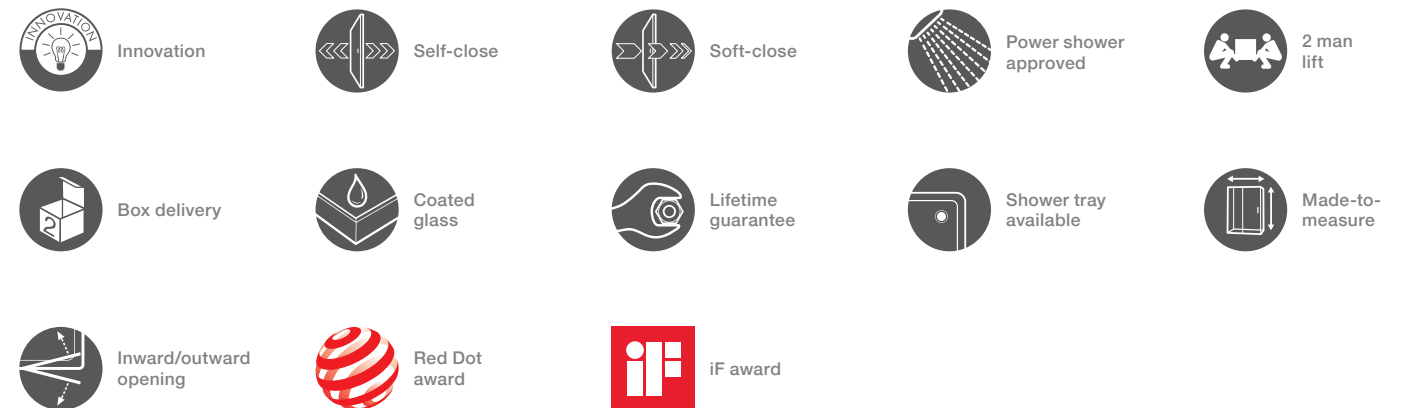

Minima[®] NG

Beautifully designed. Perfectly sculpted. The Minima[®] NG shower door collection features the sleekest bathroom designs in the market. Whether it is a contemporary hinged or sliding door, side panel or bath screen, the Minima[®] NG range has them all. Each and every one is designed with a timeless feel and with longevity as an essential. We provide a made-to-measure service for your peace of mind, allowing you to create the perfect showering solution. Subtle. Stylish. Simply unique. These are the things that turn a house into a home. These are the attributes for your dream bathroom.

Product Pages

301 Hinged Door	07
302 Hinged Enclosure	09
305 Hinged Pentagon	11
327 Divider Panel	13
331 Hinged Door with in-line Panel	15
391 Sliding Door	17
392 Sliding Enclosure	19
Minima [®] NG Made-to-Measure	23

Features

- 10mm thick safety glass
- Soft self-close hinges
- Two handle options
- Hinged doors can open inwards or outwards – decide upon installation
- Made-to-Measure options available



Enclosures

Minima® NG Hinged Door 301

Step 1: Choose your overall door width (A+B)

Width (mm)	Frame Adjustment (mm)	Code	RRP Price
800	20	301.080NG	£1,080.00
900	20	301.090NG	£1,140.00
1000	20	301.100NG	£1,200.00
1100	20	301.110NG	£1,260.00
1200	20	301.120NG	£1,320.00
1300	20	301.130NG	£1,380.00

Step 2: Choose your inline panel width (A)

Width (mm)	Description	Code
300	Minima® NG Hinge ALC Inline Panel	1.1825.009
350	Minima® NG Hinge ALC Inline Panel	1.1825.010
400	Minima® NG Hinge ALC Inline Panel	1.1825.011
450	Minima® NG Hinge ALC Inline Panel	1.1825.012
500	Minima® NG Hinge ALC Inline Panel	1.1825.013

Step 3: Choose your door width (B) and handle style

Width (mm)	Description	Door opening aperture	Code
500	Minima® NG Hinge Door Geometric Handle	466mm	1.1825.001
600	Minima® NG Hinge Door Geometric Handle	566mm	1.1825.002
700	Minima® NG Hinge Door Geometric Handle	666mm	1.1825.003
800	Minima® NG Hinge Door Geometric Handle	766mm	1.1825.004

Or

500	Minima® NG Hinge Door Soft Handle	466mm	1.1825.005
600	Minima® NG Hinge Door Soft Handle	566mm	1.1825.006
700	Minima® NG Hinge Door Soft Handle	666mm	1.1825.007
800	Minima® NG Hinge Door Soft Handle	766mm	1.1825.008

Technical drawing

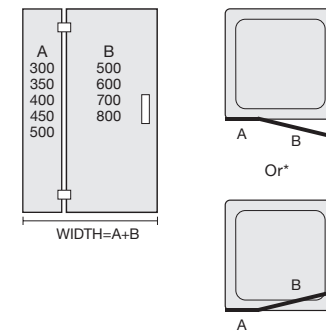

Optional filler section

Item	Code	Price
Hinge standard profile	1.1825.282	£75.00
Hinge alcove closing profile	1.1825.283	£75.00

Handle options



Geometric

Soft

Seat option



Choreograph® Seat
(See page 90)

Key Features

- Unhanded – orientation to be decided on installation by engineer
- Alternative door and panel combinations at the same price
- Mix and match panels and doors to achieve your perfect installation
- Soft self-close hinges
- Height from top of the tray 2000mm
- 10mm thick safety glass
- Minimum tray width 40mm
- Choice of soft or geometric handle style
- Nominal sizes are designed to fit onto standard sizes of shower tray
- Best-in-class door action
- Made-to-Measure options available specifically for your space
- If no door size is specified we will default to the biggest door opening available
- Door can open inwards or outwards – to be decided on installation by engineer*

How to order:

Step 1

Choose your overall door width (A+B)

Step 2

Choose your inline panel width (A)

Step 3

Choose your door width (B) and handle style

- Self-close
- 2 man lift
- Soft-close
- Coated glass
- Power shower approved
- Shower tray available
- Made-to-measure
- Lifetime guarantee (See page 107)
- Inward/outward opening

301 Minima® NG alcove hinged door with geometric handle
900 x 900mm shower tray

Enclosures

Minima® NG Hinged Enclosure 302

Step 1: Choose your overall door width (A+B)

Width (mm)	Min (mm)	Max (mm)	Code	RRP Price
800	754	767	302.080NG	£1,080.00
900	854	867	302.090NG	£1,140.00
1000	954	967	302.100NG	£1,200.00
1100	1054	1067	302.110NG	£1,260.00
1200	1154	1167	302.120NG	£1,320.00
1300	1254	1267	302.130NG	£1,380.00

Step 2: Choose your inline panel width (A)

Width (mm)	Description	Code
300	Minima® NG Hinge Inline Panel	1.1825.014
350	Minima® NG Hinge Inline Panel	1.1825.015
400	Minima® NG Hinge Inline Panel	1.1825.016
450	Minima® NG Hinge Inline Panel	1.1825.017
500	Minima® NG Hinge Inline Panel	1.1825.018

Step 3: Choose your door width (B) and handle style

Width (mm)	Description	Door opening aperture	Code
500	Minima® NG Hinge Door Geometric Handle	466mm	1.1825.001
600	Minima® NG Hinge Door Geometric Handle	566mm	1.1825.002
700	Minima® NG Hinge Door Geometric Handle	666mm	1.1825.003
800	Minima® NG Hinge Door Geometric Handle	766mm	1.1825.004

Or

500	Minima® NG Hinge Door Soft Handle	466mm	1.1825.005
600	Minima® NG Hinge Door Soft Handle	566mm	1.1825.006
700	Minima® NG Hinge Door Soft Handle	666mm	1.1825.007
800	Minima® NG Hinge Door Soft Handle	766mm	1.1825.008

Choose your side panel depth (D)

Depth (mm)	Min (mm)	Max (mm)	Adjust	Code	RRP Price
762	716	729	13	1.1825.032	£600.00
800	754	767	13	1.1825.033	£624.00
900	854	867	13	1.1825.034	£648.00
1000	954	967	13	1.1825.035	£672.00
1200	1154	1167	13	1.1825.036	£696.00
1400	1340	1353	13	1.1825.037	£720.00

Technical drawing

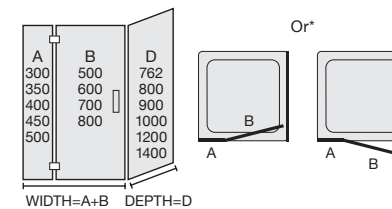

Optional filler section

Item	Code	Price
Hinge standard profile	1.1825.282	£75.00

Handle options



Geometric

Soft

Seat option



Choreograph® Seat
(See page 90)

Key Features

- Unhanded – orientation to be decided on installation by engineer
- Alternative door and panel combinations at the same price
- Mix and match panels and doors to achieve your perfect installation
- L-shaped bracket supplied with all side panels
- Additional 90° bracing bar supplied with panels wider than 1000mm
- Soft self-close hinges
- Height from top of the tray 2000mm
- 10mm thick safety glass
- Minimum tray width 40mm
- Choice of soft or geometric handle style
- Nominal sizes are designed to fit onto standard sizes of shower tray
- Best-in-class door action
- Made-to-Measure options available specifically for your space
- If no door size is specified we will default to the biggest door opening available
- Door can open inwards or outwards – to be decided on installation by engineer*

How to order:

Step 1

Choose your overall door width (A+B)

Step 2

Choose your inline panel (A)

Step 3

Choose your door width (B) & handle style

Step 4

Choose your side panel depth (D)

- Self-close
- 2 man lift
- Soft-close
- Coated glass
- Power shower approved
- Shower tray available
- Made-to-measure
- Lifetime guarantee (See page 107)
- Inward/outward opening

Enclosures

Minima® NG Hinged Pentagon 305

Step 1: Choose your complete enclosure size

Width (mm)	Min (mm)	Max (mm)	Adjust	Code	RRP Price
900 x 900	869-881	869-881	12	305.090NG	£1,680.00
1000 x 1000	969-981	969-981	12	305.100NG	£1,800.00
1200 x 900	1169-1181	869-881	12	305.120090NG	£1,800.00
1400 x 900	1369-1381	869-881	12	305.140090NG	£1,860.00

Step 2: Choose which panel width your door will hinge from

Width (mm)	Description	Code
400	Minima® Pentagon Hinge Panel	1.1825.024
500	Minima® Pentagon Hinge Panel	1.1825.025
700	Minima® Pentagon Hinge Panel	1.1825.026
900	Minima® Pentagon Hinge Panel	1.1825.027

Step 3: Choose your handle style

Width (mm)	Description	Door opening aperture	Code
700	Minima® NG Hinge Door Geometric Handle	666mm	1.1825.003
700	Minima® NG Hinge Door Soft Handle	666mm	1.1825.007

Step 4: Choose which panel width your door will close onto

Width (mm)	Description	Code
400	Minima® Pentagon Closing Panel	1.1825.028
500	Minima® Pentagon Closing Panel	1.1825.029
700	Minima® Pentagon Closing Panel	1.1825.030
900	Minima® Pentagon Closing Panel	1.1825.031

Optional filler section

Item	Code	Price
Hinge standard profile	1.1825.282	£75.00

N.B Kohler® do not provide Pentagon trays above 1200 x 900mm

Technical drawing

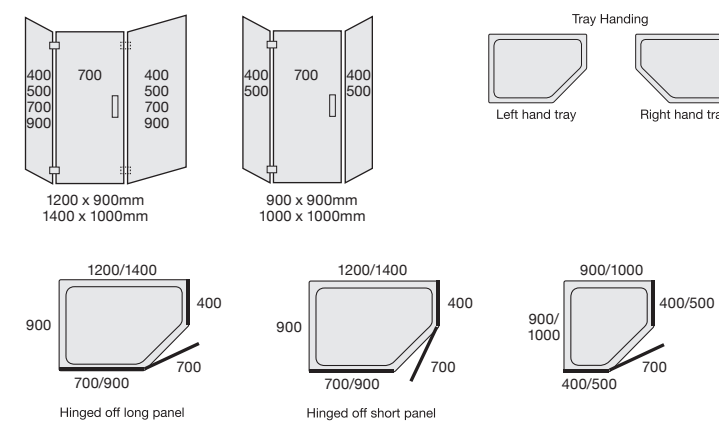

Handle options



Geometric Soft

Seat option



Choreograph® Seat (See page 90)

Key Features

- Unhanded – orientation to be decided on installation by engineer
- Specify hinge mounted on large or small panel when ordering extended units
- Extended trays are handed, please specify left or right when ordering
- Alternative door and panel combinations at the same price
- Mix and match panels and doors to achieve your perfect installation
- L-shaped bracket supplied with all pentagon panels
- Soft self-close hinges
- Height from top of the tray 2000mm
- 10mm thick safety glass
- Minimum tray width 40mm
- Choice of soft or geometric handle style
- Nominal sizes are designed to fit onto standard sizes of shower trays
- Best-in-class door action
- Made-to-measure options available specifically for your space

How to order:

Step 1

Choose your complete enclosure size

Step 2

Choose which panel width your door will hinge from

Step 3

Choose your handle style

Step 4

Choose which panel the door will close onto

- Self-close
- 2 man lift
- Soft-close
- Coated glass
- Power shower approved
- Shower tray available
- Made-to-measure
- Lifetime guarantee (See page 107)

305 Minima® NG hinged pentagon with geometric handle 1200 x 900mm shower tray

Minima® NG Glass Divider Panel 327

Step 1: Choose your complete panel size (A)

Width (mm)	Min (mm)	Max (mm)	Adjust	Code	RRP Price
400	399	411	12	1.1825.059	£318.00
800	750	762	12	1.1825.060	£624.00
900	850	862	12	1.1825.061	£648.00
1000	950	962	12	1.1825.062	£672.00
1200	1150	1162	12	1.1825.063	£696.00
1400	1336	1348	12	1.1825.064	£720.00

When choosing a glass divider panel, please be aware that spray/mist may extend beyond the length of the glass panel, the amount will depend upon the power of the shower and its location. We would recommend use of these products with tiled floors.

Technical drawing

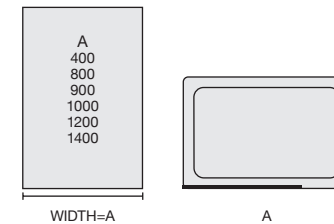

N.B Recommended opening 600mm

Optional filler section

Item	Code	Price
Hinge standard profile	1.1825.282	£75.00

Seat option



Choreograph® Seat
(See page 90)

Key Features

- Unhanded – orientation to be decided on installation by engineer
- L-shaped bracket supplied with all divider panels
- Additional 90° bracing bar supplied with panels wider than 1000mm
- Height from top of the tray to glass is 2000mm
- Minimum tray width 40mm
- Nominal sizes are designed to fit onto standard sizes of shower tray
- 10mm thick safety glass
- Glass coating as standard
- Made-to-Measure options available specifically for your space



Power shower approved



Coated glass



Made-to-measure



Shower tray available



2 man lift



Lifetime guarantee
(See page 107)

Enclosures

Minima® NG Hinged Door 331

Step 1: Choose your overall door width (A+B+C)

Width (mm)	Min (mm)	Max (mm)	Adjust	Code	RRP Price
1200	1170	1195	25	331.120NG	£1,440.00
1300	1270	1295	25	331.130NG	£1,500.00
1400	1370	1395	25	331.140NG	£1,560.00
1500	1470	1495	25	331.150NG	£1,620.00
1600	1570	1595	25	331.160NG	£1,680.00
1700	1670	1695	25	331.170NG	£1,740.00

Step 2: Choose which panel width your door will hinge from (A)

Width (mm)	Description	Code
300	Minima® NG Hinge Inline Panel	1.1825.065
350	Minima® NG Hinge Inline Panel	1.1825.066
400	Minima® NG Hinge Inline Panel	1.1825.067
450	Minima® NG Hinge Inline Panel	1.1825.068
500	Minima® NG Hinge Inline Panel	1.1825.069

Step 3: Choose your door width (B) & handle style

Width (mm)	Description	Door opening aperture	Code
600	Minima® NG Hinge Door Geometric Handle	566mm	1.1825.002
700	Minima® NG Hinge Door Geometric Handle	666mm	1.1825.003

Or

600	Minima® NG Hinge Door Soft Handle	566mm	1.1825.006
700	Minima® NG Hinge Door Soft Handle	666mm	1.1825.007

Step 4: Choose which panel width your door will close onto (C)

Width (mm)	Description	Code
300	Minima® NG Closing Inline Panel	1.1825.019
350	Minima® NG Closing Inline Panel	1.1825.020
400	Minima® NG Closing Inline Panel	1.1825.021
450	Minima® NG Closing Inline Panel	1.1825.022
500	Minima® NG Closing Inline Panel	1.1825.023

Technical drawing

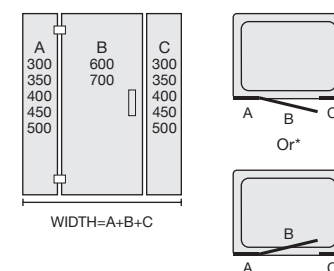

Handle options



Geometric

Soft

Optional filler section

Item	Code	Price
Hinge standard profile	1.1825.282	£75.00

Seat option



Choreograph® Seat
(See page 90)

Key Features

- Unhanded – orientation to be decided on installation by engineer
- Alternative door and panel combinations at the same price
- Mix and match panels and doors to achieve your perfect installation
- Soft self-close hinges
- Height from top of the tray 2000mm
- 10mm thick safety glass
- Minimum tray width 40mm
- Choice of soft or geometric handle style
- Nominal sizes are designed to fit onto standard sizes of shower tray
- Best-in-class door action
- Made-to-Measure options available specifically for your space
- If no door size is specified we will default to the biggest door opening available
- Door can open inwards or outwards – to be decided on installation by engineer*

How to order:

Step 1

Choose your overall door width (A+B+C)

Step 2

Choose which panel width your door will hinge from (A)

Step 3

Choose your door width (B) & handle style

Step 4

Choose which panel width your door will close onto (C)

- Self-close
- 2 man lift
- Soft-close
- Coated glass
- Power shower approved
- Shower tray available
- Made-to-measure
- Lifetime guarantee (See page 107)
- Inward/outward opening



391 Minima[®] NG alcove sliding door with geometric handle
1200 x 900mm shower tray

Minima[®] NG Sliding Door 391

Step 1: Choose your overall door width (A+B)

Width (mm)	Handle	Min (mm)	Max (mm)	Adjust	Code	RRP Price
1200	Geometric / Soft	1169	1194	25	391.120NG	£1,320.00
1400	Geometric / Soft	1369	1394	25	391.140NG	£1,500.00
1500	Geometric / Soft	1469	1494	25	391.150NG	£1,560.00
1600	Geometric / Soft	1569	1594	25	391.160NG	£1,740.00
1700	Geometric / Soft	1669	1694	25	391.170NG	£1,800.00

Step 2: Choose your door width & handle style

Width (mm)	Description	Door opening aperture	Code
1200	Minima [®] NG Sliding Door Geometric Handle	450mm	C1.1825.044G
1400	Minima [®] NG Sliding Door Geometric Handle	550mm	C1.1825.045G
1500	Minima [®] NG Sliding Door Geometric Handle	575mm	C1.1825.046G
1600	Minima [®] NG Sliding Door Geometric Handle	650mm	C1.1825.047G
1700	Minima [®] NG Sliding Door Geometric Handle	675mm	C1.1825.048G

Or

1200	Minima [®] NG Sliding Door Soft Handle	450mm	C1.1825.044S
1400	Minima [®] NG Sliding Door Soft Handle	550mm	C1.1825.045S
1500	Minima [®] NG Sliding Door Soft Handle	575mm	C1.1825.046S
1600	Minima [®] NG Sliding Door Soft Handle	650mm	C1.1825.047S
1700	Minima [®] NG Sliding Door Soft Handle	675mm	C1.1825.048S

Technical drawings

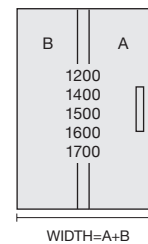

Optional filler section

Item	Code	Price
Hinge standard profile	1.1825.285	£75.00

Handle options



Geometric

Soft

Seat option



Choreograph[®] Seat
(See page 90)

Key Features

- Unhanded – orientation to be decided on installation by engineer
- Integrated soft self-close functionality
- Height from top of the tray to top of lintel is 2000mm
- Super precision bearings for smooth operation
- Minimum tray width 60mm
- Choice of soft or geometric handle style
- Nominal sizes are designed to fit onto standard sizes of shower trays
- Best-in-class door action
- Extra height available through Made-to-Measure options

How to order:

Step 1

Choose your overall door width (A+B)

Step 2

Choose your door width & handle style

- Self-close
- 2 man lift
- Soft-close
- Coated glass
- Power shower approved
- Shower tray available
- Made-to-measure
- Lifetime guarantee (See page 107)

Enclosures

Minima® NG Sliding Enclosure 392

Step 1: Choose your overall door width (A+B)

Width (mm)	Min (mm)	Max (mm)	Adjust	Code	RRP Price
1200	1173	1186	13	392.120NG	£1,320.00
1400	1373	1386	13	392.140NG	£1,500.00
1500	1473	1486	13	392.150NG	£1,560.00
1600	1573	1586	13	392.160NG	£1,740.00
1700	1673	1686	13	392.170NG	£1,800.00

Step 2: Choose your door width and handle style

Width (mm)	Description	Door opening aperture	Code
1200	Minima® NG Sliding Door Geometric Handle	450mm	C1.1825.049G
1400	Minima® NG Sliding Door Geometric Handle	550mm	C1.1825.050G
1500	Minima® NG Sliding Door Geometric Handle	575mm	C1.1825.051G
1600	Minima® NG Sliding Door Geometric Handle	650mm	C1.1825.052G
1700	Minima® NG Sliding Door Geometric Handle	675mm	C1.1825.053G

Or

1200	Minima® NG Sliding Door Soft Handle	450mm	C1.1825.049S
1400	Minima® NG Sliding Door Soft Handle	550mm	C1.1825.050S
1500	Minima® NG Sliding Door Soft Handle	575mm	C1.1825.051S
1600	Minima® NG Sliding Door Soft Handle	650mm	C1.1825.052S
1700	Minima® NG Sliding Door Soft Handle	675mm	C1.1825.053S

Step 3: Choose your side panel depth (D)

Depth (mm)	Min (mm)	Max (mm)	Adjust	Code	RRP Price
762	734	747	13	1.1825.054	£432.00
800	774	787	13	1.1825.055	£504.00
900	874	887	13	1.1825.056	£648.00

Technical drawings

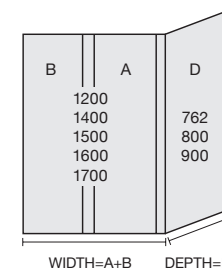

Optional filler section

Item	Code	Price
Sliding door profile	1.1825.285	£75.00
Side panel profile	1.1825.284	£75.00

Handle options



Geometric

Soft

Seat option



Choreograph® Seat
(See page 90)

Key Features

- Unhanded – orientation to be decided on installation by engineer
- Integrated soft self-close functionality
- Height from top of the tray to top of lintel is 2000mm
- L-shaped bracket supplied with all side panels
- Super precision bearings for smooth operation
- Minimum tray width 60mm
- Choice of soft or geometric handle style
- Nominal sizes are designed to fit onto standard sizes of shower trays
- Best-in-class door action
- Extra height available through Made-to-Measure options

How to order:

Step 1

Choose your overall door width (A+B)

Step 2

Choose your door width and handle style

Step 3

Choose your side panel depth (D)

- Self-close
- 2 man lift
- Soft-close
- Coated glass
- Power shower approved
- Shower tray available
- Made-to-measure
- Lifetime guarantee (See page 107)

minima[®]ng

HINGE MECHANISM

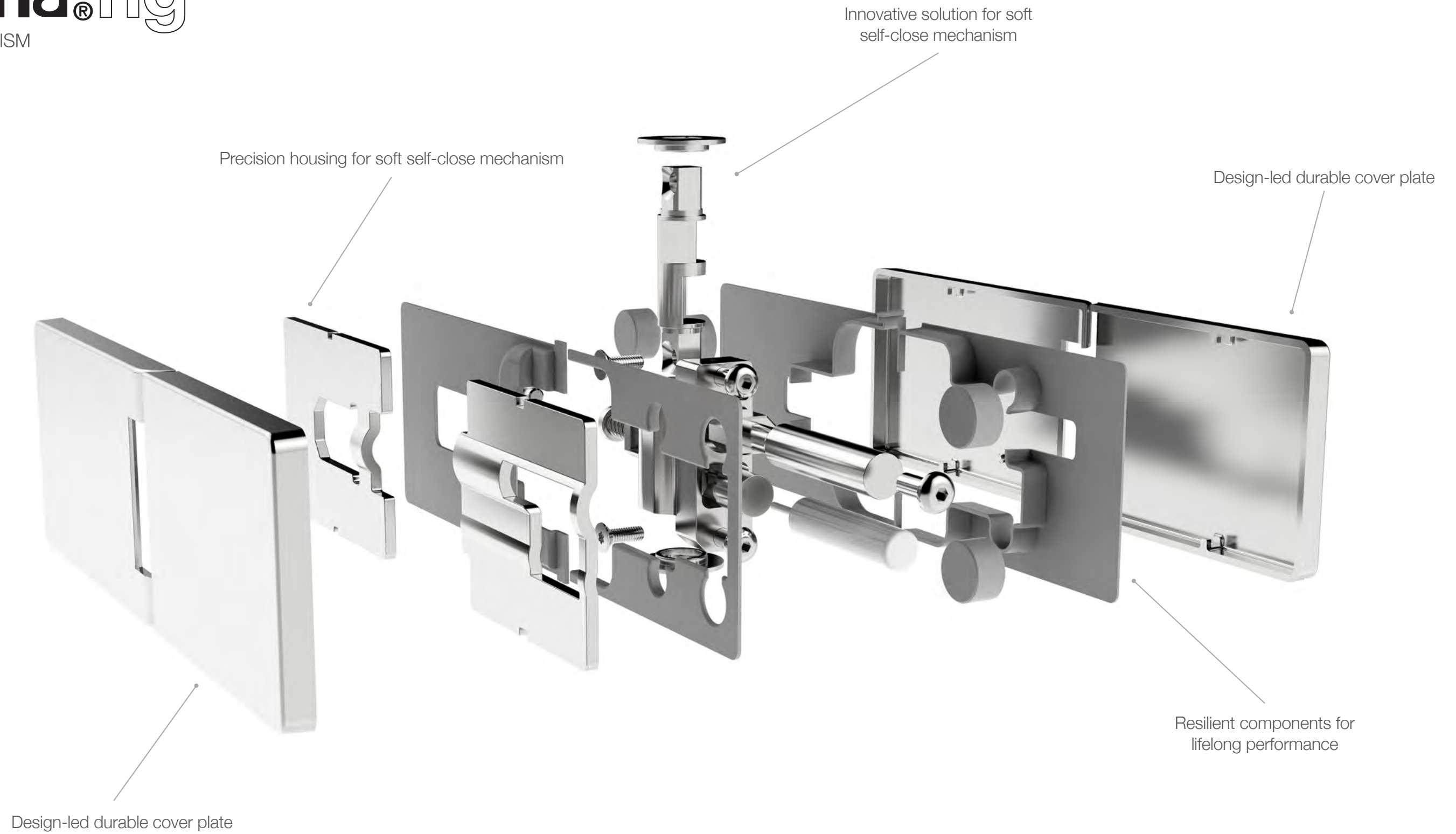

Minima[®] NG Made-to-Measure

KOHLER[®] invites you to create your own unique showering space suitable for all your needs. Our beautiful glass panels are up to 2 metres wide and 2.4 metres tall; you can build the shower of your dreams or renovate a suitable space. Kohler provides a home measure and installation service to ensure your Minima[®] NG Made-to-Measure door or enclosure is a perfect fit.

Product Pages

301 Hinged Door	26
302 Hinged Enclosure	27
305 Hinged Pentagon	28
327 Divider Panel	29
331 Hinged Door with in-line Panel	30
391 Sliding Door	31
391 Sliding Enclosure	32

Features

- Maximum panel width 2 metres
- Two handle options
- Dwarf wall options
- Suitable for difficult angles and notches
- Home measure service available



Minima[®] NG Made-to-Measure

What is it?

The Made-to-Measure service helps you create the shower of your dreams with a realistic appraisal of the installation and to spot any potential pitfalls up front. Our trained Kohler[®] engineers will be looking for out-of-true walls and varying slopes (including unlevel trays and floors). They will check that the choice and position of any doors or panels is suitable in relation to the whole bathroom layout and that the handing of the door and panel is correct for application. The home measure and installation service can only be undertaken after tiling is complete and the tray is installed and level.

Install

Following the home measure service, if you wish, our engineer will return to install the unit, further ensuring your complete satisfaction. However, please be aware Kohler[®] will only install if we have carried out the survey and measure.

Pricing

Each Made-to-Measure unit is unique and pricing will vary dependent on your requirements. Please use the prices that follow as guidelines and visit your nearest Kohler[®] showroom to discuss your bespoke showering design and gain a better understanding of the prices involved. If you choose the Kohler[®] measuring service the price of this service will be taken off the final unit price, giving you peace of mind at no additional cost.

Contact

Logistics and dimensions in your home could mean that not everything is possible given a specific situation. Your retailer can provide guidance on this, or feel free to call us on 0844 571 0048 for further assistance.

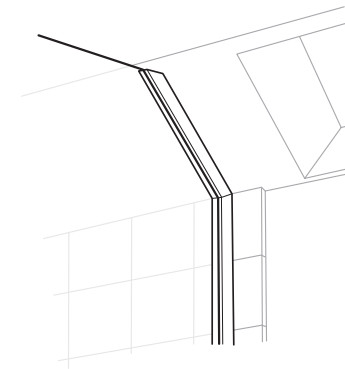

Angle & Notch Cuts

Whether it's an unusual loft space or complex bathroom layout, glass panels and doors can be bespoke to allow for that ideal fit. Angled cuts offer lines that follow the contours of the room and notches ensure no obstructive architecture prevents the perfect showering experience.

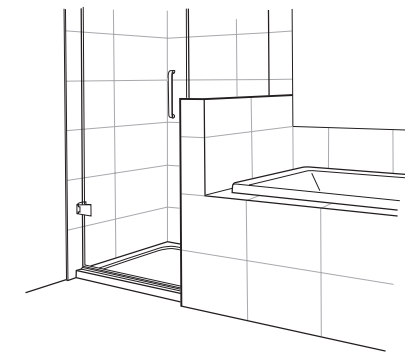

Dwarf Wall

Whether there is a low level wall or bath end, Minima[®] NG Made-to-Measure offers a solution to suit your space. Adapting shower enclosure panels around the constraints of the modern home, this feature allows for an integral showering space or a tiled seat.

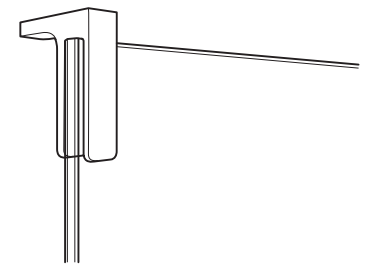

Ceiling Clamp

When the shower enclosure of choice makes a room with floor to ceiling panels, you can feel sure that the unit is fully secured and aesthetically pleasing with this purposeful yet clean-looking solution.

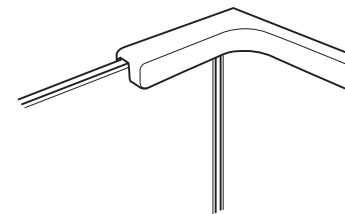

Bracing Bracket

Required for any installation over 2m tall, this bracket adds robustness to extra tall enclosures.

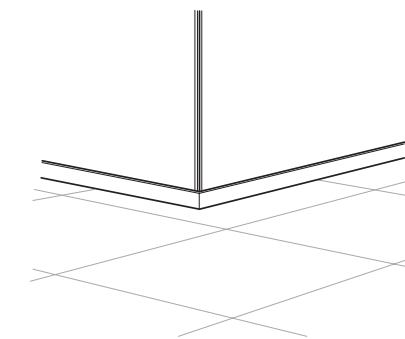

Surface Floor Profile

The most common means of securing your shower enclosure to the floor, these floor profiles join surfaces to glass with a slim, yet sleek aluminum profile.

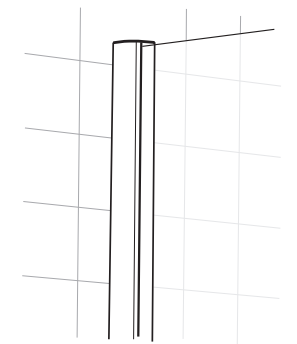

Surface Wall Profile

The most conventional method of securing your shower enclosure to the wall, these wall profiles connect surfaces to glass.

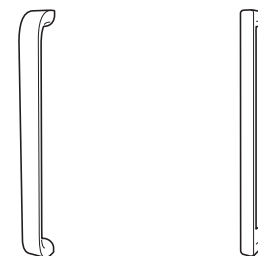

Handles

Soft or Geometric in profile, the choice is yours.

Minima® NG Made-to-Measure Hinged Door 301

Width (mm)	RRP Inc VAT
Up to 1000	£1,575.00
1000 to 1300	£1,800.00
per 100 above 1301 per panel	£50.00

Additional Made-to-Measure Glass Prices	RRP Inc VAT
Notch cut	£75.00
Angle cut	£75.00
Extra height per 100mm piece of glass	£50.00
Dwarf wall	£150.00

Measurement & Installation	RRP Inc VAT
Measure	£150.00
Installation	£250.00

Handle options



Geometric

Soft

Seat option

Choreograph® Seat
(See page 90)

Features

- Height requirements by special request
- For doors with inline panels and prices assume standard door size specified (please ask for pricing on non-standard doors)

Options

- Surface wall profile
- Ceiling fixings
- Dwarf wall options
- Standard handle options

How to order:

Step 1

Choose whether you would like a measurement service or measurement & installation service

Step 2

Select a handle style

Step 3

Select a coordinating tray if required



Power shower approved



2 man lift



Made-to-measure



Coated glass



Inward/outward opening



Lifetime guarantee
(See page 107)

Minima® NG Made-to-Measure Hinged Enclosure 302

Width (mm)	RRP Inc VAT
Up to 1000 x 1000	£2,385.00
Up to 1300 x 1000	£2,535.00
Up to 1000 x 1400	£2,445.00
Up to 1300 x 1400	£2,595.00

Additional Made-to-Measure Glass Prices	RRP Inc VAT
Notch cut	£75.00
Angle cut	£75.00
Extra height per 100mm piece of glass	£50.00
Dwarf wall	£150.00

Measurement & Installation	RRP Inc VAT
Measure	£150.00
Installation	£375.00

Handle options



Geometric

Soft

Seat option

Choreograph® Seat
(See page 90)

Features

- For doors with inline panels and prices assume standard door size specified (please ask for pricing on non-standard doors)

Options

- Surface wall profile
- Ceiling fixings
- Dwarf wall options
- Standard handle options

How to order:

Step 1

Choose whether you would like a measurement service or measurement & installation service

Step 2

Select a handle style

Step 3

Select a coordinating tray if required



Power shower approved



2 man lift



Made-to-measure



Coated glass



Inward/outward opening



Lifetime guarantee
(See page 107)

Minima® NG Made-to-Measure Pentagon 305

Width (mm)	RRP Inc VAT
Up to 1000 x up to 1000	£2,250.00
1000-1400 x up to 1000	£2,400.00
1400+ x 1000+	£2,475.00

Additional Made-to-Measure Glass Prices	RRP Inc VAT
Notch cut	£75.00
Angle cut	£75.00
Extra height per 100mm piece of glass	£50.00
Dwarf wall	£150.00

Measurement & Installation	RRP Inc VAT
Measure	£150.00
Installation	£375.00

Handle options



Geometric

Soft

Seat option

Choreograph® Seat
(See page 90)

Features

- For doors with inline panels and prices assume standard door size specified (please ask for pricing on non-standard doors)

Options

- Surface wall profile
- Ceiling fixings
- Dwarf wall options
- Standard handle options

How to order:

Step 1

Choose whether you would like a measurement service or measurement & installation service

Step 2

Select a handle style

Step 3

Select a coordinating tray if required



Power shower approved



2 man lift



Made-to-measure



Coated glass



Lifetime guarantee
(See page 107)

Minima® NG Made-to-Measure Divider Panel 327

Width (mm)	RRP Inc VAT
250-400	£549.00
401-800	£779.00
801-900	£805.00
901-1000	£835.00
1001-1200	£899.00
1201-1400	£1,050.00
1401 + per 100mm	£50.00

Additional Made-to-Measure Glass Prices	RRP Inc VAT
Notch cut	£75.00
Angle cut	£75.00
Extra height per 100mm piece of glass	£50.00
Dwarf wall	£150.00

Measurement & Installation	RRP Inc VAT
Measure	£150.00
Installation	£125.00

When choosing a glass divider panel, please be aware that spray/mist may extend beyond the length of the glass panel, the amount will depend upon the power of the shower and its location. We would recommend use of these products with tiled floors.

Handle options



Geometric

Soft

Seat option

Choreograph® Seat
(See page 90)

Features

- Height requirements by special request
- For doors with inline panels and prices assume standard door size specified (please ask for pricing on non-standard doors)

Options

- Surface wall profile
- Ceiling fixings
- Dwarf wall options

How to order:

Step 1

Choose whether you would like a measurement service or measurement & installation service

Step 2

Select a coordinating tray if required



Power shower approved



2 man lift



Made-to-measure



Coated glass



Lifetime guarantee
(See page 107)

Minima® NG Made-to-Measure Hinged Door 331

Width (mm)	RRP Inc VAT
Up to 1200	£1,950.00
Up to 1400	£2,025.00
Up to 1700	£2,780.00

Additional Made-to-Measure Glass Prices	RRP Inc VAT
Notch cut	£75.00
Angle cut	£75.00
Extra height per 100mm piece of glass	£50.00
Dwarf wall	£150.00

Measurement & Installation	RRP Inc VAT
Measure	£150.00
Installation	£375.00

Handle options



Geometric

Soft

Seat option

Choreograph® Seat
(See page 90)

Features

- Height requirements by special request
- For doors with inline panels and prices assume standard door size specified (please ask for pricing on non-standard doors)

Options

- Surface wall profile
- Ceiling fixings
- Dwarf wall options
- Standard handle options

How to order:

Step 1

Choose whether you would like a measurement service or measurement & installation service

Step 2

Select a handle style

Step 3

Select a coordinating tray if required



Power shower approved



2 man lift



Made-to-measure



Coated glass



Inward/outward opening



Lifetime guarantee
(See page 107)

Minima® NG Made-to-Measure Sliding Door 391

Additional Made-to-Measure Glass Prices	RRP Inc VAT
Notch cut	N/A
Angle cut	N/A
Extra height per 100mm piece of glass	£50.00
Dwarf wall	N/A

Measurement & Installation	RRP Inc VAT
Measure	£150.00
Installation	£250.00

Handle options



Geometric

Soft

Seat option

Choreograph® Seat
(See page 90)

Features

- Extra height only available on sliding doors

Options

- Surface wall profile
- Ceiling fixings
- Standard handle options

How to order:

Step 1

Choose whether you would like a measurement service or measurement & installation service

Step 2

Select a handle style

Step 3

Select a coordinating tray if required



Power shower approved



2 man lift



Made-to-measure



Coated glass



Lifetime guarantee
(See page 107)

Torsion®

Inspired by the way modern architecture flows cleanly through space, Torsion® shower doors fuse functionality with structural integrity and flawless design. Torsion® received the 2013 IF product design award as well as the 2012 red dot design award.

Product Pages

711 In-swing Door	37
712 In-swing Enclosure	39
715 In-swing Pentagon	41
761 Hinged Door	43
762 Hinged Enclosure	45
765 Hinged Pentagon	47
771 Sliding Door	49
772 Sliding Enclosure	51
788 Quadrant	53

Features

- 8mm thick safety glass
- Clear glazing
- Hidden mechanisms for the ease of cleaning
- Adjustable ball catch for long-life reliable operation
- iF & Red Dot design award winner

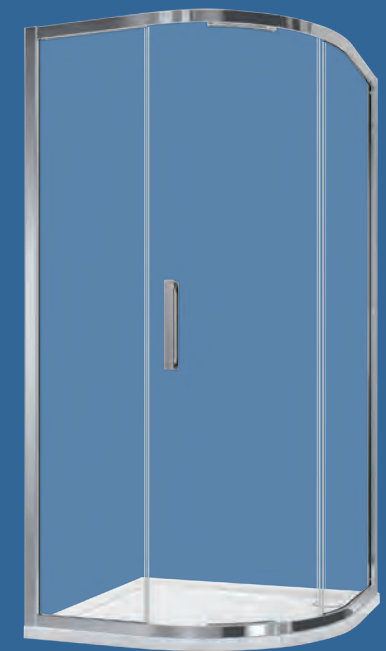

712 Torsion® in-swing enclosure with twist handle
900 x 760mm shower tray

Enclosures

Torsion® In-Swing Door 711

Geometric Handle

Tray size (mm)	Door adjustment min-max width	Door opening aperture	Left hand door code	Right hand door code	RRP Price
760	720-760mm	540mm	1.1853.159	1.1853.160	£828.00
800	760-800mm	580mm	1.1853.161	1.1853.162	£828.00
900	860-900mm	680mm	1.1853.163	1.1853.164	£875.00
1000	960-1000mm	580mm	1.1853.165	1.1853.166	£964.00
1200	1160-1200mm	680mm	1.1853.167	1.1853.168	£1,093.00

Twist Handle

Tray size (mm)	Door adjustment min-max width	Door opening aperture	Left hand door code	Right hand door code	RRP Price
760	720-760mm	540mm	1.1853.124	1.1853.125	£828.00
800	760-800mm	580mm	1.1853.126	1.1853.127	£828.00
900	860-900mm	680mm	1.1853.128	1.1853.129	£875.00
1000	960-1000mm	580mm	1.1853.130	1.1853.131	£964.00
1200	1160-1200mm	680mm	1.1853.132	1.1853.133	£1,093.00

Technical drawing

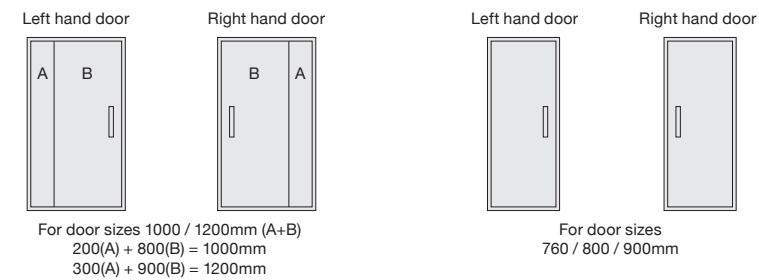

Optional filler section

- Suitable to use with Torsion® doors, side panels and enclosures
- Extends the width of a Torsion® door, side panel or enclosure by 10mm

To suit	Code	RRP Price
Door	1.1853.140	£42.00

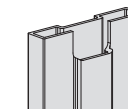

Door filler

For in-swing dimensions please speak to your local retailer.

Handle options



Geometric

Twist

Seat option



Choreograph® Seat
(See page 90)

Features

- Door position when open denotes handing, please state left or right when ordering
- 8mm thick safety glass
- Clear glazing
- Hidden mechanisms for ease of cleaning
- Adjustable ball catch for life-long reliable operation
- 20mm adjustment on each wall profile for out-of-true walls
- Height from top of tray 1950mm
- Minimum tray rim width 60mm
- Please allow 100mm clearance above the door for any adjustments
- Not compatible with Low Level Plus trays

How to order your Torsion® In-Swing Door:

Step 1

Select your door size

Step 2

Choose a handle style

Step 3

Select a coordinating tray if required



Power shower approved



Innovation



2 man lift



Lifetime guarantee
(See page 107)



Coated glass



Red Dot award



Shower tray available



iF award



Enclosures

Torsion® In-Swing Enclosure 712

Geometric Handle

Tray size (mm)	Door adjustment min-max width	Door opening aperture	Left hand door code	Right hand door code	RRP Price
760	720-740mm	540mm	1.1853.159	1.1853.160	£828.00
800	760-780mm	580mm	1.1853.161	1.1853.162	£828.00
900	860-880mm	680mm	1.1853.163	1.1853.164	£875.00
1000	960-980mm	580mm	1.1853.165	1.1853.166	£964.00
1200	1160-1180mm	680mm	1.1853.167	1.1853.168	£1,093.00

Twist Handle

Tray size (mm)	Door adjustment min-max width	Door opening aperture	Left hand door code	Right hand door code	RRP Price
760	720-740mm	540mm	1.1853.124	1.1853.125	£828.00
800	760-780mm	580mm	1.1853.126	1.1853.127	£828.00
900	860-880mm	680mm	1.1853.128	1.1853.129	£875.00
1000	960-980mm	580mm	1.1853.130	1.1853.131	£964.00
1200	1160-1180mm	680mm	1.1853.132	1.1853.133	£1,093.00

Reversible Panel

Nominal width (A+B+C)	Frame adjustment min-max width	Code	RRP Price
760mm	720-740mm	1.1853.101	£469.00
800mm	760-780mm	1.1853.102	£469.00
900mm	860-880mm	1.1853.103	£495.00
1000mm	960-980mm	1.1853.104	£532.00

Technical drawing

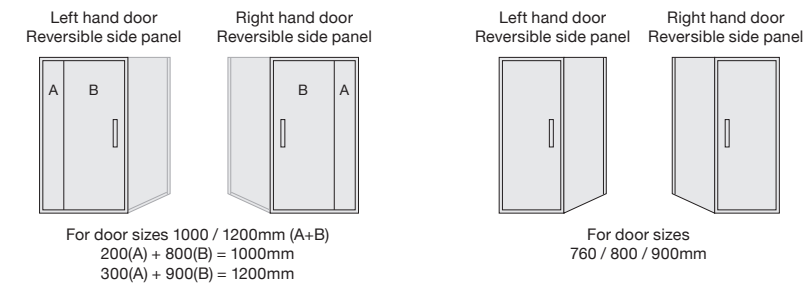

Optional filler section

- Suitable to use with Torsion® doors, side panels and enclosures
- Extends the width of a Torsion® door, side panel or enclosure by 10mm

To suit	Code	RRP Price
Door	1.1853.140	£42.00
Side panel	1.1853.141	£42.00

For in-swing dimensions please speak to your local retailer.

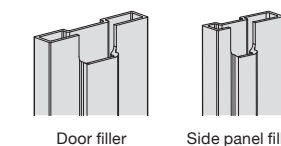

Door filler Side panel filler

Handle options



Geometric Twist

Seat option



Choreograph® Seat (See page 90)

Features

- Door position when open denotes handing, please state left or right when ordering
- 8mm thick safety glass
- Clear glazing
- Hidden mechanisms for ease of cleaning
- Adjustable ball catch for life-long reliable operation
- 20mm adjustment on each wall profile for out-of-true walls, 40mm overall adjustment
- Height from top of tray 1950mm
- Minimum tray rim width 60mm
- Please allow 100mm clearance above the enclosure for any adjustments
- Not compatible with Low Level Plus trays

How to order your Torsion® In-Swing Enclosure:

Step 1

Select your door and panel size

Step 2

Choose a handle style

Step 3

Select a coordinating tray if required



715 Torsion[®] in-swing pentagon enclosure shown with twist handle
1200 x 900mm shower tray

N.B. Showerhead no longer for sale in the UK

Enclosures

Torsion[®] In-Swing Pentagon 715

Geometric Handle

Tray size (mm)	Door adjustment min-max width	Door opening aperture	Left hand door code	Right hand door code	RRP Price
900x900	720-760mm	540mm	C1.1853.122IG	C1.1853.160IGRH	£1,371.00
1200x900	720-760mm	540mm	C1.1853.123IG	C1.1853.123IGRH	£1,590.00

Twist Handle

Tray size (mm)	Door adjustment min-max width	Door opening aperture	Left hand door code	Right hand door code	RRP Price
900x900	720-760mm	540mm	C1.1853.124IT	C1.1853.125ITRH	£1,371.00
1200x900	720-760mm	540mm	C1.1853.123IT	C1.1853.123ITRH	£1,590.00

Technical drawing

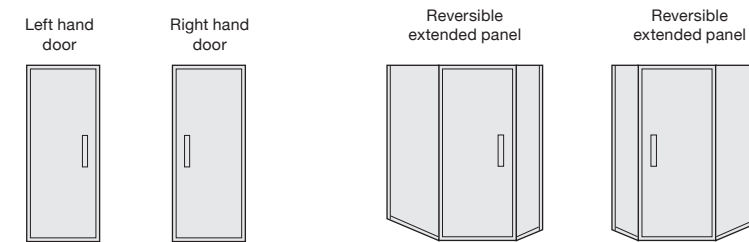

Optional filler section

- Suitable to use with Torsion[®] doors, side panels and enclosures
- Extends the width of a Torsion[®] door, side panel or enclosure by 10mm

To suit	Code	RRP Price
Door	1.1853.140	£42.00
Side panel	1.1853.141	£42.00

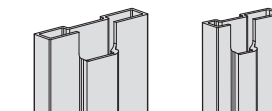

For in-swing dimensions please speak to your local retailer.

Door filler

Side panel filler

Handle options

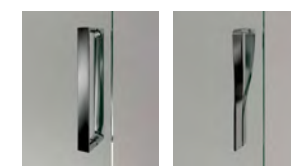

Geometric

Twist

Seat option



Choreograph[®] Seat
(See page 90)

Features

- Door position when open denotes handing, please state left or right when ordering
- 8mm thick safety glass
- Clear glazing
- Hidden mechanisms for ease of cleaning
- Adjustable ball catch for life-long reliable operation
- 20mm adjustment on each wall profile for out-of-true walls, 40mm overall adjustment
- Height from top of tray 1950mm
- Minimum tray rim width 60mm
- Please allow 100mm clearance above the enclosure for any adjustments

How to order your Torsion[®] In-Swing Pentagon:

Step 1

Select your pentagon size

Step 2

Choose a handle style

Step 3

Select a coordinating tray if required



Power shower approved



Innovation



2 man lift



Lifetime guarantee
(See page 107)



Coated glass



Red Dot award



Shower tray available



iF award



Enclosures

Torsion® Hinged Door 761

Geometric Handle

Door size	Door adjustment min - max width	Door opening aperture	Code	RRP Price
760mm	720-760mm	620mm	1.1853.142	£745.00
800mm	760-800mm	660mm	1.1853.143	£745.00
900mm	860-900mm	760mm	1.1853.144	£792.00
1000mm	960-1000mm	760mm	1.1853.145	£880.00
1200mm	1160-1200mm	760mm	1.1853.146	£1011.00

Twist Handle

Door size	Door adjustment min - max width	Door opening aperture	Code	RRP Price
760mm	720-760mm	620mm	1.1853.105	£745.00
800mm	760-800mm	660mm	1.1853.106	£745.00
900mm	860-900mm	760mm	1.1853.107	£792.00
1000mm	960-1000mm	760mm	1.1853.108	£880.00
1200mm	1160-1200mm	760mm	1.1853.109	£1011.00

Technical drawing

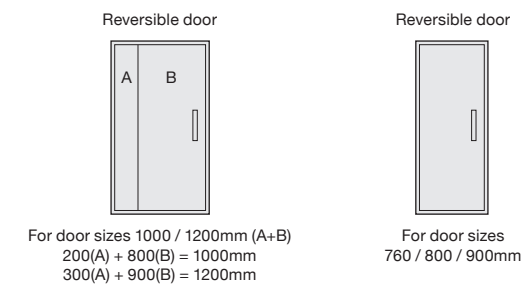

Optional filler section

- Suitable to use with Torsion® doors, side panels and enclosures
- Extends the width of a Torsion® door, side panel or enclosure by 10mm

To suit	Code	RRP Price
Door	1.1853.140	£42.00

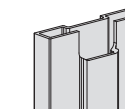

For in-swing dimensions please speak to your local retailer.

Door filler

Handle options

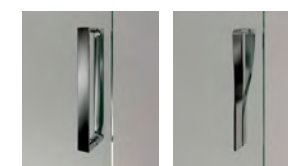

Geometric

Twist

Seat option



Choreograph® Seat (See page 90)

Features

- Unhanded – orientation to be decided on installation by engineer
- 8mm thick safety glass
- Clear glazing
- Flush-fitting bonded hinges for ease of cleaning
- Adjustable ball catch for life-long reliable operation
- 20mm adjustment on each wall profile for out-of-true walls
- Height from top of tray 1950mm
- Minimum tray rim width 60mm
- Not compatible with Low Level Plus trays

How to order your Torsion® Hinged Door:

Step 1

Select your door size

Step 2

Choose a handle style

Step 3

Select a coordinating tray if required



Power shower approved



Innovation



2 man lift



Lifetime guarantee (See page 107)



Coated glass



Red Dot award



Shower tray available



iF award

761 Torsion® hinged door shown with twist handle 900 x 900mm shower tray

N.B. Showerhead no longer for sale in the UK

Enclosures

Torsion® Hinged Enclosure 762

Geometric Handle

Door size	Door adjustment min-max width	Door opening aperture	Code	RRP Price
760mm	720-740mm	620mm	1.1853.142	£745.00
800mm	760-780mm	660mm	1.1853.143	£745.00
900mm	860-880mm	760mm	1.1853.144	£792.00
1000mm	960-980mm	760mm	1.1853.145	£880.00
1200mm	1160-1180mm	760mm	1.1853.146	£1011.00

Twist Handle

Door size	Door adjustment min-max width	Door opening aperture	Code	RRP Price
760mm	720-740mm	620mm	1.1853.105	£745.00
800mm	760-780mm	660mm	1.1853.106	£745.00
900mm	860-880mm	760mm	1.1853.107	£792.00
1000mm	960-980mm	760mm	1.1853.108	£880.00
1200mm	1160-1180mm	760mm	1.1853.109	£1011.00

Reversible Panel size	Panel adjustment min - max width	Code	RRP Price
760mm	720-740mm	1.1853.101	£469.00
800mm	760-780mm	1.1853.102	£469.00
900mm	860-880mm	1.1853.103	£495.00
1000mm	960-980mm	1.1853.104	£532.00

Technical drawing

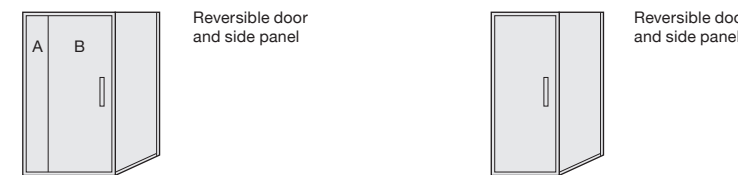

Optional filler section

- Suitable to use with Torsion® doors, side panels and enclosures
- Extends the width of a Torsion® door, side panel or enclosure by 10mm

To suit	Code	RRP Price
Door	1.1853.140	£42.00
Side panel	1.1853.141	£42.00

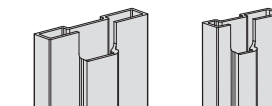

For in-swing dimensions please speak to your local retailer.

Door filler

Side panel filler

Handle options

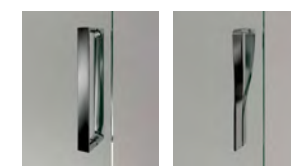

Geometric

Twist

Seat option



Choreograph® Seat (See page 90)

Features

- Unhanded – orientation to be decided on installation by engineer
- Side panels are reversible
- 8mm thick safety glass
- Clear glazing
- Flush-fitting bonded hinges for ease of cleaning
- Adjustable ball catch for life-long reliable operation
- 20mm adjustment on each wall profile for out-of-true walls
- Height from top of tray 1950mm
- Minimum tray rim width 60mm
- Not compatible with Low Level Plus trays

How to order your Torsion® Hinged Enclosure:

Step 1

Select your door and panel size

Step 2

Choose a handle style

Step 3

Select a coordinating tray if required



Power shower approved



Innovation



2 man lift



Lifetime guarantee (See page 107)



Coated glass



Red Dot award



Shower tray available



iF award



762 Torsion® hinged enclosure shown with twist handle
1200 x 800mm shower tray

N.B. Showerhead no longer for sale in the UK



Enclosures

Torsion® Hinged Pentagon 765

Geometric Handle

Tray size	Door adjustment min-max width	Door opening aperture	Code	RRP Price
900 x 900mm	720-740mm	620mm	C1.1853.122HG	£1,288.00
1200 x 900mm	720-740mm	620mm	C1.1853.123HG	£1,507.00

Twist Handle

Tray size	Door adjustment min-max width	Door opening aperture	Code	RRP Price
900 x 900mm	720-740mm	620mm	C1.1853.122HT	£1,288.00
1200 x 900mm	720-740mm	620mm	C1.1853.123HT	£1,507.00

Technical drawing

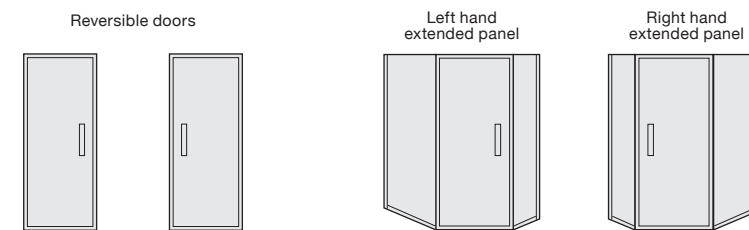

Optional filler section

- Suitable to use with Torsion® doors, side panels and enclosures
- Extends the width of a Torsion® door, side panel or enclosure by 10mm

To suit	Code	RRP Price
Door	1.1853.140	£42.00
Side panel	1.1853.141	£42.00

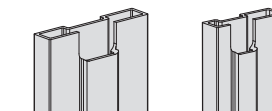

For in-swing dimensions please speak to your local retailer.

Door filler Side panel filler

Handle options



Geometric Twist

Seat option



Choreograph® Seat
(See page 90)

Features

- Extended pentagons are handed to suit tray, state left or right when ordering
- Unhanded – orientation to be decided on installation by engineer
- 8mm thick safety glass
- Clear glazing
- Flush-fitting bonded hinges for ease of cleaning
- Adjustable ball catch for life-long reliable operation
- 20mm adjustment on each wall profile for out-of-tray walls
- Height from top of tray 1950mm
- Minimum tray rim width 60mm

How to order your Torsion® Hinged Pentagon:

Step 1

Select your pentagon size

Step 2

Choose a handle style

Step 3

Select a coordinating tray if required

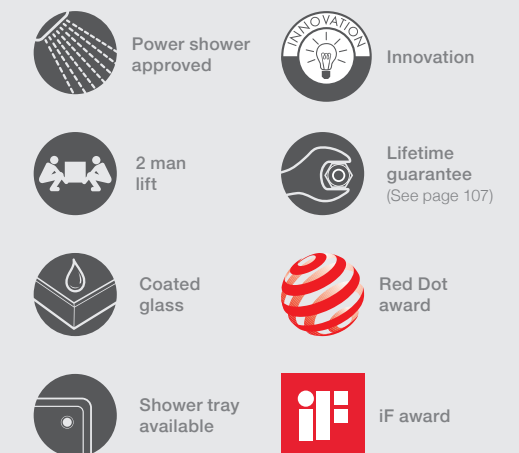

765 Torsion® hinged pentagon shown with twist handle
900 x 900mm shower tray

N.B. Showerhead no longer for sale in the UK



Enclosures

Torsion® Sliding Door 771

Geometric Handle

Door size	Door adjustment min - max width	Door opening aperture	Left hand door code	Right hand door code	RRP Price
1100mm	1060-1100mm	410mm	1.1853.147	1.1853.148	£844.00
1200mm	1160-1200mm	460mm	1.1853.149	1.1853.150	£875.00
1400mm	1360-1400mm	560mm	C1.1853.114G	C1.1853.115G	£1,042.00
1500mm	1460-1500mm	560mm	C1.1853.116G	C1.1853.117G	£1,073.00
1600mm	1560-1600mm	660mm	C1.1853.118G	C1.1853.119G	£1,104.00
1700mm	1660-1700mm	660mm	C1.1853.120G	C1.1853.121G	£1,129.00

Twist Handle

Door size	Door adjustment min - max width	Door opening aperture	Left hand door code	Right hand door code	RRP Price
1100mm	1060-1100mm	410mm	1.1853.110	1.1853.111	£844.00
1200mm	1160-1200mm	460mm	1.1853.112	1.1853.113	£875.00
1400mm	1360-1400mm	560mm	C1.1853.114T	C1.1853.115T	£1,042.00
1500mm	1460-1500mm	560mm	C1.1853.116T	C1.1853.117T	£1,073.00
1600mm	1560-1600mm	660mm	C1.1853.118T	C1.1853.119T	£1,104.00
1700mm	1660-1700mm	660mm	C1.1853.120T	C1.1853.121T	£1,129.00

Technical drawing

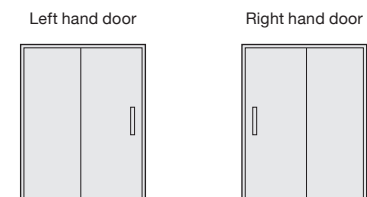

Optional filler section

- Suitable to use with Torsion® doors, side panels and enclosures
- Extends the width of a Torsion® door, side panel or enclosure by 10mm

To suit	Code	RRP Price
Door	1.1853.140	£42.00

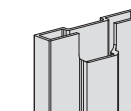

For in-swing dimensions please speak to your local retailer.

Door filler

Handle options

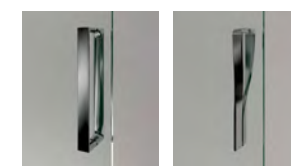

Geometric

Twist

Seat option



Choreograph® Seat
(See page 90)

Features

- Fixed panel denotes handing, please state left or right when ordering
- 8mm thick safety glass
- Clear glazing
- Hidden mechanisms for ease of cleaning
- 20mm adjustment on each wall profile for out-of-true walls
- Height from top of tray 1950mm
- Minimum tray rim width 66mm
- Please allow 150mm clearance above the door for any adjustments
- All doors above 1200mm require assembly, allowing easy transportation
- Not compatible with Low Level Plus trays

How to order your Torsion® Sliding Door:

Step 1

Select your door size

Step 2

Choose a handle style

Step 3

Select a coordinating tray if required



Power shower approved



Innovation



2 man lift



Lifetime guarantee
(See page 107)



Coated glass



Red Dot award



Shower tray available



iF award

771 Torsion® sliding door shown with twist handle
1400 x 800mm shower tray

N.B. Showerhead no longer for sale in the UK



Enclosures

Torsion® Sliding Enclosure 772

Geometric Handle

Door size	Door adj. min-max width	Door opening aperture	Left hand door code	Right hand door code	RRP Price
1100mm	1060-1080mm	410mm	1.1853.147	1.1853.148	£844.00
1200mm	1160-1180mm	460mm	1.1853.149	1.1853.150	£875.00
1400mm	1360-1380mm	560mm	C1.1853.114G	C1.1853.115G	£1,042.00
1500mm	1460-1480mm	560mm	C1.1853.116G	C1.1853.117G	£1,073.00
1600mm	1560-1580mm	660mm	C1.1853.118G	C1.1853.119G	£1,104.00
1700mm	1660-1680mm	660mm	C1.1853.120G	C1.1853.121G	£1,129.00

Twist Handle

Door size	Door adj. min-max width	Door opening aperture	Left hand door code	Right hand door code	RRP Price
1100mm	1060-1080mm	410mm	1.1853.110	1.1853.111	£844.00
1200mm	1160-1180mm	460mm	1.1853.112	1.1853.113	£875.00
1400mm	1360-1380mm	560mm	C1.1853.114T	C1.1853.115T	£1,042.00
1500mm	1460-1480mm	560mm	C1.1853.116T	C1.1853.117T	£1,073.00
1600mm	1560-1580mm	660mm	C1.1853.118T	C1.1853.119T	£1,104.00
1700mm	1660-1680mm	660mm	C1.1853.120T	C1.1853.121T	£1,129.00

Reversible Panel size	Panel adjustment min-max width	Code	RRP Price
760mm	720-740mm	1.1853.101	£469.00
800mm	760-780mm	1.1853.102	£469.00
900mm	860-880mm	1.1853.103	£495.00
1000mm	960-980mm	1.1853.104	£532.00

Technical drawing

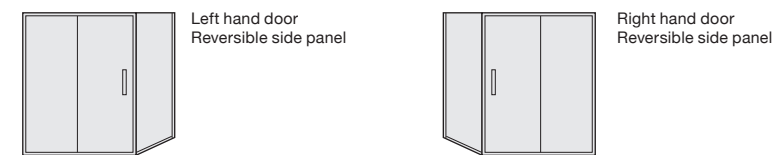

Optional filler section

- Suitable to use with Torsion® doors, side panels and enclosures
- Extends the width of a Torsion® door, side panel or enclosure by 10mm

To suit	Code	RRP Price
Door	1.1853.140	£42.00
Side panel	1.1853.141	£42.00

For in-swing dimensions please speak to your local retailer.

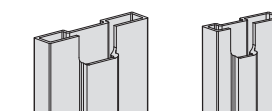

Door filler Side panel filler

Handle options

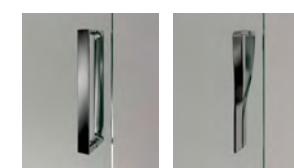

Geometric Twist

Seat option



Choreograph® Seat
(See page 90)

Features

- Side panels are reversible
- 8mm thick safety glass
- Clear glazing
- 20mm adjustment on each wall profile for out-of-true walls
- Hidden mechanisms for ease of cleaning
- Height from top of tray 1950mm
- Minimum tray rim width 66mm
- Please allow 150mm clearance above the enclosure for any adjustments
- All doors above 1200mm require assembly, allowing easy transportation
- Not compatible with Low Level Plus trays

How to order your Torsion® Sliding Enclosure:

Step 1

Select your door and panel size

Step 2

Choose a handle style

Step 3

Select a coordinating tray if required

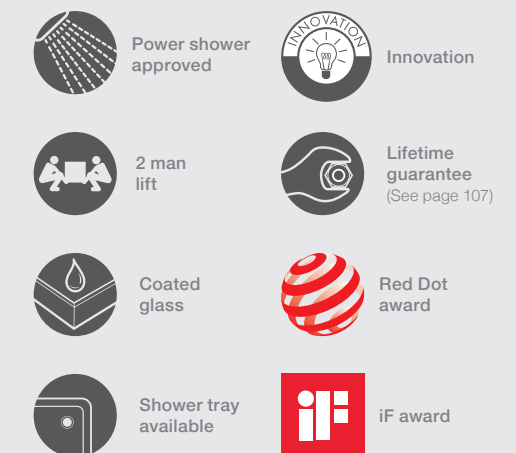

772 Torsion® sliding enclosure shown with twist handle
1400 x 800mm shower tray

N.B. Showerhead no longer for sale in the UK

Enclosures

Torsion® Quadrant 788

Geometric Handle

Door adjustment min - max width	Door opening aperture	Enclosure Adjustment (mm)	Code	RRP Price
900 x 900mm	465mm	883-900	C1.1853.137G	£976.00
1000 x 1000mm	465mm	983-1000	C1.1853.134G	£1,086.00
1000 x 800mm	465mm	983-1000, 783-800	C1.1853.138G	£976.00
1200 x 900mm	465mm	1183-1200, 893-900	C1.1853.139G	£1,133.00

Twist Handle

Door adjustment min - max width	Door opening aperture	Enclosure Adjustment (mm)	Code	RRP Price
900 x 900mm	465mm	883-900	C1.1853.137T	£976.00
1000 x 1000mm	465mm	983-1000	C1.1853.134T	£1,086.00
1000 x 800mm	465mm	983-1000, 783-800	C1.1853.138T	£976.00
1200 x 900mm	465mm	1183-1200,883-900	C1.1853.139T	£1,133.00

Technical drawing

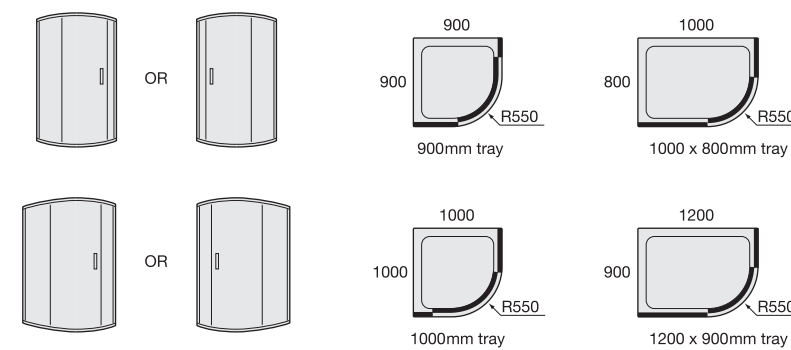

Optional filler section

- Suitable to use with Torsion®, doors, side panels and enclosures
- Extends the width of a Torsion®, door, side panel or enclosure by 10mm

To suit	Code	RRP Price
Door	1.1853.140	£42.00
Side panel	1.1853.141	£42.00

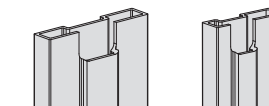

For in-swing dimensions please speak to your local retailer.

Door filler

Side panel filler

Handle options



Geometric

Twist

Seat option



Choreograph® Seat (See page 90)

Features

- Reversible Quadrant
- 8mm thick safety glass
- Clear glazing
- Quick-release mechanism for easy cleaning
- 17mm adjustment on each wall profile for out-of-true walls
- Height from top of tray 1950mm
- Minimum tray width 60mm
- Please note this product requires a two person delivery and installation

How to order your Torsion® Quadrant:

Step 1

Select your quadrant size

Step 2

Choose a handle style

Step 3

Select a coordinating tray if required

- Power shower approved
- Innovation
- 2 man lift
- Lifetime guarantee (See page 107)
- Coated glass
- Red Dot award
- Shower tray available
- iF award



788 Torsion® quadrant shown with geometric handle 900 x 900mm shower tray

N.B. Showerhead no longer for sale in the UK

Skyline®

The Skyline® collection combines subtlety and simplicity through design engineering excellence. Unique features ensure ease of installation and a robust and low maintenance enclosure.

Product Page

241 Pivot Door	57
242 Pivot Enclosure	59
245 Pivot Pentagon	61
Bi-fold Door	63
Bi-fold Enclosure	65
Bi-fold Pentagon	67
271 Sliding Door	69
272 Sliding Enclosure	71
274 Double Sliding Door	73
278 Double Sliding Enclosure	75
298 Quadrant	77
210 Walk-In	79
688 Hinged Walk-In	81

Features

- 6mm thick safety glass
- Clear glazing
- Reversible for left or right hand opening
- Adjustable ball catch for long-life reliable operation
- Geometric handle mounted vertically





241 Skyline[®] pivot door shown with geometric handle
1000 x 800mm shower tray

Enclosures

Skyline[®] Pivot Door 241

Door size	Door adjustment min - max width	Door opening aperture	Code	RRP Price
760mm	710-770mm	492mm	1.1857.103	£408.00
800mm	750-810mm	532mm	1.1857.104	£408.00
900mm	850-910mm	632mm	1.1857.105	£448.00
1000mm	950-1010mm	532mm	1.1857.106	£510.00
1200mm	1150-1210mm	532mm	1.1857.107	£612.00

Technical drawing

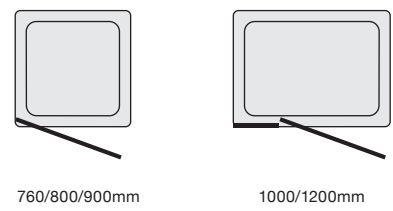

Optional filler section:

- Suitable to use with Skyline[®] doors, side panels and enclosures
- Extends the width of a Skyline[®] door, side panel or enclosure by 18mm

To suit	Code	RRP Price
Doors and side panels	1.1857.101	£41.00

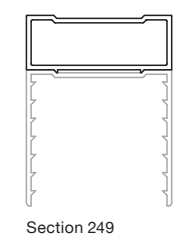

Seat option



Choreograph[®] Seat
(See page 90)

Features

- Unhanded – orientation to be decided on installation by engineer
- 1000 & 1200mm doors incorporate in-line panel
- 6mm thick safety glass door and panels
- Clear glazing
- Geometric handle mounted vertically
- Adjustable ball catch for life-long reliable operation
- 3mm adjustment on pivot blocks
- Unique 30mm adjustment system on each wall channel
- Height from top of tray 1900mm
- Minimum tray rim width 40mm

How to order your Skyline[®] Pivot Door:

- Step 1**
Select your door size
- Step 2**
Select a coordinating tray if required

- Power shower approved
- Coated glass
- 2 man lift
- Lifetime guarantee (See page 107)
- Shower tray available



242 Skyline[®] pivot enclosure shown with geometric handle
1000 x 800mm shower tray

Enclosures

Skyline[®] Pivot Enclosure 242

Door size	Door adjustment min - max width	Door opening aperture	Code	RRP Price
760mm	710-770mm	492mm	1.1857.103	£408.00
800mm	750-810mm	532mm	1.1857.104	£408.00
900mm	850-910mm	632mm	1.1857.105	£448.00
1000mm	950-1010mm	532mm	1.1857.106	£510.00
1200mm	1150-1210mm	532mm	1.1857.107	£612.00

Reversible Panel

Panel size	Panel adjustment min - max width	Code	RRP Price
760mm	725-755mm	1.1857.135	£224.00
800mm	765-795mm	1.1857.136	£244.00
900mm	865-895mm	1.1857.137	£275.00

Technical drawing

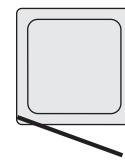

760/800/900mm

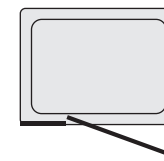

1000/1200mm

Optional filler section:

- Suitable to use with Skyline[®] doors, side panels and enclosures
- Extends the width of a Skyline[®] door, side panel or enclosure by 18mm

To suit	Code	RRP Price
Doors and side panels	1.1857.101	£41.00

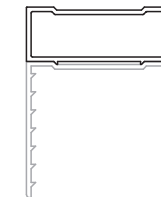

Section 249

Seat option



Choreograph[®] Seat
(See page 90)

Features

- Unhanded – orientation to be decided on installation by engineer
- 1000mm & 1200mm doors incorporate in-line panel
- 6mm thick safety glass door and panels
- Clear glazing
- Geometric handle mounted vertically
- Adjustable ball catch for life-long reliable operation
- 3mm adjustment on pivot blocks
- Unique 30mm adjustment system on each wall channel
- Height from top of tray 1900mm
- Minimum tray rim width 40mm

How to order your Skyline[®] Pivot Enclosure:

Step 1

Select your door size

Step 2

Choose your panel size

Step 3

Select a coordinating tray if required



Power shower approved



Coated glass



2 man lift



Lifetime guarantee
(See page 107)



Shower tray available

Skyline® Pivot Pentagon 245

Panel size (mm)	Panel adjustment min-max width	Code	RRP Price
900 x 900	855 x 885mm	C1.1857.109	£919.00
1200 x 900	1155 x 1185mm	C1.1857.110	£1,123.00

Technical drawing

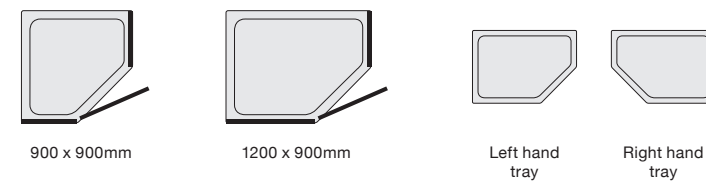

Features

- Unhanded – orientation to be decided on installation by engineer
- 6mm thick safety glass door and panels
- Clear glazing
- Geometric handle mounted vertically
- Adjustable ball catch for life-long reliable operation
- 3mm adjustment on pivot blocks
- Unique 30mm adjustment system on each wall channel
- Height from top of tray 1900mm
- Minimum tray rim width 40mm

How to order your Skyline® Pivot Pentagon:

Step 1

Select your pentagon size

Step 2

Select a coordinating tray if required

Optional filler section:

- Suitable to use with Skyline® doors, side panels and enclosures
- Extends the width of a Skyline® door, side panel or enclosure by 18mm

To suit	Code	RRP Price
Doors and side panels	1.1857.101	£41.00

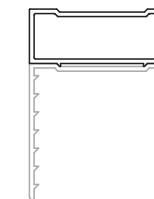

Section 249

Seat option



Choreograph® Seat
(See page 90)

- Power shower approved
- Coated glass
- 2 man lift
- Lifetime guarantee (See page 107)
- Shower tray available

Enclosures

Skyline® Bi-fold Door

Door size	Door adjustment min - max width	Door opening aperture	Code	RRP Price
760mm	710-770mm	448mm	1.1857.138	£472.00
800mm	750-810mm	480mm	1.1857.139	£490.00
900mm	850-910mm	591mm	1.1857.140	£521.00
1000mm	950-1010mm	679mm	1.1857.141	£552.00

Technical drawing

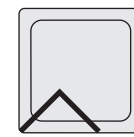

760/800/900/1000mm

Optional filler section:

- Suitable to use with Skyline® doors, side panels and enclosures
- Extends the width of a Skyline® door, side panel or enclosure by 18mm

To suit	Code	RRP Price
Doors and side panels	1.1857.101	£41.00

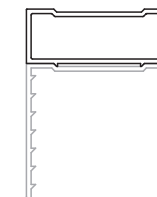

Section 249

Seat option

Choreograph® Seat
(See page 90)

Features

- Unhanded – orientation to be decided on installation by engineer
- 6mm thick safety glass door and panels
- Clear glazing
- Geometric handle mounted vertically
- Unique 30mm adjustment system on each wall channel
- Height from top of tray 1900mm
- Minimum tray rim width 40mm

How to order your Skyline® Bi-fold Door:

Step 1

Select your door size

Step 2

Select a coordinating tray if required



Power shower approved



Coated glass



2 man lift

Lifetime guarantee
(See page 107)

Shower tray available

Enclosures

Skyline® Bi-fold Enclosure

Door size	Door adjustment min - max width	Door opening aperture	Code	RRP Price
760mm	729-759mm	448mm	1.1857.138	£472.00
800mm	769-799mm	480mm	1.1857.139	£490.00
900mm	869-899mm	591mm	1.1857.140	£521.00
1000mm	969-999mm	679mm	1.1857.141	£552.00

Reversible Panel

Panel size	Panel adjustment min - max width	Code	RRP Price
760mm	725-755mm	1.1857.135	£224.00
800mm	765-795mm	1.1857.136	£244.00
900mm	865-895mm	1.1857.137	£275.00

Technical drawing

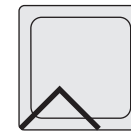

760/800/900/1000mm

Optional filler section:

- Suitable to use with Skyline® doors, side panels and enclosures
- Extends the width of a Skyline® door, side panel or enclosure by 18mm

To suit	Code	RRP Price
Doors and side panels	1.1857.101	£41.00

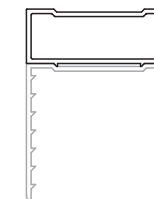

Section 249

Seat option

Choreograph® Seat
(See page 90)

Features

- Unhanded – orientation to be decided on installation by engineer
- 6mm safety glass
- Clear glazing
- Geometric handle mounted vertically
- Unique 30mm adjustment on each wall channel
- Height from top of tray 1900mm
- Minimum tray rim width 40mm

How to order your Skyline® Bi-fold Enclosure:

Step 1

Select your door size

Step 2

Choose your panel size

Step 3

Select a coordinating tray if required



Power shower approved



Coated glass



2 man lift

Lifetime guarantee
(See page 107)

Shower tray available

Skyline® Bi-fold Pentagon

Door size (mm)	Door adjustment min - max width	Door opening aperture	Code	RRP Price
900 x 900	710-770mm	448mm	C1.1857.109B	£983.00
1200 x 900	710-770mm	448mm	C1.1857.110B	£1,187.00

Technical drawing

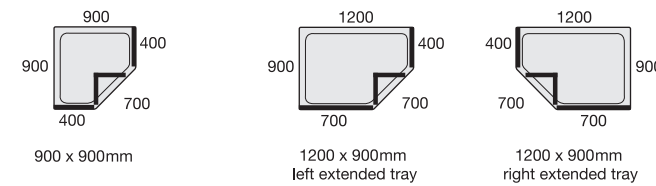

Optional filler section:

- Suitable to use with Skyline® doors, side panels and enclosures
- Extends the width of a Skyline® door, side panel or enclosure by 18mm

To suit	Code	RRP Price
Doors and side panels	1.1857.101	£41.00

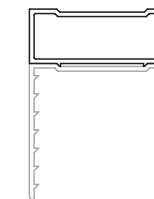

Section 249

Seat option



Choreograph® Seat
(See page 90)

Features

- Unhanded – orientation to be decided on installation by engineer
- 6mm thick safety glass door and panels
- Clear glazing
- Geometric handle mounted vertically
- Unique 30mm adjustment system on each wall channel
- Height from top of tray 1900mm
- Minimum tray rim width 40mm

How to order your Skyline® Bi-fold Pentagon:

Step 1

Select your pentagon size

Step 2

Select a coordinating tray if required



Power shower approved



Coated glass



2 man lift



Lifetime guarantee
(See page 107)



Shower tray available

Enclosures

Skyline® Sliding Door 271

Door size	Door adjustment min - max width	Door opening aperture	Code	RRP Price
1000mm	950-1010mm	360mm	1.1857.111	£510.00
1100mm	1050-1110mm	410mm	1.1857.112	£540.00
1200mm	1150-1210mm	460mm	1.1857.113	£540.00
1400mm	1350-1410mm	560mm	1.1857.114	£612.00

Technical drawing

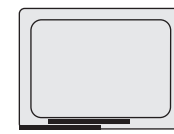

1000/1100/1200/1400mm

Optional filler section:

- Suitable to use with Skyline® doors, side panels and enclosures
- Extends the width of a Skyline® door, side panel or enclosure by 18mm

To suit	Code	RRP Price
Doors and side panels	1.1857.101	£41.00

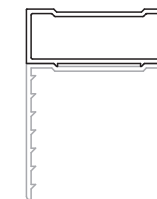

Section 249

Seat option

Choreograph® Seat
(See page 90)

Features

- Unhanded – orientation to be decided on installation by engineer
- 6mm thick safety glass door and panels
- Clear glazing
- Unique 30mm adjustment system on each wall channel
- Geometric handle mounted vertically
- Quick-release mechanism on sliders
- Hidden mechanisms and coated glass for ease of cleaning
- Height from top of tray 1900mm
- Minimum tray rim width 60mm

How to order your Skyline® Sliding Door:

Step 1

Select your door size

Step 2

Select a coordinating tray if required



Power shower approved



Coated glass



2 man lift

Lifetime guarantee
(See page 107)

Shower tray available

Enclosures

Skyline® Sliding Enclosure 272

Door size	Door adjustment min - max width	Door opening aperture	Code	RRP Price
1000mm	950-1010mm	360mm	1.1857.111	£510.00
1100mm	1050-1110mm	410mm	1.1857.112	£540.00
1200mm	1150-1210mm	460mm	1.1857.113	£540.00
1400mm	1350-1410mm	560mm	1.1857.114	£612.00

Reversible Panel

Panel size	Panel adjustment min - max width	Code	RRP Price
760mm	725-755mm	1.1857.135	£224.00
800mm	765-795mm	1.1857.136	£244.00
900mm	865-895mm	1.1857.137	£275.00

Technical drawing



1000/1100/1200/1400mm

Optional filler section:

- Suitable to use with Skyline® doors, side panels and enclosures
- Extends the width of a Skyline® door, side panel or enclosure by 18mm

To suit	Code	RRP Price
Doors and side panels	1.1857.101	£41.00

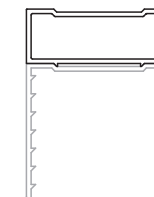

Section 249

Seat option

Choreograph® Seat
(See page 90)

Features

- Unhanded – orientation to be decided on installation by engineer
- 6mm thick safety glass door and panels
- Clear glazing
- Unique 30mm adjustment system on each wall channel
- Geometric handle mounted vertically
- Quick-release mechanism on sliders
- Hidden mechanisms for ease of cleaning
- Height from top of tray 1900mm
- Minimum tray rim width 60mm

How to order your Skyline® Sliding Enclosure:

Step 1

Select your door size

Step 2

Choose your panel size

Step 3

Select a coordinating tray if required



Power shower approved



Coated glass



2 man lift

Lifetime guarantee
(See page 107)

Shower tray available



Skyline® Double Sliding Door 274

Door size	Door adjustment min - max width	Door opening aperture	Code	RRP Price
1500mm	1450-1510mm	516mm	C1.1857.115	£714.00
1600mm	1550-1610mm	516mm	C1.1857.116	£776.00
1700mm	1650-1710mm	516mm	C1.1857.117	£816.00

Technical drawing



1500/1600/1700mm

Optional filler section:

- Suitable to use with Skyline® doors, side panels and enclosures
- Extends the width of a Skyline® door, side panel or enclosure by 18mm

To suit	Code	RRP Price
Doors and side panels	1.1857.101	£41.00

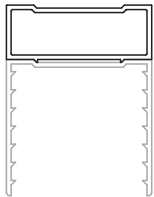

Section 249

Seat option



Choreograph® Seat
(See page 90)

Features

- 6mm thick safety glass door and panels
- Clear glazing
- Unique 30mm adjustment system on each wall channel
- Geometric handle mounted vertically
- Quick-release mechanism on sliders
- Hidden mechanisms for ease of cleaning
- Height from top of tray 1900mm
- Minimum tray rim width 60mm

How to order your Skyline® Double Sliding Door:

Step 1

Select your door size

Step 2

Select a coordinating tray if required



Power shower approved



Coated glass



2 man lift



Lifetime guarantee
(See page 107)



Shower tray available

274 Skyline® double sliding door shown with geometric handles
1600 x 900mm shower tray

Enclosures

Skyline® Double Sliding Enclosure 278

Door size	Door adjustment min - max width	Door opening aperture	Code	RRP Price
1500mm	1450-1510mm	516mm	C1.1857.115	£714.00
1600mm	1550-1610mm	516mm	C1.1857.116	£776.00
1700mm	1650-1710mm	516mm	C1.1857.117	£816.00

Reversible Panel

Panel size	Panel adjustment min - max width	Code	RRP Price
760mm	725-755mm	1.1857.135	£224.00
800mm	765-795mm	1.1857.136	£244.00
900mm	865-895mm	1.1857.137	£275.00

Technical drawing



1500/1600/1700mm

Optional filler section:

- Suitable to use with Skyline® doors, side panels and enclosures
- Extends the width of a Skyline® door, side panel or enclosure by 18mm

To suit	Code	RRP Price
Doors and side panels	1.1857.101	£41.00

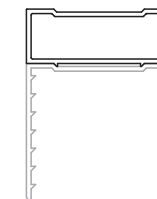

Section 249

Seat option

Choreograph® Seat
(See page 90)

Features

- 6mm thick safety glass door and panels
- Clear glazing
- Unique 30mm adjustment system on each wall channel
- Geometric handle mounted vertically
- Quick-release mechanism on sliders
- Hidden mechanisms for ease of cleaning
- Height from top of tray 1900mm
- Minimum tray rim width 60mm

How to order your Skyline® Double Sliding Enclosure:

Step 1

Select your door size

Step 2

Choose your panel size

Step 3

Select a coordinating tray if required



Power shower approved



Coated glass



2 man lift

Lifetime guarantee
(See page 107)

Shower tray available

Enclosures

Skyline® Quadrant 298

Door size (mm)	Door adjustment min - max width	Door opening aperture	Code	RRP Price
800 x 800	768-798mm	400mm	C1.1857.119	£592.00
900 x 900	868-898mm	500mm	C1.1857.120	£592.00
1000 x 800	968-998mm	450mm	C1.1857.121	£663.00
1200 x 800	1168-1198mm	450mm	C1.1857.122	£816.00
1200 x 900	1168-1198mm	500mm	C1.1857.123	£867.00

Technical drawing

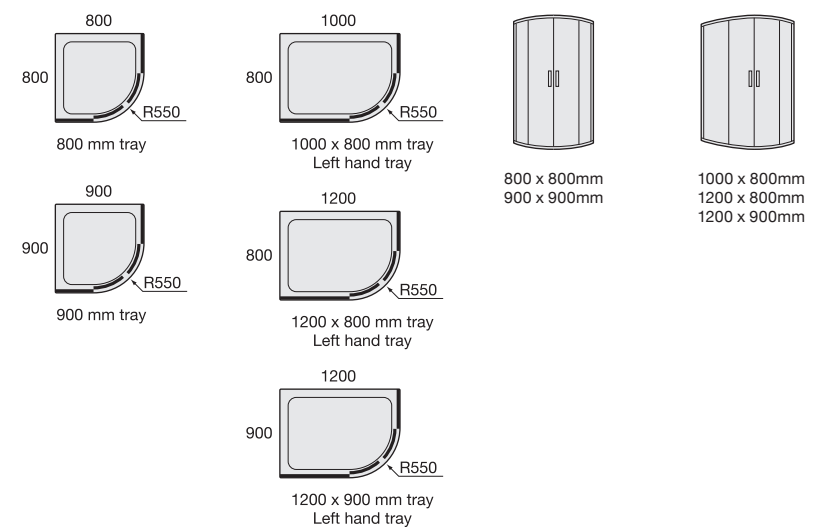

Optional filler section:

- Suitable to use with Skyline® doors, side panels and enclosures
- Extends the width of a Skyline® door, side panel or enclosure by 18mm

To suit	Code	RRP Price
Doors and side panels	1.1857.101	£41.00

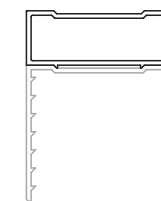

Section 249

Seat option

Choreograph® Seat
(See page 90)

Features

- Reversible Quadrant
- 6mm thick safety glass door and panels
- Clear glazing
- Hidden mechanisms for ease of cleaning
- Quick-release mechanism on sliders
- Geometric handle mounted vertically
- Unique 30mm adjustment system on each wall channel
- Height from top of tray 1900mm
- Minimum tray rim width 60mm

How to order your Skyline® Quadrant:

Step 1

Select your quadrant size

Step 2

Select a coordinating tray if required

Power shower
approvedCoated
glass2 man
liftLifetime
guarantee
(See page 107)Shower tray
available

Enclosures

Skyline® Walk-In 210

Walk-in without end panel

Enclosure size	Door opening aperture	Code	RRP Price
1400mm	540mm	1.1781.491	£689.00
1700mm	590mm	1.1781.492	£767.00

Walk-in with end panel

Enclosure size	Door opening aperture	Code	RRP Price
1400mm	540mm	1.1781.494	£981.00
1700mm	590mm	1.1781.493	£1,055.00

Tray

To suit enclosure size	Left hand tray code	Right hand tray code	RRP Price
1400 x 800mm	400993	400994	£379.00
1700 x 700mm	400995	400996	£477.00

When choosing a glass divider panel, please be aware that spray/mist may extend beyond the length of the glass panel, the amount will depend upon the power of the shower and its location. We would recommend use of these products with tiled floors.

Technical drawing

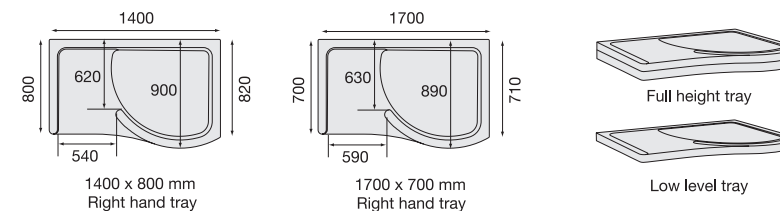

Optional filler section:

- Suitable to use with Skyline®, doors, side panels and enclosures
- Extends the width of a Skyline®, door, side panel or enclosure by 18mm

To suit	Code	RRP Price
Doors and side panels	1.1857.101	£41.00

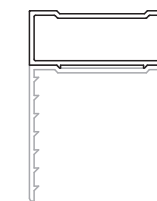

Section 249

Seat option

Choreograph® Seat
(See page 90)

Optional Riser Kit

To suit tray size	Code	RRP Price
1400 x 800mm	400971	£51.00
1700 x 700mm	400970	£55.00

Features

- The unit is handed by the tray
- End panel – matching towel rail, with choice of installation positions (optional terms)
- Includes integral low-level white tray 80mm high
- 5mm thick safety glass door and panels
- Clear glazing
- Height from top of the tray 1900mm

How to order your Skyline® Walk-In:

Step 1

Select your walk-in size, handing, with or without side panel

Step 2

Select a coordinating tray if required



2 man lift



Coated glass



Shower tray available

Lifetime guarantee
(See page 107)

Enclosures

Skyline® Hinged Walk-In 688

Panel size	Overall length fully extended min - max	Wall channel adjustment	Left hand code	Right hand code	RRP Price
800mm	1200-1229mm	29mm	108374 & 108170	108376 & 108294	£947.00
900mm	1300-1329mm	29mm	108156 & 108170	108165 & 108294	£978.00
1000mm	1400-1429mm	29mm	108157 & 108170	108166 & 108294	£1,051.00
1200mm	1600-1629mm	29mm	108158 & 108170	108167 & 108294	£1,183.00

When choosing a glass divider panel, please be aware that spray/mist may extend beyond the length of the glass panel, the amount will depend upon the power of the shower and its location. We would recommend use of these products with tiled floors.

Technical drawing

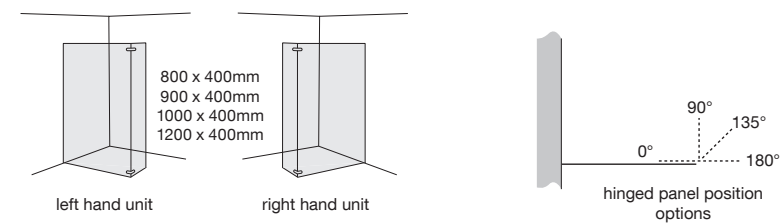

N.B Recommended opening 600mm when hinged panel is in the closed position.

Required wet-room floor anchor kit

- Wet-room kit contains 1 floor anchor point

Item	Code	RRP Price
Wet-room floor anchor kit	308069	£27.00

Tray compatibility chart

- Please use this chart to check compatibility between Skyline® Walk-In and Low Profile Tray sizes

Tray size	Walk-In			
	800	900	1000	1200
1400 x 760mm	Yes	Yes		
1400 x 900mm	Yes	Yes		
1500 x 760mm	Yes	Yes	Yes	
1600 x 700mm	Yes	Yes	Yes	
1600 x 760mm	Yes	Yes	Yes	
1700 x 700mm	Yes	Yes	Yes	Yes
1700 x 760mm	Yes	Yes	Yes	Yes

Seat option



Choreograph® Seat
(See page 90)

Features

- The position of the fixed panel denotes handing, please state left or right when ordering
- 8mm frameless safety glass panels
- Clear glazing
- 400mm hinged panel with stops at 0°, 90°, 135° and 180° provides flexible showering
- Choice of shower trays
 - set as a return panel to reduce spray
 - fully extended to increase overall panel length
 - folded back to aid access
- Available with wet-room floor anchor kit
- Supplied with bracing bars, see details opposite
- Height: 1950mm
- Unique 29mm adjustment system on wall profile
- Recommended minimum tray rim width is 30mm
- Please fit on a larger size tray to avoid the hinged panel overhanging

How to order your Skyline® Hinged Walk-In:

Step 1

Select your walk-in size

Step 2

Choose left or right handing

Step 3

Select a coordinating tray if required



2 man lift



Coated glass



Shower tray available



Lifetime guarantee
(See page 107)

Walk-In & Dividers

KOHLER® walk-in and divider panels deliver both quality and reliability to the most discerning customers, at an affordable price point. These frameless glass panels separate the shower from the rest of the bathroom in a discrete way. This range provides minimalist shower screens with coated safety glass and clear glazing.

Product Pages

327 Minima® NG Divider Panel

85

210 Skyline® Walk-In

87

688 Skyline® Hinged Walk-In

89

Features

- 5mm, 8mm & 10mm safety glass options
- Clear glazing
- Tray options available
- Made-to-Measure options available



Minima® NG Glass Divider Panel 327

Step 1: Choose your complete panel size (A)

Width (mm)	Min (mm)	Max (mm)	Adjust	Code	RRP Price
400	399	411	12	1.1825.059	£318.00
800	750	762	12	1.1825.060	£624.00
900	850	862	12	1.1825.061	£648.00
1000	950	962	12	1.1825.062	£672.00
1200	1150	1162	12	1.1825.063	£696.00
1400	1336	1348	12	1.1825.064	£720.00

When choosing a glass divider panel, please be aware that spray/mist may extend beyond the length of the glass panel, the amount will depend upon the power of the shower and its location. We would recommend use of these products with tiled floors.

Technical drawing

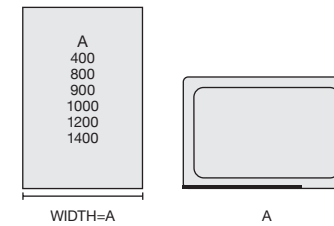

N.B Recommended opening 600mm

Optional filler section

Item	Code	Price
Hinge standard profile	1.1825.282	£75.00

Seat option



Choreograph® Seat
(See page 90)

Key Features

- Unhanded – orientation to be decided on installation by engineer
- L-shaped bracket supplied with all divider panels
- Additional 90° bracing bar supplied with panels wider than 1000mm
- Height from top of the tray to glass is 2000mm
- Minimum tray width 40mm
- Nominal sizes are designed to fit onto standard sizes of shower tray
- 10mm thick safety glass
- Glass coating as standard
- Made-to-Measure options available specifically for your space



Power shower approved



Coated glass



Made-to-measure



Shower tray available



2 man lift



Lifetime guarantee
(See page 107)

Enclosures

Skyline® Walk-In 210

Walk-in without end panel

Enclosure size	Door opening aperture	Code	RRP Price
1400mm	540mm	1.1781.491	£689.00
1700mm	590mm	1.1781.492	£767.00

Walk-in with end panel

Enclosure size	Door opening aperture	Code	RRP Price
1400mm	540mm	1.1781.494	£981.00
1700mm	590mm	1.1781.493	£1,055.00

Tray

To suit enclosure size	Left hand tray code	Right hand tray code	RRP Price
1400 x 800mm	400993	400994	£379.00
1700 x 700mm	400995	400996	£477.00

When choosing a glass divider panel, please be aware that spray/mist may extend beyond the length of the glass panel, the amount will depend upon the power of the shower and its location. We would recommend use of these products with tiled floors.

Technical drawing

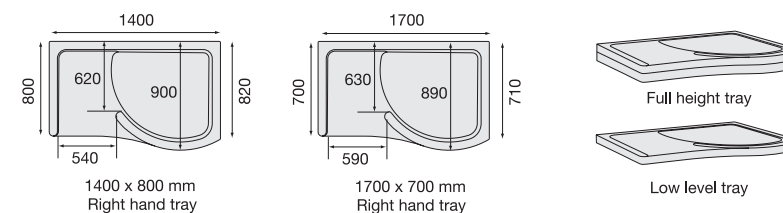

Optional filler section:

- Suitable to use with Skyline®, doors, side panels and enclosures
- Extends the width of a Skyline®, door, side panel or enclosure by 18mm

To suit	Code	RRP Price
Doors and side panels	1.1857.101	£41.00

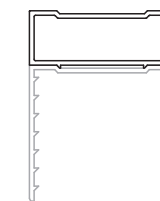

Section 249

Seat option

Choreograph® Seat
(See page 90)

Optional Riser Kit

To suit tray size	Code	RRP Price
1400 x 800mm	400971	£51.00
1700 x 700mm	400970	£55.00

Features

- The unit is handed by the tray
- End panel – matching towel rail, with choice of installation positions (optional terms)
- Includes integral low-level white tray 80mm high
- 5mm thick safety glass door and panels
- Clear glazing
- Height from top of the tray 1900mm

How to order your Skyline® Walk-In:

Step 1

Select your walk-in size, handing, with or without side panel

Step 2

Select a coordinating tray if required



2 man lift



Coated glass



Shower tray available

Lifetime guarantee
(See page 107)

Enclosures

Skyline® Hinged Walk-In 688

Panel size	Overall length fully extended min - max	Wall channel adjustment	Left hand code	Right hand code	RRP Price
800mm	1200-1229mm	29mm	108374 & 108170	108376 & 108294	£947.00
900mm	1300-1329mm	29mm	108156 & 108170	108165 & 108294	£978.00
1000mm	1400-1429mm	29mm	108157 & 108170	108166 & 108294	£1,051.00
1200mm	1600-1629mm	29mm	108158 & 108170	108167 & 108294	£1,183.00

When choosing a glass divider panel, please be aware that spray/mist may extend beyond the length of the glass panel, the amount will depend upon the power of the shower and its location. We would recommend use of these products with tiled floors.

Technical drawing

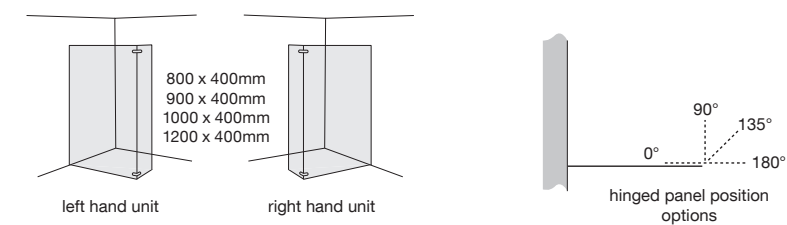

N.B Recommended opening 600mm when hinged panel is in the closed position.

Required wet-room floor anchor kit

- Wet-room kit contains 1 floor anchor point

Item	Code	RRP Price
Wet-room floor anchor kit	308069	£27.00

Tray compatibility chart

- Please use this chart to check compatibility between Skyline® Walk-In and Low Profile Tray sizes

Tray size	Walk-In			
	800	900	1000	1200
1400 x 760mm	Yes	Yes		
1400 x 900mm	Yes	Yes		
1500 x 760mm	Yes	Yes	Yes	
1600 x 700mm	Yes	Yes	Yes	
1600 x 760mm	Yes	Yes	Yes	
1700 x 700mm	Yes	Yes	Yes	Yes
1700 x 760mm	Yes	Yes	Yes	Yes

Seat option



Choreograph® Seat
(See page 90)

Features

- The position of the fixed panel denotes handing, please state left or right when ordering
- 8mm frameless safety glass panels
- Clear glazing
- 400mm hinged panel with stops at 0°, 90°, 135° and 180° provides flexible showering
- Choice of shower trays
 - set as a return panel to reduce spray
 - fully extended to increase overall panel length
 - folded back to aid access
- Available with wet-room floor anchor kit
- Supplied with bracing bars, see details opposite
- Height: 1950mm
- Unique 29mm adjustment system on wall profile
- Recommended minimum tray rim width is 30mm
- Please fit on a larger size tray to avoid the hinged panel overhanging

How to order your Skyline® Hinged Walk-In:

Step 1

Select your walk-in size

Step 2

Choose left or right handing

Step 3

Select a coordinating tray if required



2 man lift



Coated glass



Shower tray available



Lifetime guarantee
(See page 107)

Choreograph® Freestanding Shower Seat

The Choreograph® seat makes it easier than ever to create a shower space that caters to your needs, your style, and your life. Make your shower time more relaxing with this freestanding shower seat. Its unique height offers optimal comfort for daily grooming tasks, both in and out of the shower.

- Elevates you to the ideal showering position for maximum water pressure and minimal heat loss
- One-piece construction designed for water drainage and easy cleaning
- Can be used inside and outside the shower
- Rated to a static weight of 137kg
- Polypropylene construction
- Anti-slip coating
- Anti-slip feet

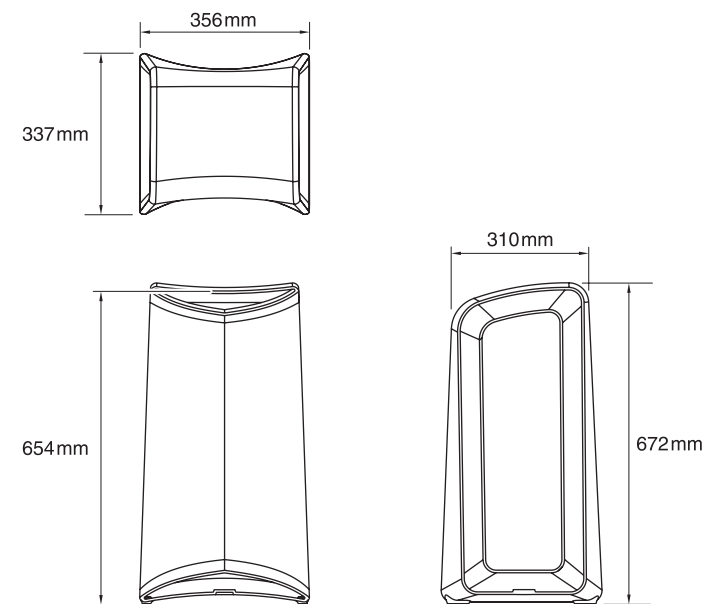

Code	Description	RRP Price
97632-0	Choreograph® freestanding shower seat	£249.00

Enclosure Care Kit

Available in one Care Kit, the treatment and protector are used on new or existing shower installations, where protector has not already been applied, and for topping up factory coated glass after a reasonable length of time. The treatment must always be used on existing shower installations to prepare for the protector. The treatment is a cleaning material that is applied to the glass to ensure it is in the cleanest condition possible prior to application of the protector. If this process is not undertaken, there is the likelihood of locking in dust, dirt and stains under the protector.

The Care Kit includes: one bottle of glass treatment, one bottle of glass protector, 4 cloths and 2 rubber gloves.

Nano-technology

- Intelligent particles self-organise to smoothen and stop dirt sticking to the glass

Easy clean

- Makes cleaning effortless. No need for strong cleaning agents

Repels water

- The nano-particles repel water to stop dirt and limescale build-up

Limescale resistant

- The nano-particles fill gaps in the glass so limescale can't grip the surface

Long lasting

- The durability of the agent means you won't have to re-apply frequently

Code	Description	RRP Price
305817	Enclosure Care Kit	£44.00
305818	Glass Cleaner	£21.00
306590	Glass Cleaner & Enclosure Care Kit	£57.00

Bath Screens

Good things come in small packages. When size precludes a separate shower enclosure, bath screens lend big impact to the smallest bathroom. Single panel or discreet folding bath screens mean you are sure to find a look that meets your needs.

Product Pages

Minima [®] NG Hinged Twin Panel Bath Screens	94
Single Panel Bath Screens	94
Reversible Twin Panel Bath Screens	95

Features

- 5-10mm glass
- Single or twin panel
- Fixed panels for improved water retention
- Round, Sail or Square shapes available



Minima® NG Bath Screen 352

Item	Min (mm)	Max (mm)	Adjust	Code	RRP Price
Minima® NG Bath Screen	994	1006	12	1.1825.057	£768.00

Key features

- Height requirements by special request
- For doors with inline panels and prices assume standard door size specified (please ask for pricing on non-standard doors)
- Bath Screen can open inwards or outwards – to be decided on installation by engineer

Technical drawing

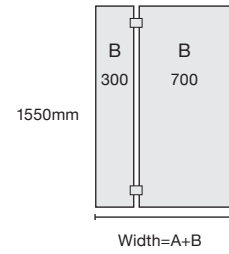

Single Panel Bath Screen 050

Item	Colour/Finish	Material	Kg	Code	RRP Price
Single panel Bath Screen W800 x H1450mm 5mm Safety glass Adjustment for out-of-true walls	Clear Glass	Polished Chrome	25		
Single Panel Reversible Square				1.1863.005	£271.00
Single Panel Reversible Round				1.1863.007	£271.00
Single Panel Reversible Sail				1.1863.009	£271.00

Technical drawing

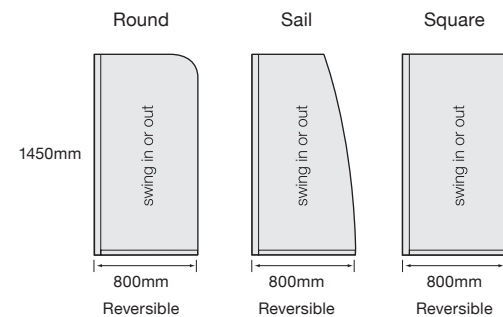

Coated glass



Lifetime guarantee
(See page 107)



2 man lift



Inward/outward opening

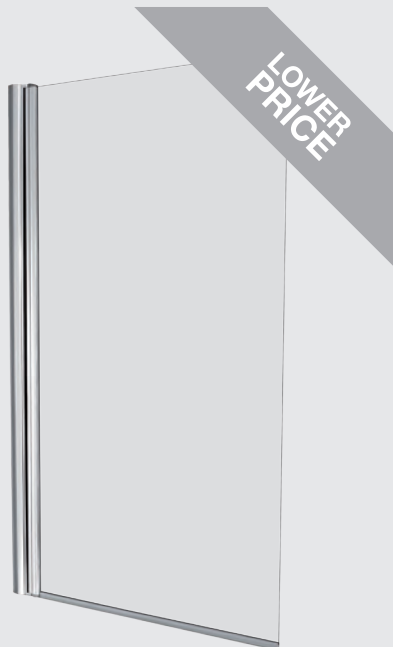

Coated glass



Lifetime guarantee
(See page 107)

Bath Screens

Reversible Twin Panel Bath Screen 051/052

Item	Colour / Finish	Material	Kg	Code	RRP Price
A Reversible Twin Panel Sail W900 x H1550mm	Clear Glass	Polished Chrome	24	2.1863.001	£373.00
Reversible Twin Panel Square W900 x H1550mm			24	1.1863.002	£373.00
<ul style="list-style-type: none"> • Fixed panel for folding screens • All panels are reversible • 5mm Safety glass • Hinged from fixed panel & folds to 90° 					
B Reversible Twin Panel Sail W900 x H1550mm	Clear Glass	Polished Chrome	22	2.1863.046	£373.00
Reversible Twin Panel Square W900 x H1550mm			22	2.1863.047	£373.00
<ul style="list-style-type: none"> • Fixed panel for folding screens • All panels are reversible • 5mm Safety glass • Hinged from fixed panel & folds to 90° 					

Technical drawing

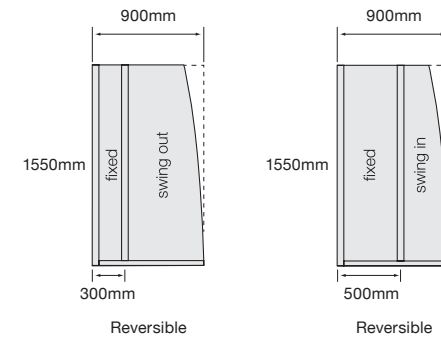

Coated glass



Lifetime guarantee
(See page 107)



Shower Trays

Less is more for our range of low-profile shower trays. Thin yet incredibly strong, their slender lines almost vanish into the floor, complementing modern shower enclosures perfectly to complete the minimalist ideal. What's more, ingenious design and advanced materials help keep cleaning minimal too.

Product Pages

Standard Shower Trays	99
Anti-Slip Shower Trays	101
Low Level Plus Trays	103

Features

- Choice of Low-Profile, Anti-Slip and Walk-In trays
- Walk-In trays are suitable for use with walk-in enclosures
- BioCote® incorporated to reduce bacteria growth by up to 99.9%
- Tray colour white
- 10 year guarantee
- Anti-Slip is available on all trays except Low Level Plus trays



N.B Amicio shower system shown no longer sold in the UK

Shower Trays – How to Shop

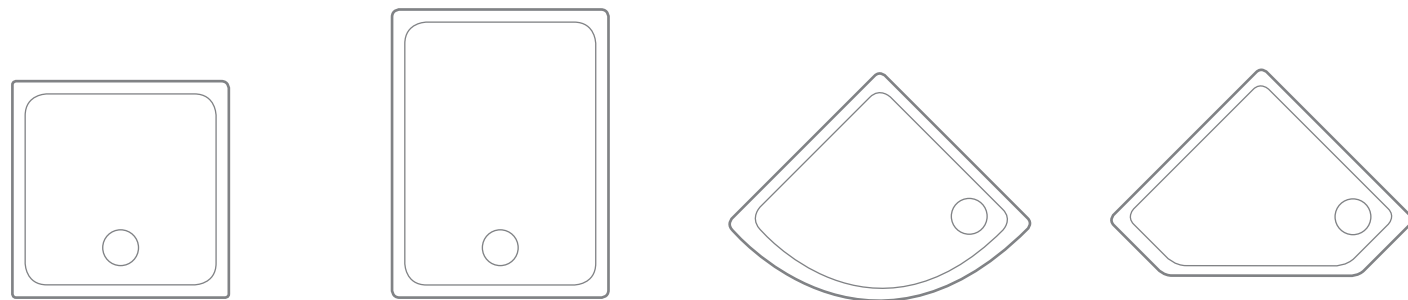

Low Profile Tray

Choose from a range of Low-Profile shower trays to create your minimalist shower enclosure. The 40mm height makes it one of the slimmest shower trays available, giving a sleek almost invisible “wet-room” look. The sleek styling flows through to the waste, which is integrated into the design to give a level surface for you to stand on.

- Low-profile tray with ‘walk-on’ waste
- Patented laminated construction gives incredible strength whilst reducing weight
- BioCote® incorporated to reduce bacterial/mould growth by up to 99.9%
- All trays available with riser kit for easy installation on concrete floors
- Tray colour white
- 10 year guarantee

Riser Kits

A riser kit allows you to convert a low level tray to a riser tray providing the flexibility of installation on a solid floor. Each kit contains easy to install removable panels, simple clip-on fixings and robust adjustable push-fit riser legs.





Riser kit legs provide adjustability to make flat. The height of the tray has to be 100mm from the floor surface to the underside of the tray. The new panel sits under the tray. Numbers on each leg indicate level setting and once height is set, locking nuts ensure no movement.

Technical Details

Height: 40mm
 Rim width: 66mm
 Height on riser: 140mm
 Front surface: Durable Acrylic capped ABS incorporating BioCote®
 Filler: Resin-stone concrete for stiffness
 Rear skin: ABS
 Max flow rate: 30l/m



Standard Shower Trays

Tray Shape	Code	Size	RRP Price	Riser Kit	RRP Price
	400931	800 x 800 x 40mm (radius 550mm)	£173.00	400966	£82.00
	400883	900 x 900 x 40mm (radius 550mm)	£186.00	400966	£82.00
	400941	1000 x 800 x 40mm left hand (radius 550mm)	£242.00	400963	£124.00
	400942	1000 x 800 x 40mm right hand (radius 550mm)	£242.00	400963	£124.00
	401012	1000 x 1000 x 40mm (radius 550mm)	£230.00	401022	£98.00
	400943	1200 x 900 x 40mm left hand (radius 550mm)	£275.00	400963	£124.00
	400944	1200 x 900 x 40mm right hand (radius 550mm)	£275.00	400963	£124.00
	400932	900 x 900 x 40mm	£186.00	400965	£124.00
	400951	1200 x 900 x 40mm left hand	£276.00	400962	£124.00
	400952	1200 x 900 x 40mm right hand	£276.00	400962	£124.00
	400921	760 x 760 x 40mm	£107.00	401001	£98.00
	400881	800 x 800 x 40mm	£119.00	401001	£98.00
	400882	900 x 900 x 40mm	£184.00	401001	£98.00
	400953	1000 x 1000 x 40mm	£256.00	401001	£98.00
	400922	900 x 760 x 40mm	£186.00	400960	£72.00
	1.1824.001.WH	1000 x 700 x 40mm	£197.00	400960	£72.00
	400884	1000 x 760 x 40mm	£193.00	400960	£72.00
	400885	1000 x 800 x 40mm	£205.00	400960	£72.00
	400886	1100 x 800 x 40mm	£228.00	400961	£75.00
	1.1824.002.WH	1200 x 700 x 40mm	£246.00	400961	£75.00
	400887	1200 x 760 x 40mm	£207.00	400961	£75.00
	400888	1200 x 800 x 40mm	£222.00	400961	£75.00
	400923	1200 x 900 x 40mm	£230.00	400961	£75.00
	1.1824.003.WH	1400 x 700 x 40mm	£288.00	400964	£105.00
	400889	1400 x 760 x 40mm	£259.00	400964	£105.00
	400924	1400 x 800 x 40mm	£311.00	400964	£105.00
	401013	1400 x 900 x 40mm	£325.00	401021	£105.00
	1.1824.004.WH	1500 x 700 x 40mm	£330.00	400964	£105.00
	400890	1500 x 760 x 40mm	£332.00	400964	£105.00
	400925	1600 x 700 x 40mm	£384.00	400964	£105.00
	400891	1600 x 760 x 40mm	£394.00	400964	£105.00
	401014	1600 x 900 x 40mm	£428.00	401021	£105.00
	400926	1700 x 700 x 40mm	£401.00	400964	£105.00
	400892	1700 x 760 x 40mm	£417.00	400964	£105.00
401015	1700 x 900 x 40mm	£449.00	401021	£105.00	



Clean and fresh forever with innovative BioCote® technology, every low profile tray stays protected for its whole lifetime, thanks to the antibacterial technology BioCote®, which is incorporated into the manufacturing process. This innovative antibacterial technology will keep your new shower tray cleaner than ever before by reducing bacteria and mould growth by up to 99.9%.

anti-slip

Shower Trays



The KOHLER® anti-slip tray is an anti-slip tray like no other. This tray exceeds the most stringent independently tested anti-slip test, passing at – Class C.

- Anti-slip coating is applied to the whole tray surface
- Low-profile 40mm shower tray
- The coating is bonded to the tray for a long lasting finish
- Tray colour white
- Patented laminated construction gives incredible strength whilst reducing weight
- BioCote® integrated into the anti-slip surface which reduces bacteria and mould growth by up to 99.9%
- Easy to clean
- All trays available with riser kit for easy installation on solid floor installations
- Anti-slip is available on all trays
- 10 year guarantee



Ultimate safety with anti-slip coating

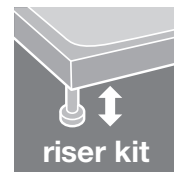

Optional riser kits with easy 'push-fit' legs



Reduces bacteria and mould by up to 99.9%

Best in Class

What does Class C mean?

Kohler Anti-slip tray has achieved Class C for DIN 51097 – a barefoot ramp test. In testing the tray is fixed to the ramp and made wet and soapy. The tray is then inclined until the test subject slips.

The grip is given a classification depending on the angle of inclination of the slip. Class C is the highest classification. A tray must be inclined to a minimum of 24° with the test subject still standing.

On Kohler Anti-slip trays, test subjects were still standing at an incline of over 30°.

DIN 51097 Ramp test for barefoot		Ramp angle
	Class A	12°
	Class B	18°
	Class C	24°
	Kohler Anti-slip tray	30°

Anti-slip Shower Trays

Tray Shape	Code	Size	RRP Price	Riser Kit	RRP Price
	1.1824.032.AS	800 x 800 x 40mm (radius 550mm)	£241.00	400966	£82.00
	1.1824.033.AS	900 x 900 x 40mm (radius 550mm)	£260.00	400966	£82.00
	1.1824.035.AS	1000 x 800 x 40mm left hand (radius 550mm)	£338.00	400963	£124.00
	1.1824.036.AS	1000 x 800 x 40mm right hand (radius 550mm)	£338.00	400963	£124.00
	1.1824.034.AS	1000 x 1000 x 40mm (radius 550mm)	£322.00	401022	£98.00
	1.1824.037.AS	1200 x 900 x 40mm left hand (radius 550mm)	£385.00	400963	£124.00
	1.1824.038.AS	1200 x 900 x 40mm right hand (radius 550mm)	£385.00	400963	£124.00
	1.1824.039.AS	900 x 900 x 40mm	£260.00	400965	£124.00
	1.1824.040.AS	1200 x 900 x 40mm left hand	£386.00	400962	£124.00
	1.1824.041.AS	1200 x 900 x 40mm right hand	£386.00	400962	£124.00
	1.1824.011.AS	760 x 760 x 40mm	£148.00	401001	£98.00
	1.1824.012.AS	800 x 800 x 40mm	£167.00	401001	£98.00
	1.1824.014.AS	900 x 900 x 40mm	£256.00	401001	£98.00
	1.1824.017.AS	1000 x 1000 x 40mm	£359.00	401001	£98.00
	1.1824.013.AS	900 x 760 x 40mm	£260.00	400960	£72.00
	1.1824.001.AS	1000 x 700 x 40mm	£276.00	400960	£72.00
	1.1824.015.AS	1000 x 760 x 40mm	£272.00	400960	£72.00
	1.1824.016.AS	1000 x 800 x 40mm	£286.00	400960	£72.00
	1.1824.018.AS	1100 x 800 x 40mm	£318.00	400961	£75.00
	1.1824.002.AS	1200 x 700 x 40mm	£343.00	400961	£75.00
	1.1824.019.AS	1200 x 760 x 40mm	£290.00	400961	£75.00
	1.1824.020.AS	1200 x 800 x 40mm	£309.00	400961	£75.00
	1.1824.021.AS	1200 x 900 x 40mm	£322.00	400961	£75.00
	1.1824.003.AS	1400 x 700 x 40mm	£404.00	400964	£105.00
	1.1824.022.AS	1400 x 760 x 40mm	£361.00	400964	£105.00
	1.1824.023.AS	1400 x 800 x 40mm	£435.00	400964	£105.00
	1.1824.024.AS	1400 x 900 x 40mm	£455.00	401021	£105.00
	1.1824.004.AS	1500 x 700 x 40mm	£461.00	400964	£105.00
	1.1824.025.AS	1500 x 760 x 40mm	£465.00	400964	£105.00
	1.1824.026.AS	1600 x 700 x 40mm	£536.00	400964	£105.00
	1.1824.027.AS	1600 x 760 x 40mm	£553.00	400964	£105.00
	1.1824.028.AS	1600 x 900 x 40mm	£597.00	401021	£105.00
	1.1824.029.AS	1700 x 700 x 40mm	£561.00	400964	£105.00
1.1824.030.AS	1700 x 760 x 40mm	£584.00	400964	£105.00	
1.1824.031.AS	1700 x 900 x 40mm	£630.00	401021	£105.00	



Low Level Plus Trays

A new range of shower trays offering three types of installation to suit your needs, including a streamlined, discreet wet-room solution.

- Low-profile 40mm shower tray
- Can be surface-mounted with or without riser kit, as well as flush-mounted, giving a 'Walk-in wet-room' solution for ease of accessibility
- Extra large sizes available to replace a bath installation
- Tray colour white
- 4 colour options for waste covering; White, Grey Anthracite, Silver & Taupe
- Patented robust material gives incredible strength whilst reducing weight
- BioCote® reduces bacteria and mould growth by up to 99.9%
- Quick and easy installation with new riser kit
- New low-profile hidden waste
- 10 year guarantee

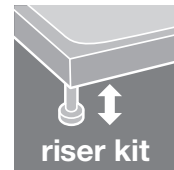

riser kit

Optional riser kits with easy 'push-fit' legs



anti-bacteria

Reduces bacteria and mould by up to 99.9%

Low Level Plus Trays

Tray Shape	Code	Size	RRP Price	Riser Kit	RRP Price
Square	1.1764.494.WH	800 x 800 x 40mm	£177.00	1.1764.563	£133.00
	1.1764.502.WH	900 x 900 x 40mm	£231.00	1.1764.563	£133.00
Rectangle	1.1764.492.WH	1000 x 700 x 40mm	£357.00	1.1764.563	£133.00
	1.1764.495.WH	1000 x 800 x 40mm	£354.00	1.1764.563	£133.00
	1.1764.493.WH	1200 x 700 x 40mm	£405.00	1.1764.563	£133.00
	1.1764.496.WH	1200 x 800 x 40mm	£413.00	1.1764.563	£133.00
	1.1764.503.WH	1200 x 900 x 40mm	£276.00	1.1764.563	£133.00
	1.1764.497.WH	1400 x 800 x 40mm	£458.00	1.1764.564	£148.00
	1.1764.504.WH	1400 x 900 x 40mm	£461.00	1.1764.564	£148.00
	1.1764.498.WH	1500 x 800 x 40mm	£470.00	1.1764.564	£148.00
	1.1764.499.WH	1600 x 800 x 40mm	£482.00	1.1764.564	£148.00
	1.1764.505.WH	1600 x 900 x 40mm	£562.00	1.1764.564	£148.00
	1.1764.500.WH	1700 x 800 x 40mm	£494.00	1.1764.564	£148.00
1.1764.501.WH	1800 x 800 x 40mm	£507.00	1.1764.564	£148.00	
White waste cover	E62C70-00	700mm	£50.00		
	E62C80-00	800mm	£60.00		
	E62C90-00	900mm	£70.00		
Silver waste cover	E62C70-S21	700mm	£50.00		
	E62C80-S21	800mm	£60.00		
	E62C90-S21	900mm	£70.00		
Grey anthracite waste cover	E62C70-M53	700mm	£50.00		
	E62C80-M53	800mm	£60.00		
	E62C90-M53	900mm	£70.00		
Taupe waste cover	E62C70-M65	700mm	£50.00		
	E62C80-M65	800mm	£60.00		
	E62C90-M65	900mm	£70.00		

Waste Cover Features

- Dedicated extra slim waste
- Available in 3 sizes; 700mm, 800mm & 900mm
- Available in 4 finishes; White, Grey Anthracite, Silver & Taupe
- Removable waste cover for ease of cleaning
- Integrated hair trap

Riser Kit Features

- Unique riser frame with integrated spirit levels improves installation time
- Adjustable bar allows leveling of the frame prior to tray installation

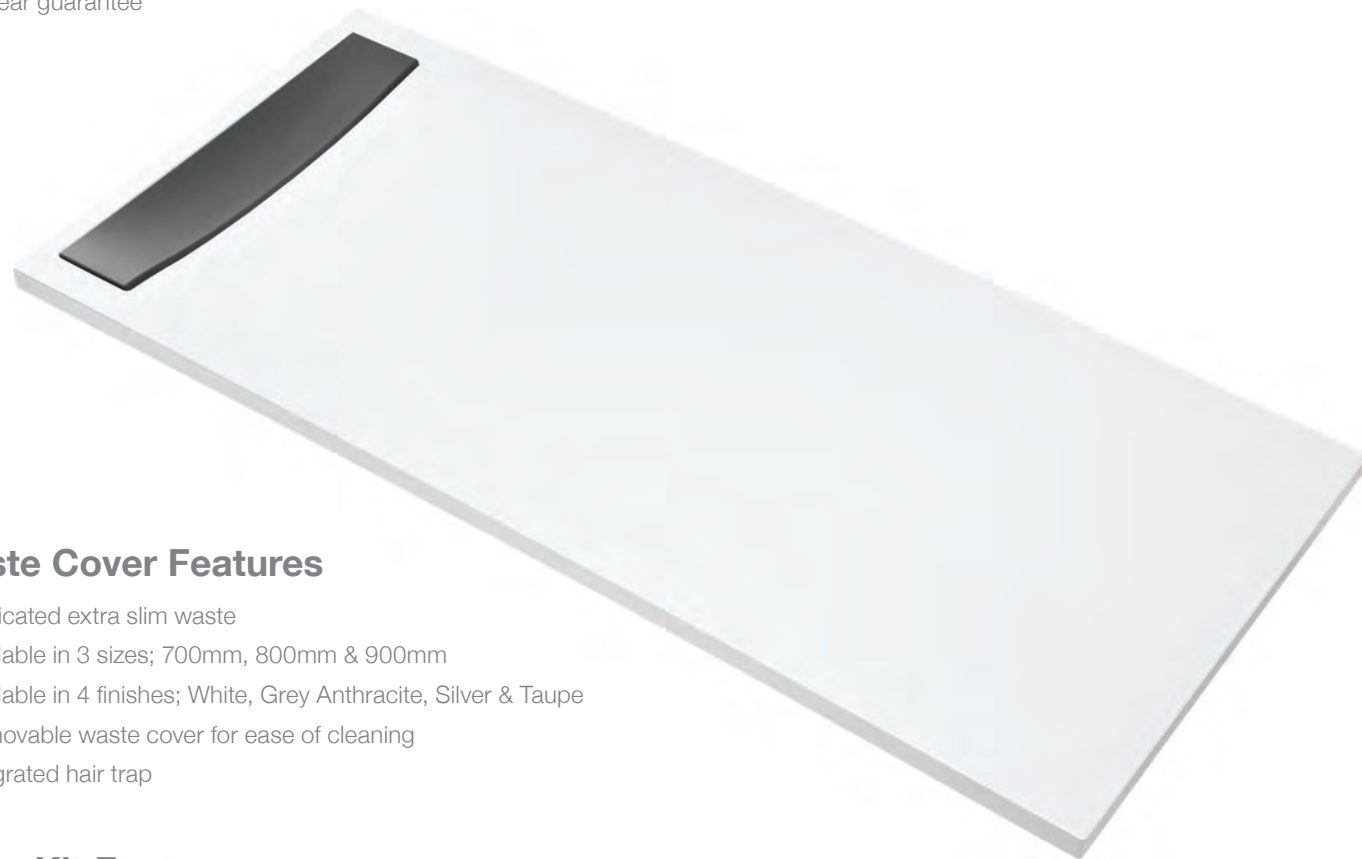

Life without labour is guilt. Labour without art is brutality. - John Ruskin



and closets that carry the Kohler mark are well designed and will stand in the test of time. If you use colored fixtures, Kohler colors are pure, uniform, harmonious. If you prefer white, Kohler white is as immaculate as fresh laundered linen. Kohler lavatory and handles and

Kohler's reputation for quality is well known. The men who do each intricate detail of manufacture work on rigid engineering requirements—and with the care of high art.

As all Kohler bathroom—the same cost. Quality is not a matter of money—but of knowledge and wisdom. Even the small home must have the finest fixtures

Eleven Important Points

1. Kohler fixtures are designed for perfect plumbing.
2. Kohler fixtures are made of the finest materials.
3. Kohler fixtures are made in the United States.
4. Kohler fixtures are made in the United States.
5. Kohler fixtures are made in the United States.
6. Kohler fixtures are made in the United States.
7. Kohler fixtures are made in the United States.
8. Kohler fixtures are made in the United States.
9. Kohler fixtures are made in the United States.
10. Kohler fixtures are made in the United States.
11. Kohler fixtures are made in the United States.

KOHLER OF KOHLER



WHEN A FELLER NEEDS AN ARCHITECT

When a feller needs an architect, he needs a man who can design a house that is both beautiful and practical. Kohler's reputation for quality is well known. The men who do each intricate detail of manufacture work on rigid engineering requirements—and with the care of high art.

As all Kohler bathroom—the same cost. Quality is not a matter of money—but of knowledge and wisdom. Even the small home must have the finest fixtures

Eleven Important Points

1. Kohler fixtures are designed for perfect plumbing.
2. Kohler fixtures are made of the finest materials.
3. Kohler fixtures are made in the United States.
4. Kohler fixtures are made in the United States.
5. Kohler fixtures are made in the United States.
6. Kohler fixtures are made in the United States.
7. Kohler fixtures are made in the United States.
8. Kohler fixtures are made in the United States.
9. Kohler fixtures are made in the United States.
10. Kohler fixtures are made in the United States.
11. Kohler fixtures are made in the United States.



What John Michael Kohler saw in 1883 when he looked at a cast-iron horse trough was the bathtub that launched a global plumbing company. That pioneering spirit of ingenuity – the kind that sees a bathing revolution in a horse trough – has defined Kohler Co. from its earliest days. A visionary, John Michael Kohler understood the importance of innovative design and an uncompromising commitment to craft and quality. After four generations, we remain a family-owned company, with over 26,000 products and 13,000 patents to our name. Still leading the industry in innovation and design. Bolder than ever.

A KOHLER Experience®



Thank you.

If you'd like to learn more about KOHLER® and our complete product offering, we invite you to take a look at our website or stop by a displaying Kohler Showroom.

Showrooms

To experience Kohler bathroom products first hand, visit KOHLER.co.uk to find a displaying showroom near you.

Peace-of-mind guarantee

At Kohler, we are confident in the quality and reliability of our products and guarantee them against faulty materials or workmanship, provided they have been installed, cared for and used in accordance with our instructions.

25 years	Ceramic and enameled cast iron products
10 years	Acrylic baths, metal Vessels and Shower Trays
5 years	Shower valves, taps, bath panels, cistern fittings and seats
2 years	Bathroom furniture and accessories
1 year	Whirlpool and spa systems

Kohler enclosures & bath screens hold a lifetime guarantee – certain exclusions & conditions apply, see website for full details.

Our lifetime guarantee is available to the original private domestic customer only who buys a Kohler shower enclosure and who completes and returns to Kohler the guarantee registration form, along with a copy of proof of purchase from an approved Kohler retailer, within 30 days of purchase.

Where the purchase of a Kohler shower enclosure has not been registered, the lifetime guarantee does not apply but you will be entitled to a 12 month guarantee from the date of purchase. Proof of purchase is necessary.

For further information please visit KOHLER.co.uk or call us for a copy of the terms and conditions and to register your guarantee.

Contacting us

For Kohler Customer Service or technical enquiries, please call us on +44 (0) 844 571 0048.

E-mail info@kohler.co.uk or visit our website KOHLER.co.uk

For technical details please visit www.kohlerpro.co.uk for further information.



Define your Bathroom Space

Showcasing a full range of sanitaryware, coordinating furniture, mirrors, taps, artist editions, enclosures and showering. We are confident you will find something to inspire you.



Kitchen Sinks & Taps

Combining beautiful design and smart functionality, Kohler kitchen sinks and taps simplify everyday tasks and bring inspiration to life. Our full-line catalogue will help you choose the right ingredients to create a kitchen that suits your life.

Join us for an unforgettable stay at the Old Course Hotel in St Andrews, Scotland, or The American Club® in Kohler, Wisconsin, where you'll enjoy classically elegant settings, sumptuous cuisine, exclusive spa and golf experiences, luxurious amenities and quietly confident service. Plan your experience at KOHLERexperience.com.



KOHLER.co.uk

View the latest bathroom designs
at KOHLER.co.uk.

© 2016 by Kohler Co.
Kohler UK

Cromwell Road Cheltenham Gloucestershire GL52 5EP United Kingdom
Sales & Technical Tel: +44 (0) 844 571 0048

KENC16

THE BOLD LOOK
OF **KOHLER**®

