

CONNECT + CONTROL

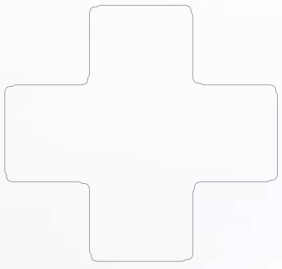

Pegler Yorkshire



MARKET LEADING METAL PUSH-FIT

CONNECT WITH CONFIDENCE

Tectite





Pegler Yorkshire



CONNECT WITH CONFIDENCE

With a wealth of expertise and the broadest range of solutions and systems on the market, Pegler Yorkshire's Connect products mean you'll complete your installation as seamlessly, efficiently and effectively as possible.

TOTAL FUNCTIONALITY, COMPLETE EFFICIENCY

Pegler Yorkshire's range of **Connect** solutions offer innovatively designed, efficient and reliable products and systems that reduce installation time and cost without compromising quality, aesthetics or reliability.

Our **Tectite**, **Henco** and **XPress** product ranges are designed to perform faultlessly in a variety of applications and environments – so you can always be sure to connect with confidence whatever your challenge.

GLOBAL EXPERIENCE, COMBINED EXPERTISE

With over 100 years of manufacturing and innovation combined with extensive industry knowledge and worldwide market experience, Pegler Yorkshire offers the most advanced and complete **Connect & Control** systems on a global scale.

As one of Britain's largest and most respected manufacturers and suppliers of products for the plumbing and heating industries, Pegler Yorkshire is confident we can provide you with all the connection, control and support your project needs.

For more information visit www.pegleryorkshire.co.uk/





Tectite

CONNECT + CONTROL

CONTENTS

Pegler Yorkshire is pleased to be associated with several influential industry organisations:



Association of Plumbing and Heating Contractors



The Bathroom Manufacturers Association



The UK Copper Board



Heating and Ventilating Contractors Association

Brass

The Brass Page for specifiers, designers, engineers and manufacturers



British Plumbing Employers Council



British Electrotechnical Allied Manufacturers Association



Construction Products Association



The Copper Development Association



Scottish and Northern Ireland Plumbing Employers Federation



Builders Merchants Federation



Institute of Plumbing



The UK District Energy Association



The Chartered Institution of Building Services Engineers



British Automatic Fire Sprinkler Association



Bundesverband Technischer Brandschutz e.V.



European Fire Sprinkler Network

1.0 PRODUCT RANGE OVERVIEW

Introduction to Tectite	4-5
Product overview	6-9
Domestic Tectite Flexible Metal System	10-11
Standards, approvals and guarantees	12-13

2.0 PRODUCT RANGE DETAILS

Tube/pipe options	14-15
Classic push-fit fittings	16-26
Classic fittings	27-28
Classic chrome	29-33
Air push-fit fittings	34-37
Sprint push-fit fittings	38-47
Sprint chrome	48-51
Pro push-fit fittings	52-59
316 push-fit fittings	60
316 tube and push-fit fittings	61-68
Carbon steel system tubing	69
Carbon push-fit fittings	70-75
Valves	76-79
Accessories	80-85

3.0 TECHNICAL DATA

Tube compatibility and applications	86
Material specification and manufacturing standards	87
Working temperatures and pressure tables	88-89
Tubes, pipe and their compatibilities	90-92
System design considerations and tube expansion	93-98
Valves	99-103

4.0 INSTALLATION INSTRUCTIONS

A quick guide to installation	104
Tectite installation instructions	105-107
Tectite installation instructions 10 - 28mm	108
Tectite installation instructions 35 - 54mm	109
Demounting	110-111



THE COMPLETE RANGE

Tectite fittings from Pegler Yorkshire makes jointing faster and more cost effective than other jointing methods - a fittings system which simply pushes together in seconds to create a perfect joint, every time.



TECTITE PUSH-FIT BENEFITS

A completely heat - free system offering the following benefits:

- ✚ Improved installation time over traditional methods
- ✚ No naked flames (improved safety)
- ✚ Perfectly clean internal bore (less finishing/cleaning required)
- ✚ No localised annealing from high temperature working
- ✚ System does not need to be "dry" for effective jointing



THE PERFECT SOLUTION ALL ROUND

A heat - free, time saving jointing method which guarantees uncontaminated installation. Ideal for applications as diverse as domestic maintenance and refurbishment, new build and large - scale public sector projects.

RENOWNED PEGLER YORKSHIRE QUALITY AND RELIABILITY

Some Tectite products offer the bonus of an enhanced 25 - year warranty. Pegler Yorkshire also operates a Quality Management System for the development, manufacture and supply of fittings, tube, valves and accessories which complies with the requirements of BS EN ISO 9001:2008.

VERSATILITY AND CHOICE

A wide range of fittings for use with many different types of materials, including copper tube, PEX and PB pipe, and a variety of steel including stainless and carbon.

Choice of demountable or non-demountable fittings.



COST-SAVING AND COST-SAVING INSTALLATION

Time saving and cost - saving installation of many types of plumbing and heating services - for commercial, domestic and public utility applications - including:

- ✚ All above - ground hot and cold domestic and commercial water services
- ✚ Heating and chilled water services (potable and non-potable)
- ✚ Low - temperature hot water and heating
- ✚ Smallbore or minibore central heating systems
- ✚ Pressurised, vented and unvented heating systems





CONNECT + CONTROL

TECTITE TUBE & TectSEAL™ 3PS

Tectite Tube is manufactured with an integrated layer of Aluminium offering unrivalled performance and a truly efficient installation. The metal element of the construction enables the pipe to retain the shape you manipulate it to, whether a 90° bend or a tight offset, Tectite Tube offer exceptional installation benefits. Combined with Tectite Classic demountable brass fittings, the system is like nothing else on your merchant shelves.



1 PE-XC

Internal and external layers enable the tubes use on a variety of applications including potable water services, heating applications and low temperature and hot water services.

2 ADHESIVE

The connecting layer binds the PE-Xc and Aluminium together resulting in a vast reduction in thermal expansion.

3 ALUMINIUM LAYER

The Aluminium layer provides Tectite Tube with its unique physical characteristics and superior performance.

4 INNER SEAL

EPDM seal angled in line with pipe insertion and pre-lubricated for ease of installation.

5 OUTER SEAL

EPDM seal angled in line with fitting insertion and pre-lubricated for ease of installation.

6 LINER

Stiff and strong Fortron PPS material ensures you make a reliable joint every time.

! NOTE: Only suitable for use with Tectite Classic fittings and TectSEAL™ 3PS. Not suitable for Irish sizes.



PERFORMANCE

- + Reduces the number of fittings used by up to 40%
- + Operating maximum of 6 bar at 95°C and 16 bar at 30°C
- + Clip only once per metre
- + 8 x less expansion than plastic systems
- + No sagging under temperature thanks to metal construction

Plastic bending radius is **8X** external diameter

TECTITE bending radius is **4X** external diameter

- + Rodent resistant metal construction
- + Mould into the tightest bends by hand



PRODUCT OVERVIEW

TECTITE CLASSIC

The original Tectite fitting and proven in the field for over 15 years, Tectite Classic can be used for applications where a demountable fitting is required.



FEATURES

- ✚ Demountable
- ✚ Available in sizes 10mm to 28mm
- ✚ Manufactured from DZR brass or gunmetal
- ✚ Can be used with Tectite flexible metal tube, copper tube, PB and PEX pipe (with liners) or chrome plated copper tube
- ✚ Suitable for use on hot and cold water services, heating applications and low temperature hot water services
- ✚ WRAS approved

TECTITE AIR

The Air range of products are designed specially to be used for pneumatic applications and are not recommended for use with fuels, spirits, explosive gases and petroleum.



FEATURES

- ✚ Specially adapted fittings to be used on compressed air systems
- ✚ Demountable and reusable
- ✚ Push-fit connections enabling quick assembly of joint
- ✚ Silicone free
- ✚ Sizes range from 15mm to 28mm
- ✚ Oil resistant NBR 'O' ring providing complete impermeability even if the air contains oil
- ✚ DZR brass body - rodent resistant
- ✚ Stainless steel grab ring with 'grab first' design removing the risk of full bore failure
- ✚ Alignment ring enables fitter to centre the pipe
- ✚ Suitable for connections to copper tube, PB pipe (with liner) and PEX pipe

DESCRIPTION	CAT. No.	SIZES (mm)	PAGE No.
Straight Coupling	T1	10 - 28	16
Reduced Coupling	T1R	10 - 28	16
Straight Female Connector	T2	10 - 28	17
Straight Male Connector	T3	10 - 28	18
Tank Connector	T5	15 - 28	19
Reducer	T6	10 - 28	19
Elbow	T12	10 - 28	20
Street Elbow	T12s	10 - 28	20
Male Elbow	T13	10 - 28	21
Female Elbow	T14	10 - 28	21
Backplate Elbow	T15	10 - 28	22
Obtuse Elbow	T21	12 - 28	22
Obtuse Street Elbow	T21s	12 - 28	22
Equal tee	T24	10 - 28	23
Tee, Reduced Branch	T25	12 - 28	23
Tee, End Reduced	T26	15 - 28	24
Tee, End and Branch Reduced	T27	15 - 28	24
Stop End	T61	10 - 28	25
Tap Connector	T62	10 - 22	25
Bent Tap Connector	T63	10 - 22	26

DESCRIPTION	CAT. No.	SIZES (mm)	PAGE No.
Straight Coupling	TD1	15 - 28	34
Straight Female Connector	TD2	15 - 28	34
Straight Male Connector	TD3	15 - 28	35
Reducer	TD6	15 - 28	35
Elbow	TD12	15 - 28	36
Male Elbow	TD13	15 - 28	36
Obtuse Elbow	TD21	15 - 28	36
Equal tee	TD24	15 - 28	37
Tee, Reduced Branch	TD25	15 - 28	37
Tee, End and Branch Reduced	TD27	22 - 28	37
Stop End	TD61	15 - 28	37

FEATURE	CLASSIC	AIR
Size Range	15mm to 28mm	15mm to 28mm
Demountable	✓	✓
Electrical Continuity	-	-
Applications	Potable Water, Heating, Hot Water, Cold Water, Gray/Rain Water	Compressed Air
Tube Compatibility	Tectite Flexible Metal, Copper, Chrome Plated Copper, PEX, PB	Copper, Chrome Plated Copper, PEX, PB
Material	DZR Brass	DZR Brass
Guarantee	25 Year	25 Year
WRAS	✓	-



CONNECT + CONTROL

TECTITE SPRINT

Tectite Sprint non-demountable fittings are ideal for fast and efficient heat free jointing, offering a visually appealing, low profile design which can be easily installed in confined spaces. They are also easy to insulate.

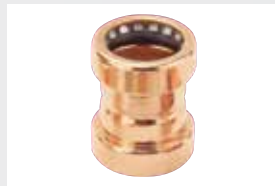

FEATURES

- + Available in sizes 10mm to 54mm
- + Manufactured from copper or machined DZR brass
- + Can be used with copper tube and PEX pipe (with liners) or chrome plated copper tube
- + Suitable for use on hot and cold water services, heating and chilled water* applications and low temperature hot water services
- + Provides electrical continuity
- + WRAS approved

*Brass adaptors not suitable for chilled water

DESCRIPTION	CAT. No.	SIZES (mm)	PAGE No.
Straight Coupling	TT1	10 - 54	38
Reduced Coupling	TT1R	14 - 22	38
Straight Female Connector	TT2	10 - 54	39
Straight Male Connector	TT3	10 - 54	39
Tank Connector	TT5	15 - 22	40
Reducer	TT6	15 - 54	40
Elbow	TT12	10 - 54	41
Street Elbow	TT12s	10 - 54	41
Male Elbow	TT13	15 - 22	42
Female Elbow	TT14	14 - 22	42
Backplate Elbow	TT15	12 - 18	42
Obtuse Elbow	TT21	12 - 54	43
Obtuse Street Elbow	TT21s	12 - 54	43
Equal tee	TT24	10 - 54	44
Tee, Reduced Branch	TT25	14 - 54	44
Tee, End Reduced	TT26	15 - 28	45
Tee, End and Branch Reduced	TT27	16 - 28	45
Stop End	TT61	10 - 28	46
Tap Connector	TT62	10 - 22	46
Bent Tap Connector	TT63	10 - 18	47
Straight Male Union	TT69	35 - 54	47

Tectite SPRINT is also available with a Chrome Plated finish.

FEATURE	SPRINT	PRO
Size Range	10mm to 54mm	15mm to 54mm
Demountable	-	✓
Electrical Continuity	✓	✓
Applications	Potable Water, Heating, Hot Water, Cold Water, Gray/Rain Water, Chilled Water	Potable Water, Heating, Hot Water, Cold Water, Gray/Rain Water
Tube Compatibility	Copper, Chrome Plated Copper, PEX, PB	Tectite Flexible Metal, Copper, Chrome Plated Copper, PEX, PB
Material	Copper or DZR Brass	DZR Brass
Guarantee	25 Year	25 Year
WRAS	✓	✓

TECTITE PRO

Tectite Pro demountable fittings have been specially developed to meet the rigorous demands of the mechanical services sector. Tectite Pro offers enhanced performance over an extended size range and is WRAS approved. 15mm to 54mm fittings feature a stainless steel grab ring.



FEATURES

- + Demountable
- + Available in sizes 15mm to 54mm
- + Manufactured from DZR brass or gunmetal
- + Provides electrical continuity
- + Can be used with copper tube, PB and PEX pipe, chrome plated copper tube or carbon steel tube
- + Designed for use in the mechanical services sector on hot and cold services, heating applications and low temperature hot water services
- + Provides enhanced performance
- + WRAS approved

DESCRIPTION	CAT. No.	SIZES (mm)	PAGE No.
Straight Coupling	TX1	15 - 54	52
Straight Female Connector	TX2	15 - 54	52
Straight Male Connector	TX3	15 - 54	53
Reducer	TX6	22 - 54	53
Elbow	TX12	15 - 54	54
Street Elbow	TX12s	15 - 28	54
Male Elbow	TX13	15 - 28	55
Female Elbow	TX14	15 - 28	55
Backplate Elbow	TX15	15	55
Obtuse Elbow	TX21	15 - 54	56
Obtuse Street Elbow	TX21s	15 - 54	56
Equal tee	TX24	15 - 54	56
Tee, Reduced Branch	TX25	22 - 54	57
Tee, End Reduced	TX26	12 - 28	57
Tee, End and Branch Reduced	TX27	12 - 28	57
Stop End	TX61	15 - 54	58
Tap Connector	TX62	15 - 22	59
Bent Tap Connector	TX63	15 - 22	59



PRODUCT OVERVIEW

TECTITE 316

Tectite 316 is a stainless steel option which has been developed for use with 316 System tube for potable water applications where water quality and hygiene are key considerations. The Tectite 316 range incorporates a stainless steel grab ring which has been specifically developed to grip stainless steel tube without the need to for it to be scribed.



FEATURES

- ✚ Demountable
- ✚ Available in sizes 15mm to 54mm
- ✚ Manufactured from 316 stainless steel
- ✚ Provides electrical continuity
- ✚ Can be used with 316 System tube
- ✚ Designed for hot and cold, chilled water applications and LTHW
- ✚ WRAS approved

TECTITE CARBON

The latest addition to Tectite, Carbon is built on tried and tested technology. It combines a robust fitting and pipe solution in Carbon Steel. Ideal for domestic and commercial sealed systems, Tectite Carbon provides professional installers with a lightweight and low profile solution.



FEATURES

- ✚ Available in sizes from 15mm to 54mm
- ✚ Manufactured from galvanised carbon steel
- ✚ Performs up to 20 bar working pressure
- ✚ Provides electrical continuity with integral earth strap
- ✚ Lightweight
- ✚ Simple to install*
- ✚ Designed for use with unvented closed circuit heating and chilled water services (closed loop)

*Versus traditional methods.

DESCRIPTION	CAT. No.	SIZES (mm)	PAGE No.
Straight Coupling	TS1	15 - 54	61
Straight Female Connector	TS2	15 - 54	62
Straight Male Connector	TS3	15 - 54	62
Reducer	TS6	18 - 54	63
Elbow	TS12	15 - 54	63
Street Elbow	TS12s	10 - 54	64
Male Elbow	TS13	15 - 28	64
Female Elbow	TS14	15 - 28	64
Backplate Elbow	TS15	15 - 22	65
Obtuse Elbow	TS21	15 - 54	66
Obtuse Street Elbow	TS21s	15 - 54	66
Equal tee	TS24	15 - 54	66
Tee, Reduced Branch	TS25	18 - 54	67
Stop End	TS61	15 - 54	68
Tap Connector	TS62	15 - 22	68

DESCRIPTION	CAT. No.	SIZES (mm)	PAGE No.
Straight Coupling	TC1	15 - 54	70
Straight Female Connector	TC2	15 - 42	70
Straight Male Connector	TC3	15 - 54	70
Reducer	TC6	18 - 54	71
Elbow	TC12	15 - 54	71
Street Elbow	TC12s	15 - 54	72
Male Elbow	TC13	15 - 22	72
Female Elbow	TC14	15 - 22	72
Obtuse Elbow	TC21	15 - 54	73
Obtuse Street Elbow	TC21s	15 - 54	73
Equal tee	TC24	15 - 54	73
Tee, Reduced Branch	TC25	18 - 54	74
Straight Male Union	TC69	15 - 54	75

FEATURE	316	CARBON
Size Range	15mm to 54mm	15mm to 54mm
Demountable	✓	-
Electrical Continuity	✓	✓
Applications	Potable Water, Heating, Hot Water, Cold Water, Gray/Rain Water, Chilled Water	Heating (Closed Unvented Systems), Chilled Water (Closed Loop)
Tube Compatibility	Stainless Steel, Carbon Steel, Tectite Flexible Metal, Copper, Chrome Plated Copper, PEX, PB	Carbon Steel
Material	316 Stainless Steel	Carbon Steel
Guarantee	25 Year	10 Year
WRAS	✓	-



CONNECT + CONTROL

TECTITE FLEXIBLE HOSE CONNECTORS

Tectite flexible hose connectors are suitable for use in areas where space is limited and the fitting of rigid tube is difficult.

FEATURES

- + Available in 15mm sizes
- + Manufactured with high quality stainless steel braided EPDM hose
- + Designed for use in hot and cold water services and on fan coils
- + WRAS approved





DOMESTIC TECTITE FLEXIBLE METAL SYSTEM

Every customer relies on you to do a good job, quickly, cleanly, cost-effectively and with no unexpected problems. You need to be sure that whatever you recommend and install today won't cause problems for you or your customers in the future. Your reputation depends on it.

Tectite Tube offers installers the flexible installation of plastic with none of the compromise, suitable for use on potable water and central heating systems where you can connect directly to the boiler.*



TectSEAL™ 3PS features patented directional seals, pre-lubricated for reduced insertion force and a reliable seal every time.



The Tectite Classic fittings provide the performance and reliability only metal can, along with an array of features to ensure your peace of mind. The range also includes chrome fittings for a decorative finish on exposed chrome pipework.

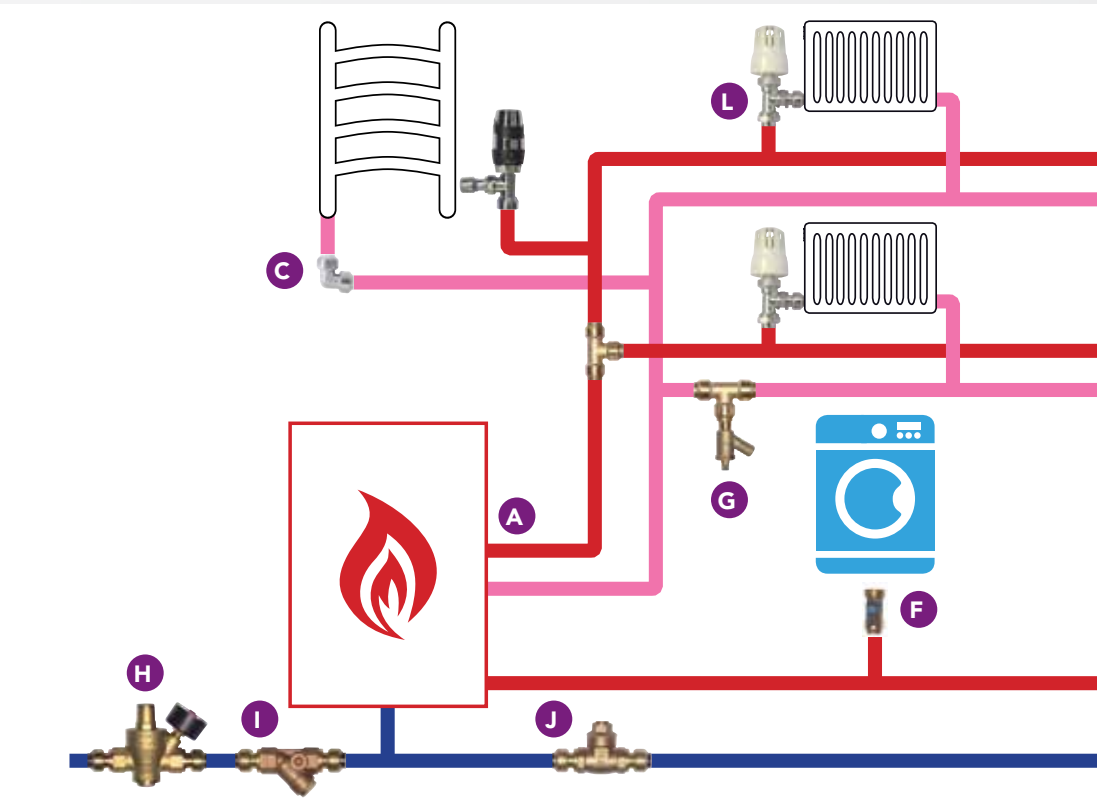

Tectite ball valves provide fast isolation of pipe work for system servicing. Its compact design is packed with innovative features like the clever locking mechanism built into the indices on the lever.



Double check valves protect the system from contamination by preventing back flow and as with the Tectite ball valve can be fitted with anti-rotation clips to secure the valve.



A range of appliance valves are available for connecting washing machines and dishwashers. The isolating valves come in straight, bent or tee patterns, all have interchangeable red and blue indices.



* Due to the Tectite Tube's metal construction and advanced TectSEAL™ 3PS there is no need for 1m of copper in some applications, connection is possible to a range of new boilers, consult the Tectite website for more guidance. Always refer to your boiler manufacturers installation instructions.



CONNECT + CONTROL

The brand new and completely unique Tectite Metal Push-Fit System available in sizes 15mm and 22mm, offers you the next evolution in domestic plumbing. At Tectite we believe in the efficiency and swift installation offered by a flexible plumbing solution, combined with the performance and reliability offered by traditional metal systems.

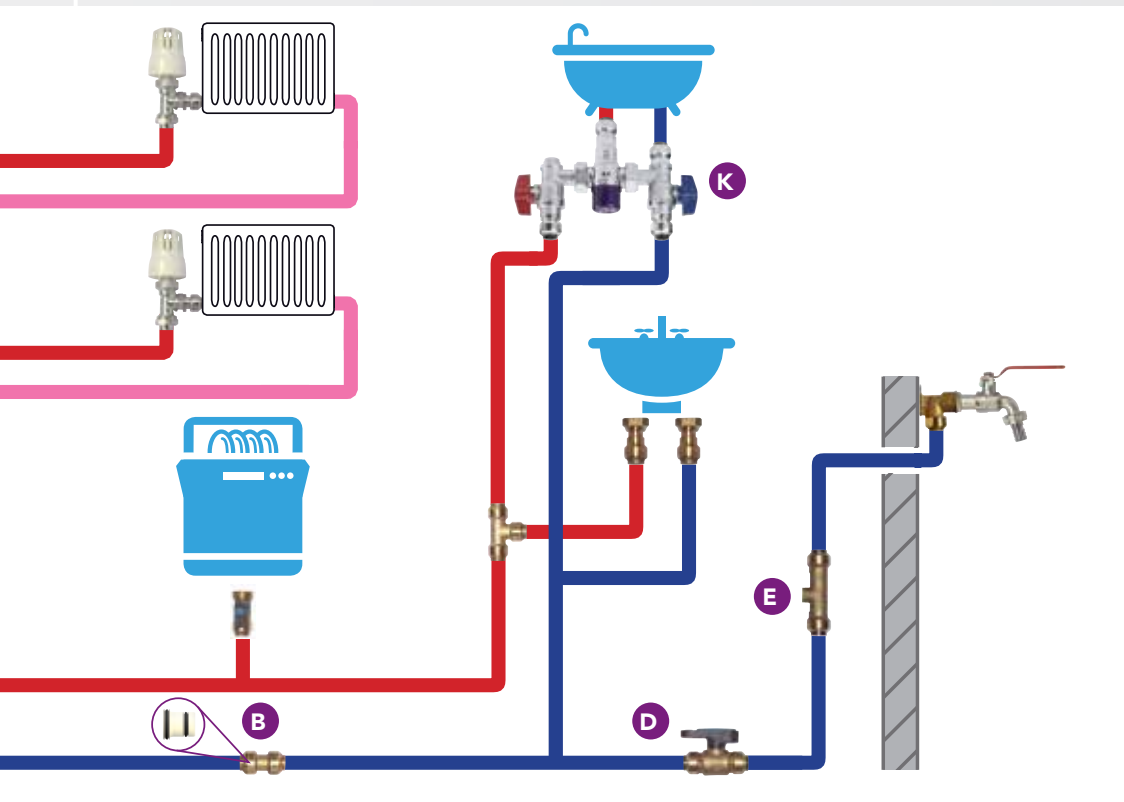

The valve range includes the Terrier thermostatic radiator valve with integrated Tectite connection. An energy efficient system upgrade with a time efficient installation.



Thermal mixing valves provide anti-scald protection and are approved to both TMV3 and TMV2 standards.



Tectite draining taps are pre scored at precisely the right depth to engage with the grab ring in Tectite fittings* for a secure joint that can be rotated out of the way when not in use.



Pressure reducing valves protect systems from potentially damaging water pressure by reducing it down to safe levels.

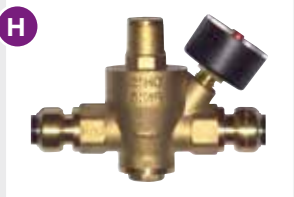

Y Strainers provide protection to equipment in pipework systems by filtering out harmful debits.



Swing check valves prevent back flow in systems.



* Tectite draining taps are only compatible with Tectite Classic, Tectite Pro and Tectite 316 Fittings.



PUSH-FIT SOLUTIONS STANDARDS, APPROVALS AND GUARANTEES

It's Pegler Yorkshire's policy to provide a range of products and services which meet, or exceed, the requirements of our customers in respect of quality, cost and delivery.

STANDARDS AND APPROVALS

WRAS All Tectite Sprint, Tectite Classic, Tectite Pro and Tectite 316 fittings are listed and comply with the requirements of the United Kingdom Water Regulations/Byelaws (Scotland).

DVGW Tectite Classic and Tectite 316 fittings have been approved by the German approval authority. They comply with DVGW Arbeitsblatt W534, which covers fittings and joints for tubes in potable water installations.

Tectite Classic fittings are also approved by **KIWA** (Dutch certification), **SITAC** (Norway, Sweden and Finland certification) and **CSTB** (French certification). Tectite 316 fittings are also approved by **SVGW** (Swiss certification).



Tectite - PEX barrier pipe is kitemark approved



The Tectite range has been certified by the WRAS and is audited periodically



Applicable Tectite products are DVGW approved for the European market



ISO is achieved through the continuous improvement of our Quality Management System in line with the requirements of BS EN ISO9001: 2000





CONNECT + CONTROL

PRODUCT APPROVALS										
Product	WRAS	CSTB	KIWA	DVGW	ETA	ACS	Sintef	Stac	SVGW	OVGW
Tectite Sprint	✓	-	-	-	-	-	✓	✓	-	-
Tectite Classic	✓	✓	✓	✓	✓	✓	-	-	-	-
Tectite Pro	✓	-	-	-	-	-	-	-	-	-
Tectite 316	✓	-	-	✓	-	-	-	-	✓	✓
Tectite Carbon	-	-	-	-	-	-	-	-	-	-

GUARANTEES

25 YEAR GUARANTEE

Where Tectite Sprint, Tectite Classic, Tectite Pro and Tectite 316 fittings, Tectite - PEX barrier pipe and 316 System tube are installed in pipelines with other products, all are guaranteed against all manufacturing defects for 25 years.

TECTITE FITTINGS, TUBE AND ACCESSORIES	GUARANTEE PERIOD (YEARS)		
	5	10	25
Fittings	-	-	✓
Fittings with XPress carbon steel System tube	-	✓	-
Carbon Fittings	✓	-	-
Carbon Fittings with XPress carbon steel System tube	-	✓	-
Tectite valves	✓	-	-
Tectite flexible hose connectors	-	✓	-

To qualify for guarantees, all products must be installed in accordance with our instructions in specified applications.





TMLCPC Tectite Flexible Metal Tube

Coil
(use with TectSEAL™)

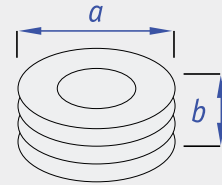

Size	Length	a	b	Code
15mm x 25m	25m	560	80	44909
15mm x 50m	50m	660	110	44910
15mm x 400m	400m	660	110	44913
22mm x 25m	25m	700	180	44911
22mm x 50m	50m	850	340	44912
22mm x 400m	400m	900	340	44914

TMLCPS Tectite Flexible Metal Tube Straight Length

Coil
(use with TectSEAL™)



Size	Code
15mm x 3m	44915
22mm x 3m	44916

TP515 Qual-Pex Pipe

Coil



Size	Code
10mm x 100m	60000
10mm x 50m	60001



**QP520
Qual-Pex Pipe**



Size	Code
15mm x 3m	60029
22mm x 3m	60037
28mm x 3m	60041

**TMLCP3PS
TectSEAL™ 3PS Liner**

For insertion into Tectite Metal Tube



Size	Code
15mm	44917
22mm	44918



T1/T270 Straight coupling

Push-fit x push-fit

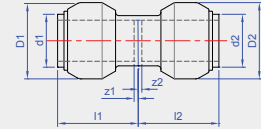

Size	d1	d2	l1	l2	D1	D2	z1	z2	Code
10mm	10	10	25	25	21	21	1	1	45108
12mm	12	12	25	25	23	23	1	1	45110
14mm	14	14	25	25	26	26	1	1	45112
15mm	15	15	25	25	26	26	1	1	45114
16mm	16	16	25	25	27	27	1	1	45116
18mm	18	18	25	25	29	29	1	1	45118
20mm	20	20	30	30	32	32	1	1	45120
22mm	22	22	30	30	34	34	1	1	45121
28mm	28	28	33	33	42	42	1	1	45123

T1R/T240 Reducing coupling

Push-fit x push-fit

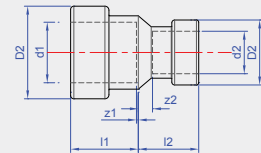

Size	d1	d2	l1	l2	D1	D2	z1	z2	Code
12 x 10mm	12	10	25	25	23	21	1	1	45155
14 x 12mm	14	12	25	25	26	23	1	1	45157
15 x 10mm	15	10	25	25	26	21	1	1	45159
15 x 12mm	15	12	25	25	26	23	1	1	45161
16 x 12mm	16	12	25	25	27	23	1	1	45163
16 x 14mm	16	14	25	25	27	26	1	1	45165
18 x 15mm	18	15	30	30	29	26	1	1	45167
20 x 18mm	20	18	30	25	32	29	1	1	45168
22 x 10mm	22	10	30	25	34	21	1	1	45170
22 x 15mm	22	15	30	25	34	26	1	1	45172
22 x 18mm	22	18	30	25	34	29	1	1	45174
28 x 22mm	28	22	33	30	42	34	1	1	45178



T1S/T270S Slip coupling

Push-fit x push-fit

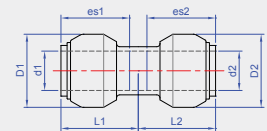

Size	d1	d2	l1	l2	D1	D2	es1	es2	Code
12mm	12	12	25	25	23	23	24	24	45140
15mm	15	15	25	25	26	26	24	24	45141
18mm	18	18	25	25	29	29	24	24	45142
22mm	22	22	30	30	34	34	29	29	45143
28mm	28	28	33	33	42	42	32	32	45144

T2/T270G Straight female connector

Push-fit x BSP parallel female thread

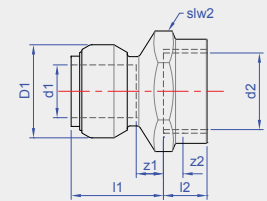

Size	d1	d2	l1	l2	D1	slw2	z1	zs2	Code
10mm x 3/8"	10	3/8"	25	14	21	22	1	1	45190
10mm x 1/2"	10	1/2"	25	16	21	25	1	3	45192
12mm x 3/8"	12	3/8"	25	14	23	22	1	3	45194
12mm x 1/2"	12	1/2"	25	16	23	25	1	3	45196
14mm x 3/8"	14	3/8"	25	14	26	22	1	3	45200
14mm x 1/2"	14	1/2"	25	16	26	25	1	3	45202
15mm x 3/8"	15	3/8"	25	14	26	22	1	3	45204
15mm x 1/2"	15	1/2"	25	16	26	25	1	3	45206
18mm x 1/2"	18	1/2"	25	16	29	25	1	3	45210
16mm x 1/2"									45209
18mm x 3/4"	18	3/4"	25	19	29	32	1	4	45212
22mm x 1/2"	22	1/2"	30	16	34	26	1	3	45220
22mm x 3/4"	22	3/4"	30	18	34	31	1	3	45222
22mm x 1"	22	1"	30	20	34	38	1	4	45223
28mm x 3/4"	28	3/4"	33	18	42	32	1	4	45224
28mm x 1"	28	1"	33	20	42	37	1	4	45225



T3P/T243G

Straight male connector

Push-fit x BSP parallel male thread

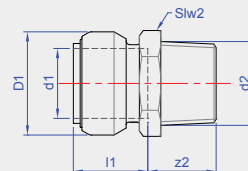

Size	d1	d2	l1	D1	slw2	z2	Code
10mm x 3/8"	10	3/8"	24	21	20	15	45250
10mm x 1/2"	10	1/2"	24	21	23	18	45252
12mm x 3/8"	12	3/8"	24	23	20	14	45254
12mm x 1/2"	12	1/2"	24	23	25	16	45256
15mm x 3/8"	15	3/8"	24	26	20	15	45265
15mm x 1/2"	15	1/2"	24	26	22	16	45267
18mm x 1/2"	18	1/2"	24	29	24	19	45286
18mm x 3/4"	18	3/4"	24	29	28	19	45288
22mm x 1/2"	22	1/2"	29	34	28	15	45290
22mm x 3/4"	22	3/4"	29	34	28	17	45292
22mm x 1"	22	1"	29	34	34	20	45294
28mm x 1"	28	1"	32	42	37	21	45296

T3T/T243G

Straight male connector

Push-fit x BSP taper male thread

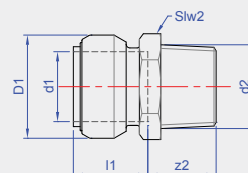

Size	d1	d2	l1	D1	slw2	z1	d3	Code
10mm x 3/8"	10	3/8"	24	21	17	16	22	45348
10mm x 1/2"	10	1/2"	24	21	21	16	27	45349
12mm x 3/8"	12	3/8"	24	23	22	13	30	45350
14mm x 3/8"	14	3/8"	24	26	22	13	30	45354
14mm x 1/2"	14	1/2"	24	26	24	13	27	45356
15mm x 1/2"	15	1/2"	24	26	24	14	32	45358
16mm x 1/2"	16	1/2"	24	27	42	23	27	45362
18mm x 1/2"	18	1/2"	24	29	23	15	27	45367
18mm x 3/4"	18	3/4"	24	29	28	19	35	45369
22mm x 1/2"	22	1/2"	29	34	24	14	32	45364
22mm x 3/4"	22	3/4"	29	34	26	14	32	45366
22mm x 1"	22	1"	29	34	28	15	35	45368
28mm x 1"	28	1"	32	42	28	16	42	45370



T5 Tank connector

Push-fit x BSP parallel male thread with back nut

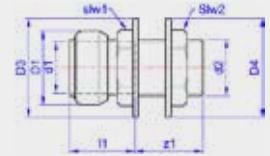

Size	d1	d2	l1	D1	slw1	slw2	z1	D3	D4	Code
15mm x 1/2"	15	1/2"	24	26	22	26	25	35	30	45390
22mm x 3/4"	22	3/4"	29	34	28	30	24	42	44	45394
28mm x 1"	28	1"	32	42	32	38	24	32	50	45396

T6/T243 Reducer

Larger end male for insertion into fitting x push-fit

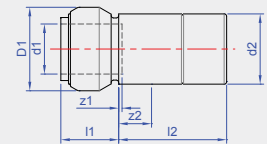

Size	d1	d2	l1	l2	D1	z1	z2	Code
12 x 10mm	10	12	24	21	21	0	3	45410
15 x 10mm	10	15	22	26	21	2	2	45416
15 x 12mm	12	15	24	22	23	0	2	45418
18 x 15mm	15	18	24	22	26	3	0	45424
22 x 12mm	12	22	22	30	23	2	1	45425
22 x 15mm	15	22	22	30	26	2	1	45426
22 x 18mm	18	22	22	30	29	2	1	45430
28 x 15mm	15	28	22	33	26	2	1	45435
28 x 18mm	18	28	22	33	29	2	1	45437
28 x 22mm	22	28	23	33	34	6	1	45438



T12/T090

Elbow

Push-fit x push-fit

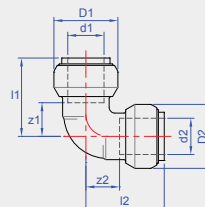

Size	d1	d2	l1	l2	D1	D2	z1	z2	Code
10mm	10	10	30	30	21	21	6	6	45510
12mm	12	12	31	31	23	23	7	7	45512
14mm	14	14	33	33	26	26	9	9	45514
15mm	15	15	33	33	26	26	9	9	45516
16mm	16	16	33	33	27	27	9	9	45518
18mm	18	18	34	34	29	29	10	10	45520
20mm	20	20	40	40	32	32	12	12	45522
22mm	22	22	40	40	34	34	12	12	45524
28mm	28	28	49	49	42	42	17	17	45526

T12S/T092

Street elbow

Push-fit x male end for insertion into fitting

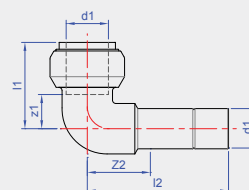

Size	d1	d2	l1	l2	D1	z1	z2	Code
10mm	10	10	30	42	21	6	18	45490
12mm	12	12	31	42	23	7	19	45492
10 x 15mm	10	15	32	42	26	8	18	45494
15mm	15	15	33	44	26	9	20	45496
18mm	18	18	34	48	29	10	28	45498
22mm	22	22	40	48	34	12	19	45500
28mm	28	28	49	57	42	17	25	45502

T12SNP/T092

Street elbow

Push-fit x male end for insertion into fitting. Nickel plated finish

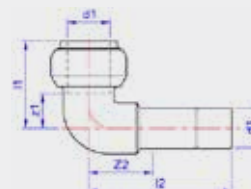

Size	d1	d2	l1	l2	D1	z1	z2	Code
10mm	10	10	30	42	21	6	18	45491
10 x 15mm	10	15	32	42	26	8	18	45495
15mm	15	15	33	44	26	9	20	45497



T13/T092G Male elbow

Push-fit x BSP taper male thread

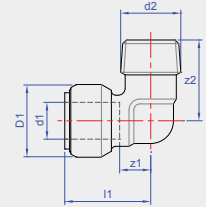

Size	d1	d2	l1	D1	z1	z2	Code
10mm x 3/8"	10	3/8"	30	21	6	24	45550
10mm x 1/2"	10	1/2"	30	21	6	29	45552
12mm x 3/8"	12	3/8"	32	23	7	24	45554
12mm x 1/2"	12	1/2"	33	23	7	29	45556
14mm x 1/2"	14	1/2"	33	26	9	29	45560
15mm x 1/2"	15	1/2"	33	26	9	29	45561
16mm x 1/2"	16	1/2"	34	27	10	29	45563
16mm x 3/4"	16	3/4"	36	27	13	36	45564
18mm x 1/2"	18	1/2"	33	29	10	29	45569
18mm x 3/4"	18	3/4"	34	29	10	36	45570
22mm x 3/4"	22	3/4"	41	34	12	34	45576
28mm x 1"	28	1"	49	42	17	42	45578

T14/T090G Female elbow

Push-fit x BSP parallel female thread

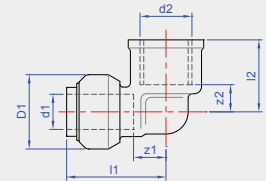

Size	d1	d2	l1	l2	D1	z1	z2	Code
10mm x 3/8"	10	3/8"	34	23	21	10	13	45590
10mm x 1/2"	10	1/2"	34	23	21	10	11	45592
12mm x 3/8"	12	3/8"	34	24	23	10	13	45594
12mm x 1/2"	12	1/2"	34	25	23	10	11	45596
14mm x 1/2"	14	1/2"	34	25	26	10	11	45600
15mm x 1/2"	15	1/2"	34	25	26	10	11	45606
16mm x 1/2"	16	1/2"	34	25	27	9	12	45608
16mm x 3/4"	16	3/4"	39	32	27	16	14	45609
18mm x 1/2"	18	1/2"	36	25	29	12	11	45614
18mm x 3/4"	18	3/4"	40	33	29	16	18	45615
22mm x 3/4"	22	3/4"	42	33	34	13	18	45620
28mm x 1"	28	1"	49	37	42	17	21	45622



T15/T471G

Backplate elbow

Push-fit x BSP parallel female thread

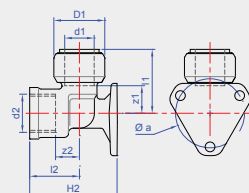

Size	d1	d2	l1	l2	H2	a	D1	z1	z2	Code
12mm x 1/2"	12	1/2"	34	25	44	35	23	10	13	45638
14mm x 1/2"	14	1/2"	35	25	44	35	26	10	13	45640
15mm x 1/2"	15	1/2"	35	25	44	35	26	10	13	45646
16mm x 1/2"	16	1/2"	35	25	44	35	27	11	13	45648
18mm x 1/2"	18	1/2"	34	25	44	35	29	11	13	45650
18mm x 3/4"	18	3/4"	40	32	51	35	29	15	16	45652
22mm x 3/4"	22	3/4"	40	32	53	35	34	11	18	45654

T21/T041

45° Obtuse elbow

Push-fit x push-fit

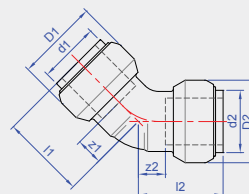

Size	d1	d2	l1	l2	D1	D2	z1	z2	Code
12mm	12	12	29	29	23	23	5	5	45531
15mm	15	15	29	29	26	26	5	5	45535
18mm	18	18	29	29	29	29	5	5	45537
22mm	22	22	35	35	34	34	6	6	45538
28mm	28	28	40	40	42	42	8	8	45539

T21S/T040

45° Obtuse street elbow

Push-fit x male end for insertion into fitting

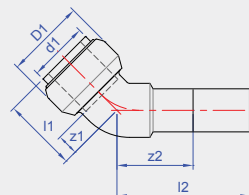

Size	d1	d2	l1	l2	D1	z1	z2	Code
12mm	12	12	29	36	23	5	12	45528
15mm	15	15	29	36	26	5	13	45542
18mm	18	18	29	37	29	5	13	45544
22mm	22	22	35	42	34	6	13	45545
28mm	28	28	40	47	42	8	15	45546



T24/T130 Equal tee

Push-fit on all ends

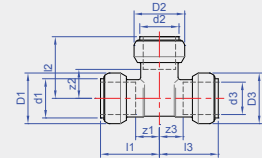
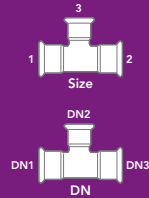

Size	d1	d2	d3	l1	l2	l3	D1	D2	D3	z1	z2	z3	Code
10mm	10	10	10	30	30	30	21	21	21	6	6	6	45660
12mm	12	12	12	31	31	31	23	23	23	7	7	7	45662
14mm	14	14	14	33	33	33	26	26	26	9	9	9	45664
15mm	15	15	15	33	33	33	26	26	26	9	9	9	45666
16mm	16	16	16	34	34	34	27	27	27	10	10	10	45668
18mm	18	18	18	34	34	34	29	29	29	10	10	10	45670
20mm	20	20	20	41	41	41	32	32	32	12	12	12	45674
22mm	22	22	22	41	41	41	34	34	34	12	12	12	45676
28mm	28	28	28	49	49	49	42	42	42	17	17	17	45678

T25/T130 Tee, reduced branch

Push-fit on all ends

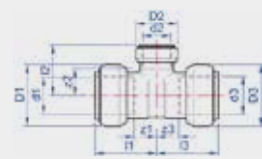
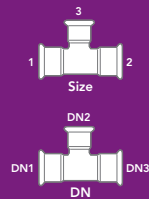

Size	d1	d2	d3	l1	l2	l3	D1	D2	D3	z1	z2	z3	Code
12 x 12 x 10mm	12	10	12	30	32	30	23	21	23	6	8	6	45700
14 x 14 x 12mm	14	12	14	31	33	31	26	23	26	7	9	7	45710
15 x 15 x 10mm	15	10	15	30	32	30	26	21	26	6	8	6	45715
15 x 15 x 12mm	15	12	15	32	33	32	26	23	26	8	9	8	45717
16 x 16 x 12mm	16	12	16	33	33	33	27	23	27	9	9	9	45719
16 x 16 x 14mm	16	14	16	34	34	34	27	26	27	10	10	10	45722
18 x 18 x 14mm	18	14	18	34	35	34	29	26	29	10	11	10	45724
20 x 20 x 16mm	20	16	20	38	36	38	32	27	32	9	12	9	45726
22 x 22 x 10mm	22	10	22	35	38	35	34	21	34	6	14	6	45730
22 x 22 x 14mm	22	14	22	38	38	38	34	23	34	9	14	9	45736
22 x 22 x 15mm	22	15	22	38	38	38	34	26	34	9	14	9	45737
22 x 22 x 16mm	22	16	22	38	38	38	34	27	34	9	14	9	45739
22 x 22 x 18mm	22	18	22	39	36	39	34	29	34	10	12	10	45742
28 x 28 x 15mm	28	15	28	42	40	42	42	26	42	10	16	10	45744
28 x 28 x 18mm	28	18	28	44	39	44	42	29	42	12	15	12	45745
28 x 28 x 22mm	28	22	28	46	44	46	42	34	42	14	15	14	45746



T26/T130 Tee, one end reduced

Push-fit on all ends

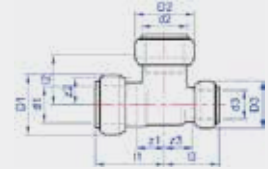
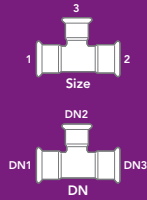

Size	d1	d2	d3	l1	l2	l3	D1	D2	D3	z1	z2	z3	Code
15 x 10 x 15mm	15	15	10	34	34	31	26	26	21	10	10	9	45780
22 x 15 x 22mm	22	22	15	41	41	37	34	34	26	12	12	13	45786
22 x 18 x 22mm	22	22	18	41	41	37	34	34	29	12	12	13	45788
28 x 15 x 28mm	28	28	15	48	48	40	42	42	26	16	16	16	45790
28 x 18 x 28mm	28	28	18	48	48	40	42	42	29	16	16	16	45792
28 x 22 x 28mm	28	28	22	49	48	44	42	42	34	17	16	15	45793

T27/T130 Tee, one end and branch reduced

Push-fit on all ends

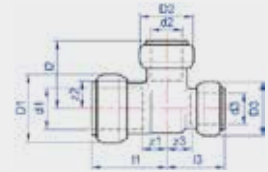
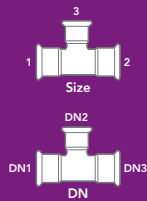

Size	d1	d2	d3	l1	l2	l3	D1	D2	D3	z1	z2	z3	Code
15 x 10 x 10mm	15	10	10	30	32	33	26	21	21	6	8	9	45810
15 x 12 x 12mm	15	12	12	29	33	32	26	23	23	5	9	8	45812
16 x 14 x 14mm	16	14	14	34	33	32	27	26	26	10	9	8	45815
22 x 15 x 15mm	22	15	15	37	36	31	34	26	26	8	12	7	45820
22 x 18 x 18mm	22	18	18	38	36	35	34	29	29	9	12	11	45819
28 x 18 x 18mm	28	18	18	45	41	35	42	29	29	13	17	11	45821
28 x 22 x 22mm	28	22	22	46	44	44	42	34	34	13	15	15	45822

T30/T130G Female branch tee

Push-fit on all ends x BSP parallel female branch

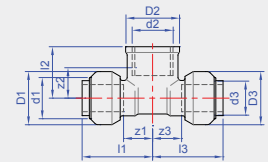
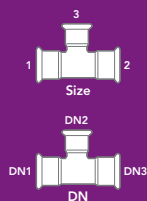

Size	d1	d2	d3	l1	l2	l3	D1	D2	D3	z1	z2	z3	Code
12 x 12mm x 1/2"	12	1/2"	12	35	24	35	23	27	23	11	8	11	45823
15 x 15mm x 1/2"	15	1/2"	15	35	25	35	26	27	26	11	12	11	45840
16 x 16mm x 1/2"	16	1/2"	16	36	25	36	27	27	27	12	13	12	45825
22 x 22mm x 1/2"	22	1/2"	22	39	27	39	34	27	34	10	14	10	45845
22 x 22mm x 3/4"	22	3/4"	22	41	30	41	34	34	34	12	12	12	45846



T61/T301 Stop end

Push-fit ends for use on tube

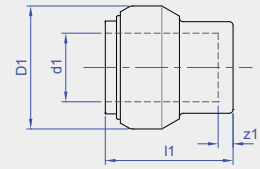

Size	d1	l1	D1	D2	z1	Code
10mm	10	26	21	21	2	45860
12mm	12	26	23	23	2	45862
14mm	14	26	26	26	2	45864
15mm	15	26	26	26	2	45866
16mm	16	26	27	27	2	45868
18mm	18	26	29	29	2	45870
20mm	20	31	32	32	2	45872
22mm	22	31	34	34	2	45874
28mm	28	34	42	42	2	45876

T61RV/T302 Air release stop end

Push-fit x air release valve

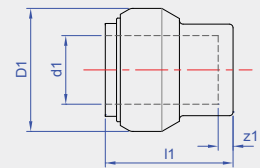

Size	d1	l1	D1	D2	z1	Code
10mm	10	34	21	21	10	45890
12mm	12	34	23	23	10	45891
15mm	15	34	26	26	10	45892
18mm	18	34	29	29	10	45893
22mm	22	39	34	34	10	45894
28mm	28	42	42	42	10	45895

T62/T062 Tap connector

Push-fit x BSP union nut.
Spigot and washer joint

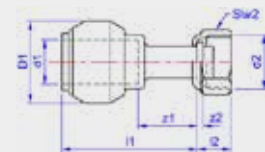

Size	d1	d2	l1	l2	D1	slw2	z1	z2	Code
10mm x 1/2"	10	1/2"	33	13	21	24	9	2	45900
15mm x 1/2"	15	1/2"	36	13	26	24	13	2	45902
15mm x 3/4"	15	3/4"	35	13	26	31	11	2	45171
22mm x 3/4"	22	3/4"	46	13	34	31	17	2	45903



T62S

Tap connector

Male end for insertion into fitting x BSP union nut. Spigot and washer joint. Supplied with copper tail

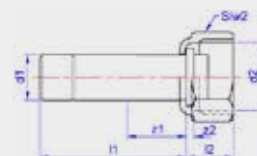

Size	d1	d2	l1	l2	slw2	z1	z2	Code
15mm x 1/2"	15	1/2"	27	12	24	3	2	45910
15mm x 3/4"	15	3/4"	36	12	31	12	2	45912
22mm x 3/4"	22	3/4"	36	12	31	7	2	45914

T63/T063

Bent tap connector

Push-fit x BSP union nut. Spigot and washer joint

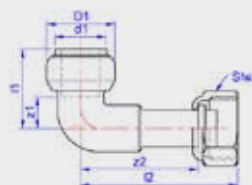

Size	d1	d2	l1	l2	D1	slw2	z1	z2	Code
10mm x 1/2"	10	1/2"	33	47	21	24	9	35	45920
15mm x 1/2"	15	1/2"	33	47	26	24	9	39	45922
15mm x 3/4"	15	3/4"	31	45	26	31	9	35	45923
22mm x 3/4"	22	3/4"	42	52	34	31	18	40	45924

T68FF

Flat faced union adaptor

Push-fit x BSP union nut. Suitable for use with water meters

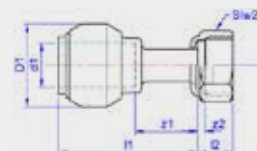

Size	d1	d2	l1	l2	slw2	z1	z2	Code
15mm x 3/4"	15	3/4"	32	13	31	8	2	40759

Bib Tap Kit

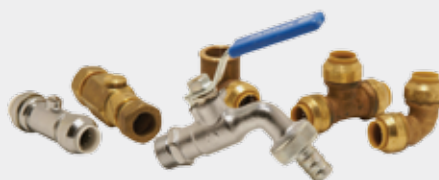

Code

45070

TECTITE CLASSIC FITTINGS



TX68S Cylinder union

Male end for insertion into fitting x BSP union nut

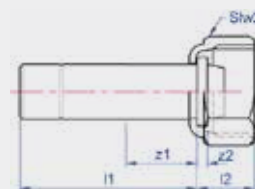

Size	d1	d2	l1	l2	slw2	z1	z2	Code
22mm x 1"	22	1"	37	15	31	8	3	65930

Tectite Classic Flexifit

TF90 Flexible connector

Push-fit x push-fit 300mm long



Size	a	Code
15mm	300mm	45983
22mm	400mm	45984

TF92 Flexible tap connector

Push-fit x BSP parallel female thread. Spigot and washer joint 300mm long



Size	a	Code
15mm x 1/2"	300mm	45985
22mm x 3/4"	400mm	45986



Tectite Classic Manifolds

TM80 Manifold

Push-fit x male end for insertion into fitting x push-fit outlet

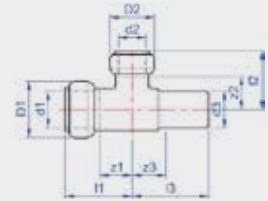

Size	d1	d2	d3	l1	l2	l3	D1	D2	z1	z2	z3	Code
22 x 22 x 10mm	22	10	22	36	39	40	35	21	7	15	11	45940

TM81 Manifold

Push-fit x male end for insertion into fitting x 2 push-fit outlets

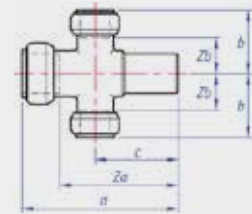

Size	d1	d2	d3	d4	l1	l2	l3	l4	D1	D2	D3	z1	z3	z4	Code
22 x 22 x 10 x 10mm	22	10	10	22	76	40	39	39	21	35	21	47	15	15	45942

2.0 PRODUCT DETAILS

TECTITE CLASSIC CHROME



T1CP/T240 Reducing coupling

Push-fit x push-fit

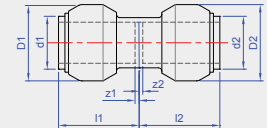

Size	d1	d2	l1	l2	D1	D2	z1	z2	Code
10mm	12	10	25	25	23	21	1	1	45109
12mm	15	10	25	25	26	21	1	1	45111
15mm	15	12	25	25	26	23	1	1	45115

T1RCP/T240 Reducing coupling

Push-fit x push-fit

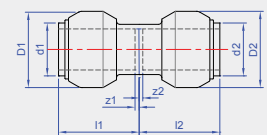

Size	d1	d2	l1	l2	D1	D2	z1	z2	Code
12 x 10mm	10	10	25	25	21	21	1	1	45156
15 x 10mm	12	12	25	25	23	23	1	1	45160
15 x 12mm	15	15	25	25	26	26	1	1	45162

T2CP/T270G Straight female connector

Push-fit x BSP parallel female thread

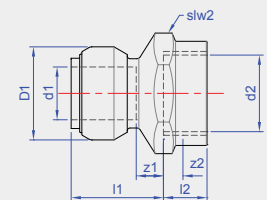

Size	d1	d2	l1	l2	D1	D2	z1	z2	Code
10mm x 3/8"	10	3/8"	25	14	21	22	1	1	45191
10mm x 1/2"	10	1/2"	25	16	21	25	1	3	45193
12mm x 3/8"	12	3/8"	25	14	23	22	1	3	45195
12mm x 1/2"	12	1/2"	25	16	23	25	1	3	45197
15mm x 3/8"	15	3/8"	25	14	26	22	1	3	45205
15mm x 1/2"	15	1/2"	25	16	26	25	1	3	45207



T3TCP/T243G

Straight male connector

Push-fit x BSP taper male thread

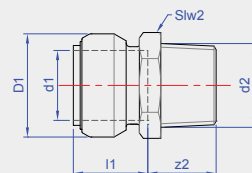

Size	d1	d2	l1	D1	slw2	z2	Code
0mm x 3/8"	10	3/8"	24	21	22	15	45251
10mm x 1/2"	10	1/2"	24	21	23	18	45253
12mm x 3/8"	12	3/8"	24	23	20	14	45255
12mm x 1/2"	12	1/2"	24	23	25	16	45257
15mm x 3/8"	15	3/8"	24	26	20	15	45266
15mm x 1/2"	15	1/2"	24	26	22	16	45268

T6CP/T243

Reducer

Larger end male for insertion into fitting x push-fit

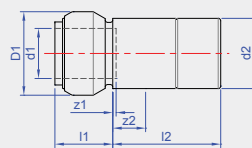

Size	d1	d2	l1	l2	D1	z1	z2	Code
12 x 10mm	10	12	24	21	21	0	3	45411
15 x 10mm	10	15	22	26	21	2	2	45417
15 x 12mm	12	15	24	22	23	0	2	45419

T12CP/T090

Elbow

Push fit x push-fit

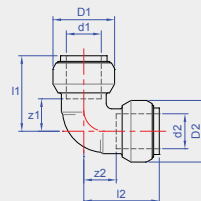

Size	d1	d2	l1	l2	D1	D2	z1	z2	Code
10mm	10	10	30	30	21	21	6	6	45511
12mm	12	12	31	31	23	23	7	7	45513
15mm	15	15	33	33	26	26	9	9	45517



T12SCP/T092 Street elbow

Push-fit x male end
for insertion into fitting

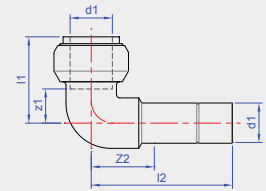

Size	d1	d2	l1	l2	D1	z1	z2	Code
15 x 12mm	15	12	32	43	23	8	19	45493

T13CP/T092G Male elbow

Push-fit x BSP taper male thread

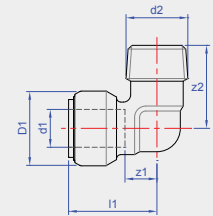

Size	d1	d2	l1	l2	D1	z1	z2	Code
10mm x 3/8"	10	3/8"	30	21	6	24	45551	
10mm x 1/2"	10	1/2"	30	21	6	29	45553	
12mm x 3/8"	12	3/8"	32	23	7	24	45555	
12mm x 1/2"	12	1/2"	33	23	7	29	45557	
15mm x 1/2"	15	1/2"	33	26	9	29	45562	

T14CP/T090G Female elbow

Push-fit x BSP parallel female thread

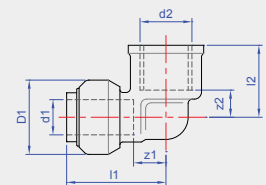

Size	d1	d2	l1	l2	D1	z1	z2	Code
10mm x 3/8"	10	3/8"	34	23	21	10	13	45591
10mm x 1/2"	10	1/2"	34	23	21	10	11	45593
12mm x 3/8"	12	3/8"	34	24	23	10	13	45595
12mm x 1/2"	12	1/2"	34	25	23	10	11	45597
15mm x 1/2"	15	1/2"	34	25	26	10	11	45607



T15CP/T471G Backplate elbow

Push-fit x BSP parallel female thread

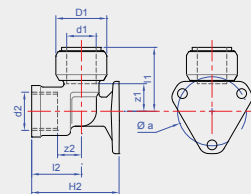

Size	d1	d2	l1	l2	H2	a	D1	z1	z2	Code
10mm x 1/2"	10	1/2"	34	25	44	35	21	10	13	45631
12mm x 1/2"	12	1/2"	34	25	44	35	23	10	13	45639
15mm x 1/2"	15	1/2"	35	25	44	35	26	10	13	45647

T24CP/T130 Equal tee

Push-fit on all ends

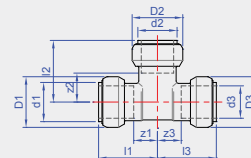

Size	d1	d2	d3	l1	l2	l3	D1	D2	D3	z1	z2	z3	Code
10mm	10	10	10	30	30	30	21	21	21	6	6	6	45661
12mm	12	12	12	31	31	31	23	23	23	7	7	7	45663
15mm	15	15	15	33	33	33	26	26	26	9	9	9	45667

T25CP/T130 Tee, reduced branch

Push-fit on all ends

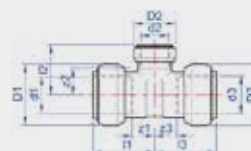
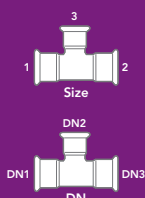

Size	d1	d2	d3	l1	l2	l3	D1	D2	D3	z1	z2	z3	Code
12 x 12 x 10mm	12	10	12	30	32	30	30	21	30	6	8	6	45701
15 x 15 x 10mm	15	10	15	30	32	30	30	21	30	6	8	6	45716
15 x 15 x 12mm	15	12	15	32	33	32	32	23	32	8	9	8	45718

T27CP/T130 Tee, one end and branch reduced

Push-fit on all ends

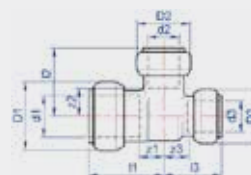
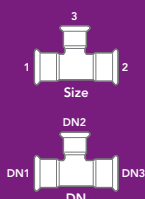

Size	d1	d2	d3	l1	l2	l3	D1	D2	D3	z1	z2	z3	Code
12 x 12 x 12mm	15	12	12	29	33	32	26	23	23	5	9	8	45813



T30CP/T130G Female branch tee

Push-fit ends x BSP parallel female branch

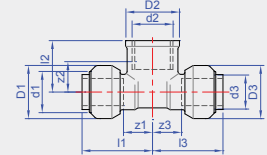
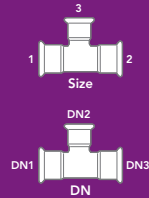

Size	d1	d2	d3	l1	l2	l3	D1	D2	D3	z1	z2	z3	Code
15 x 15 x 1/2"	15	1/2"	15	35	25	35	26		26	11	12	11	45841

T61CP/T301 Stop end

Push-fit end for use on tube

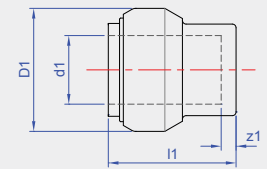

Size	d1	l1	D1	D2	z1	Code
10mm	10	26	21	21	2	45861
15mm	15	26	26	26	2	45867



TD1/T270 Straight coupling

Push-fit x push-fit

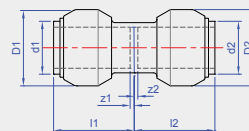

Size	d1	d2	l1	l2	D1	D2	z1	z2	Code
15mm	15	15	25	25	26	26	1	1	45114
18mm	18	18	25	25	29	29	1	1	45118
22mm	22	22	30	30	34	34	1	1	45121
28mm	28	28	33	33	42	42	1	1	45123

TD1S/T270S Slip coupling

Push-fit x push-fit

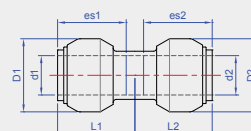

Size	d1	d2	l1	l2	D1	D2	es1	es2	Code
15mm	15	15	25	25	26	26	24	24	45141
22mm	22	22	30	30	34	34	29	29	45143
28mm	28	28	33	33	42	42	32	32	45144

TD2/T270G Straight female connector

Push-fit x BSP parallel female thread

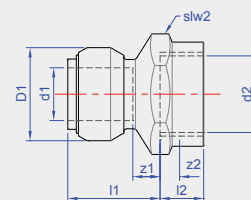

Size	d1	d2	l1	l2	D1	slw2	z1	z2	Code
15mm x 1/2"	15	1/2"	25	16	26	25	1	3	45206
18mm x 1/2"	18	1/2"	25	16	29	25	1	3	45210
18mm x 3/4"	18	3/4"	25	19	29	32	1	4	45211
22mm x 1/2"	22	1/2"	30	16	34	26	1	3	45212
22mm x 3/4"	22	3/4"	30	18	34	31	1	3	45222
22mm x 1"	22	1"	30	20	34	38	1	4	45223
28mm x 1"	28	1"	33	20	42	37	1	4	45225



TD3P Straight male connector

Push-fit x BSP parallel male thread

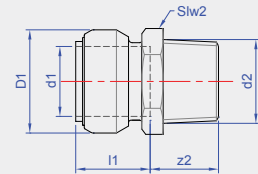

Size	d1	d2	l1	D1	slw2	z2	Code
15mm x 1/2"	15	1/2"	24	26	22	16	45358
18mm x 1/2"	18	1/2"	24	29	24	19	45367
18mm x 3/4"	18	3/4"	24	29	28	19	45369
22mm x 1/2"	22	1/2"	29	34	28	15	45365
22mm x 3/4"	22	3/4"	29	34	28	17	45366
28mm x 1"	28	1"	32	42	37	21	45370

TD3T/T243G Straight male connector

Push-fit x BSP taper male thread

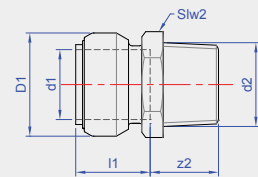

Size	d1	d2	l1	D1	slw2	z1	d3	Code
22mm x 1"	22	1"	29	34	28	15	35	45294

TD6/T243 Reducer

Larger end male for insertion into fitting x push-fit

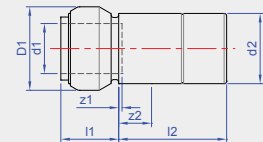

Size	d1	d2	l1	l2	D1	z1	z2	Code
22 x 15mm	15	22	22	30	26	2	1	45426
22 x 18mm	18	22	22	30	29	2	1	45427
28 x 18mm	18	28	22	33	29	2	1	45437
28 x 22mm	22	28	23	33	34	6	1	45438



TD12/T090

Elbow

Push-fit x push-fit

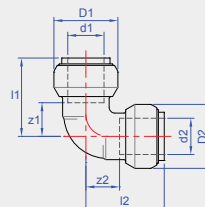

Size	d1	d2	l1	l2	D1	D2	z1	z2	Code
15mm	15	15	33	33	26	26	9	9	45516
18mm	18	18	34	34	29	29	10	10	45520
22mm	22	22	40	40	34	34	12	12	45524
28mm	28	28	49	49	42	42	17	17	45526

TD13/T092G

Male elbow

Push-fit x BSP taper male thread

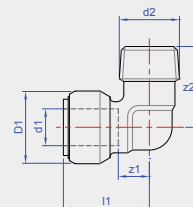

Size	d1	d2	l1	D1	z1	z2	Code
15mm x 1/2"	15	1/2"	33	26	9	29	45561
18mm x 1/2"	18	1/2"	33	29	10	29	45569
22mm x 3/4"	22	3/4"	41	34	12	34	45576
28mm x 1"	28	1"	49	42	17	42	45578

TD21/T041

45° Obtuse elbow

Push-fit x push-fit

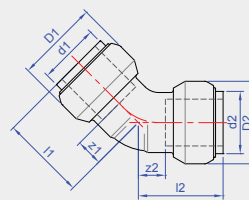

Size	d1	d2	l1	l2	D1	D2	z1	z2	Code
15mm	15	15	29	29	26	26	5	5	45535
18mm	18	18	29	29	29	29	5	5	45537
22mm	22	22	35	35	34	34	6	6	45538
28mm	28	28	40	40	42	42	8	8	45539



TD24/T130 Equal tee

Push-fit on all ends

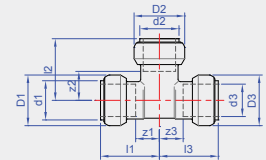
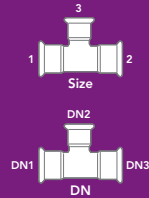

Size	d1	d2	d3	l1	l2	l3	D1	D2	D3	z1	z2	z3	Code
15mm	15	15	15	33	33	33	26	26	26	9	9	9	45666
18mm	18	18	18	34	34	34	29	29	29	10	10	10	45670
22mm	22	22	22	41	41	41	34	34	34	12	12	12	45676
28mm	28	28	28	49	49	49	42	42	42	17	17	17	45678

TD25/T130 Tee, reduced branch

Push-fit on all ends

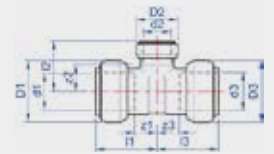
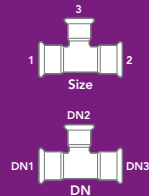

Size	d1	d2	d3	l1	l2	l3	D1	D2	D3	z1	z2	z3	Code
22 x 22 x 15mm	22	15	22	38	38	38	34	26	34	9	14	9	45737
22 x 22 x 18mm	22	18	22	39	36	39	34	29	34	10	12	10	45742
28 x 28 x 18mm	28	18	28	44	39	44	42	29	42	12	15	12	45745
28 x 28 x 22mm	28	22	28	46	44	46	42	34	42	14	15	14	45746

T27/T130 Tee, one end and branch reduced

Push-fit on all ends

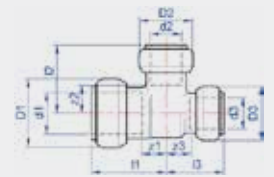
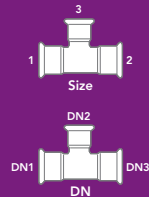

Size	d1	d2	d3	l1	l2	l3	D1	D2	D3	z1	z2	z3	Code
28 x 22 x 22mm	28	22	22	46	44	44	42	34	34	13	15	15	45822

TD61/T301 Stop end

Push-fit ends for use on tube

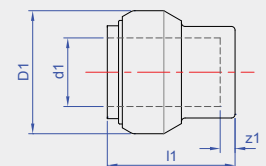

Size	d1	l1	D1	D2	z1	Code
15mm	15	26	26	26	2	45866
18mm	18	26	29	29	2	45870
22mm	22	31	34	34	2	45874
28mm	28	34	42	42	2	45876



TT1/TT270 Straight coupling

Push-fit x push-fit

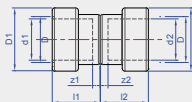

Sizes 10 - 28mm

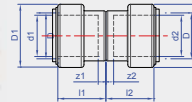

Sizes 35 - 54mm

Size	d1	d2	l1	l2	D1	slw2	z1	z2	Code
10mm	10	10	17	17	16	16	1	1	75500
12mm	12	12	18	18	18	18	1	1	75660
14mm	14	14	19	19	20	20	2	2	75661
15mm	15	15	17	17	22	22	1	1	75501
16mm	16	16	20	20	23	23	3	3	75662
18mm	18	18	17	17	25	25	1	1	75663
22mm	22	22	19	19	30	30	1	1	75502
28mm	28	28	21	21	36	36	1	1	75503
35mm	35	35	43	43	47	47	3	3	75900
42mm	42	42	46	46	55	55	4	4	75901
54mm	54	54	49	49	67	67	4	4	75902

TT1R/TT240 Reducing coupling

Push-fit x push-fit

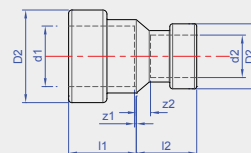

Size	d1	d2	l1	l2	D1	slw2	z1	z2	Code
14 x 12mm	14	12	20	18	20	18	1	1	75664
15 x 10mm	15	10	17	23	22	16	1	7	75504
15 x 12mm	15	12	18	23	22	18	1	6	75665
16 x 12mm	16	12	18	23	23	18	1	6	75666
16 x 14mm	16	14	17	16	23	20	1	1	75667
18 x 15mm	18	15	18	20	25	22	1	4	75668
18 x 16mm	18	16	18	16	25	23	1	0	75669
22 x 15mm	22	15	19	26	30	22	1	10	75505
22 x 16mm	22	16	18	27	30	23	0	9	75670
22 x 18mm	22	18	19	24	30	25	1	6	75671



TT2/TT270G

Straight female connector

Push-fit x BSP parallel female thread

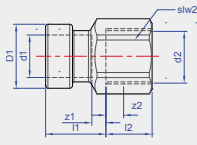

Sizes 10 - 28mm

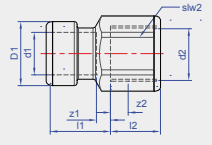

Sizes 35 - 54mm

Size	d1	d2	l1	l2	D1	slw2	z1	z2	Code
10mm x 1/2"	10	1/2"	20	15	16	25	5	3	75672
12mm x 1/2"	12	1/2"	21	15	18	25	4	3	75673
14mm x 3/8"	14	3/8"	20	13	20	20	6	3	75674
14mm x 1/2"	14	1/2"	20	13	20	25	4	3	75675
15mm x 1/2"	15	1/2"	17	15	22	25	1	3	75510
16mm x 1/2"	16	1/2"	21	15	23	25	4	3	75676
18mm x 1/2"	18	1/2"	23	15	25	25	4	3	75677
18mm x 3/4"	18	3/4"	20	17	25	32	1	4	75835
22mm x 3/4"	22	3/4"	36	17	30	30	1	3	75511
28mm x 1"	28	1"	20	21	36	38	2	4	75678
35mm x 1.1/4	35	1.1/4"	47	25	46	48	8	6	75903
42mm x 1.1/2	42	1.1/2"	47	25	54	55	6	6	75904
54mm x 2	54	2"	49	26	67	65	6	6	75905

TT3/TT243G

Straight male connector

Push-fit x BSP taper male thread

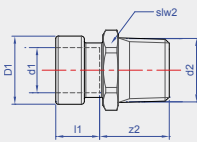

Sizes 10 - 28mm

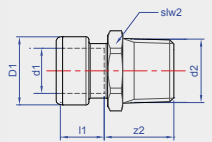

Sizes 35 - 54mm

Size	d1	d2	l1	D1	slw2	z2	Code
10mm x 3/8"	10	3/8"	15	16	22	17	75679
10mm x 1/2"	10	1/2"	15	16	22	20	75680
12mm x 3/8"	12	3/8"	16	18	22	17	75681
12mm x 1/2"	12	1/2"	16	19	25	19	75682
14mm x 3/8"	14	3/8"	16	20	22	17	75683
14mm x 1/2"	14	1/2"	16	20	22	17	75684
15mm x 1/2"	15	1/2"	16	22	21	20	75515
16mm x 1/2"	16	1/2"	15	23	22	19	75685
18mm x 3/4"	18	3/4"	17	25	27	23	75687
22mm x 3/4"	22	3/4"	16	30	26	23	75516
28mm x 1"	28	1"	18	37	32	21	75518
35mm x 1.1/4	35	1.1/4"	39	46	46	29	75906
42mm x 1.1/2	42	1.1/2"	42	54	55	29	75907
54mm x 2	54	2"	45	67	70	34	75908



TT5 Tank connector

Push-fit x BSP taper male thread with back nut

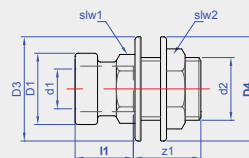

Size	d1	d2	l1	D1	slw1	slw2	z1	D3	D4	Code
15mm x 1/2"	15	1/2"	16	22	22	26	26	35	30	75520
22mm x 3/4"	22	3/4"	17	30	31	30	28	32	44	75521

TT6/TT243 Reducer

Larger end male for insertion into fitting x push-fit

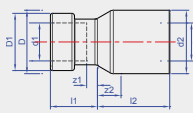

Sizes 15 - 28mm

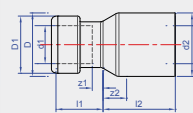

Sizes 35 - 54mm

Size	d1	d2	l1	l2	D1	z1	z2	Code
15 x 10mm	10	15	17	22	16	2	6	75523
15 x 12mm	12	15	20	19	18	5	4	75524
18 x 15mm	15	18	18	22	22	2	4	75522
22 x 14mm	14	22	17	29	20	2	11	75688
22 x 15mm	15	22	18	26	22	6	2	75525
28 x 15mm	15	28	19	33	22	2	13	75526
28 x 22mm	22	28	20	27	30	2	7	75527
35 x 15mm	15	35	18	57	22	2	17	75909
35 x 22mm	22	35	19	51	30	3	11	75910
35 x 28mm	28	35	22	46	37	3	6	75911
42 x 22mm	22	42	21	59	30	4	17	75913
42 x 28mm	28	42	22	54	37	3	12	75914
42 x 35mm	35	42	42	47	47	2	5	75915
54 x 22mm	22	54	20	72	30	2	27	75917
54 x 28mm	28	54	22	67	37	3	22	75918
54 x 35mm	35	54	41	61	46	1	16	75919
54 x 42mm	42	54	38	55	54	4	10	75920



TT12/TT090 Elbow

Push-fit x push-fit

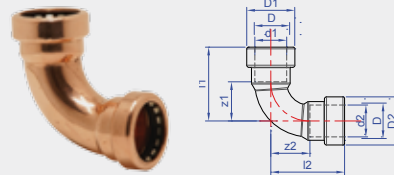

Sizes 10 - 28mm

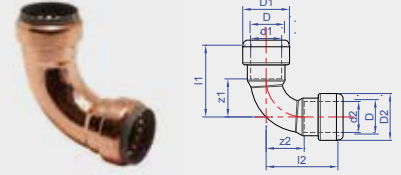

Sizes 35 - 54mm

Size	d1	d2	l1	l2	D1	D2	z1	z2	Code
10mm	10	10	26	26	16	17	6	6	75530
12mm	12	12	34	34	18	19	17	17	75689
14mm	14	14	36	36	20	21	19	19	75690
15mm	15	15	36	36	22	22	19	19	75531
16mm	16	16	36	36	23	23	19	19	75691
18mm	18	18	39	39	25	25	20	20	75692
22mm	22	22	44	44	30	30	25	25	75532
28mm	28	28	51	51	37	37	31	31	75533
35mm	35	35	81	81	46	46	41	41	75921
42mm	42	42	93	93	54	54	51	51	75922
54mm	54	54	110	110	67	67	65	65	75923

TT12S/TT092 Street elbow

Push-fit x male end for insertion into fitting

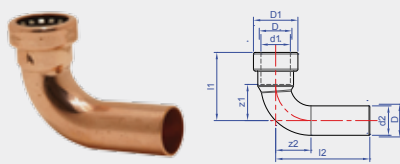

Sizes 10 - 22mm

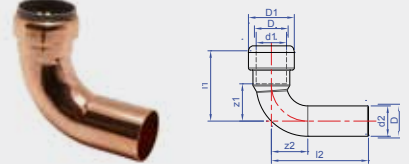

Sizes 35 - 54mm

Size	d1	d2	l1	l2	D1	z1	z2	Code
10mm	10	10	28	44	16	6	18	75535
10 x 15mm	10	15	28	45	16	12	28	75536
12mm	12	12	34	39	18	18	21	75693
14mm	14	14	35	35	20	19	19	75694
15mm	15	15	37	50	22	20	33	75537
16mm	16	16	32	45	23	16	29	75695
18mm	18	18	38	50	25	21	33	75696
22mm	22	22	44	58	30	26	40	75538
35mm	35	35	81	93	46	41	53	75924
42mm	42	42	92	105	54	50	62	75925
54mm	54	54	111	124	67	66	79	75926



TT13/TT092G

Male elbow

Push-fit x BSP taper male thread

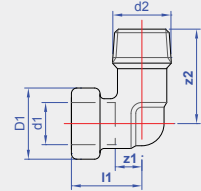

Size	d1	d2	l1	D1	z1	z2	Code
15mm x 1/2"	15	1/2"	24	22	9	29	75540
18mm x 1/2"	18	1/2"	30	25	13	30	75832
22mm x 3/4"	22	3/4"	30	30	13	35	75833

TT14/TT090G

Female elbow

Push-fit x BSP parallel female taper thread

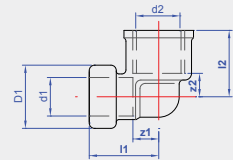

Size	d1	d2	l1	l2	D1	z1	z2	Code
14mm x 1/2"	14	1/2"	26	27	20	10	14	75697
15mm x 1/2"	15	1/2"	26	25	22	10	10	75545
16mm x 1/2"	16	1/2"	25	27	23	10	14	75698
18mm x 1/2"	18	1/2"	30	25	25	13	13	75830
22mm x 3/4"	22	3/4"	32	34	30	13	18	75831

TT15/TT471G

Backplate elbow

Push-fit x BSP parallel female thread

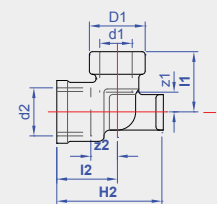

Size	d1	d2	l1	l2	D1	H2	z1	z2	a	Code
12mm x 1/2"	12	1/2"	27	26	18	44	10	14	35	75548
14mm x 1/2"	14	1/2"	26	22	20	44	10	14	35	75699
15mm x 1/2"	15	1/2"	28	25	22	42	17	10	35	75550
18mm x 1/2"	18	1/2"	30	25	25	44	13	13	35	75834



TT21/TT041 45° Obtuse elbow

Push-fit x push-fit

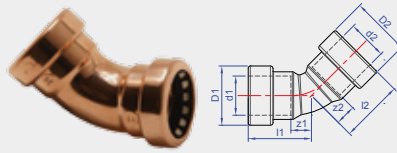

Sizes 12 - 28mm

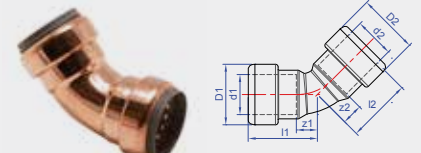

Sizes 35 - 54mm

Size	d1	d2	l1	l2	D1	D2	z1	z2	Code
12mm	12	12	27	27	18	18	10	10	75701
14mm	14	14	28	28	20	20	11	11	75702
15mm	15	15	28	28	22	22	12	12	75551
16mm	16	16	28	28	23	23	13	13	75703
18mm	18	18	33	33	25	25	14	14	75704
22mm	22	22	34	34	30	30	17	17	75552
28mm	28	28	44	44	37	37	22	22	75553
35mm	35	35	57	57	46	46	17	17	75927
42mm	42	42	62	62	54	54	20	20	75928
54mm	54	54	72	72	67	67	27	27	75929

TT21S/TT040 45° Obtuse street elbow

Push-fit x male end for insertion into fitting

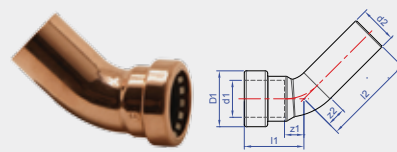

Sizes 12 - 28mm

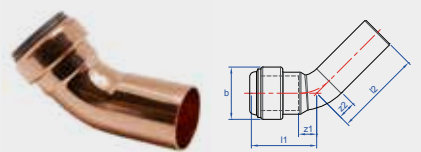

Sizes 35 - 54mm

Size	d1	d2	l1	l2	D1	z1	z2	Code
12mm	12	12	27	27	19	10	10	75705
14mm	14	14	28	28	21	11	11	75706
15mm	15	15	28	36	22	12	12	75585
16mm	16	16	28	28	23	13	13	75707
18mm	18	18	33	33	25	14	14	75708
22mm	22	22	34	34	30	17	17	75586
28mm	28	28	44	44	37	22	22	75587
35mm	35	35	57	68	46	19	28	75930
42mm	42	42	62	76	54	23	34	75931
54mm	54	54	72	85	67	29	40	75932



TT24/TT130 Equal tee

Push-fit on all ends

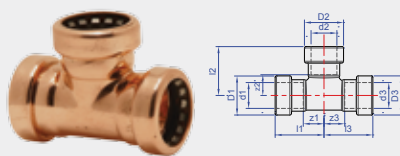
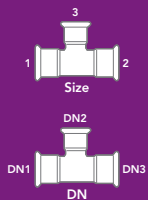

Sizes 10 - 28mm

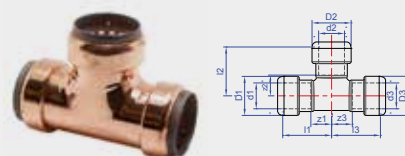

Sizes 35 - 54mm

Size	d1	d2	d3	l1	l2	l3	D1	D2	D3	z1	z2	z3	Code
10mm	10	10	10	23	23	23	16	16	16	7	7	7	75555
12mm	12	12	12	26	26	26	18	18	18	9	9	9	75709
14mm	14	14	14	26	26	26	20	20	20	10	10	10	75710
15mm	15	15	15	26	26	26	22	22	22	9	9	9	75556
18mm	18	18	18	29	29	29	25	25	25	13	13	13	75712
22mm	22	22	22	31	31	31	30	30	30	13	13	13	75557
28mm	28	28	28	38	38	38	37	37	37	17	17	17	75558
35mm	35	35	35	64	64	64	46	46	46	24	24	24	75933
42mm	42	42	42	70	70	70	54	54	54	28	28	28	75934
54mm	54	54	54	78	78	78	67	67	67	33	33	33	75935

TT25/TT130 Tee, reduced branch

Push-fit on all ends

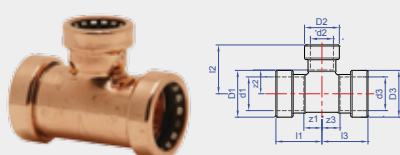
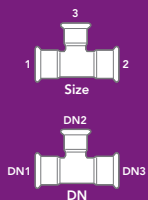

Sizes 14 - 28mm

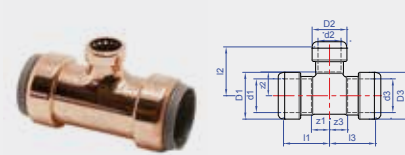

Sizes 35 - 54mm

Size	d1	d2	d3	l1	l2	l3	D1	D2	D3	z1	z2	z3	Code
14 x 14 x 12mm	14	12	14	26	27	25	20	18	20	7	9	7	75713
15 x 15 x 10mm	15	10	15	23	26	23	22	16	22	7	11	7	75565
15 x 15 x 12mm	15	12	15	25	28	25	22	18	22	9	11	9	75714
16 x 16 x 12mm	16	12	16	25	28	25	23	18	23	9	9	9	75715
16 x 16 x 14mm	16	14	16	25	27	25	23	20	23	10	10	10	75716
18 x 18 x 12mm	18	12	18	25	30	25	25	18	25	9	14	9	75717
18 x 18 x 14mm	18	14	18	26	29	26	25	20	25	10	11	10	75718
18 x 18 x 15mm	18	15	18	27	28	27	25	22	25	11	12	11	75719
22 x 22 x 10mm	22	10	22	25	30	25	30	16	30	8	15	8	75566
22 x 22 x 14mm	22	14	22	29	31	29	30	20	30	9	14	9	75720
22 x 22 x 15mm	22	15	22	28	31	28	30	22	30	9	14	9	75567
22 x 22 x 16mm	22	16	22	30	32	30	30	23	30	9	14	9	75721
22 x 22 x 18mm	22	18	22	30	32	30	30	25	30	10	12	10	75722
28 x 28 x 15mm	28	15	28	28	35	28	37	22	37	10	16	10	75568
28 x 28 x 18mm	28	18	28	32	35	32	37	25	37	12	15	12	75723
28 x 28 x 22mm	28	22	28	46	44	46	37	30	37	14	15	14	75569
35 x 35 x 22mm	35	22	35	56	40	56	46	30	46	16	22	16	75937
42 x 42 x 22mm	42	22	42	61	44	61	54	30	54	19	26	19	75940
54 x 54 x 22mm	54	22	54	64	51	64	67	30	67	19	55	19	75944



TT26/TT130 Tee, one end reduced

Push-fit on all ends

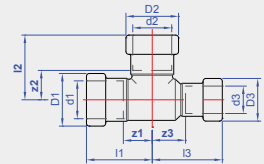
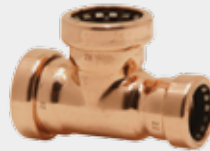
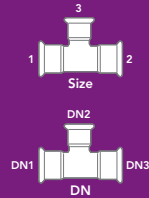

Size	d1	d2	d3	l1	l2	l3	D1	D2	D3	z1	z2	z3	Code
15 x 12 x 15mm	15	15	12	29	29	31	22	22	18	12	12	15	75724
18 x 12 x 18mm	18	18	12	31	32	35	25	25	18	15	15	19	75725
18 x 15 x 18mm	18	18	15	31	31	34	25	25	22	14	14	17	75726
22 x 15 x 22mm	22	22	15	31	31	36	30	30	22	13	13	19	75573
22 x 18 x 22mm	22	22	18	33	33	36	30	30	25	16	16	20	75727
28 x 15 x 28mm	28	28	15	36	36	38	37	37	22	17	17	22	75574
28 x 22 x 28mm	28	28	22	36	36	41	37	37	30	17	17	24	75575

TT27/TT130 Tee, one end and branch reduced

Push-fit on all ends

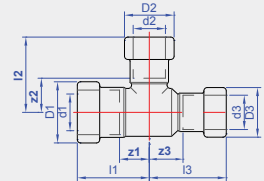
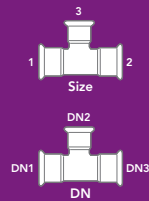

Size	d1	d2	d3	l1	l2	l3	D1	D2	D3	z1	z2	z3	Code
16 x 14 x 14mm	16	14	14	26	26	24	23	20	20	13	10	10	75728
22 x 15 x 15mm	22	15	15	31	29	33	33	22	22	13	13	17	75582
22 x 18 x 18mm	22	18	18	32	34	33	30	25	25	14	18	17	75729
28 x 18 x 18mm	28	18	18	34	37	39	36	25	25	14	20	22	75730
28 x 22 x 22mm	28	22	22	36	36	36	36	30	30	18	19	19	75584

TT30/TT130G Female branch tee

Female branch tee.
Push-fit ends x BSP parallel female branch

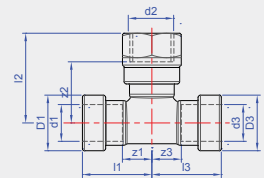
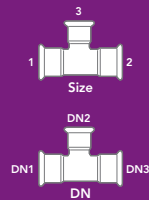

Size	d1	d2	d3	l1	l2	l3	D1	D3	z1	z2	z3	Code
35 x 35mm x 1/2	35	1/2"	35	53	25	53	46	46	14	15	14	75959
42 x 42mm x 1/2	42	1/2"	42	54	28	54	54	54	14	20	14	75960
54 x 54mm x 1/2	54	1/2"	54	57	35	57	67	67	13	26	15	75961



TT61/TT301

Stop end

Push-fit end for use on tube

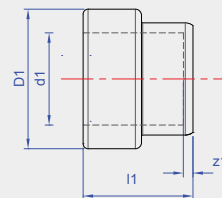

Size	d1	l1	D1	z1	Code
10mm	10	17	16	1	75590
12mm	12	18	18	3	75731
14mm	14	18	21	3	75732
15mm	15	17	22	1	75591
16mm	16	17	23	1	75733
18mm	18	19	24	3	75734
22mm	22	18	30	1	75592
28mm	28	19	36	1	75593

TT62/TT062

Tap connector

Push-fit x BSP union nut

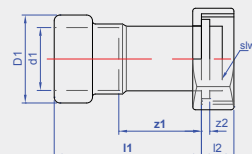

Size	d1	D2	l1	l2	D1	slw2	z1	z2	Code
10mm x 1/2"	10	1/2"	35	13	16	24	19	2	75600
12mm x 3/8"	12	3/8"	33	11	18	21	16	2	75736
12mm x 1/2"	12	1/2"	35	13	18	24	18	2	75735
14mm x 3/8"	14	3/8"	35	11	20	21	18	2	75738
14mm x 1/2"	14	1/2"	31	13	20	24	14	2	75737
15mm x 1/2"	15	1/2"	36	13	22	24	16	2	75601
16mm x 1/2"	16	1/2"	34	13	23	24	18	3	75739
16mm x 3/4"	16	3/4"	34	13	23	31	18	2	75740
18mm x 1/2"	18	1/2"	34	13	25	24	15	2	75741
18mm x 3/4"	18	3/4"	35	13	25	31	19	2	75742
22mm x 3/4"	22	3/4"	39	13	30	31	17	2	75603



TT63/TT063 Bent tap connector

Push-fit x BSP union nut

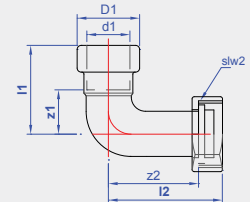

Size	d1	d2	l1	l2	D1	slw2	z1	z2	Code
10mm x 1/2"	10	1/2"	41	36	16	24	16	24	75604
12mm x 1/2"	12	1/2"	33	42	18	24	16	30	75743
15mm x 1/2"	15	1/2"	44	45	22	24	28	32	75605
18mm x 1/2"	18	1/2"	41	42	25	24	24	32	75744

TT69/TT331G Straight male union connector

Push-fit x BSP taper male thread

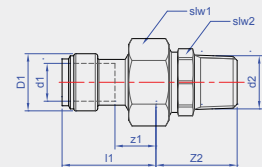

Size	d1	D2	l1	D1	slw1	slw2	z1	z2	Code
35mm x 1.1/4	35	1.1/4"	56	46	58	46	43	16	75965
42mm x 1.1/2	42	1.1/2"	57	54	58	51	44	15	75966
54mm x 2	54	2"	62	67	75	65	50	17	75967



TT1CP/TT270 Straight coupling

Push-fit x push-fit

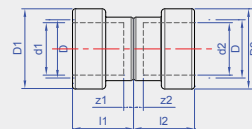

Size	d1	d2	l1	l2	D1	D2	z1	z2	Code
10mm	10	10	17	17	16	16	1	1	75836
12mm	12	12	18	18	18	18	1	1	75837
15mm	15	15	17	17	22	22	1	1	75838
22mm	22	22	19	19	30	30	1	1	75839

TT1RCP/TT240 Reducing coupling

Push-fit x push-fit

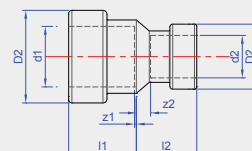

Size	d1	d2	l1	l2	D1	D2	z1	z2	Code
15 x 10mm	15	10	17	23	22	16	1	7	75840
15 x 12mm	15	12	18	23	22	18	1	6	75841

TT2CP/TT270G Straight female connector

Push-fit x BSP parallel female thread

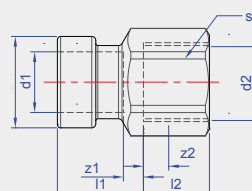

Size	d1	d2	l1	l2	D1	slw2	z1	z2	Code
12mm x 1/2"	12	1/2"	21	15	18	25	4	3	75842
15mm x 1/2"	15	1/2"	17	15	22	25	1	3	75843

TT3CP/TT243G Straight male connector

Push-fit x BSP taper male thread

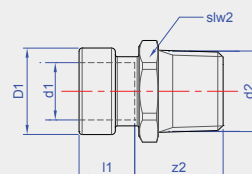

Size	d1	d2	l1	D1	z1	z2	Code
10mm x 1/2"	10	1/2"	15	16	22	20	75844
12mm x 3/8"	12	3/8"	16	18	22	17	75845
12mm x 1/2"	12	1/2"	16	19	25	19	75846
15mm x 1/2"	15	1/2"	16	22	21	20	75847



TT6CP/TT243 Reducer

Larger end male for insertion into fitting x push-fit

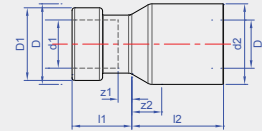

Size	d1	d2	l1	l2	D1	z1	z2	Code
15 x 10mm	10	15	17	22	16	2	6	75848
15 x 12mm	12	15	20	19	18	5	4	75849
22 x 15mm	15	22	18	26	22	6	2	75850

TT12CP/TT090 Elbow

Push fit x push-fit

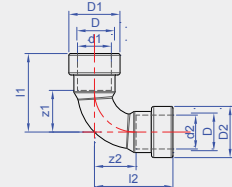

Size	d1	d2	l1	l2	D1	D2	z1	z2	Code
10mm	10	10	26	26	16	17	6	6	75851
12mm	12	12	34	34	18	19	17	17	75852
15mm	15	15	36	36	22	22	19	19	75853
22mm	22	22	44	44	30	30	25	25	75854

TT13CP/TT092G Male elbow

Push-fit x BSP taper male thread

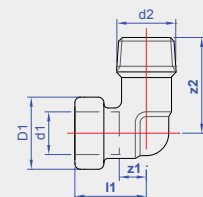

Size	d1	d2	l1	D1	z1	z2	Code
15mm x 1/2"	15	1/2"	24	22	9	29	75855

TT14CP/TT090G Female elbow

Push-fit x BSP parallel female thread

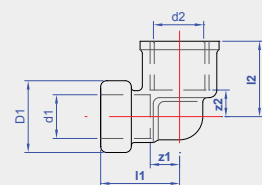

Size	d1	d2	l1	l2	D1	z1	z2	Code
15mm x 1/2"	15	1/2"	26	25	22	10	10	75856



TT15CP/TT471G Backplate elbow

Push-fit x BSP parallel female thread

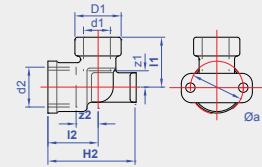
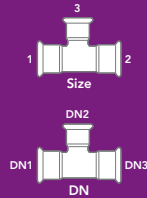

Size	d1	d2	I1	I2	D1	H2	z1	z2	a	Code
12mm x 1/2"	12	1/2"	27	26	18	44	10	14	35	75857
15mm x 1/2"	15	1/2"	28	25	22	42	17	10	35	75858

TT24CP/TT130 Equal tee

Push-fit on all ends

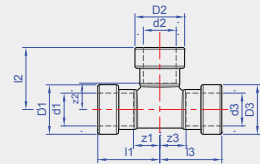
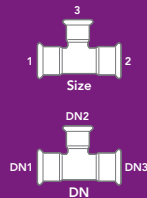

Size	d1	d2	d3	I1	I2	I3	D1	D2	D3	z1	z2	z3	Code
10mm	10	10	10	23	23	23	16	16	16	7	7	7	75859
12mm	12	12	12	26	26	26	18	18	18	9	9	9	75860
15mm	15	15	15	26	26	26	22	22	22	9	9	9	75861
22mm	22	22	22	31	31	31	30	30	30	13	13	13	75862

TT25CP/TT130 Tee, reduced branch

Push-fit on all ends

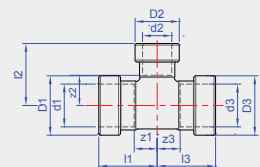
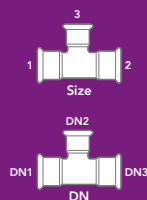

Size	d1	d2	d3	I1	I2	I3	D1	D2	D3	z1	z2	z3	Code
15 x 15 x 10mm	15	10	15	23	26	23	22	16	22	7	11	7	75863
15 x 15 x 12mm	15	12	15	25	28	25	22	18	22	9	11	9	75864
22 x 22 x 15mm	22	15	22	28	31	28	30	22	30	9	14	9	75865

TT26CP/TT130 Tee, one end reduced

Push-fit on all ends

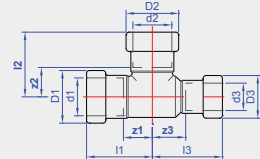
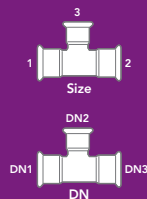

Size	d1	d2	d3	I1	I2	I3	D1	D2	D3	z1	z2	z3	Code
22 x 15 x 22mm	22	22	15	31	31	36	30	30	22	13	13	19	75869



TT27CP/TT130 Tee, one end and branch reduced

Push-fit on all ends

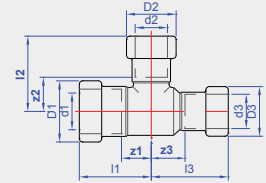
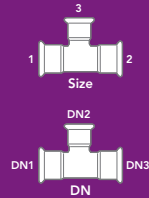

Size	d1	d2	d3	l1	l2	l3	D1	D2	D3	z1	z2	z3	Code
22 x 15 x 15mm	22	15	15	31	29	33	33	22	22	13	13	17	75870

TT61/TT301 Stop end

Push-fit end for use on tube

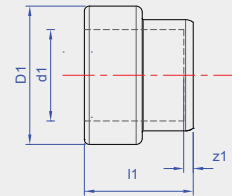

Size	d1	l1	D1	z1	Code
10mm	10	17	16	1	75866
12mm	12	18	18	3	75867
15mm	15	17	22	1	75868



TX1/TX270 Straight coupling

Push-fit x push-fit

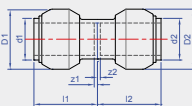

Sizes 15 - 28mm

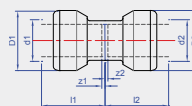

Sizes 35 - 54mm

Size	d1	d2	l1	l2	D1	D2	z1	z2	Code
15mm	15	15	25	25	26	26	1	1	65114
22mm	22	22	30	30	34	34	1	1	65121
28mm	28	28	33	33	42	42	1	1	65123
35mm	35	35	58	58	60	60	1	1	45126
42mm	42	42	63	63	71	71	1	1	45128
54mm	54	54	70	70	83	83	1	1	45130

TX1 Slip/TX270S Straight coupling slip pattern

Push-fit x push-fit

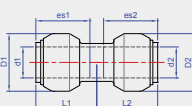

Sizes 15 - 28mm

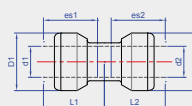

Sizes 35 - 54mm

Size	d1	d2	l1	l2	D1	D2	es1	es2	Code
15mm	15	15	25	25	26	26	24	24	65141
22mm	22	22	30	30	34	34	29	29	65143
28mm	28	28	33	33	42	42	32	32	65144
35mm	35	35	58	58	60	60	57	57	45145
42mm	42	42	63	63	71	71	62	62	45146
54mm	54	54	70	70	83	83	69	69	45147

TX2/TX270G Straight female connector

Push-fit x BSP parallel female thread

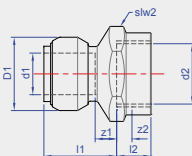

Sizes 15 - 28mm

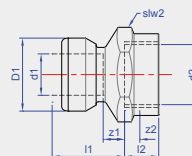

Sizes 35 - 54mm

Size	d1	d2	l1	l2	D1	slw2	z1	z2	Code
15mm x 1/2"	15	1/2"	25	16	26	25	1	3	65206
22mm x 3/4"	22	3/4"	30	18	34	31	1	3	65222
22mm x 1"	22	1"	30	20	34	38	1	4	65223
28mm x 1"	28	1"	33	20	42	37	1	4	65225
35mm x 1 1/4"	35	1.1/4"	58	26	60	48	1	6	45230
42mm x 1 1/2"	42	1.1/2"	63	26	71	54	1	6	45232
54mm x 2"	54	2"	70	30	83	66	1	6	45234



TX3/TX243G Straight male connector

Push-fit x BSP taper male thread

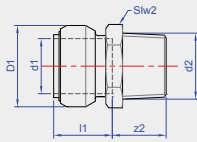

Sizes 15 - 28mm

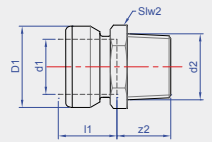

Sizes 35 - 54mm

Size	d1	d2	l1	D1	slw2	z2	Code
5mm x 1/2"	15	1/2"	24	26	22	16	65267
22mm x 3/4"	22	3/4"	29	34	28	17	65292
22mm x 1"	22	1"	29	34	34	20	65294
28mm x 1"	28	1"	32	42	37	21	65296
35mm x 1 1/4"	35	1 1/4"	57	60	43	26	45310
42mm x 1 1/2"	42	1 1/2"	62	71	50	26	45312
54mm x 2"	54	2"	69	83	61	31	45314

TX3P/TX243G Straight male connector

Push-fit x BSP parallel male thread

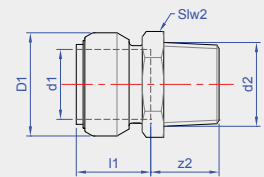

Size	d1	d2	l1	D1	slw2	z1	d3	Code
15mm x 1/2"	15	1/2"	24	26	24	14	32	65358
22mm x 1/2"	22	1/2"	29	34	24	14	32	65364
22mm x 3/4"	22	3/4"	29	34	26	14	32	65366
22mm x 1"	22	1"	29	34	28	15	35	65368
28mm x 1"	28	1"	32	42	28	16	42	65370

TX6/TX243 Reducer

Larger end male for insertion into fitting x push-fit

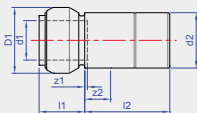

Sizes 22 - 28mm

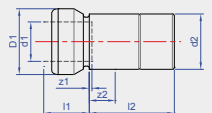

Sizes 35 - 54mm

Size	d1	d2	l1	l2	D1	z1	z2	Code
22 x 15mm	15	22	22	30	26	2	1	65426
28 x 15mm	15	28	22	33	26	2	1	65435
28 x 22mm	22	28	23	33	34	6	1	65438
35 x 15mm	15	35	23	58	26	1	1	45450
35 x 22mm	22	35	25	58	34	4	1	45452
35 x 28mm	28	35	30	58	42	2	1	45454
42 x 15mm	15	42	23	63	26	1	1	45456
42 x 22mm	22	42	25	63	34	4	1	45458



TX6/TX243 Reducer (cont)

Size	d1	d2	l1	l2	D1	z1	z2	Code
42 x 28mm	28	42	29	63	42	3	1	45460
42 x 35mm	35	42	54	62	60	3	0	45462
54 x 15mm	15	54	24	70	26	1	1	45464
54 x 22mm	22	54	25	70	34	4	1	45466
54 x 28mm	28	54	30	70	42	2	1	45468
54 x 35mm	35	54	54	70	60	3	1	45470
54 x 42mm	42	54	59	70	71	3	1	45472

TX12/TX090 Elbow

Push-fit x push-fit

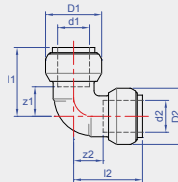

Sizes 15 - 28mm

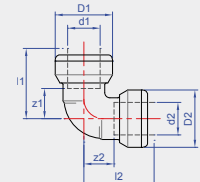

Sizes 35 - 54mm

Size	d1	d2	l1	l2	D1	D2	z1	z2	Code
15mm	15	15	33	33	26	26	9	9	65516
22mm	22	22	40	40	34	34	12	12	65524
28mm	28	28	49	49	42	42	17	17	65526
35mm	35	35	76	76	60	60	19	19	45530
42mm	42	42	85	85	71	71	23	23	45532
54mm	54	54	98	98	83	83	29	29	45534

TX12S/TX092 Street elbow

Push-fit x male copper for insertion into fitting

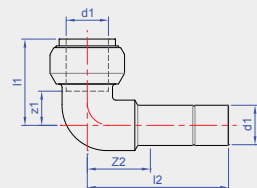

Size	d1	d2	l1	l2	D1	z1	z2	Code
15mm	15	15	33	44	26	9	20	65496
22mm	22	22	40	48	34	12	19	65500
28mm	28	28	49	57	42	17	25	65502



TX13/TX092G Male elbow

Push-fit x BSP taper male thread

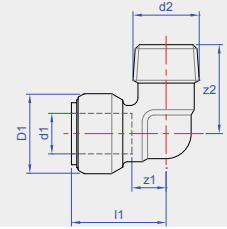

Size	d1	d2	l1	D1	z1	z2	Code
15mm x 1/2"	15	1/2"	33	26	9	29	65561
22mm x 3/4"	22	3/4"	41	34	12	34	65576
28mm x 1"	28	1"	49	42	17	42	65578

TX14/TX090G Female elbow

Push-fit x BSP parallel female thread

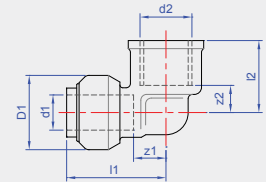

Size	d1	d2	l1	l2	D1	z1	z2	Code
15mm x 1/2"	15	1/2"	34	25	26	10	11	65606
22mm x 3/4"	22	3/4"	42	33	34	13	18	65620
28mm x 1"	28	1"	49	37	42	17	21	65622

TX15/TX471G Backplate elbow

Push-fit x BSP parallel female thread

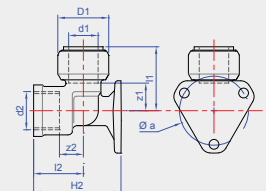

Size	d1	d2	l1	l2	H2	a	D1	z1	z2	Code
15mm x 1/2"	15	1/2"	35	25	44	35	26	10	13	65646



TX21/TX041 45° Obtuse elbow

Push-fit x push-fit

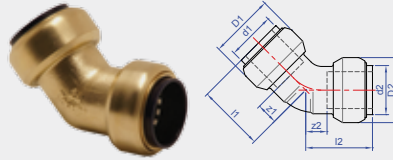

Sizes 22 - 28mm

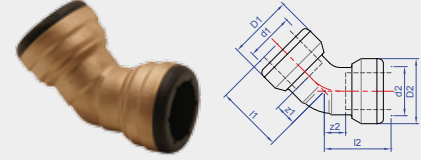

Sizes 35 - 54mm

Size	d1	d2	l1	l2	D1	D2	z1	z2	Code
15mm	15	15	29	29	26	26	5	5	65535
22mm	22	22	35	35	34	34	6	6	65538
28mm	28	28	40	40	42	42	8	8	65539
35mm	35	35	67	67	60	60	10	10	45540
42mm	42	42	75	75	71	71	13	13	45541
54mm	54	54	84	84	83	83	15	15	45558

TX21S/TX040 Obtuse street elbow

Push-fit male end for insertion into fitting

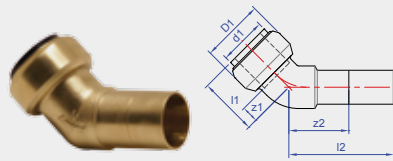

Sizes 15 - 28mm

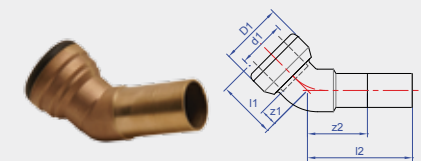

Sizes 35 - 54mm

Size	d1	d2	l1	l2	D1	z1	z2	Code
15mm	15	15	29	37	26	5	13	65542
22mm	22	22	35	42	34	6	13	65545
28mm	28	28	40	47	42	8	15	65546
35mm	35	35	67	67	60	10	37	45547
42mm	42	42	75	75	71	13	43	45548
54mm	54	54	84	94	83	15	45	45549

TX24/TX130 Equal tee

Push-fit on all ends

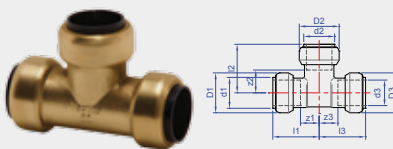
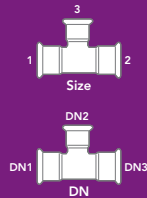

Sizes 22 - 28mm

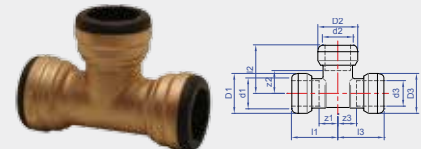

Sizes 35 - 54mm

Size	d1	d2	d3	l1	l2	l3	D1	D2	D3	z1	z2	z3	Code
15mm	15	15	15	33	33	33	26	26	26	9	9	9	65666
22mm	22	22	22	41	41	41	34	34	34	12	12	12	65676
28mm	28	28	28	49	49	49	42	42	42	17	17	17	65678
35mm	35	35	35	76	76	76	60	60	60	19	19	19	45680
42mm	42	42	42	85	85	85	71	71	71	23	23	23	45682
54mm	54	54	54	98	98	98	83	83	83	29	29	29	45684



TX25/TX130 Tee, reduced branch

Push-fit on all ends

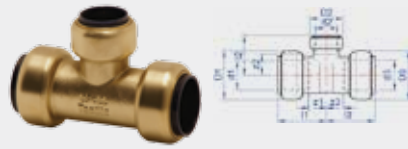
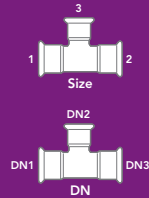

Sizes 22 - 28mm

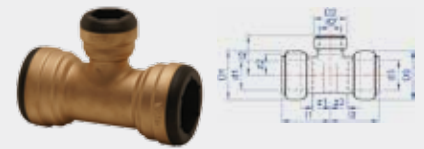

Sizes 35 - 54mm

Size	d1	d2	d3	l1	l2	l3	D1	D2	D3	z1	z2	z3	Code
22 x 22 x 15mm	22	15	22	38	38	38	34	26	34	9	14	9	65737
28 x 28 x 15mm	28	15	28	42	40	42	42	26	42	10	16	10	65744
28 x 28 x 22mm	28	22	28	46	44	46	42	34	42	14	15	14	65746
35 x 35 x 15mm	35	15	35	68	67	68	60	26	60	11	43	11	45750
35 x 35 x 22mm	35	22	35	74	74	74	60	34	60	17	45	17	45752
35 x 35 x 28mm	35	28	35	74	78	74	60	42	60	17	46	17	45753
42 x 42 x 15mm	42	15	42	80	82	80	71	26	71	18	58	18	45754
42 x 42 x 22mm	42	22	42	80	76	80	71	34	71	18	47	18	45756
42 x 42 x 28mm	42	28	42	80	81	80	71	42	71	18	49	18	45758
54 x 54 x 15mm	54	15	54	88	89	88	83	26	83	19	65	19	45760
54 x 54 x 22mm	54	22	54	88	84	88	83	34	83	19	55	19	45762
54 x 54 x 28mm	54	28	54	88	87	88	83	42	83	19	55	19	45764
54 x 54 x 35mm	54	35	54	88	86	88	83	60	83	19	29	19	45765

TX26/TX130 Tee, one end reduced

Push-fit on all ends

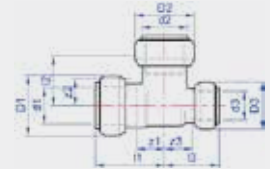
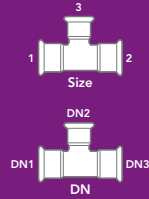

Size	d1	d2	d3	l1	l2	l3	D1	D2	D3	z1	z2	z3	Code
22 x 15 x 22mm	22	22	15	41	41	37	34	34	26	12	12	13	65786
28 x 15 x 28mm	28	28	15	48	48	40	42	42	26	16	16	16	65790
28 x 22 x 28mm	28	28	22	49	48	44	42	42	34	17	16	15	65793

TX27/TX130 Tee, one end branch reduced

Push-fit on all ends

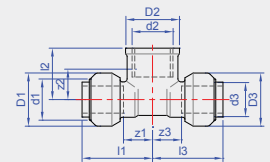
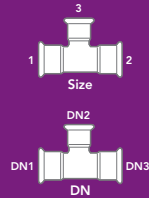

Size	d1	d2	d3	l1	l2	l3	D1	D2	D3	z1	z2	z3	Code
22 x 15 x 15mm	22	15	15	37	36	31	34	26	26	8	12	7	65820
28 x 22 x 22mm	28	22	22	46	44	44	42	34	34	13	15	15	65822



TX30/TX130G Female branch tee

Push-fit ends x BSP
parallel female
branch

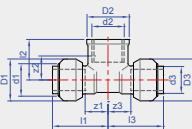
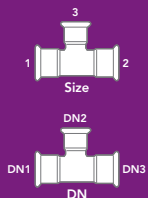

Sizes 15 - 22mm

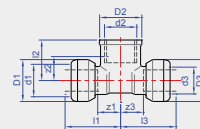

Sizes 35 - 42mm

Size	d1	d2	d3	l1	l2	l3	D1	D2	D3	z1	z2	z3	Code
15 x 15mm x 1/2"	15	1/2"	15	35	25	35	26	27	26	11	12	11	65840
22 x 22mm x 1/2"	22	1/2"	22	39	27	39	34	27	34	10	14	10	65845
35 x 35mm x 1/2"	35	1/2"	35	68	38	68	60	27	60	11	21	11	45848
42 x 42mm x 1/2"	42	1/2"	42	74	41	74	71	27	71	12	25	12	45850

TX61/TX301 Stop end

Push-fit ends for use on tube

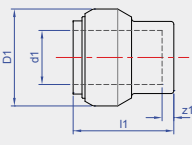

Sizes 15 - 28mm

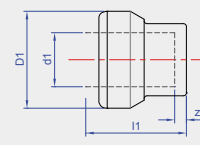

Sizes 35 - 54mm

Size	d1	l1	D1	D2	z1	Code
15mm	15	26	26	26	2	65866
22mm	22	31	34	34	2	65874
28mm	28	34	42	42	2	65876
35mm	35	63	60	60	6	45878
42mm	42	68	71	71	6	45880
54mm	54	76	83	83	6	45882

TX61RV/TX302 Air release stop end

Push-fit x air release valve

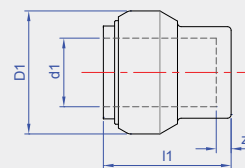

Size	d1	l1	D1	D2	z1	Code
15mm	15	34	26	26	10	65892
22mm	22	39	34	34	10	65894
28mm	28	42	42	42	10	65895



TX62/TX062 Tap connector

Push-fit x BSP union nut.
Spigot and washer joint

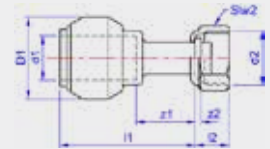

Size	d1	d2	l1	l2	D1	slw2	z1	z2	Code
15mm x 1/2"	15	1/2"	36	13	26	24	13	2	65902
15mm x 3/4"	15	3/4"	35	13	26	31	11	2	65171
22mm x 3/4"	22	3/4"	46	13	34	31	17	2	65903

TX63/TX063 Bent tap connector

Push-fit x BSP union nut.
Spigot and washer joint

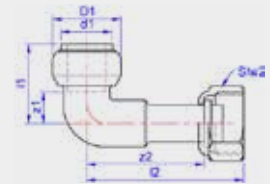

Size	d1	d2	l1	l2	D1	slw2	z1	z2	Code
15mm x 1/2"	15	1/2"	33	47	26	24	9	39	65922
22mm x 3/4"	22	3/4"	42	52	34	31	18	40	65924

TX68FF/TX068 Flat faced union adaptor

Push-fit x BSP union nut.
Suitable for use with water meters

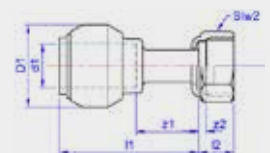

Size	d1	d2	l1	l2	slw2	z1	z2	Code
15mm x 3/4"	15	3/4"	32	13	31	8	2	65759
22mm x 3/4"	22	3/4"	44	13	31	17	2	65760



TX68S Cylinder union

Male end for insertion into fitting x BSP union nut

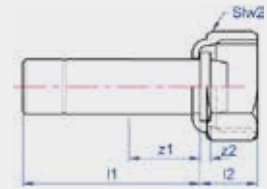

Size	d1	d2	l1	l2	slw2	z1	z2	Code
22mm x 1"	22	1"	37	15	31	8	3	65930

Tectite Flexi-fit

TXF90 Flexible connector

Push-fit x push-fit 300mm long



Size	a	Code
15mm	300mm	65983
22mm	400mm	65984

TXF92 Flexible tap connector

Push-fit x BSP parallel female thread. Spigot and washer joint 300mm long



Size	a	Code
15mm x 1/2"	300mm	65985
22mm x 3/4"	400mm	65986

2.0 PRODUCT DETAILS

TECTITE 316 TUBE AND PUSH-FIT FITTINGS



SS610 316 Stainless steel

316 System tube 6 metre lengths

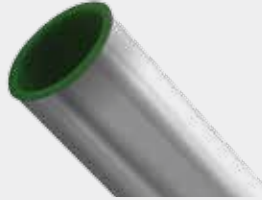

Size	Code
15 x 0.6mm	25010
18 x 0.7mm	25001
22 x 0.7mm	25002
28 x 0.8mm	25016
35 x 1.0mm	25018
42 x 1.1mm	25019
54 x 1.2mm	25021

TS1/TS270 Straight coupling

Push-fit x push-fit

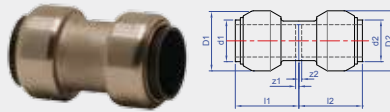

Sizes 15 - 28mm

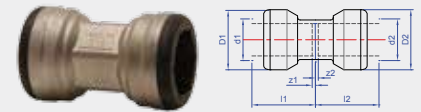

Sizes 35 - 54mm

Size	d1	d2	l1	l2	D1	D2	z1	z2	Code
15mm	15	15	25	25	26	26	1	1	25114
18mm	18	18	25	25	29	29	1	1	25118
22mm	22	22	30	30	34	34	1	1	25121
28mm	28	28	33	33	42	42	1	1	25123
35mm	35	35	58	58	60	60	1	1	25126
42mm	42	42	63	63	71	71	1	1	25128
54mm	54	54	70	70	83	83	1	1	25130

TS1 Slip/TS270S Straight coupling, Slip Pattern

Push-fit x push-fit

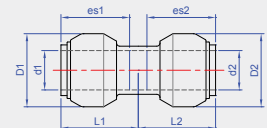

Size	d1	d2	l1	l2	D1	D2	es1	es2	Code
15mm	15	15	25	25	26	26	24	24	25141
18mm	18	18	25	25	29	29	24	24	25142
22mm	22	22	30	30	34	34	29	29	25143
28mm	28	28	33	33	42	42	32	32	25144



TS2/TS270G

Straight female connector

Push-fit x BSP parallel female thread

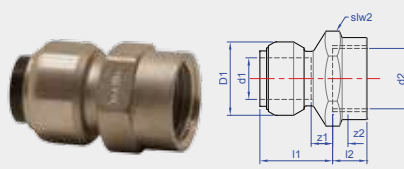

Sizes 15 - 28mm

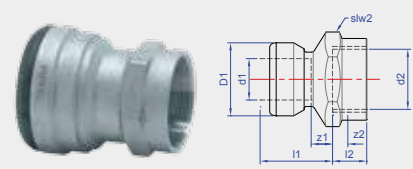

Sizes 35 - 54mm

Size	d1	d2	l1	l2	D1	slw2	z1	z2	Code
15mm x 1/2"	15	1/2"	25	17	26	25	1	3	25206
18mm x 1/2"	18	1/2"	25	17	29	25	1	3	25210
18mm x 3/4"	18	3/4"	27	17	29	32	3	4	25212
22mm x 1/2"	22	1/2"	30	17	34	25	3	3	25220
22mm x 3/4"	22	3/4"	30	17	34	32	3	3	25222
22mm x 1"	22	1"	28	23	34	38	1	4	25223
28mm x 3/4"	28	3/4"	32	17	42	32	1	4	25224
28mm x 1"	28	1"	32	23	42	38	1	4	25225
35mm x 1 1/4"	35	1.1/4"	59	25	60	48	2	6	25230
42mm x 1 1/2"	42	1.1/2"	64	25	71	54	2	6	25232
54mm x 2"	54	2"	70	30	83	65	1	6	25234

TS3/TS243G

Straight male connector

Push-fit x BSP taper male thread

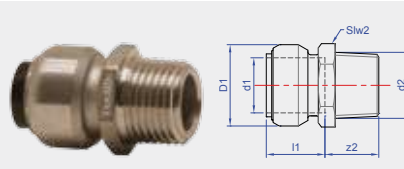

Sizes 15 - 28mm

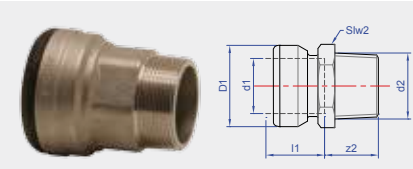

Sizes 35 - 54mm

Size	d1	d2	l1	D1	slw2	z2	Code
15mm x 1/2"	15	1/2"	23	26	25	19	25267
18mm x 1/2"	18	1/2"	23	29	25	22	25286
18mm x 3/4"	18	3/4"	23	29	32	23	25288
22mm x 1/2"	22	1/2"	27	34	28	19	25290
22mm x 3/4"	22	3/4"	27	34	32	20	25292
28mm x 3/4"	28	3/4"	31	42	32	20	25295
28mm x 1"	28	1"	31	42	38	23	25296
35mm x 1 1/4"	35	1.1/4"	57	60	43	27	25310
42mm x 1 1/2"	42	1.1/2"	62	71	50	26	25312
54mm x 2"	54	2"	68	83	61	31	25314



TS6/TS243 Reducer

Larger male end for insertion into fitting x push-fit

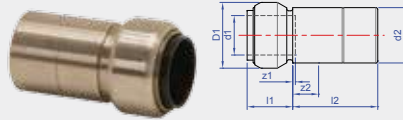

Sizes 15 - 28mm

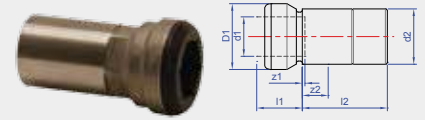

Sizes 35 - 54mm

Size	d1	d2	l1	l2	D1	z1	z2	Code
18 x 15mm	15	18	23	22	26	0	0	25424
22 x 15mm	15	22	23	30	26	0	3	25426
22 x 18mm	18	22	22	31	29	0	4	25430
28 x 15mm	15	28	22	33	26	0	2	25435
28 x 18mm	18	28	23	33	29	0	2	25437
28 x 22mm	22	28	23	33	34	6	1	25438
35 x 22mm	22	35	25	58	34	4	1	25452
35 x 28mm	28	35	30	58	42	2	1	25454
42 x 22mm	22	42	25	63	34	4	1	25458
42 x 28mm	28	42	29	63	42	3	1	25460
42 x 35mm	35	42	54	62	60	0	2	25462
54 x 35mm	35	54	54	70	60	3	3	25470
54 x 42mm	42	54	59	70	71	3	3	25472

TS12/TS090 Elbow

Push-fit x push-fit

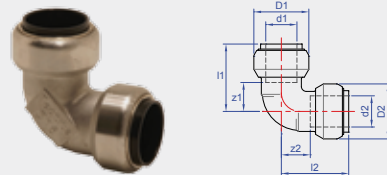

Sizes 15 - 28mm

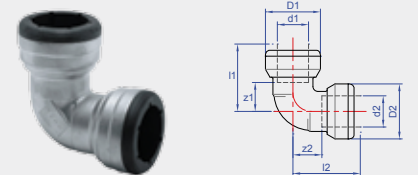

Sizes 35 - 54mm

Size	d1	d2	l1	l2	D1	D2	z1	z2	Code
15mm	15	15	33	33	26	26	9	9	25516
18mm	18	18	34	34	29	29	10	10	25520
22mm	22	22	40	40	34	34	12	12	25524
28mm	28	28	48	48	42	42	16	16	25528
35mm	35	35	76	76	60	60	20	20	25530
42mm	42	42	86	86	71	71	23	23	25532
54mm	54	54	98	98	83	83	29	29	25534



TS12S/TS092 Street elbow

Push-fit x male copper for insertion into fitting

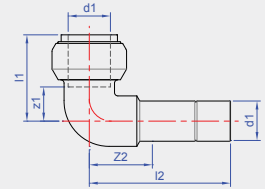

Size	d1	d2	l1	l2	D1	z1	z2	Code
15mm	15	15	33	40	26	10	17	25496
18mm	18	18	34	43	29	11	20	25498
22mm	22	22	42	50	34	14	19	25500
28mm	28	28	47	61	42	16	30	25502

TS13/TS092G Male elbow

Push-fit x BSP taper male thread

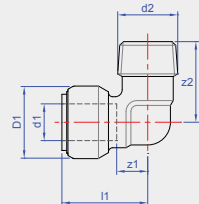

Size	d1	d2	l1	D1	z1	z2	Code
15mm x 1/2"	15	1/2"	32	26	9	31	25561
18mm x 1/2"	18	1/2"	32	29	9	31	25569
22mm x 3/4"	22	3/4"	39	34	12	35	25576
28mm x 1"	28	1"	47	42	17	41	25578

TS14/TS090G Female elbow

Push-fit x BSP parallel female thread

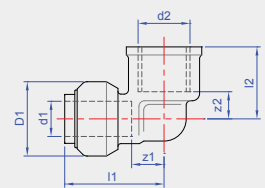

Size	d1	d2	l1	l2	D1	z1	z2	Code
15mm x 1/2"	15	1/2"	34	25	26	11	10	25606
18mm x 1/2"	18	1/2"	36	27	29	12	10	25614
18mm x 3/4"	18	3/4"	39	29	29	16	10	25615
22mm x 3/4"	22	3/4"	40	32	34	13	14	25620
28mm x 1"	28	1"	47	40	42	16	21	25622



TS15/TS471G Backplate elbow

Push-fit x BSP parallel female thread

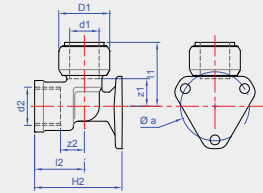

Size	d1	d2	l1	l2	H2	a	D1	z1	z2	Code
15mm x 1/2"	15	1/2"	34	27	43	35	26	11	13	25646
18mm x 1/2"	18	1/2"	35	27	45	35	29	12	13	25650
22mm x 3/4"	22	3/4"	41	31	52	35	34	14	13	25654

TS18/TS002A Slow bend

Push-fit x push-fit

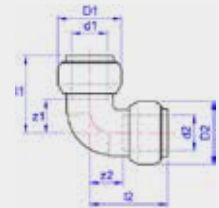

Size	d1	d2	l1	l2	D1	D2	z1	z2	Code
15mm	15	15	41	41	26	26	18	18	26003
18mm	18	18	47	47	29	29	24	24	26005
22mm	22	22	54	54	34	34	27	27	26007
28mm	28	28	66	66	42	42	35	35	26008
35mm	35	35	99	99	60	60	42	42	26009
42mm	42	42	112	112	71	71	50	50	26010
54mm	54	54	133	133	83	83	65	65	26011

TS18S/TS001 Slow street elbow

Push-fit x male copper for insertion into fitting

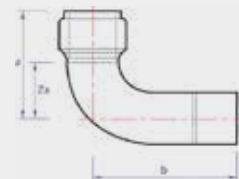

Size	d1	d2	l1	l2	D1	z1	z2	Code
15mm	15	15	41	52	26	18	29	26023
18mm	18	18	45	53	29	22	28	26025
22mm	22	22	53	62	34	27	47	26027
28mm	28	28	66	74	42	35	43	26028



TS21/TS041 45° Obtuse elbow

Push-fit x push-fit

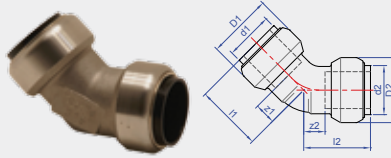

Sizes 15 - 28mm

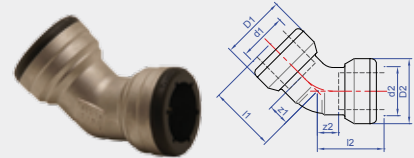

Sizes 35 - 54mm

Size	d1	d2	l1	l2	D1	D2	z1	z2	Code
15mm	15	15	28	28	26	26	5	5	26043
18mm	18	18	28	28	29	29	5	5	26045
22mm	22	22	33	33	34	34	6	6	26047
28mm	28	28	39	39	42	42	8	8	26048
35mm	35	35	67	67	60	60	10	10	26049
42mm	42	42	75	75	71	71	13	13	26050
54mm	54	54	84	84	83	83	15	15	26051

TS21S/TS040 45° Obtuse street elbow

Push-fit x male end for insertion into fitting

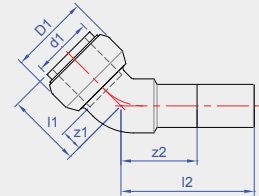

Size	d1	d2	l1	l2	D1	z1	z2	Code
15mm	15	15	28	36	26	5	13	26063
18mm	18	18	28	37	29	5	14	26065
22mm	22	22	33	42	34	6	15	26067
28mm	28	28	38	48	42	7	17	26068
35mm	35	35	66	94	60	10	37	26069
42mm	42	42	75	106	71	13	44	26070
54mm	54	54	83	115	83	15	47	26071

TS24/TS130 Equal tee

Push-fit on all ends

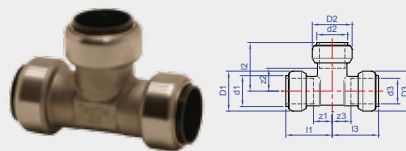
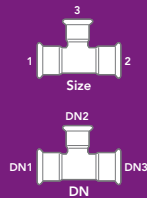

Sizes 15 - 28mm

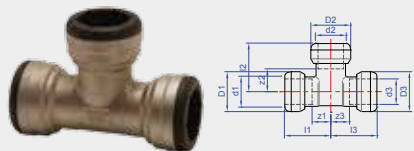

Sizes 35 - 54mm

Size	d1	d2	d3	l1	l2	l3	D1	D2	D3	z1	z2	z3	Code
15mm	15	15	15	33	33	33	26	26	26	9	9	9	25666
18mm	18	18	18	34	34	34	29	29	29	10	10	10	25670
22mm	22	22	22	39	39	39	34	34	34	12	12	12	25676
28mm	28	28	28	46	46	46	42	42	42	15	15	15	25678
35mm	35	35	35	77	77	77	60	60	60	20	20	20	25680
42mm	42	42	42	85	85	85	71	71	71	23	23	23	25682
54mm	54	54	54	98	98	98	83	83	83	29	29	29	25684



TS25/TS130 Tee, reduced branch

Push-fit on all ends

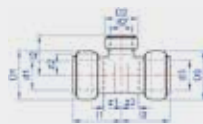
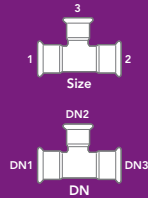

Sizes 18 - 28mm

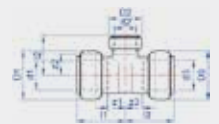

Sizes 35 - 54mm

Size	d1	d2	d3	l1	l2	l3	D1	D2	D3	z1	z2	z3	Code
18 x 18 x 15mm	18	15	18	34	35	34	29	26	29	9	10	9	25725
22 x 22 x 15mm	22	15	22	36	36	36	34	26	34	9	13	9	25737
22 x 22 x 18mm	22	18	22	37	36	37	34	29	34	10	13	10	25742
28 x 28 x 15mm	28	15	28	40	39	40	42	26	42	9	16	9	25744
28 x 28 x 18mm	28	18	28	42	39	42	42	29	42	11	16	11	25745
28 x 28 x 22mm	28	22	28	44	40	44	42	34	44	13	16	13	25746
35 x 35 x 15mm	35	15	35	69	63	69	60	26	60	11	39	11	25750
35 x 35 x 22mm	35	22	35	74	73	74	60	34	60	17	49	17	25752
35 x 35 x 28mm	35	28	35	74	73	74	60	42	60	17	42	17	25753
42 x 42 x 22mm	42	22	42	80	76	80	71	34	71	17	47	17	25756
42 x 42 x 28mm	42	28	42	80	79	80	71	42	71	17	45	17	25758
54 x 54 x 22mm	54	22	54	88	77	88	83	34	83	19	48	19	25762
54 x 54 x 28mm	54	28	54	88	85	88	83	42	83	19	51	19	25764
54 x 54 x 35mm	54	35	54	88	86	88	83	60	83	19	29	19	25765
54 x 54 x 42mm	54	42	54	92	91	92	83	71	83	24	29	24	25766

TS30/TS130G Female branch tee

Push-fit ends x BSP
parallel female thread

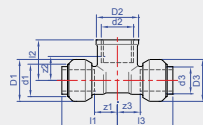
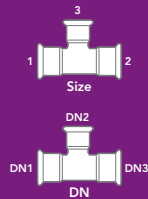

Sizes 15 - 28mm

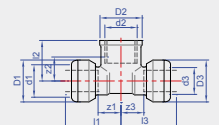

Sizes 35 - 42mm

Size	d1	d2	d3	l1	l2	l3	D1	D2	D3	z1	z2	z3	Code
15 x 15mm x 1/2"	15	1/2"	15	34	27	34	26	26	26	11	10	11	25840
18 x 18mm x 1/2"	18	1/2"	18	36	27	36	29	26	29	13	11	13	25843
22 x 22mm x 1/2"	22	1/2"	22	38	30	38	34	26	34	10	13	10	25845
22 x 22mm x 3/4"	22	3/4"	22	41	32	41	34	34	34	13	15	13	25846
28 x 28mm x 1/2"	28	1/2"	28	41	32	41	42	26	42	10	15	10	25847
35 x 35mm x 1/2"	35	1/2"	35	68	38	68	60	30	60	11	21	11	25848
42 x 42mm x 1/2"	42	1/2"	42	74	41	74	71	30	71	12	25	12	25850



TS61/TS301 Stop end

Push-fit ends for use on stainless steel tube

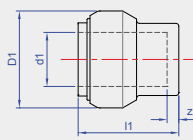

Sizes 15 - 28mm

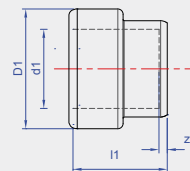

Sizes 35 - 54mm

Size	d1	l1	D1	z1	Code
15mm	15	26	26	3	25866
18mm	18	26	29	3	25870
22mm	22	30	34	3	25874
28mm	28	34	42	3	25876
35mm	35	63	60	6	25878
42mm	42	69	71	7	25880
54mm	54	75	83	7	25882

TS61RV/TS302 Air release stop end

Push-fit x air release valve

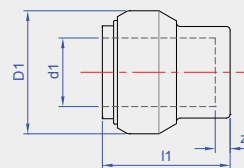

Size	Code
15mm	25884
18mm	25885
22mm	25886
28mm	25887
35mm	25890
42mm	25891
54mm	25892

TS62/TS062 Tap connector

Push-fit x BSP union nut.
Spigot and washer joint

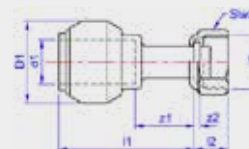

Size	d1	d2	l1	l2	D1	slw2	z1	z2	Code
15mm x 1/2"	15	1/2"	35	13	26	24	12	2	25902
22mm x 3/4"	22	3/4"	46	13	34	31	17	2	25903

TECTITE CARBON STEEL SYSTEM TUBING



SC640

Carbon steel system tube

6 metre and 3 metre lengths



Size	d1	DN1	Code
5mm x 1.2mm	15	DN12	45080
18mm x 1.2mm	18	DN15	45081
22mm x 1.5mm	22	DN20	45082
28mm x 1.5mm	28	DN25	45083
35mm x 1.5mm	35	DN32	45084
42mm x 1.5mm	42	DN40	45085
54mm x 1.5mm	54	DN50	45086
12mm x 1.2mm			25079
15mm x 1.2mm	15	DN12	25080
18mm x 1.2mm	18	DN15	25081
22mm x 1.5mm	22	DN20	25082
28mm x 1.5mm	28	DN25	25083
35mm x 1.5mm	35	DN32	25084
42mm x 1.5mm	42	DN40	25085
54mm x 1.5mm	54	DN50	25086
66.7mm x 1.5mm	67	DN65	25090
76.1mm x 2.0mm	76	DN65	25087
88.9mm x 2.0mm	89	DN80	25088
108mm x 2.0mm	108	DN100	25089

SC660

Plastic coated carbon steel system tube

6 metre lengths



Size	d1	DN1	Code
15mm x 2.2mm	15	DN12	25060
18mm x 2.2mm	18	DN15	25061
22mm x 2.5mm	22	DN20	25062
28mm x 2.5mm	28	DN25	25063
35mm x 2.5mm	35	DN32	25064
42mm x 2.5mm	42	DN40	25065
54mm x 2.5mm	54	DN50	25066



TC1/TC270 Straight coupling

Push-fit x push-fit

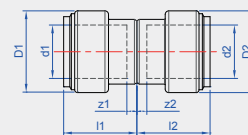

Size	a	Za	b	Code
15mm	61	5	23	76301
18mm	62	6	26	76302
22mm	64	6	31	76303
28mm	67	7	38	76304
35mm	85	8	46	76305
42mm	93	9	55	76306
54mm	96	8	67	76307

TC2/TC270G Straight female connector

Push-fit x parallel female thread

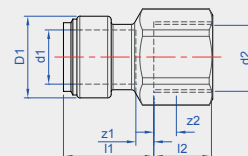

Size	a	Za	b	Code
15mm x 1/2	48	3	27	76336
18mm x 1/2	47	2	30	76337
18mm x 3/4	50	3	34	76338
22mm x 3/4	51	5	36	76339
28mm x 1	57	4	41	76340
35mm x 1.1/4	72	5	48	76341
42mm x 1.1/2	72	3	55	76342

TC3/TC243G Male connector

Push-fit x BSP taper male thread

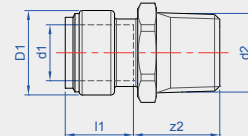

Size	a	Za	b	Code
15mm x 3/8	43	16	27	76348
15mm x 1/2	48	21	27	76349
18mm x 1/2	50	22	30	76350
18mm x 3/4	50	23	30	76351
22mm x 3/4	52	24	36	76352
28mm x 1	56	26	46	76353
35mm x 1.1/4	69	29	52	76354
42mm x 1.1/2	72	30	63	76355
54mm x 2	79	34	78	76356



TC6/TC243 Reducer

Push-fit x male

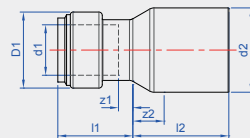

Size	a	Za	b	Code
8 x 15mm	62	35	18	76361
22 x 15mm	64	37	22	76362
22 x 18mm	64	30	22	76363
28 x 15mm	68	41	28	76364
28 x 18mm	72	40	28	76365
28 x 22mm	62	34	28	76366
35 x 15mm	84	57	35	76367
35 x 18mm	82	54	35	76368
35 x 22mm	79	51	35	76369
35 x 28mm	75	45	35	76370
42 x 22mm	87	59	42	76371
42 x 28mm	84	54	42	76372
42 x 35mm	95	55	42	76373
54 x 22mm	100	72	54	76374
54 x 28mm	97	67	54	76375
54 x 35mm	94	54	54	76376
54 x 42mm	104	62	54	76377

TC12/TC090 Elbow

Push-fit x push-fit

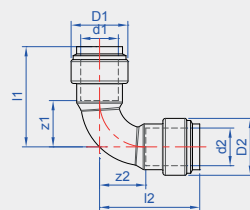

Size	a	Za	b	r	Code
15mm	44	17	23	18	76391
18mm	49	21	26	22	76392
22mm	54	26	31	27	76393
28mm	65	35	38	34	76394
35mm	82	42	46	42	76395
42mm	93	51	55	50	76396
54mm	109	64	68	65	76397



TC12S/TC092

Street elbow

Push-fit x male copper for
insertion into fitting

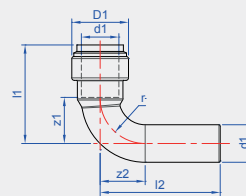

Size	a	Za	b	c	r	Code
15mm	34	7	23	44	18	76456
18mm	37	9	26	39	22	76457
22mm	39	11	31	42	27	76458
28mm	45	15	38	48	34	76459
35mm	57	17	46	68	42	76460
42mm	63	21	55	76	50	76461
54mm	71	26	68	86	65	76462

TC13/TC092G

Male elbow

Push-fit x BSP taper male thread

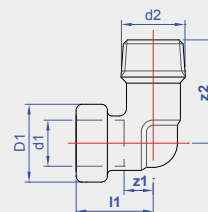

Size	a	b	Za	Code
15mm x 1/2	46	60	19	76416
18mm x 1/2	51	55	21	76417
22mm x 3/4	56	63	28	76418

TC14/TC090G

Female elbow

Push-fit x BSP parallel female thread

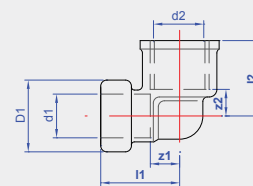

Size	a	b	Za	Zb	Code
15mm x 1/2	46	60	19	45	76426
18mm x 1/2	51	58	21	43	76427
22mm x 3/4	55	62	27	46	76429



TC21/TC041 45° Obtuse elbow

Push-fit x push-fit

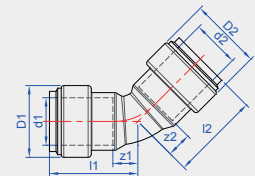

Size	a	Za	b	r	Code
15mm	34	7	23	18	76441
18mm	37	9	26	22	76442
22mm	39	11	31	27	76443
28mm	45	15	38	34	76444
35mm	57	17	46	42	76445
42mm	63	21	55	50	76446
54mm	71	26	68	65	76447

TC21S/TC040 45° Obtuse elbow

Push-fit x male end for insertion into fitting

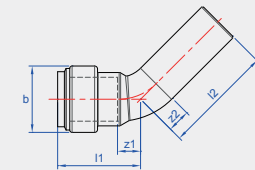

Size	a	Za	b	c	r	Code
15mm	34	7	23	44	18	76456
18mm	37	9	26	39	22	76457
22mm	39	11	31	42	27	76458
28mm	45	15	38	48	34	76459
35mm	57	17	46	68	42	76460
42mm	63	21	55	76	50	76461
54mm	71	26	68	86	65	76462

TC24/TC130 Equal tee

Push-fit all ends

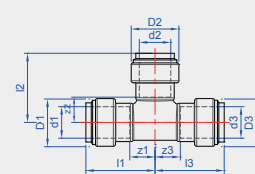
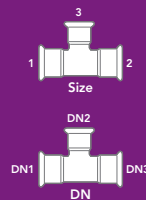

Size	a	Za	b	c	Zc	Code
15mm	78	12	23	39	12	76466
18mm	84	14	26	41	13	76467
22mm	88	16	31	44	16	76468
28mm	98	19	38	50	20	76469
35mm	128	24	47	64	24	76470
42mm	138	27	55	70	28	76471
54mm	160	35	68	80	35	76472



TC25/TC130 Tee, reduced branch

Push-fit all ends

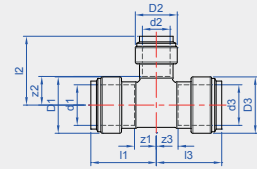
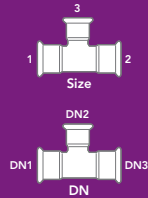

Size	a	Za	b	c	Zc	Code
18 x 18 x 15mm	80	12	26	39	11	76482
22 x 22 x 15mm	82	13	31	44	17	76483
22 x 22 x 18mm	83	13	31	46	18	76484
28 x 28 x 15mm	85	12	38	46	18	76485
28 x 28 x 18mm	90	15	38	47	19	76486
28 x 28 x 22mm	91	15	38	48	20	76487
35 x 35 x 15mm	101	10	47	51	24	76488
35 x 35 x 18mm	104	13	47	52	24	76489
35 x 35 x 22mm	109	15	47	50	22	76490
35 x 35 x 28mm	114	18	47	55	25	76491
42 x 42 x 22mm	118	17	55	53	25	76492
42 x 42 x 28mm	124	21	55	57	27	76493
42 x 42 x 35mm	138	27	55	63	29	76494
54 x 54 x 22mm	125	18	68	60	31	76495
54 x 54 x 28mm	129	21	68	61	31	76496
54 x 54 x 35mm	144	27	68	75	35	76497
54 x 54 x 42mm	150	31	68	80	38	76498

TC30/TC130G Female branch tee

Push-fit x BSP parallel female branch

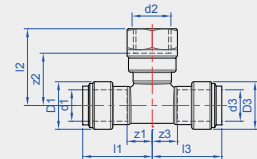
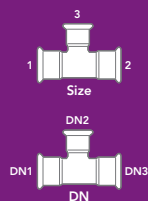

Size	a	Za	b	c	Code
15 x 15 x 1/2"	80	12	25	43	76536
18 x 18 x 1/2"	80	11	29	43	76537
22 x 22 x 1/2"	83	13	31	46	76538
28 x 28 x 1/2"	85	12	41	47	76539
35 x 35 x 1/2"	101	11	59	53	76540
42 x 42 x 1/2"	118	17	70	57	76541
54 x 54 x 1/2"	125	18	68	63	76542



TS61/TS301 Stop end

Push-fit stop end for use on stainless steel tube

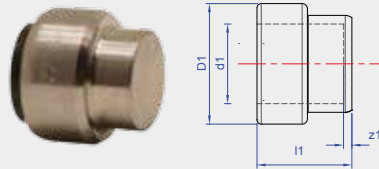

Sizes 15 - 28mm

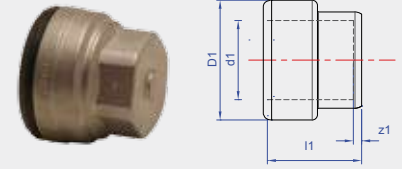

Sizes 35 - 54mm

Size	d1	l1	D1	z1	Code
15mm	15	26	26	3	25866
18mm	18	26	29	3	25870
22mm	22	30	34	3	25874
28mm	28	34	42	3	25876
35mm	35	63	60	6	25878
42mm	42	69	71	7	25880
54mm	54	75	83	7	25882

TC69/TC331G Straight male union connector

Push-fit x BSP taper male thread

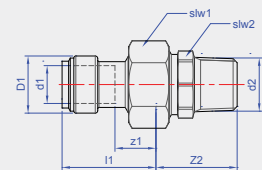

Size	a	Za	b	Code
15mm x 1/2	80	53	32	76571
18mm x 1/2	81	53	32	76572
22mm x 3/4	87	59	38	76573
28mm x 1	98	69	48	76574
35mm x 1.1/4	107	67	53	76575
42mm x 1.1/2	111	70	67	76576
54mm x 2	121	77	67	76577



TX300 Quarter turn lever ball valve

Push-fit x push-fit

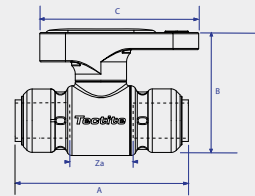

Size	A	B	C	Za	Kg	Code
15mm	71	37	65	25		66001
22mm	88	45	77	34		66004

TX480 Servicing valve

Push-fit x push-fit

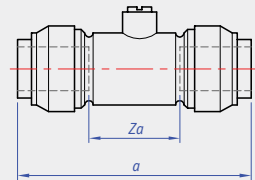

Size	d1	d2	l1	l2	D1	D2	z1	z2	Code
15mm									65950

TX526S/TX467 DZR draining tap

Male end for insertion into fitting.
Draining tap to BS 2879 Type 2

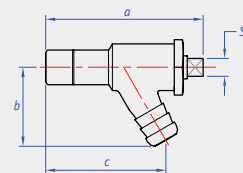

Size	a	b	c	s	Code
15mm	74	35	56	8	65936
15mm					65936CP

TX802 Double check valve

Push-fit x push-fit

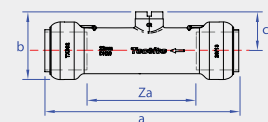

Size	a	b	c	Za	Kg	Code
15mm	92	33	20	46	0.128	66013
22mm	113	40	24	59	0.265	66014



TX809
Straight application valve

Push-fit x 3/4" BSP

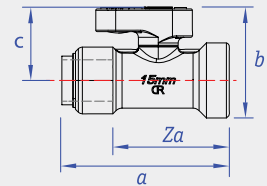

Size	a	b	c	Za	Kg	Code
15mm x 3/4	59	40	25	36	0.088	66010

TX809B
Bent application valve

Push-fit x 3/4" BSP

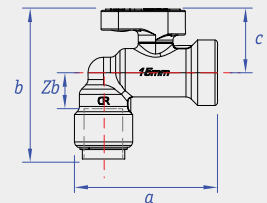

Size	a	b	c	Zb	Kg	Code
15mm x 3/4	58	61	25	13	0.112	66011

TX809T
Tee application valve

Push-fit x 3/4" BSP

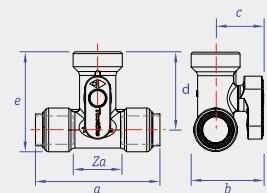

Size	a	b	c	d	e	za	Kg	Code
15mm x 3/4	66	40	25	42	54	20	0.130	66012



TX402 In line thermostatic mixing valve

Push fit x push fit, with flat face unions for easy servicing

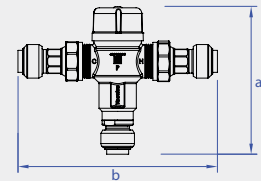

Size	Code
15mm	5A1560
22mm	5A1561

TX402UA In line thermostatic mixing valve

Push fit x push fit, with flat face unions for easy servicing

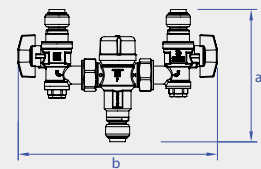

Size	Code
15mm	5A1562
22mm	5A1563

TX402UAX In line thermostatic mixing valve

Push fit x push fit, with flat face unions for easy servicing angle valves with isolating valves, filters and test points

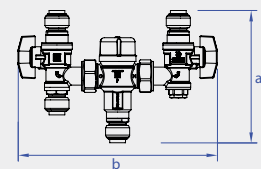

Size	Code
15mm	5A1564
22mm	5A1565

TMV 3/2 Filter Kit



Size	Code
15mm Filter Kit	5A1156
22mm Filter Kit	5A1157



**T111 UK
Scribe/deburrer**



Size	Code
10-28mm	46133

**T111 UK
Disconnecting
tool**



Size	Code
10mm	45970
12mm	45971
14mm	45972
15mm	45973
16mm	45974
18mm	45975
22mm	45977
28mm	45978

**DC/405
Disconnecting clip**

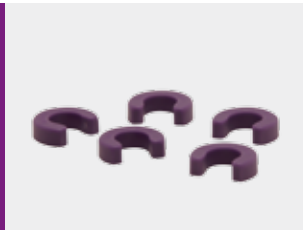

Size	Code
10mm	46100
12mm	46101
14mm	46102
15mm	46103
16mm	46104
18mm	46105
22mm	46107
28mm	46108

**DTX/305
Disconnecting
tool**

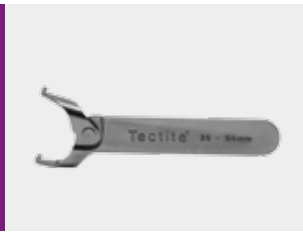

Size	Code
35-54mm	46145



T66 PEX liner

For insertion into tube



Size	Code
10mm	60100
15mm	60103
22mm	60105
28mm	60106

T67 Copper tube liner

For insertion into tube



Size	Code
10mm	60144

T110 Multipurpose tool Deburring/ depth gauge/scribe

for use with Tectite
CLASSIC, Tectite PRO &
316 up to 28mm



Size	Code
10 - 28mm	46132

T115 Multipurpose tool Deburring/ depth gauge/scribe

For use with Tectite
SPRINT



Size	Code
0-28mm	75640



**TC117
Depth gauge**

For use with
Tectite CARBON

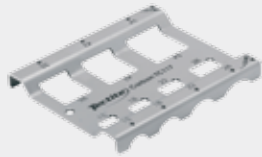

Size	Code
15-54mm	76121

**T120
Pipe clips, nail in**



Size	Code
10mm	60110
15mm	60111
22mm	60112
28mm	60113

**T121
Anti rotation clip**

For TX300



Size	Code
15mm	66006
22mm	66007
15mm	66006
22mm	66007

**T125
Bend former**

For use with PEX pipe



Size	Code
15mm	60130



T140 Pipe cutter - ratchet

For use with PEX pipe



Size	Code
10-28mm	60120

TCX End cap



Size	Code
35mm	46180
42mm	46181
54mm	46182

TDX Demounting end cap



Size	Code
35mm	46146
42mm	46151
54mm	46156

TX100 Replacement 'O' ring



Size	Code
35mm	46147
42mm	46148
54mm	46149

TX105/405 Replacement grab ring

For Tectite PRO



Size	Code
35mm	46135
42mm	46136
54mm	46137



TX106
Replacement grab ring
For Tectite 316



Size	Code
35mm	46183
42mm	46184
54mm	46185

S130
Silicone lubricant grease



Size	Code
100g Tub	39219

S120
Deburring Tool



Size	Code
N/A	39168

TC143
Internal swivel blade
Cobalt for use with TC147



Size	Code
All Tube Sizes	76200

S122
Tube preparation kit



Size	Code
35-54mm	39233

TC144
Internal swivel blade
Carbide BS2015
For use with TC147



Size	Code
All Tube Sizes	76201



TC145 External chamfer bit

For use with TC146
and TC148



Size

15-22mm

Code

76202

TC148 Noga 3000 handle

For use with TC145
and TC146



Code

76206

TC146 Rotodrive holder

For use with TC145
and TC148



Code

76203

TC150 Noga deburring kit

Contains TC148/TC146
and TC145



Code

76207

TC147 Noga 1000 handle

For use with TC143
and TC144

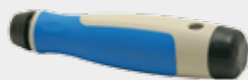

Code

76208

T141 Tectite tube cutter

For use with Tectite
Metal Tube

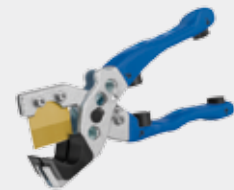

Code

44908



T150
Kalispeed calibration tool set
 Power click handle, calibrators and case for use with Tectite metal tube



Code	
44904	

T152
Kalispeed power click handle
 For use with T151



Code	
44901	

T151
Kalispeed single
 For use with T152



Size	Code
15mm	44902
22mm	44903

TBI
Internal bending spring



Size	Code
15mm	44930
22mm	44932

TC155
Carbon cutter wheel
 For use with Rems Cento



Code
76250

TBA
External bending spring



Size	Code
15mm	44931

Tube straightener



Size	Code
15mm	44905



3.0 TECHNICAL DATA

TUBE COMPATABILITY AND APPLICATIONS

FITTING AND TUBE COMPATABILITY

Tube/pipe type	Standard	Tectite Sprint	Tectite Classic	Tectite Pro	Tectite 316	Tectite Carbon	Tectite Air
Copper tube	BS EN 1057	✓	✓	✓	✓	-	✓
PB pipe (with liner)	BS 7291: Part 2	-	✓	✓	-	-	✓
PEX pipe (with liner)	BS 7291: Part 3	✓	✓	✓	-	-	✓
Stainless steel tube	EN 10312	-	-	-	✓	-	-
Carbon steel tube	EN 10305-2	-	-	✓	✓	✓	-
Plastic coated carbon steel tube	EN 10305-2	-	-	✓	✓	✓	-
Flexible metal tube	-	-	✓	✓	✓	-	-

It is advisable to make copper to steel connections via gunmetal/copper alloy fittings.

RECOMMENDED APPLICATIONS

Application	Tectite Sprint	Tectite Classic	Tectite Pro	Tectite 316	Tectite Carbon	Tectite Air
Commercial mechanical services						
Chilled	✓*	-	-	✓	✓†	-
Potable	✓	✓	✓	✓	-	-
Heating	✓	✓	✓	✓	✓	-
Hot water services	✓	✓	✓	✓	-	-
Food	-	-	-	✓	-	-
Brewery	-	-	-	✓	-	-
Gas	-	-	-	-	-	-
Domestic						
Potable	✓	✓	-	✓	-	-
Heating	✓	✓	-	✓	✓	-
Gas	-	-	-	-	-	-
Hot water services	✓	✓	-	✓	-	-
Cold water services	✓	✓	-	✓	-	-

* Brass adaptors not suitable for chilled water.

† Closed loop.



3.0 TECHNICAL DATA

MATERIALS SPECIFICATION AND MANUFACTURING STANDARDS

CONNECT + CONTROL

MATERIALS SPECIFICATION

Component	Tectite Sprint	Tectite Classic	Tectite Pro	Tectite 316	Tectite Carbon	Tectite Air
Body	Copper or DZR brass ¹	DZR brass	Stainless steel (316)	316 Stainless steel	Carbon steel (zinc plated)	DZR brass
'O' ring	EPDM*	EPDM*	EPDM*	EPDM*	EPDM*	NBR
Alignment ring	Glass filled nylon 6	Glass filled Nylon 6	Glass filled Nylon 6	Glass filled Nylon 6	Glass filled Nylon 6	Gas filled Nylon
Cartridge/ Demounting ring	-	Acetal copolymer	Up to 28mm cartridge ring brass tin plated	Up to 28mm cartridge ring brass	N/A	Acetal copolymer
Grab ring	Stainless steel (316)	Stainless steel	Stainless steel (Kolsterised)	Stainless steel	Stainless steel	Stainless steel
35-54mm End Cap	-	-	High performance nylon	High performance nylon	-	-
Shim	-	-	-	-	Mild steel (Zinc plated)	-

BNB. The 'O' ring in all Tectite fittings is manufactured from Ethylene Propylene Diene Monomer (EPDM) and is supplied lubricated for easy tube insertion.

* Ethylene Propylene Diene Monomer.

¹ Threaded fittings are DZR brass.

MANUFACTURING STANDARDS

Component	Standard	Summary	Tectite Sprint	Tectite Classic	Tectite Pro	Tectite 316	Tectite Carbon	Tectite Air
Taper end thread	ISO 7/EN10226-1 (formerly BS 21/ ISO 7)	Pipe-threads, where pressure-tight joints are made on the threads (metric dimensions)	✓	✓	✓	✓	✓	✓
Parallel end thread	BS EN ISO 228:2003 (formerly BS 2779/ ISO R228/1)	Pipe-threads, where pressure-tight joints are not made on the threads (metric dimensions)	✓	✓	✓	✓	✓	✓

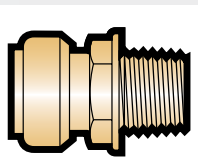

MALE CONNECTORS

Tectite male connectors have either taper male BSP threads to ISO 7 (formerly BS 21) or parallel BSP threads to BS EN ISO 228:2003. Inert jointing compounds or PTFE tape should be applied to taper threads and good quality jointing washers should be used with parallel threaded fittings.

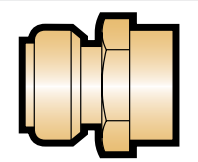

FEMALE CONNECTORS

Tectite female threaded connectors have internal parallel threads to BS EN ISO 228:2003.



3.0 TECHNICAL DATA

WORKING TEMPERATURES AND PRESSURE TABLES

The maximum temperature and pressure range in any system is dictated by the component with the lowest performance rating. Remember to pressure test all systems thoroughly after completion. Tectite installations may be tested to 1.5 times their normal working pressure at ambient temperature.

ACHIEVING LOW TEMPERATURES

For products used in water systems, working temperatures of less than 4°C can only be achieved if antifreeze is added to the system.

PRESSURE EQUIPMENT DIRECTIVE

From 30th May 2002 most pressure equipment and assemblies on the market in the United Kingdom must comply with the Pressure Equipment Directive (PED) 1999. Fittings are exempt from the PED unless they are incorporated into pressure equipment falling within its scope. XPress valves are also exempt.

For a detailed explanation please visit:

www.peglyorkshire.co.uk/technical.cfm

CE marking

CE marking is a manufacturers' declaration that their product complies with the essential requirements of all relevant European Directives and Regulations.

From 1 July 2013 manufacturers in Europe must comply with the Construction Products Regulations (EU) 305/2011. This regulation requires manufacturers to apply CE marking if their product is covered by a harmonised European Standard (hEN) or a European Technical Assessment (ETA).

At the time of going to print, there are currently no hENs or ETAs which apply to XPRESS, TECTITE, HENCO, YORKSHIRE, ENDEX, KUTERLITE, tube or fitting product ranges and consequently no requirement for CE marking. For more updated information please visit

www.peglyorkshire.co.uk

or www.gov.uk/cemarking

TECTITE WORKING TEMPERATURES AND PRESSURE TABLE

Tectite fitting	Tube/pipe used with	Minimum				Maximum			
		°C	Bar	°C	Bar	°C	Bar	°C	Bar
Classic	Copper	-24*	16	30	16	65	10	95	6
	Flexible metal	-20*	16	30	16	65	10	95	6
	PEX/PB	-20*	12	20	12	65	6	92	3
Sprint	Copper	-24*	20	30	20	65	16	114	10
	PEX/PB	-20*	12	20	12	65	6	92	3
Pro (≤ 28mm)	Copper	-24*	20	30	20	65	16	114	10
Pro (≥ 35mm)	Copper	-24*	16	30	16	65	10	90	6
316 (≤ 28mm)	Stainless steel	-24*	20	30	20	65	16	114	10
316 (≥ 35mm)	Stainless steel	-24*	16	30	16	65	10	90	6
Carbon	Carbon steel	-24*	20	30	20	65	16	114	10
Air	Copper	-24*	16	30	16	65	10	95	6
	PEX/PB	-20*	12	20	12	65	6	92	3

TECTITE CLASSIC AND PRO FLEXIBLE HOSE/TAP CONNECTOR WITH COPPER TUBE

15mm	-20	16	30	16	65	10	90	6
22mm	-20	10	30	10	65	10	90	6



NOTE: *Female T, TX and TT fittings to be DENSO® wrapped to avoid failure.



TECTITE VALVES

Tectite fitting	Tube/pipe used with	Minimum				Maximum			
		°C	Bar	°C	Bar	°C	Bar	°C	Bar
TX300/PT550	Copper/ Stainless Steel/ Carbon Steel	-10	20	30	20	65	16	114	10
	Flexible metal	-10	16	30	16	65	10	95	6
	PEX/PB	-10	12	20	12	65	6	92	3
TX480 T809,T,B	Copper	-10	16	30	16	65	10	95	6
	Flexible metal	-10	16	30	16	65	10	95	6
	PEX/PB	-10	12	20	12	65	6	92	3
TX802	Copper/ Stainless Steel/ Carbon Steel	-10	10	30	10	65	10	90	10
	Flexible metal	-10	10	30	10	65	10	80	10
	PEX/PB	-10	10	30	10	65	6	80	3
PT5PRV	Copper/ Stainless Steel/ Carbon Steel	-10	1	20	1	65	16	65	16
	Flexible metal	-10	1	20	1	65	16	65	16
	PEX/PB	-10	1	20	1	65	16	65	16

All performance figures based on correct assembly of fittings and tube/pipe as detailed in installation instructions. Lower temperatures are achievable using Tectite valves but you must first contact Pegler Yorkshire technical department to verify suitability of glycol mix. ■ TX405 Minimum/Maximum "COLD" inlet temperature and pressure TX405 ■ Minimum/Maximum "HOT" inlet temperature and pressure NB: Please refer to page XX for further detailed performance data on the TX405.



EQUIPOTENTIAL BONDING

It is the installers duty to ensure that all metallic pipework systems should comply with the equipotential bonding requirements of the current edition of the IEE electrical wiring regulations (BS 7671 1992).

After all plumbing work has been completed, always ensure continuity checks are conducted by a qualified electrician in accordance with regulations.



3.0 TECHNICAL DATA

TUBES, PIPE AND THEIR COMPATIBILITIES

COPPER TUBE

Compatible copper tube must meet the requirements of BS EN 1057 for copper and copper alloy - seamless round copper tubes for water (and gas) in sanitary and heating applications.

BS EN 1057 includes specified temper conditions (material strength) expressed as an 'R' number. Quite simply, the higher the number, the harder the material. As a result, tube diameter, wall thickness, length and the material temper must all be specified for full product designation.

All Tectite 316 fittings can be used with copper tube, although in humid conditions some staining of the tube may be witnessed (see page 57 Phenolic foam section for details on moisture-proof insulation).

Yorkex* copper System tube is manufactured to the same standards as above and offers the same features and benefits.

*Yorkex is a brand name of Yorkshire Copper Tube.



TECTITE FLEXIBLE METAL TUBE

Features an outer and inner layer manufactured from cross-linked high density polymer (PE-Xc) bonded to a middle layer of butt-welded aluminium. Available in both 15 and 22mm sizes, Tectite Flexible metal tube comes in straight lengths of 3m and coils of 25m, 50m and 400m. It is suitable for used with Tectite classic fittings when used in conjunction with TectSEAL 3PS liner.

DIMENSIONS OF TECTITE FLEXIBLE METAL TUBE

Barrier Layer (mm)	
A	
0.4	
0.4	
Diameter (mm)	
Od	1D
15.0	11.3
22.0	17.6

COPPER TUBE BS EN 1057 COMPATABILITY

Tectite Sprint, Tectite Classic and Tectite Pro fittings. All tube tempers (R220, R250 and R290) are available in all the designated wall thicknesses.

Outside diameter	Wall thickness (mm)							
	0.6	0.7	0.8	0.9	1.0	1.2	1.5	2.0
10mm	✓	✓	✓	-	✓	-	-	-
12mm	✓	-	✓	-	✓	-	-	-
15mm	-	✓	-	-	✓	-	-	-
22mm	-	-	-	✓	✓	✓	-	-
28mm	-	-	-	✓	✓	✓	✓	-
35mm	-	-	-	-	-	✓	✓	-
42mm	-	-	-	-	-	✓	✓	-

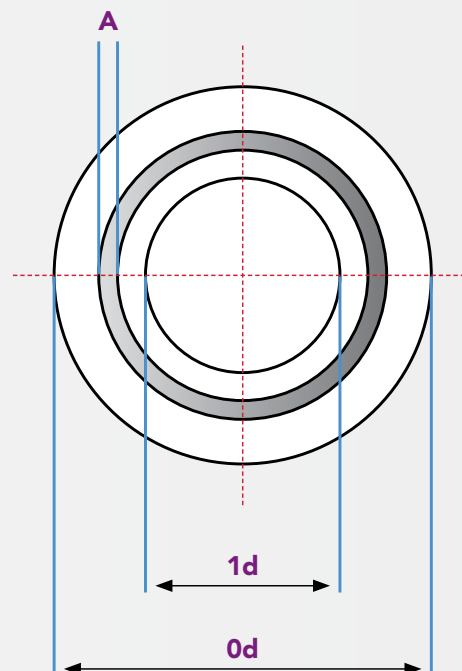



CONNECT + CONTROL

TECTITE-PEX BARRIER PIPE

Tectite-PEX is a high-integrity cross-linked polyethylene barrier pipe. Available in sizes from 10mm to 28mm in 3m straight lengths or 25m, 50m and 100m coils, it is suitable for use with Tectite Sprint and Tectite Classic fittings (use with T66 liners). You can use Tectite Sprint and Tectite Classic fittings on all PEX plastic pipes which meet BS 7291: Part 3 (use with appropriate manufacturers' liners). Tectite 316 fittings cannot be used with plastic pipes.



For the ultimate in convenience, our Tectite Sprint and Tectite Classic ranges of fittings can also be used with PB pipe that conforms to BS 7921: Part 2 (use with appropriate manufacturers' liners).

At the heart of Tectite-PEX is an EVOH (ethylene vinyl alcohol) resin oxygen barrier found centrally within the pipe wall. This barrier inhibits the ingress of oxygen - vital in central heating applications where permeation of oxygen into the system can cause radiator corrosion.

FLEXIBILITY

Tectite-PEX is flexible enough to be cabled around obstructions and through joists with ease, saving on time and materials. The product's flexibility also allows it to absorb energy and so reduce noise from water hammer and thermal movement.

The pipe's low thermal conductivity means exposed pipework in central heating systems is cooler to the touch than other materials. It is resistant to limescale and all-but eliminates the threat of burst pipes in cold conditions.

Lightweight and convenient to handle and store, Tectite-PEX can be painted with either emulsion or oil-based gloss paints (NOT cellulose paint). Care must be taken to ensure that no paint comes into contact with Tectite fittings.

INSTALLATION

When installing Tectite-PEX, always remember to observe minimum bend radii to avoid kinking of the pipe. The Tectite accessories range includes a bend former for tight bends.

TECTITE-PEX BENDS

Size	Minimum radius
10mm	45mm using T120 clips
15mm	100mm using T120 clips, 90mm using T125 bend former brackets
22mm	175mm using T120 clips
28mm	300mm using T120 clips

STANDARDS AND APPROVALS

Tectite PEX adheres to all major trade specifications as follows:

BS 7291: Specification for thermo-plastic pipes and associated fittings for hot and cold water for domestic purposes and heating installations in buildings.

BS 7291: Part 1 General requirements.

BS 7291: Part 3 Specification for cross-linked polyethylene (PEX) pipes and associated fittings.



Kitemark approved

All Tectite PEX barrier pipe is Kitemark approved.

WRAS Tectite PEX complies with The Water Supply (Water Fittings) Regulations 1999.

DIN Tectite PEX barrier pipe fully meets the requirements of DIN 16892.

Tectite PEX adheres to all major trade specifications as follows:

BS 7291: Specification for thermo-plastic pipes and associated fittings for hot and cold water for domestic purposes and heating installations in buildings.

BS 7291: Part 1 General requirements.

BS 7291: Part 3 Specification for cross-linked polyethylene (PEX) pipes and associated fittings.

TECTITE-PEX BARRIER PIPE TOLERANCES

Dimensions	1.6mm	1.6mm	2.1mm	2.7mm
12mm ± 0.1mm	-0.1mm	-	-	-
15mm ± 0.1mm	-	-0.1 +0.2mm	-	-
22mm ± 0.1mm	-	-	-0.1+0.2mm	-
28mm ± 0.1mm	-	-	-	-0.1 +0.2mm



Kitemark approved

All Tectite PEX barrier pipe is Kitemark approved.

WRAS Tectite PEX complies with The Water Supply (Water Fittings) Regulations 1999.

DIN Tectite PEX barrier pipe fully meets the requirements of DIN 16892.



3.0 TECHNICAL DATA

TUBES, PIPE AND THEIR COMPATIBILITIES

STAINLESS STEEL 316 SYSTEM TUBE

Specially designed to be used with Tectite 316 stainless steel fittings, 316 System tube is available in 6m straight lengths in sizes from 15mm to 54mm. The tube is manufactured from BS 316 S31/DIN 1.4401 stainless steel strip conforming to BS10088 Part 2 and thanks to its thin-walled geometry, is stiff, lightweight and easy to handle.



Tectite 316 fittings are also compatible with stainless steel tubes to BS EN 10312 (encompassing the former BS 4127) and DVGW GW541.

STAINLESS STEEL 316 SYSTEM TUBE: SPECIFIC

Wall thickness EN 10312 Table 1			
Outside diameter	316 System tube	GW541 Table 2 (formerly BS 4127)	EN 10312 Table 2 GW541 Table 3
15mm	0.6mm	0.6mm	1.0mm
18mm	0.7mm	0.7mm	1.0mm
22mm	0.7mm	0.7mm	1.2mm
28mm	0.8mm	0.8mm	1.2mm
35mm	1.0mm	1.0mm	1.5mm
42mm	1.0mm	1.1mm	1.5mm
54mm	1.0mm	1.2mm	1.5mm

! NOTE: Tectite fittings can also be used with copper tube to the above standards, in which case a 25 year guarantee will apply.

XPRESS GALVANISED CARBON STEEL SYSTEM TUBE AND PLASTIC COATED CARBON STEEL SYSTEM TUBE

Carbon steel System tube from our XPress range is available in 3m and 6m straight lengths in sizes from 15mm to 108mm (54mm if plastic coated). Galvanised carbon steel System tube is manufactured in accordance with EN 10305-3 from material with a very low carbon content and has a thin walled profile resulting in a lightweight easier to handle product.



The galvanised coating (external only) has a minimum thickness of 7 microns and is thermally applied which provides a superior bond to the tube.

Tectite Advance can be used with our SC640 galvanised carbon steel System tube or our SC660 plastic coated carbon steel System tube.

XPRESS GALVANISED CARBON STEEL TUBE: SPECIFICATION

Wall thickness EN 10312 Table 1			
Outside diameter	Outside diameter including plastic coating	Galvanised tube	Including plastic coating
15mm	17mm	1.2mm	2.2mm
18mm	19mm	1.2mm	2.2mm
22mm	24mm	1.5mm	2.5mm
28mm	30mm	1.5mm	2.5mm
35mm	37mm	1.5mm	2.5mm
42mm	44mm	1.5mm	2.5mm
54mm	56mm	1.5mm	2.5mm

CARBON STEEL SYSTEM TUBE: BENDS

Size	Minimum Radii
15mm	30mm
18mm	36mm
22mm	44mm

In sizes up to 28mm carbon steel System tube, is suitable for bending using proprietary bend formers.

! NOTE: Tectite fittings can also be used with copper tube to the above standards, in which case a 25 year guarantee will apply.



3.0 TECHNICAL DATA

SYSTEM DESIGN CONSIDERATIONS AND TUBE EXPANSION

CONNECT + CONTROL

The following are some of the specific design considerations it is important to take account of when designing and installing pipework systems containing Tectite fittings.

THERMAL MOVEMENT

Thermal movement is a major consideration when designing plumbing and heating systems. Pipework systems expand and contract with changes in temperature. If they are fixed too rigidly and their movement restricted, the systems will be subject to stress which must be avoided. So it's important to take the effect of thermal movement into account when designing or installing a system.

It's especially important to avoid stress concentrations between

fixed points typically found at radiators, valves and other fittings. However, the ability of Tectite joints to rotate will accommodate movement within the system associated with expansion and contraction in certain design configurations.

The following tables show thermal expansion details for a range of tube/pipe lengths and temperature changes. For further calculations please refer to the Pegler Yorkshire System Design Document or visit the website.

TECTITE CLASSIC: TECTITE FLEXIBLE METAL TUBE EXPANSION

Temperature difference	Pipe length									
	1m	2m	3m	4m	5m	6m	7m	8m	9m	10m
10°C	0.25	0.50	0.75	1.00	1.25	1.50	1.75	2.00	2.25	2.50
20°C	0.50	1.00	1.50	2.00	2.50	3.00	3.50	4.00	4.50	5.00
30°C	0.75	1.50	2.25	3.00	3.75	4.50	5.25	6.00	6.75	7.50
40°C	1.00	2.00	3.00	4.00	5.00	6.00	7.00	8.00	9.00	10.00
50°C	1.25	2.50	3.75	5.00	6.25	7.50	8.75	10.00	11.25	12.50
60°C	1.50	3.00	4.50	6.00	7.50	9.00	10.50	12.00	13.50	15.00
70°C	1.75	3.50	5.25	7.00	8.75	10.50	12.25	14.00	15.75	17.50
80°C	2.00	4.00	6.00	8.00	10.00	12.00	14.00	16.00	18.00	20.00

TECTITE SPRINT, TECTITE CLASSIC AND TECTITE PRO: COPPER TUBE EXPANSION

Temperature change	Tube length									
	3m	4m	5m	6m	7m	8m	9m	10m	12m	25m
10°C	0.5mm	0.7mm	0.9mm	1.0mm	1.2mm	1.4mm	1.5mm	1.7mm	2.0mm	4.3mm
20°C	1.0mm	1.4mm	1.7mm	2.0mm	2.4mm	2.7mm	3.0mm	3.4mm	4.0mm	8.5mm
30°C	1.5mm	2.0mm	2.6mm	3.1mm	3.6mm	4.1mm	4.6mm	5.1mm	6.1mm	13mm
40°C	2.0mm	2.7mm	3.4mm	4.1mm	4.8mm	5.4mm	6.1mm	6.8mm	8.2mm	17mm
50°C	2.6mm	3.4mm	4.3mm	5.1mm	6.0mm	6.8mm	7.7mm	8.5mm	10.2mm	21mm
60°C	3.1mm	4.1mm	5.1mm	6.1mm	7.1mm	8.2mm	9.2mm	10.2mm	12.2mm	26mm
70°C	3.6mm	4.8mm	6.0mm	7.1mm	8.3mm	9.5mm	10.7mm	11.9mm	14.3mm	30mm
80°C	4.1mm	5.4mm	6.8mm	8.2mm	9.5mm	10.9mm	12.2mm	13.6mm	16.3mm	34mm
90°C	4.6mm	6.1mm	7.7mm	9.2mm	10.7mm	12.2mm	13.8mm	15.3mm	18.4mm	38mm
100°C	5.1mm	6.8mm	8.5mm	10.2mm	11.9mm	13.6mm	15.3mm	17.0mm	20.4mm	43mm

TECTITE SPRINT, TECTITE CLASSIC AND TECTITE PRO: PEX BARRIER PIPE EXPANSION

Upper working temperature	Lower working temperature									
	0°C	10°C	20°C	30°C	40°C	50°C	60°C	70°C	80°C	90°C
90°C	17.6mm	16.4mm	15.1mm	13.5mm	11.6mm	9.4mm	7.4mm	5.0mm	2.6mm	0.0mm
80°C	15.0mm	13.8mm	12.5mm	10.9mm	9.0mm	6.8mm	4.8mm	2.4mm	0.0mm	-
70°C	12.6mm	11.4mm	10.1mm	8.5mm	6.6mm	4.0mm	2.4mm	0.0mm	-	-
60°C	10.2mm	9.0mm	7.7mm	6.1mm	4.2mm	2.0mm	0.0mm	-	-	-
50°C	8.2mm	7.0mm	5.7mm	4.1mm	2.2mm	0.0mm	-	-	-	-
40°C	6.0mm	4.8mm	3.5mm	1.9mm	0.0mm	-	-	-	-	-
30°C	4.1mm	2.9mm	1.6mm	0.0mm	-	-	-	-	-	-
20°C	2.5mm	1.3mm	0.0mm	-	-	-	-	-	-	-
10°C	1.2mm	0.0mm	-	-	-	-	-	-	-	-
0°C	0.0mm	-	-	-	-	-	-	-	-	-



3.0 TECHNICAL DATA

SYSTEM DESIGN CONSIDERATIONS AND TUBE EXPANSION

TECTITE 316: STAINLESS STEEL SYSTEM TUBE EXPANSION

Temperature change	Tube length									
	3m	4m	5m	6m	7m	8m	9m	10m	12m	25m
10°C	0.5mm	0.6mm	0.8mm	1.0mm	1.1mm	1.3mm	1.4mm	1.6mm	1.9mm	4.0mm
20°C	1.0mm	1.3mm	1.6mm	1.9mm	2.2mm	2.6mm	2.9mm	3.2mm	3.8mm	8.0mm
30°C	1.4mm	1.9mm	2.4mm	2.9mm	3.4mm	3.8mm	4.3mm	4.8mm	5.8mm	12.0mm
40°C	1.9mm	2.6mm	3.2mm	3.8mm	4.5mm	5.1mm	5.8mm	6.4mm	7.7mm	16.0mm
50°C	2.4mm	3.2mm	4.0mm	4.8mm	5.6mm	6.4mm	7.2mm	8.0mm	9.6mm	20.0mm
60°C	2.9mm	3.8mm	4.8mm	5.8mm	6.7mm	7.7mm	8.6mm	9.6mm	11.5mm	24.0mm
70°C	3.4mm	4.5mm	5.6mm	6.7mm	7.8mm	9.0mm	10.1mm	11.2mm	13.4mm	28.0mm
80°C	3.8mm	5.1mm	6.4mm	7.7mm	9.0mm	10.2mm	11.5mm	12.8mm	15.4mm	32.0mm
90°C	4.3mm	5.8mm	7.2mm	8.6mm	10.1mm	11.5mm	13.0mm	14.4mm	17.3mm	36.0mm
100°C	4.8mm	6.4mm	8.0mm	9.6mm	11.2mm	12.8mm	14.4mm	16.0mm	19.2mm	40.0mm

TECTITE PRO*, TECTITE 316* AND TECTITE AIR*:

GALVANISED CARBON STEEL SYSTEM TUBE AND PLASTIC COATED CARBON STEEL SYSTEM TUBE EXPANSION

Temperature change	Tube length									
	3m	4m	5m	6m	7m	8m	9m	10m	12m	25m
10°C	0.4mm	0.5mm	0.6mm	0.7mm	0.8mm	1.0mm	1.1mm	1.2mm	1.4mm	3.0mm
20°C	0.7mm	1.0mm	1.2mm	1.4mm	1.7mm	1.9mm	2.2mm	2.4mm	2.9mm	6.0mm
30°C	1.1mm	1.4mm	1.8mm	2.2mm	2.5mm	2.9mm	3.2mm	3.6mm	4.3mm	9.0mm
40°C	1.4mm	1.9mm	2.4mm	2.9mm	3.4mm	3.8mm	4.3mm	4.8mm	5.8mm	12.0mm
50°C	1.8mm	2.4mm	3.0mm	3.6mm	4.2mm	4.8mm	5.4mm	6.0mm	7.2mm	15.0mm
60°C	2.2mm	2.9mm	3.6mm	4.3mm	5.0mm	5.8mm	6.5mm	7.2mm	8.6mm	18.0mm
70°C	2.5mm	3.4mm	4.2mm	5.0mm	5.9mm	6.7mm	7.6mm	8.4mm	10.1mm	21.0mm
80°C	2.9mm	3.8mm	4.8mm	5.8mm	6.7mm	7.7mm	8.6mm	9.6mm	11.5mm	24.0mm
90°C	3.2mm	4.3mm	5.4mm	6.5mm	7.6mm	8.6mm	9.7mm	10.8mm	13.0mm	27.0mm
100°C	3.6mm	4.8mm	6.0mm	7.2mm	8.4mm	9.6mm	10.8mm	12.0mm	14.4mm	30.0mm

INSULATION

For all Tectite Systems, we recommend you adhere to the insulation requirements as specified by the Water Supply (Water Fittings) Regulations and Building Regulations 1999. These requirements are equally applicable to plastic pipe and stainless steel tube.

Pegler Yorkshire would always recommend that any insulation should be fitted in accordance with:

The Code of Practice BS5970:2012

- Thermal Insulation of Pipework, ductwork, associated equipment and other industrial installations in the temperature range of -100°C to +870° C.

Additional guidance can be found on an insulation manufacturer website.

We have the following specific recommendations for Tectite systems:

Every effort should be made to ensure that the pipework and fittings are clean and dry prior to the fitment of insulation. To help to achieve this, the avoidance of water based media for leak detection should be considered.

Where Carbon Steel systems are used every effort should be made to protect the system from both internal and external corrosion. Both fittings and tubing should be stored undercover in a clean dry environment prior to installation.

Special consideration should be given to the effects of condensation on fittings and pipework. This may be caused by surrounding works during the construction cycle and not by the system itself.

The choice of insulation system should not be considered as the only means of preventing corrosion, the specifier must consider the whole process and the potential risk of corrosion taking place.

After initial installation, suitable vapour barriers need to be considered to ensure that NO WATER INGRESS is allowed to permeate the insulation.

Xpress Carbon and Tectite Carbon systems should not be installed in externally or exposed locations without due consideration to weathering protection. We would recommend that Stainless Steel or Xpress Copper be used for such applications.

PHENOLIC FOAM

When using rigid phenolic foam (or other thermal insulation) to lag pipework, always remember to refer to the lagging manufacturer's fixing instructions. To avoid the risk of external corrosion of copper pipework lagged with this foam, the European Phenolic Foam Association recommend that such insulation products be installed with a moisture barrier. As a precautionary measure, Pegler Yorkshire does not recommend any anti-corrosion materials containing a mineral oil base are applied around the mouth of the fitting and this should instead be protected using silicon grease (or similar) to form the atmospheric barrier between the metal and the foam insulation.



An alternative would be to use an impervious material, such as PVC tape. This needs to be applied to the mouth of the fitting before applying any mineral oil-based materials. If a grease-free installation is preferred then butyl tape can be used to provide a vapour barrier.

Some manufacturers of this type of lagging supply their products with an internal, factory-applied silicate barrier to prevent external corrosion problems.

Maximum spacing of support brackets for 316 System tube, BS 4127 and W541 stainless steel tube and plastic coated and galvanised carbon steel tube		
Size	Horizontal pitch	Vertical pitch
15mm	1.80m	2.00m
18mm	2.10m	2.30m
22mm	2.40m	3.00m
28mm	2.40m	3.00m
35mm	2.70m	3.00m
42mm	3.00m	3.60m
54mm	3.00m	3.60m

Maximum spacing of support brackets for copper tube to BS EN 1057				
Size	Wall thickness	Temper	Horizontal pitch	Vertical pitch
12mm	0.7mm	R250/R290	1.00m	1.50m
15mm	0.7mm	R250/R290	1.20m	1.80m
15mm	1.0mm	R250/R290	1.20m	1.80m
22mm	0.9mm	R250/R290	1.80m	2.40m
22mm	1.0mm	R250/R290	1.80m	2.40m
22mm	1.2mm	R250/R290	1.80m	2.40m
28mm	0.9mm	R250/R290	1.80m	2.40m
28mm	1.0mm	R250/R290	1.80m	2.40m
28mm	1.2mm	R250/R290	1.80m	2.40m
28mm	1.5mm	R250/R290	1.80m	2.40m
35mm	1.0mm	R250/R290	2.40m	3.00m
35mm	1.2mm	R250/R290	2.40m	3.00m
35mm	1.5mm	R250/R290	2.40m	3.00m
42mm	1.0mm	R250/R290	2.40m	3.00m
42mm	1.2mm	R250/R290	2.40m	3.00m
42mm	1.5mm	R250/R290	2.40m	3.00m
54mm	1.0mm	R250/R290	2.70m	3.00m
54mm	1.2mm	R250/R290	2.70m	3.00m
54mm	2.0mm	R250/R290	2.70m	3.00m

THERMAL EXPANSION

When including expansion joints in a system take care not to introduce tensional stress when assembling and tightening threaded connections.

CORRECT ANCHORING

Always ensure the spur used to anchor the branch of a tee or connecting a radiator is long enough to allow normal thermal movement. Forgetting to observe this simple rule can lead to a failure. Incorporating expansion loops or bellow devices into the system can help guard against such problems, whilst a horseshoe link or offset (see diagrams) is an ideal way to counteract continual thermal cycling.

PIPE RESTRAINT

In any installation, the system should be supported to ensure the minimum stress is imposed on the tube/pipe and joints. For the maximum spacing of supporting brackets for internal installations, please see the tables (opposite).

LOCAL WATER AUTHORITY

We recommend consulting the local water authority when it comes to pipework accessibility.

BUILDING IN DIMENSIONS

All building in dimensions are correct at the time of going to press. Pegler Yorkshire reserves the right to change these dimensions without prior notice, however to ensure you are using the most up to date information please refer to our web site www.pegler-yorkshire.co.uk

COVERED PIPEWORK

Making provision for thermal movement is vital where pipework of any material is installed under screed or plaster or passes through brick or blockwork. The preferred practice is to use tubing with factory applied protective plastic covering incorporating air gaps to accommodate thermal movement or to pass tubes and pipes through sleeves or conduits or to lay them in ducts surrounded by loose, inert non-rigid material such as vermiculite or glass wool. For further information, consult the publication BS 66.700:2006 Design, installation, testing and maintenance of services supplying water for domestic use within buildings their curtilages.

FLUSHING

The main objective of the flushing process is to remove as much dirt and debris from the pipework system as possible in order to reduce the likelihood of system blockage and to create the best possible circumstances for a successful chemical clean and subsequent water treatment regime so that any hygiene problems and corrosion damage within a system are largely prevented.

The level of cleanliness achievable by system flushing is very much dependant on the adequacy of the system design and installation with regard to flushing. Provision should be included in the system for adequate air venting, draining and bypassing of equipment.

Consideration should be given to the 'Flushing Velocity' and should be based on the largest pipe size in the system section to be flushed.



3.0 TECHNICAL DATA

SYSTEM DESIGN CONSIDERATIONS AND TUBE EXPANSION

The water velocity required for flushing must be sufficient to pick up and carry the majority of the dirt and debris from within the system.

The hot and cold water pipelines should be flushed separately. For details, please refer to the BSRIA Guide BG29-2012 'Pre-Commissioning Cleaning of Pipework Systems'.

Some contracts may still require that proprietary chemicals are used to cleanse and flush pipework before full commissioning. Tectite is compatible with a wide selection of products. To find out more contact us.

General Consideration

All items that are sensitive to sediment must remain valved off and by-passed throughout the flushing procedure. Care should be taken to ensure that pumps are not allowed to operate against a closed head for long periods. This situation should be avoided whenever possible.

CHEMICAL CLEANING

Chemical cleaning should always be carried out immediately after flushing.

Chemical cleaning of the system should always be the responsibility of the appointed chemical cleaning specialist and should be preceded by a properly executed clean water flushing as described in the previous section. This is an essential prerequisite to any effective chemical cleaning programme.

There are many proprietary cleaning chemicals available for preparing the pipework for subsequent service. Some of these are acidic, others are neutral but all must be capable of effectively removing any rust and other debris that has formed in the pipework prior to commissioning, without damaging the various components in the system.

Strong acid cleaners that do not contain inhibitor must be avoided as severe internal wastage may occur, particularly at joints between tube and fitting.

Irrespective of whatever cleaner is chosen, the manufacturer's instructions must be followed exactly, taking particular care to ensure that cleaning agents are completely flushed out of the system before adding any protective inhibitors to the water.

Please refer to BSRIA BG29 2012 'Pre-Commission Cleaning of Pipework Systems'.

As this is specialist work, it should only be entrusted to an organisation that has the facilities, safety training and experience in dealing with the potentially hazardous chemicals involved. Suitably qualified personnel will have the knowledge to be able to offer advice on the selection and use of appropriate chemicals, as well as the safe disposal of waste material.

PRESSURE TESTING OF PIPEWORK SYSTEMS

It is recommended that completed pipework systems are pressure tested prior to being covered (insulation, or paint), and should be performed prior to commencing the cleaning procedure.

The entire system should be pressure tested in accordance of BSRIA and B&ES.

This pressure test can be both pneumatic and hydraulic and is determined by the installed and planned commissioning regime.

If the pipe system is to be left empty after the pressure test, then a pressure test with dry air and/or inert gas should be performed, (microbiological contamination through bacteria and corrosion of carbon steel systems has to be avoided).

The pressure test should consist of two steps;

- ✚ Leak test
- ✚ Tightness test

The leak test involves inspecting the system for joint integrity (tightness), the tightness test focuses on checking the system for strength.

The tightness test with water is described in the B&ES Guide to Good Practice TR/6, BS EN 806-4, BS6700.

If pre-fabricated pipework or equipment has been hydraulically pressure tested, off site prior to installation, this should be notified to the cleaning/chemical treatment specialist as these may have already developed an internal layer of corrosion, microbiological, biofilm build up etc.

Due to the inherent dangers associated with pneumatic testing using inert gas or dry air a responsible person must be in charge of this operation at all times.

The following must be understood as a recommendation only.

BASIC PROCEDURE

If the system is to be pressure tested (as recommended) then the following procedure applies to each section in turn.

1. Test Preparation

- a. Check that all high points have suitable vents to facilitate removal of air during filling and that these are all closed.
- b. Install suitable drainage facilities at all low points for drainage.
- c. Blank plug or seal any open ends and close all valves at the limits of the test section of the piping
- d. Remove, blank off all terminal units that may be damaged by the test pressure.
- e. Open all valves within the enclosed test section.
- f. Check that the test gauge is working correctly and has been calibrated, and has the correct range.
- g. If the compressed dry air or inert gas is at a higher pressure than is required for the test (maximum 0.5bar pressure) a pressure reducing valve, pressure gauge and pressure relief valve set to open at the test pressure should be fitted to the connecting pipework.
- h. If possible the compressed air supply should be outside the test area
- i. Check that there is a suitable method for draining the system.

It is recommended that systems be tested with a nitrogen rich (90%)/air mixture. If air is to be used it should be clean, dry and free from oil, the drying performance should conform to 'purity class 3 under the ISO 8573' for particulate contamination, water and oil content.



Guidance should be sought from the relevant compressor manufacturer.

Excessive oil carry over in compressed air may be detrimental to the EPDM seals as well as causing bacteriological issues. Pure Nitrogen is also acceptable but consideration should be taken of HSE guidelines or recommendations.

2. Pneumatic Pressure Testing

- a. An initial low-pressure test at 0.5 bar is to be carried out, having put the necessary safety measures in place, to enable any leaks to be found.
Significantly leaking, un-pressed or damaged joints shall be replaced, but those with low leakage rates should be identified for close inspection during the high-pressure test.
- b. This test pressure is to be maintained / pumped for a period of 30 minutes minimum.
- c. The test is passed if the pressure in the system is maintained for one hour and there is no visible leakage throughout the test.
- d. If required, a signature should be obtained on a test certificate.
- e. After testing, safely release the pressure, if necessary ensure that all vents on cylinder tanks and pressure vessels are opened to atmosphere BEFORE draining down and refitting vulnerable items.

These test times may vary according to the pipework system (plastic pipe systems may take longer to achieve stable pressures).

Water Regulation 12 requires 'that the water system shall be capable of withstanding an internal water pressure not less than 1.5 times the maximum pressure to which the installation or relevant part is designed to be subjected to in operation'.

When hydraulic testing is undertaken then the following should be carried out.

The test water should contain anti-corrosion inhibitors / long lasting biocide chemicals with the intention that post testing the system shall be left completely full of the test water (suitable protection against freezing and the onset of biological growth will also have to be considered). Circulation of the system test is strongly recommended.

If leaving the system full of water is not practical then every effort shall be made to fully drain and dry the pipe work by purging with dry air/nitrogen. If the system is to be left not in use for longer than 5 days, we recommend that the system be left charged with an inert gas to reduce the risk of onset corrosion and /or bacterial growth.

Do not leave a Carbon Steel system empty without drying as oxygen will begin to corrode the internal surface.

Inspection of the internal condition to the pipework is recommended so that the water treatment specialist understands the correct process required when cleaning.

3. Hydraulic Pressure Testing

- a. Start to fill the system and 'walk' the route of the pipework being tested. Visually checking for leaks and listening for the sound of escaping air.
- b. Release air from all the high points systematically through the system to ensure the system is completely filled with water. (The full loading of the o rings often resolves small leaks identified during the 0.5 bar test).
- c. Turn the pump on to allow the system water to circulate to help reduce the risk of trapped air, bleed the system if necessary. Turn off the pump set when completed.
- d. Check the system contains the correct amount of inhibitors and biocides.
- e. Using an independent pump set, progressively increase the pressure until the system pressure achieves 1.5 times normal working pressure, (verify that this pressure is within the capability of the system components), record the test pressure.
- f. Leave the system for 30 minutes minimum.
- g. The test is passed if the pressure in the system is maintained for the next one hour and there is no visible leakage throughout the test.
- h. Leaking joints at this stage should be identified and marked for replacement.
- i. The system pressure should then be reduced to 0.5 bar again to confirm that no persistent low-pressure leaks are present.

Further information can be found in;

Guides issued by BSRIA, B&ES, CIBSE, WRAS and the Copper Development Association (CDA) Guideline document 'Pressure Testing Piping Systems'.

TUBE BENDING

Portable bending machines are ideal for bending tubes up to 28mm. Most machines bend the tube between matched formers and back guides that support the outside diameter (OD) of the tube. This eliminates the risk of the tube wall collapsing.

The point at which the bending pressure is exerted must be maintained at the correct distance in front of the former's point of support. It's also important to keep formers and guides well lubricated. Bending tubes correctly will avoid any wrinkling and flattening that can affect flow conditions.

Using adjustable bending machines (which allow the pressure on the back guide to be adjusted) will ensure perfect bends every time so long as the root (inside) bending radius is 3.5 times the outside diameter of the tube. Up to 28mm Carbon and Stainless and 54mm Copper.



3.0 TECHNICAL DATA

SYSTEM DESIGN CONSIDERATIONS AND TUBE EXPANSION

CONNECTING TUBES MADE FROM DISSIMILAR METAL

The UK Water Regulations recommend that tubes and fittings made from different types of metals shall not be connected directly together except where galvanic action is unlikely or where effective measures are taken to prevent it. Galvanic corrosion is a process whereby the materials that come in to contact with each other oxidises or corrodes. If you are in doubt, we recommend you refer to the full and detailed information provided in Water Regulations Guide (G2.11 and R3.2), or by contacting the Water Regulations Advisory Scheme. info@wras.co.uk.

MIXED METAL INSTALLATIONS

The substitution of stainless steel XPress or Tectite 316 fittings on a galvanised carbon steel installation is acceptable in heating and chilled water applications, if required.

When joining copper to carbon steel we recommend the use of a yellow metal i.e. brass or gunmetal to prevent galvanic corrosion.

When doing this, care must be taken to protect the SC640 galvanised tube surface from the increased risk of external corrosion at the stainless/galvanised steel interface.

Galvanised carbon steel is anodic to stainless steel in air and, if the pipeline is allowed to become wet, there is a risk of localised corrosion of the carbon steel tube surface adjacent to the stainless steel fitting. This potential problem is less likely in heating pipe work which usually remains hot and dry.

In chilled water installations, an accumulation of environmental condensate on the pipe work could, under some circumstances, leach out aggressive chemicals from the insulation, resulting in corrosion, particularly at the stainless steel/carbon steel interface. Consequently, we recommend that where stainless steel fittings are installed on carbon steel pipe, the joint area should be provided with additional protection to prevent localised corrosion. This can be as simple as wrapping the interface area with an impervious material such as Denso or PVC tape.

Provided these precautions are taken, there is no reason why the combination of stainless steel fittings and carbon steel tube should not be entirely satisfactory. Provided used on closed system.

TRANSPORT AND STORAGE

We recommend that tube is not left exposed to the elements, and that end caps remain in place during storage.

During transport and storage of Tectite tubes and push fittings it is important to avoid damage and soiling. The best storage temperature for fittings and tubes is between 10°C and 25°C and they should be stored in a dry area (maximum humidity 65%). The storage of tubes should be horizontal, separated by wooden blocks. Bundles should not be stacked higher than the recommended maximum height in order to prevent tubes from becoming oval (the maximum height should not exceed 6 bundles, when stacking stack in 2x2/3x3, etc.). Please ensure that carbon and stainless tubes are stored separately.





3.0 TECHNICAL DATA

TECTITE VALVES

CONNECT + CONTROL

GENERAL SPECIFICATION - TX402 RANGE TMV3/2 THERMOSTATIC MIXING VALVES

TX402	
Materials	DZR Brass
Surface finish	Chrome plate
Water connections 15mm and 22mm	Tectite fittings all ends. Water strainers. Single non return valves on inlets

TUBE COMPATABILITY

Tube connections	Copper, Chrome Copper, PEX with Liners (6 bar @65°C, 3 bar @ 95°C max pressure) Stainless steel
------------------	---

TECHNICAL SPECIFICATION - TMV3

TECTITE TX405 TMV WHEN USED AS TMV3 VALVE		
	General operating parameters	TMV3 approved parameters
Minimum mixed temperature	30°C	38°C
Maximum mixed temperature	50°C	46°C
Maximum temperature deviation	+/- 2°C	+/- 2°C
Maximum hot inlet temperature	85°C	65°C
Maximum hot/cold, cold/hot inlet pressure ratio	5 to 1	N/A
Maximum static pressure	12 bar	10 bar
Minimum dynamic flow pressure	0.1 bar	0.2 bar
Minimum hot inlet to mixed outlet temperature differential	10°C	10°C
Flow with 0.2 bar differential pressure loss	9.0L/M	9.0L/M
Flow 1.0 bar differential pressure loss	18L/M	18L/M



3.0 TECHNICAL DATA

TECTITE VALVES

APPROVALS - TMV3

TECTITE TX405 TMV WHEN USED AS TMV3 ARE APPROVED BY WRAS FOR THE FOLLOWING USES:

Code	Operating range	Size	Application	Max. temperature
HP-B	High pressure	15mm, 22mm	Bidet	38°C
HP-S	High pressure	15mm, 22mm	Shower	41°C
HP-W	High pressure	15mm, 22mm	Washbasin	41°C
HP-T44	High pressure	15mm, 22mm	Bath	44°C
HP-T46	High pressure	15mm, 22mm	Bath	46°C (assisted)
LP-B	Low pressure	15mm, 22mm	Bidet	38°C
LP-S	Low pressure	15mm, 22mm	Shower	41°C
LP-W	Low pressure	15mm, 22mm	Washbasin	41°C

INSTALLATION CONDITIONS - TMV3

TO COMPLY WITH THE BUILD CERT TMV3 SCHEME THE VALVES MUST BE INSTALLED UNDER THE FOLLOWING CONDITIONS:

Operating pressure range	Low pressure	High pressure
Maximum static pressure (bar)	10	10
Flow pressure, hot and cold (bar)	0.2-1	1-5
Hot supply temperature (°C)	52-65	52-65
Cold supply temperature (°C)	5-20	5-20

TECHNICAL SPECIFICATION - TMV2

TECTITE TX402 TMV WHEN USED AS TMV2 VALVE

	BS EN 1287:1999	BS EN 1111:1999
Maximum static pressure	10.0	10.0
Supply pressure hot and cold	0.1-1.0	0.5-5.0
Hot supply (°C)	55-65	55-65
Cold supply (°C)	Maximum 25	Maximum 25
Mixed water temperature (°C)	Maximum 46	Maximum 46



CONNECT + CONTROL

APPROVALS - TMV2

TECTITE TX402 TMV WHEN USED AS TMV2 VALVE

Code	BS EN 1287:1999 low pressure 0.1 - 1 bar		BS EN 1111:1999 high pressure 1.5 bar	
	15mm	22mm	15mm	22mm
Bidet	-	✓	✓	✓
Shower	-	✓	✓	✓
Washbasin	-	✓	✓	✓
Tub	-	-	✓	✓
Bath fill (Cold isolation at 46°C)	-	-	✓	✓

INSTALLATION CONDITIONS - TMV2

TO COMPLY WITH THE BUILDCERT TMV2 SCHEME THE VALVES MUST BE INSTALLED UNDER THE FOLLOWING CONDITIONS:

Operating pressure range	Low pressure	High pressure
Maximum static pressure (bar)	10	10
Flow pressure, hot and cold (bar)	0.1-1	0.5-5.0
Hot supply temperature (°C)	55-65	55-65
Cold supply temperature (°C)	≤ 25	≤ 25

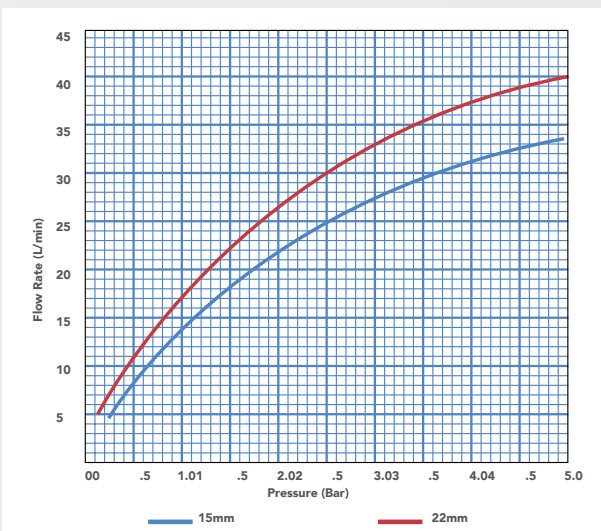

TECTITE TX402 TMV3/2 FLOW PRESSURE GRAPH

These products are certified under the Buildcert TMV scheme having been independently tested by an approved testing laboratory WRC-NSF, and are a Water Regulations Advisory Scheme (WRAS) approved product and is listed in the Water Fittings and Materials Directory.

Installation, adjustment, in service testing and maintenance is covered in the installation operating and maintenance instructions supplied with each Tectite TMV.



3.0 TECHNICAL DATA

TECTITE VALVES

TX300

MATERIAL SPECIFICATION

Component	Material
Body	Brass CW625N-DW
End Cap	Brass CW625N-DW
Ball	CP brass
Stem/Spindle	Brass CW617N
Ball Seals	PTFE
Thrust washer	PTFE
Stem 'O' Rings	EPDM
Lever	30% Glass filled nylon
Lever Nut	Plated Steel
Nameplate(s)	30% Glass filled nylon

TECTITE END CONNECTIONS - TX300

Cartridge	Plated brass
De-mount collar	Black acetal
'O' ring protector	Glass filled nylon
Grab ring	Stainless steel
'O' ring	EPDM

T809, T809B, T809T

MAXIMUM PRESSURE CONDITIONS - T809, T809B, T809T

Component	Maximum pressure (bar)
Copper pipe to EN1057 - Temperatures up to 95°C	6
Tectite tube - Temperatures up to 92°C	6 (using TECTSEAL liners)
PEX/PB pipe to BS7291 Part 2/3 - Temperatures	6 (using suitable liners)

MATERIAL SPECIFICATIONS - T809, T809B, T809T

Body	DR Brass alloy CW626N-DW changing to 602 for future batches
Ball	CP brass
Stem/Spindle	Brass
Ball	EPDM
Stem 'O' rings	EPDM
Lever	30% glass filled nylon
Lever screw	Brass
Red/ blue indices	30% Glass filled nylon
Ball retaining clip	304 Stainless Steel



CONNECT + CONTROL

TECTITE END CONNECTIONS - T809, T809B, T809T

Cartridge	Nylon 66
De mount	Nylon 66
'O' ring protector	Glass filled nylon 6
Grab ring	301 Stainless steel
'O' ring	EPDM

DOUBLE CHECK VALVE - TX802

MAXIMUM PRESSURE CONDITIONS

Range	Maximum pressure conditions (bar)
Copper pipe to EN1257 Temperatures up to 90°C	10bar
Tectite multi tube- temperatures up to 90°C	10bar (with TectSEAL liners)
PEX/PB pipe to BS7291part 2/3-temperature up to 90°C	3bar (with suitable liners)

MATERIAL SPECIFICATION

Component	Material
Body	Brass alloy CW626N-DW changing to 602 for future orders
Verification screw	DR Brass alloy CW626N-DW changing to 602 for future orders
'O' rings	EPDM
Non-return valve cartridge	Nylon

TECTITE END CONNECTIONS - TX802

Cartridge	Nickel plated brass
De mount	Black acetal
'O' ring protector	Glass filled nylon
Grab ring	Stainless steel
'O' ring	EPDM

PRESSURE & TEMPERATURE RATINGS

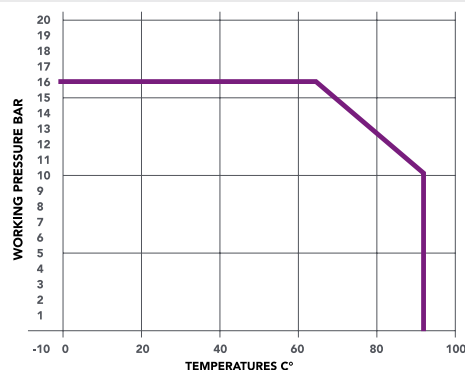



4.0 INSTALLATION INSTRUCTIONS

A QUICK GUIDE TO INSTALLATION

Step 1

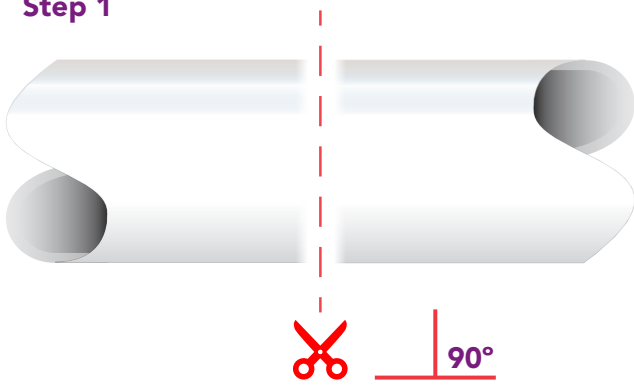

Step 2

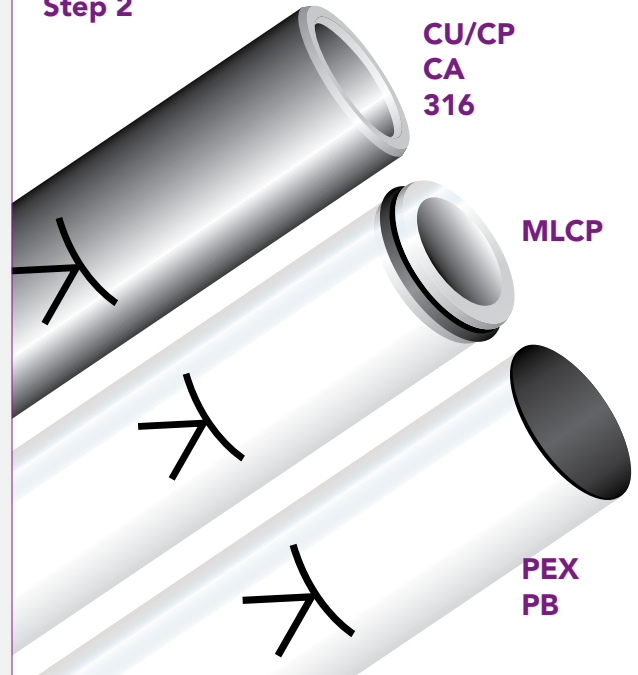

Step 3

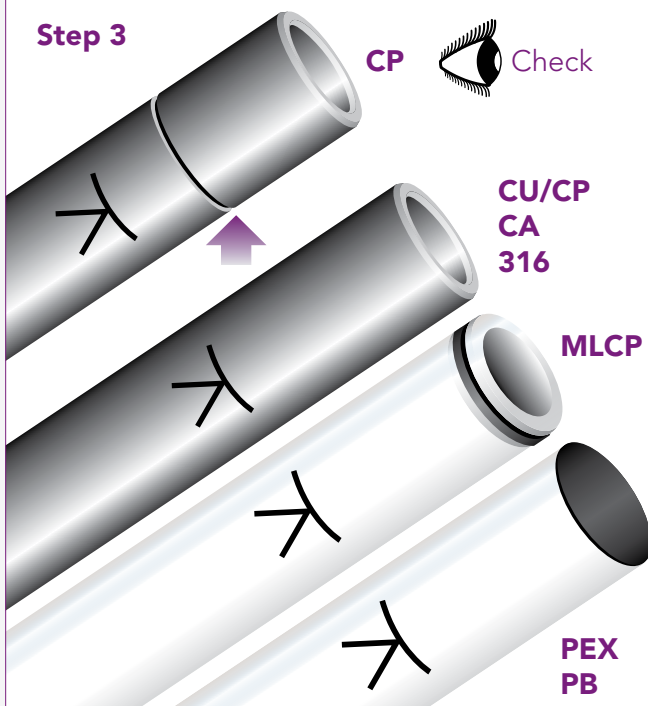

Step 4

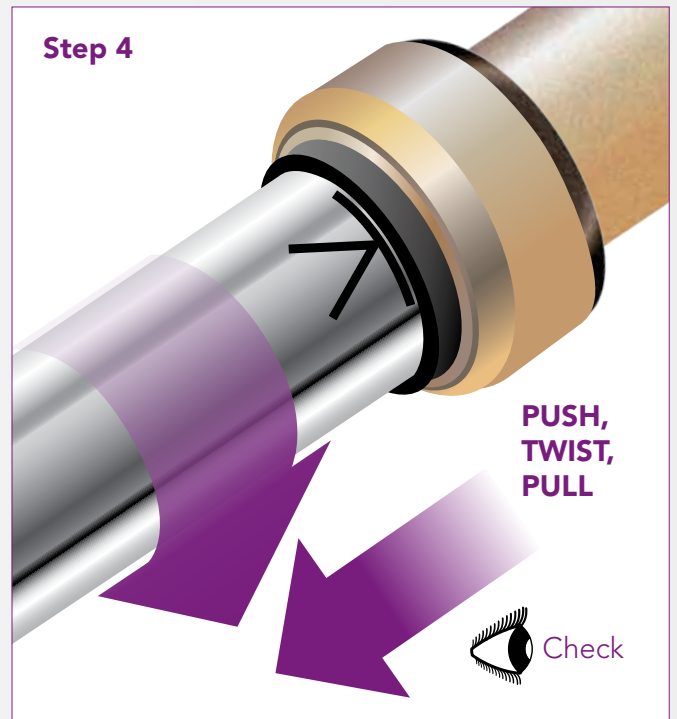



4.0 INSTALLATION INSTRUCTIONS

TECTITE INSTALLATION INSTRUCTIONS

CONNECT  CONTROL

The Tectite jointing system has been designed with easy efficient installation in mind.

GUIDE TO INSTALLATION

The jointing procedures are almost identical for every type of Tectite fitting and compatible tube material. Where there are variations (such as inserting a liner into a PEX pipe) these are shown on the following pages and in the fitting instructions. To ensure the fittings stay clean and the 'O' ring is protected from damage, never remove the fitting from its packaging until immediately prior to installation.

The tube/pipe can be fully inserted by hand. A damaged tube/pipe end will require excessive force to be used. If this is the case you should check the tube/pipe is round and deburred before continuing. Tectite fittings with plain male ends must not be used directly with capillary fittings, since heating will damage the non-metallic parts. Neither should plain ends on capillary fittings be used with Tectite.

Heat should not be applied to Tectite fittings, directly or indirectly. They should be disconnected (where applicable) to avoid any possible damage to non-metallic parts if they are to be used on a system in conjunction with capillary fittings. Similarly, reconnection must not be considered until the heated tubes have been allowed to cool and have been flushed to remove any flux residues. Use pipe clips to secure finished installations and prevent vibration or movement.

PAINTING

Fittings can be painted with water-based paints. Oil-based or aggressive solvent paint should be avoided.

BOILER CONNECTION

Tectite-PEX barrier pipe should not be joined directly to a boiler or other similar heat source. Connection should be via a piece of copper tube a minimum of 1m long.

PREPARATION

New tube ends should have any tape, labels or residual adhesive removed, taking care not to damage the tube in the process. Check the tube is round, clean and free from burrs and scores. If necessary, trim and prepare as below.

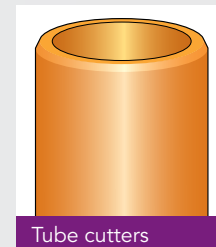

Tube cutters

We recommend the use of a good quality tube cutter with a sharp wheel for metal and plastic coated metal tube.

For cutting PEX pipe we recommend the use of good quality pipe shears with a sharp blade. Clean, square cut pipe ends should have the pipe manufacturer's liners fitted.

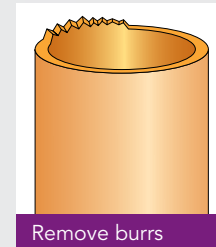

Remove burrs

Ensure the tube is cut square and all burrs and sharp edges are removed and is chamfered as shown in the illustration.

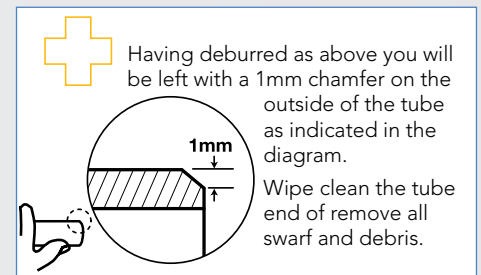

If a deburrer is not available, a fine file should be used to prepare the tube end.

SOCKET DEPTHS	
TECTITE SPRINT	
Size	Socket depth
10mm	15mm
15mm	16mm
22mm	18mm
28mm	20mm
35mm	40mm
42mm	42mm
54mm	45mm
TECTITE CLASSIC	
Size	Socket depth
10-18mm	23mm
22mm	27mm
28mm	31mm
TECTITE PRO	
Size	Socket depth
10-18mm	23mm
22mm	27mm
28mm	31mm
35mm	57mm
42mm	62mm
54mm	68mm
TECTITE 316	
Size	Socket depth
35mm	57mm
42mm	62mm
54mm	68mm
TECTITE CARBON	
Size	Socket depth
15mm	28mm
18mm	28mm
22mm	30mm
28mm	32mm
35mm	40mm
42mm	42mm
54mm	45mm
TECTITE AIR	
Size	Socket depth
10-18mm	23mm
22mm	27mm
28mm	31mm





4.0 INSTALLATION INSTRUCTIONS

TECTITE INSTALLATION INSTRUCTIONS

COPPER, CHROME PLATED COPPER, STAINLESS STEEL SYSTEM AND CARBON STEEL SYSTEM TUBES



1. Select the correct size of tube and fitting for the job. Ensure both are clean, in good condition and free from damage, scores and imperfections. Do not use any additional lubricant or sealing compounds. Cut the tube square using a rotary tube cutter wherever possible. Take care to ensure that the tube end is deburred and chamfered. If the tube is oval or damaged, use a re-rounding tool.



2. Remove any burrs or sharp edges from the external tube end using either the T110 (Tectite Classic and Tectite Pro) or the T115 (Tectite Sprint and Tectite Carbon) 3-in-1 Tectite deburring, scribe tool and socket depth marker or the S120 deburring tool from the XPress accessories range. Also, ensure the internal bore is deburred. For deburring stainless steel tube ends a fine toothed file should be used.

Then wipe clean the tube end to remove all swarf and debris - this helps to avoid damage to the 'O' ring when inserting the tube.

An alternative method of preparing copper tube ends 35-54mm before inserting into the fitting, is to use the appropriately-sized S122 percussion deburrer (not for carbon steel tube) featured in the XPress accessories range. Place the cup of the deburrer onto the end of the tube and strike it with a sharp blow from a copper-faced hammer. As well as removing burrs and sharp edges, this tool also creates a slight taper that aids insertion into the fitting. If 10mm R220 annealed copper tube is being used, ensure a T67 support liner is fully inserted into the tube.

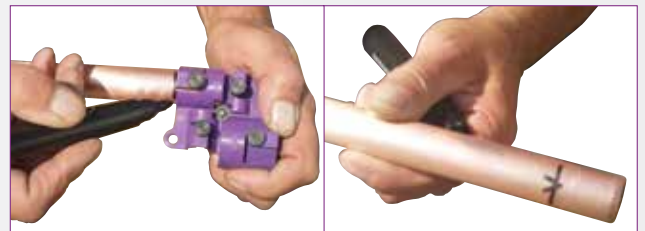

3. To make a perfect joint, the tube must be fully inserted in the fitting until it meets the tube stop. To confirm that this is the case, mark the socket depth on the tube or pipe using the T111/T115 socket depth marker (Tectite Classic, Tectite Pro & Tectite 316) or a tape measure and a marker/pencil. For the socket depth of each size of fitting, see tables. The socket depth can occasionally be obscured by the collar of the fitting so we recommend adding a 'V' mark over the depth mark line as this will always be visible.

! NOTE: The T111 Tool is designed for marking Tectite flexible metal tube as well as copper, PEX and PB. For 15 and 22mm tube you must ensure you are using the correct side of the tool as the depth mark is shorter for Tectite flexible metal tube to take into account of the depth of the TectSEAL™



4. When jointing chrome-plated copper tube with Tectite Classic, Tectite Pro and Sprint fittings, scribe the tube using the T110/T115 (Sprint) scribing tool to ensure positive grab ring location. This helps to accommodate any variance in chrome plate thickness. Note: The scribing function is not suitable for stainless steel tube.

Proceed to jointing (see next page).



FLEXIBLE METAL TUBE AND PB PEX PIPE

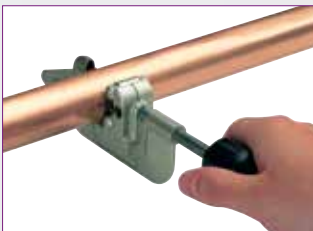

1. Select the correct size of pipe and fitting for the job. Ensure both are clean, in good condition and free from damage, scores and imperfections. Do not use any additional lubricant or sealing compounds. Cut the tube square using a rotary tube cutter.
2. Where Tectite-PEX barrier pipe is used, remove the label from the pipe end. If the pipe has been used on a previous installation cut the tube back to behind the teeth marks, ensuring there are no score marks on the pipe.
- 2a. Use the Tectite Calibrating Tools to provide a clean, square pipe end with chamfered edges. Calibration re-rounds the tube after cutting to prepare it for the TectSEAL™ and for push-fit jointing.



- 3a. Push the patented TectSEAL™ 3PS into the Tube until the flange meets the tube end. TectSEAL™ 3PS are pre-lubricated. Make sure all swarf is removed from tube before fitting TectSEAL™.

Proceed to jointing (see next page).

- 3b. Ensure the correct pipe support liner from the pipe manufacturer is fully inserted into the pipe (T66 for Tectite flex).

PLASTIC COATED CARBON STEEL SYSTEM TUBE



1. Select the correct size of tube and fitting for the job. Ensure both are clean, in good condition and free from damage, scores and imperfections. Do not use any additional lubricant or sealing compounds. Cut the tube square using a rotary tube cutter wherever possible.
2. The plastic coating must be removed to the socket depth of the fitting using the S115 stripping tool from the XPress accessories range. Select the correct sized tool, fully insert the tube and twist the tool until the excess of plastic is completely detached.



3. Remove any burrs or sharp edges from the external tube end using an S120 deburring tool from the XPress accessories range. Also deburr the internal bore. If using plastic coated tube, the use of the S115 tool (as point 2), will deburr the inside of 15mm to 28mm tube. The same tool will also deburr the outside of plastic coated tube – insert the tube into the opposite end of the tool and twist.

The use of the S115 tool (as point 2), will deburr the inside of 15mm to 28mm tube. The same tool will also deburr the outside of plastic coated tube – insert the tube into the opposite end of the tool and twist.

SOCKET DEPTHS

	SPRINT	CLASSIC	PRO	316	CARBON
Black	up to 28mm	-	-	-	-
Purple	-	up to 28mm	up to 28mm	up to 28mm	-
Metal	35 - 54mm	-	-	-	ALL SIZES



4.0 INSTALLATION INSTRUCTIONS

TECTITE INSTALLATION INSTRUCTIONS 10MM TO 28MM SIZES

JOINTING

1. To make a perfect joint, the tube or pipe must be fully inserted in the fitting until it meets the tube stop. To confirm that this is the case, mark the socket depth on the tube or pipe using the appropriate socket depth marker or a tape measure and a marker/pencil.

For the socket depth of each size of fitting, see tables on page 105.



2. Inspect the fitting ensuring that the grab rings/'O'-rings have not been contaminated with grit or debris. Insert the tube/pipe into the mouth of the fitting to rest against the grab ring.

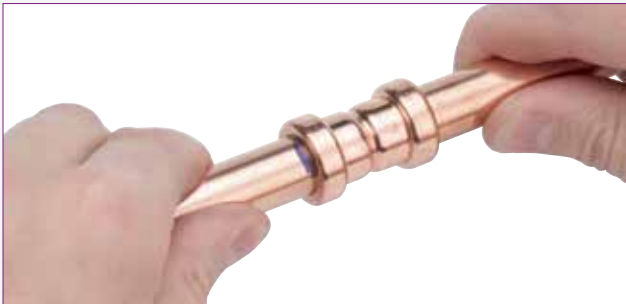

3. Push the tube firmly with a slight twisting action until it reaches the tube stop with a positive "click".
4. Ensure the depth insertion mark corresponds with the mouth of the fitting and then pull firmly on the tube to ensure the fitting is secure.



! NOTE: We recommend all systems are thoroughly pressure tested to 1.5 times working pressure before the hand-over to the customer.

! NOTE: Tectite Sprint and Tectite Carbon fittings must not be used with the male ended fittings from other Tectite ranges (except T526S). Other third party male ended products should not be used with any Tectite fittings.

Do not use Tectite fittings on gas services.

Tectite Classic fittings do not provide electrical continuity, other Tectite fittings only provide electrical continuity when installed with metal tube.



4.0 INSTALLATION INSTRUCTIONS

TECTITE INSTALLATION INSTRUCTIONS 35MM TO 54MM SIZES

CONNECT + CONTROL

Although manufactured to a different design, jointing tubes in sizes from 35mm to 54mm with Tectite Pro and Tectite 316 fittings is basically the same as it is at smaller sizes.

PREPARATION

The first thing to consider when it comes to installation of 35mm to 54mm fittings is whether you plan to demount any fittings in the system on a regular basis. If you do, then we recommend you replace the standard end cap with the appropriately sized TDX demounting end cap.

To ensure the fittings stay clean and the 'O' ring is protected from damage, never remove the fitting from its packaging until immediately prior to installation.

When it comes to tube end preparation and socket depth marking for jointing with 35mm to 54mm fittings, follow the same routine as outlined in the preliminaries, tube preparation and installation tips sections for 10mm to 28mm fittings on the previous pages.

1. Insert the tube through the end cap to rest against the grab ring.
2. Now push the tube firmly with a slight twisting action until it reaches the tube stop with a positive 'click'.
3. Ensure the depth insertion mark corresponds with the mouth of the fitting, then pull firmly on the tube to ensure that the fitting is secure.

! **NOTE: We recommend all systems are thoroughly pressure tested to 1.5 times working pressure before the hand-over to the customer.**

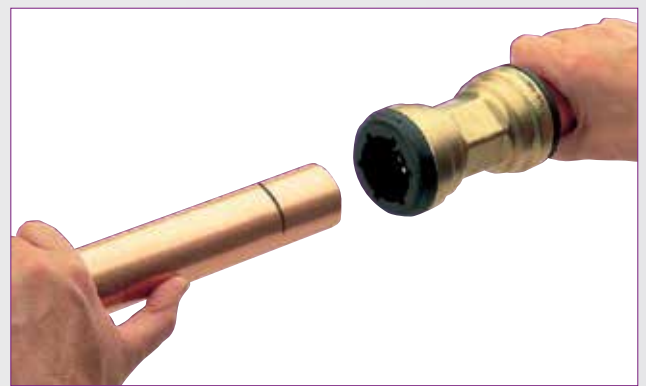



4.0 PRODUCT OVERVIEW

TECTITE INSTALLATION INSTRUCTIONS DEMOUNTING

How to demount Tectite Classic, Tectite Pro and Tectite 316 fittings from pipework.

DEMOUNTING

Tectite Classic, Tectite Pro and Tectite 316 fittings in sizes 10mm to 28mm can all be disconnected as described below. Tectite Sprint and Tectite Carbon fittings are not suitable for disconnection. Ensure the system is de-pressurised and drained.



1. Place the forks of the disconnecting tool around the fitting assembly. The fork side carrying the Tectite brand logo should be positioned around the tube/pipe, with the opposite side around the neck of the fitting.
2. Squeeze the disconnecting tool with one hand until the release collar in the fitting is depressed. With the other hand, twist out the tube/pipe using the thumb as a lever against the tool to assist disconnection.
3. Check the fitting and tube/pipe for damage before remaking the joint.



4. The plastic disconnecting clip may be used where only an occasional disconnecting facility is required.

NOTE: TectSEAL™ 3PS liners will remain in the fitting following demounting. This fitting can still be used again with Tectite Tube, gently insert again with a twist observing the depth indicator.

DEMOUNTING WITH TDX DEMOUNTING END CAPS

Tectite Pro and Tectite 316 fittings in 35mm to 54mm sizes are supplied with conventional black end caps. If you intend to demount the fitting on a regular basis, a TDX demounting end cap should be purchased separately and substituted for the standard end cap. A DTX Tectite end cap tool will also be required.

Due to the potentially high frequency with which TX61/TS61 stop ends may be demounted, they are supplied with the TDX end caps fitted as standard.

Demounting the fitting from the tube is a simple process when TDX demounting end caps have been installed in the fittings. Ensure the system is de-pressurised and drained.

1. To remove the tube from the fitting, insert the prongs of the Tectite DTX end cap tool in the recesses in the status indicator (2) and turn anti-clockwise fully. The status indicator will withdraw into the fitting, indicating that the fitting is in the de-mountable position. Using a 'clockwise' twisting and pulling action the tube can now be removed.
2. Before reusing the fitting, the status indicator must be returned to the mounted position (protruding).

NOTE: If the status indicator is not in the protruding position, the assembly will not withstand full system pressure.





DEMOUNTING END CAP

If regular demounting of a particular fitting is envisaged TDX demounting end caps should be purchased separately and installed in the fitting body.



STANDARD BLACK END CAPS

Fittings with standard black end caps can be demounted from the tube by unscrewing the end cap with the Tectite DTX end cap tool and snipping off the grab ring with side cutters, discarding both grab ring and 'O' ring. A new grab ring and 'O' ring must be used when reassembling the fitting (see the disassembly section below).

DISASSEMBLY

Replacing the 'O' ring on 35mm to 54mm Tectite Pro and Tectite 316 fittings is easily achieved by disassembling the fitting.



1. Have replacement parts for the discarded items ready for insertion. Using a spanner on the fitting flats to prevent the fitting from rotating, insert the Tectite DTX end cap tool into the slots in the end cap. Turn the tool anti-clockwise to unscrew the end cap and slide it along the tube away from the fitting body.
2. Pull the tube out of the fitting body.
3. Remove and discard the 'O' ring.
4. Remove and retain the alignment ring.



5. Snip off the grab ring with side cutters and discard.

REASSEMBLY

Tectite Pro grab rings (TX105) and Tectite 316 grab rings (TS106) are not interchangeable. Care must be taken when replacing grab rings to ensure that only the correct grab ring is used.

1. Before re-assembly have replacement parts for the discarded items ready for insertion, ensuring all the components are clean and the 'O' ring is lubricated using S130 Silicone lubricant from the XPress accessories range. Replace the components in the correct order, as shown, and check they are fully seated in the fitting body.

NOTE: The grab ring operates with an interference fit in the body to provide electrical continuity. Therefore, the end cap must be tightened down flush with the fitting body.

2. Screw the end cap back into the fitting until hand tight. If resistance is felt and the end cap is not flush with the fitting body, remove the end cap and ensure the grab ring is fully located i.e. fully in contact with the alignment ring. Again screw the end cap into the fitting until hand tight. Temporarily insert a 300mm length of deburred tube into the fitting BUT NOT THROUGH the grab ring to help locate the demount tool. Tighten the end cap a further 8mm to 10mm. Remove the tube.

3. Before reinstalling the fitting back into the system, check the end of the tube for damage. If the tube is scored or damaged, remove the affected section with a tube cutter and prepare the tube end as described in preliminaries and tube preparation (page 105).
4. Reinsert the tube into the fitting up to the tube stop, ensuring the socket depth mark corresponds with the mouth of the fitting and that the finished joint is secure.

REPLACEMENT 'O' RINGS



TX100 replacement 'O' rings and TX105/TS106 grab rings are available (sizes 35mm to 54mm) in the event that any are lost or damaged on-site.

We recommend the use of S130 Silicone lubricant grease available from the XPress range to aid insertion of the replacement 'O' ring into the fitting as these 'O' rings are supplied unlubricated.





Pegler Yorkshire

Follow us on



CONNECT  CONTROL

UK ENQUIRIES

UK SALES

Free Phone: 0800 156 0010

Free Fax: 0808 156 1011

Email: uk.sales@pegleryorkshire.co.uk

TECHNICAL HELP

Free Phone: 0800 156 0050

Free Fax: 0808 156 1012

Email: tech.help@pegleryorkshire.co.uk

BROCHURE HOTLINE

Free Phone: 0800 156 0020

Free Fax: 0808 156 1011

Email: info@pegleryorkshire.co.uk

INTERNATIONAL ENQUIRIES

EXPORT

Tel: +44 (0) 1302 855 656

Fax: +44 (0) 1302 730 513

Email: export@pegleryorkshire.co.uk

Tectite

XPress

Henco

Terrier

Meibes

Ballorex

Pegler

Prestex

Yorkshire

Endex

Kuterlite

Francis Pegler

Performa



HEAD OFFICE

Pegler Yorkshire Group Limited

St. Catherine's Avenue, Doncaster,
South Yorkshire DN4 8DF, England

Tel: +44 (0) 1302 560 560

Fax: +44 (0) 1302 560 203

Email: info@pegleryorkshire.co.uk

www.pegleryorkshire.co.uk

Registered in England Company No. 00401507

Registered Office: Haigh Park Road, Stourton,
Leeds, West Yorkshire, LS10 1RT England

All brand names and logo styles are registered trademarks. Maintaining a policy of continual product development, Pegler Yorkshire reserves the right to change specifications, design and materials of products listed in this publication without prior notice

LIT.REF: 880118