

Product Catalogue August 2015



PVC-UE Roofline,
Window &
Cladding Systems

Rainwater
Systems

Soil & Waste
Systems

Underground
Drainage Systems

MDPE
Systems

Hot & Cold
Plumbing Systems

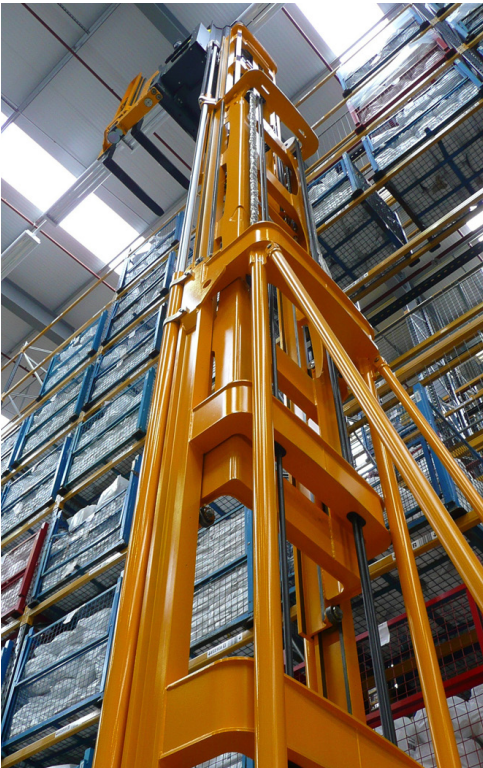

FloPlast are an established market leader in the manufacture and supply of plastic building and plumbing systems in the UK.

The company's specialist areas are PVC-UE Roofline, Window & Cladding, Rainwater, Soil & Waste, Underground Drainage, MDPE systems & Hot & Cold Plumbing systems.

FloPlast place a heavy emphasis on product design with many innovative features to its products making them practical both to install and in their functionality. The company has invested heavily in its infrastructure to ensure that its products are manufactured and supplied to its customers on a cost effective basis.

With competitive pricing and an extensive range of high quality products, **FloPlast** endeavour to provide an excellent service to both stockist and end user alike.

Contents

PVC-UE Roofline, Window and Cladding Systems	Page
Introduction	4
Fascia, soffit & window boards	4
Roofline trims	6
Window system trims	7
Cladding systems & fixings	7
Woodgrain	8

Rainwater Systems	Page
Introduction	10
Ancillaries / Spares	10
Half Round 112mm gutter	11
Square Line 114mm gutter	11
Niagara ® Ogee 110mm gutter	12
Hi-Cap 115mm gutter	12
65mm Square, 68mm & 80mm Round downpipe	13
Miniflo Half Round 76mm gutter & 50mm downpipe	14
Xtraflo Semi-Elliptical 170mm gutter & 110mm Round downpipe	14
Anthracite Hi-Cap 115mm gutter & 68mm downpipe	15

"Cast Iron" Style Rainwater Systems	Page
Half Round 112mm gutter	16
Hi-Cap 115mm gutter	16
Niagara ® Ogee 110mm gutter	16
68mm Round downpipe & spares	17
65mm Square downpipe & spares	17
Motifs for Hoppers & Fittings	17

Rainwater Harvesting	Page
StormSaver Rainwater Harvesting system	18
EcoFlo: Water Butts & Rainwater Diverters	19

Soil & Waste Systems	Page
Introduction	20
Air Admittance Valves	20
Ancillaries	20
ABS Solvent Weld waste	21
Polypropylene Push-Fit waste	21
Unicom Compression waste	22
Chrome Unicom Compression waste	22
Waste Traps	23
Overflow waste	24
110mm Solvent Soil	24
110mm Ring Seal Soil	25
110mm "Cast Iron" Style Ring Seal Soil	26
Soil-WC Pan Connectors	26
flexiflo Connectors	26

Underground Drainage Systems	Page
Introduction/ GroundGuard / Land Drainage	27
110mm drainage	28
160mm drainage	32
FloDrain Channel Drainage	33

MDPE Systems	Page
Blue MDPE pipe	34
Compression fittings	34

Hot & Cold Plumbing Systems	Page
FloFit Hot & Cold pipe 10/15/22mm	35
FloFit Hot & Cold fittings 10/15/22mm	35

For CE DOP's (Declaration of Performance), please refer to our website at www.floplast.co.uk

PVC-UE Roofline, Window & Cladding Systems

Introduction to PVC-UE Roofline, Window & Cladding Systems BS 7619:2010

FloPlast Roofline, Window & Cladding extrusions are manufactured on state of the art machinery and extrusion die's at the group's Cork plant, which has over 40 years extrusion experience.

FloPlast boards offer a complete maintenance free solution to both Roofline and Window Systems construction. The tough impermeable outer skin of **FloPlast** foam boards provides year round protection from both weather and insect infestation. The system comes with a 20 year white and a 10 year woodgrain performance and Colour Guarantee.



Both the Roof Trim and Cladding Systems have been assessed and achieved Agrément Certification as follows:-



A range of these products are also available with a laminated woodgrain finish, please see pages 6 & 7.

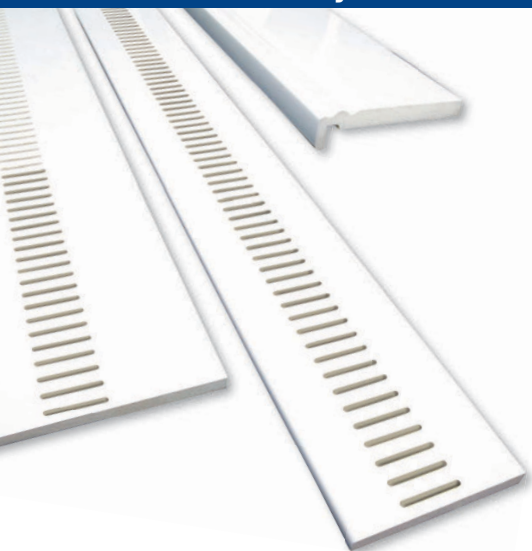

Roofline & Window Systems



Product	Code	Size
---------	------	------



Universal Board - 9mm

Suitable as fascia (refurbishment - install over timber support), window board or reveal liner.

Double Leg: 	U350	350mm
	U450	450mm
Single Leg: 	U100	100mm
	U150	150mm
	U175	175mm
	U200	200mm
	U225	225mm
	U250	250mm
	U275	275mm
	U300	300mm



NEW Square Edge Universal Board - 9mm

Suitable as fascia (refurbishment - install over timber support), window board or reveal liner.

Single Leg: 	L150	150mm
	L175	175mm
	L200	200mm
	L225	225mm
	L250	250mm
Double Leg: 	L400	400mm



Hockey Window Board - 9mm

Suitable as fascia (refurbishment - install over timber support).

Double Round Leg: 	K400	400mm
Single Round Edge: 	K150	150mm
	K175	175mm
	K200	200mm
	K225	225mm
	K250	250mm



Ogee Fascia Board - 10mm



Suitable as fascia (refurbishment - install over timber support).



Double Leg: 	O404	404mm
Single Leg: 	O150	150mm
	O175	175mm
	O200	200mm
	O225	225mm
	O250	250mm

PVC-UE Roofline, Window & Cladding Systems





Product	Code	Size
Mammoth Board - 18mm Suitable as fascia (replacement/new build install direct to rafters), window board or reveal liner.		
Double Leg: 	M404	404mm
Single Leg: 	M150 M175 M200 M225 M250 M300	150mm 175mm 200mm 225mm 250mm 300mm

Product	Code	Size
Mammoth Bullnose Board - 16mm Suitable as fascia (replacement/new build, install direct to rafters).		
Double Round Edge: 	B400	400mm
Single Round Edge: 	B150 B175 B200 B225 B250	150mm 175mm 200mm 225mm 250mm

Product	Code	Size
Ogee Mammoth Board - 18mm Suitable as fascia (replacement/new build, install direct to rafters).		
Double Leg: 	G454	454mm
Single Edge: 	G150 G175 G200 G225 G250 G300	150mm 175mm 200mm 225mm 250mm 300mm

Product	Code	Size
Multi-Purpose Board - 10mm		
Double Round Edge:  (S600-9mm)	S304 S404 S600	304mm 404mm 600mm
Single Round Edge: 	S100 S150 S175 S200 S225 S250 S500	100mm 150mm 175mm 200mm 225mm 250mm 500mm

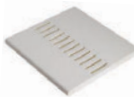
Product	Code	Size
Hollow Soffit/Trims To be used as a soffit only.		
Hollow Soffit: 	H300	300mm
Hollow Soffit trims: 	HJ HH HF	'J' 'H' 'F'

Product	Code	Size
Vented Board - 10mm		
Vented Soffit: 	V100 V150 V175 V200 V225 V250 V304 V404 V500 V600	100mm 150mm 175mm 200mm 225mm 250mm 304mm 404mm 500mm 600mm
Double Vented Soffit: 	DV175 DV200 DV250 DV304 DV404	175mm 200mm 250mm 304mm 404mm
Vented soffit with a double row of vents is available to special order		





Scan with your smart phone for more information.





All boards and trims are manufactured in 5 metre lengths unless otherwise stated

Product	Code	Size
Box End Board:		
Universal Board	UB450	450mm
Mammoth Board	MB404	404mm
Ogee Mammoth Board	GB454	454mm

Roofline Trims





Product	Code	Size
In-Line Joints:		
	RT1	300x42mm Leg
	RT2**	500x35mm Leg
	RT3#	500x42mm Leg



Product	Code	Size
Corner Joints:		
	RT4	300x42mm Leg
	RT5**	500x35mm Leg
	RT6#	500x42mm Leg
	RT7	300x42mm Leg Internal Corner
	RT10	300x42mm Leg External Corner 135°

**Double ended joint - cut to 2 sizes as required.
To be used with Mammoth Board.



#Double ended joint - cut to 2 sizes as required.
To be used with Universal Board.

NEW Square In-Line Joints:		
	RT16	300x42mm Leg

NEW Square Corner joints:		
	RT13	300x42mm Leg
	RT18	300x42mm Leg Internal Corner

Ogee In-Line Joints:		
	RT11	300x50mm
	RT12*	500x50mm

*Double ended ogee joint - cut to 2 sizes as required.

Ogee Corner Joints:		
	RT14	300x50x50mm
	RT15*	500x50x50mm
	RT17	300x42mm leg Ogee Internal Corner

*Double Ended Ogee Joint - cut to 2 sizes as required.

Ogee Box End Cover:		
	RT19	404x60mm

All boards and trims are manufactured in 5 metre lengths unless otherwise stated

Product	Code
In-Line Jointing Trim:	
	RT20

Edge Capping Trims:	
	RT21

Product	Code	Size
Hockey Board In-line Joint:		
	RT8	300mm

Hockey Board Corner Joint:		
	RT9	300mm



Bargeboard Moulding Trim:		
	RT22	500mm

Finials:		
	RT23	340mm
	RT29	900mm

Disc Soffit Ventilator:		
	RT25	

Product	Code
Soffit Ventilator:	
	RT24

Soffit Ventilator with Mesh:	
	RT27







Product	Code	Size
Over Fascia Ventilation & Eaves protection system		
Over Fascia Ventilation:		
	OFV10	10mm
Eaves Protection System:		
	EPS	









PVC-UE Roofline, Window & Cladding Systems

Window Systems

All boards and trims are manufactured in 5 metre lengths unless otherwise stated







Product	Code	Size
Architrave-Pencil Round:		
	WT1	45x6mm
	WT2	65x6mm
	WT3	95x6mm
D Section:		
	WT4	28x6mm
Edge Fillet:		
	WT5	20mm
Quadrant:		
	WT6	12mm
	WT7	19mm
Square:		
	WT8	15x13mm
Hockey Board End Mouldings:		
	WT16	300mm





Product	Code	Size
Board End Mouldings:		
	WT14	42x50mm (pair)
	WT15	42x31.5mm (1 Item)
Window Board Channel:		
	RT21	10x5mm
Angle:		
	WT30	100x80mm 90° Hollow
	WT31	25x25mm 90° Rigid
	WT32	50x50mm 90° Rigid
	WT36	25x25mm Flexi
	WT37	35x35mm Flexi
	WT38	75x75mm Flexi

Cladding Systems

BS EN 13245-2: 2008 Attestation Level 4



Product	Code
150mm Shiplap Cladding:	
	C150
100mm V Joint Cladding:	
	C100
Top Edge Trim (two part):	
	CT1
Starter Trim:	
	CT2
Universal Channel:	
	CT3



Product	Code
Drip Trim:	
	CT4
Internal/External Corner (two part):	
	CT5
Centre Joint Trim:	
	CT7
150mm Butt Joint Trim:	
	CT8

All boards and trims are manufactured in 5 metre lengths unless otherwise stated.

Fixings

A4 Stainless Steel Pins/Nails with white plastic heads



Product	Code	Product	Code	Product	Code
FloTop Pins box (250):		FloTop Nails box (100):		Clad Pins box (250):	
	FP30 (30mm)		FN50 (50mm)		CP30 (30mm)
	FP40 (40mm)		FN65 (65mm)		CP50 (50mm)

PVC-UE Roofline, Window & Cladding Systems



Golden Oak (WG)

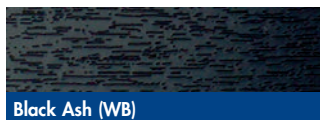

Black Ash (WB)



Rosewood (WR)

When ordering please add foil reference to code required, e.g. U150 WG

Woodgrain PVC-UE Roofline

All boards and trims are manufactured in 5 metre lengths unless otherwise stated

Product	Code	Size
---------	------	------

Universal Board:

	U150	150mm
	U175	175mm
	U200	200mm
	U225	225mm
	U250	250mm
	U300	300mm
(Double leg)	U450	450mm

Mammoth Board:

	M150	150mm
	M175	175mm
	M200	200mm
	M225	225mm
	M250	250mm
	M404	404mm
(Double leg)		

Multi-Purpose Board:

	S100	100mm
	S150	150mm
	S175	175mm
	S200	200mm
	S225	225mm
	S250	250mm
	S304	304mm
	S404	404mm

Hollow Soffit:

	H300	300mm
--	------	-------

Product	Code	Size
---------	------	------

Hollow Soffit Trims:

	HJ	'J'
	HH	'H'
	HF	'F'

Vented Soffit:

	V150	150mm
	V175	175mm
	V200	200mm
	V225	225mm
	V250	250mm
	V304	304mm
	V404	404mm

Double Vented Soffit:

	DV175	175mm
	DV200	200mm
	DV250	250mm
	DV304	304mm
	DV404	404mm

Vented soffit with a double row of vents is available to special order.

Box End Board:

Universal Board	UB450	450mm
Mammoth Board	MB404	404mm

Woodgrain Roofline Trims

All boards and trims are manufactured in 5 metre lengths unless otherwise stated

Product	Code	Size
---------	------	------

In-Line Joints

	RT1	300x42mm Leg
	RT2#	500x35mm Leg

Corner Joints

	RT4	300x42mm Leg
	RT5#	500x35mm Leg

#Double ended joint - cut to 2 sizes as required. To be used with Mammoth Board.

Internal Corner

	RT7	300x42mm Leg
--	-----	--------------

Product	Code	Size
---------	------	------

Finial:

	RT23	340mm
--	------	-------

Product	Code
---------	------

In-Line Jointing Trim:

	RT20
--	------

PVC-UE Roofline, Window & Cladding Systems



Golden Oak (WG)

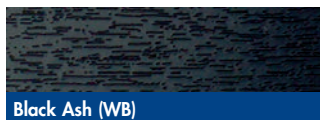

Black Ash (WB)









Rosewood (WR)

When ordering please add foil reference to code required, e.g. WT1 WG

Woodgrain Window Systems

All boards and trims are manufactured in 5 metre lengths unless otherwise stated

Product	Code	Size
Architrave-Pencil Round:		
	WT1	45x6mm
	WT2	65x6mm
	WT3	95x6mm
D Section:		
	WT4	28x6mm
Edge Fillet:		
	WT5	20mm
Quadrant:		
	WT6	12mm
	WT7	19mm
Square:		
	WT8	15x13mm





Product	Code	Size
Angle:		
	WT30	100x80mm 90° Hollow
	WT31	25x25mm 90° Rigid
	WT32	50x50mm 90° Rigid
	WT36	25x25mm Flexi
	WT37	35x35mm Flexi
Board End Mouldings:		
	WT14	42x50mm (pair)
	WT15	42x315mm (1 Item)

Woodgrain Cladding Systems

All boards and trims are manufactured in 5 metre lengths unless otherwise stated
BS EN 13245-2: 2008 Attestation Level 4



Product	Code
150mm Shiplap Cladding:	
	C150
100mm V Joint Cladding:	
	C100
Top Edge Trim (two part):	
	CT1
Starter trim:	
	CT2
Universal Channel:	
	CT3

Product	Code
Drip Trim:	
	CT4
Internal/External Corner (two part):	
	(external corner foiled) CT5
	(Internal corner foiled) CT6
Centre Joint Trim:	
	CT7
150mm Butt Joint Trim:	
	CT8

Woodgrain Fixings

A4 Stainless Steel Pins/Nails. When ordering please add foil reference to code required, e.g. FP30 BR



Product	Code
FloTop Pins box (250):	
	FP30 (30mm) FP40 (40mm)

Product	Code
FloTop Nails box (100):	
	FN50 (50mm) FN65 (65mm)

Product	Code
Clad Pins box (250):	
	CP30 (30mm) CP50 (50mm)

Rainwater Systems

Introduction to Rainwater Systems

FloPlast Rainwater Systems offer a wide choice of profile design, both traditional and modern, in a range of colours to suit all tastes and applications.

FloPlast Rainwater Systems come with a 10 Year Performance and Colour Guarantee on the black, white, and brown ranges and 20 years for the "Cast Iron" style systems.

Register online - www.floplast.co.uk



Scan with your smart phone to watch our Rainwater installation video



Ancillaries / Spares

Product	Code	Product	Code	Product	Code
Universal Rainwater Adaptor		FloGuard: Leaf Protection System 5m Pack		8mm Downpipe Spacer Brackets	
 Connects to 110mm drainage	D96		FG1	 Only use with RS2, RC4 & RB4 (Black/white only)	RC9
Universal Rise & Fall Bracket		Balloon: Leaf Protection System		For use with 68mm Round downpipe	
	RF1	 (Outlet Guard)	OG1	 Only use with RS52, RC54 & RB54 (Black/white only)	RCS9
Rafter Bracket Top Fix		DrainGuard (Black)		40ml Compressed Silicone Lubricant Spray	
	RR1	 Fits round and square downpipe	DG1		SL40
Rafter Bracket Side Fix		Snow/Tile Guard - 2m			
	RR2		SG1		
GutterBrush (black)		Snow / Tile Guard Bracket			
 Debris eliminator (4m)	GB4		SG2		
NEW GutterBrush (white)		8mm Universal Fascia Bracket Spacer			
 Debris eliminator (4m)	GB4	 (Black/white only) Suitable for Half Round, Square Line, Niagara Ogee and Hi-Cap gutters only	RS9		
Product	Code	Product	Code		
Spare Gutter Seals		Spare Gutter Seals			
 Round	RRS1	 Niagara	RRNS1		
 Square	RRSS1	 Hi-Cap	RRHS1		





Rainwater Systems

Half Round 112mm Rainwater System

BS EN 607:2004, BS EN 12200-1:2000, BS EN 1462:2004

For optimum performance of Half Round gutter systems we recommend the use of FloPlast 68mm Round downpipe system.

112mm Gutter & Fittings

Product	Code
Gutter	
	2m RG2 3m RG3 4m RG4
90° Angle	
	RA1
135° Angle	
	RA2
Adjustable Angle 50° - 156°	
	RA3*
Angle - Any Degree	
	RA9#

Product	Code
Running Outlet	
	RO1
Stopend Outlet	
	RO2
Stopend -	
	External RE1
	Internal RE2
Fascia Bracket	
	RK1
Union Bracket	
	RU1



Product	Code
To Cast Iron Ogee Gutter Adaptors:	
	R/H RD3
	L/H RD4**
To Half Round Cast Iron Adaptor	
	RD5
Spare Gutter Clip	
	RRC1

*FloPlast will fabricate any non-standard angle to special order.

*Not available in grey





**Not available in brown







Square Line 114mm Rainwater System

BS EN 607:2004, BS EN 12200-1:2000, BS EN 1462:2004

For optimum performance of Square Line gutter systems we recommend the use of FloPlast 65mm Square downpipe system.

114mm Gutter & Fittings

Product	Code
Gutter 2m / 3m / 4m	
	2m RGS2* 3m RGS3* 4m RGS4
90° Angle	
	RAS1
135° Angle	
	RAS2
Adjustable Angle 50° - 156°	
	RAS3**
Angle - Any Degree	
	RAS9#

Product	Code
Running Outlet	
	ROS1
Stopend Outlet	
	ROS2
Stopends	
	External RES1
	Internal RES2
Fascia Bracket	
	RKS1
Union Bracket	
	RUS1



Product	Code
Square/Round Gutter Adaptor	
	RDS1
To Cast Iron Ogee Gutter Adaptors	
	R/H RDS3
	L/H RDS4*
To Half Round Cast Iron Gutter Adaptor	
	RDS5
Spare Gutter clip	
	RRSC1

*FloPlast will fabricate any non-standard angle to special order.

*Not available in caramel



Gutter & pipe code reference numbers refer to length of run : 2 metres, 2.5 metres, 4 metres & 5.5 metres. **Important when ordering:** To indicate the product colour(s) required, the following code suffixes should be used: B-Black, BR-Brown, W-White, G-Grey, C-Caramel.









Rainwater Systems

Niagara® Ogee 110mm Rainwater System BS EN 607:2004, BS EN 12200-1:2000, BS EN 1462:2004





For optimum performance of Niagara gutter systems we recommend the use of FloPlast 65mm Square Line & 80mm Round downpipe systems.

110mm Gutter & Fittings

Product	Code
Gutter	
 4m	RGN4
90° Angle	
 Internal	RAN1
 External	RAN2
135° Angle	
 Internal	RAN3
 External	RAN4
Angle - Any Degree	
	RAN9*
Running Outlet	
 Multi Outlet	RON1*
 80mm Round	RON4**

Product	Code
Stopend Outlets - 65mm Square	
 L/H	RON2*
 R/H	RON3*
Stopend Outlets - 80mm Round	
 L/H	RON5**
 R/H	RON6**
Stopends - External:	
 L/H	REN1
 R/H	REN2
Stopends - Internal:	
 L/H	REN3
 R/H	REN4
Union Bracket	
	RUN1









Product	Code
Fascia Bracket	
 Top	RKN1
 Hung	RKN2
Spare Gutter Clip	
	RRNC1
Niagara to Half Round Gutter Adaptors	
 R/H	RNR3***
 L/H	RNR4***
Niagara to Square Line Gutter Adaptors	
 R/H	RNS3***
 L/H	RNS4***

*FloPlast will fabricate any non-standard angle to special order.
 **Not available in sand.
 ***Not available in caramel.
 ***Products not available in caramel or sand.

Hi-Cap 115mm Rainwater System BS EN 607:2004, BS EN 12200-1:2000, BS EN 1462:2004

For optimum performance of Hi-Cap gutter systems we recommend the use of FloPlast 68mm & 80mm Round downpipe systems.

115mm Gutter & Fittings

Product	Code
Gutter - 4m	
 4m	RGH4
Angle	
 90°	RAH1
 135°	RAH2
 any degree	RAH9*
Running Outlet	
 68mm	ROH1*
 80mm	ROH4

Product	Code
Stopend	
 External	REH1
 Internal	REH2
Fascia Bracket	
 R/H	RKH1
 Top Hung	RKH2**
Union Bracket	
 RUH1	RUH1
 Floating	RUH2**



Product	Code
Hi Cap to Half Round Gutter Adaptors	
	RHR3***
Hi Cap to Square Line Gutter Adaptors	
	RHS3***
Spare gutter clip	
	RRHC1

*FloPlast will fabricate any non-standard angle to special order.
 **Not available in sand
 ***Not available in brown or grey
 ***Products not available in sand or grey







Gutter & pipe code reference numbers refer to length of run : 2 metres, 2.5 metres, 4 metres & 5.5 metres. **Important when ordering:** To indicate the product colour(s) required, the following code suffixes should be used: B-Black, BR-Brown, W-White, G-Grey, C-Caramel, S-Sand.







Rainwater Systems



65mm Square Downpipe & Fittings

BS EN 12200-1:2000



Product	Code	
Pipe		
	2.5m	RPS2.5
	4m	RPS4
	5.5m	RPS5.5
Offset Bend		
	92½°	RBS1
	112½°	RBS2
	Adj. Offset Bend	RBS5
Shoe		
		RBS3
	(With fixing lugs)	RBS4*

Product	Code	
Pipe Clips		
		RCS1
	Flush	RCS2#
	Single Fix	RCS3#
	(With fixing lugs)	RCS4**
Pipe Sockets		
		RSS1
	(With fixing lugs)	RSS2***
67½° Branch		
		RY1





Product	Code	
Square Access Pipe		
		RXS1#
Sq/Rd Downpipe Adaptor		
	Connects to 68mm round downpipe system.	RDS2#
Hopper		
		RHS1##





#Not available in caramel
 ##Connects to 65mm square & 68mm round downpipe.
 *Must be used in conjunction with RCS4 and RSS2. (Black and white)
 **Must be used in conjunction with RBS4 and RSS2. (Black and white)
 ***Must be used in conjunction with RCS4 and RBS4. (Black and white)



68mm Round Downpipe & Fittings

BS EN 12200-1:2000



Product	Code	
Pipe		
	2.5m	RP2.5
	4m	RP4
	5.5m	RP5.5
Offset Bends:		
	92½°	RB1
	112½°	RB2
67½° Branch		
		RY1

Product	Code	
Shoes		
		RB3
	(With fixing lugs)	RB4*
Pipe Clips:		
		RC1
	Single Fix	RC3#
	(With fixing Lugs)	RC4**

Product	Code	
Pipe Sockets		
		RS1
	(With fixing lugs)	RS2***
Access Pipe		
		RX1
Hopper		
		RHS1##

#Not available in caramel
 #Connects to 65mm square & 68mm round downpipe.



*Must be used in conjunction with RC4 and RS2. (Black and white)
 **Must be used in conjunction with RB4 and RS2. (Black and white)



***Must be used in conjunction with RC4 and RB4. (Black and white)



80mm Round Downpipe & Fittings

BS EN 12200-1:2000



Product	Code	
Pipe		
	4m	RPH4
Offset Bend		
	92½°	RBH1
	112½°	RBH2

Product	Code	
Shoe		
		RBH3
Pipe Clip		
	(Single fix)	RCH3
Pipe Socket		
		RSH1

Product	Code	
Hopper		
		RHH1
67½° Branch		
		RYH1
Universal Rainwater Adaptor		
	Connects 110mm Drainage	D97

Important when ordering: - To indicate the product colour(s) required, the following code suffixes should be used: B-Black, BR-Brown, G-Grey, W-White, C-Caramel, S-Sand. Please note all prices are per unit.

Rainwater Systems

Miniflo 76mm/50mm Rainwater System

BS EN 607:2004, BS EN 12200-1:2000, BS EN 1462:2004



76mm Gutter & Fittings

Product	Code	
Gutter	2m	RGM2
Angle		
	90°	RAM1
	135°	RAM2

Product	Code	
Running Outlet		ROM1
Stopend Outlet		ROM2
Stopend		REM1

Product	Code	
Fascia Bracket		RKM1
Union Bracket		RUM1

50mm Pipe & Fittings

Product	Code	
Pipe	2m	RPM2
Offset Bend		
	112½°	RBM2

Product	Code	
Shoe		RBM3
Pipe Clip		RCM1

Product	Code	
Pipe Socket		RSM1

Xtraflo 170mm/110 Semi-Elliptical Rainwater System

170mm Gutter & Fittings BS EN 1462:2004, BS EN 607:2004



Product	Code	
Gutter		RGX4
90° Angle		RAX1

Product	Code	
Running Outlet		ROX1
Fascia Bracket		RKX1

Product	Code	
Union Bracket		RUX1
Stopend		
	External	REX1
	Internal	REX2

110mm Pipe & Fittings BS EN 1329:2000

Product	Code	
Pipe - Plain Ended	3m *4m	SP1 SP2
Pipe - Single Socket	3m 4m	SP3 SP4
Shoe		SP161A
Pipe Clip		SP82

Product	Code	
Offset Bends:		
	135° Top	SP440
	135° Bottom	SP435
Hopper		RHX1
92½° Soil Pipe Branch		SP190

Product	Code	
92½° Soil Pipe Access Bend		SP169
Access Pipe		
	Socket/Spigot	SP274

*Not available in White

Gutter & pipe code reference numbers refer to length of run: 3 or 4 metres.



Important when ordering: - To indicate the product colour(s) required, the following code suffixes should be used: B-Black, BR-Brown, G-Grey, W-White, C-Caramel, S-Sand.

INTRODUCING THE **NEW** ANTHRACITE COLOUR RANGE IN HI-CAP



Hi-Cap 115mm Rainwater System BS EN 607:2004, BS EN 12200-1:2000, BS EN 1462:2004

115mm Gutter & Fittings



Product	Code	
Gutter - 4m	4m	RGH4
Angle		
	90°	RAH1
	135°	RAH2
	any degree	RAH9*



Product	Code	
Union Bracket		RUH1
Running Outlet	68mm	ROH1
Fascia Bracket		RKH1

Product	Code	
Stopend		
	External	REH1
	Internal	REH2



*FloPlast will fabricate any non-standard angle to special order.

68mm Round Downpipe & Fittings BS EN 12200-1:2000



Product	Code	
Pipe		
	2.5m	RP2.5
	4m	RP4
Offset Bends:		
	92½°	RB1
	112½°	RB2

Product	Code	
67½° Branch		
		RY1
Shoes		
		RB3
Pipe Clip		
		RC1

Product	Code	
Pipe Sockets		
		RS1
Hopper**		
		RHS1

**Connects to 65mm square & 68mm round downpipe.

Gutter & pipe code reference numbers refer to length of run: 2.5 metres, 4 metres.

Important when ordering: To indicate the product colour, the following code suffix should be used: A-Anthracite.



“CAST IRON” STYLE Rainwater System

BS EN 607:2004, BS EN 12200-1:2000, BS EN 1462:2004



HALF ROUND



112mm Gutter & Fittings

Product	Code	
Gutter		
	4m	RG4
	2m	RG2
Angle		
	90°	RA1
	135°	RA2
	any degree	RA9#
Running Outlet - 68mm round		
		RO1
Stopend Outlet - 68mm round		
		RO2
Stopend		
	External	RE1
	Internal	RE2
Fascia Bracket		
		RK1
Union Bracket		
		RU1
To Cast Iron Ogee gutter adaptors		
	R/H	RD3
	L/H	RD4
To Half Round Cast Iron gutter adaptors		
		RD5

Gutter & pipe code reference numbers refer to length of run: 2.5 metres & 4 metres.

HI-CAP



115mm Gutter & Fittings

Product	Code	
Gutter		
	4m	RGH4
Angle		
	90°	RAH1
	135°	RAH2
	any degree	RAH9#
Running Outlet - 68mm round		
		ROH1
Stopend		
	External	REH1
	Internal	REH2
Fascia Bracket		
		RKH1
Union Bracket		
		RUH1

Important when ordering -
To indicate "Cast Iron" on your order the CI suffix should be added to the product code e.g. RA1CI



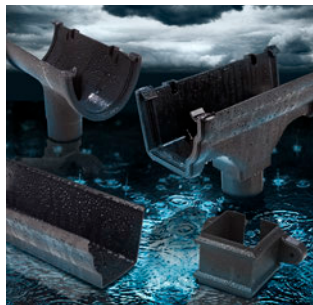











*FloPlast will fabricate any non-standard angle to special order



Niagara® Ogee



110mm Gutter & Fittings

Product	Code	
Gutter		
	4m	RGN4
	3m	RGN3
90° Angle		
	Internal	RAN1
	External	RAN2
135° Angle		
		RAN3
		RAN4
Angle - Any Degree		
		RAN9#
Running Outlet - Multi Outlet		
		RON1
Stopend Outlet - 65mm		
	L/H	RON2
	R/H	RON3
Stopend - External		
	L/H	REN1
	R/H	REN2
Stopend - Internal		
	L/H	REN3
	R/H	REN4
Fascia Bracket		
		RKN1
Union Bracket		
		RUN1

“CAST IRON” STYLE Rainwater System

BS EN 607:2004, BS EN 12200-1:2000, BS EN 1462:2004



68mm Round Pipe & Fittings

Product	Code
Pipe	
 2.5m	RP2.5
Offset Bend	
 92½°	RB8
 112½°	RB6
Shoe	
 RB4#	RB4#
Pipe Clip	
 RC4#	RC4#
Pipe Socket	
 RS2#	RS2#
67½° Branch	
 RY1	RY1
Access Pipe	
 PART 100	RX1

Square/Round Downpipe Adaptor

 RDS2	RDS2
---	------

Universal Hopper

 RH1	RH1
--	-----

Connects to 65mm square & 68mm round downpipe

Ogee Hopper

 RH4#	RH4#
---	------

Connects to 68mm round and 65mm square downpipes.

Rectangular Hopper**

 RH5#	RH5#
---	------

Connects to 68mm round and 65mm square downpipes.

Please note: If a larger outlet is required please contact our technical department on 01795 431 731

65mm Square Pipe & Fittings

Product	Code
Pipe 2.5m	
 RPS2.5	RPS2.5
Offset Bend	
 92½°	RBS8
 112½°	RBS6
Shoe	
 RBS4#	RBS4#
Pipe Clip	
 RCS4#	RCS4#
Pipe Socket	
 RSS2#	RSS2#
67½° Branch	
 RYS2	RYS2

Motifs for Hoppers & Fittings



Product	Code
Fleur-de-Lis	
 40mm	FL55
 52mm	FL70
Tudor Rose	
 40mm	TR55
 52mm	TR70
Decorative Square	
 40mm	DS55
 52mm	DS70
Lion's Head	
 40mm	LH55
 52mm	LH70

40mm motifs can be used with RH4 and RH5
52mm motifs cannot be used with RH4

Fixings

Product	Code
Cast Iron Fixings	
 FC50	FC50
12 gauge x 50mm stainless steel fixings for "Cast Iron" Range (Socket fixings).	

Gutter clip and seal

Product	Code
Gutter Clip	
 Round	RRC1
 Niagara	RRNC1
 Hi-Cap	RRHC1

Gutter Seals

 Round	RRS1
 Niagara	RRNS1
 Hi-Cap	RRHS1

*With fixing lugs (Requires 2 x FC50 fixings)

**This product is rotationally moulded and subject to bowing along its length up to +/-4%.

Gutter & pipe code reference numbers refer to length of run: 2.5 metres & 4 metres.

Important when ordering :-

To indicate "Cast Iron" on your order the CI suffix should be added to the product code e.g. RA1CI



StormSaver Rainwater Harvesting System BS8515:2009



With the average home owner using around 150 litres of water per day, the **StormSaver** rainwater harvesting system will enable the metered home owner to recycle rainwater and potentially reduce their bills by up to 50%, whilst remaining kinder to the environment. StormSaver can also alleviate pressure on local drainage in line with Sustainable Drainage Schemes (SuDS), to help prevent flood risk

Benefits of using StormSaver:

- Uses over 75% less energy than other traditionally pumped Rainwater Harvesting systems, by using clever suction technology.
- Low decibel rating.
- Flow Rate of 10 litres per minute (same as mains pressure).
- Compact control unit, which can easily fit into either a kitchen cupboard, or be located in a utility room or garage.
- Cost effective solution to reuse rainwater effectively.
- The shallow dig tank is robust and comes with all the necessary components such as integral filtration, overflow siphon and inlet calmer pre-fitted for ease of installation.
- Ideal for new build properties and homes with up to 6 bedrooms.

Product	Code	Size (L)
---------	------	----------

StormSaver Packages	S1500	1500
	S3000	3000
	S5000	5000
	S7500	7500

Package includes:

- Underground storage tank
- 235mm Entrance shaft
- Pedestrian duty lid for tank
- Control panel
- ½" Boosted floating suction filter kit
- 20m ½" Flexible suction hose



Product	Code	Size (L)
---------	------	----------

Underground Storage Tanks	ST1500	1500
	ST3000	3000
	ST5000	5000
	ST7500	7500

Product	Code	Size
---------	------	------

Pedestrian Duty Lid	PDL1	
---------------------	------	--

Entrance Shaft	ES235	235(mm)
	ES635	635(mm)

Control Panel	CP1	
---------------	-----	--

½" Boosted Floating Suction Filter Kit	FK1	
--	-----	--

Product	Code	Size
---------	------	------

½" Flexible Suction Hose	H20	20(mm)
	H40	40(mm)

Level Sensor	LS1	
--------------	-----	--

Identification Tape and Label Pack	ID1	
------------------------------------	-----	--

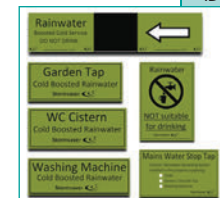



110mm Non-Return Valve - Single Flap	D550	
--------------------------------------	------	--

Required for the system to comply with BS 8515



EcoFlo Rainwater Storage and Diverters



Product	Code
Rainwater Diverter Connects to 65mm square and 68mm round downpipe  <p>Not available in sand.</p>	RVS1
Connector Kit  <p>Not available in brown, grey, sand or "cast iron" Style.</p>	RVS2

Product	Code
100L Slim Water Butt 	WB100
100L Slim Water Butt Stand 	ST100

100L SLIM WATER BUTT	
<ul style="list-style-type: none"> • 100L capacity. • Space saving water butt ideal where space is at a premium. • Supplied with tap and lid. • Manufactured in the UK from recycled materials. 	
Dimensions	
Water Butt: 32cm (12½") Length 36cm (14") Width 95.2cm (37½") Height	Stand: 33cm (13") Length 33cm (13") Width 30.5cm (12") Height

Product	Code
Rainwater Diverter Connects to 80mm Round Downpipe  <p>Not available in "cast Iron" Style.</p>	RVH1
MiniFlo Rainwater Diverter Connects to 50mm Round Downpipe  <p>Not available in sand or "cast Iron" Style.</p>	RVM1

Product	Code
210L Slim Water Butt 	WB200
210L Slim Water Butt Stand 	ST200

210L SLIM WATER BUTT	
<ul style="list-style-type: none"> • 210L capacity • Traditional shape water butt with a large capacity. • Supplied with tap and childproof lid. • Manufactured in the UK from recycled materials. 	
Dimensions	
Water Butt: 57cm (22½") Diameter 97cm (38") Height	Stand: 53cm (21") Diameter 31cm (12") Height

Soil & Waste Systems

Introduction to Soil & Waste

FloPlast offer a comprehensive choice of systems and products, in a range of sizes and colours, to suit all tastes and applications.

Air Admittance Valves

FloPlast Air Admittance Valves have been awarded the prestigious BSI Kitemark (KM 51 2474) and are A1 rated in accordance with BS EN 12380.

AX110 - External Air Admittance Valve

The External Air Admittance Valve complements the existing range of Internal Air Admittance Valves. The external version eliminates the need for the installer to work and handle pipes above the roof line, therefore making it easier to comply with Work at Height (WAHR) and Manual Handling Regulations.

"Cast Iron" Style Ring Seal Soil System PVC-U

The FloPlast "Cast Iron" Style Rainwater and Soil Systems offer the authentic look of Cast Iron with all the benefits of PVC. This soil system complements the well established Half Round, Niagara & Hi-Cap "Cast Iron" Style Rainwater Systems.

- All sockets come complete with a "Cast Iron" style shroud.
- Full PVC-U system.
- 10 Year Performance and Colour Guarantee.
- 1.8m pipes for the traditional look.
- Pipe clips also replicate the traditional cast iron style.
- Strap on boss - extra care should be taken when solvent welding the strap on boss as any excess solvent will be detrimental to the "Cast Iron" effect. Alternatively use external grade silicone sealant.



**World's
FIRST
External
Air Admittance
Valve**

Benefits

- Removal of unsightly ventilation stack.
- Removes the need for the installer to work & handle pipe above the roof line.
- (Work at Height (WAHR) and Manual Handling Regulations).
- Reduced installation time.
- Materials cost saving - bends, pipe, vent cowl and clips.



AX110

Air Admittance Valves

BS EN 12380:2002 Attestation Level 4



www.floplast.co.uk





White

Black



Grey

Product	Code	Size
Air Admittance Valve Compression		
	AV32	32mm
	AV40	40mm
	AV50	50mm



(White only) This product is not CE marked under the Construction Products Regulations 2011

Product	Code	Size
Air Admittance Valve Solvent  		
	AF32	32mm
		40mm
		50mm



(White only) Universal adaptor to fit 32mm/40mm/50mm Solvent Waste Pipe

Product	Code	Size
External Air Admittance Valve  		
	AX110	110 Pushfit 82mm Solvent

(Push-Fit/Solvent)

Product	Code	Size
Air Admittance Valve Push-Fit  		
	AF110	110mm

For 82mm solvent connection, remove seal from 110mm push-fit.

Product	Code	Size
Air Admittance Valve Solvent  		
	AV110	110mm



Ancillaries



Product	Code
40ml Compressed Silicone Lubricant Spray	
	SL40

Product	Code
50g Silicone Lubricant Gel	
	SL50

Product	Code
800gm Lubricant Gel	
	SG800

Product	Code
100gm Silicone Grease	
	SG100

Product	Code
125ml Solvent Cement	
	 SC125

Product	Code
250ml Solvent Cement	
	 SC250

Soil & Waste Systems

ABS Solvent Weld System BS EN 1455-1:2000, BS 5255 : 1989



Product	Code	Size
3m Wastepipe	WS01	32mm
	WS02	40mm
	WS03	50mm

Product	Code	Size
Straight Coupling	WS07	32mm
	WS08	40mm
	WS09	50mm

Product	Code	Size
90° Bend	WS10	32mm
	WS11	40mm
	WS12	50mm

Product	Code	Size
92½° (87½°) Bend	WS14	32mm
	WS15	40mm
	WS16	50mm

Product	Code	Size
135° Bend (45°)	WS18	32mm
	WS19	40mm
	WS20	50mm

Product	Code	Size
Tee	WS22	32mm
	WS23	40mm
	WS24	50mm

Product	Code	Size
90° Conversion Bend	WS26	32mm
	WS27	40mm
	WS28#	50mm

Product	Code	Size
135°(45°) Conversion Bend	WS76#	32mm
	WS77#	40mm

Product	Code	Size
Access Plug	WS30	32mm
	WS31	40mm
	WS32	50mm

Product	Code	Size
Pipe Clip	WS34	32mm
	WS35	40mm
	WS36	50mm

Product	Code	Size
Reducer	WS38	40x32mm
	WS39	50x32mm
	WS40	50x40mm

Product	Code	Size
135° (45°) Branch	WS42*	32mm
	WS43#	40mm

Product	Code	Size
Level Invert Reducer	WS50*	40x32mm

Product	Code	Size
92½° (87½°) Cross Tee	WS58*	40mm

Product	Code	Size
Tank Connector	WS60*	32mm
	WS61*	40mm

Product	Code	Size	
Adaptors	Male	WS63#	32mm
		WS64#	40mm
	Female	WS66#	32mm
		WS67#	40mm

*White only
#Not available in black

Push-Fit Waste System BS EN 1451-1:2000, BS 5254 : 1976

Material: Polypropylene



Product	Code	Size
3m Wastepipe	WP01	32mm
	WP02	40mm
	WP03	50mm

Product	Code	Size
Straight Coupling	WP07	32mm
	WP08	40mm
	WP09	50mm

Product	Code	Size
90° Bend	WP10	32mm
	WP11	40mm
	WP12	50mm

Product	Code	Size
92½° (87½°) Bend	WP14	32mm
	WP15	40mm
	WP16	50mm

Product	Code	Size
135° Bend (45°)	WP18	32mm
	WP19	40mm
	WP20	50mm

Product	Code	Size
Tee	WP22	32mm
	WP23	40mm
	WP24	50mm

Product	Code	Size
90° Conversion Bend	WP26	32mm
	WP27	40mm

Product	Code	Size
Socket Plug	WP30	32mm
	WP31	40mm
	WP32	50mm

Product	Code	Size
Pipe Clip	WP34	32mm
	WP35	40mm
	WP36	50mm

Product	Code	Size
Reducer	WP38	40x32mm
	WP39	50x32mm
	WP40	50x40mm

Product	Code	Size
Tank Connector	WP60	32mm
	WP61	40mm

Soil & Waste Systems



Unicom Compression Waste System BS 5254:1976, BS EN 1451-1:2000



Material: Polypropylene



White

Product	Code	Size
3m Wastepipe*		
	WP01 WP02	32mm 40mm
Straight coupling		
	WC07 WC08	32mm 40mm
90° Bend		
	WC10 WC11	32mm 40mm

Product	Code	Size
0-90° Adjustable Bend		
	WC14 WC15	32mm 40mm
135° Bend (45°)		
	WC18 WC19	32mm 40mm
Tee		
	WC22 WC23	32mm 40mm

Product	Code	Size
90° Conversion Bend		
	WC26 WC27	32mm 40mm
Reducer		
	WC38	40x32mm
Flexi-Tube		
	FT32 FT40	32mm 40mm

*Also available in black and grey. See page 21.



"Chrome" Style Unicom Compression Waste System

BS 5254:1976, BS EN 1451-1:2000

Material: Polypropylene



Chrome

Product	Code	Size
1.1m Wastepipe (ABS)		
	CW01 CW02	32mm 40mm
Straight Coupling		
	CW07 CW08	32mm 40mm

Product	Code	Size
90° Bend		
	CW10 CW11	32mm 40mm
Tee		
	CW22 CW23	32mm 40mm

Product	Code	Size
Pipe Clip		
	CW34 CW35	32mm 40mm
*Price per pack of 3		

"Chrome" Style Waste Traps BS EN 274-1:2002

Material: Polypropylene



Chrome

Product	Code	Size
Telescopic Bottle Trap 76mm seal		
	CT37T CT47T	32mm 40mm

System Features

- Enhances the area for visible installations.
- Ideal for all public areas, hotels, pubs & restaurants.
- Fits ABS, PVC, Copper & Polypropylene pipes.
- Gives an authentic chrome effect.











Soil & Waste Systems











Waste Traps BS EN 274-1:2002













White

Traps to BS EN 274 are manufactured in white, high temperature polypropylene with compression type outlets that fit plastic and copper waste pipes 32mm/1¼" and 40mm/1½".

Product	Code	Size
P Trap - 38mm seal		
	TP33 TP43	32mm 40mm
P Trap - 76mm seal		
	TP37 TP47	32mm 40mm
S Trap - 38mm seal		
	TS33 TS43	32mm 40mm
S Trap - 76mm seal		
	TS37 TS47	32mm 40mm
Telescopic P Trap - 76mm seal		
	TP47T	40mm
Shallow Bath Trap - 38mm seal		
	TSB42	40mm *With cleaning eye and 20mm seal
Low Level Bath Trap - 50mm seal		
	TLB45	40mm
Washing Machine Trap		
	TW470	40mm
Washing Machine Kit - 76mm seal		
	TW471	40mm Includes 600mm stand pipe and 2 clips
Running 'P' Trap - 76mm seal		
	TR47	40mm
Single Bowl Sink Kit - 76mm seal		
	TW472	40mm

Product	Code	Size
½ Bowl Sink Kit		
	TW475	40mm
Double Bowl Sink Kit - 76mm seal		
	TW476	40mm
Double Nozzle Trap - 76mm seal		
	TW477	40mm
Appliance Half Traps - 76mm seal		
	TW473	40mm
Appliance Half Traps - 76mm seal		
	TW474	40mm
Bottle Trap - 38mm seal		
	TB33 TB43	32mm 40mm
Bottle Trap - 76mm seal		
	TB37 TB47	32mm 40mm
Anti Vac Bottle - 76mm seal		
	TB37A TB47A	32mm 40mm
Telescopic Bottle Trap - 76mm seal		
	TB37T TB47T	32mm 40mm
Plain Swivel Elbow		
	WC26 WC27	32mm 40mm
Washing Machine Tee		
	TWT41	40mm

Product	Code	Size
Washing Machine/Dishwasher Nozzle		
	THC40	40mm
Overflow & Hose Connector		
	THC41	40mm
Trap Height Adjustor		
	TA33 TA43	32mm 40mm
Telescopic Pedestal Trap - 76mm seal		
	TD372T TD374T	32x32mm 32x40mm
Patent No. GB2362658. Reg.Design No. 2092016		
Shower Traps		
	TH41	40x19mm Plastic grid
	TH43	40x19mm Chrome grid
	TH51	40x50mm Plastic grid
	TH53	40x50mm Chrome grid
FastFlo Shower Trap		
	TH52	40 x 50mm
Wet room Shower Trap		
	TH54	40 x 50mm
Trap Seal Kits (4 piece)		
	TK32 TK40	32mm 40mm

Soil & Waste Systems

Overflow Waste System

21.5mm Overflow Waste PVC-U Solvent

Product	Code
3m Overflow Pipe	OS01
Straight Coupling	OS10
90° Bend	OS11

Product	Code
135° (45°) Bend	OS12
Tee	OS13
Straight Tank Connector	OS14

Product	Code
Bent Tank Connector	OS15
Pipe Clip	OS16
Overflow Waste Reducer*	OS17 OS18

● Black ○ White

32mm OS17
40mm OS18

*Fits into socket of both push-fit and solvent weld systems.

110mm Solvent Soil System PVC-U

BS EN 1329-1:2000, BS 4514:2001 BS EN 1453-1:2000

Product	Code
Pipe-Plain Ended	SS1 SS2
Pipe Clip	SS82
Double Socket Pipe Coupling	SS106
Single Socket Pipe Coupling (Solvent ring seal)	SS107
Offset Bend - Top	SS440
Offset Bend - Bottom	SS435
92½° (87½°) Bend (Double socket)	SS561
135° (45°) Bend (Double socket)	SS563

Product	Code
90° Bend (Spigot/socket)	SS168
92½° (87½°) Branch (Triple socket)	SS191
135° (45°) Branch (Triple socket)	SS211
Vent Terminal	SS302
Short Boss Pipe	SS583
Strap Boss	SS319
Boss Adaptor	SS20 SS21
Access Pipe (Double socket)	SS275

Product	Code
Screwed Access Cap	SS292
92½° (87½°) Access Bend (Double socket)	SS569
92½° (87½°) Access Branch (Triple socket)	SS503



● Black ● Olive Grey



Soil & Waste Systems

Ring Seal Soil System PVC-U







110mm Pipe and Fittings

BS EN 1329-1:2000, BS 4514:2001
BS EN 14531-1:2000









Product	Code	
Pipe-Plain Ended		
	3m 4m	SP1 SP2*
Pipe-Single Ended		
	3m 4m	SP3 SP4
Pipe/Socket Clip		
	Pipe Clip Socket Clip	SP82 SP83*
Double Socket Pipe Coupling		
		SP105
Single Socket Pipe Coupling		
		SP124
92½° (87½°) Bend (Socket/Spigot)		
		SP161
92½° (87½°) Bend (Double Socket)		
		SP561
112½° (67½°) Bend (Socket/Spigot)		
		SP162
135° (45°) Bend (Socket/Spigot)		
		SP163
135° (45°) Bend (Double Socket)		
		SP563
Adjustable Bend 0-90°		
	(PP - Do not solvent weld)	SP560
135° (45°) Offset Bend - Top		
		SP440
135° (45°) Offset Bend - Bottom		
		SP435
92½° (87½°) Branch		
		SP190
112½° (67½°) Branch		
		SP200

Product	Code	
135° (45½°) Branch		
		SP210
92½° (87½°) Double Branch		
		SP230
92½° (87½°) Access Bend		
		SP169
92½° Corner Branch (Special order only)		
		SP232
92½° (87½°) Access Branch		
		SP502
Screwed Access Cap		
		SP292
Socket Plug		
		SP296
Access Pipe (Socket/Spigot)		
		SP274
Access Pipe (Socket/solvent socket)		
		SP275*
Boss Pipe (Socket/Spigot)		
		SP581
Boss Pipe (Socket/solvent socket)		
		SP582*
Short Boss Pipe		
		SP583
Strap Boss		
		SP319
Soil Manifold 32/40/50mm connections		
	(One open boss)	SP588*
Weathering Collar		
		SP300

Product	Code	
Vent Terminal		
		SP302
Extract Cowl		
		SP310
500 x 600mm Weathering Slate		
		SP320
Boss Adaptor - Rubber Push - Fit		
	32mm 40mm 50mm	SP10 SP11 SP12
Solvent Boss Adaptor		
	32mm 40mm 50mm	SP20 SP21 SP22
Fire Protection Collar 110mm		
	(FC55, FC82 & FC160 available to order)	FC110

Reducers

Product	Code	
110x50mm Waste*		
		SP95
110x68mm Rainwater		
		SP96
110x82mm Soil (Grey only)		
		SP97
Universal Waste Adaptor (32/40/50)		
		D95
Drain Connector		
		SP107*
Universal Pipe Connector (Adapts to soil/clay/CI/drainage)		
		SP140*

* To reduce to 32mm or 40mm waste use SP10, SP11 or SP12 respectively.

* Not Available in white

Soil & Waste Systems







“CAST IRON” STYLE Ring Seal Soil System PVC-U

BS EN 1329-1:2000, BS 4514:2001
BS EN 14531-1:2000

Important when ordering: - To indicate “Cast Iron” on your order the CI suffix should be added to the product code e.g. SP161CI
110mm Pipe and Fittings



Product	Code
1.8m Pipe - Plain Ended - 110mm	
	SP9
110mm Pipe Coupling (Requires 2 x FC65 fixings)	
	SP115
Pipe Clip (Requires 2 x FC65 fixings)	
	SP84
8mm Pipe Spacer Bracket	
	SP89
92½° (87½°) Bend (Socket/spigot)	
	SP161*
135° (45°) Bend (Socket/spigot)	
	SP163*
92½° (87½°) Bend (Double socket)	
	SP561*

Product	Code
135° (45°) Bend (Double/spigot)	
	SP563*
92½° (87½°) Double Branch	
	SP230*
92½° (87½°) Branch	
	SP190*
92½° (87½°) Branch (Without side bosses)	
	SP192*
92½° (87½°) Access bend	
	SP169*
Access Pipe (Socket/spigot)	
	SP274*
Boss Pipe (Socket/spigot)	
	SP581*

Product	Code
Strap Boss	
	SP319
Cast Iron Fixings	
	FC65##
110mm Vent Terminal	
	SP302
110mm Weathering Collar	
	SP300
500x600mm Weathering Slate	
	SP320

*All complete with socket shroud.

**12 gauge x 65mm Stainless Steel fixings for “Cast Iron” range (Socket Fixings). The FC65 is a 12 gauge x 65mm Stainless Steel bolt, that requires a 12mm, 12 point star head socket to tighten it. When fixing product to concrete, brick, block etc fix FC65 in the same way as any other screw by using a plug type fixing, and into timber by pilot drilling a starter hole first.

##Solvent cement can be used, with caution, alternatively use external silicone sealant.

Soil-WC Connectors

BS EN 1329-1:2000, BS 5627:1984



White



Product	Code
Swan neck	
	SP100
Straight	
	SP101
Offset	
	SP102
90° Bend	
	SP103

Product	Code
250mm Extension	
	SP104
Flexible	
	SP106
14° Connector	
	SP108



Grey

flexiflo Connectors

Product	Code	Size(mm)
Coupling		
	WF07	30-38
	WF08	38-45
Elbow		
	WF11	40-48
	SP111	105-116

Underground Drainage Systems

Introduction to Underground Drainage Systems

FloPlast Underground Drainage Systems are available in 110mm & 160mm sizes.

FloPlast Underground Drainage Systems comply where applicable, with the requirements of the following British Standards.

BS EN 1401-1: 2009 PVC-U Underground Drainage Systems.

BS4660: 2000 PVC-U Ancillary Items (Rodding eyes, Access fittings etc).

BS EN 124: 1994 Access covers, gratings and frames.

BS EN 13598-1:2010 Specification for Ancillary fittings including shallow Inspection Chamber.

BS EN 13476-2: 2007: Structured wall piping (PVC-u) for non-pressure Underground Drainage Systems.

KM 563461 applies to BS EN 1401-1: 2009 for a UD application.

KM 563462 applies BS EN 13476-2: 2007 for a UD application.

KM 544332 applies to BS EN 1401-1 (fittings for UD application).



Scan with your smart phone to watch our Underground Drainage installation video



GroundGuard

Lightweight ground reinforcement system suitable for pedestrian areas and light vehicle access.

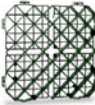
Product	Code
GroundGuard Tiles	
 Pack of 20 = 3.2 square metres 1 Tile = 390 x 390 x 40mm Tested in excess of 200 tonnes per square metre spread load	G40

GroundGuard is suitable for:

- Additional/overflow grass car parks.
- Walkways and disabled access routes.
- Golf buggy paths.
- Driveways and residential lawn parking.

Please visit www.floplast.co.uk for installation instructions.

Land Drainage

Corrugated coiled land drainage pipe manufactured in PVCu.

Product	Code	No	Size O.D
Land Drainage - 25m Coil			
	L8025		80mm x 25m
	L10025		100mm x 25m

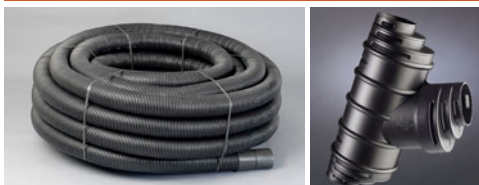

Product	Code	No	Size O.D
Couplings			
	LC80		80mm
	LC100		100mm

Product	Code	No	Size O.D
Multi-Junction Branch			
	LJ100		80/100mm

Underground Drainage Systems

















Underground Drainage System PVC-U

110mm Pipe & Fittings, PVC-U

BS 4660:2000, BS EN 1401-1:2009, BS EN 124:1994,
BS EN 13476-2:2007



Product	Code
Pipe	
 Plain Ended (Bale quantity 50)	3m D043 6m D046
 Single Socket (Bale quantity 50)	3m D143 6m D146
Pipe Coupling	
 Single Socket Coupling	D124
 Double Socket Coupling Removable centre stop for use as Slip coupling	D105
Single Socket Bends	
 87½° Bend (Socket/Spigot)	D161
 45° Bend (Socket/Spigot)	D163
 30° Bend (Socket/Spigot)	D164
 15° Bend (Socket/Spigot)	D167
Double Socket Bends	
 87½° Bend	D561
 45° Bend	D563
 30° Bend	D564
 15° Bend	D567
 87½° Rest Bend	D571
 87½° Settlement Rest bend	D570
 0-90° Adjustable Bend	D560
110mm non-return valve	
 110mm Non-Return Valve-Single Flap	CE D550

Product	Code
Large Radius Bends	
 87½° Plain End	D281
 45° Plain End	D283
 87½° PE with Channel Access	D581
 45° PE with Channel Access	D583
Equal Junctions	
 87½° Junction (Double Socket)	D190
 45° Junction (Double Socket)	D210
 87½° Junction (Triple Socket)	D191
 45° Junction (Triple Socket)	D211
Access Fittings	
 87½° Access Bend (Socket/spigot)	D169
 Access Pipe (Socket/spigot)	D274
 Screwed Access Aap	D292
 Channel Access Pipe PE 1.5m	D870
Rodding Points	
 PCV Oval Rodding Point (Spigot)	D881
 PCV Oval Rodding Point (Socketed)	D882
 PCV Square Rodding Point (Spigot)	D883
 PCV Square Rodding Point (Socketed)	D884
(45 rodding point with sealed access cover suitable for loading up to 10kN (1 tonne) where the frame of the cover is supported by a concrete plinth)	
DrainGuard	
 Fits round and square downpipe (Black)	DG1

Underground Drainage Systems

Underground Drainage System PVC-U

BS 4660:2000, BS EN 1401-1:2009, BS EN 124:1994,
BS EN 13476-2:2007



110mm Pipe & Fittings, PVC-U

Product	Code
Universal Traps	
Universal Gully Trap (Socket/Spigot 45°)	D500
Low Back 'P' Trap	D501
Leaf/Debris Interceptor Gully (Black)	D94
Spare Square Grid	D502

Product	Code
Universal Traps	
Square Blank Cover Grid	D508
Square Hopper Including Polypropylene Grid	D504
Rectangle Blank Cover Grid	D507
Rectangular Hopper Including Polypropylene Grid	D506

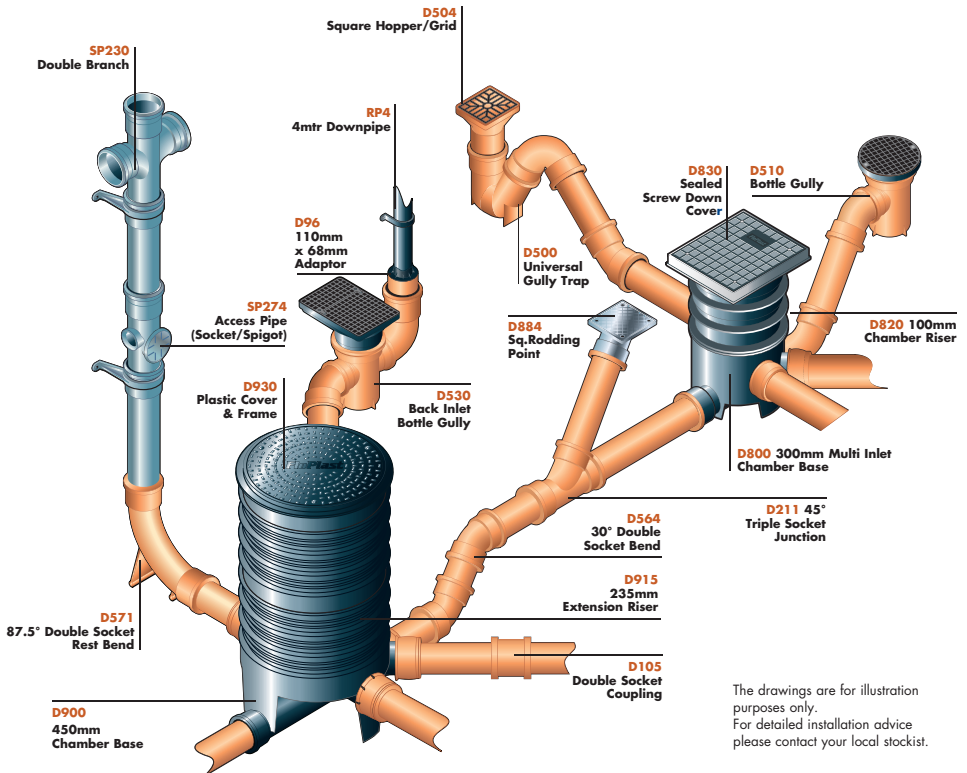

The drawings are for illustration purposes only.
For detailed installation advice please contact your local stockist.

Underground Drainage Systems

Underground Drainage System PVC-U

110mm Fittings, PVC-U

BS 4660:2007, BS EN 1401-1:2009, BS EN 124:1994,
BS EN 13598-2:2009, BS EN 13598-1:2010



Product	Code
Bottle Gully Traps	
Bottle Gully Circular Grid	D510
NEW Bottle Gully Square Grid	D515
Bottle Gully Rectangular Grid	D520
Back Inlet Bottle Gully Rectangular Grid	D530
Back Inlet Bottle Gully Circular Grid	D540
Round Hopper and Grid	D514
NEW Square Hopper and Grid	D518
Rectangular Hopper and Grid	D524
200mm Riser	D505

Product	Code
Adaptors	
110x50mm Waste Adaptor (Grey/Black/White)	SP95
110x68mm Rainwater Adaptor (Grey/Black/White)	SP96
Universal Waste Adaptor (32/40/50mm)	D95
Universal Rainwater Adaptor (Square/Round)	D96
80x110mm Adaptor	D97
160x110mm Level Invert (Socket/Spigot)	D99
Supersleve Clay Adaptor DS (Black)	D100
Hepsleve Clay Adaptor DS (Black)	D101

Product	Code
Drain Connector	
(Black/Grey only)	SP107
Flexible Couplings, Connectors and Adaptors	
Coupling 98mm-115mm	D102
Adaptor A: 98mm-115mm B: 120mm-136mm	D103
Socket Plug	
	D296

Bottle Gully with rectangular hopper

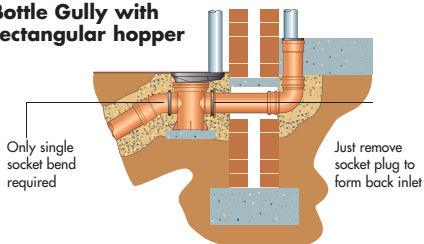

Bottle Gully with circular hopper

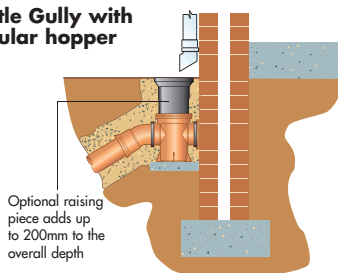

The drawings are for illustration purposes only.
For detailed installation advice please contact your local stockist.

Underground Drainage Systems

Underground Drainage System PVC-U

BS 4660:2007, BS EN 1401-1:2009, BS EN 124:1994,
BS EN 13598-2:2009, BS EN 13598-1:2010



110mm Fittings, PVC-U

Product	Code
Large Inspection Chamber - 450mm Diameter (LIC)	
 270mm Deep Chamber Base - 5x110mm flexible inlets / Supplied with 4 socket plugs (Allows for 0-20° of movement)	D900
 270mm Deep Chamber Base - 5x110mm fixed inlets / Supplied with 4 socket plugs	D910
 235mm Extension Riser (Can be cut to size)	D915
 Riser Sealing Ring (Use with each Riser)	D935
 450mm Plastic Cover & Frame (35 kN)	D930*
 450mm Plastic Cover Frame with 350mm Restricted Access (35 kN) (For use with I.C. over 1.2mtr deep up to 3mtr)	D931*
 Cast Iron Cover & Plastic Frame (35 kN) (For replacement purposes only)	D923
 Block Paving Cover 450mm Square/Round	D933
 450mm Ductile Iron Cover/Frame (B125) Conforms to the requirements of SFA7.	D934

*To conform with new document H Building Regulations H2000 use D930 or D931 as required.



Product	Code
Mini Access Chamber - 300 Diameter (MAC)	
 270mm Deep Multi Inlet Chamber Base - 5x110mm flexible inlets / Supplied with 4 socket plugs (Allows for 0-20° of movement)	D800
 270mm 45° Inlet Chamber Base - 3x110mm flexible inlets / Supplied with 2 socket plugs (Allows for 0-20° of movement)	D801
 270mm 90° Inlet Chamber Base - 3x110mm flexible inlets / Supplied with 2 socket plugs (Allows for 0-20° of movement)	D802
 270mm 45° Inlet Chamber Base - 3x110mm Fixed inlets / Supplied with 2 socket plugs	D810
 100mm Chamber Riser With integral rubber ring (60mm cut down facility)	D820
 200mm Chamber Riser With integral rubber ring (60/100/150mm cut down facility)	D822
 340mm Sealed Screw Down Cover and Frame (35kN)	D830
 Block Paving Cover 300mm Square/Round	D932



Underground Drainage Systems

Underground Drainage System PVC-U

160mm Pipe & Fittings, PVC-U



Product	Code
Pipe	
 Plain Ended (bale quantity 33)	6m 6D046
 Single Socket (bale quantity 33)	3m 6D143 6m 6D146
Pipe coupling	
 Double Socket Coupling Removable centre stop for use as slip coupling	6D105
Single socket bends	
 87½° Bend (Socket/spigot)	6D161
 45° Bend (Socket/spigot)	6D163
 30° Bend (Socket/spigot)	6D164
 15° Bend (Socket/spigot)	6D167
Double socket bends	
 87½° Bend	6D561
 45° Bend	6D563
 30° Bend	6D564
 15° Bend	6D567
Adaptors	
 160x110mm Level Invert (Socket/spigot)	D99
 Flexi-Adaptor Cast iron/160mm	CE 6D102
 Clay Adaptor A: 160mm-180mm B: 180mm-200mm	CE 6D104
Equal junctions	
 87½° Junction (Double Socket)	6D190
 45° Junction (Double Socket)	6D210
 87½° Junction (Triple Socket)	6D191
 45° Junction (Triple Socket)	6D211
160/110mm Unequal junctions	
 160x110mm 87½° Junction (Double socket)	6D198
 160x110mm 45° Junction (Double socket)	6D218

Product	Code
160mm Large Inspection Chamber - 450 Diameter (LIC)	
 160mm x 160mm 90° Chamber Base With two 45° 110mm Inlets	6D900
Use a proprietary adhesive such as Siroflex MS Polymer or CT1 Sealant & Construction Adhesive to seal first riser to base.	
 235mm Extension Riser (Can be cut to size)	D915
 Riser Sealing Ring (Use with each riser)	D935
 450mm Plastic Cover & Frame (35 kN)	D930*
 450mm Plastic Cover & Frame With 350mm restricted access (35 kN) (For use with I.C. over 1.2mtr deep up to 3mtr)	D931* 
 Cast Iron cover & Plastic Frame (35 kN)	D923
*To conform with new document H Building Regulations H2000 use D930 or D931 as required.	
800gm Lubricant Gel	
	SG800



Underground Drainage Systems

FloDrain 110mm Domestic Channel Drainage BS EN 1433:2002 Attestation level 3

Polypropylene/ABS



Product	Code
Channel - 1 Metre length including grate (Pallet quantity 90)	
	CE D700

Product	Code
Channel Drain with Galvanised Grate (Pallet quantity 90)	
	CE D701

Product	Code
Drain Corner	
	CE D710

Product	Code
Drain Corner with Galvanised Grate	
	CE D720

Product	Code
Garage Pack (Pallet quantity 16)	
	CE D750
(Consists of 3x1m Channel lengths plus 1x End cap & 1x End outlet)	

Product	Code
Galvanised Garage Pack (Pallet quantity 16)	
	CE D751
(Consists of 3x1m Channel lengths plus 1x End cap & 1x End outlet)	

Product	Code
End Cap	
	D711

Product	Code
Sump/Trap Unit and Basket	
	D732

Product	Code
End Outlet	
	D712

Product	Code
Threshold Channel Drain - 1m	
	D730

Channel Drain system features

- Suitable for domestic areas where surface water collects:
 - Driveways and pathways
 - Patios and conservatories
 - Swimming pools and sports areas
 - Gardens and water features
 - Retaining walls
- Quality domestic surface Channel Drainage 110mm x 100mm.
- Anti-slip heel guard grating.
- Garage Pack available (3 x 1m lengths, End cap and Outlet).
- Manufactured to BS EN 1433, with a load class A15 - 1.5 tonne.
- 4 outlets per length for maximum flexibility.
- Quad section for corners and junctions.
- Concave grid for maximum flow.

Product	Code
Channel Drain Jointing Clip	
	D734



MDPE Pipe







*50mm & 63mm sizes available to special order







Medium Density Polyethylene Pipe (MDPE) 12 Bar								
Nom Size O.D	Code	Price 25m Coil	Code	Price 50m Coil	Code	Price 100m Coil	Code	Price 150m Coil
20mm	111601	34.32	111602	68.60	111603	131.08	111604	196.47
25mm	112601	42.10	112602	84.16	112603	160.14	112604	240.22
32mm	113601	67.49	113602	134.97	113603	254.60	113604	381.97

Fittings for MDPE Pipe

'Supreme' Compression fittings for MDPE pipe BS EN 12201-3:2011

FloPlast 'Supreme' range offers everything you could ask of a compression fitting. They are suitable for use below ground on cold water services with polyethylene pipes manufactured in accordance with the requirements of BS EN 12201 - 2 : 2011 (BLUE). 

Product	Code	Size
Stopcock-Plastic		
	491042	20mm
	492042	25mm
Pipe Liner		
	491000	20mm
	492000	25mm
	493000	32mm
Adaptors Kit for copper pipe BS EN 1057 (Pull out resistant) For use with Stopcocks only		
15mm Copper	491003	20mm
22mm Copper	492003	25mm
Universal Adaptors Fits plastic, lead, copper and zincplated pipes		
15-21mm	491007	20mm
15-21mm	492007	25mm
21-27mm	492008	25mm
27-34mm	492009	25mm
		
Terminal Cap		
	491006	20mm
	492006	25mm
	493006	32mm
Coupling		
	491012	20mm
	492012	25mm
	493012	32mm
	495012*	50mm
	496012*	63mm
Reducing Coupling		
	492113	25x20mm
	493213	32x25mm
	495313*	50x32mm

Product	Code	Size
Wall Plate Elbow		
	491105	20mm x 1/2"
	492205	25mm x 3/4"
90° Elbow		
	491015	20mm
	492015	25mm
	493015	32mm
	495015*	50mm
	496015*	63mm
90° Tee		
	491024	20mm
	492024	25mm
	493024	32mm
	495024*	50mm
	496024*	63mm
Male Adaptor		
	491102	20mm x 1/2"
	491202	20mm x 3/4"
	492102	25mm x 1/2"
	492202	25mm x 3/4"
	492302	25mm x 1"
	493202	32mm x 3/4"
	493302	32mm x 1"
Female Adaptor		
	491103	20mm x 1/2"
	491203	20mm x 3/4"
	492103	25mm x 1/2"
	492203	25mm x 3/4"
	492303	25mm x 1"
	493203	32mm x 3/4"
	493303	32mm x 1"
Reducing 90° Tee		
	492125	25x20x25mm
	493225	32x25x32mm
	495325*	50x32x50mm



FloPlast 'Supreme' range of MDPE compression fittings are a Water Regulations Advisory Scheme Approved Product. (Certificate No. 1112064)





FloFit Hot & Cold Plumbing Systems

Flofit PE-X Pipe								
Nom Size O.D	Code	Price 25m Coil	Code	Price 50m Coil	Code	Price 100m Coil	Code	Price 3m Length
10mm	N/A	N/A	120402	77.15	N/A	N/A	N/A	N/A
15mm	121401	44.57	121402	89.17	121403	178.32	121400	5.57 (20 per pack)
22mm	122401	89.17	122402	178.32	N/A	N/A	122400	11.10 (20 per pack)

Push-fit Fittings for FloFit Pipe

FloFit is a flexible and fully demountable push-fit plumbing system. The product is suitable for all domestic and small commercial hot & cold water installations, including central heating for both pressurised (unvented) and combi (vented) systems. FloFit enables the installer to undertake a faster, easier and more cost effective installation. Independent testing confirms time-saving of up to 40% compared with traditional methods. FloFit Fittings are manufactured in accordance with BS7291. PT: 1/2/3 and are a . (All FloFit pipe is kitemarked to BS7291 Parts 1 & 3, Class S, Licence no 36801  and WRAS approved).

Product	Code	Size
Straight Couplings		
	FC10	10mm
	FC15	15mm
	FC22	22mm

Product	Code	Size
Reducing Couplers		
	FRC15	15x10mm
	FRC22	22x15mm

Product	Code	Size
Elbows		
	FB10	10mm
	FB15	15mm
	FB22	22mm

Product	Code	Size
Equal Tees		
	FT10	10mm
	FT15	15mm
	FT22	22mm

Product	Code	Size
Reducing Tees		
	FRT151010	15x10x10mm
	FRT151510	15x15x10mm
	FRT151522	15x15x22mm
	FRT221515	22x15x15mm
	FRT222210	22x22x10mm
	FRT222215	22x22x15mm

Product	Code	Size
Stem Elbows		
	FS10	10mm
	FS15	15mm

Product	Code	Size
Tap Connectors		
	FTC1512	15mm x 1/2"
	FTC1534	15mm x 3/4"
	FTC2234	22mm x 3/4"

Product	Code	Size
Bent Tap Connectors		
	FBC1512	15mm x 1/2"

Product	Code	Size
Stop Ends		
	FE10	10mm
	FE15	15mm
	FE22	22mm

Product	Code	Size
Polybutylene Inserts (Blue) (Pack 50)		
	FPI15	15mm
	FPI22	22mm

Product	Code	Size
PE-X Inserts (White) (Pack 50)		
	FXI10	10mm
	FXI15	15mm
	FXI22	22mm

Product	Code	Size
Blue Collet Clips (Cold water use) (Pack 50)		
	FCB10	10mm
	FCB15	15mm
	FCB22	22mm

Product	Code	Size
Red Collet Clips (Hot water use) (Pack 50)		
	FCR10	10mm
	FCR15	15mm
	FCR22	22mm

Product	Code	Size
Pipe Cutters		
	FFC1	

Product	Code	Size
Chrome ISO Valve		
	FV15	15mm x 15mm

Product	Code	Size
Flexi - Hoses		
	FH10	15mm x 1/2" x 300mm
	FH11	15mm x 1/2" x 500mm
	FH20	22mm x 3/4" x 300mm
	FH21	22mm x 3/4" x 500mm
	FH15	15 x 15 x 300mm

Product	Code	Size
ISO Valve / Flexi - Hose		
	FH30	15mm x 1/2" x 300mm

FloPlast

building the future

FloPlast Limited
 Castle Road
 Eurolink Business Park
 Sittingbourne
 Kent ME10 3FP
 UK

Tel: 01795 431731
 Sales Office Direct Line:
01795 421422

Fax:
01795 431188

E-mail:
sales@floplast.co.uk

Website:
www.floplast.co.uk



Systems available:

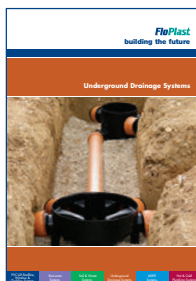
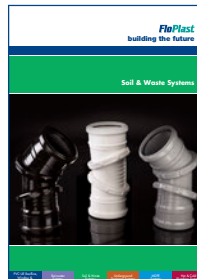
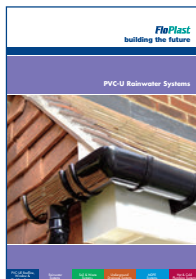
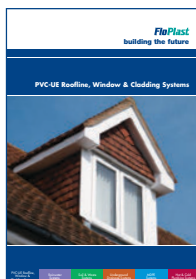

KM 501316



KM 512474



KM 544331



KM 548614



KM 36801



KM 563461



KM 544332



KM 563460



KM 572704



KM 563462



15/10/15

PVC-UE Roofline,
 Window &
 Cladding Systems

Rainwater
 Systems

Soil & Waste
 Systems

Underground
 Drainage Systems

MDPE
 Systems

Hot & Cold
 Plumbing Systems