

USER MANUAL
USER INSTRUCTIONS

WORCESTER GREENSTORE LECP GROUND SOURCE HEAT PUMP IN EITHER SYSTEM OR COMBI VARIANTS

6KW, 7KW, 9KW AND 11KW



6 720 802 172-01.11



CONTENTS

1	Key to symbols and safety instructions	2
1.1	Key to symbols	2
1.2	Safety instructions	3
2	The Benchmark Scheme	3
3	Ground source heat pump operation	3
3.1	Selection and sizing of a heat pump	3
4	Heat emitters	3
5	Use	4
5.1	General	4
5.2	Heat pump function	4
6	Energy measurement	5
7	Control unit	6
7.1	Additional heat	6
7.2	Hot water production	6
8	Control panel	6
8.1	Panel overview	6
8.2	On/Off button	6
8.3	Status lamp	6
8.4	Menu display	6
8.5	Menu button and menu dial	6
8.6	Return button	6
8.7	Mode button	6
8.8	Info button	6
9	Menu overview	7
10	Menu navigation	7
10.1	Initial menu	7
10.2	Finding desired function and changing values	7
10.3	Help information in the menu display	8
11	Information from the heat pump	9
11.1	Operating information	9
11.2	Info button	9
11.3	Operating symbols	9
12	Heating, general	10
12.1	Circuits for heating	10
12.2	Control methods for heating	10
12.3	Time control for heating	10
12.4	Operating modes	11

13	Settings	11
13.1	Mode button functions	11
13.2	Room temperature	11
13.3	Hot water	15
13.4	Holiday	16
13.5	Energy measurements	16
13.6	Timers	16
13.7	External control	16
13.8	General	17
13.9	Alarms	17
13.10	Access level	18
13.11	Return to factory settings	18
14	Alarms	18
14.1	Control unit and room controller alarm lamp	18
14.2	Alarm buzzer at alarm	18
14.3	Acknowledgement of alarms	18
14.4	Alarm timer, alarm mode	18
14.5	Alarm categories	19
14.6	Alarm window	19
14.7	Alarm functions	19
14.8	Warnings	22
14.9	Information log	23
15	Energy savings	24
16	Maintenance	24
16.1	Checking the safety valves	24
16.2	Expansion vessel	24
16.3	Particle filter	24
17	The guarantee	24

1 KEY TO SYMBOLS AND SAFETY INSTRUCTIONS

1.1 KEY TO SYMBOLS

WARNINGS

	<p>Warnings in this document are identified by a warning triangle printed against a grey background. Keywords at the start of a warning indicate the type and seriousness of the ensuing risk if measures to prevent the risk are not taken.</p>
---	--

The following keywords are defined and can be used in this document:

- **NOTE** indicates a situation that could result in damage to property or equipment.
- **CAUTION** indicates a situation that could result in minor to medium injury.
- **WARNING** indicates a situation that could result in severe injury or death.
- **DANGER** indicates a situation that will result in severe injury or death.

IMPORTANT INFORMATION



This symbol indicates important information where there is no risk to people or property.

ADDITIONAL SYMBOLS

Symbol	Explanation
▶	Step in an action sequence
→	Cross-reference to another part of the document
•	List entry
-	List entry (second level)

Table 1

1.2 SAFETY INSTRUCTIONS

GENERAL

- ▶ Read the guide carefully and keep it to hand for future use.

INSTALLATION AND COMMISSIONING

- ▶ The heat pump may be installed and put into operation only by a competent person.

RISK OF DAMAGE DUE TO OPERATOR ERROR

Operator errors can result in injury and damage to property.

- ▶ Ensure that children never operate this appliance unsupervised or play with it.
- ▶ Ensure that only personnel who can operate this appliance correctly have access to it.

SERVICE AND MAINTENANCE

- ▶ Only competent persons may carry out repairs. Incorrect repairs can lead to serious risks to the user, and a reduction in savings.
- ▶ Only use original spare parts.
- ▶ Service and maintenance must be carried out annually by a competent person.

2 THE BENCHMARK SCHEME

Worcester, Bosch Group is a licensed member of the Benchmark Scheme which aims to improve the standards of installation and commissioning of domestic heating and hot water systems in the UK and to encourage regular servicing to optimise safety, efficiency, performance and to comply with the F gas regulations.

Please ensure that the installer has fully completed the Benchmark Checklist on the inside back pages of the installation instructions supplied with the product and that you have signed it to say that you have received a full and clear explanation of its operation. The installer is legally required to complete a commissioning checklist as a means of complying with the appropriate Building Regulations (England and Wales).

All installations should be made in accordance with MCS/MIS 3005.

This product should be serviced regularly to optimise its safety, efficiency and performance. The service engineer should complete the relevant Service Record on the Benchmark Checklist after each service.

The Benchmark Checklist may be required in the event of any warranty work and as supporting documentation relating to home improvements in the optional documents section of the Home Information Pack.

3 GROUND SOURCE HEAT PUMP OPERATION

As the outside temperature gets colder, the heat demand of a house increases and the output of a ground source heat pump will decrease. Eventually it becomes so cold outside that the output of the heat pump alone is not able to heat the building effectively. The Greestore range of ground source heat pumps therefore allows for monoenergetic and bivalent operation.

Monoenergetic means that in the event of very low external temperatures a 3-stage electrical booster heater in the indoor unit will automatically be activated to provide additional heat if required and keep the building warm.

In bivalent operation a second heating appliance (e.g. gas or oil boiler) is used to supplement the heat load.

3.1 SELECTION AND SIZING OF A HEAT PUMP

It is essential that heat pump systems are designed to operate efficiently in order to meet the building heating needs and the expectations of the customer. In order to achieve this, the following design activities must be completed prior to installation:-

- Pre-design assessment - Determine the suitability of a heat pump system for the building based on the customer requirements, expectations and building type.
- Detailed design - Complete building heat loss calculations and domestic hot water usage assessment.
- Specification - Select a suitable heat pump and system components based on the detailed design. Calculate and communicate the predicted energy use and running costs of the system to the customer.

A suitable design methodology for the above is detailed in MIS3005, the Microgeneration Certification Scheme (MCS) heat pump installer standard. Worcester, Bosch Group recommended that this standard is followed for heat pump systems. The standard covers the design, installation and commissioning requirements to ensure that 100% of the building heat loss can be met efficiently by the heat pump system. A heat pump system must be designed to this standard to be eligible for government financial incentives e.g. Renewable Heat Incentive (RHI).

The Worcester Bosch Group design team offer a heat pump sizing service which is MCS compliant. To request this service, download and submit the form using the guidance notes from our website address:

www.worcester-bosch.co.uk/hp

4 HEAT EMITTERS

Worcester, Bosch Group heat pumps are fitted with weather compensation controls as standard. However, for a heat pump to perform to its highest energy efficiency, the central heating emitter circuit should be designed so that the flow temperature is as low as possible.

As a guide, the system should be designed using the following maximum flow temperatures;

- Underfloor heating: 35-40 °C
- Radiators: 45-50 °C

If underfloor heating has been installed, it is important to remember that the underfloor system designer should have been informed that the heat source will be from an air source heat pump. It is also important to remember that radiators should have been correctly sized to work effectively with lower flow temperatures.

A tool to aid installers and end users to understand the relevance of building heat loss and heat emitter selection on heat pump performance, has been created by the joint trade associations. The 'Heat Emitter Guide' can be downloaded from the following website:

www.microgenerationcertification.org

5 USE

5.1 GENERAL

The Worcester Greenstore series is equipped with the latest generation low energy circulation pumps on both the cold and hot sides. Low energy circulation pumps are being introduced in line with future European legislation. They are designed to improve the system efficiency.

When purchasing the equipment, the installation engineer must make an energy estimate and assess the degree of energy coverage for the heat pump system in line with current guide lines.

Greenstore Combi/System is a series of heat pumps that use stored solar energy in order to provide water-based heating and hot water.

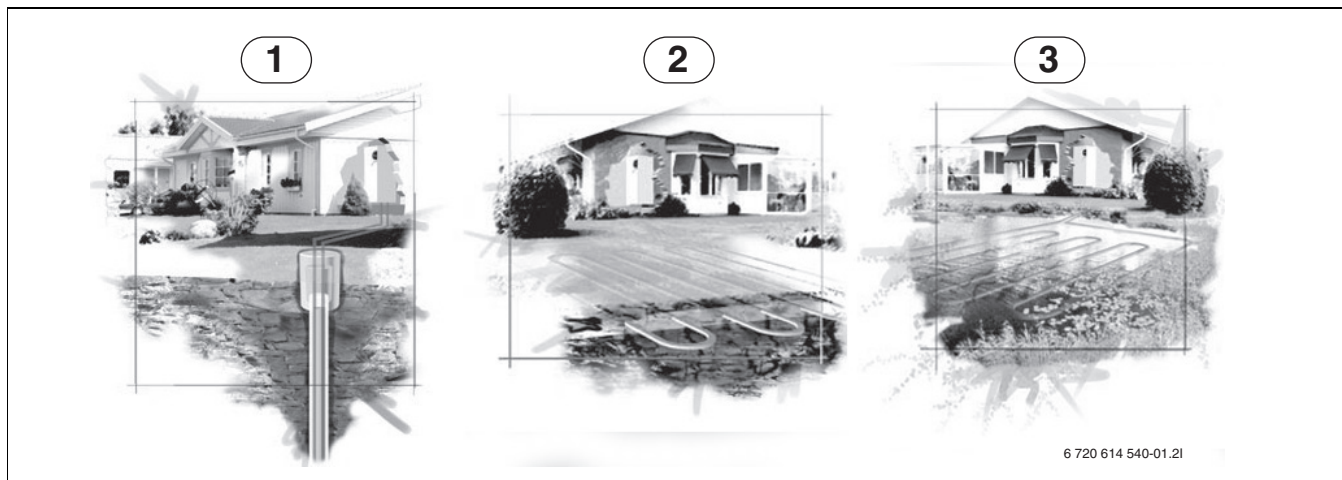

Fig. 1 Stored solar energy

- [1] Rock heat
- [2] Soil heat
- [3] Lake heat

Greenstore 6-11 Combi are heat pumps with integrated domestic hot water cylinders.

Greenstore 6-11 System are heat pumps designed to be supplemented with external domestic hot water cylinders.

Once the heat pump has been installed and started, there are a number of points that should be checked regularly. This may concern an alarm triggering or performing basic maintenance actions. If the problem is repeated, you should contact your installer.

5.2 HEAT PUMP FUNCTION

The heat pump consists of four main parts:

- **Evaporator**
Evaporates the refrigerant to gas and at the same time transfers the heat from the collector to the refrigerant circuit.
- **Condenser**
Condenses the gas to fluid again and transfers the heat to the heating system.
- **Expansion valve**
Lowers the pressure of the refrigerant.
- **Compressor**
Increases the pressure of the refrigerant.

These four main parts are linked in three circuits. A refrigerant circulates in the heat pump, which in some parts of the circuit is in a liquid state and in other parts in a gas state.

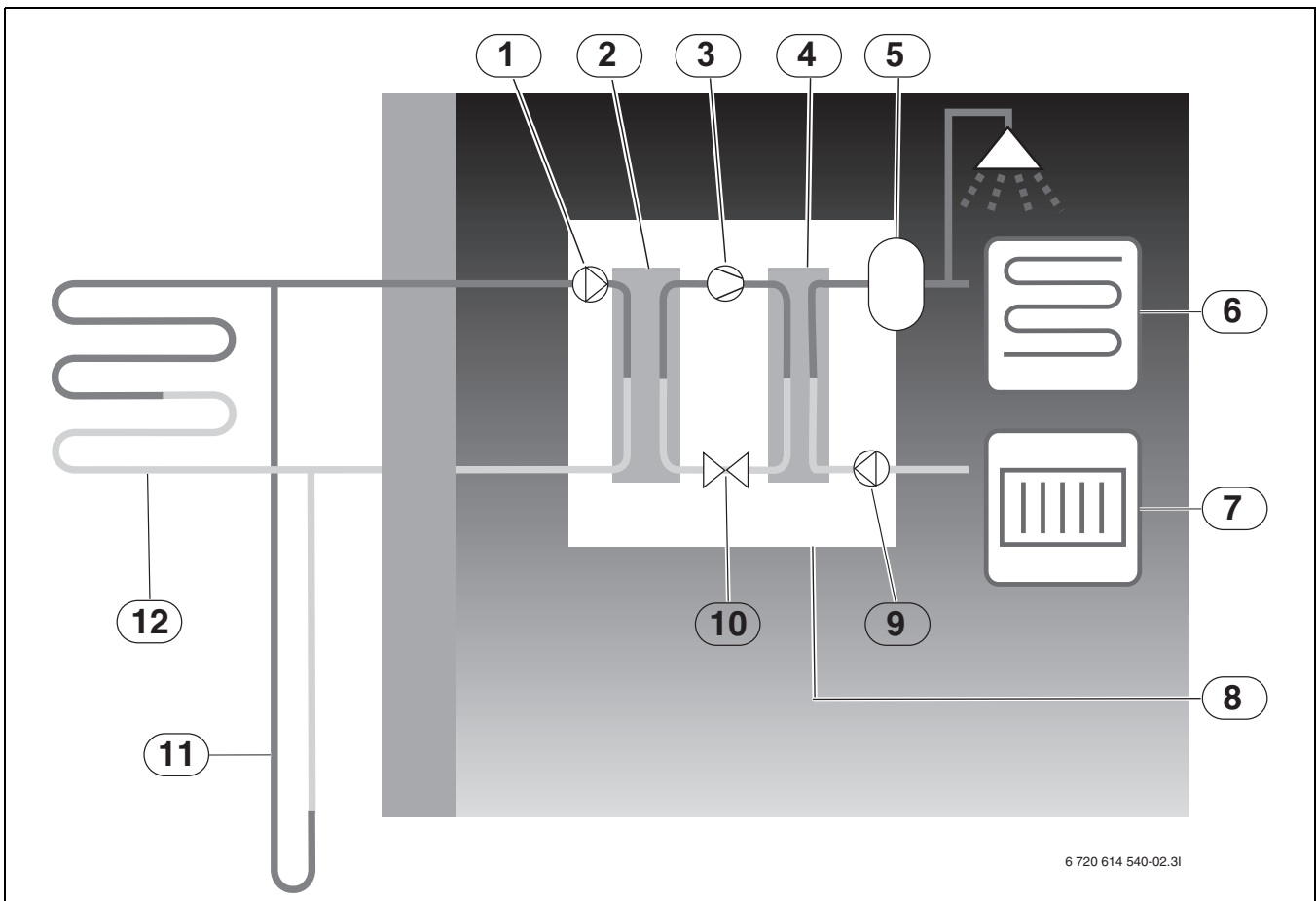

6 720 614 540-02.3I

Fig. 2 Heat pump description

- [1] Collector circuit pump
- [2] Evaporator
- [3] Compressor
- [4] Condenser
- [5] Heat pump domestic hot water cylinder
- [6] Floor heating
- [7] Radiator
- [8] Heat pump
- [9] Heat carrier pump
- [10] Expansion valve
- [11] Borehole
- [12] Geothermal heating coil (horizontal loop/compact collector)

- The collector circuit fluid, which is a mixture of water and anti-freeze, circulates in the borehole/geothermal heating coil in a plastic hose. The fluid collects stored solar energy and with the help of the collector circuit pump leads it into the heat pump and to the evaporator. The temperature is then approximately 0 °C.
- In the evaporator the collector circuit fluid meets the refrigerant. The refrigerant is then in a fluid state and is at approximately -10 °C. When the refrigerant meets the zero degree heat transfer fluid, it starts to boil. Vapour forms and is led into the compressor. The temperature of the vapour is approximately 0 °C
- In the compressor, the pressure on the refrigerant increases and the temperature of the vapour rises to approximately +100 °C. The hot vapour is then forced into the compressor.
- In the condenser the heat is transferred to the house heating system (radiators and underfloor heating) and the hot water system. The vapour cools and liquefies. The pressure in the refrigerant is still high when it is led on to the expansion valve.
- The pressure of the refrigerant is reduced in the expansion valve. The temperature also drops to approximately -10 °C. When the refrigerant passes the evaporator it changes to vapour again.

- The collector circuit is led out from the heat pump to the borehole/geothermal heating coil to collect new stored solar energy. The temperature of the fluid is then approximately -3 °C.

6 ENERGY MEASUREMENT

The control unit has the ability to measure the amount of energy that is produced by the heat pump unit. The calculation assumes that, for example, the heat pump is correctly installed and that the flow and Δ temperatures on the hot and cold sides are adjusted as recommended. The value should therefore be regarded as an estimate of the actual emitted output. The margin of error in the calculation is normally put at 5-10%.

In addition, the energy output is affected by the outdoor temperature, the settings for the thermostat and room controls and heat pump usage. Ventilation, indoor temperature and hot water demand can play a decisive role.

7 CONTROL UNIT

The control unit controls and monitors the heating and hot water production with the heat pump and additional heat. The monitoring function shuts down the heat pump in the event of a fault so as to prevent damage to critical parts of the pump.

7.1 ADDITIONAL HEAT

The additional heat becomes active in the event of emergency operation, extra hot water and hot water peak.

The additional heat is provided through electric additional heat.

The Multi module accessory is required for mixed additional heat.

The control unit will automatically activate the additional heat, when needed.

7.2 HOT WATER PRODUCTION

Hot water is heated in the domestic hot water cylinder and the control unit gives priority to hot water before production of heating water according to the settings that are made. The domestic hot water cylinder is fitted with a sensor that senses the temperature of the domestic hot water.

8 CONTROL PANEL

Settings for the control of the heat pump are made with the control unit's control panel, which also provides information about current status.

8.1 PANEL OVERVIEW

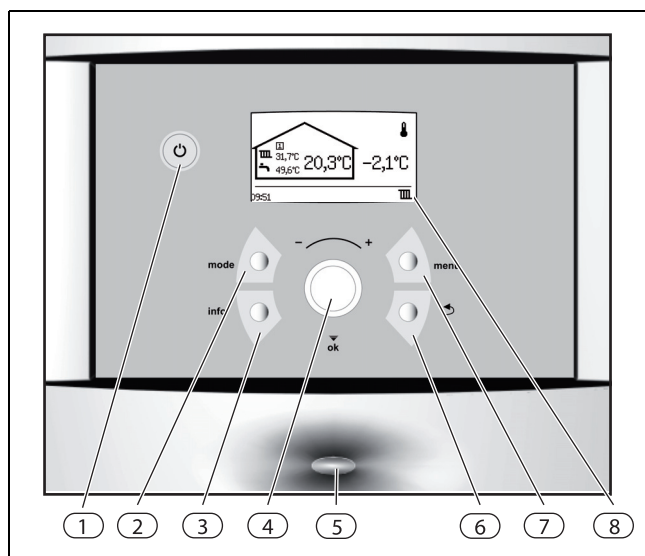

Fig. 3 The control panel

- [1] On/Off button
- [2] Mode button
- [3] Info button
- [4] Menu dial
- [5] Status lamp
- [6] Return button
- [7] Menu button
- [8] Menu display

8.2 ON/OFF BUTTON

Use the On/Off button to turn the heat pump on and off.

8.3 STATUS LAMP

<i>The lamp lights continuously.</i>	The heat pump is running.
<i>The lamp flashes rapidly.</i>	There is an alarm that has not been acknowledged.
	The alarm has been acknowledged but the alarm cause remains.
<i>The lamp flashes slowly, menu window not lit.</i>	The heat pump is in stand-by mode ¹ .
<i>The lamp and menu display not lit.</i>	No voltage to the control unit.

Table 2 Lamp functions

1) Stand-by means that the heat pump control unit has been turned off but with electrical power still supplied to the unit.

8.4 MENU DISPLAY

Use the menu display in order to:

- View information from the heat pump.
- View available menus.
- Change set values.

8.5 MENU BUTTON AND MENU DIAL

Use **menu** to get from *Initial menu* to the menus. Use the menu dial in order to:

- Navigate the menus and get to the setting displays.
 - Turn the dial to see more menus on the same level or change a set value.
 - Press the dial to change to a lower menu level or save a change.

8.6 RETURN BUTTON

Use **return** to:

- Go back to the previous menu level.
- Leave a setting display without changing the set value.

8.7 MODE BUTTON

Use **mode** to change type of operation.



The controller language can be changed with the **mode** button.

- ▶ Press the **mode** button in the initial menu for at least 5 s, then select the required language.

8.8 INFO BUTTON

Use **info** to see information from the control unit about operating mode, temperature, program version, etc.

9 MENU OVERVIEW

Room temperature	Circuit 1 Heating (Heat curve, Compressor x operating time on/off, Room temperature program) Circuit 2, 3... (option) (Heat curve, Room temperature program) General (Summer/winter operation)
Hot water	Extra hot water (period, Stop temperature) Hot water peak (Day of the week, Interval, Time) Hot water program Hot water mode
Holiday	Circuit 1 and Hot water Circuit 2, 3... (option)
Energy measurements	Generated energy Consumption electric additional heat
Timers	Active timers are shown, e.g. Extra hot water duration
External control	Heat pump x (External input 1, 2, External input circuit 2, 3... (option))
General	Room sensor settings (room controller) Set date Set time Summer/winter time Display contrast Language
Alarms	Information log Delete information log Alarm log Delete alarm log Alarm indication (Alarm buzzer signal, Alarm indication control unit and Room sensor (room controller))
Access level	
Return to factory settings	

Table 3 Menu overview

10 MENU NAVIGATION

10.1 INITIAL MENU

Initial menu shows different temperatures, time, as well as current operating symbols. The window displays information alternately **Room temperature** (if room controllers exist) and **Flow temperature** for each circuit installed.

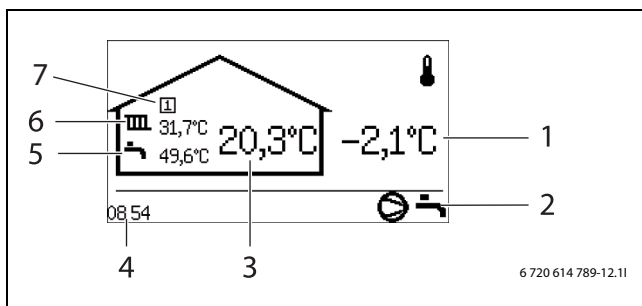

Fig. 4 Initial menu

- [1] Outdoor temperature
- [2] Current operating symbols
- [3] The circuit room temperature
- [4] Current time
- [5] Hot water temperature
- [6] Circuit flow temperature
- [7] Circuit number

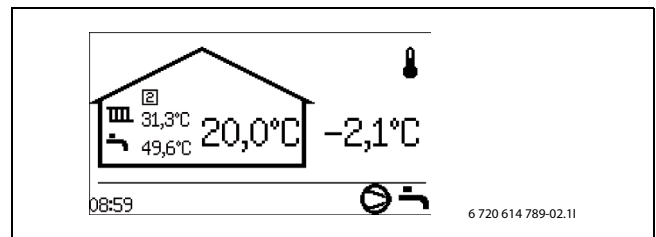

Fig. 5 Initial menu, circuit 2 is shown if installed

10.2 FINDING DESIRED FUNCTION AND CHANGING VALUES

Menu overview (→ Page 7) shows the main functions that are reached with **menu** and the dial.

► Press **menu**.

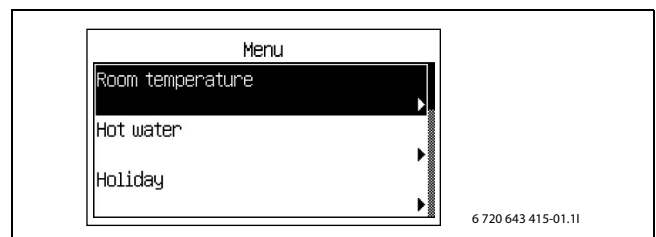

Fig. 6

MENU NAVIGATION

► Turn the dial to mark a desired menu bar.

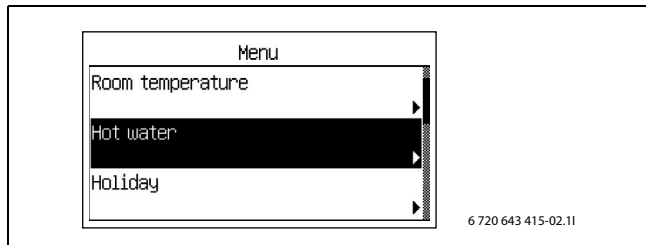

Fig. 7

► Select the function by pressing the dial. The first three menu functions under *Hot water* are displayed.

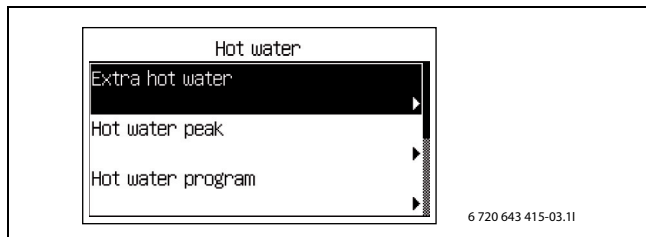

Fig. 8

► Turn the dial to see other menu lines.

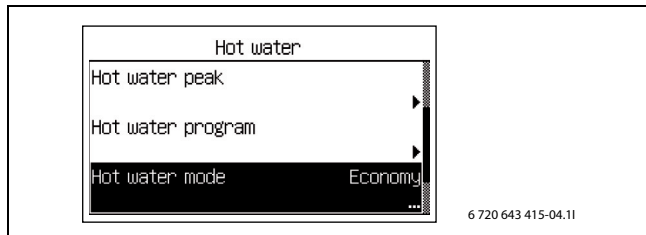

Fig. 9

► Press the dial to select the function.

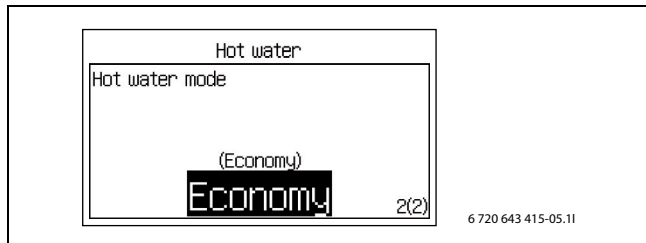

Fig. 10

► Turn the menu dial to change the set value.

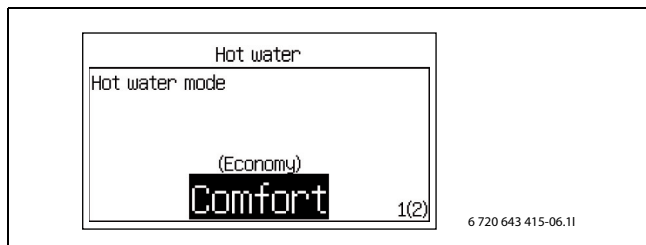

Fig. 11

► Press the dial to save the value or use to return without changing.

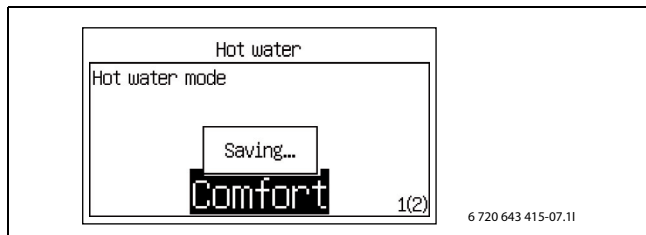

Fig. 12

The control unit automatically returns to the menu when the value has been saved.

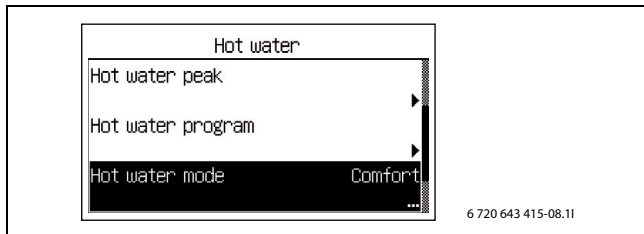

Fig. 13



Economy and **Comfort** are explained in more detail in the chapter about hot water mode (→ Chapter 13.3).

10.3 HELP INFORMATION IN THE MENU DISPLAY

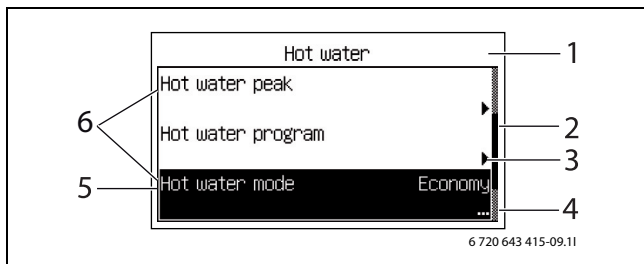

Fig. 14 Help information 1

- [1] The menu level is **Hot water**
- [2] Drop-down list. The marked row shows your position among the functions under **Hot water**.
- [3] The arrow shows that there is new menu on the next level.
- [4] The points show that the next level is a setting window.
- [5] The function is marked.
- [6] Three of the functions under **Hot water**.

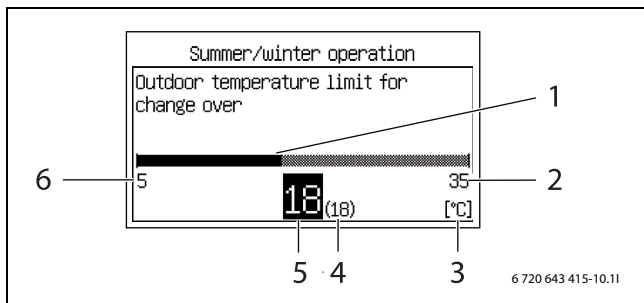

Fig. 15 Help information 2

- [1] Graphic display of the value.
- [2] Highest possible value.
- [3] Unit.
- [4] Previous value.
- [5] New value. (Saved when the menu dial is pressed.)
- [6] Lowest possible value

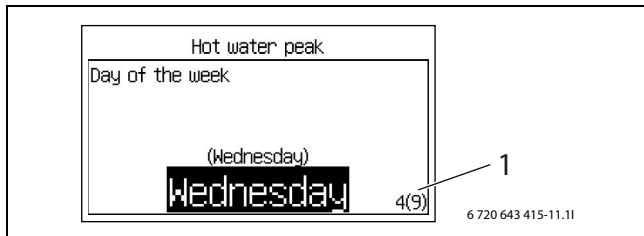

Fig. 16 Help information 3

- [1] Option 4 out of 9 is displayed.

11 INFORMATION FROM THE HEAT PUMP

The heat pump provides information about temperatures, operating modes, possible alarms, etc.

11.1 OPERATING INFORMATION

The *Initial menu* shows different temperatures and times of day. Different operating symbols show the functions for which there are demand or which are in operation.

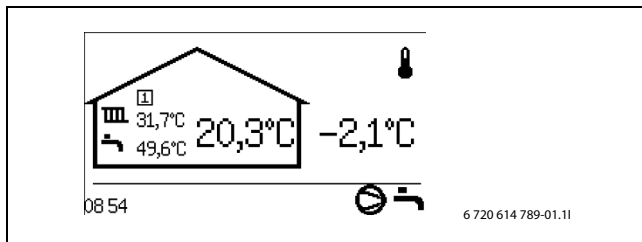

Fig. 17

11.2 INFO BUTTON

- ▶ Press **info** in the *Initial menu*.
Detailed information about temperatures, operating mode, etc., is displayed.
- ▶ Turn the dial to see all the information.
- ▶ Press **←** to return to the initial menu.
- ▶ Press **info** in a menu display.
The detailed information is displayed for as long as **info** is pressed.
- ▶ Release **info**.
The menu display is displayed.

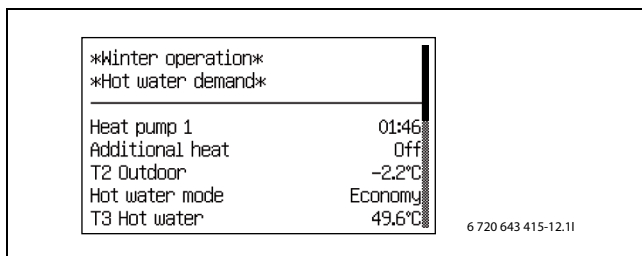

Fig. 18

11.3 OPERATING SYMBOLS

Symbols for different functions and components for which there is a demand or which are in operation are displayed in the bottom right corner of the *Initial menu*.

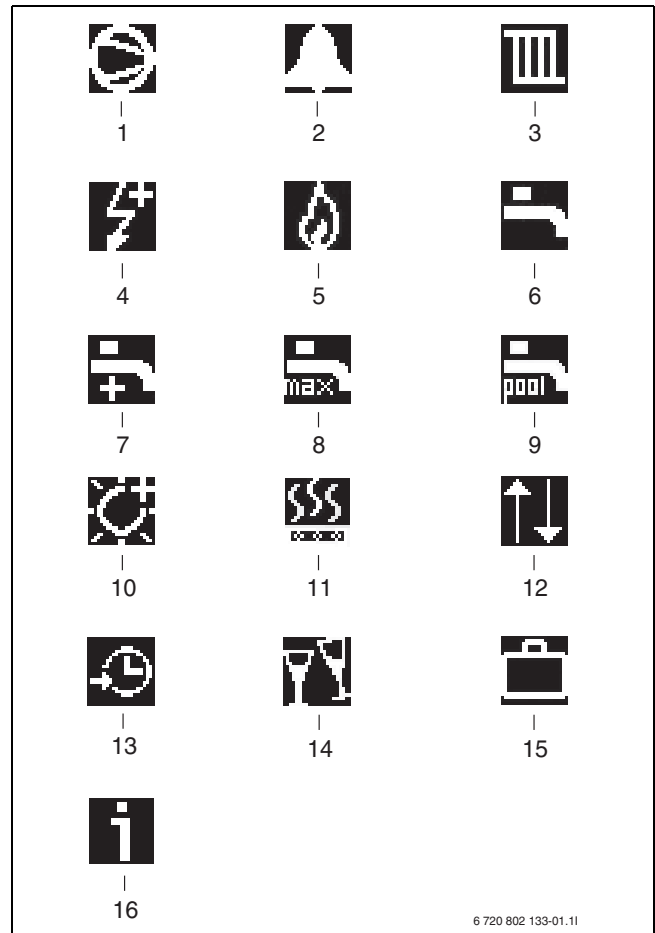

Fig. 19 Operating symbols

- [1] Compressor
- [2] Alarm (compressor, additional heat)
- [3] Heating
- [4] Electric additional heat
- [5] Mixed additional heat (option)
- [6] Hot water
- [7] Extra hot water
- [8] Hot water peak
- [9] Pool (option)
- [10] Solar (option)
- [11] Screed drying
- [12] External control
- [13] Program/time control
- [14] Party
- [15] Holiday
- [16] Information log

12 HEATING, GENERAL

12.1 CIRCUITS FOR HEATING

- **Circuit 1;** the first circuit is included by default in the control unit and is controlled by the installed flow sensor, can also be controlled with the optional room controller.
- **Circuit 2 (mixed);** control of circuit 2 is also included by default in the control unit but needs to be supplemented with an external mixing valve, circulation pump and flow sensor and also an additional room controller - these parts are all available as optional accessories.
- **Circuits 3-4 (mixed);** control of up to 2 additional circuits is optional. Each circuit is then fitted with a Multi module, mixing valve, circulation pump, flow sensor and possibly a room controller, these parts are all available as optional accessories.



Circuits 2 through 4 cannot have a higher flow temperature than circuit 1. This means that underfloor heating on circuit 1 cannot be combined with radiators on another circuit. Room temperature reduction for circuit 1 can affect other circuits in some cases.

12.2 CONTROL METHODS FOR HEATING

- **Outdoor sensor;** a sensor is fitted on a north facing outside wall of the house. The sensor sends signals to the control unit in the heat pump. Control with an outdoor sensor means that the heat pump automatically regulates the heating in the house depending on the outdoor temperature. The customer determines the temperature of the heating system in relation to the outdoor temperature by setting the heat curve on the control unit.
- **Outdoor sensor and room controllers** (one room controller per circuit is possible); Control with outdoor sensor supplemented with room controller(s) means that one (or several) controllers are mounted in specified areas of the property. They are connected to the heat pump and provide the control unit with information about the current room temperature. The signal will affect the flow temperature.



It is only the room where the room controller is located that can influence regulation of the temperature for the relevant heating circuit.

12.2.1 LCD ROOM CONTROLLER (ACCESSORY)

The control unit supports up to four room controllers.

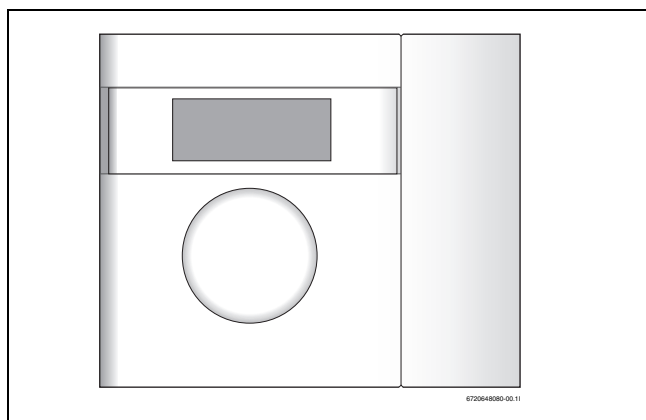

Fig. 20 CAN-BUS LCD room controller

THE DISPLAY FUNCTIONS

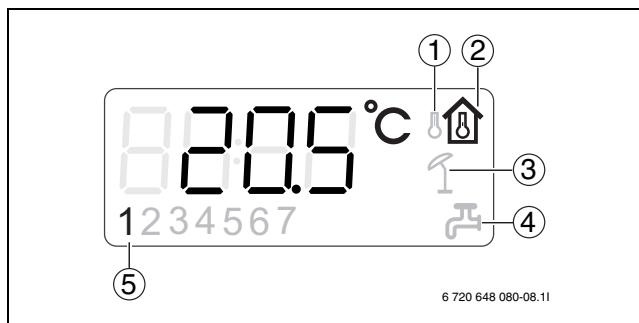

Fig. 21

- [1] Outdoor temperature
- [2] Room temperature
- [3] Holiday
- [4] Extra hot water
- [5] Current circuit

The display window shows the current room temperature. When **Show outdoor temperature in room sensor** (room controller) is set to **Yes** the outdoor temperature is also shown, alternating with the room temperature. This is valid for all installed room controllers.

In the display window, operating symbols can appear at the bottom right hand side. The symbol for **Extra hot water** or **Holiday** is displayed when the function has been set in the heat pump.

The room controller display is used to indicate alarms for some alarm categories (→ Table 46). The display window slowly flashes red until the alarm has been acknowledged in the heat pump control unit, or been automatically reset.

SETTING THE ROOM TEMPERATURE WHEN A ROOM CONTROLLER HAS BEEN INSTALLED

The room temperature can easily be set using the room controller.

- ▶ Turn the room controller knob to set the desired room temperature for the circuit. The previous set value is shown with blinking digits. The display blinks during the setting and stops blinking shortly after turning of the knob has stopped. The value in the control unit menu **Room temperature normal** for the circuit is automatically set to the same value.

Alternatively the desired room temperature is set via the control unit.

- ▶ Go to the menu **Room temperature normal** for the circuit and set the desired room temperature. The room temperature value in the room controller for the circuit is automatically set to the same value.

For **Circuit 1** there is one more way to set the room temperature.

- ▶ Use **mode** to set the room temperature in **Room temperature normal** (→ Chapter 13.1).

12.3 TIME CONTROL FOR HEATING

- **Program control;** The control unit offers a possibility to define two individual programs for time control of the heating.
- **Holiday;** the control unit has a program for holiday mode, which means that during the selected period the room temperature changes to a lower or higher level. The program also allows switching off hot water production.
- **External control;** the control unit can make settings for external control, which means that the preselected function is performed when the control unit senses an input signal.

12.4 OPERATING MODES

- **With electric additional heat;** the electric additional heat is permitted to work at the same time as the heat pump to meet the demand, when the heat pump cannot meet it by itself. Alarm mode, Extra hot water and Hot water peak also activate the additional heat.
- **With mixed additional heat (option);** mixed additional heat which is permitted to work at the same time as heat pump. The additional heat is also used during alarm operation.
A hot water electric heater is required for production of extra hot water and hot water peak. In this case, the electric additional heat in the heat pump is disabled.



The Multi module accessory is required for mixed additional heat and hot water electric heater.

13 SETTINGS

13.1 MODE BUTTON FUNCTIONS

By pressing , the following functions can be used directly:

- **Room temperature normal / Temperature increase/decrease**
- **Party**
- **Holiday**
- **Extra hot water duration**



The  button can be used to change the language of the control unit.

- ▶ Hold down the  button for at least five seconds in the initial menu and then select language.

> Room temperature normal / Temperature increase/decrease

Here, temperature changes for **Circuit 1** can be made. If this circuit is equipped with a room temperature sensor, the display shows **Room temperature normal**, otherwise **Temperature increase/decrease** is shown.

Factory setting	20.0°C
Lowest value	10.0°C
Highest value	35.0°C

Table 4 Room temperature, normal

Factory setting	=
Alternative	--, -, =, +, ++

Table 5 Room temperature increase/decrease

- ▶ Use this function to simply increase or decrease the heat when there are no room controllers.
 - gives approx. 1 °C lower room temperature.
 - gives approx. 0.5 °C lower room temperature.
 - + gives approx. 0.5 °C higher room temperature.
 - ++ gives approx. 1 °C higher room temperature.



It always takes some time for a change of a heating setting, e.g. an increase or decrease in room temperature, to apply. The same applies in the event of a quick change of the outdoor temperature. This is why you should always wait for at least 24 hours before making a new change.

> Party

Party mode means that a running room program is stopped during the set time in order to avoid a temperature drop.

>> Number of hours

Factory setting	0h
Lowest value	0h
Highest value	99h

Table 6 Party duration

- ▶ Select the number of hours that party mode should be active for. The function starts immediately on all activated circuits.

>> Circuit 1

>> Circuit x

Factory setting	No
Alternative	No/Yes

Table 7 Enable party mode

- ▶ Select **Yes** to enable party mode.
Party mode can be enabled for each installed circuit. The menu is displayed only if more than one circuit is installed.

>> Deactivate party mode

Factory setting	No
Alternative	No/Yes

Table 8 Deactivate party mode

- ▶ Select **Yes** to disable party mode on all activated circuits. The heat pump returns to program mode. The menu is displayed only if party mode is active.

> Holiday

The same functions are included here as in the **Holiday** menu (→ Chapter 13.4).

> Extra hot water duration

- ▶ For a description of setting **Extra hot water** (→ Chapter 13.3).

Factory setting	0h
Lowest value	0h
Highest value	48h

Table 9 Extra hot water duration



After a period with blocked hot water production, e.g., holiday, it is recommended to enable the extra hot water function so as to eliminate bacteria and quickly reach the correct hot water temperature.

13.2 ROOM TEMPERATURE

Press the  button in the standard display to open the main menu. Select **Room temperature** to adjust the heating.

The following options are available under **Room temperature**:

- **Circuit 1 Heating**
- **Circuit 2, 3...**
- **General**

> Circuit 1 Heating

>> Heat curve

The heat curve constitutes the basis for the control unit's control of the temperature on the heating water to the circuit and indicates how high it needs to be in relation to the outdoor temperature. The control unit increases the temperature of the heating water when the outdoor temperature drops. The temperature of the heating water out to the circuit, i.e. the flow temperature is measured by sensor T1 for circuit 1 (full name E11.T1) and sensor T1 for circuit 2 (full name E12.T1).

SETTINGS

Each circuit is controlled by its own heat curve. The installer sets the type of heating for each circuit, that is **Radiator** or **Underfloor**. The heat curve for **Underfloor** has lower values because the floors do not tolerate such high temperatures.

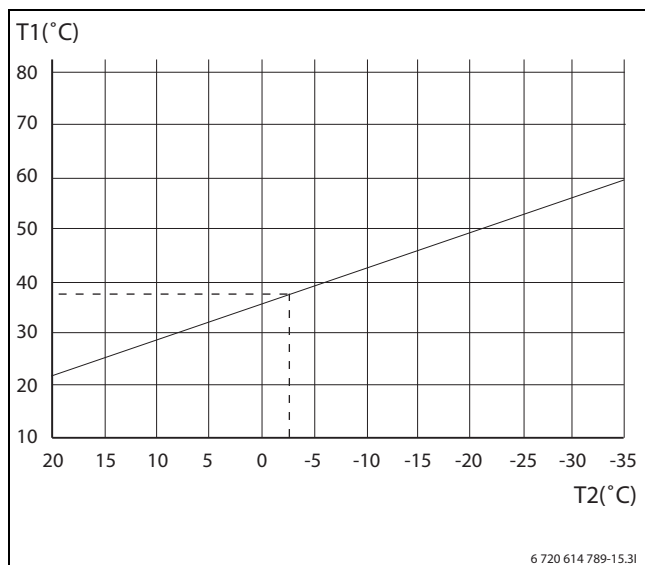

Fig. 22 Radiator

The figure indicates the factory setting curve for a radiator circuit. At -2.5 °C the flow set point is 37.4 °C.

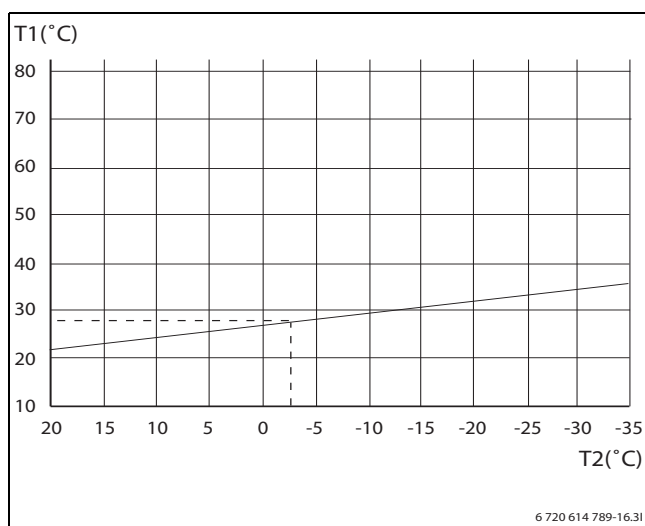

Fig. 23 Floor

The figure indicates the factory setting curve for an underfloor circuit. At -2.5 °C the flow set point is 27.2 °C.

Setting of heat curve



If the heat curve has been set too high, the display will show the message **Too high heat curve setting**.

► Change the heat curve setting.

A heat curve is set for each circuit. If the room temperature is perceived to be too high or too low in the circuit, it is preferable to adjust the curve.

The curve can be changed in different ways. The slope of the curve can be changed by offsetting the flow temperature upwards or downwards on the left-hand side (the value at outdoor temperature 20 °C, factory value 22.0 °C) as well as the right-hand side (the value at outdoor temperature -35 °C, factory setting 60.0 °C). In addition, the curve can be affected by every 5th outdoor temperature degree.

The value at 0 °C is displayed above the curve's left-hand point, factory value 35.7 °C.

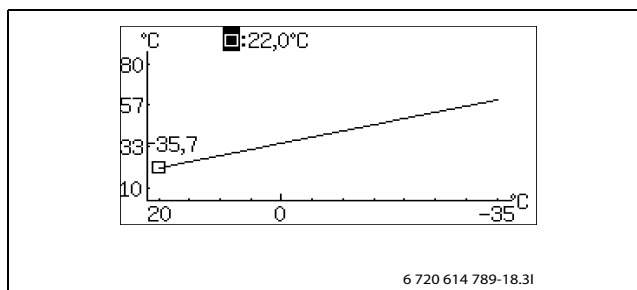

Fig. 24 Settings window Heat curve (radiator)

Change the left point:

- Press the menu dial when the square is highlighted. The value is then highlighted.

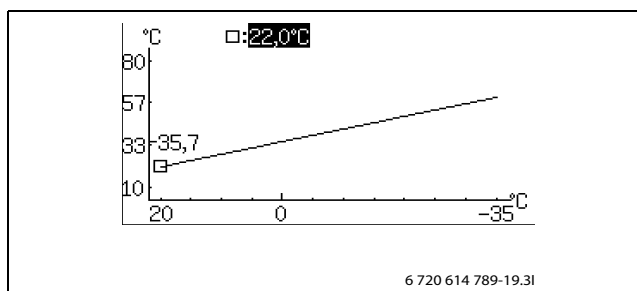

Fig. 25

- Turn the menu dial to change the value. Press the dial to save or use to return without saving. In the window, the square is highlighted again and any changed values are displayed after the square. In addition, the curve is updated according to the new value.

Change the right point:

- Turn the menu dial when the square is highlighted. The upper square is changed to outdoor temperature with the corresponding curve value after the colon. The circle marks the relevant curve position.
- Continue to turn the dial until it shows a square before the colon.
- Press the dial to highlight the value.

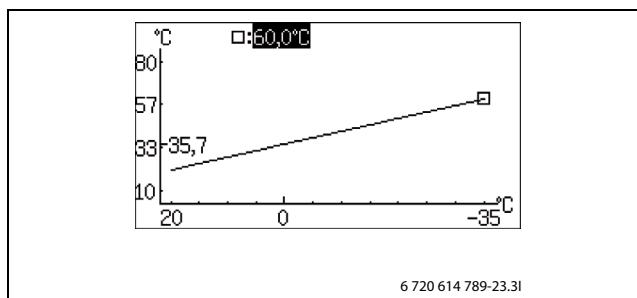

Fig. 26

- Turn the menu dial to change the value. Press the dial to save or use to return without saving. In the window, the square is highlighted again and any changed values are displayed after the square. In addition, the curve is updated according to the new value.

Change a specific value, for example the value at an outdoor temperature of 0 °C:

- Turn the menu dial when the square is highlighted until 0 °C is marked (→ Fig. 27).
- Press the dial to highlight the value.

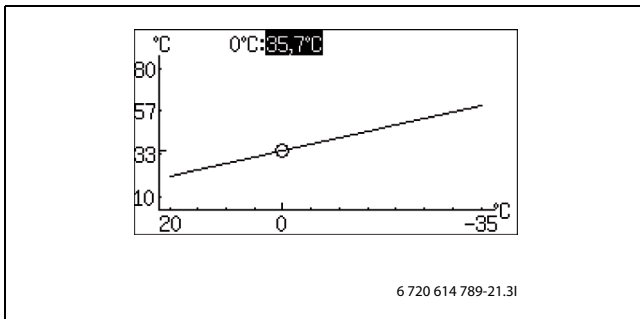

Fig. 27

- ▶ Turn the menu dial to change the value.

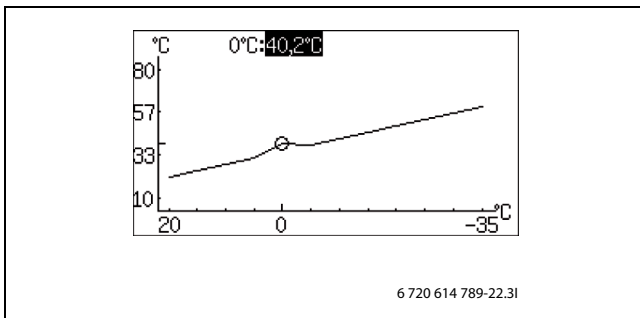

Fig. 28

- ▶ Press the dial to save or use to return without saving.
- ▶ Use to leave the curve setting window and return to the menu.



Recommendations:

- ▶ Increase the value of the right point if it feels too cold at low outdoor temperatures.
- ▶ Increase the value of curve at 0 °C if it feels a little cold at outdoor temperatures around 0.
- ▶ Increase or decrease the value of the curve equally at the right and left points to fine adjust the heat (the curve is offset parallel).

>> Compressor x operating time on/off

Factory setting	20.0
Lowest value	10.0 (Comfort)
Highest value	30.0 (Economy)

Table 10 Compressor operating time on/off

- ▶ Select how long the compressor should be on or off in heating mode. Higher set values result in fewer compressor starts and stops, which achieves higher economy. However, more pronounced temperature fluctuations in the heating system may result than with lower values.

>> Room temperature program

Factory setting	HP optimized
Alternative	<ul style="list-style-type: none"> • HP optimized • Program 1 • Program 2

Table 11 Program selection, circuit 1

- ▶ Choose if the circuit should be controlled with a program or not.

HP optimized

This means that the control unit is only controlled by the flow set point value (→ Chapter 13.2.1), without programmed changes during the day. Optimised operation provides the best comfort and energy savings in the vast majority of cases.

Program 1 and 2

These selections provide an opportunity to define user programs for time control by adjusting the start and stop times, as well as a normal and an programmed temperature.

Program	Day	Start	Stop
Program 1, 2	Mon - Sun	5:30	22:00

Table 12 Program 1 and 2

To set the desired time of day:

- ▶ Select **Program 1** or **Program 2**.
- ▶ Go to menu **View/edit active program**.
- ▶ Select day by turning the menu dial.

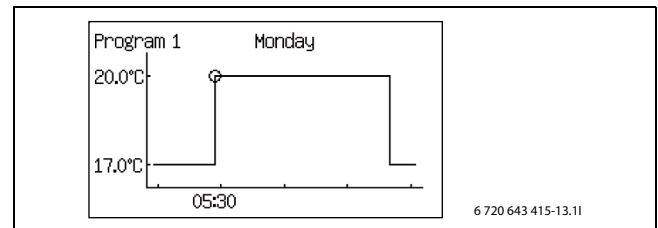

Fig. 29

- ▶ Press the menu dial to mark the value to be changed.

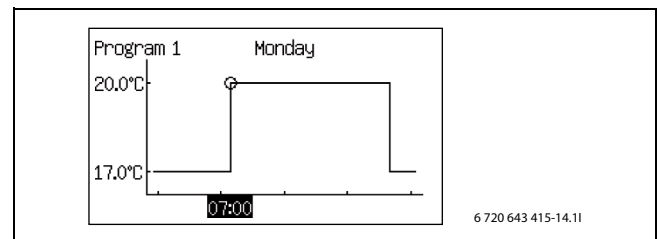

Fig. 30

- ▶ Turn the menu dial until the desired setting has been selected.
- ▶ Then press the menu dial.
- ▶ Turn the menu dial to be able to set additional values in the same way as above.
- ▶ Go back one step with .

▶ Select **Saving alternative:**

- **Return without saving**
- **Program 1**
- **Program 2**

The set changes are saved as a selected program or not at all.

- ▶ To adjust the normal temperature, proceed to menu **Room temperature normal**.
- ▶ To adjust the exceptional temperature, proceed to menu **Room temperature exception**.

Room temperature program when there is a room controller:

>> Room temperature program

>>> Active program

If a program is selected, the following (if the menu button is turned) is displayed:

>>> View/edit active program

>>> Room temperature normal

Factory setting	20.0 °C
Lowest value	10.0 °C
Highest value	35.0 °C

Table 13 Room temperature, normal

- ▶ Set the desired set point for the room temperature.

>>> Room temperature exception

Factory setting	17.0 °C
Lowest value	10.0 °C
Highest value	30.0 °C

Table 14 Room temperature, exception

- ▶ Set the temperature that should apply as programmed temperature in the program.
The menu is displayed only if **Program 1** or **Program 2** has been selected.

>>> Copy to all heating circuits

Factory setting	No
Alternative	No/Yes

Table 15 All circuits

- ▶ Select **Yes** to have the same control for all installed circuits.
The menu is displayed only under **Circuit 1**.

Room temperature program when there is no room controller:
>> Room temperature program
>>> Active program
>>> View/edit active program

The same as when there is a room controller, see above.

>>> Room temperature normal

Factory setting	20.0 °C
Lowest value	10.0 °C
Highest value	35.0 °C

Table 16 Room temperature, normal

- ▶ Set the measured value in the room.
The indicated value is used by temperature programs to calculate the difference between normal and exceptional temperature.

>>> Temperature increase/decrease

Factory setting	=
Alternative	- -, -, =, +, ++

Table 17 Room temperature increase/decrease

- ▶ Use this function to adjust the room temperature so that the normal room temperature (see the previous menu) becomes the desired temperature.
- ▶ Use this function to simply increase or decrease the heat when there are no room controllers.
 - - gives approx. 1 °C lower room temperature.
 - gives approx. 0.5 °C lower room temperature.
 - + gives approx. 0.5 °C higher room temperature.
 - ++ gives approx. 1 °C higher room temperature.

> Room temperature influence

Factory setting	3.0
Lowest value	0.0
Highest value	10.0

Table 18 Room temperature influence

- ▶ Set how much a 1 K (°C) difference in room temperature should influence the set point value for the flow temperature.
Example: at a 2 K (°C) deviation from the set room temperature, the set point value for the flow temperature is changed by 6 K (°C) (2 K deviation * factor 3 = 6 K).

>>> Room temperature exception

The same as when there is a room controller, see above.

>>> Copy to all heating circuits

The same as when there is a room controller, see above.



It always takes some time for a change of a heating setting, e.g. an increase or decrease in room temperature, to apply. The same applies in the event of a quick change of the outdoor temperature. This is why you should always wait for at least 24 hours before making a new change.

> Circuit 2, 3... (Circuit 3 option)

Circuit 2, 3... has the same settings options as Circuit 1, (→ Chapter 13.2).

13.2.1 SET POINT

The heating circuit's set point value is the temperature of the flow that the heat pump attempts to maintain. Sometimes, the measured actual value fluctuates a bit upward and downward depending on changes in the outdoor temperature or a large hot water demand.



The set point value specified by the customer/installer is most often the room temperature, which is recalculated by the control unit into a corresponding flow temperature set point value. Under normal conditions, 1 K (°C) in room temperature corresponds to approx. 3 K (°C) in flow temperature.

The set point value is normally based on:

- Current curve value (the flow temperature at the current outdoor temperature according to the applicable heat curve).
- Current curve influence through:
 - **Room sensor** (room controller)
 - **Holiday**
 - **Active program**
 - **External control**

SET POINT VALUE CALCULATION

The set point value for the heating circuit is the current curve value adjusted with active curve influence, if any such exists.

Priority order for curve influence is:

- **External control**
- **Active program**
- **Holiday**

Only one of these can be active. How big the influence should be and when to exercise it is set in the respective function.

FIXED SET POINT VALUE

A fixed set point value (not curve-based) applies in the event of:

- External set point value. The set point value is determined according to input signal 0-10V where 1V is 10 °C and 10V is 80 °C (0V triggers an alarm).

SET POINT VALUE LIMITATION

The calculated set point value is always checked against the permitted temperature limits.

The applicable set point value T1 for **Circuit 1** and the measured actual value for T1 are used to activate and deactivate the heat demand.

The following applies to **Circuit 2, 3...:** When the actual value for the mixed circuit's T1 is low in relation to the set point value, more heating water is shunted into the circuit so as to maintain the set point value.

If the flow temperature has been below the set point value for a certain period of time, there is heat demand and the compressor produces heat before there is a too significant temperature reduction indoors. This happens until the flow temperature is a couple of degrees higher than

the set point value. (Or because **Maximum operating time for heating at hot water demand** has passed.)

Heating demand is not active during summer operation.

> **General**

>> **Summer/winter operation**

>>> **Winter operation**

Factory setting	Automatic
Alternative	On/Automatic/Off

Table 19 Summer/winter operation

If **On** is selected, the heat pump is constantly in winter operation and heat and hot water are always produced. **Off** signifies constant summer operation; only hot water is produced. **Automatic** signifies change-over at the set outdoor temperature.

>>> **Outdoor temperature limit for change over**

Factory setting	18 °C
Lowest value	5 °C
Highest value	35 °C

Table 20 Change over temperature

The menu is displayed only if **Automatic** has been selected in **Winter operation**.



In the event of alternation between winter and summer operation and vice versa, there is a certain delay aimed at preventing constant starting and stopping of the compressor when the outdoor temperature oscillates around the temperature limit.

13.3 HOT WATER

Under **Hot water**, there are functions to:

- Request **Extra hot water**
- Specify when **Hot water peak** should be performed to eliminate bacteria
- Set any **Hot water program**
- Select operating mode

> **Extra hot water**

Additional amount of hot water is produced by temporarily increasing the temperature of the hot water during the set number of hours to the indicated stop temperature.

>> **Extra hot water duration**

Factory setting	0h
Lowest value	0h
Highest value	48h

Table 21 Extra hot water duration

► Set the duration of extra hot water production.

>> **Extra hot water stop temperature**

Factory setting	65 °C
Lowest value	50 °C
Highest value	65 °C

Table 22 Extra hot water stop temperature

► Set the stop temperature for extra hot water.

The heat pump starts the function directly and uses the compressor first and then the additional heat source to increase the temperature. When the desired number of hours have passed, the heat pump returns to normal hot water mode.

DANGER: Risk of burn injuries.
► Use a mixing valve when the hot water temperature exceeds 60 °C.

> **Hot water peak**

Hot water peak means a temporary increase in the hot water temperature to approx. 65 °C for thermal elimination of bacteria (pasteurisation).

For the hot water temperature increase, the compressor is used first; the additional heat source then continues alone.

>> **Day of the week**

Factory setting	Wednesday
Area	None, Day, All

Table 23 Weekday

► Set the day on which the hot water peak should take place. **None** means that the function is disabled. **All** means that a hot water peak takes place every day.

If hot water peak is deactivated comfort mode must be selected in the menu **Hot water mode**.

>> **Interval in weeks**

Factory setting	1
Lowest value	1
Highest value	4

Table 24 Week interval

► Set how often a hot water peak should take place.

- 1 means a hot water peak every week.
- 2 means that a hot water peak takes place in all even weeks of the year, i.e. in week 2, 4, 6, etc.
- 3 means week 3, 6, 9, etc.
- 4 means week 4, 8, 12, etc.

>> **Start time**

Factory setting	3:00
Lowest value	0:00
Highest value	23:00

Table 25 Start time

► Set the time of the hot water peak.

WARNING: Risk of scalding.
At hot water temperatures greater than 60 °C, there is a risk of scalding.
► Exercise caution when using hot water immediately after a hot water peak.

> **Hot water program**

Program 1 and **Program 2** enables you to block hot water production during the set time.

>> **Active program**

Factory setting	Always hot water
Alternative	<ul style="list-style-type: none"> • Always hot water • Program 1 • Program 2

Table 26 Hot water program

>> View/edit active program

The menu is displayed only if **Program 1** or **Program 2** has been selected. Programs are changed in the same way as for **Room temperature program** (→ Chapter 13.2).

> Hot water mode

Factory setting	Economy
Alternative	Economy/Comfort

Table 27 Hot water mode
▶ Select hot water mode.

Economy means that the hot water is permitted to cool slightly before hot water production starts compared to **Comfort**. Heating stops at a slightly lower temperature.

▶ Change to Comfort if more or hotter hot water is desired.

This setting must be used if electric additional heat is missing or if the hot water circulation is used, when the temperature in the hot water circulation is otherwise too low.

The factory settings for on and off temperature are approx. 8 K (°C) lower in Economy mode compared to Comfort mode.

13.4 HOLIDAY

During holidays (absence), the heating can, for example, be kept at a lower or higher level and hot water production can be switched off. *Start* and *Stop date*, *Room temperature* and *Block hot water production* are only displayed if the holiday function is activated.

> Circuit 1 and hot water
>> Activate holiday function

Factory setting	No
Alternative	No/Yes

Table 28 Holiday function
>> Start date
>> Stop date
▶ Set start and stop date for the desired period. Format yyyy-mm-dd.

The period starts and ends at 00:00. Both the start and end date are included in the period.

▶ Terminate the period prematurely by indicating **No in the menu**

Activate holiday function.

>> Room temperature
▶ Set the room temperature that should apply to the circuit during the period.

Factory setting	17 °C
Lowest value	10 °C
Highest value	35 °C

Table 29 Room temperature, holiday
>> Copy to all heating circuits

Factory setting	No
Alternative	Yes/No

Table 30 Copy circuits
>> Block hot water production

Factory setting	No
Alternative	Yes/No

Table 31 Block hot water
> Circuit 2, 3...
>> Activate holiday function
>> Start date
>> Stop date
>> Room temperature
▶ Set the values in the same way as for **Circuit 1 and hot water.**
13.5 ENERGY MEASUREMENTS

Energy is measured per compressor; the calculated results are added prior to being displayed.

> Generated energy

This displays **Generated energy** in kWh divided into **Heating** and **Hot water**.

> Consumption electric additional heat

This displays **Consumption electric additional heat** in kWh divided into **Heating** and **Hot water**.

13.6 TIMERS

Timers are used by the control unit to count down the different time dependent functions such as **Extra hot water duration**. At customer level the following timers can be observed (only timers that are counting are displayed):

Timer	F value
Extra hot water	0h
Alarm mode delay	1h
Party	0h
Operating time for heating at hot water demand	20min
Hot water, operating time at heating demand	30min
Heat pump x timers	
> Compressor start delay	10min
Additional heat timers	
> Additional heat start delay	120min
> Delay mixing valve control after additional heat start	20min

Table 32 Timers
13.7 EXTERNAL CONTROL

When an external input is connected, the control unit performs functions which are set to **Yes** or is separated from 0 (**Room temperature**). When the external input is no longer connected, the control unit returns to normal mode. Only installed functions are displayed.

> Heat pump x
>> External input 1, 2
>>> Block compressor
>>> Block additional heat
>>> Block heating at tripped underfloor temperature limiter
>>> Block heating
>>> Room temperature
>>> Block hot water production
>> External input circuit 2, 3...
>>> Block compressor
>>> Block additional heat
>>> Block heating at tripped underfloor temperature limiter
>>> Block heating
>>> Room temperature
>>> Block hot water production

Room temperature:

Factory setting	No (0.0 °C)
Lowest value	10.0 °C
Highest value	35.0 °C

Table 33 Room temperature

- ▶ Set the room temperature that should apply in the event of enabled external control.
- ▶ Value > 0 °C enables the function.

The highest temperature is used if temperature changes have been set for a certain circuit at several external inputs.

Other functions:

Factory setting	No
Alternative	Yes/No

Table 34 Functions

13.8 GENERAL

Among other things, settings for date and time are available here.

> **Room sensor settings** (room controller)

>> **Show outdoor temperature in room sensor** (room controller)

Factory setting	No
Alternative	Yes/No

Table 35 Show outdoor temperature in room controller

> **Set date**

Factory setting	
Format	yyyy-mm-dd

Table 36 Date

> **Set time**

Factory setting	
Format	hh:mm:ss

Table 37 Time

- ▶ Check and change, if necessary, date and time. These are used by the control unit to manage the different clock settings, e.g., holiday and room temperature program.

> **Summer/winter time**

Factory setting	Automatic
Alternative	Manual/Automatic

Table 38 Summer/winter time.

- ▶ Select if there should be automatic change over between summer and winter time or not (dates according to EU standard).

> **Display contrast**

Factory setting	70%
Lowest value	0%
Highest value	100%

Table 39 Display contrast

- ▶ If necessary, change the background light of the control panel.

> **Language**

- ▶ Change language, if desired.

13.9 ALARMS

The different alarms that can occur are described in (→Chapter 14).

Under **Alarms** there is:

- **Information log**
- **Delete information log**
- **Alarm log**
- **Delete alarm log**
- **Alarm indication**

> **Information log**

The information log shows information from the heat pump. The information log symbol is displayed in the control panel initial menu when there is active information.

> **Delete information log**

The information log is deleted here.

> **Alarm log**

The alarm log shows the alarms and warnings that have occurred. Alarm category (→ Chapter 14.5) is displayed in the top left corner of the display. If the alarm is active, the alarm symbol (→Chapter 11.3) is displayed both in the alarm log and the initial menu of the control panel.

> **Delete alarm log**

The alarm log is deleted here.

> **Alarm indication**

Settings for alarm buzzer and status lamp are made here.

>> **Alarm buzzer signal**

>>> **Interval**

Factory setting	2s
Lowest value	2s
Highest value	3600s (60min)

Table 40 Interval

- ▶ Set the length of the alarm interval.

The alarm buzzer sounds for one second and is silent during the rest of the interval. The setting applies to all alarm buzzers.

>>> **Blocking time**

Factory setting	Off
Start time	0:00 - 23:45
Stop time	0:00 - 23:45

Table 41 Blocking time

- ▶ Set the times between which alarms buzzers should not be allowed to produce an acoustic signal.

>> **Alarm indication control unit**

>>> **Block alarm buzzer**

Factory setting	No
Alternative	No/Yes

Table 42 Block alarm buzzer

The setting applies only to the control unit's alarm buzzer.

>> **Alarm indication room sensor** (room controller)

>>> **Block alarm indicator lamp**

Factory setting	Yes
Alternative	No/Yes

Table 43 Block indicator lamp

The setting applies to all room controllers.

13.10 ACCESS LEVEL

Access level is **Customer** as standard: This level gives you access to all functions that the user requires. The installer also has access to the additional functions required at installation.

13.11 RETURN TO FACTORY SETTINGS

- ▶ Select **Return to factory settings** and **Yes** to reset all customer settings to the factory settings. Settings made by the installer are not affected.

Factory setting	No
Alternative	Yes/No

Table 44 Return to factory settings

14 ALARMS

14.1 CONTROL UNIT AND ROOM CONTROLLER ALARM LAMP

The status lamp on the control unit is used to show ON/OFF status for the heat pump but also to show possible alarms. The status lamp is therefore also called alarm lamp.

Behaviour	Function
Blue, continuously lit.	The heat pump is running.
Blue, flashing rapidly.	There is an alarm which must be acknowledged. The alarm has been acknowledged but the alarm cause remains.
Blue, flashing.	The heat pump is in standby mode ¹⁾ .

Table 45 Alarm lamp control unit

1) Stand-by means that the heat pump is running but no heating or hot water demand exists.

The room controller display is used to indicate alarms for some alarm categories (→ Table 46). The display window slowly flashes red until the alarm has been acknowledged in the heat pump control unit, or been automatically reset.

The room controller alarm display function is referred to as alarm lamp in this chapter.

The room controller alarm lamp can be blocked.

14.2 ALARM BUZZER AT ALARM

At an alarm the alarm buzzer on the heat pump sounds for one second per alarm buzzer interval set. At certain times of the day the alarm buzzer can be blocked or blocked altogether.

In the event of a warning, the alarm buzzer does not sound.

14.3 ACKNOWLEDGEMENT OF ALARMS

Acknowledgement means that you have to press  to make the alarm window disappear. What happens after acknowledgement is described in the respective alarm description.

In most cases, warnings do not have to be acknowledged. The alarm window disappears by itself once the warning cause has disappeared. It is, however, possible to acknowledge the warning.

14.4 ALARM TIMER, ALARM MODE

In the event of an alarm that stops the compressor the control unit starts a timer at 1h. If the fault does not recur additional heat may start when the timer has counted down.

14.5 ALARM CATEGORIES

The alarms are divided into different categories depending on the type and seriousness of the fault. Alarm category is displayed in the alarm window and alarm log.

CATEGORIES A-H ARE ALARMS, CATEGORIES I-J ARE WARNINGS/INFORMATION, CATEGORIES K-M ARE WARNINGS, CATEGORY Z IS INFORMATION.

Meaning	A	B	C	D	E	F	G	h	In	J	K	L	M	Z
Stops the compressor	X	X	X	X	X				X	X				
Stops additional heat						X	X				X			
Alarm lamp, alarm buzzer is activated	X	X	X	X	X	X	X	X						
Alarm delay	5s	3s	15 min	1 min	5s	1s	1s	1s	5s	5s	2s	5s	0s	0s
Requires acknowledgement to restart	X	X	X	X		X								
Can be restarted before acknowledgement					X		X	X	X	X	X		X	
Menu display must be acknowledged	X	X	X	X	X	X	X	X				X	X	
Placed in the information log									X	X				X

Table 46 Alarm categories

- [In] Temporary stop of compressor. The information may recur a number of times during a certain time period; if there are more during the period, a category A alarm is sounded.
- [J] Temporary stop of compressor. The information may recur a number of times during a certain time period; if there are more during the period, a category A alarm is sounded.
- [M] Used for board connection problems.

14.6 ALARM WINDOW

When an alarm/warning occurs, the display shows information about what has happened. At the same time, information is saved in the alarm log. The alarm symbol is displayed in the initial menu of the control panel (→ Chapter 11.3).

Example of an alarm:

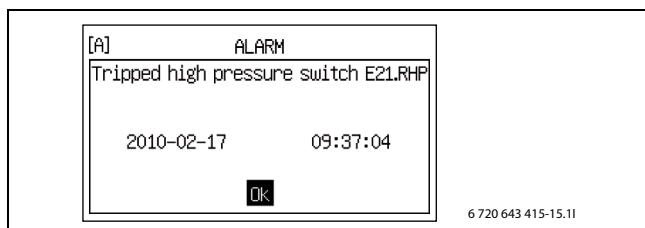

Fig. 31

14.7 ALARM FUNCTIONS

The different alarms that can occur are presented here, the alarm text is indicated in the heading.

Most alarm texts contain a designation of the part of the heat pump that has caused the alarm. Always indicate the whole alarm information when you are in contact with the installer.

E21 refers to heat pump 1, E22 refers to heat pump 2.

E11 refers to circuit 1, E12 circuit 2, E13 circuit, 3, etc.

Txx refers to different temperature sensors.

14.7.1 HIGH HOT GAS TEMPERATURE E2X.T6

Function: Compressor stops. Activated when the temperature from the compressor becomes too high. The alarm can occur in individual cases under extreme service conditions.

Alarm timer starts: Yes.

Reset condition: The hot gas temperature drops to the permitted temperature.

Category: A.

Alarm lamp/buzzer: Yes.

Restart: Acknowledgement is required.

- ▶ Contact your installer if the alarm remains active for more than three hours or recurs often.

14.7.2 TRIPPED LOW PRESSURE SWITCH E2X.RLP

Function: Compressor stops. Activated when the pressure in the refrigerant circuit of the heat pump becomes too low.

Alarm timer starts: Yes.

Reset condition: The pressure goes back to the permitted level.

Category: A.

Alarm lamp/buzzer: Yes.

Restart: Acknowledgement is required.

- ▶ Check the filter and clean if required (→Chapter 16.3).

- ▶ Contact your installer if the alarm remains after acknowledgement.

14.7.3 TRIPPED HIGH PRESSURE SWITCH E2X.RHP

Function: Compressor stops. Activated when the pressure in the refrigerant circuit becomes too high.

Alarm timer starts: Yes.

Reset condition: The pressure goes back to the permitted level.

Category: A.

Alarm lamp/buzzer: Yes.

Restart: Acknowledgement is required.

- ▶ Contact your installer if the alarm remains after acknowledgement.

14.7.4 LOW PRESSURE COLLECTOR CIRCUIT

Function: Compressor stops. Activated when the pressure in the collector circuit becomes too low.

Alarm timer starts: Yes.

Reset condition: The pressure goes back to the permitted level.

Category: A.

Alarm lamp/buzzer: Yes.

Restart: Acknowledgement is required.

- ▶ Contact your installer if the alarm remains after acknowledgement.

14.7.5 LOW TEMPERATURE COLLECTOR CIRCUIT IN E2X.T10

Function: Alarm is given if the collector circuit temperature is too low and if warning of this has been given several times.

Alarm timer starts: Yes.

Reset condition: The collector circuit temperature exceeds the lowest permitted temperature.

Category: A.

Alarm lamp/buzzer: Yes.

Restart: Acknowledgement is required.

- ▶ Contact your installer if the alarm remains after acknowledgement.

14.7.6 LOW TEMPERATURE COLLECTOR CIRCUIT OUT E2X.T11

Function: Alarm is given if the collector circuit temperature is too low and if warning of this has been given several times.

Alarm timer starts: Yes.

Reset condition: The temperature of the refrigerant exceeds the lowest permitted temperature.

Category: A.

Alarm lamp/buzzer: Yes.

Restart: Acknowledgement is required.

- ▶ Contact your installer if the alarm remains after acknowledgement.

14.7.7 TOO HIGH BOOT COUNT I/O BOARD BAS X

Function: Compressor stops. Is activated if the controller has executed more than three new starts after the alarm **Check CANbus cable connection**, (→ Chapter 14.8.6).

Alarm timer starts: Yes.

Reset condition: The CAN-BUS communication with the controller has been restored.

Category: A.

Alarm lamp/buzzer: Yes.

Restart: Acknowledgement is required.

- ▶ Contact your installer if the alarm remains after acknowledgement.

14.7.8 MOTOR CUT-OUT 1 E2X.F11, COMPRESSOR

Function: Activated when the compressor's motor cut-out has tripped because of high current or lost current phase resulting in undue strain on the compressor.

Alarms may also be due to faults in the soft start.

Alarm timer starts: Yes.

Reset condition: Motor cut-out reset.

Category: B.

Alarm lamp/buzzer: Yes.

Restart: Acknowledgement is required.

- ▶ Check the heating system fuses, and main fuses.
- ▶ Contact your installer if the alarm remains after acknowledgement.

14.7.9 FAILURE ON SENSOR E2X.T6 HOT GAS

Function: The compressor stops because the hot gas cut-out cannot be guaranteed. Activated when the sensor's value indicates a temperature lower than -50 °C.

Alarm timer starts: Yes.

Reset condition: The value of the sensor indicates > -50 °C.

Category: E.

Alarm lamp/buzzer: Yes.

Restart: Automatic once the alarm cause has disappeared.

- ▶ Contact your installer if the alarm remains active for more than three hours or recurs often.

14.7.10 SHORT CIRCUIT ON SENSOR E2X.T6 HOT GAS

Function: The compressor stops because the hot gas cut-out cannot be guaranteed. Activated when the sensor's resistance value indicates a temperature higher than 150 °C.

Alarm timer starts: Yes.

Reset condition: The value of the sensor indicates < 150 °C.

Category: E.

Alarm lamp/buzzer: Yes.

Restart: Automatic once the alarm cause has disappeared.

- ▶ Contact your installer if the alarm remains active for more than three hours or recurs often.

14.7.11 HIGH FLOW TEMPERATURE E1X.T1

Function: Compressor stops. Activated when the temperature in the heating circuit becomes too high in relation to the settings that are made.

Alarm timer starts: Yes.

Reset condition: The sensor's value falls below the temperature for beginning of the heating demand.

Category: E.

Alarm lamp/buzzer: Yes.

Restart: Automatic once the alarm cause has disappeared.

- ▶ Lower the heating on the circuit.
- ▶ Check that the thermostat valves are open.
- ▶ Contact your installer if the alarm recurs often.

14.7.12 FAULTY ELECTRIC HEATER E21.E2

Function: The electric heater is turned off. Activated by tripped overheat protection on the electric additional heat, high flow temperature or too high temperature in electric additional heat. The automatic trip fuse to the electric additional heat may have been tripped due to, for example, a short circuit.

Reset condition: Overheat protection reset or the temperature has fallen.

Category: F.

Alarm lamp/buzzer: Yes.

Restart: Acknowledgement is required.

- ▶ Reset the overheat protection if this has been triggered.
- ▶ Reset the automatic fuse if this has been tripped.
- ▶ Contact your installer if the alarm continues after acknowledgement.

14.7.13 OVERHEAT PROTECTION TRIPPED HOT WATER ELECTRIC HEATER

Function: The electric heater is turned off. If alarm output from the electric heater has been connected to the multi module, the alarm is given when an error occurs.

Reset condition: The error in the electric heater has been overcome and no alarm signal.

Category: F.

Alarm lamp/buzzer: Yes.

Restart: Acknowledgement is required.

- ▶ Contact your installer if the alarm remains after acknowledgement.

14.7.14 FAULTY PROTECTIVE ANODE E41.F31

Function: Does not affect the compressor or additional heat. The alarm is activated when the anode in the hot water heater is broken or does not work.

Reset condition: The anode should be taken care of so as to prevent corrosion in the hot water heater.

Category: H.

Alarm lamp/buzzer: Yes.

Restart: Acknowledgement is required.

- ▶ Contact your installer.

14.7.15 FAILURE ON SENSOR E11.T1 FLOW

Function: The system switches over to control based on sensor T8. The alarm is activated when the sensor's value indicates a temperature lower than 0 °C.

Reset condition: The value of the sensor indicates >0 °C.

Category: H.

Alarm lamp/buzzer: Yes.

Restart: Automatic once the alarm cause has disappeared.

- ▶ Contact your installer if the alarm remains active for more than three hours or recurs often.

14.7.16 SHORT CIRCUIT ON SENSOR E11.T1 FLOW

Function: The system switches over to control based on sensor T8. The alarm is activated when the sensor's value indicates a temperature higher than 110 °C.

Reset condition: The value of the sensor indicates < 110 °C.

Category: H.

Alarm lamp/buzzer: Yes.

Restart: Automatic once the alarm cause has disappeared.

- ▶ Contact your installer if the alarm remains active for more than three hours or recurs often.

14.7.17 FAILURE ON SENSOR E12.T1, E13.T1... FLOW

Function: The mixing valve for the circuit is closed completely. The alarm is activated when the sensor's value indicates a temperature lower than 0 °C.

Reset condition: The value of the sensor indicates >0 °C.

Category: H.

Alarm lamp/buzzer: Yes.

Restart: Automatic once the alarm cause has disappeared.

- ▶ Contact your installer if the alarm remains active for more than three hours or recurs often.

14.7.18 SHORT CIRCUIT ON SENSOR E12.T1, E13.T1... FLOW

Function: The mixing valve for the circuit is closed completely. The alarm is activated when the sensor's value indicates a temperature higher than 110 °C.

Reset condition: The value of the sensor indicates < 110 °C.

Category: H.

Alarm lamp/buzzer: Yes.

Restart: Automatic once the alarm cause has disappeared.

- ▶ Contact your installer if the alarm remains active for more than three hours or recurs often.

14.7.19 FAILURE ON SENSOR T2 OUTDOOR

Function: In the event of a failure on T2, the outdoor temperature is set to 0 °C so that the heat pump can continue to produce heat. The alarm is

activated when the sensor's value indicates a temperature lower than -50 °C.

Reset condition: The value of the sensor indicates > -50 °C.

Category: H.

Alarm lamp/buzzer: Yes.

Restart: Automatic once the alarm cause has disappeared.

- ▶ Contact your installer if the alarm remains active for more than three hours or recurs often.

14.7.20 SHORT CIRCUIT ON SENSOR T2 OUTDOOR

Function: In the event of a short circuit on T2, the outdoor temperature is set to 0 °C so that the heat pump can continue to produce heat. The alarm is activated when the sensor's value indicates a temperature higher than +70 °C.

Reset condition: The value of the sensor indicates < 70 °C.

Category: H.

Alarm lamp/buzzer: Yes.

Restart: Automatic once the alarm cause has disappeared.

- ▶ Contact your installer if the alarm remains active for more than three hours or recurs often.

14.7.21 FAILURE ON SENSOR T3 HOT WATER

Function: The hot water production is terminated. The alarm is activated when the sensor's value indicates a temperature lower than 0 °C.

Reset condition: The value of the sensor indicates >0 °C.

Category: H.

Alarm lamp/buzzer: Yes.

Restart: Automatic once the alarm cause has disappeared.

- ▶ Contact your installer if the alarm remains active for more than three hours or recurs often.

14.7.22 SHORT CIRCUIT ON SENSOR T3 HOT WATER

Function: The hot water production is terminated. The alarm is activated when the sensor's value indicates a temperature higher than +110 °C.

Reset condition: The value of the sensor indicates < 110 °C.

Category: H.

Alarm lamp/buzzer: Yes.

Restart: Automatic once the alarm cause has disappeared.

- ▶ Contact your installer if the alarm remains active for more than three hours or recurs often.

14.7.23 FAILURE ON SENSOR E1X.TT.T5 ROOM

Function: The room temperature influence is set to 0, which means that the room controller cannot affect the heating system any longer. The alarm is activated when the sensor's value indicates a temperature lower than -1 °C.

Reset condition: The value of the sensor indicates > -1 °C.

Category: H.

Alarm lamp/buzzer: Yes.

Restart: Automatic once the alarm cause has disappeared.

- ▶ Contact your installer if the alarm remains active for more than three hours or recurs often.

14.7.24 SHORT CIRCUIT ON SENSOR E1X.TT.T5 ROOM

Function: The room temperature influence is set to 0, which means that the room controller cannot affect the heating system any longer. The alarm is activated when the sensor's value indicates a temperature higher than +70 °C.

Reset condition: The value of the sensor indicates < 70 °C.

Category: H.

Alarm lamp/buzzer: Yes.

Restart: Automatic once the alarm cause has disappeared.

- ▶ Contact your installer if the alarm remains active for more than three hours or recurs often.

14.7.25 FAILURE ON SENSOR E2X.T8 HEAT TRANSFER FLUID OUT

Function: Activated when the sensor's value indicates a temperature lower than 0 °C.

Reset condition: The value of the sensor indicates >0 °C.

Category: H.

Alarm lamp/buzzer: Yes.

Restart: Automatic once the alarm cause has disappeared.

- ▶ Contact your installer if the alarm remains active for more than three hours or recurs often.

14.7.26 SHORT CIRCUIT ON SENSOR E2X.T8 HEAT TRANSFER FLUID OUT

Function: Activated when the sensor's value indicates a temperature higher than 110 °C.

Reset condition: The value of the sensor indicates < 110 °C.

Category: H.

Alarm lamp/buzzer: Yes.

Restart: Automatic once the alarm cause has disappeared.

- ▶ Contact your installer if the alarm remains active for more than three hours or recurs often.

14.7.27 FAILURE ON SENSOR E2X.T9 HEAT TRANSFER FLUID IN

Function: Activated when the sensor's value indicates a temperature lower than 0 °C.

Reset condition: The value of the sensor indicates >0 °C.

Category: H.

Alarm lamp/buzzer: Yes.

Restart: Automatic once the alarm cause has disappeared.

- ▶ Contact your installer if the alarm remains active for more than three hours or recurs often.

14.7.28 SHORT CIRCUIT ON SENSOR E2X.T9 HEAT TRANSFER FLUID IN

Function: Activated when the sensor's value indicates a temperature higher than 110 °C.

Reset condition: The value of the sensor indicates < 110 °C.

Category: H.

Alarm lamp/buzzer: Yes.

Restart: Automatic once the alarm cause has disappeared.

- ▶ Contact your installer if the alarm remains active for more than three hours or recurs often.

14.7.29 FAILURE ON SENSOR E2X.T10

Function: Activated when the sensor's resistance value indicates a temperature lower than -20 °C.

Reset condition: The value of the sensor indicates > -20 °C.

Category: H.

Alarm lamp/buzzer: Yes.

Restart: Automatic once the alarm cause has disappeared.

- ▶ Contact your installer if the alarm remains active for more than three hours or recurs often.

14.7.30 SHORT CIRCUIT ON SENSOR E2X.T10

Function: Activated when the sensor indicates a temperature in excess of 70 °C.

Reset requirement: The sensor value displayed < 70 °C.

Category: H.

Alarm lamp/buzzer: Yes.

Restart: Automatic once the alarm cause has disappeared.

- ▶ Contact your installer if the alarm remains active for more than three hours or recurs often.

14.7.31 FAILURE ON SENSOR E2X.T11

Function: Activated when the sensor's value indicates a temperature lower than -50 °C.

Reset condition: The value of the sensor indicates > -50 °C.

Category: H.

Alarm lamp/buzzer: Yes.

Restart: Automatic once the alarm cause has disappeared.

- ▶ Contact your installer if the alarm remains active for more than three hours or recurs often.

14.7.32 SHORT CIRCUIT ON SENSOR E2X.T11

Function: Activated when the sensor indicates a temperature in excess of 70 °C.

Reset requirement: The sensor value displayed < 70 °C.

Category: H.

Alarm lamp/buzzer: Yes.

Restart: Automatic once the alarm cause has disappeared.

- ▶ Contact your installer if the alarm remains active for more than three hours or recurs often.

14.8 WARNINGS
14.8.1 ELECTRIC ADDITIONAL HEAT SHUT DOWN DUE TO HIGH TEMPERATURE E2X.T8

Function: The electric heater is turned off. The warning is activated in additional heat mode if the outgoing temperature of the heat transfer fluid exceeds the maximum value.

Reset condition: The warning is deactivated when the temperature falls.

Category: K.

Alarm lamp: Yes.

Restart: Automatic once the alarm cause has disappeared.

- ▶ Contact your installer if the warning recurs often.

14.8.2 HIGH TEMPERATURE DIFFERENCE HEAT TRANSFER FLUID E2X

Function: The warning is activated when the temperature difference between heat transfer fluid out and heat transfer fluid in becomes too high.

Reset condition: The warning is deactivated on acknowledgement of the warning display.

Category: L.

Alarm lamp/buzzer: No.

Restart: The warning does not close anything but is registered in the alarm log.

- ▶ Check and clean the particle filter, if required.
- ▶ Contact your installer if the warning remains after acknowledgement.

14.8.3 HIGH TEMPERATURE DIFFERENCE COLLECTOR CIRCUIT E2X

Function: The warning is activated when the temperature difference between collector circuit out and collector circuit in becomes too big.

Reset condition: The warning is deactivated on acknowledgement of the warning display.

Category: L.

Alarm lamp/buzzer: No.

Restart: The warning does not close anything but is registered in the alarm log.

- ▶ Check and clean the particle filter, if required.
- ▶ Contact your installer if the warning remains after acknowledgement.

14.8.4 THE HEAT PUMP IS NOW WORKING IN ANTI-FREEZE MODE

Function: Activated when the temperature in one of the circuits becomes too low.

Reset condition: The temperature in the circuit is increased.

Category: L.

Alarm lamp/buzzer: No.

Restart: Automatic once the alarm cause has disappeared.

- ▶ Contact your installer.

14.8.5 CHECK CONNECTION TO I/O BOARD X

Function: Depends on the board.

Reset condition: Communication with the board is re-established.

Category: M.

Alarm lamp/buzzer: No.

Restart: Acknowledgement is required.

- ▶ Contact your installer.

14.8.6 CHECK CANBUS CABLE CONNECTION

Function: Communication with the controller has been interrupted. The controller executes a new start if the alarm is still active after two hours. If more than three new starts have been carried out within one hour, the alarm **Too high boot count I/O board BAS x** (category A), → Chapter 14.7.7.

Category: M.

Alarm lamp/buzzer: No.

Restart: Acknowledgement is required.

- ▶ Contact your installer if the warning recurs often.

14.9 INFORMATION LOG

The information log shows information from the heat pump.

14.9.1 HIGH FLOW TEMPERATURE E2X.T8

Function: The information is given if the temperature of the heating medium is too high. The information can appear temporarily when high room and hot water temperatures are set.

Reset condition: The information is deactivated when the temperature falls to the permitted level.

14.9.2 TEMPORARY HEAT PUMP STOP E21.RLP

Function: Activated when the pressure in the refrigerant circuit of the heat pump becomes too low. If the information appears several times during a certain time period, the information transforms into a category A alarm (→ Chapter 14.7.2).

Reset condition: The pressure goes back to the permitted level.

14.9.3 TEMPORARY HEAT PUMP STOP E21.RHP

Function: Activated when the pressure in the refrigerant circuit becomes too high. If the information appears several times during a certain time period, the information transforms into a category A alarm (→ Chapter 14.7.3).

Reset condition: The pressure goes back to the permitted level.

14.9.4 LOW TEMPERATURE COLLECTOR CIRCUIT IN E2X.T10

Function: The information is given if the temperature of the refrigerant to the heat pump is too low. If the information appears several times during a certain time period, the information transforms into a category A alarm (→ Chapter 14.7.5).

Reset condition: The temperature of the collector circuit exceeds the lowest permitted temperature.

14.9.5 LOW TEMPERATURE COLLECTOR CIRCUIT OUT E2X.T11

Function: The information is given if the temperature of the refrigerant from the heat pump is too low. If the information appears several times during a certain time period, the information transforms into a category A alarm (→ Chapter 14.7.6).

Reset condition: The temperature of the collector circuit exceeds the lowest permitted temperature.

14.9.6 HOT WATER PEAK FAILURE, NEW TRY WITHIN 24 HOURS

Function: The hot water has not come up at the right temperature. The hot water peak is repeated at the same time on the next day.

Reset condition: The correct hot water peak temperature is reached.

14.9.7 TEMPORARY HEAT PUMP STOP DUE TO WORKING AREA LIMITS

Function: The compressor stops until the hot gas temperature falls below the set limit. The warning can occur when the heat pump works close to the lowest permitted outdoor temperature.

Reset condition: The hot gas temperature is within the range of the compressor.

14.9.8 TEMPORARY HOT WATER STOP DUE TO WORKING AREA LIMITS

Function: Ongoing hot water operation is aborted and replaced with heating operation. The warning can occur when the heat pump works close to the lowest permitted outdoor temperature.

Reset condition: The hot gas temperature is within the range of the compressor.

14.9.9 ADDITIONAL HEAT IS NOW WORKING AT ITS HIGHEST TEMPERATURE

Function: The additional heat begins to be stepped down. The information is activated in additional heat mode if the outgoing temperature (T1 or T8) approaches the set maximum value. The information is blocked during hot water peaks or extra hot water.

Reset condition: The information is deactivated when the temperature falls.

14.9.10 TEMPORARY HOT WATER STOP E2X

Function: Ongoing DHW mode is temporarily interrupted; the system changes over to heating mode.

Reset condition: DHW temperature drops a few degrees.

15 ENERGY SAVINGS

INSPECTION AND MAINTENANCE

To achieve as low energy consumption as possible for a longer period of time, we recommend that you have an annual service and any maintenance carried out by a competent person.

UNDERFLOOR HEATING

Do not set a flow temperature that is higher than the highest value recommended by the floor manufacturer.

AIRING

Do not leave the windows ajar when you air. This makes heat leave the room all the time, but the air quality in the room does not improve. Instead, open the windows fully for a short time.

ADDITIONAL ELECTRIC HEAT

Different settings (e.g. extra hot water) lead to the activation of an additional electric heat source and thereby to higher energy consumption.

Always select a temperature setting for hot water and heating that is as low as possible.

16 MAINTENANCE

The heat pump requires minimal upkeep. Some inspection is recommended nevertheless for the heat pump to perform as well as possible. Check the following points a couple of times during the first year. Subsequently they should be checked occasionally during the year:

- Safety valves
- Expansion vessel (plastic vessel collector circuit)
- Particle filter

16.1 CHECKING THE SAFETY VALVES



The safety valve should be checked by a qualified engineer - usually as part of an annual service visit.



Never close the safety valve or obstruct its discharge pipe.

- ▶ Check that the waste water hose from the safety valve is not blocked.

16.2 EXPANSION VESSEL

A plastic expansion vessel is connected to the heat pump collector circuit ("the cold side"). The level in the vessel must not be less than minimum level 1/3. If the fluid level is too low, contact your installer.

16.3 PARTICLE FILTER

The particle filter (dirt filter) ensures that no particles or dirt get into the heat exchangers. In time, the filter can become clogged and must be cleaned. There are particle filters on both the "hot and cold sides". The particle filter should be cleaned as follows:

- ▶ Switch off the heat pump with the ON/OFF button.
- ▶ Shut the valve and screw off the sealing lid.
- ▶ Release the locking ring which holds the sieve in the valve. Use the accompanying locking ring bar. (→Image 32)
- ▶ Lift the sieve out from the valve and rinse it clean with water.
- ▶ Replace the sieve, the locking ring and the sealing lid.
- ▶ Open the valve and start the heat pump with the ON/OFF button.

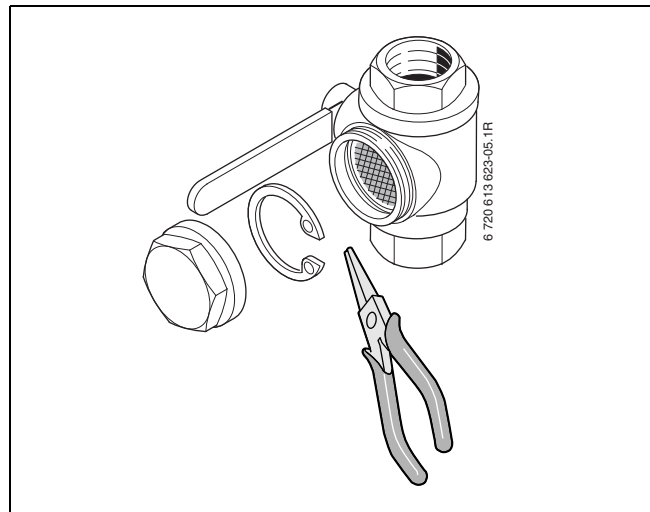

Fig. 32

17 THE GUARANTEE

The Greenstore Liquid to Water heat pump has a 2 year guarantee against faulty material or manufacture subject to Terms and conditions. To read the full Terms and Conditions please visit us online at www.worcester-bosch.co.uk/guarantee. The Guarantee Registration form is available on this same page and can be completed and submitted electronically. Alternatively please telephone one of our Guarantee Registration advisors on 0844 892 2552. Your statutory rights are not affected by the manufacturers guarantee.

NOTES

NOTES

NOTES

Worcester, Bosch Group
Cotswold Way, Warndon, Worcester WR4 9SW.
Tel. 0844 892 9900

Worcester, Bosch Group is a brand name of Bosch Thermotechnology Ltd.
worcester-bosch.co.uk

6 720 802 172

WORCESTER, BOSCH GROUP:

TECHNICAL SUPPORT: 0844 892 4010

APPOINTMENTS: 0844 892 3000

SPARES: 01905 752571

LITERATURE: 0844 892 9800

TRAINING: 01905 752526

SALES: 01905 752640

