

20
15



Enclosures

THE BOLD LOOK
OF **KOHLER**®

Enhancing your home, improving your life

Choosing and planning a new bathroom is an exciting, creative experience. It's a rare opportunity to transform one of the most important parts of your home – where you can relax, refresh and revitalise, and where your daily routine begins and ends.

KOHLER® began designing bathroom products nearly 140 years ago, and we've seen a lot change in that time. In fact, we've been at the forefront of innovation, and our showering products lead the way. From the sleek, award-winning Torsion® to the highly configurable Minima®, we offer a wide range of shower enclosure options.

We've earned a reputation for iconic design and uncompromising quality. With everything from shower doors to shower trays, our wide selection lets you easily upgrade your existing bathroom or custom design a new one.

Table of Contents

Minima	05
Minima Made-to-Measure	17
Torsion	27
Skyline	49
Walk-In/Dividers	77
Bath Screens	85
Shower Trays	89

KOHLER® Quality.

Kohler develops, tests and handcrafts shower enclosures that last a lifetime. Through hard work and no compromise, we have built a reputation as solid as every product we create. We're passionate about what we do and proud of our heritage. Yet we're always looking ahead and ready to evolve. We embrace design innovation whilst never sacrificing the quality and craftsmanship the Kohler brand has been known for since 1873.

Minima®

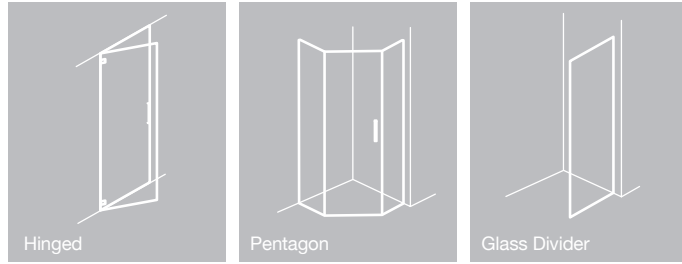

Torsion®

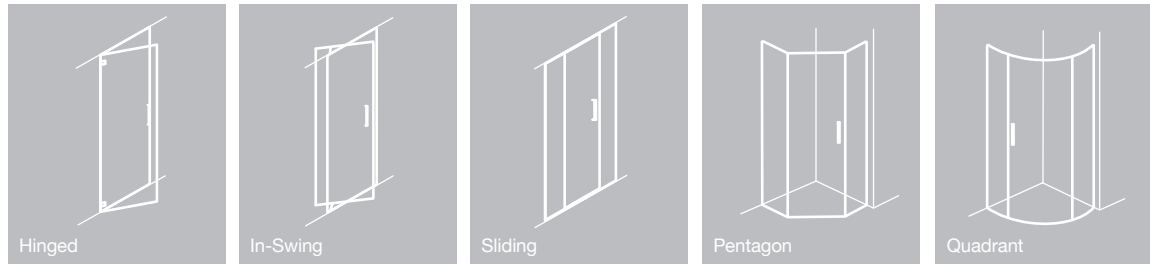

Skyline®

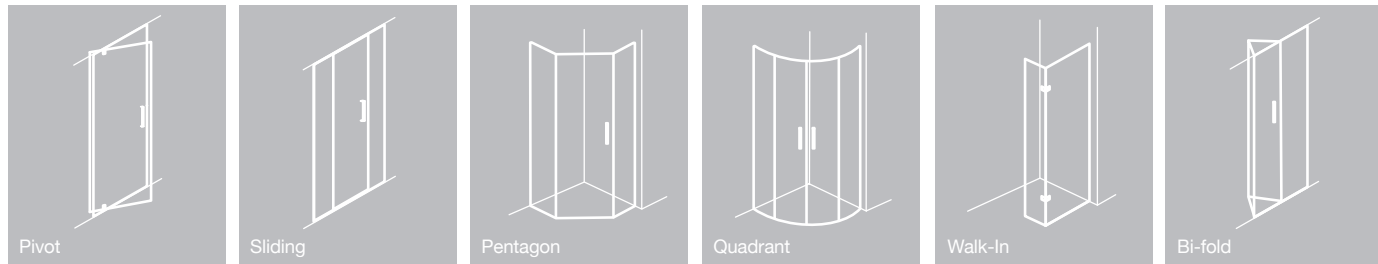

Walk-In

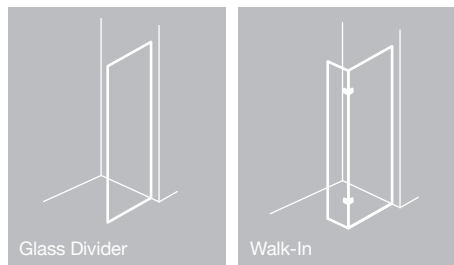

	MINIMA® PAGE 5	TORSION® PAGE 27	SKYLINE® PAGE 49	WALK-IN & DIVIDERS PAGE 77
Bi-fold door			● See page 57	
Bi-fold enclosure			● See page 59	
Bi-fold pentagon			● See page 61	
Divider Panel	● See page 13			● See page 79
Hinged door	● See page 7	● See page 35		
Hinged enclosure	● See page 9	● See page 37		
Hinged pentagon	● See page 11	● See page 39		
In-swing door		● See page 29		
In-swing enclosure		● See page 31		
In-swing pentagon		● See page 33		
Pivot door			● See page 51	
Pivot enclosure			● See page 53	
Pivot pentagon			● See page 55	
Sliding door		● See page 41	● See page 63	
Sliding enclosure		● See page 43	● See page 65	
Quadrant		● See page 45	● See page 71	
Walk-in			● See page 73	● See page 81

Icon Key



Innovation



Coated glass



Power shower approved



2 man lift

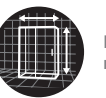

Made-to-measure



Box delivery



Lifetime guarantee



Red Dot award



iF award

Minima[®]

The Minima collection provides leading edge design options across a vast array of standard door and panel sizes. Creative engineering provides ingenious design which means we can remove the frame without compromising function, keeping water in check while light is set free.

Product Pages

301 Hinged Door	07
302 Hinged Enclosure	09
305 Hinged Pentagon	11
327 Divider panel	13
331 Hinged Door with in-line panel	15
Minima Made-to-Measure	17

Features

- 8/10mm thick safety glass
- Reversible for left or right handing
- Self-closing hinges
- Multiple handle & hinge options





301 Minima hinged door shown with geometric hinge and handle
1200 x 900 mm shower tray

Minima® Hinged Door 301

Nominal width (A+B)	Frame Adjustment min - max width	Code	RRP Price
800 mm	772-794 mm	301.080	£951.00
900 mm	872-894 mm	301.090	£1,060.00
1000 mm	972-994 mm	301.100	£1,169.00
1100 mm	1072-1094 mm	301.110	£1,278.00
1200 mm	1172-1194 mm	301.120	£1,387.00
1300 mm	1272-1294 mm	301.130	£1,480.00

Technical drawings:

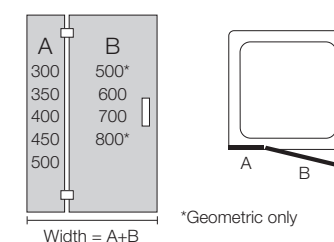

Optional filler section:

- Suitable to use with Minima doors, side panels and enclosures
- Extends the width of a Minima door, side panel or enclosure by 20 mm

To suit	Code	RRP Price
Doors and side panels	551	£72.00

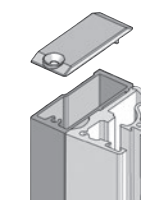

For door opening apertures please speak to your local retailer.

Section 551

Handle & hinge options:

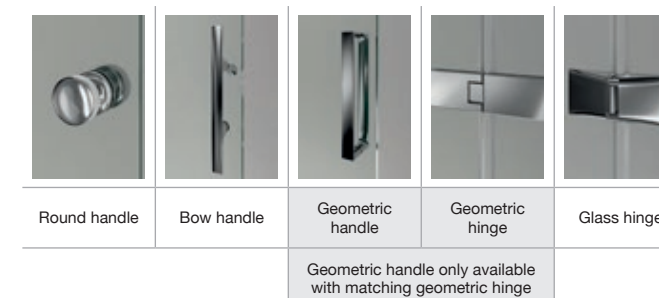

Features

- Reversible for left or right hand fitting
- 45° bracing bars supplied with hinged panel (A) of 400 mm or more
- Self-closing hinges
- Height from top of tray to top of glass 1952 mm
- Overall unit height including 45° bracing bar 1972 mm
- 8mm thick frameless safety glass door
10 mm thick safety glass in-line panels
- Nominal sizes are designed to fit onto standard sizes of shower tray, actual dimensions may differ
- Minimum tray rim width 40 mm
- Please note geometric handles are only available with matching geometric hinges
- Optional seat available

How to order your Minima® Hinged Door:

Step 1

Select your door size.

Step 2

Choose a handle and hinge style.

Step 3

Select a coordinating tray if required.



Made-to-measure



2 man lift



Power shower approved



Lifetime guarantee



Coated glass

Minima® Hinged Enclosure 302

Nominal width (A+B)	Nominal Depth (D)	Frame Adjustment min-max		Code	RRP Price
		Width (mm)	Depth (mm)		
800 mm	800 mm	754-770	754-770	302.080080	£1,589.00
900 mm	900 mm	854-870	854-870	302.090090	£1,751.00
1000 mm	800 mm	954-970	754-770	302.100080	£1,791.00
1000 mm	900 mm	954-970	854-870	302.100090	£1,844.00
1100 mm	800 mm	1054-1070	754-770	302.110080	£1,916.00
1100 mm	900 mm	1054-1070	854-870	302.110090	£1,969.00
1200 mm	800 mm	1154-1170	754-770	302.120080	£2,009.00
1200 mm	900 mm	1154-1170	854-870	302.120090	£2,062.00
1300 mm	800 mm	1254-1270	754-770	302.130080	£2,118.00
1300 mm	900 mm	1254-1270	854-870	302.130090	£2,171.00

Technical drawings:

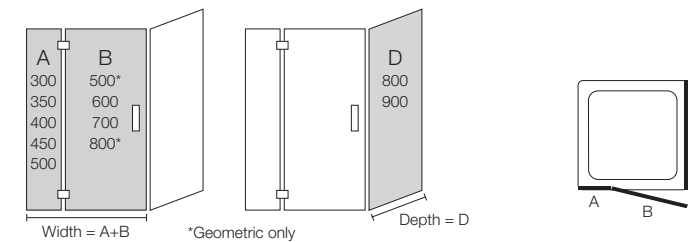

Optional filler section:

- Suitable to use with Minima doors, side panels and enclosures
- Extends the width of a Minima door, side panel or enclosure by 20 mm

To suit	Code	RRP Price
Doors and side panels	551	£72.00

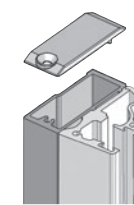

Section 551

For door opening apertures please speak to your local retailer.

Handle & hinge options:

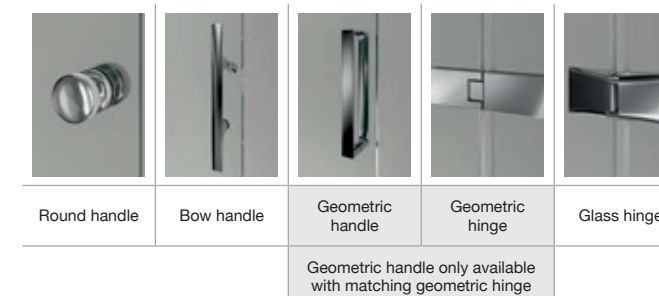

Features

- Reversible for left or right hand fitting
- 45° bracing bar supplied with hinged panel (A) of 400 mm or more
- 45° bracing bar supplied with side panel (D) up to 1000 mm
- 90° bracing bar supplied with side panel (D) over 1000 mm
- Self-closing hinges
- Height from top of tray to top of glass 1952 mm
- Overall unit height including 45° bracing bar 1972 mm
- Overall unit height including 90° bracing bar 1992 mm
- 8 mm thick frameless safety glass door, 10 mm thick safety glass side and in-line panels
- Nominal sizes are designed to fit onto standard sizes of shower tray, actual dimensions may differ
- Minimum tray rim width 40 mm
- For widths greater than 1200 mm, the maximum depth is 900 mm
- Please note geometric handles are only available with matching geometric hinges
- Optional seat available

How to order your Minima® Hinged Enclosure:

Step 1

Select your enclosure size.

Step 2

Choose a handle and hinge style.

Step 3

Select a coordinating tray if required.



Made-to-measure



2 man lift



Power shower approved



Lifetime guarantee



Coated glass

Minima® Hinged Pentagon 305

Nominal width (A+B)	Nominal Depth (D)	Frame Adjustment min-max Depth (mm)	Code	RRP Price
900 mm	900 mm	854-870	305.090	£1,636.00
1200 mm	900 mm	1154-1170	305.120090	£1,796.00

Technical drawings:

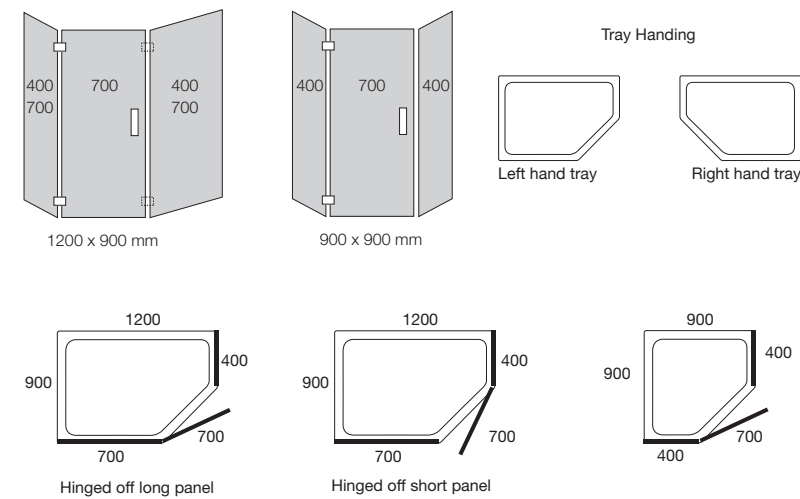

Optional filler section:

- Suitable to use with Minima doors, side panels and enclosures
- Extends the width of a Minima door, side panel or enclosure by 20 mm

To suit	Code	RRP Price
Doors and side panels	551	£72.00

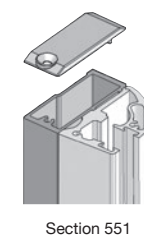

For door opening apertures please speak to your local retailer.

Handle & hinge options:

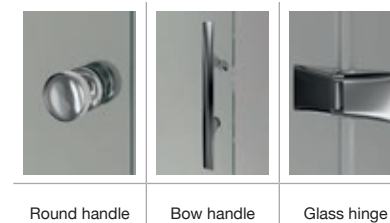

Round handle Bow handle Glass hinge

Features

- Reversible for left or right hand fitting
- Specify hinge mounted on large or small panel when ordering extended units
- Extended trays are handed, please specify left or right with order
- Two 45° bracing bars supplied with all pentagon units
- Self-closing hinges
- Height from top of tray to top of glass 1952 mm
- Overall unit height including 45° bracing bar 1972 mm
- 8 mm thick frameless safety glass door, 10 mm thick safety glass side and in-line panels
- Nominal sizes are designed to fit onto standard sizes of shower tray, actual dimensions may differ
- Minimum tray rim width 40 mm
- Optional seat available

How to order your Minima® Hinged Pentagon:

Step 1

Select your pentagon size.

Step 2

Choose a handle and hinge style.

Step 3

Select a coordinating tray if required.



Made-to-measure



2 man lift



Power shower approved



Lifetime guarantee



Coated glass

Minima® Glass Divider Panel 327

Panel Size	Panel Adjustment min-max Width	Code	RRP Price
400 mm	354-370 mm	327.040	£303.00
800 mm	754-770 mm	327.080	£479.00
900 mm	854-870 mm	327.090	£519.00
1000 mm	954-970 mm	327.100	£558.00
1200 mm	1154-1170 mm	327.120	£638.00
1400 mm	1340-1356 mm	327.140	£718.00

Technical drawings:

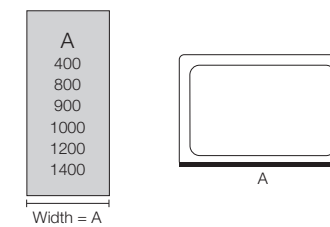

Optional filler section:

- Suitable to use with Minima doors, side panels and enclosures
- Extends the width of a Minima door, side panel or enclosure by 20 mm

To suit	Code	RRP Price
Doors and side panels	551	£72.00

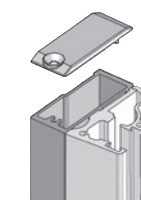

For door opening apertures please speak to your local retailer.

Section 551

Optional bracing bar:

Bracing bar option	Code	RRP Price
90° bracing bar	400983	£186.00

When choosing a glass divider panel, please be aware that spray/mist may extend beyond the length of the glass panel, the amount will depend upon the power of the shower and its location. We would recommend use of these products with tiled floors.

Features

- Reversible for left or right hand fitting
- 45° bracing bar supplied with 800, 900 and 1000 mm panels
- 90° bracing bar supplied with 1200 and 1400 mm panels
- Height from top of tray to top of glass 1952 mm
- Overall unit height including 45° bracing bar 1972 mm
- Overall unit height including 90° bracing bar 1992 mm
- 10 mm thick safety glass
- Nominal sizes are designed to fit onto standard sizes of shower tray. Actual dimensions may differ
- Optional seat available

How to order your Minima® Glass Divider Panel:

Step 1

Select your divider panel size.

Step 2

Select a coordinating tray if required.



Made-to-measure



2 man lift



Power shower approved



Lifetime guarantee



Coated glass



331 Minima hinged door with in-line panels shown with geometric hinges and handle
1700 x 760mm shower tray

Minima® Hinged Door with In-Line Panels 331

Nominal width (A+B+C)	Frame Adjustment min-max Width	Code	RRP Price
1200 mm	1172-1194 mm	331.120	£1,412.00
1300 mm	1272-1294 mm	331.130	£1,518.00
1400 mm	1372-1394 mm	331.140	£1,627.00
1500 mm	1472-1494 mm	331.150	£1,734.00
1600 mm	1572-1594 mm	331.160	£1,830.00
1700 mm	1672-1694 mm	331.170	£1,937.00

Technical drawings:

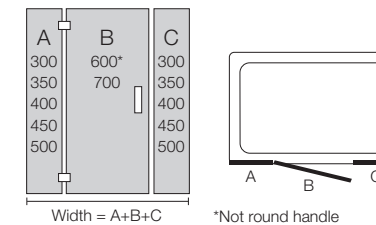

Optional filler section:

- Suitable to use with Minima doors, side panels and enclosures
- Extends the width of a Minima door, side panel or enclosure by 20 mm

To suit	Code	RRP Price
Doors and side panels	551	£72.00

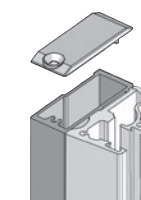

Section 551

For door opening apertures please speak to your local retailer.

Handle & hinge options:

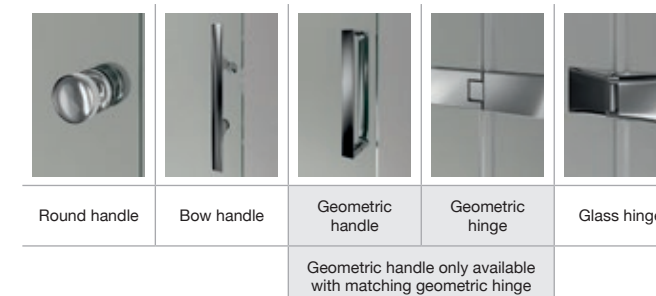

Features

- Reversible for left or right hand fitting
- 45° bracing bars supplied with hinged panel (A) and in-line panel (C) of 400 mm or more
- Self-closing hinges
- Height from top of tray to top of glass 1952 mm
- Overall unit height including 45° bracing bar 1972 mm
- 8 mm thick frameless safety glass door, 10 mm thick safety glass in-line panels
- Nominal sizes are designed to fit onto standard sizes of shower tray, actual dimensions may differ
- Minimum tray rim width 40 mm
- Optional seat available

How to order your Minima® Hinged Door with In-Line Panels:

Step 1

Select your door size.

Step 2

Choose a handle and hinge style.

Step 3

Select a coordinating tray if required.

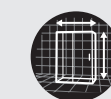

Made-to-measure



2 man lift



Power shower approved



Lifetime guarantee



Coated glass

Minima Made-to-Measure

Minima made-to-measure shower enclosures invite you to create your own unique showering space. With glass panels up to 2 metres wide, you can build the shower of your dreams or renovate an atypical space. KOHLER® provides a home measure and installation service to ensure your Minima made-to-measure door or enclosure is a perfect fit.

Product Pages

301 Hinged Door	21
302 Hinged Enclosure	22
305 Hinged Pentagon	23
327 Divider panel	24
331 Hinged Door with in-line panel	25

Features

- Max panel width 2m
- Multiple handle & hinge options
- Dwarf wall options
- Suitable for difficult angles and notches
- Home measure service available



MADE TO MEASURE

Minima made-to-measure shower enclosures invite you to create your own unique showering space. With bespoke capabilities you can build the shower of your dreams or renovate an atypical space.

Choose from a selection of wall and ceiling fittings, add a towel rail for enhanced comfort or convenience, or incorporate a dwarf wall into your design – just about anything is possible with Minima made-to-measure. We'll even build it for you.

Kohler provides a home measure and installation service to ensure your Minima made-to-measure door or enclosure is a perfect fit. From the initial planning stages through to installation, we'll see to it that everything runs smoothly.

Minima Made-to-Measure & Installation Service



Measure



Design

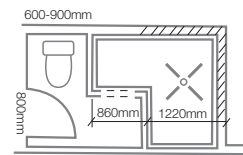

Customise

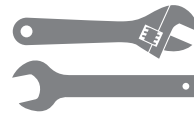

Install

The Home Measure service can only be undertaken after tiling is complete and the tray is installed level. Following the Home Measure service, if you wish, our engineer will return to install the unit, further ensuring your complete satisfaction. Installation is only available if a Kohler engineer has carried out the survey and measure. Logistics and dimensions in your home could mean not everything is possible given a specific situation. Your retailer can provide guidance on this or feel free to call us on 0844 571 0048 for further assistance.

Minima Made-to-Measure Features

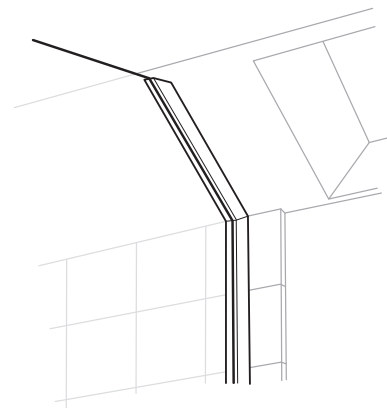

Angle & Notch Cuts

Whether it's an unusual loft space or complex bathroom layout, glass panels and doors can be bespoke to allow for that ideal fit. Angled cuts offer lines that follow the contours of the room and notches ensure no obstructive architecture prevents the perfect showering experience.

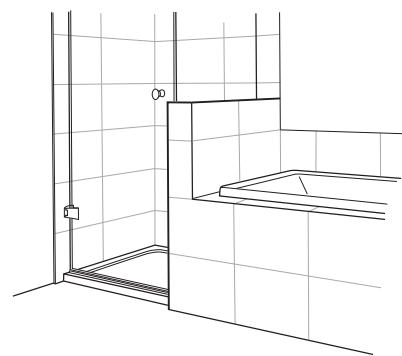

Dwarf Wall

Whether there is a low level wall or bath end, Minima made-to-measure offers a solution to suit your space. Adapting shower enclosure panels around the constraints of the modern home, this feature allows for an integral showering space.

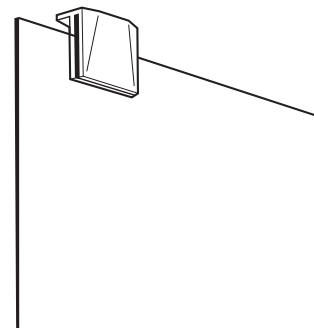

Ceiling Clamp

When the shower enclosure of choice makes a room with floor to ceiling panels, you can feel sure that the unit is fully secured and aesthetically pleasing with this purposeful yet clean looking solution.

Enclosures

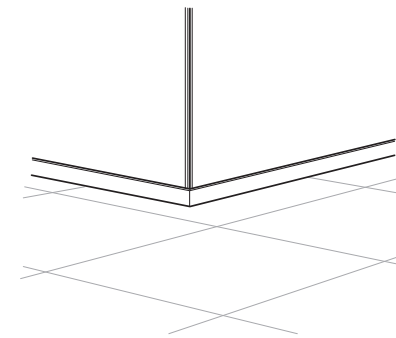

Surface Floor Profile

The most common means of securing your shower enclosure to the floor, these join surfaces to glass with a slim, yet sleek aluminum profile.

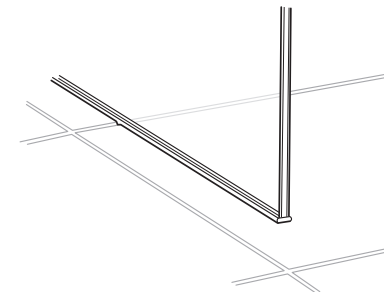

Recessed Floor Profile

Specifically for divider panel applications, this feature gives the impression of a seamless join between glass and floor.

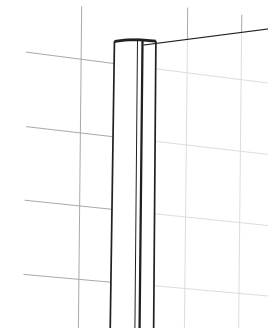

Surface Wall Profile

The most conventional method of securing your shower enclosure to the wall, these connect surfaces to glass.

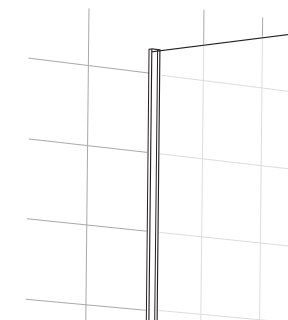

Recessed Wall Profile

Commonly used in divider panel applications, this feature gives the perception of glass and wall integration.



Towel Rail

Add that personal touch with a convenient towel rail.

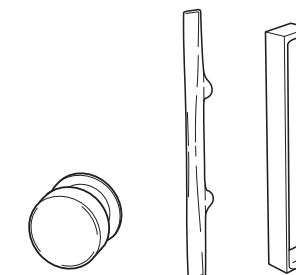

Handles

Round handle
Bow handle
Geometric handle

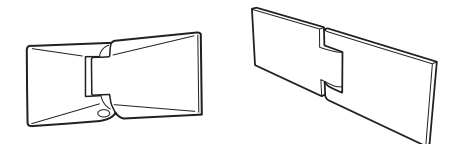

Hinges

Glass hinge
Geometric hinge

Minima® Made-to-Measure Hinged Door 301

Width	RRP Price
Up to 1000 mm	£1323.34
1001-1300 mm	£1733.13
per 100 mm above 1301 mm	£109.28

Additional Made-to-Measure Glass Prices	RRP Price
Per angle cut (requires Measurement Service)	£243.83
Per notch cut (requires Measurement Service)	£300.00

Measurement and Installation Options	RRP Price
Measurement Only Service	£145.20
Measurement and Installation Service	£508.20

Technical drawings:

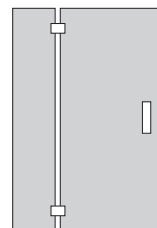

Handle & hinge options:

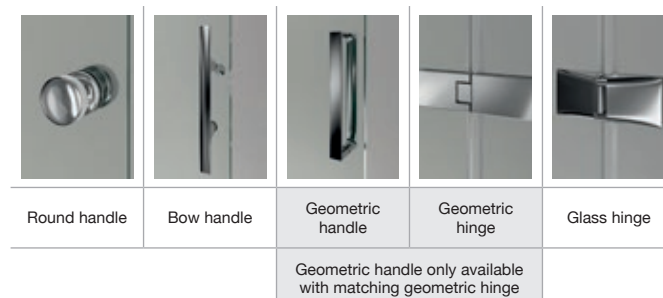

Features

- Height requirements by special request
- For doors with in-line panels and prices assume standard door size specified (please ask for pricing on non-standard doors)

Made-to-measure options:

- Surface wall profile
- Towel rail
- Ceiling fixings
- Dwarf wall options
- Standard handle and hinge options
- Geometric hinge and handle options also available

How to order your Minima Made-to-Measure Hinged Door:

Step 1

Choose whether you would like a measurement service or measurement and installation service.

Step 2

Select a handle and hinge style.

Step 3

Select a coordinating tray if required.



Made-to-measure



2 man lift



Power shower approved



Lifetime guarantee



Coated glass

Enclosures

Minima® Made-to-Measure Hinged Enclosure 302

Width	RRP Price
Up to 1000 mm	£2191.08
1001-1300 mm	£2461.73
per 100 mm above 1301 mm	£108.26

Additional Made-to-Measure Glass Prices	RRP Price
Per angle cut (requires Measurement Service)	£243.83
Per notch cut (requires Measurement Service)	£300.00

Measurement and Installation Options	RRP Price
Measurement Only Service	£145.20
Measurement and Installation Service	£580.80

Technical drawings:

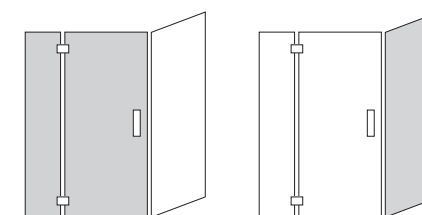

Handle & hinge options:

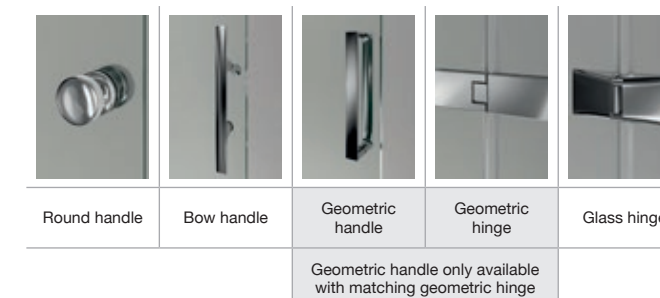

Features

- Height requirements by special request
- For doors with in-line panels and prices assume standard door size specified (please ask for pricing on non-standard doors)

Made-to-measure options:

- Surface wall profile
- Towel rail
- Ceiling fixings
- Dwarf wall options
- Standard handle and hinge options
- Geometric hinge and handle options also available

How to order your Minima Made-to-Measure Hinged Enclosure:

Step 1

Choose whether you would like a measurement service or measurement and installation service.

Step 2

Select a handle and hinge style.

Step 3

Select a coordinating tray if required.



Made-to-measure



2 man lift



Power shower approved



Lifetime guarantee



Coated glass

Minima® Made-to-Measure Pentagon 305

Width	Depth	RRP Price
Up to 1000 mm	Up to 1000 mm	£2044.60
1001-1400 mm	Up to 1000 mm	£2244.28
per 100 mm above 1401 mm	per 100 mm above 1000 mm	£106.22

Additional Made-to-Measure Glass Prices	RRP Price
Per angle cut (requires Measurement Service)	£243.83
Per notch cut (requires Measurement Service)	£300.00

Measurement and Installation Options	RRP Price
Measurement Only Service	£145.20
Measurement and Installation Service	£656.40

Technical drawings:

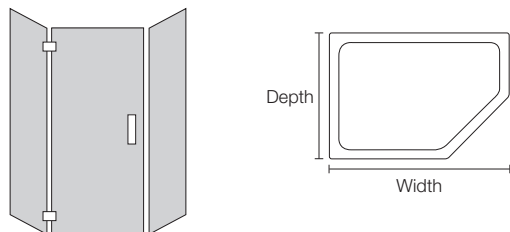

Handle & hinge options:



Round handle Bow handle Glass hinge

Features

- Height requirements by special request
- For doors with in-line panels and prices assume standard door size specified (please ask for pricing on non-standard doors)

Made-to-measure options:

- Surface wall profile
- Towel rail
- Ceiling fixings
- Dwarf wall options
- Standard handle and hinge options

How to order your Minima Made-to-Measure Pentagon:

Step 1

Choose whether you would like a measurement service or measurement and installation service.

Step 2

Select a handle and hinge style.

Step 3

Select a coordinating tray if required.

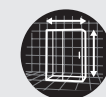

Made-to-measure



2 man lift



Power shower approved



Lifetime guarantee



Coated glass

Enclosures

Minima® Made-to-Measure Glass Divider Panel 327

Width	RRP Price
250-400 mm	£503.44
401-800 mm	£796.60
801-900 mm	£863.50
901-1000 mm	£929.36
1001-1200 mm	£1062.12
1201-1400 mm	£1404.14
per 100 mm above 1401 mm	£106.22

Additional Made-to-Measure Glass Prices	RRP Price
Per angle cut (requires Measurement Service)	£243.83
Per notch cut (requires Measurement Service)	£300.00

Measurement and Installation Options	RRP Price
Measurement Only Service	£145.20
Measurement and Installation Service	£462.00

Technical drawings:



Features

- Height requirements by special request

Made-to-measure options:

- Surface wall profile
- Recessed wall profile
- Surface floor profile
- Recessed floor profile
- Towel rail
- Ceiling fixings

How to order your Minima Made-to-Measure Glass Divider Panel:

Step 1

Choose whether you would like a measurement service or measurement and installation service.

Step 2

Select a coordinating tray if required.



Made-to-measure



2 man lift



Power shower approved



Lifetime guarantee



Coated glass

When choosing a glass divider panel, please be aware that spray/mist may extend beyond the length of the glass panel, the amount will depend upon the power of the shower and its location. We would recommend use of these products with tiled floors.

Minima® Made-to-Measure Hinged Door with In-Line Panels 331

Width	RRP Price
Up to 1200 mm	£1758.07
1201-1400 mm	£2028.70
1401-1700 mm	£2231.14
per 100 mm above 1701 mm	£108.26

Additional Made-to-Measure Glass Prices	RRP Price
Per angle cut (requires Measurement Service)	£243.83
Per notch cut (requires Measurement Service)	£300.00

Measurement and Installation Options	RRP Price
Measurement Only Service	£145.20
Measurement and Installation Service	£580.40

Technical drawings:

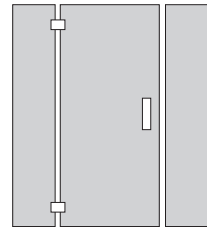

Handle & hinge options:

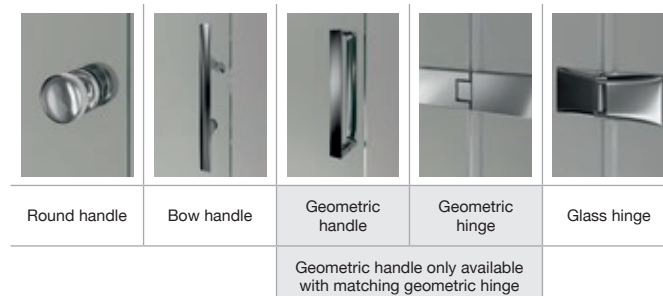

Features

- Height requirements by special request
- For doors with in-line panels prices assume standard door size specified. (Please ask for pricing on non-standard doors)

Made-to-measure options:

- Surface wall profile
- Towel rail
- Ceiling fixings
- Dwarf wall options
- Standard handle and hinge options
- Geometric hinge and handle options also available

How to order your Minima Made-to-Measure with In-Line Panels:

Step 1

Choose whether you would like a measurement service or measurement and installation service.

Step 2

Select a handle and hinge style.

Step 3

Select a coordinating tray if required.

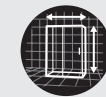

Made-to-measure



2 man lift



Power shower approved



Lifetime guarantee



Coated glass

Minima® Made-to-Measure Notes

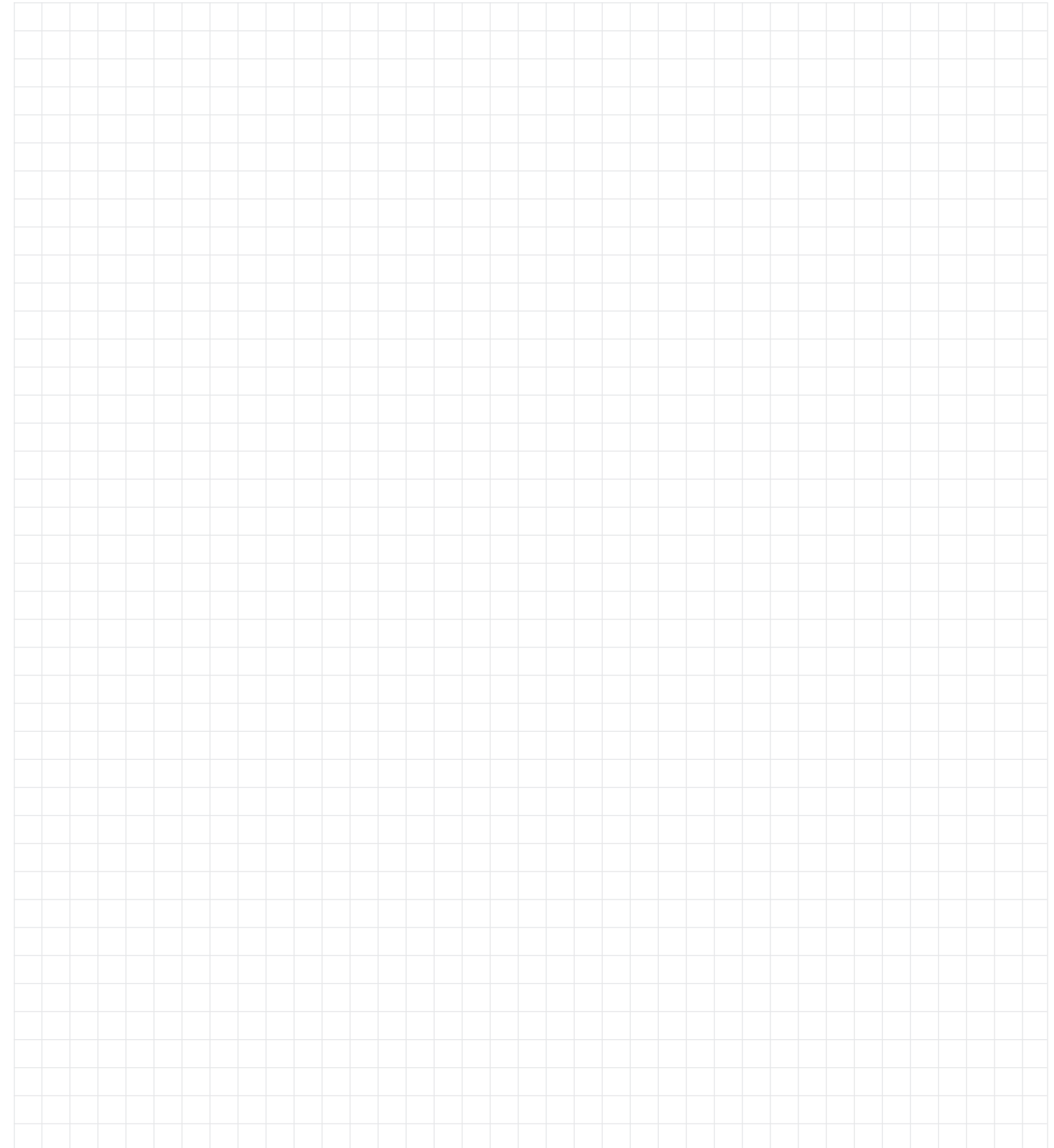

Torsion®

Inspired by the way modern architecture flows cleanly through space, Torsion shower doors fuse functionality with structural integrity and flawless design. Torsion received the 2013 IF product design award as well as the 2012 red dot design award.

Product Pages

711 In-swing Door	29
712 In-swing Enclosure	31
715 In-swing Pentagon	33
761 Hinged Door	35
762 Hinged Enclosure	37
765 Hinged Pentagon	39
771 Sliding Door	41
772 Sliding Enclosure	43
788 Quadrant Seat & Shelf	45 47

Features

- 8mm thick safety glass
- Clear glazing
- Optional seat & shelf
- Hidden mechanisms for the ease of cleaning
- Adjustable ball catch for long-life reliable operation
- IF & Red Dot design award winner



Torsion® In-Swing Door 711

Geometric Handle

Tray size (mm)	Door adjustment min-max width	Door opening aperture	LH door code	RH door code	RRP Price
760	720-760 mm	540 mm	1.1853.159	1.1853.160	£811.00
800	760-800 mm	580 mm	1.1853.161	1.1853.162	£811.00
900	860-900 mm	680 mm	1.1853.163	1.1853.164	£857.00
1000	960-1000 mm	580 mm	1.1853.165	1.1853.166	£944.00
1200	1160-1200 mm	680 mm	1.1853.167	1.1853.168	£1,071.00

Twist Handle

Tray size (mm)	Door adjustment min-max width	Door opening aperture	LH door code	RH door code	RRP Price
760	720-760 mm	540 mm	1.1853.124	1.1853.125	£811.00
800	760-800 mm	580 mm	1.1853.126	1.1853.127	£811.00
900	860-900 mm	680 mm	1.1853.128	1.1853.129	£857.00
1000	960-1000 mm	580 mm	1.1853.130	1.1853.131	£944.00
1200	1160-1200 mm	680 mm	1.1853.132	1.1853.133	£1,071.00

Technical drawings:

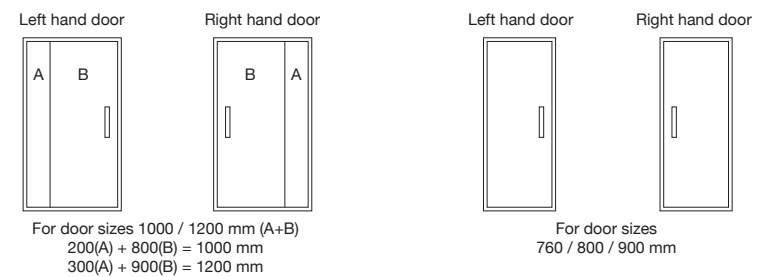

Optional filler section:

- Suitable to use with Torsion® doors, side panels and enclosures
- Extends the width of a Torsion door, side panel or enclosure by 10 mm

To suit	Code	RRP Price
Door	1.1853.140	£41.00
Side panel	1.1853.141	£41.00

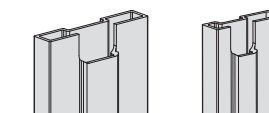

For in-swing dimensions please speak to your local retailer.

Door filler

Side panel filler

Handle & hinge options:



Geometric handle

Twist handle

Seat & shelf options:



Torsion® Seat

Torsion® Shelf

Features

- Door position when open denotes handing, please state left or right when ordering
- 8 mm thick safety glass
- Clear glazing
- Optional seat and shelf – see page 47-48 for details
- Hidden mechanisms for ease of cleaning
- Adjustable ball catch for life-long reliable operation
- 20 mm adjustment on each wall profile for out of true walls
- Height from top of tray 1950 mm
- Minimum tray rim width 60 mm
- Please allow 100 mm clearance above the door for any adjustments
- Small amount of spray/mist due to the 3-4 mm gap under the door

How to order your Torsion® In-Swing Door:

Step 1

Select your door size.

Step 2

Choose a handle style.

Step 3

Select a coordinating tray if required.



IF award



Red Dot award



Innovation



Lifetime guarantee



Coated glass



Power showerer approved



2 man lift

Enclosures

Torsion® In-Swing Enclosure 712

Geometric Handle

Tray size (mm)	Door adjustment min-max width	Door opening aperture	LH door code	RH door code	RRP Price
760	720-740 mm	540 mm	1.1853.159	1.1853.160	£811.00
800	760-780 mm	580 mm	1.1853.161	1.1853.162	£811.00
900	860-880 mm	680 mm	1.1853.163	1.1853.164	£857.00
1000	960-980 mm	580 mm	1.1853.165	1.1853.166	£944.00
1200	1160-1180 mm	680 mm	1.1853.167	1.1853.168	£1,071.00

Twist Handle

Tray size (mm)	Door adjustment min-max width	Door opening aperture	LH door code	RH door code	RRP Price
760	720-740 mm	540 mm	1.1853.124	1.1853.125	£811.00
800	760-780 mm	580 mm	1.1853.126	1.1853.127	£811.00
900	860-880 mm	680 mm	1.1853.128	1.1853.129	£857.00
1000	960-980 mm	580 mm	1.1853.130	1.1853.131	£944.00
1200	1160-1180 mm	680 mm	1.1853.132	1.1853.133	£1,071.00

Reversible Panel

Nominal width (A+B+C)	Frame Adjustment min-max Width	Code	RRP Price
760 mm	720-740 mm	1.1853.101	£459.00
800 mm	760-780 mm	1.1853.102	£459.00
900 mm	860-880 mm	1.1853.103	£485.00
1000 mm	960-980 mm	1.1853.104	£521.00

Technical drawings:

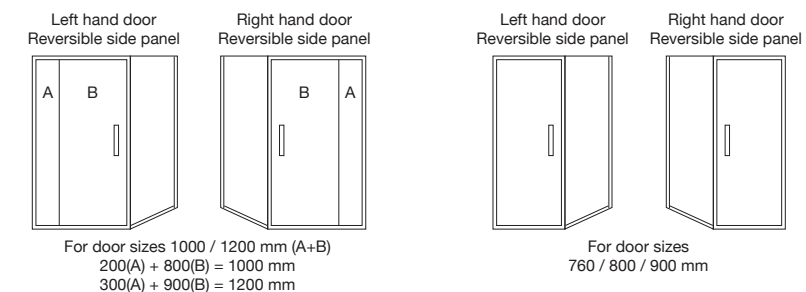

Optional filler section:

- Suitable to use with Torsion® doors, side panels and enclosures
- Extends the width of a Torsion door, side panel or enclosure by 10 mm

To suit	Code	RRP Price
Door	1.1853.140	£41.00
Side panel	1.1853.141	£41.00

For in-swing dimensions please speak to your local retailer.

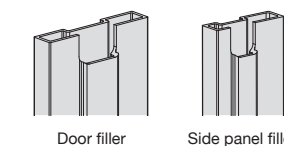

Handle & hinge options:

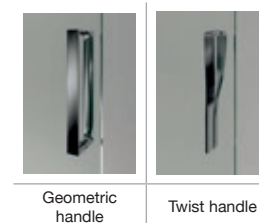

Seat & shelf options:

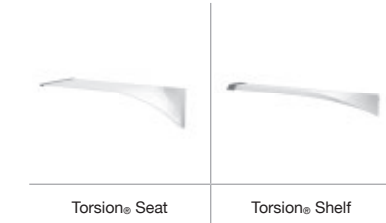

Features

- Door position when open denotes handing, please state left or right when ordering
- 8 mm thick safety glass
- Clear glazing
- Optional seat and shelf – see page 47-48 for details
- Hidden mechanisms for ease of cleaning
- Adjustable ball catch for life-long reliable operation
- 20 mm adjustment on each wall profile for out-of-true walls, 40 mm overall adjustment
- Height from top of tray 1950 mm
- Minimum tray rim width 60 mm
- Please allow 100 mm clearance above the enclosure for any adjustments
- Small amount of spray/mist due to the 3-4 mm gap under the door

How to order your Torsion® In-Swing Enclosure:

Step 1

Select your door and panel size.

Step 2

Choose a handle style.

Step 3

Select a coordinating tray if required.



IF award



Red Dot award



Innovation



Lifetime guarantee



Coated glass



Power showerer approved



2 man lift



715 Torsion in-swing pentagon enclosure shown with twist handle
1200 x 900mm shower tray

Enclosures

Torsion® In-Swing Pentagon 715

Geometric Handle

Tray size (mm)	Door adjustment min-max width	Door opening aperture	LH door code	RH door code	RRP Price
900x900	720-760 mm	540 mm	C1.1853.122IG	C1.1853.160IGRH	£1,343.00
1200x900	720-760 mm	540 mm	C1.1853.123IG	C1.1853.123IGRH	£1,557.00

Twist Handle

Tray size (mm)	Door adjustment min-max width	Door opening aperture	LH door code	RH door code	RRP Price
900x900	720-760 mm	540 mm	C1.1853.124IT	C1.1853.125ITRH	£1,343.00
1200x900	720-760 mm	540 mm	C1.1853.123IT	C1.1853.123ITRH	£1,557.00

Technical drawings:

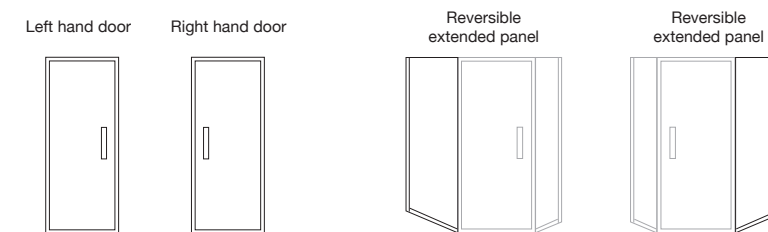

Optional filler section:

- Suitable to use with Torsion® doors, side panels and enclosures
- Extends the width of a Torsion door, side panel or enclosure by 10 mm

To suit	Code	RRP Price
Door	1.1853.140	£41.00
Side panel	1.1853.141	£41.00

For in-swing dimensions please speak to your local retailer.

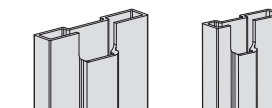

Door filler

Side panel filler

Handle & hinge options:



Geometric handle

Twist handle

Seat & shelf options:



Torsion® Seat

Torsion® Shelf

Features

- Door position when open denotes handing, please state left or right when ordering
- 8 mm thick safety glass
- Clear glazing
- Optional seat and shelf – see page 47-48 for details
- Hidden mechanisms for ease of cleaning
- Adjustable ball catch for life-long reliable operation
- 20 mm adjustment on each wall profile for out-of-true walls, 40 mm overall adjustment
- Height from top of tray 1950 mm
- Minimum tray rim width 60 mm
- Please allow 100 mm clearance above the enclosure for any adjustments
- Small amount of spray/mist due to the 3-4 mm gap under the door

How to order your Torsion® In-Swing Pentagon:

Step 1

Select your pentagon size.

Step 2

Choose a handle style.

Step 3

Select a coordinating tray if required.



IF award



Red Dot award



Innovation



Lifetime guarantee



Coated glass



Power showerer approved



2 man lift

Torsion® Hinged Door 761

Geometric Handle

Door size	Door adjustment min - max width	Door opening aperture	Code	RRP Price
760 mm	720-760 mm	620 mm	1.1853.142	£730.00
800 mm	760-800 mm	660 mm	1.1853.143	£730.00
900 mm	860-900 mm	760 mm	1.1853.144	£776.00
1000 mm	960-1000 mm	760 mm	1.1853.145	£862.00
1200 mm	1160-1200 mm	760 mm	1.1853.146	£990.00

Twist Handle

Door size	Door adjustment min - max width	Door opening aperture	Code	RRP Price
760 mm	720-760 mm	620 mm	1.1853.105	£730.00
800 mm	760-800 mm	660 mm	1.1853.106	£730.00
900 mm	860-900 mm	760 mm	1.1853.107	£776.00
1000 mm	960-1000 mm	760 mm	1.1853.108	£862.00
1200 mm	1160-1200 mm	760 mm	1.1853.109	£990.00

Technical drawings:

Reversible door

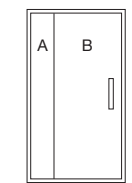

For door sizes 1000 / 1200 mm (A+B)
 200(A) + 800(B) = 1000 mm
 300(A) + 900(B) = 1200 mm

Reversible door



For door sizes
 760 / 800 / 900 mm

Optional filler section:

- Suitable to use with Torsion® doors, side panels and enclosures
- Extends the width of a Torsion door, side panel or enclosure by 10 mm

To suit	Code	RRP Price
Door	1.1853.140	£41.00
Side panel	1.1853.141	£41.00

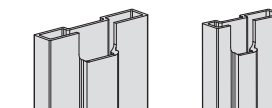

Door filler

Side panel filler

Handle & hinge options:



Geometric handle

Twist handle

Seat & shelf options:



Torsion® Seat

Torsion® Shelf

Features

- Reversible for left or right hand fitting
- 8 mm thick safety glass
- Clear glazing
- Optional seat and shelf – see page 47-48 for details
- Flush-fitting bonded hinges for ease of cleaning
- Adjustable ball catch for life-long reliable operation
- 20 mm adjustment on each wall profile for out-of-true walls
- Height from top of tray 1950 mm
- Minimum tray rim width 60 mm

How to order your Torsion® Hinged Door:

Step 1

Select your door size.

Step 2

Choose a handle style.

Step 3

Select a coordinating tray if required.



IF award



Red Dot award



Innovation



Lifetime guarantee



Coated glass



Power showerer approved



2 man lift



762 Torsion hinged enclosure shown with twist handle
1200 x 800mm shower tray

Torsion® Hinged Enclosure 762

Geometric Handle

Door size	Door adjustment min-max width	Door opening aperture	Code	RRP Price
760 mm	720-740 mm	620 mm	1.1853.142	£730.00
800 mm	760-780 mm	660 mm	1.1853.143	£730.00
900 mm	860-880 mm	760 mm	1.1853.144	£776.00
1000 mm	960-980 mm	760 mm	1.1853.145	£862.00
1200 mm	1160-1180 mm	760 mm	1.1853.146	£990.00

Twist Handle

Door size	Door adjustment min-max width	Door opening aperture	Code	RRP Price
760 mm	720-740 mm	620 mm	1.1853.105	£730.00
800 mm	760-780 mm	660 mm	1.1853.106	£730.00
900 mm	860-880 mm	760 mm	1.1853.107	£776.00
1000 mm	960-980 mm	760 mm	1.1853.108	£862.00
1200 mm	1160-1180 mm	760 mm	1.1853.109	£990.00

Reversible Panel size	Panel adjustment min - max width	Code	RRP Price
760 mm	720-740 mm	1.1853.101	£459.00
800 mm	760-780 mm	1.1853.102	£459.00
900 mm	860-880 mm	1.1853.103	£485.00
1000 mm	960-980 mm	1.1853.104	£521.00

Technical drawings:

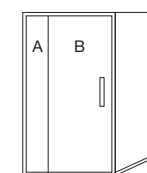

Reversible door and side panel.
For door sizes 1000 / 1200 mm (A+B)
200(A) + 800(B) = 1000 mm
300(A) + 900(B) = 1200 mm

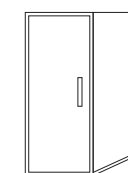

Reversible door and side panel.
For door sizes 760 / 800 / 900 mm

Optional filler section:

- Suitable to use with Torsion® doors, side panels and enclosures
- Extends the width of a Torsion door, side panel or enclosure by 10 mm

To suit	Code	RRP Price
Door	1.1853.140	£41.00
Side panel	1.1853.141	£41.00

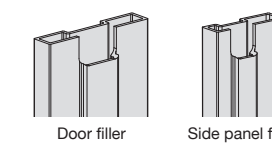

Handle & hinge options:



Geometric handle Twist handle

Seat & shelf options:



Torsion® Seat Torsion® Shelf

Features

- Reversible for left or right hand fitting
- Side panels are reversible
- 8 mm thick safety glass
- Clear glazing
- Optional seat and shelf – see page 47-48 for details
- Flush-fitting bonded hinges for ease of cleaning
- Adjustable ball catch for life-long reliable operation
- 20 mm adjustment on each wall profile for out-of-true walls
- Height from top of tray 1950 mm
- Minimum tray rim width 60 mm

How to order your Torsion® Hinged Enclosure:

Step 1

Select your door and panel size.

Step 2

Choose a handle style.

Step 3

Select a coordinating tray if required.



IF award



Red Dot award



Innovation



Lifetime guarantee



Coated glass



Power showerer approved



2 man lift



765 Torsion hinged pentagon shown with twist handle
900 x 900mm shower tray

Enclosures

Torsion® Hinged Pentagon 765

Geometric Handle

Tray size	Door adjustment min-max width	Door opening aperture	Code	RRP Price
900 x 900 mm	720-740 mm	620 mm	C1.1853.122HG	£1,262.00
1200 x 900 mm	720-740 mm	620 mm	C1.1853.123HG	£1,476.00

Twist Handle

Tray size	Door adjustment min-max width	Door opening aperture	Code	RRP Price
900 x 900 mm	720-740 mm	620 mm	C1.1853.122HT	£1,262.00
1200 x 900 mm	720-740 mm	620 mm	C1.1853.123HT	£1,476.00

Technical drawings:

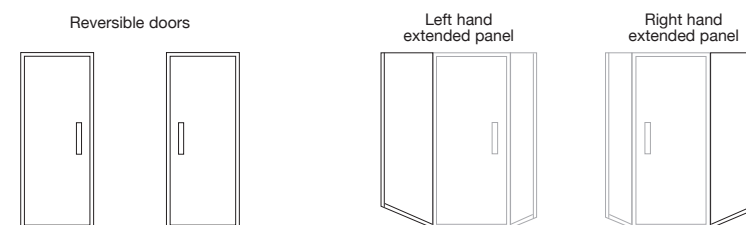

Optional filler section:

- Suitable to use with Torsion® doors, side panels and enclosures
- Extends the width of a Torsion door, side panel or enclosure by 10 mm

To suit	Code	RRP Price
Door	1.1853.140	£41.00
Side panel	1.1853.141	£41.00

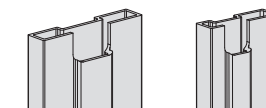

Door filler Side panel filler

Handle & hinge options:



Geometric handle Twist handle

Seat & shelf options:



Torsion® Seat Torsion® Shelf

Features

- Extended pentagons are handed to suit tray, state left or right when ordering
- Reversible door for left or right hand fitting
- 8 mm thick safety glass
- Clear glazing
- Optional seat and shelf – see page 47-48 for details
- Flush-fitting bonded hinges for ease of cleaning
- Adjustable ball catch for life-long reliable operation
- 20 mm adjustment on each wall profile for out-of-true walls
- Height from top of tray 1950 mm
- Minimum tray rim width 60 mm

How to order your Torsion® Hinged Pentagon:

Step 1

Select your pentagon size.

Step 2

Choose a handle style.

Step 3

Select a coordinating tray if required.



IF award



Red Dot award



Innovation



Lifetime guarantee



Coated glass



Power showerer approved



2 man lift

Enclosures

Torsion® Sliding Door 771

Geometric Handle

Door size	Door adjustment min - max width	Door opening aperture	Left hand door code	Right hand door code	RRP Price
1100 mm	1060-1100 mm	410 mm	1.1853.147	1.1853.148	£827.00
1200 mm	1160-1200 mm	460 mm	1.1853.149	1.1853.150	£857.00
1400 mm	1360-1400 mm	560 mm	C1.1853.114G	C1.1853.115G	£1,042.00
1500 mm	1460-1500 mm	560 mm	C1.1853.116G	C1.1853.117G	£1,072.00
1600 mm	1560-1600 mm	660 mm	C1.1853.118G	C1.1853.119G	£1,102.00
1700 mm	1660-1700 mm	660 mm	C1.1853.120G	C1.1853.121G	£1,134.00

Twist Handle

Door size	Door adjustment min - max width	Door opening aperture	Left hand door code	Right hand door code	RRP Price
1100 mm	1060-1100 mm	410 mm	1.1853.110	1.1853.111	£827.00
1200 mm	1160-1200 mm	460 mm	1.1853.112	1.1853.113	£857.00
1400 mm	1360-1400 mm	560 mm	C1.1853.114T	C1.1853.115T	£1,042.00
1500 mm	1460-1500 mm	560 mm	C1.1853.116T	C1.1853.117T	£1,072.00
1600 mm	1560-1600 mm	660 mm	C1.1853.118T	C1.1853.119T	£1,102.00
1700 mm	1660-1700 mm	660 mm	C1.1853.120T	C1.1853.121T	£1,134.00

Technical drawings:

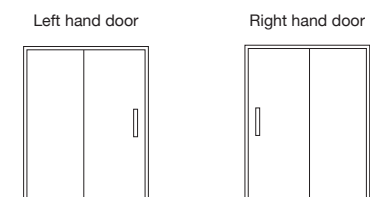

Optional filler section:

- Suitable to use with Torsion® doors, side panels and enclosures
- Extends the width of a Torsion door, side panel or enclosure by 10 mm

To suit	Code	RRP Price
Door	1.1853.140	£41.00
Side panel	1.1853.141	£41.00

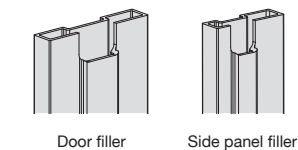

Handle & hinge options:



Geometric handle

Twist handle

Seat & shelf options:



Torsion® Seat

Torsion® Shelf

Features

- Fixed panel denotes handing, please state left or right when ordering
- 8 mm thick safety glass
- Clear glazing
- Optional seat and shelf – see page 47-48 for details
- Hidden mechanisms for ease of cleaning
- 20 mm adjustment on each wall profile for out-of-true walls
- Height from top of tray 1950 mm
- Minimum tray rim width 66 mm
- Please allow 150 mm clearance above the door for any adjustments
- All doors above 1200 mm require assembly, allowing easy transportation

How to order your Torsion® Sliding Door:

Step 1

Select your door size.

Step 2

Choose a handle style.

Step 3

Select a coordinating tray if required.



IF award



Red Dot award



Innovation



Lifetime guarantee



Coated glass



Power shower approved



2 man lift

KOHLER.co.uk



772 Torsion sliding enclosure shown with twist handle
1400 x 800mm shower tray

Torsion® Sliding Enclosure 772

Geometric Handle

Door size	Door adj. min-max width	Door opening aperture	Left hand door code	Right hand door code	RRP Price
1100 mm	1060-1080 mm	410 mm	1.1853.147	1.1853.148	£827.00
1200 mm	1160-1180 mm	460 mm	1.1853.149	1.1853.150	£857.00
1400 mm	1360-1380 mm	560 mm	C1.1853.114G	C1.1853.115G	£1,042.00
1500 mm	1460-1480 mm	560 mm	C1.1853.116G	C1.1853.117G	£1,072.00
1600 mm	1560-1580 mm	660 mm	C1.1853.118G	C1.1853.119G	£1,102.00
1700 mm	1660-1680 mm	660 mm	C1.1853.120G	C1.1853.121G	£1,134.00

Twist Handle

Door size	Door adj. min-max width	Door opening aperture	Left hand door code	Right hand door code	RRP Price
1100 mm	1060-1080 mm	410 mm	1.1853.110	1.1853.111	£827.00
1200 mm	1160-1180 mm	460 mm	1.1853.112	1.1853.113	£857.00
1400 mm	1360-1380 mm	560 mm	C1.1853.114T	C1.1853.115T	£1,042.00
1500 mm	1460-1480 mm	560 mm	C1.1853.116T	C1.1853.117T	£1,072.00
1600 mm	1560-1580 mm	660 mm	C1.1853.118T	C1.1853.119T	£1,102.00
1700 mm	1660-1680 mm	660 mm	C1.1853.120T	C1.1853.121T	£1,134.00

Reversible Panel size	Panel adjustment min-max width	Code	RRP Price
760 mm	720-740 mm	1.1853.101	£459.00
800 mm	760-780 mm	1.1853.102	£459.00
900 mm	860-880 mm	1.1853.103	£485.00
1000 mm	960-980 mm	1.1853.104	£521.00

Technical drawings:

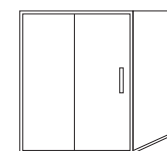

Left hand door
Reversible side panel

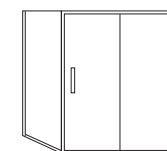

Right hand door
Reversible side panel

Optional filler section:

- Suitable to use with Torsion® doors, side panels and enclosures
- Extends the width of a Torsion door, side panel or enclosure by 10 mm

To suit	Code	RRP Price
Door	1.1853.140	£41.00
Side panel	1.1853.141	£41.00

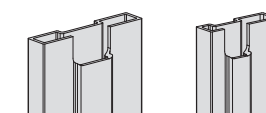

Door filler Side panel filler

Handle & hinge options:



Geometric handle Twist handle

Seat & shelf options:



Torsion® Seat Torsion® Shelf

Features

- Side panels are reversible
- 8 mm thick safety glass
- Clear glazing
- Optional seat and shelf – see page 47-48 for details
- 20mm adjustment on each wall profile for out-of-true walls
- Hidden mechanisms for ease of cleaning
- Height from top of tray 1950 mm
- Minimum tray rim width 66 mm
- Please allow 150 mm clearance above the enclosure for any adjustments
- All doors above 1200 mm require assembly, allowing easy transportation

How to order your Torsion® Sliding Enclosure:

Step 1

Select your door and panel size.

Step 2

Choose a handle style.

Step 3

Select a coordinating tray if required.



IF award



Red Dot award



Innovation



Lifetime guarantee



Coated glass



Power showerer approved



2 man lift



788 Torsion quadrant shown with geometric handle
900 x 900mm shower tray

Enclosures

Torsion® Quadrant 788

Geometric Handle

Door adjustment min - max width	Door opening aperture	Code	RRP Price
900 x 900 mm	465 mm	C1.1853.137G	£980.00
1000 x 1000 mm	465 mm	C1.1853.134G	£1,090.00
1000 x 800 mm	465 mm	C1.1853.138G	£980.00
1200 x 900 mm	465 mm	C1.1853.139G	£1,133.00

Twist Handle

Door adjustment min - max width	Door opening aperture	Code	RRP Price
900 x 900 mm	465 mm	C1.1853.137T	£980.00
1000 x 1000 mm	465 mm	C1.1853.134T	£1,090.00
1000 x 800 mm	465 mm	C1.1853.138T	£980.00
1200 x 900 mm	465 mm	C1.1853.139T	£1,133.00

Technical drawings:

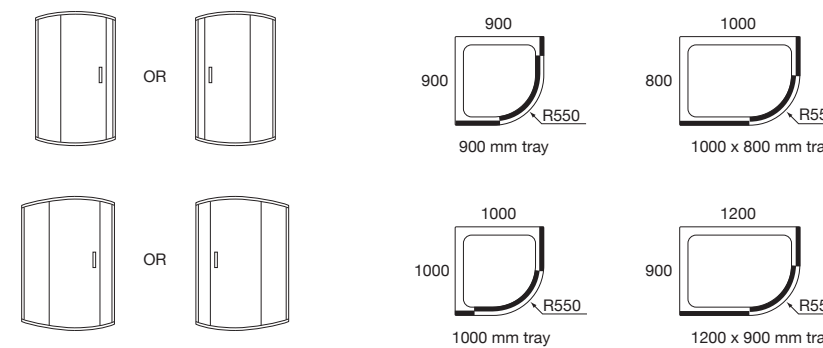

Optional filler section:

- Suitable to use with Torsion® doors, side panels and enclosures
- Extends the width of a Torsion door, side panel or enclosure by 10 mm

To suit	Code	RRP Price
Door	1.1853.140	£41.00
Side panel	1.1853.141	£41.00

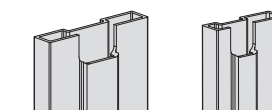

Door filler Side panel filler

Handle & hinge options:



Geometric handle Twist handle

Seat & shelf options:



Torsion® Seat Torsion® Shelf

Features

- Reversible Quadrant
- 8 mm thick safety glass
- Clear glazing
- Optional seat and shelf – see page 47-48 for details
- Quick release mechanism for easy cleaning
- 17 mm adjustment on each wall profile for out of true walls
- Height from top of tray 1950 mm
- Minimum tray width 60 mm
- Please note this product requires a two person delivery and installation

How to order your Torsion® Quadrant:

Step 1

Select your quadrant size.

Step 2

Choose a handle style.

Step 3

Select a coordinating tray if required.



IF award



Red Dot award



Innovation



Lifetime guarantee



Coated glass



Power shower approved



2 man lift

Torsion® Seat



Features

- To suit Torsion doors and enclosures
- Seats are handed by “curved” feature, state left or right when ordering
- High-grade resin blended with natural mineral fillers
- 24 mm thick x 330 mm wide
- 12 mm adjustment
- Maximum weight limit 150Kg
- 10 year Guarantee

Seat options:



Left-hand Seat



Right-hand Seat

Left hand code	Right hand code	Seat size	Seat Adjustment min-max width	Price
2.1795.115	2.1795.116	700 mm	674-686 mm	£536.00
2.1795.117	2.1795.118	760 mm	734-746 mm	£536.00
2.1795.119	2.1795.120	800 mm	774-786 mm	£536.00
2.1795.121	2.1795.122	900 mm	874-886 mm	£561.00
2.1795.123	2.1795.124	1000 mm	974-986 mm	£597.00

Technical drawings:

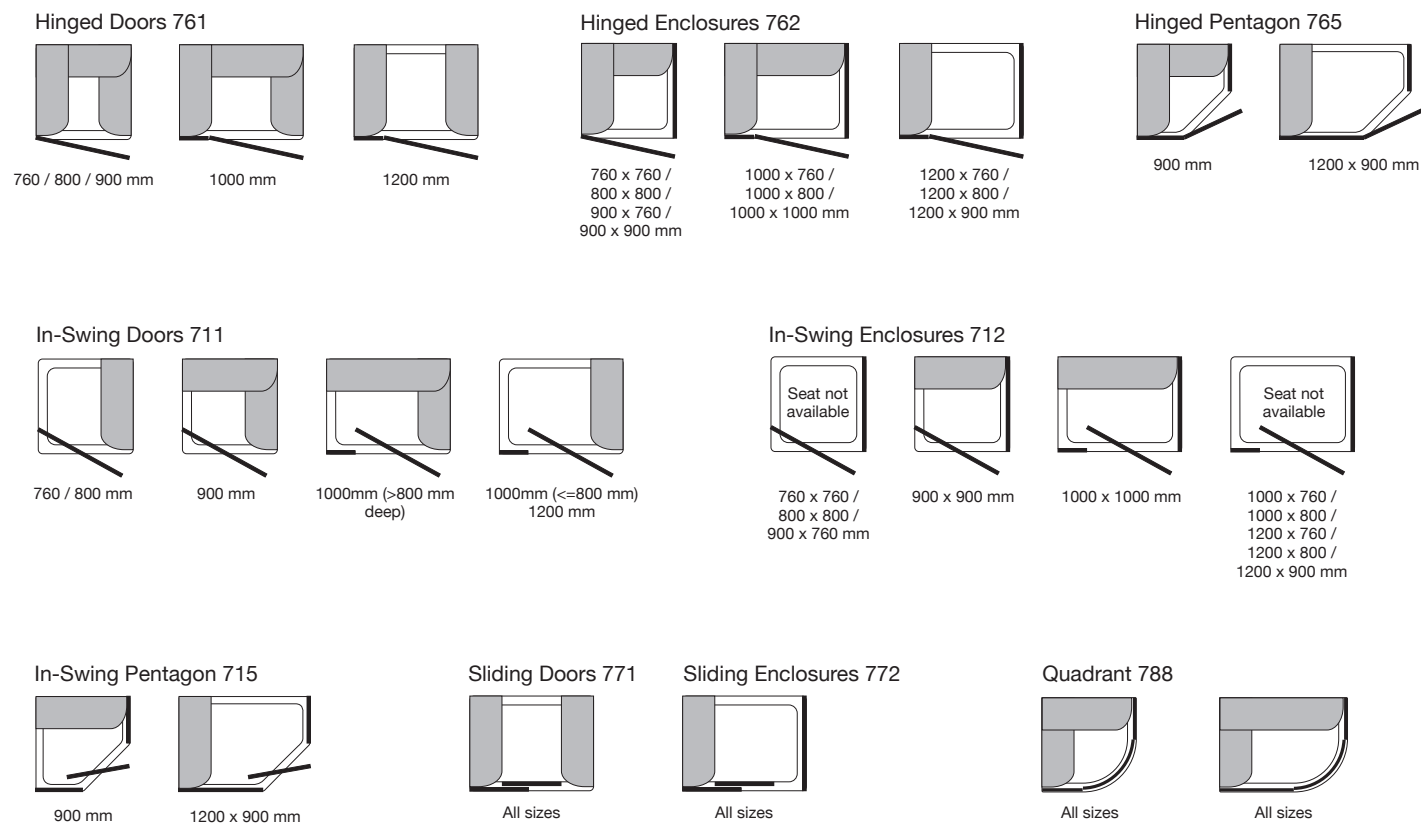

Enclosures

Torsion® Shelf



Features

- To suit Torsion doors and enclosures
- Shelves are handed by “twist” feature, state left or right when ordering
- High-grade resin blended with natural mineral fillers
- 22 mm thick x 90 mm wide
- 20 mm adjustment
- Maximum weight limit 10Kg
- 10 year Guarantee

Shelf options:



Left-hand Shelf



Right-hand Shelf

Left hand code	Right hand code	Shelf size	Shelf Adjustment min-max width	Price
2.1795.105	2.1795.106	700 mm	670-690 mm	£358.00
2.1795.107	2.1795.108	760 mm	730-750 mm	£358.00
2.1795.109	2.1795.110	800 mm	770-790 mm	£358.00
2.1795.111	2.1795.112	900 mm	870-890 mm	£378.00
2.1795.113	2.1795.114	1000 mm	970-990 mm	£403.00

Technical drawings:

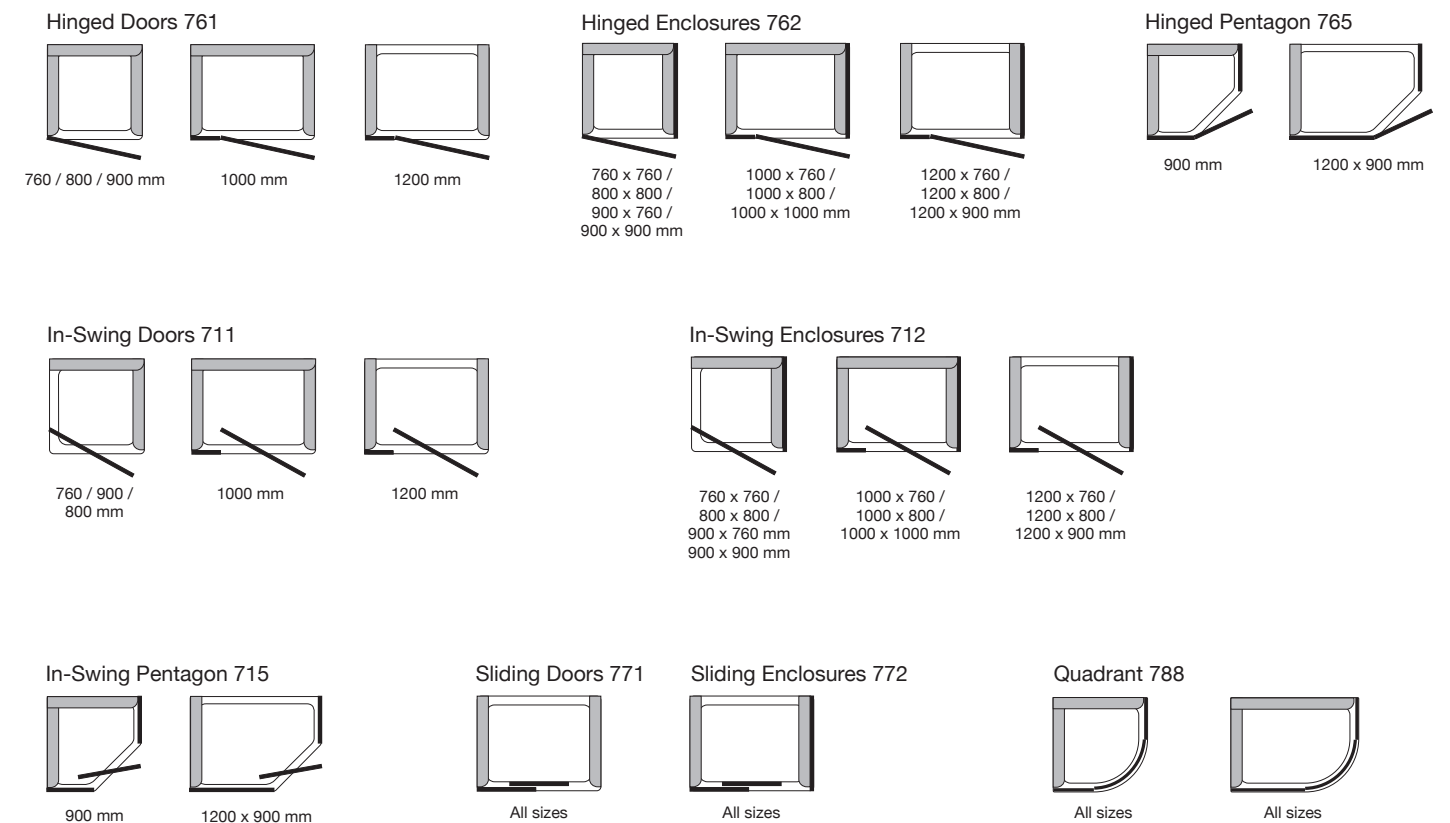

Skyline®

The Skyline collection combines subtlety and simplicity through design engineering excellence. Unique features ensure ease of installation and a robust and low maintenance enclosure.

Product Page

241 Pivot Door	51
242 Pivot Enclosure	53
245 Pivot Pentagon	55
Bi-fold Door	57
Bi-fold Enclosure	59
Bi-fold Pentagon	61
271 Sliding Door	63
272 Sliding Enclosure	65
274 Double Sliding Door	67
278 Double Sliding Enclosure	69
298 Quadrant	71
210 Walk-In	73
688 Hinged Walk-In	75

Features

- 6mm thick safety glass
- Clear glazing
- Reversible for left or right hand opening
- Adjustable ball catch for long-life reliable operation
- Geometric handle mounted vertically

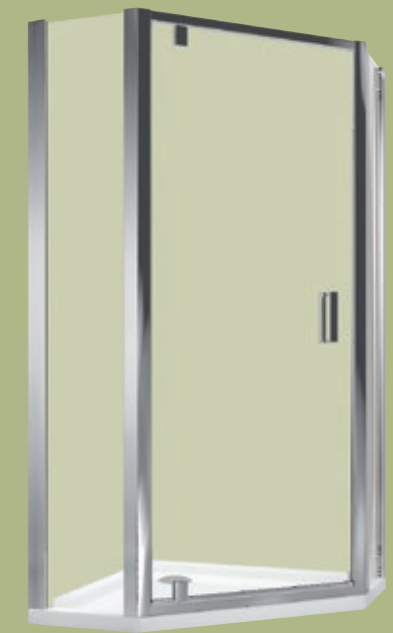

242 Skyline pivot enclosure shown with geometric handle
800 x 800mm shower tray

Enclosures

Skyline® Pivot Door 241

Door size	Door adjustment min - max width	Door opening aperture	Code	RRP Price
760 mm	710-770 mm	492 mm	1.1857.103	£399.00
800 mm	750-810 mm	532 mm	1.1857.104	£399.00
900 mm	850-910 mm	632 mm	1.1857.105	£439.00
1000 mm	950-1010 mm	532 mm	1.1857.106	£499.00
1200 mm	1150-1210 mm	532 mm	1.1857.107	£599.00

Technical drawings:



760 / 800 / 900 mm

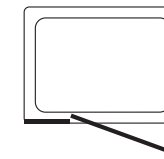

1000 / 1200 mm

Optional filler section:

- Suitable to use with Skyline® doors, side panels and enclosures
- Extends the width of a Skyline door, side panel or enclosure by 18 mm

To suit	Code	RRP Price
Doors and side panels	1.1857.101	£40.00

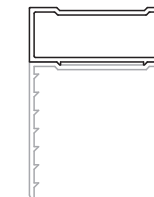

Section 249

Features

- Reversible for left or right hand opening
- 1000 & 1200 mm doors incorporate in-line panel
- 6 mm thick safety glass door and panels
- Clear glazing
- Geometric handle mounted vertically
- Adjustable ball catch for life-long reliable operation
- 3mm adjustment on pivot blocks
- Unique 30 mm adjustment system on each wall channel
- Height from top of tray 1900 mm
- Minimum tray rim width 40 mm

How to order your Skyline® Pivot Door:

Step 1

Select your door size.

Step 2

Select a coordinating tray if required.



Lifetime guarantee



Coated glass



Power shower approved



2 man lift

Enclosures

Skyline® Pivot Enclosure 242

Door size	Door adjustment min - max width	Door opening aperture	Code	RRP Price
760 mm	710-770 mm	492 mm	1.1857.103	£399.00
800 mm	750-810 mm	532 mm	1.1857.104	£399.00
900 mm	850-910 mm	632 mm	1.1857.105	£439.00
1000 mm	950-1010 mm	532 mm	1.1857.106	£499.00
1200 mm	1150-1210 mm	532 mm	1.1857.107	£599.00

Reversible Panel

Panel size	Panel adjustment min - max width	Code	RRP Price
760 mm	725-755 mm	1.1857.135	£219.00
800 mm	765-795 mm	1.1857.136	£239.00
900 mm	865-895 mm	1.1857.137	£269.00

Technical drawings:

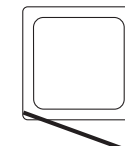

760 / 800 / 900 mm

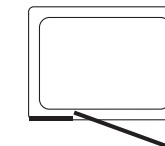

1000 / 1200 mm

Optional filler section:

- Suitable to use with Skyline® doors, side panels and enclosures
- Extends the width of a Skyline door, side panel or enclosure by 18 mm

To suit	Code	RRP Price
Doors and side panels	1.1857.101	£40.00

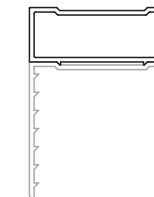

Section 249

Features

- Reversible for left or right hand opening
- 1000 mm & 1200 mm doors incorporate in-line panel
- 6 mm thick safety glass door and panels
- Clear glazing
- Geometric handle mounted vertically
- Adjustable ball catch for life-long reliable operation
- 3mm adjustment on pivot blocks
- Unique 30 mm adjustment system on each wall channel
- Height from top of tray 1900 mm
- Minimum tray rim width 40 mm

How to order your Skyline® Pivot Enclosure:

Step 1

Select your door size.

Step 2

Choose your panel size.

Step 3

Select a coordinating tray if required.



Lifetime guarantee



Coated glass



Power shower approved



2 man lift

KOHLER.co.uk



Skyline® Pivot Pentagon 245

Panel size (mm)	Panel adjustment min-max width	Code	RRP Price
900 x 900	855 x 885 mm	C1.1857.109	£899.00
1200 x 900	1155 x 1185 mm	C1.1857.110	£1,099.00

Technical drawings:

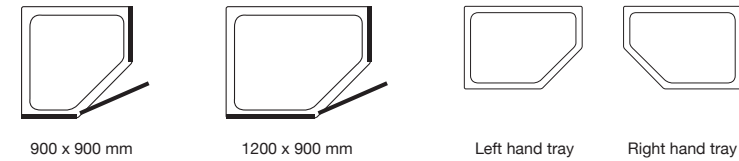

Optional filler section:

- Suitable to use with Skyline® doors, side panels and enclosures
- Extends the width of a Skyline door, side panel or enclosure by 18 mm

To suit	Code	RRP Price
Doors and side panels	1.1857.101	£40.00

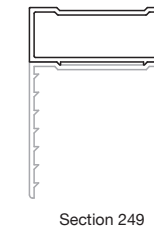

Features

- Reversible for left or right hand opening
- 6 mm thick safety glass door and panels
- Clear glazing
- Geometric handle mounted vertically
- Adjustable ball catch for life-long reliable operation
- 3 mm adjustment on pivot blocks
- Unique 30 mm adjustment system on each wall channel
- Height from top of tray 1900 mm
- Minimum tray rim width 40 mm

How to order your Skyline® Pivot Pentagon:

Step 1

Select your pentagon size.

Step 2

Select a coordinating tray if required.



Lifetime guarantee



Coated glass



Power shower approved



2 man lift

Skyline® Bi-fold Door

Door size	Door adjustment min - max width	Door opening aperture	Code	RRP Price
760 mm	710-770 mm	448 mm	1.1857.138	£462.00
800 mm	750-810 mm	480 mm	1.1857.139	£480.00
900 mm	850-910 mm	591 mm	1.1857.140	£510.00
1000 mm	950-1010 mm	679 mm	1.1857.141	£540.00

Technical drawings:

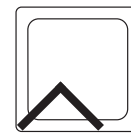

760 / 800 / 900 / 1000 mm

Optional filler section:

- Suitable to use with Skyline® doors, side panels and enclosures
- Extends the width of a Skyline door, side panel or enclosure by 18 mm

To suit	Code	RRP Price
Doors and side panels	1.1857.101	£40.00

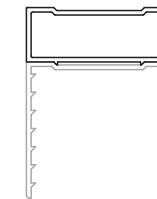

Section 249

Features

- Reversible for left or right hand opening
- 6 mm thick safety glass door and panels
- Clear glazing
- Geometric handle mounted vertically
- Unique 30 mm adjustment system on each wall channel
- Height from top of tray 1900 mm
- Minimum tray rim width 40 mm

How to order your Skyline® Bi-fold Door:

Step 1

Select your door size.

Step 2

Select a coordinating tray if required.



Lifetime guarantee



Coated glass



Power shower approved



2 man lift

Enclosures

Skyline® Bi-fold Enclosure

Door size	Door adjustment min - max width	Door opening aperture	Code	RRP Price
760 mm	729-759 mm	448 mm	1.1857.138	£462.00
800 mm	769-799 mm	480 mm	1.1857.139	£480.00
900 mm	869-899 mm	591 mm	1.1857.140	£510.00
1000 mm	969-999 mm	679 mm	1.1857.141	£540.00

Reversible Panel

Panel size	Panel adjustment min - max width	Code	RRP Price
760 mm	725-755 mm	1.1857.135	£219.00
800 mm	765-795 mm	1.1857.136	£239.00
900 mm	865-895 mm	1.1857.137	£269.00

Technical drawings:



760 / 800 / 900 / 1000 mm

Optional filler section:

- Suitable to use with Skyline® doors, side panels and enclosures
- Extends the width of a Skyline door, side panel or enclosure by 18 mm

To suit	Code	RRP Price
Doors and side panels	1.1857.101	£40.00

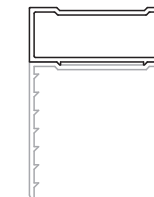

Section 249

Features

- Reversible for left or right hand opening
- 6 mm safety glass
- Clear glazing
- Geometric handle mounted vertically
- Unique 30 mm adjustment on each wall channel
- Height from top of tray 1900 mm
- Minimum tray rim width 40 mm

How to order your Skyline® Bi-fold Enclosure:

Step 1

Select your door size.

Step 2

Choose your panel size.

Step 3

Select a coordinating tray if required.



Lifetime guarantee



Coated glass



Power shower approved



2 man lift



Skyline® Bi-fold Pentagon

Door size (mm)	Door adjustment min - max width	Door opening aperture	Code	RRP Price
900 x 900	710-770 mm	448 mm	C1.1857.109B	£999.00
1200 x 900	710-770 mm	448 mm	C1.1857.110B	£1,199.00

Technical drawings:

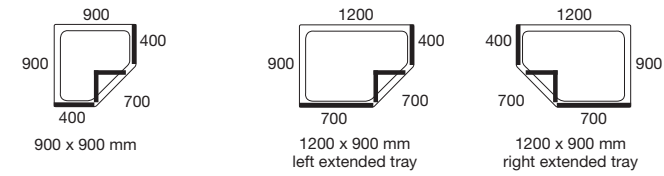

Optional filler section:

- Suitable to use with Skyline® doors, side panels and enclosures
- Extends the width of a Skyline door, side panel or enclosure by 18 mm

To suit	Code	RRP Price
Doors and side panels	1.1857.101	£40.00

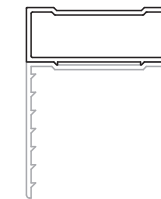

Section 249

Features

- Reversible for left or right hand opening
- 6 mm thick safety glass door and panels
- Clear glazing
- Geometric handle mounted vertically
- Unique 30 mm adjustment system on each wall channel
- Height from top of tray 1900 mm
- Minimum tray rim width 40 mm

How to order your Skyline® Bi-fold Pentagon:

Step 1

Select your pentagon size.

Step 2

Select a coordinating tray if required.



Lifetime guarantee



Coated glass



Power shower approved



2 man lift



271 Skyline sliding door shown with geometric handle
1200 x 800mm shower tray

Skyline® Sliding Door 271

Door size	Door adjustment min - max width	Door opening aperture	Code	RRP Price
1000 mm	950-1010 mm	360 mm	1.1857.111	£499.00
1100 mm	1050-1110 mm	410 mm	1.1857.112	£529.00
1200 mm	1150-1210 mm	460 mm	1.1857.113	£529.00
1400 mm	1350-1410 mm	560 mm	1.1857.114	£599.00

Technical drawings:

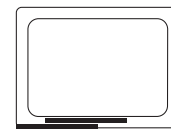

1000 / 1100 / 1200 / 1400 mm

Optional filler section:

- Suitable to use with Skyline® doors, side panels and enclosures
- Extends the width of a Skyline door, side panel or enclosure by 18 mm

To suit	Code	RRP Price
Doors and side panels	1.1857.101	£40.00

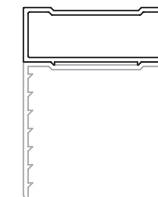

Section 249

Features

- Reversible for left or right hand opening
- 6 mm thick safety glass door and panels
- Clear glazing
- Unique 30 mm adjustment system on each wall channel
- Geometric handle mounted vertically
- Quick-release mechanism on sliders
- Hidden mechanisms and coated glass for ease of cleaning
- Height from top of tray 1900 mm
- Minimum tray rim width 60 mm

How to order your Skyline® Sliding Door:

Step 1

Select your door size.

Step 2

Select a coordinating tray if required.



Lifetime guarantee



Coated glass



Power shower approved



2 man lift

Skyline® Sliding Enclosure 272

Door size	Door adjustment min - max width	Door opening aperture	Code	RRP Price
1000 mm	950-1010 mm	360 mm	1.1857.111	£499.00
1100 mm	1050-1110 mm	410 mm	1.1857.112	£529.00
1200 mm	1150-1210 mm	460 mm	1.1857.113	£529.00
1400 mm	1350-1410 mm	560 mm	1.1857.114	£599.00

Reversible Panel

Panel size	Panel adjustment min - max width	Code	RRP Price
760 mm	725-755 mm	1.1857.135	£219.00
800 mm	765-795 mm	1.1857.136	£239.00
900 mm	865-895 mm	1.1857.137	£269.00

Technical drawings:

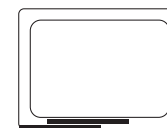

1000 / 1100 / 1200 / 1400 mm

Optional filler section:

- Suitable to use with Skyline® doors, side panels and enclosures
- Extends the width of a Skyline door, side panel or enclosure by 18 mm

To suit	Code	RRP Price
Doors and side panels	1.1857.101	£40.00

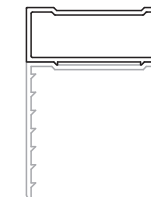

Section 249

Features

- Reversible for left or right hand opening
- 6 mm thick safety glass door and panels
- Clear glazing
- Unique 30 mm adjustment system on each wall channel
- Geometric handle mounted vertically
- Quick-release mechanism on sliders
- Hidden mechanisms for ease of cleaning
- Height from top of tray 1900 mm
- Minimum tray rim width 60 mm

How to order your Skyline® Sliding Enclosure:

Step 1

Select your door size.

Step 2

Choose your panel size.

Step 3

Select a coordinating tray if required.



Lifetime guarantee



Coated glass



Power shower approved



2 man lift



272 Skyline sliding enclosure shown with geometric handle
1200 x 800mm shower tray

Skyline® Double Sliding Door 274

Door size	Door adjustment min - max width	Door opening aperture	Code	RRP Price
1500 mm	1450-1510 mm	516 mm	C1.1857.115	£699.00
1600 mm	1550-1610 mm	516 mm	C1.1857.116	£759.00
1700 mm	1650-1710 mm	516 mm	C1.1857.117	£799.00

Technical drawings:

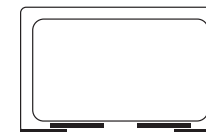

1500 / 1600 / 1700 mm

Optional filler section:

- Suitable to use with Skyline® doors, side panels and enclosures
- Extends the width of a Skyline door, side panel or enclosure by 18 mm

To suit	Code	RRP Price
Doors and side panels	1.1857.101	£40.00

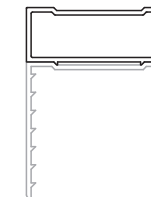

Section 249

Features

- 6 mm thick safety glass door and panels
- Clear glazing
- Unique 30 mm adjustment system on each wall channel
- Geometric handle mounted vertically
- Quick-release mechanism on sliders
- Hidden mechanisms for ease of cleaning
- Height from top of tray 1900 mm
- Minimum tray rim width 60 mm

How to order your Skyline® Double Sliding Door:

Step 1

Select your door size.

Step 2

Select a coordinating tray if required.



Lifetime guarantee



Coated glass



Power shower approved



2 man lift

Skyline® Double Sliding Enclosure 278

Door size	Door adjustment min - max width	Door opening aperture	Code	RRP Price
1500 mm	1450-1510 mm	516 mm	C1.1857.115	£699.00
1600 mm	1550-1610 mm	516 mm	C1.1857.116	£759.00
1700 mm	1650-1710 mm	516 mm	C1.1857.117	£799.00

Reversible Panel

Panel size	Panel adjustment min - max width	Code	RRP Price
760 mm	725-755 mm	1.1857.135	£219.00
800 mm	765-795 mm	1.1857.136	£239.00
900 mm	865-895 mm	1.1857.137	£269.00

Technical drawings:



1500 / 1600 / 1700 mm

Optional filler section:

- Suitable to use with Skyline® doors, side panels and enclosures
- Extends the width of a Skyline door, side panel or enclosure by 18 mm

To suit	Code	RRP Price
Doors and side panels	1.1857.101	£40.00

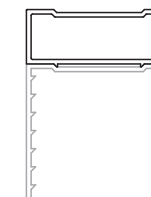

Section 249

Features

- 6 mm thick safety glass door and panels
- Clear glazing
- Unique 30 mm adjustment system on each wall channel
- Geometric handle mounted vertically
- Quick-release mechanism on sliders
- Hidden mechanisms for ease of cleaning
- Height from top of tray 1900 mm
- Minimum tray rim width 60 mm

How to order your Skyline® Double Sliding Enclosure:

Step 1

Select your door size.

Step 2

Choose your panel size.

Step 3

Select a coordinating tray if required.



Lifetime guarantee



Coated glass



Power shower approved



2 man lift

Skyline® Quadrant 298

Door size (mm)	Door adjustment min - max width	Door opening aperture	Code	RRP Price
800 x 800	768-798 mm	400 mm	C1.1857.119	£579.00
900 x 900	868-898 mm	500 mm	C1.1857.120	£579.00
1000 x 800	968-998 mm 768-798 mm	450 mm	C1.1857.121	£649.00
1200 x 800	1168-1198 mm 768-798 mm	450 mm	C1.1857.122	£799.00
1200 x 900	1168-1198 mm 868-898 mm	500 mm	C1.1857.123	£849.00

Technical drawings:

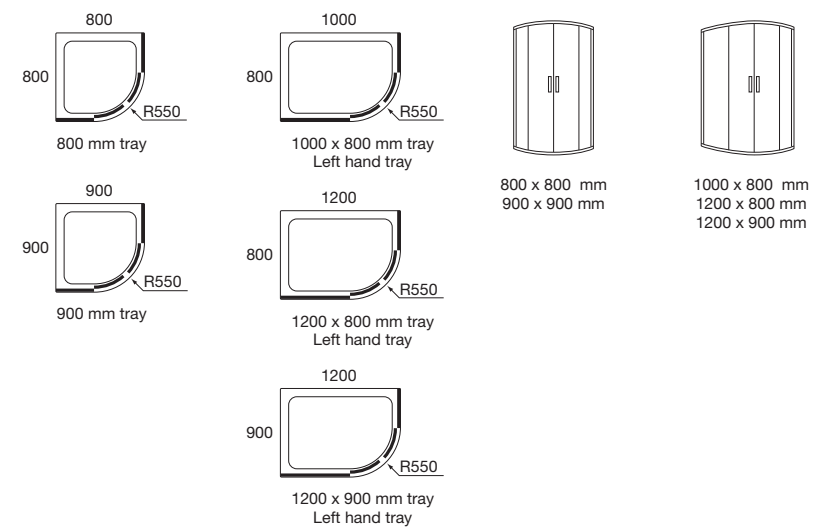

Optional filler section:

- Suitable to use with Skyline® doors, side panels and enclosures
- Extends the width of a Skyline door, side panel or enclosure by 18 mm

To suit	Code	RRP Price
Doors and side panels	1.1857.101	£40.00

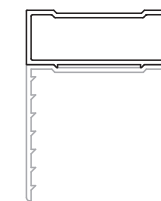

Section 249

Features

- Reversible Quadrant
- 6 mm thick safety glass door and panels
- Clear glazing
- Hidden mechanisms for ease of cleaning
- Quick-release mechanism on sliders
- Geometric handle mounted vertically
- Unique 30 mm adjustment system on each wall channel
- Height from top of tray 1900 mm
- Minimum tray rim width 60 mm

How to order your Skyline® Quadrant:

Step 1

Select your quadrant size.

Step 2

Select a coordinating tray if required.



Lifetime guarantee



Coated glass



Power shower approved



2 man lift

Enclosures

Skyline® Walk-In 210

Walk-in without end panel

Enclosure size	Door opening aperture	Code	RRP Price
1400 mm	540 mm	1.1781.491	£661.00
1700 mm	590 mm	1.1781.492	£751.00

Walk-in with end panel

Enclosure size	Door opening aperture	Code	RRP Price
1400 mm	540 mm	1.1781.494	£961.00
1700 mm	590 mm	1.1781.493	£1,033.00

Tray

To suit enclosure size	Left hand tray code	Right hand tray code	RRP Price
1400 x 800 mm	400993	400994	£371.00
1700 x 700 mm	400995	400996	£467.00

Technical drawings:

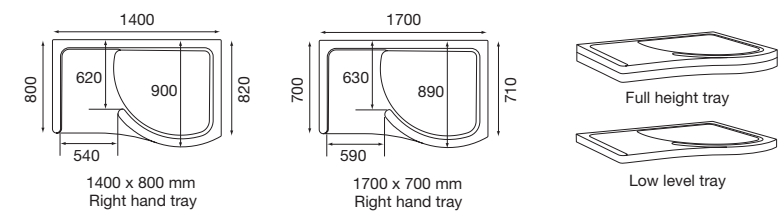

Optional filler section:

- Suitable to use with Skyline® doors, side panels and enclosures
- Extends the width of a Skyline door, side panel or enclosure by 18 mm

To suit	Code	RRP Price
Doors and side panels	1.1857.101	£40.00

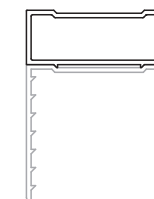

Section 249

Optional Riser Kit

To suit tray size	Code	RRP Price
1400 x 800 mm	400971	£49.00
1700 x 700 mm	400970	£51.00

When choosing a glass divider panel, please be aware that spray/mist may extend beyond the length of the glass panel, the amount will depend upon the power of the shower and its location. We would recommend use of these products with tiled floors.

Features

- The unit is handed by the tray
- End panel – matching towel rail, with choice of installation positions (optional terms)
- Includes integral low level white tray 80 mm high
- 5 mm thick safety glass door and panels
- Clear glazing
- Height from top of the tray 1900 mm

How to order your Skyline® Walk-In:

Step 1

Select your walk-in size, handing, with or without side panel.

Step 2

Select a coordinating tray if required.



Lifetime guarantee



Coated glass



2 man lift

Enclosures

Skyline® Hinged Walk-In 688

Panel size (mm)	Overall length fully extended min - max	Wall channel adjustment	Left hand code	Right hand code	RRP Price
800 mm	1200-1229 mm	29 mm	108374 & 108170	108376 & 108294	£908.00
900 mm	1300-1329 mm	29 mm	108156 & 108170	108165 & 108294	£957.00
1000 mm	1400-1429 mm	29 mm	108157 & 108170	108166 & 108294	£1,029.00
1200 mm	1600-1629 mm	29 mm	108158 & 108170	108167 & 108294	£1,135.00

Technical drawings:

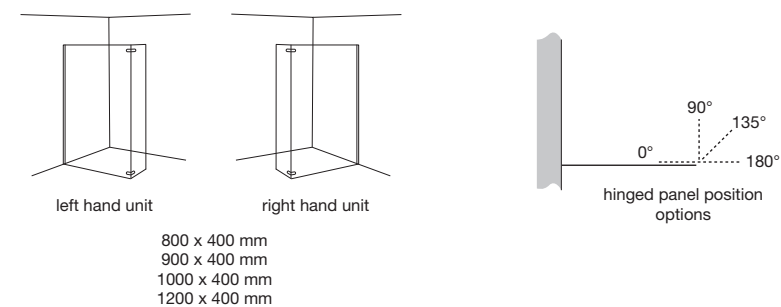

Required Wet-room Floor Anchor Kit

- Wet-room kit contains 1 floor anchor point

	Code	RRP Price
Wet-room floor anchor kit	308069	£29.00

Tray Compatibility Chart

- Please use this chart to check compatibility between Skyline Walk-In and Low Profile Tray sizes

Tray size	Walk-In			
	800	900	1000	1200
1400 x 760 mm	Yes	Yes		
1400 x 900 mm	Yes	Yes		
1500 x 760 mm	Yes	Yes	Yes	
1600 x 700 mm	Yes	Yes	Yes	
1600 x 760 mm	Yes	Yes	Yes	
1700 x 700 mm	Yes	Yes	Yes	Yes
1700 x 760 mm	Yes	Yes	Yes	Yes

When choosing a glass divider panel, please be aware that spray/mist may extend beyond the length of the glass panel, the amount will depend upon the power of the shower and its location. We would recommend use of these products with tiled floors.

Features

- The position of the fixed panel denotes handing, please state left or right when ordering
- 8 mm frameless safety glass panels
- Clear glazing
- 400 mm hinged panel with stops at 0°, 90°, 135° and 180° provides flexible showering
- Choice of shower trays
 - set as a return panel to reduce spray
 - fully extended to increase overall panel length
 - folded back to aid access
- Available with wet-room floor anchor kit
- Supplied with bracing bars, see details opposite
- Height: 1950 mm
- Unique 29 mm adjustment system on wall profile
- Recommended minimum tray rim width is 30 mm
- Please fit on a larger size tray to avoid the hinged panel overhanging

How to order your Skyline® Hinged Walk-In:

Step 1

Select your walk-in size.

Step 2

Choose left or right handing.

Step 3

Select a coordinating tray if required.



Lifetime guarantee



Coated glass



2 man lift

Walk-In & Dividers

KOHLER® walk-in and divider panels deliver both quality and reliability to the most discerning customers, at an affordable price point. These frameless glass panels separate the shower from the rest of the bathroom in a discrete way. This range provides minimalist shower screens with coated safety glass and clear glazing.

Product Pages

327 Minima Glass Divider Panel	79
210 Skyline Walk-In	81
688 Skyline Hinged Walk-In	83

Features

- 6mm thick safety glass
- Clear glazing
- Reversible for left or right hand opening
- Adjustable ball catch for long-life reliable operation
- Geometric handle mounted vertically





327 Minima glass divider panel
1200 x 760mm shower tray

Enclosures

Minima® Glass Divider Panel 327

Panel Size	Panel Adjustment min-max Width	Code	RRP Price
400 mm	354-370 mm	327.040	£303.00
800 mm	754-770 mm	327.080	£479.00
900 mm	854-870 mm	327.090	£519.00
1000 mm	954-970 mm	327.100	£558.00
1200 mm	1154-1170 mm	327.120	£638.00
1400 mm	1340-1356 mm	327.140	£718.00

Technical drawings:

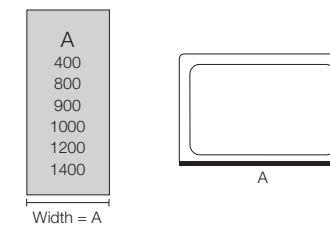

Optional filler section:

- Suitable to use with Minima doors, side panels and enclosures
- Extends the width of a Minima door, side panel or enclosure by 20 mm

To suit	Code	RRP Price
Doors and side panels	551	£72.00

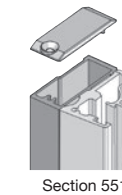

Optional bracing bar:

Bracing bar option	Code	RRP Price
90° bracing bar	400983	£186.00

Minima Made-to-Measure:

Width	RRP Price
250-400 mm	£503.44
401-800 mm	£796.60
801-900 mm	£863.50
901-1000 mm	£929.36
1001-1200 mm	£1062.12
1201-1400 mm	£1404.14
per 100 mm above 1401 mm	£106.22

Additional Made-to-Measure Glass Prices	RRP Price
Per angle cut (requires Measurement Service)	£243.83
Per notch cut (requires Measurement Service)	£300.00

Measurement and Installation Options	RRP Price
Measurement Only Service	£145.20
Measurement and Installation Service	£462.00

When choosing a glass divider panel, please be aware that spray/mist may extend beyond the length of the glass panel, the amount will depend upon the power of the shower and its location. We would recommend use of these products with tiled floors.

Features

- Reversible for left or right hand fitting
- 45° bracing bar supplied with 800, 900 and 1000 mm panels
- 90° bracing bar supplied with 1200 and 1400 mm panels
- Height from top of tray to top of glass 1952 mm
- Overall unit height including 45° bracing bar 1972 mm
- Overall unit height including 90° bracing bar 1992 mm
- 10 mm thick safety glass
- Nominal sizes are designed to fit onto standard sizes of shower tray. Actual dimensions may differ

Made-to-measure options:

- Surface wall profile
- Recessed wall profile
- Surface floor profile
- Recessed floor profile
- Towel rail
- Ceiling fixings

How to order your Minima® Glass Divider Panel:

Step 1

Select your divider panel size.

Step 2

Select a coordinating tray if required.



Made-to-measure



2 man lift



Power shower approved



Lifetime guarantee



Coated glass

Enclosures

Skyline® Walk-In 210

Walk-in without end panel

Enclosure size	Door opening aperture	Code	RRP Price
1400 mm	540 mm	1.1781.491	£661.00
1700 mm	590 mm	1.1781.492	£751.00

Walk-in with end panel

Enclosure size	Door opening aperture	Code	RRP Price
1400 mm	540 mm	1.1781.494	£961.00
1700 mm	590 mm	1.1781.493	£1,033.00

Tray

To suit enclosure size	Left hand tray code	Right hand tray code	RRP Price
1400 x 800 mm	400993	400994	£371.00
1700 x 700 mm	400995	400996	£467.00

Technical drawings:

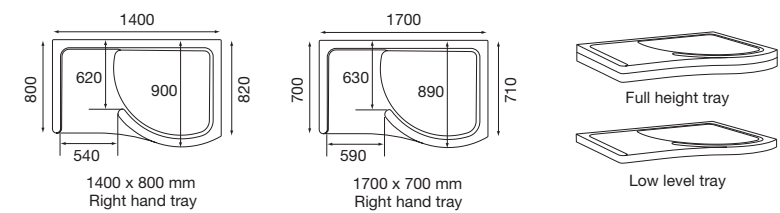

Optional filler section:

- Suitable to use with Skyline® doors, side panels and enclosures
- Extends the width of a Skyline door, side panel or enclosure by 18 mm

To suit	Code	RRP Price
Doors and side panels	1.1857.101	£40.00

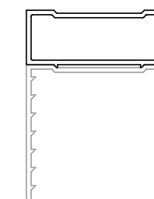

Section 249

Optional Riser Kit

To suit tray size	Code	RRP Price
1400 x 800 mm	400971	£49.00
1700 x 700 mm	400970	£51.00

When choosing a glass divider panel, please be aware that spray/mist may extend beyond the length of the glass panel, the amount will depend upon the power of the shower and its location. We would recommend use of these products with tiled floors.

Features

- The unit is handed by the tray
- End panel – matching towel rail, with choice of installation positions (optional terms)
- Includes integral low level white tray 80 mm high
- 5 mm thick safety glass door and panels
- Clear glazing
- Height from top of the tray 1900 mm

How to order your Skyline® Walk-In:

Step 1

Select your walk-in size, handing, with or without side panel.

Step 2

Select a coordinating tray if required.



Lifetime guarantee



Coated glass



2 man lift

Enclosures

Skyline® Hinged Walk-In 688

Panel size (mm)	Overall length fully extended min - max	Wall channel adjustment	Left hand code	Right hand code	RRP Price
800 mm	1200-1229 mm	29 mm	108374 & 108170	108376 & 108294	£908.00
900 mm	1300-1329 mm	29 mm	108156 & 108170	108165 & 108294	£957.00
1000 mm	1400-1429 mm	29 mm	108157 & 108170	108166 & 108294	£1,029.00
1200 mm	1600-1629 mm	29 mm	108158 & 108170	108167 & 108294	£1,135.00

Technical drawings:

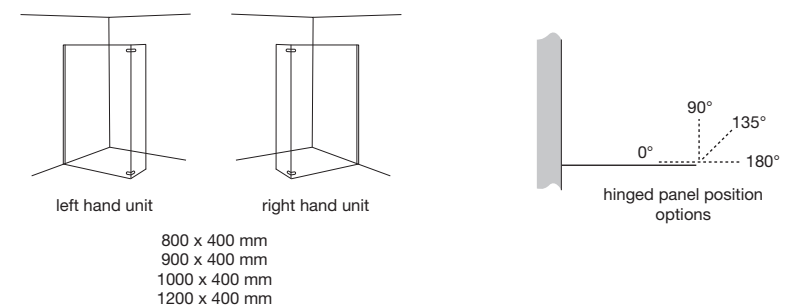

Required Wet-room Floor Anchor Kit

- Wet-room kit contains 1 floor anchor point

	Code	RRP Price
Wet-room floor anchor kit	308069	£29.00

Tray Compatibility Chart

- Please use this chart to check compatibility between Skyline Walk-In and Low Profile Tray sizes

Tray size	Walk-In			
	800	900	1000	1200
1400 x 760 mm	Yes	Yes		
1400 x 900 mm	Yes	Yes		
1500 x 760 mm	Yes	Yes	Yes	
1600 x 700 mm	Yes	Yes	Yes	
1600 x 760 mm	Yes	Yes	Yes	
1700 x 700 mm	Yes	Yes	Yes	Yes
1700 x 760 mm	Yes	Yes	Yes	Yes

When choosing a glass divider panel, please be aware that spray/mist may extend beyond the length of the glass panel, the amount will depend upon the power of the shower and its location. We would recommend use of these products with tiled floors.

Features

- The position of the fixed panel denotes handing, please state left or right when ordering
- 8 mm frameless safety glass panels
- Clear glazing
- 400 mm hinged panel with stops at 0°, 90°, 135° and 180° provides flexible showering
- Choice of shower trays
 - set as a return panel to reduce spray
 - fully extended to increase overall panel length
 - folded back to aid access
- Available with wet-room floor anchor kit
- Supplied with bracing bars, see details opposite
- Height: 1950 mm
- Unique 29 mm adjustment system on wall profile
- Recommended minimum tray rim width is 30 mm
- Please fit on a larger size tray to avoid the hinged panel overhanging

How to order your Skyline® Hinged Walk-In:

Step 1

Select your walk-in size.

Step 2

Choose left or right handing.

Step 3

Select a coordinating tray if required.



Lifetime guarantee



Coated glass



2 man lift

Bath Screens

Bath screens; good things come in small packages. When size precludes a separate shower enclosure, bath screens lend big impact to the smallest bathroom. Single panel or discreet folding bath screens mean you are sure to find a look that meets your needs.

Product Pages

Minima Hinged Twin Panel Bath Screens	87
Single Panel Bath Screens	88
Reversible Twin Panel Bath Screens	88



Single panel bath screen round

Features

- 5-10mm glass
- Single or twin panel
- Fixed panels for improved water retention
- Swings in or out for every bath screen
- Round, Sail or Square available



Minima® Hinged Twin Panel Bath Screen 352

	Colour / Finish	Material	Kg	Code	RRP Price
Minima Hinged Twin Panel bath screen 352 – W1000 mm <ul style="list-style-type: none"> • Reversible for left or right hand opening • Adjustment for out-of-true walls • Panel A is fixed with panel B hinged • 10 mm Safety glass • Outward swing 	Clear Glass	Polished Chrome	43	352.010	£714.00

Technical drawings:



Single Panel Bath Screen

	Colour / Finish	Material	Kg	Code	RRP Price
Single panel Bath Screen W800 x H1450 mm <ul style="list-style-type: none"> • 5 mm Safety glass • Adjustment for out-of-true walls 	Clear Glass	Polished Chrome	25		
Single Panel Reversible Square				1.1863.005	£265.00
Single Panel Reversible Round				1.1863.007	£265.00
Single Panel Reversible Sail				1.1863.009	£265.00

Technical drawings:

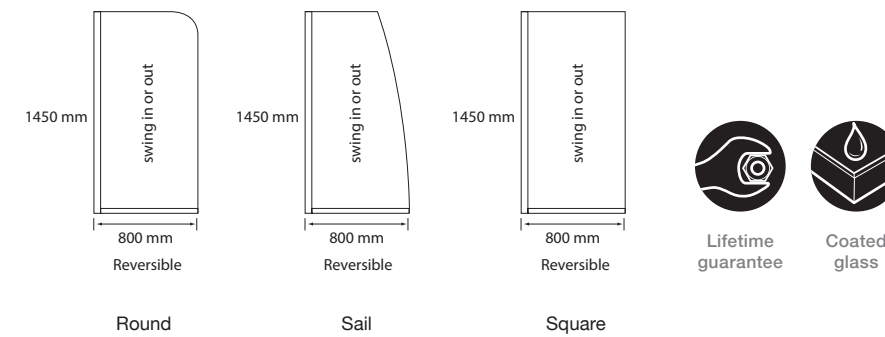

Minima® Hinged Twin Panel bath screen 352 – Made-to-Measure

	Colour / Finish	Material	Kg	RRP Price
Minima Hinged Twin Panel bath screen 352 - Made-to-Measure Up to 1000 mm Per 100 mm after 1000 mm <ul style="list-style-type: none"> • Max panel width 2 m 	Clear Glass			£892.50 £102.13
Additional Made-to-Measure Glass Prices: Per angle cut (requires Measurement Service) Per notch cut (requires Measurement Service)				£243.83 £300.00
Measurement and Installation Options Measurement Service Installation Service				£145.20 £508.20

Technical drawings:

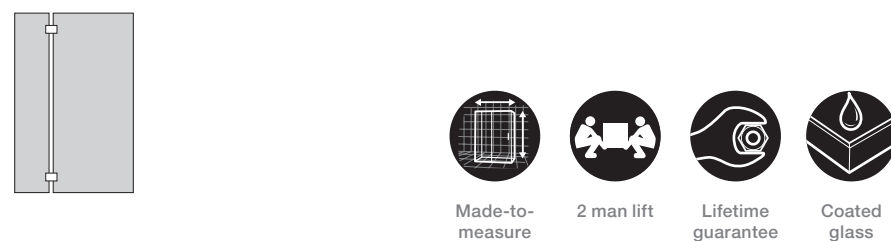

Reversible Twin Panel Bath Screen

	Colour / Finish	Material	Kg	Code	RRP Price
Reversible Twin Panel Sail W970 x H1670 mm	Clear Glass	Polished Chrome	24	2.1863.001	£538.00
Reversible Twin Panel Square W970 x H1670 mm			24	1.1863.002	£538.00
Reversible Twin Panel Square W870 x H1670 mm			22	2.1863.046	£538.00
Reversible Twin Panel Sail W870 x H1670 mm			22	2.1863.047	£538.00

Technical drawings:

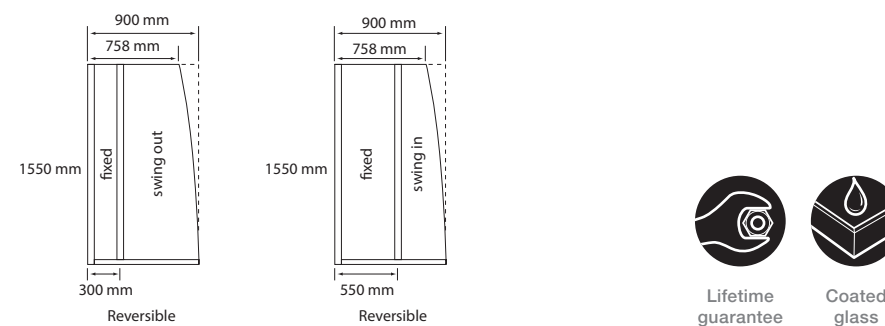



Shower Trays

Less is more for our range of low profile shower trays. Thin yet incredibly strong, their slender lines almost vanish into the floor, complementing modern shower enclosures perfectly to complete the minimalist ideal. What's more, ingenious design and advanced materials help keep cleaning minimal too.

Product Pages

Standard Shower Trays	91
Anti-Slip Shower Trays	93
Low Level Plus Trays	95

Features

- Choice of Low Profile, Anti-Slip and Walk-In trays
- Walk-In trays are suitable for use with walk-in enclosures
- BioCote® incorporated to reduce bacteria growth by up to 99.9%
- High flow, vortex waste with self-cleaning action
- Tray colour white
- Life time guarantee
- Anti-Slip is available on all trays except Low Level Plus trays



Shower Trays – How to Shop

Less is more for our range of low profile shower trays. Thin yet incredibly strong, their slender lines almost vanish into the floor, complementing modern shower enclosures perfectly to complete the minimalist ideal. What's more, ingenious design and advanced materials help keep cleaning minimal too.

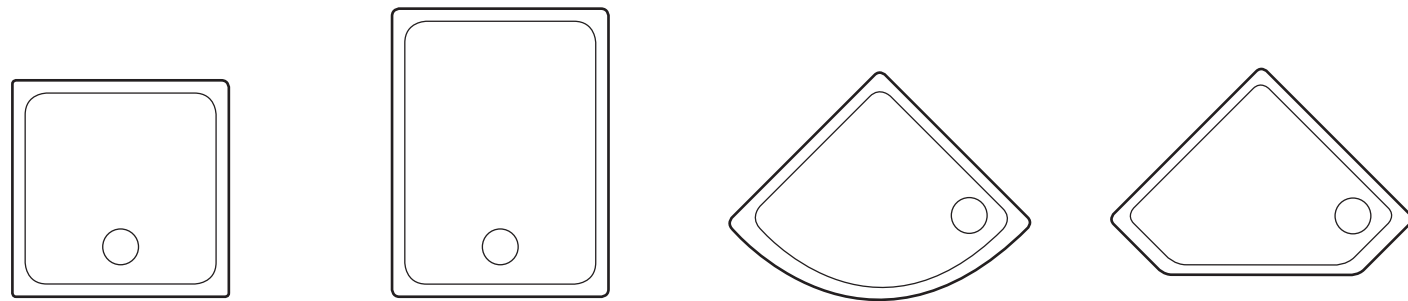

Low Profile Tray

Choose from a range of Low Profile shower trays to create your minimalist shower enclosure. The 40mm height makes it one of the slimmest shower trays available, giving a sleek almost invisible “wet-room” look. The sleek styling flows through to the waste, which is integrated into the design to give a level surface for you to stand on.

- Low profile tray with 'walk-on' waste
- Patented laminated construction gives incredible strength whilst reducing weight
- BioCote® incorporated to reduce bacterial/mould growth by up to 99.9%
- High flow, vortex waste with self-cleaning action
- All trays available with riser kit for easy installation on concrete floors
- Tray colour white
- Lifetime guarantee





Technical Details

Height: 40 mm
 Rim width: 66 mm
 Height on riser: 140 mm
 Front surface: Durable Acrylic capped ABS incorporating BioCote®
 Filler: Resin-stone concrete for stiffness
 Rear skin: ABS
 Max flow rate: 30l/m



Clean and fresh forever with innovative BioCote® technology, every low profile tray stays protected for its whole lifetime, thanks to the antibacterial technology BioCote®, which is incorporated into the manufacturing process. This innovative antibacterial technology will keep your new shower tray cleaner than ever before by reducing bacteria and mould growth by up to 99.9%.

Standard Shower Trays

Tray Shape	Code	Size	RRP Price	Riser Kit	RRP Price
	400931	800 x 800 x 40 mm (radius 550 mm)	£169.00	400966	£80.00
	400883	900 x 900 x 40 mm (radius 550 mm)	£182.00	400966	£80.00
	400941	1000 x 800 x 40 mm left hand (radius 550 mm)	£237.00	400963	£121.00
	400942	1000 x 800 x 40 mm right hand (radius 550 mm)	£237.00	400963	£121.00
	401012	1000 x 1000 x 40 mm (radius 550 mm)	£225.00	401022	£96.00
	400943	1200 x 900 x 40 mm left hand (radius 550 mm)	£269.00	400963	£121.00
	400944	1200 x 900 x 40 mm right hand (radius 550 mm)	£269.00	400963	£121.00
	400932	900 x 900 x 40 mm	£182.00	400965	£121.00
	400951	1200 x 900 x 40 mm left hand	£270.00	400962	£121.00
	400952	1200 x 900 x 40 mm right hand	£270.00	400962	£121.00
	400921	760 x 760 x 40 mm	£104.00	401001	£96.00
	400881	800 x 800 x 40 mm	£116.00	401001	£96.00
	400882	900 x 900 x 40 mm	£180.00	401001	£96.00
	400953	1000 x 1000 x 40 mm	£250.00	401001	£96.00
	400922	900 x 760 x 40 mm	£182.00	400960	£70.00
	1.1824.001.WH	1000 x 700 x 40 mm	£193.00	400960	£70.00
	400884	1000 x 760 x 40 mm	£189.00	400960	£70.00
	400885	1000 x 800 x 40 mm	£200.00	400960	£70.00
	400886	1100 x 800 x 40 mm	£223.00	400961	£73.00
	1.1824.002.WH	1200 x 700 x 40 mm	£241.00	400961	£73.00
	400887	1200 x 760 x 40 mm	£202.00	400961	£73.00
	400888	1200 x 800 x 40 mm	£217.00	400961	£73.00
	400923	1200 x 900 x 40 mm	£225.00	400961	£73.00
	1.1824.003.WH	1400 x 700 x 40 mm	£282.00	400964	£102.00
	400889	1400 x 760 x 40 mm	£253.00	400964	£102.00
	400924	1400 x 800 x 40 mm	£304.00	400964	£102.00
	401013	1400 x 900 x 40 mm	£318.00	401021	£102.00
	1.1824.004.WH	1500 x 700 x 40 mm	£323.00	400964	£102.00
	400890	1500 x 760 x 40 mm	£325.00	400964	£102.00
	400925	1600 x 700 x 40 mm	£376.00	400964	£102.00
	400891	1600 x 760 x 40 mm	£386.00	400964	£102.00
	401014	1600 x 900 x 40 mm	£419.00	401021	£102.00
	400926	1700 x 700 x 40 mm	£392.00	400964	£102.00
	400892	1700 x 760 x 40 mm	£408.00	400964	£102.00
401015	1700 x 900 x 40 mm	£440.00	401021	£102.00	

Riser Kits

A riser kit allows you to convert a low level tray to a riser tray providing the flexibility of installation on a solid floor. Each kit contains easy to install removable panels, simple clip-on fixings and robust adjustable push-fit riser legs.

Riser kit legs provide adjustability to make flat, the height of the tray has to be 100 mm from the floor surface to the underside of the tray. The new panel sits under the tray.

Numbers on each leg indicate level setting and once height is set, locking nuts ensure no movement.

Note: the Front Wrap style riser is still available if required

anti-slip

Shower Trays



The KOHLER® anti-slip tray is an anti-slip tray like no other. This tray exceeds the most stringent independently tested anti-slip test, passing at the – Class C.

- Anti-slip coating is applied to the whole tray surface
- Low-profile 40 mm shower tray
- The coating is bonded to the tray for a long lasting finish
- Tray colour white
- Patented laminated construction gives incredible strength whilst reducing weight
- BioCote®, integrated into the anti-slip surface which reduces bacteria and mould growth by up to 99.9%
- Easy to clean
- All trays available with riser kit for easy installation on solid floor installations
- High Flow Vortex Waste with self cleaning action
- Anti-slip is available on all trays
- Lifetime domestic guarantee



vortex
Powerful self cleaning Vortex waste



anti-slip
Ultimate safety with anti-slip coating

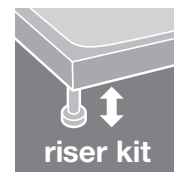

riser kit
Optional riser kits with easy 'push-fit' legs



anti-bacteria
Reduces bacteria and mould by up to 99.9%

Best in Class

What does Class C mean?

Kohler Anti-slip tray has achieved Class C for DIN 51097 – a barefoot ramp test. In testing the tray is fixed to the ramp and made wet and soapy. The tray is then inclined until the test subject slips.

The grip is given a classification depending on the angle of inclination of the slip. Class C is the highest classification. A tray must be inclined to a minimum of a 24° with the test subject still standing.

On Kohler Anti-slip trays, test subjects were still standing at an incline of over 30°.

DIN 51097 Ramp test for barefoot		Ramp angle
	Class A	12°
	Class B	18°
	Class C	24°
	Kohler Anti-slip tray	30°

Anti-slip Shower Trays

Tray Shape	Code	Size	RRP Price	Riser Kit	RRP Price
	1.1824.032.AS	800 x 800 x 40 mm (radius 550 mm)	£236.00	400966	£80.00
	1.1824.033.AS	900 x 900 x 40 mm (radius 550 mm)	£254.00	400966	£80.00
	1.1824.035.AS	1000 x 800 x 40 mm left hand (radius 550 mm)	£331.00	400963	£121.00
	1.1824.036.AS	1000 x 800 x 40 mm right hand (radius 550 mm)	£331.00	400963	£121.00
	1.1824.034.AS	1000 x 1000 x 40 mm (radius 550 mm)	£315.00	401022	£96.00
	1.1824.037.AS	1200 x 900 x 40 mm left hand (radius 550 mm)	£377.00	400963	£121.00
	1.1824.038.AS	1200 x 900 x 40 mm right hand (radius 550 mm)	£377.00	400963	£121.00
	1.1824.039.AS	900 x 900 x 40 mm	£254.00	400965	£121.00
	1.1824.040.AS	1200 x 900 x 40 mm left hand	£378.00	400962	£121.00
	1.1824.041.AS	1200 x 900 x 40 mm right hand	£378.00	400962	£121.00
	1.1824.011.AS	760 x 760 x 40 mm	£145.00	401001	£96.00
	1.1824.012.AS	800 x 800 x 40 mm	£163.00	401001	£96.00
	1.1824.014.AS	900 x 900 x 40 mm	£250.00	401001	£96.00
	1.1824.017.AS	1000 x 1000 x 40 mm	£351.00	401001	£96.00
	1.1824.013.AS	900 x 760 x 40 mm	£254.00	400960	£70.00
	1.1824.001.AS	1000 x 700 x 40 mm	£270.00	400960	£70.00
	1.1824.015.AS	1000 x 760 x 40 mm	£266.00	400960	£70.00
	1.1824.016.AS	1000 x 800 x 40 mm	£280.00	400960	£70.00
	1.1824.018.AS	1100 x 800 x 40 mm	£311.00	400961	£73.00
	1.1824.002.AS	1200 x 700 x 40 mm	£336.00	400961	£73.00
	1.1824.019.AS	1200 x 760 x 40 mm	£284.00	400961	£73.00
	1.1824.020.AS	1200 x 800 x 40 mm	£302.00	400961	£73.00
	1.1824.021.AS	1200 x 900 x 40 mm	£315.00	400961	£73.00
	1.1824.003.AS	1400 x 700 x 40 mm	£395.00	400964	£102.00
	1.1824.022.AS	1400 x 760 x 40 mm	£353.00	400964	£102.00
	1.1824.023.AS	1400 x 800 x 40 mm	£426.00	400964	£102.00
	1.1824.024.AS	1400 x 900 x 40 mm	£445.00	401021	£102.00
	1.1824.004.AS	1500 x 700 x 40 mm	£451.00	400964	£102.00
	1.1824.025.AS	1500 x 760 x 40 mm	£455.00	400964	£102.00
	1.1824.026.AS	1600 x 700 x 40 mm	£525.00	400964	£102.00
	1.1824.027.AS	1600 x 760 x 40 mm	£541.00	400964	£102.00
	1.1824.028.AS	1600 x 900 x 40 mm	£585.00	401021	£102.00
	1.1824.029.AS	1700 x 700 x 40 mm	£549.00	400964	£102.00
	1.1824.030.AS	1700 x 760 x 40mm	£572.00	400964	£102.00
1.1824.031.AS	1700 x 900 x 40 mm	£617.00	401021	£102.00	



Low Level Plus Trays

A new range of shower trays offering three types of installation to suit your needs, including a streamlined, discreet wet-room solution.

- Low-profile 40 mm shower tray
- Can be surface mounted with or without riser kit, as well as flush-mounted, giving a Walk-in 'wet-room' solution for ease of accessibility
- Extra large sizes available to replace a bath installation
- Tray colour white
- Four colour options for waste covering, White, Grey Anthracite, Silver & Taupe
- Patented robust material gives incredible strength whilst reducing weight
- BioCote®, reduces bacteria and mould growth by up to 99.9%
- Quick and easy installation with new riser kit
- New low profile hidden waste
- Lifetime guarantee

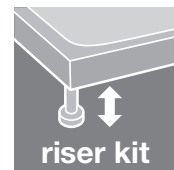

riser kit

Optional riser kits with easy 'push-fit' legs



anti-bacteria

Reduces bacteria and mould by up to 99.9%



Waste Cover Features

- Dedicated extra slim waste
- Available in 3 sizes, 700, 800 & 900 mm
- Available in 4 finishes, White, Grey Anthracite, Silver & Taupe
- Removable waste cover for ease of cleaning
- Integrated hair trap

Riser Kit Features

- Unique riser frame with integrated spirit levels improves installation time
- Adjustable bar allows leveling of the frame prior to tray installation

Low Level Plus Trays

Tray Shape	Code	Size	RRP Price	Riser Kit	RRP Price
Square	1.1764.494.WH	800 x 800 x 40 mm	£173.00	1.1764.563.WH	£130.00
	1.1764.502.WH	900 x 900 x 40 mm	£226.00	1.1764.563.WH	£130.00
Rectangle	1.1764.492.WH	1000 x 700 x 40 mm	£349.00	1.1764.563.WH	£130.00
	1.1764.495.WH	1000 x 800 x 40 mm	£346.00	1.1764.563.WH	£130.00
	1.1764.493.WH	1200 x 700 x 40 mm	£396.00	1.1764.563.WH	£130.00
	1.1764.496.WH	1200 x 800 x 40 mm	£404.00	1.1764.563.WH	£130.00
	1.1764.503.WH	1200 x 900 x 40 mm	£270.00	1.1764.563.WH	£130.00
	1.1764.497.WH	1400 x 800 x 40 mm	£448.00	1.1764.564.WH	£145.00
	1.1764.504.WH	1400 x 900 x 40 mm	£451.00	1.1764.564.WH	£145.00
	1.1764.498.WH	1500 x 800 x 40 mm	£460.00	1.1764.564.WH	£145.00
	1.1764.499.WH	1600 x 800 x 40 mm	£472.00	1.1764.564.WH	£145.00
	1.1764.505.WH	1600 x 900 x 40 mm	£550.00	1.1764.564.WH	£145.00
	1.1764.500.WH	1700 x 800 x 40 mm	£484.00	1.1764.564.WH	£145.00
	1.1764.501.WH	1800 x 800 x 40 mm	£496.00	1.1764.564.WH	£145.00
White waste cover	E62C70-00	700 mm	£50.00		
	E62C80-00	800 mm	£60.00		
	E62C90-00	900 mm	£70.00		
Silver waste cover	E62C70-S21	700 mm	£50.00		
	E62C80-S21	800 mm	£60.00		
	E62C90-S21	900 mm	£70.00		
Grey anthracite waste cover	E62C70-M53	700 mm	£50.00		
	E62C80-M53	800 mm	£60.00		
	E62C90-M53	900 mm	£70.00		
Taupe waste cover	E62C70-M65	700 mm	£50.00		
	E62C70-M65	800 mm	£60.00		
	E62C70-M65	900 mm	£70.00		

Life without labour is guilt. Labour without art is brutality. - John Ruskin



and closets that carry the Kohler mark are well designed and will stand, in the best sense of the word, for the life of the house. Kohler culture are pure, uniform, harmonious. If you prefer white, Kohler white is as immaculate as freshly laundered linen. Kohler faucets and handles and

Kohler Vortex sink with chrome fittings, equipped with Porcelainizer.

Kohler Wallace cast-iron mixing faucet with third side supply.

KOHLER OF KOHLER



WHEN A FELLER NEEDS AN ARCHITECT

When a feller needs an architect, he needs a man who can see the beauty of a building in a way that no other man can. He needs a man who can see the beauty of a building in a way that no other man can. He needs a man who can see the beauty of a building in a way that no other man can.

ELEVEN IMPORTANT POINTS

1. Kohler design is distinctive, purposeful, practical.
2. Kohler design is decorative, purposeful, practical.
3. Kohler design is decorative, purposeful, practical.
4. Kohler design is decorative, purposeful, practical.
5. Kohler design is decorative, purposeful, practical.
6. Kohler design is decorative, purposeful, practical.
7. Kohler design is decorative, purposeful, practical.
8. Kohler design is decorative, purposeful, practical.
9. Kohler design is decorative, purposeful, practical.
10. Kohler design is decorative, purposeful, practical.
11. Kohler design is decorative, purposeful, practical.



What John Michael Kohler saw in 1883 when he looked at a cast-iron horse trough was the bathtub that launched a global plumbing company. That pioneering spirit of ingenuity – the kind that sees a bathing revolution in a horse trough – has defined Kohler Co. from its earliest days. A visionary, John Michael Kohler understood the importance of innovative design and an uncompromising commitment to craft and quality. After four generations, we remain a family-owned company, with over 26,000 products and 13,000 patents to our name. Still leading the industry in innovation and design. Bolder than ever.

A KOHLER Experience®



Join us for an unforgettable stay at the Old Course Hotel in St Andrews, Scotland, or The American Club® in Kohler, Wisconsin, where you'll enjoy classically elegant settings, sumptuous cuisine, exclusive spa and golf experiences, luxurious amenities and quietly confident service. Plan your experience at KOHLERexperience.com.

Thank you.

If you'd like to learn more about KOHLER® and our complete product offering, we invite you to take a look at our website or stop by a displaying Kohler Showroom.

Showrooms

To experience Kohler bathroom products firsthand, visit KOHLER.co.uk to find a displaying showroom near you.

Peace-of-mind guarantee

At Kohler, we are confident in the quality and reliability of our products and guarantee them against faulty materials or workmanship, provided they have been installed, cared for and used in accordance with our instructions.

- 25 years Ceramic and enameled cast iron products
- 10 years Acrylic baths, metal Vessels and Shower Trays
- 5 years Shower valves, taps, bath panels, cistern fittings and seats
- 2 years Bathroom furniture and accessories
- 1 year Whirlpool and spa systems

Kohler Enclosures and Bath Screens hold a Lifetime guarantee*

The Kohler Lifetime and 5 year guarantees are valid in the United Kingdom and Republic of Ireland and are available to the original purchaser upon registration of the product. For further information please visit www.kohler.co.uk or call us for a copy of the terms and conditions and to register your guarantee.

*Certain exclusions and conditions apply

Contacting us

For Kohler Customer Service or technical enquiries, please call us on +44 (0) 844 571 0048. E-mail info@kohler.co.uk or visit our Website KOHLER.co.uk

For technical details please contact technical enquiries on 0844 571 0048 or visit www.kohlerpro.co.uk for further information.



Define your Bathroom Space

Showcasing a full range of sanitaryware, coordinating furniture, mirrors, taps, artist editions, enclosures and showering. We are confident you will find something to inspire you.



Kitchen Sinks & Taps

Combining beautiful design and smart functionality, Kohler kitchen sinks and taps simplify everyday tasks and bring inspiration to life. Our full-line catalogue will help you choose the right ingredients to create a kitchen that suits your life.



KOHLER.co.uk

View the latest bathroom designs
at KOHLER.co.uk.

© 2015 by Kohler Co.
Kohler UK

Cromwell Road Cheltenham Gloucestershire GL52 5EP United Kingdom
Sales & Technical Tel: +44 (0) 844 571 0048

KENC15

THE BOLD LOOK
OF **KOHLER**®

