

Installation and operating instructions

Twin Channel Programmer

Greenstar Comfort

For EMS compatible Worcester Greenstar condensing boilers

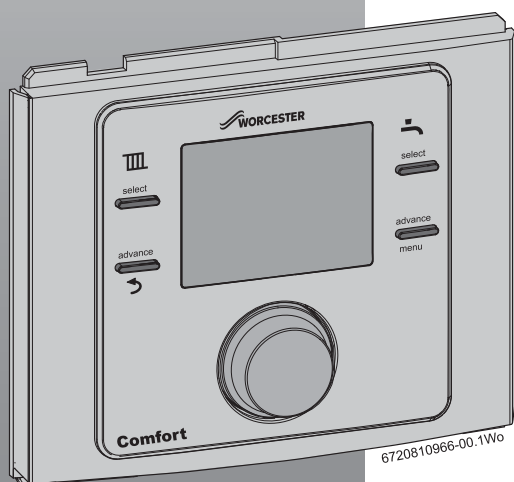

UK/IE

WORCESTER
Bosch Group

Contents

1	Key to symbols and safety instructions	3
1.1	Key to symbols	3
1.2	General safety instructions	3
2	Comfort Twin Channel Programmer	4
2.1	Programmer	4
3	Comfort installation	5
3.1	Programmer mounting	5
3.2	Time and date setting	6
4	Operation	6
4.1	Programmer	6
5	Programmer settings	7
5.1	User	7
5.1.1	Heating	7
5.1.2	Hot water	8
5.1.3	Holiday function	8
5.1.4	Info	8
5.1.5	Setting	8
5.2	Installer	9
5.3	Key lock	10
6	Troubleshooting	10
6.1	Temperature related faults	10
6.2	Comfort related faults	10
6.2.1	Programmer	10
7	Servicing	10
8	Maintenance	10
9	Environment / disposal	10

1 Key to symbols and safety instructions

1.1 Key to symbols

Warnings

	<p>Warnings in this document are identified by a warning triangle printed against a grey background.</p> <p>Keywords at the start of a warning indicate the type and seriousness of the ensuing risk if measures to prevent the risk are not taken.</p>
--	---

The following keywords are defined and can be used in this document:

- **NOTICE** indicates a situation that could result in damage to property or equipment.
- **CAUTION** indicates a situation that could result in minor to medium injury.
- **WARNING** indicates a situation that could result in severe injury or death.
- **DANGER** indicates a situation that will result in severe injury or death.

Important information

	<p>This symbol indicates important information where there is no risk to people or property.</p>
--	--

Additional symbols

Symbol	Explanation
▶	Step in an action sequence
→	Cross-reference to another part of the document
•	List entry
–	List entry (second level)

Abbreviations

CH	=	Central Heating
HW	=	Hot Water
DST	=	Daylight Savings Time
BST	=	British Summer Time
GMT	=	Greenwich mean time

Definitions (DST/BST)

Daylight Saving Time (DST) and British Summer Time (BST) begins on the last Sunday in March at 1:00am GMT and clocks are put forward by one hour.

British Summer Time (BST) ends on the last Sunday in October at 2:00am BST and the clocks are put back by one hour.

1.2 General safety instructions

These installation instructions are intended for heating engineers, and electricians.

- ▶ Read any installation instructions (boiler, heating controls, etc.) carefully before starting the installation.
- ▶ Observe the safety instructions and warnings.
- ▶ Observe national and regional regulations, technical rules and guidelines.
- ▶ Record all work carried out.

Appliance operation

This appliance can be used by children aged from 8 years and above and persons with reduced physical, sensory or mental capabilities or lack of experience and knowledge if they have been given supervision or instruction concerning use of the appliance in a safe way and understand the hazards involved. Children shall not play with the appliance. Cleaning and user maintenance shall not be made by children without supervision. (BS EN 60335-1 2012)

Installation, commissioning and servicing

Installation, commissioning and servicing must only be carried out by a competent engineer.

- ▶ Only use original spares.

Electrical work

Electrical work must only be carried out by a qualified electrician.

- ▶ Before starting electrical work:
 - Isolate the mains electrical supply and secure against unintentional re-connection.
 - Check for zero potential.
- ▶ Also observe connection diagrams of other system components.

Handover to the user

When handing over, instruct the user how to operate the heating system and inform him about its operating conditions.

- ▶ Explain how to operate the heating system and draw the user's attention to any safety-relevant action.
- ▶ Explain that modifications and repairs must only be carried out by an authorised contractor.
- ▶ Advise the user to have the system serviced annually by a competent engineer.
- ▶ Leave the this instruction manual with the user or at the appliance.

2 Comfort Twin Channel Programmer

2.1 Programmer

The Programmer is for central heating and hot water control. Up to three sets of ON and OFF times can be set for controlling central heating and hot water.

The unit has user and installer menus to allow the setting of time programs, monitoring of system information, setting current time/date, daylight savings and maintenance information.

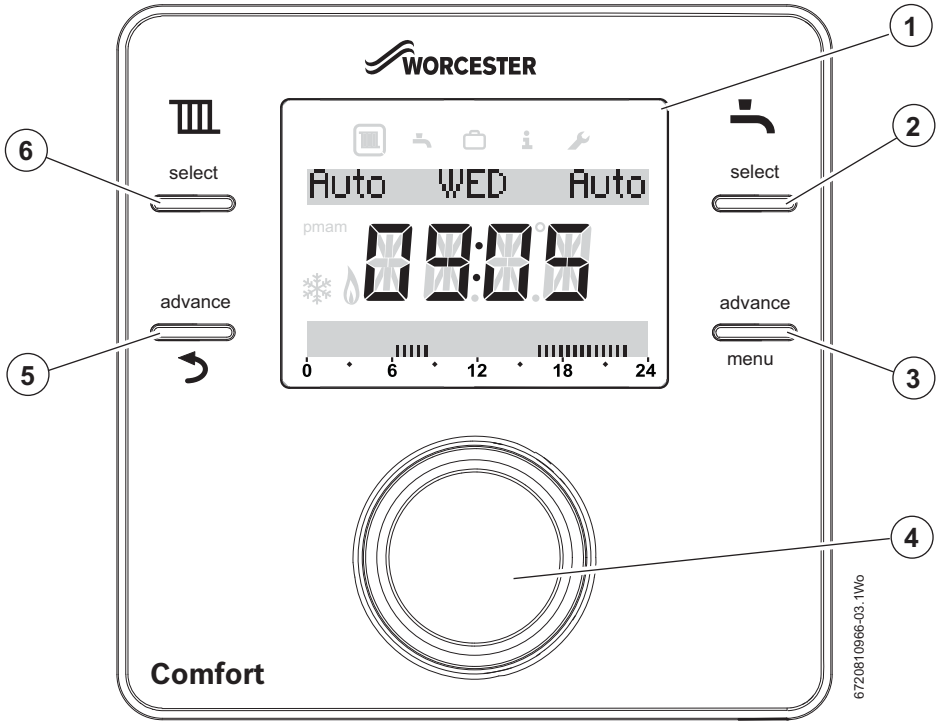

Fig. 1 Comfort Programmer

1	Display	Time, date, CH and HW program selection, fault codes, menu symbols and operational symbols
2	Hot water program selection	ON, OFF, AUTO, ONCE
3	Hot water (HW) program advance button / user menu selection button	Only functional in AUTO mode. Pressed once, advances the timer to the next programmed ON or OFF time, pressed again, returns to the current program. Hold the button down for more than 3 seconds to enter the user menu program
4	Rotary push button knob	Turn or press to select or confirm settings
5	Central heating (CH) program advance button / Back button	Only functional in AUTO mode. Pressed once, advances the timer to the next programmed ON or OFF time, pressed again, returns to the current program. When in the menu functions this button return to next higher level
6	Central heating program selection	ON, OFF, AUTO, ONCE

3 Comfort installation

CAUTION: Mains supplies

- ▶ Isolate the mains supplies to the boiler before starting any work, and follow all relevant safety precautions

Refer the boiler's Installation, Commissioning and Servicing instruction manual for information on the boiler. Refer to this manual for detailed information on installing and using the Comfort.

A brief overview of the Comfort installation procedure is listed:

- ▶ Isolate the boiler
- ▶ Remove any panels or casings required to gain access to the control panel
- ▶ Mount the Programmer (boiler fascia or a suitable wall location and wire back to the boiler)
- ▶ Turn the boiler on
- ▶ Set time and date on the Programmer

3.1 Programmer mounting

There are two methods of mounting the Programmer:

- In the boiler fascia
 - On the wall (optional wall mounting kit 7 733 600 039)
- If your boiler is mounted remotely i.e. in the loft or an outbuilding you may want the Programmer to be conveniently located for easy access

Boiler fascia mounted Programmer

Refer to your boiler's Installation, Commissioning and Servicing instruction manual for mounting the Programmer into the boiler fascia.

Wall mounted Programmer

Choose a convenient wall location, approximately 1.2 metres from the floor, to mount the Programmer.

Programmer/boiler connection

NOTICE: EMS Connections

- ▶ The Programmer must NOT be connected to the boiler's 230 volt supply or an external 230 volt supply.

- ▶ Ensure that the EMS cable is at least 100mm away from any power cables to eliminate any mains interference
- ▶ EMS connections are not polarity sensitive

Run a two core cable from the boiler to the Programmer's location.

Use an electrical cable with a minimum rating of H05VV-F.

For cable runs up to:

- ▶ 100 metres, use 0.50mm² conductor cross sectional area
- ▶ 300 metres, use 1.5mm² conductor cross sectional area

Connect the cable to the EMS bus point connections on the boiler control circuit board, refer to the Installation, Commissioning and Servicing instruction manual for your boiler to locate the EMS connections.

i The Comfort connects to your boiler's EMS BUS connections only, on an edge connector identified either with **BB** or 

Optional wall mounting kit

Using the wall plate as a template, mark the position of the mounting screws.

The optional wall mounting kit contains:

- 2 x countersunk screws
- 2 x plastic wall plugs
- Wall plate
- Top retainer
- ▶ Drill two holes to suit the size and depth of the wall plugs
- ▶ Fit the wall plugs
- ▶ Fit the wall plate [1], ensuring that it is level and tighten the screws to secure
- ▶ Connect the two core cable to the terminal block, one core to each outer connection, ignore the middle connection

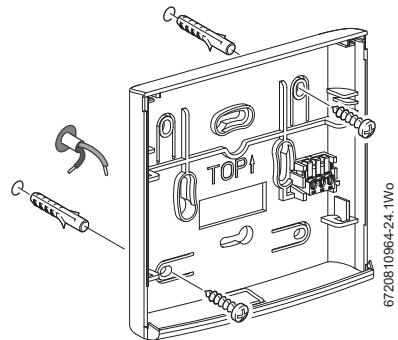

Fig. 2 Suggested Programmer wall plate mounting

- ▶ Engage the four clips on the back of the Programmer [2] with the four slots on the wall plate as shown in figure 3
- ▶ Push the Programmer down into the body of the wall plate to secure
- ▶ Engage the tabs on the top retainer [3] into the slots on the wall plate [1] and push down onto the Programmer to secure

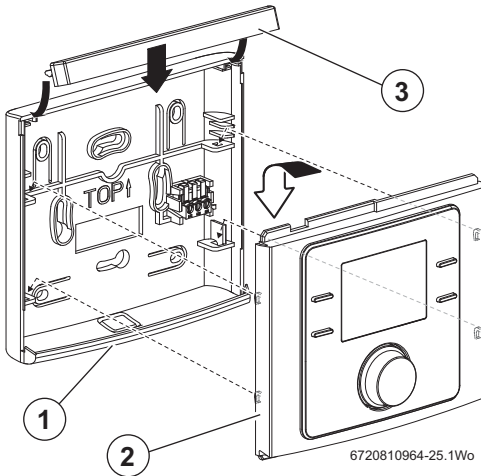

Fig. 3 Fitting Programmer to wall plate assembly

3.2 Time and date setting



If the boiler has been switched off for an extended period of time, the initial set up will have to be performed again.

► Turn the boiler ON
The Programmer will display a default time and date.



Set the current time and date

- Hold the menu button down for more than 3 seconds to enter the user menu, turn the knob to select Settings and press to enter
- Refer to section 5.1.5 **Settings - Time/Date** for setting the Time and Date, and clock format

4 Operation

The Programmer is supplied with factory set default ON and OFF times, for central heating (CH) and hot water (HW), that are shown in the table below.

This allows the homeowner to start using the Comfort programmer straight away without having to make any adjustments within the programmers menus.

However, these time settings can be reset according to the homeowner's requirements via the User menu function on the Programmer, refer to section 5.1. The times can be reset to the factory setting via the User menu.

	06:30	08:30	16:30	22:30
CH	ON	OFF	ON	OFF
HW	ON	OFF	ON	OFF

4.1 Programmer

During normal operation the display shows:

- the operational modes of the central heating and hot water, either **ON**, **OFF**, **AUTO**, **ONCE** or **ADV**, press the Central heating or HW **select** button to choose either:
 - **ON** = heating or hot water is permanently on
 - **OFF** = heating or hot water is permanently off
 - **AUTO** = programmed times for heating and hot water
 - **ONCE** = heating or hot water is on from the first programmed on time to the last programmed off time
- In the Auto mode, press the Advance button once to move to the next on or off time, press for a second time to return to the current programme
- the current time and day,
- am or pm for the 12 hour time format
- Graphical indication of the current time program, the black markers indicate half hour time periods. The flashing black marker indicates the current time position in the programmed sequence, either in the ON or OFF period.

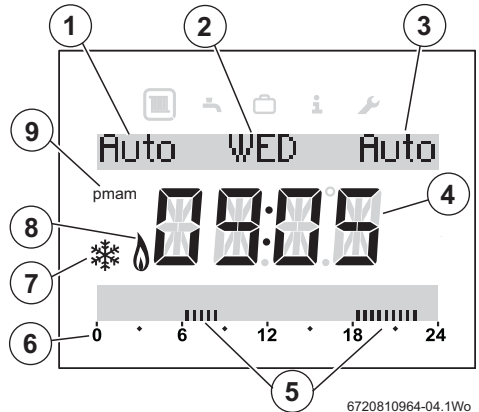

Fig. 4 Display elements

1. Central heating operational status
2. Current day
3. HW operational status
4. Current time
5. Graphical indication of the current time program
6. 24 hour time scale
7. Frost protection - displayed when boiler is set to minimum
8. Burner ON - display when boiler is heating
9. am or pm display - not displayed in 24 hour clock format

5 Programmer settings



There are two levels of settings:

1. User
2. Installer

5.1 User

Press the menu button for more than three seconds to enter the User setting area of the Programmer.

Five icons are shown across the top of the display:

1. Heating 
2. Hot water 
3. Holiday 
4. Info 
5. Settings 

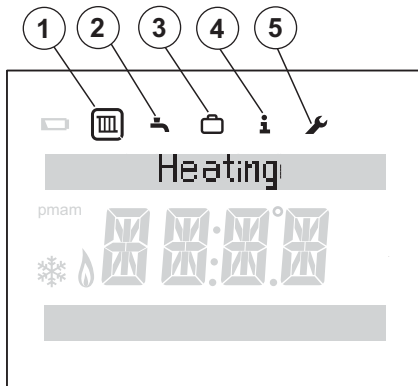

6720810965-16_11wo

Fig. 5 User menu

Turn the knob to select an icon, the icon is encircled to confirm the selection, and press the knob to enter that section.



The display will dim after 20 seconds of inactivity and remain dimmed until a button is pressed or the knob is turned/pressed. After 60 seconds of inactivity the display will return to normal operation.

5.1.1 Heating

This Time program is used to set your required ON and OFF times for the central heating. The Programmer has default time settings as shown below:

	06:30	08:30	16:30	22:30
CH	ON	OFF	ON	OFF

Time program

Select **Time program** with the knob, and press to enter.

Press the Return button  at any time to return to the previous higher level.

In the Time program you can select **ON** and **OFF** times for the central heating, there are three **ON** and three **OFF** programs. Using the knob you can select various combinations of days, for example:

- ▶ Mon to Fri
- ▶ Sat and Sun
- ▶ Monday, Tuesday, Wednesday, Thursday, Friday, Saturday and Sunday

Whether you choose to set the same times for Monday to Friday and different times for Saturday and Sunday or set times for individual days the setting operation is the same.

- ▶ Select the desired day(s) using the knob
- ▶ Press the knob to select the first Heating **ON** setting
- ▶ The hours flash
- ▶ Turn the knob to select the desired hours setting
- ▶ Press the knob to confirm
- ▶ The minutes flash
- ▶ Turn the knob to select the desired minutes
- ▶ Press the knob to confirm
- ▶ The first Heating **OFF** hours flash
- ▶ Turn the knob to select the desired hours setting
- ▶ Press the knob to confirm
- ▶ The minutes flash
- ▶ Turn the knob to select the desired minutes
- ▶ Press the knob to confirm
- ▶ Now the second Heating **ON** hours flash
- ▶ Repeat the process to set the hours and minutes for the second Heating **ON** times

6. Repeat the process for the second Heating **OFF** times



If the third heating period is not required repeatedly press the knob to cycle through the third period without making any settings.

- ▶ Repeat the whole process for the third Heating **ON** and **OFF** times, if required

If after setting the third time period you decide that you no longer require it and wish to disable it, follow these steps:

- ▶ In the Time program, cycle through time periods 1 and 2 by just pressing the knob to accept the time setting until you reach period 3
- ▶ Turn the knob to set the flashing hours to 00
- ▶ Press to accept and the minutes flash
- ▶ Turn the knob clockwise to 00 and then the display changes to just bars and period 3 is disabled

5.1.2 Hot water

This Time program is used to set your required ON and OFF times for the hot water. The Programmer has default time settings as shown below:

	06:30	08:30	16:30	22:30
HW	ON	OFF	ON	OFF

Time programs

Select time program with the knob, and press to enter. Press the Return button to go back to the previous higher level. In the time program you can select ON and OFF times for the hot water heating, there are three ON and three OFF programs. Using the knob you can select various combinations of days or individual days:

- ▶ Mon to Fri
- ▶ Sat and Sun
- ▶ Monday, Tuesday, Wednesday, Thursday, Friday, Saturday and Sunday



Whether you choose to set the same times for Monday to Friday and different times for Saturday and Sunday or set times for individual days the setting operation is the same as previously set in the Heating program.

5.1.3 Holiday function

This function, by default, is set to OFF.

When the Holiday function is set, via this program, the function will become active at 00:01 am of the day set and inactive at midnight on the last day set.

During the holiday period **Holiday** and 5 °C will be displayed, the HW and CH functions are off and will return to normal operation at the end of the holiday period. The Frost symbol will be displayed, indicating that the boiler is OFF but is protected when the temperature fall below 5 °C.

Turn the knob to select the **Holiday** function:

- ▶ Press the knob to enter the program and **OFF** is displayed
- ▶ Press the knob and **OFF** flashes, turn the knob to select **ON**
- ▶ Press the knob to select **ON**, two day/months are displayed which will be the start and finish of the holiday period, the first date displayed will be today's with the day flashing
- ▶ Turn the knob to select the desired day
- ▶ Press the knob to confirm the day, now the month flashes
- ▶ Turn the knob to select the desired month
- ▶ Press the knob to confirm
- ▶ Now the last day of the holiday period flashes
- ▶ Turn the knob to select the desired day
- ▶ Press the knob to confirm and the month now flashes
- ▶ Turn the knob to select the desired month
- ▶ Press the knob to confirm
- ▶ **ON** will be displayed when the function is active
- ▶ After setting the holiday period, repeatedly press the Return button to return to the normal display.

To cancel the holiday function:

- ▶ Press the menu key for more than three seconds to enter user menus and select **Holiday**, **ON** will be displayed.
- ▶ Press the knob and **ON** flashes, turn the knob to select **OFF**
- ▶ Press the knob to confirm **OFF**
- ▶ Repeatedly press the return button  to go back to the user menu

5.1.4 Info

This Programmer does not support this function

5.1.5 Setting

- ▶ Turn the knob to select **Settings** and press to enter the function. Four menus are available, indicated by the flashing arrow heads, turning the knob will cycle through the available menus:

1. Language
2. Time/date
3. Format
4. Reset all

Language

This function allows you to choose the language used by the Programmer, by default is set to English (EN).

- ▶ Turn the knob to select language, EN flashes, select either:
 - EN (English)
 - NL (Dutch)
 - dE (German)
- ▶ Press the knob to confirm the desired language

Time/Date

This function allows the current time and date to be set, this would be used on initial set up of the Programmer or if the time and date were lost due to the boiler being switched off for an extended period of time.

Turn the knob to select **Time/date** and press to enter the **Clock time** function:

- ▶ Press the knob to select clock time and the hours flash
- ▶ Turn the knob to select the correct hour
- ▶ Press the knob to confirm the selection and minutes flash
- ▶ Turn the knob to select the correct minutes
- ▶ Press the knob to confirm the selection
- ▶ Turn the knob to display the date set up area
- ▶ Press the knob to select the function, the day flashes
- ▶ Turn the knob to select the correct day
- ▶ Press the knob to confirm the correct day and then the month flashes
- ▶ Turn the knob to select the correct month
- ▶ Press the knob to confirm and then the year flashes
- ▶ Turn the knob to select the correct year
- ▶ Press the knob to confirm to set the year
- ▶ Turn the knob to display **DST** (Daylight savings time) ON
- ▶ Press the knob and **ON** flashes

- ▶ Turn the knob to select **ON** or **OFF**, if **ON** is selected the Programmer will automatically adjust the time in conjunction with daylight savings time
- ▶ Press the knob to confirm the selection
- ▶ Press the return button  to go back to **Time/date** and turn the knob to select **Format**

Format

This function allows you to change the way the date is displayed, by default the format is DD.MM.YYYY. Once the date and time have been set the date format can be set:

- ▶ Press the knob to show the date format flashing
- ▶ Turn the knob to select either:
 - DD.MM.YYYY
 - MM/DD/YYYY
- ▶ When the desired format for the date has been selected, press the knob to confirm and return to **Date format**
- ▶ Turn the knob to select **Time format**, this function allows to change the way the time is displayed, either 12 or 24 hour, by default 24 hour is set.
- ▶ Press the knob and the time format is displayed flashing
- ▶ Turn the knob to select either:
 - 12 hour
 - 24 hour
- ▶ Press the knob to confirm once the choice has been made
- ▶ When the desired format has been selected, turn the knob to display **Contrast**
- ▶ Press the knob to select **Contrast**, this function allows you to adjust the contrast of the screen, by default it is set to 10
- ▶ The current contrast flashes
- ▶ Turn the knob to select from 0 to 20 the desired level, adjusting the contrast increases the intensity of the display
- ▶ Press the knob to confirm

Press the return button at any time to return to the next higher level, you can keep pressing the return button until you return to the normal display.

Reset all

Turn the knob to select **Reset all**, this function will reset all the Programmer User settings back to the factory default settings. Any customised ON /OFF times for heating or hot water or any other customised settings will have to be re-entered.

Any default settings are described at the beginning of the functional descriptions.



- ▶ Press the knob and NO flashes
- ▶ If a reset is required turn the knob to select YES
- ▶ Press the knob to confirm
- ▶ Dashes progress across the screen until four are displayed briefly, then the display reverts to just showing **Reset all**

5.2 Installer

These functions are only used by the installer/service engineer and are useful during installation of the Comfort Programmer or during an annual service/inspection.

Press the menu button and return button for more than three seconds to display the Installer icon on the programmer.

Six icons are shown across the top of the display:

1. Heating 
2. HW (Hot Water) 
3. Holiday 
4. Info 
5. Settings 
6. Installer setting 

Selections 1 to 5 are the same as the Programmer user menu, → section 5.1.

Turn the knob to select the Installer icon  and press the knob to enter the function.

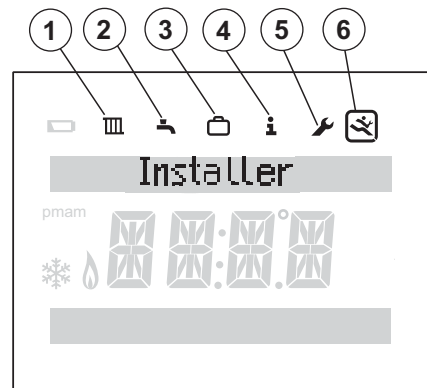

6720810965-17-1W0

Fig. 6 Installer menu

Installer settings menu options

Press the knob and the following menus are available:

1. Reset all
2. Maintenance
3. System info

The menu options are displayed on the top line with flashing left and right arrows heads, indicating that there are other menu options available. Turning the knob will select each option in turn, eventually returning to the first option.

1. Reset all

The Programmer Installer menus will be reset to factory default settings, any default settings are described at the beginning of the functional descriptions.

- ▶ Press the knob and **NO** flashes

- ▶ Turn the knob to select **NO** or **YES**
- ▶ Press the knob to confirm, if **YES** is chosen the unit is set back to the Installer menus factory defaults, four bars progress across the display until the reset has taken place, if **NO** is chosen, no reset takes place

2. Maintenance

Turn the knob to select **Maintenance** and the following menus are available:

1. Fault history

Fault history

- ▶ Press the knob and **Cont. faults** is displayed
- ▶ Press the knob and the first of five faults is displayed with the fault code and occurrence date. The fault screens can be scrolled through using the knob. If no faults have occurred, the text **No fault** will be displayed.

3. System info

- ▶ Turn the knob to select **System info**
- ▶ Press the knob and the install date is displayed
- ▶ Press the knob to return to **Install date**
- ▶ Turn the knob to select **SW controller**
- ▶ Press the knob to display the software controller version
- ▶ Press the knob to return to **SW controller**
- ▶ Press the return button  to go back to **System info**

5.3 Key lock

When the **Key lock** is active, no user interaction with the unit is possible, if a button is pressed or the knob turned/pressed the word **Key lock** is displayed.

Key lock ON

To activate the **Key lock**:

- ▶ Hold down the CH Select button and the knob at the same time for more than three seconds and the **Key lock** is active

Key lock OFF

To de-activate the **Key lock**:

- ▶ Hold down the CH Select button and knob at the same time for more than 3 seconds and the **Key lock** is de-activated

6 Troubleshooting

6.1 Temperature related faults

Problem	Cause	Remedy
The required room temperature has not been achieved.	Airlock	Bleed the radiators and vent the heating system.
	Low system pressure	Top the system pressure via the filling link
	Time program	The heating is not on for long enough
	Flow temperature	Set a higher flow temperature
Thermostat valve faulty/sticking		Operate the TRV to ensure that it does not stick
		Fully open the TRV

6.2 Comfort related faults

6.2.1 Programmer

Fault code	Cause code	Problem	Description	Remedy
A27	1007	Unable to communicate with boiler's EMS bus	Boiler is EMS compatible but no communication	Replace EMS interface

7 Servicing

The unit can not be serviced.

Should the unit fail to function correctly check that the:

- ▶ Programmer settings are correct

8 Maintenance

The unit requires no maintenance.

The outer casing can be wiped clean using a dry cloth, do not use polish or detergents.

9 Environment / disposal

Environmental protection is a fundamental corporate strategy of the Bosch Group.

The quality of our products, their economy and environmental safety are all of equal importance to us and all environmental protection legislation and regulations are strictly observed.

We use the best possible technology and materials for protecting the environment taking account of economic considerations.

Packaging

We participate in the recycling programmes of the countries in which our products are sold to ensure optimum recycling.

All of our packaging materials are environmentally compatible and can be recycled.

Electrical and electronic equipment



Scrap electrical and electronic equipment must be collected separately and returned to an environmentally compatible recycling facility (European Directive on waste electrical and electronic equipment).

Use the country specific return and collection system for the disposal of electrical and electronic equipment.

Worcester, Bosch Group
Cotswold Way, Warndon, Worcester WR4 9SW.
Tel. 0330 123 9559
Worcester, Bosch Group is a brand name of
Bosch Thermotechnology Ltd.

worcester-bosch.co.uk

Comfort 6 720 810 966 (2014/07)

WORCESTER, BOSCH GROUP:

TECHNICAL SUPPORT:	0330 123 3366
APPOINTMENTS:	0330 123 9339
SPARES:	0330 123 9779
LITERATURE:	0330 123 9119
TRAINING:	0330 123 0166
SALES:	0330 123 9669



WORCESTER
Bosch Group

