

SALUS[®]

CONTROLS PLC

iT500 Internet Thermostat



INSTALLER MANUAL

1. Product compliance & safety information

These instructions are applicable to the SALUS Controls model stated on the front cover of this manual only, and must not be used with any other make or model.

This accessory must be fitted by a competent person, and installation must comply with the guidance provided in the current IEE Wiring Regulations and current Building Regulations. Failure to comply with the requirements of these publications could lead to prosecution.



Always isolate the AC Mains supply before installing or working on any components that require 230 VAC 50Hz supply.

**When fitting batteries, do not mix old and new batteries together.
Do not use rechargeable batteries.**

Please leave these instructions with the end user where they should be kept in a safe place for future reference.

2. Installation of the iT500RX Receiver



1
Loosen the screws at the bottom of the receiver unit.



2
Unclip the front of the unit.

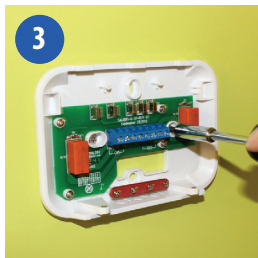

3
Fit the back of the receiver unit to the wall using the fittings supplied.

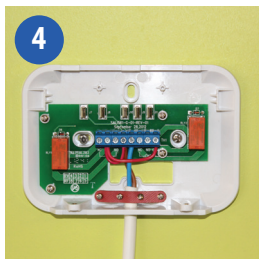

4
Wire up the receiver using one of the schematics on pages 4 and 5



5
Clip the front of the unit back on by aligning the fittings and pushing into place.



6
Securely screw the front of the receiver in place.

3. WIRING SCHEMATICS FOR SYSTEM CONFIGURATIONS

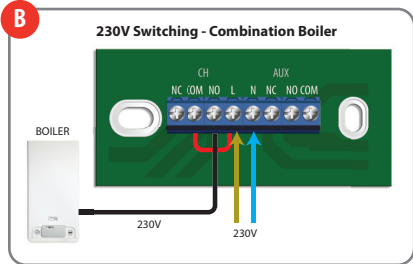
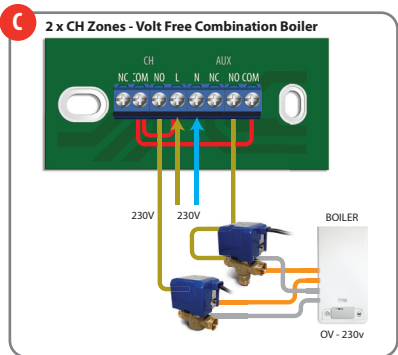
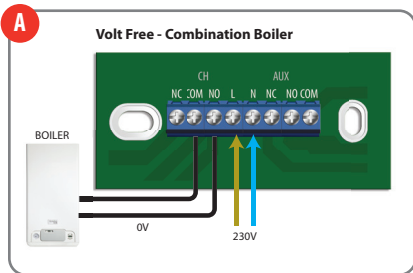

A One central heating zone only.



B One central heating zone only.







C Two central heating zones.

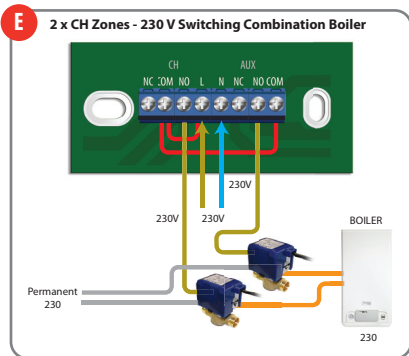
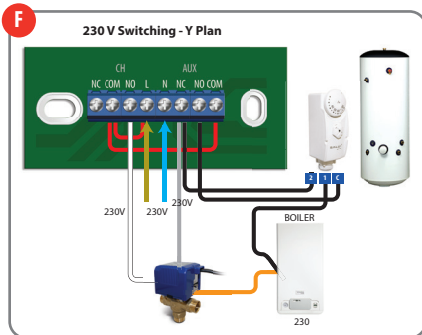
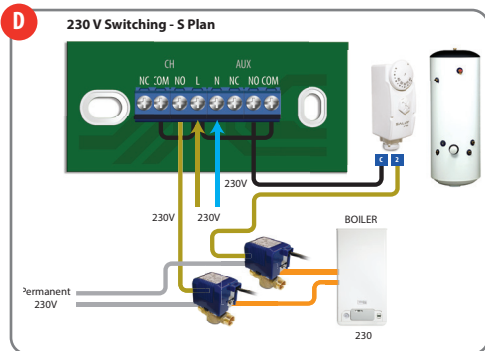

iT300 Sensor required for this configuration.

3. WIRING SCHEMATICS FOR SYSTEM CONFIGURATIONS



- D** One central heating zone plus hot water. 
- E** Two central heating zones.  *iT300 Sensor required for this configuration.*
- F** One central heating zone plus hot water. 

4. Installation of wall bracket docking (optional)



1
Attach the wall mounting bracket to a suitable wall using the fittings supplied and the built-in level.



2
After first ensuring that the bracket is secure, clip the iT500 into place by aligning the recess on the back of the unit to the bracket and clipping into place.



3
Once clipped into place, ensure the unit is securely seated on the bracket.

i For best results mount the iT500 1.5m from ground level.

5. Desk mount option iT500



For the desk mounted option, simply clip the clear stand supplied separately into the back of the unit.

6. Connecting the Gateway to your existing router

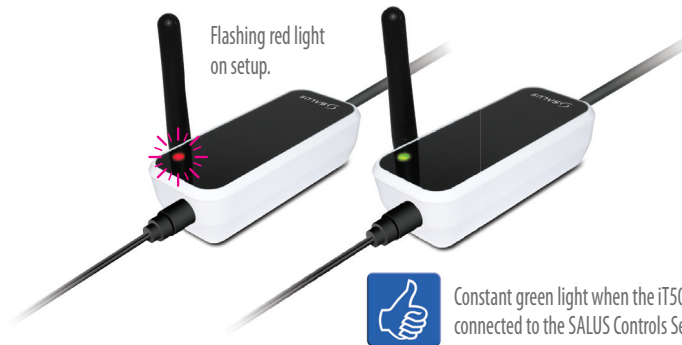
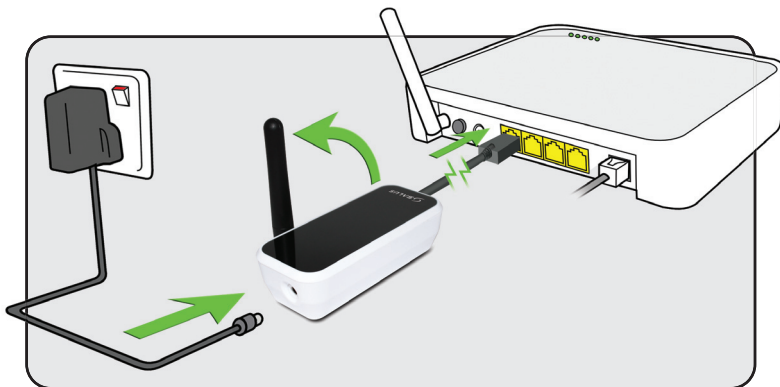

8. Setting up the iT500 Thermostat

After powering up iT500 for the first time the display will go through the following sequence.

1



OTA* Revision number

2



3



iT500 Software revision

4



The globe icon  will appear when the unit automatically connects to the internet via the SALUS iTG500 Gateway. This should take approximately 20 seconds.



* Over The Air operated software

9. LCD Overview

LCD ICONS	DESCRIPTION	FUNCTION
1234567	Day of the week	Displays the number of the day of the week. 1 being Monday
88 ^E _B	Temperature indicator	Displays set or measured temperature
88:88	Clock display	Displays time
1 2 3 4 5 6	Program number indicator	Displays the number of the active (selected) program
	Heat mode indicator	Indicates heating output is turned on*
	Heat zone indicator	Indicates heating zone*
	Hot water indicator	Indicates hot water control*
	Hot water mode indicator	Indicates hot water output is turned on*
	RF signal indicator	Indicates the unit is transmitting a wireless signal to the iT500RX or is receiving the signal from the iT300*
	Touch lock indicator	Indicates touch lock is activated
	Battery status	Indicates battery is low
	Holiday indicator	Indicates holiday operation mode is selected
	Internet indicator	Indicates connection to iTG500 and SALUS server
	Cooling indicator	Indicates cooling output is on*
ON	ON indicator	Hot water continuously on*
1	Once indicator	Hot water is on once*
AUTO	AUTO indicator	Automatic program mode
OFF	OFF indicator	Off mode
	Setting indicator	Manual override or settings mode

* System configuration specific.

Selecting your system configuration

Based on your system wiring on page 4.



If the iT500 is to be used in the UK for single zone heating then there is no need to enter system configuration setup, please proceed to page 15.



Note! This menu should only be entered by the installer as changes can have a detrimental effect on your heating system.



At any time press and hold  for 5 seconds to return to the home screen.

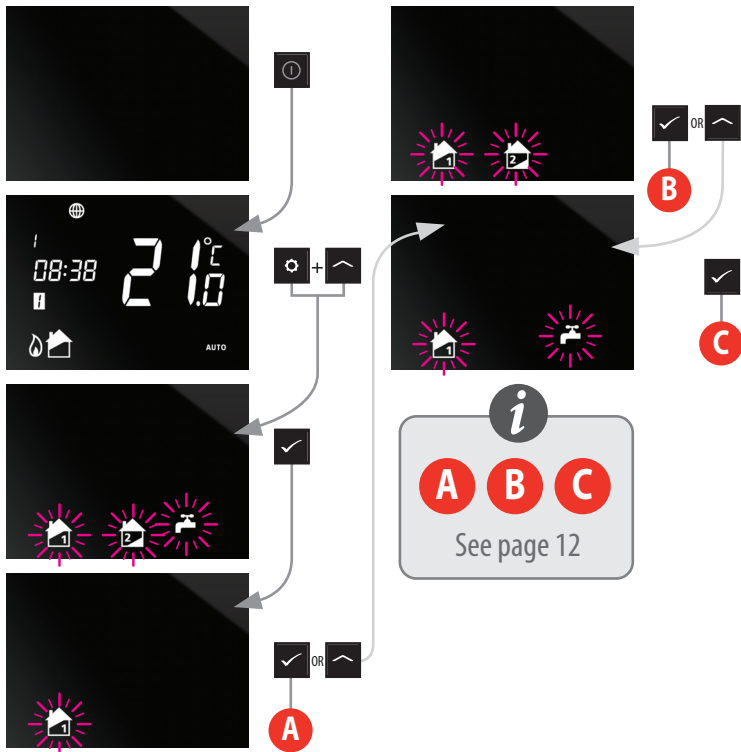

Now that you have selected your system configuration you can continue with the rest of the installation setup.



* Cooling can only be selected if your system supports this.
 ** Please refer to the following page for your region.

10. European Time Zones

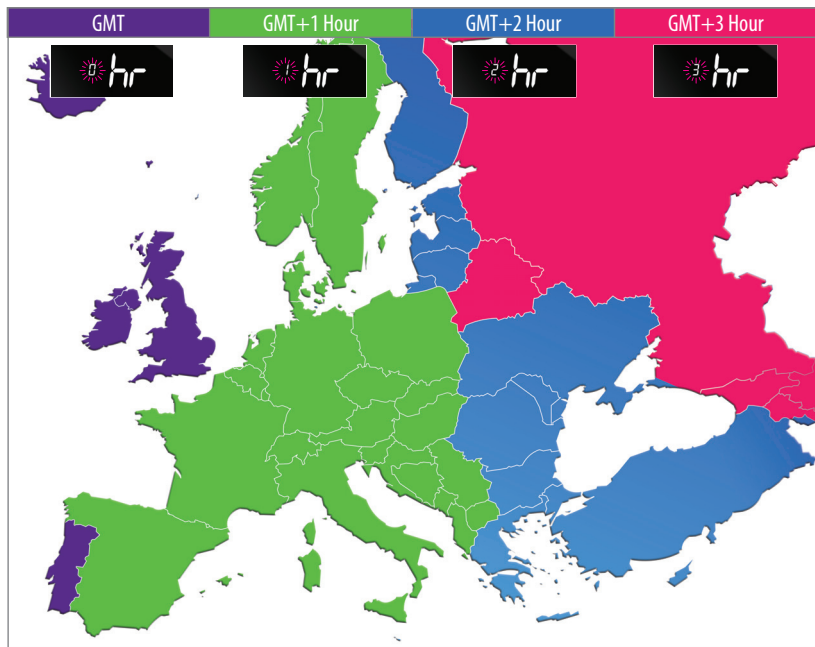

UK
IRELAND
PORTUGAL
ICELAND*

AUSTRIA
POLAND
GERMANY
CZECH
SPAIN
FRANCE
ITALY
SWITZERLAND
LUXEMBOURG
HOLLAND

BELGIUM
DENMARK
SWEDEN
NORWAY
MALTA
CROATIA
SERBIA
BOSNIA
SLOVENIA

ESTONIA
TURKEY
CYPRUS
GREECE
ROMANIA
RUSSIA
UKRAINE

BULGARIA
LITHUANIA
BELARUS*
FINLAND
MOLDOVA
LATVIA

RUSSIA*



The countries marked with * do not observe Daylight Saving Time

Now that you have selected your system configuration you can continue with the rest of the installation setup. DST (daylight saving time) ON will automatically change your time from summer to winter.

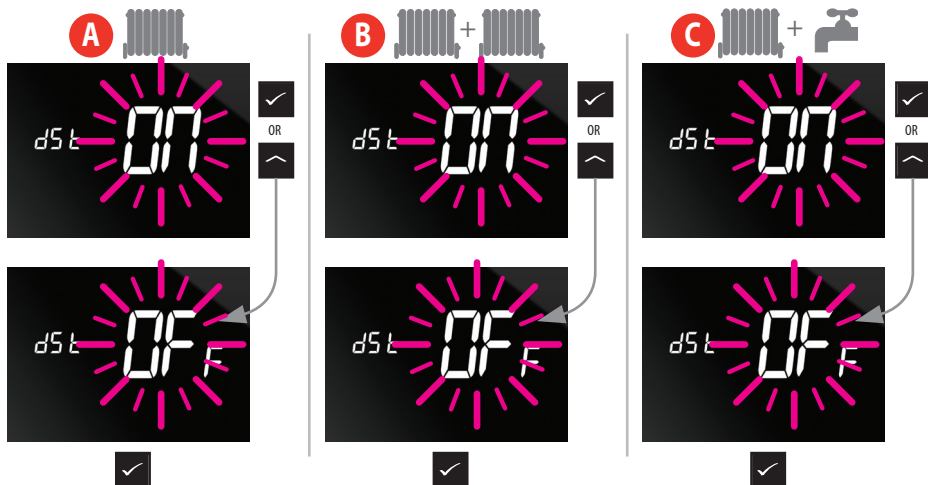

11. Pairing the iT500 with the iT500RX Receiver





Using a paper clip, insert into the hole marked SYNC at the bottom of the iT500RX Receiver. Then work through the screen sequence shown on the next page.



The bottom switch will show a constant red light when the iT500RX Receiver is ready to pair. Now go to the iT500 Thermostat.

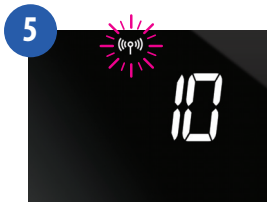
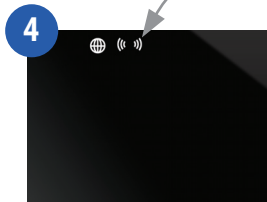

FAILSAFE MODE: In the event of RF signal loss, your system will be switched on for 4 minutes, then off for 11 minutes. If you want to disable FAILSAFE MODE when RF link has been lost then move the slide switch on the iT500RX to either the manual or off position.



When the iT500RX Receiver and the iT500 Thermostat are paired then the light will be green.

Press  OR 

to return to home screen.

12. Fitting the wall bracket and mounting the iT300

i

Used for 2
central heating
zones only

Note: iT300 purchased separately. Can only be used if your system supports two central heating zones. See pages 4 and 5.

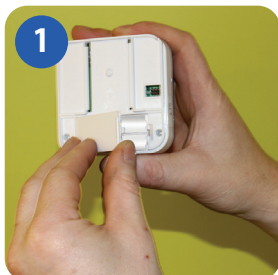

1 Remove the battery cover on the back of the iT300 unit.

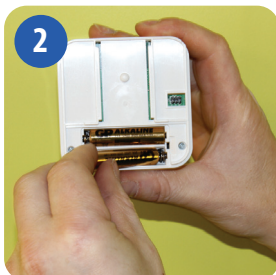

2 Insert the 2x AAA batteries supplied into the iT300 unit.



3 Replace the battery cover.



3 Attach the wall mounting bracket to a suitable wall using the fittings supplied.



4 Align the grooves on the back of the iT300 unit and slide onto the bracket.



5 Once in place, ensure the unit is securely seated on the bracket.

13. Pairing the iT300 to the receiver



To pair the iT300 to the receiver, insert a paperclip or similar object into the hole on the left hand side of the iT300 for 2 seconds.



A red light will flash in the top right hand corner of the iT300.

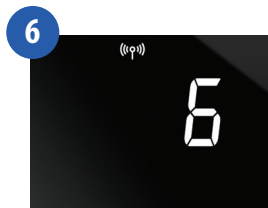
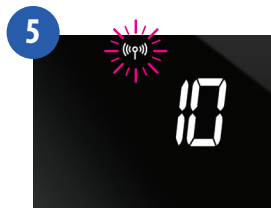
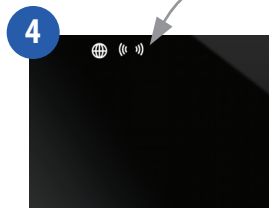
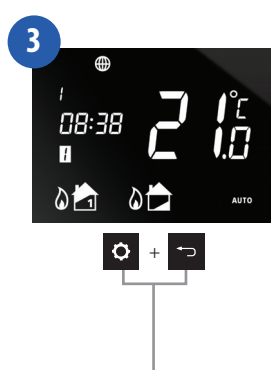

The iT500 has successfully paired with the iT300 when the antenna stops flashing.

Press OR

to return to home screen.

Please note the red LED on the iT300 will continue to flash and eventually timeout.

i The iT300 should be installed in the area of the house that the second zone will be controlled from, ie. Upstairs.

14. Registering and operating your iT500 online

1



Go to the SALUS controls website. www.salus-controls.com and select your relevant country

2



Click on the register iT500 icon on the left hand side of your country's website

14. Registering and operating your iT500 online

3



Click on REGISTER

4

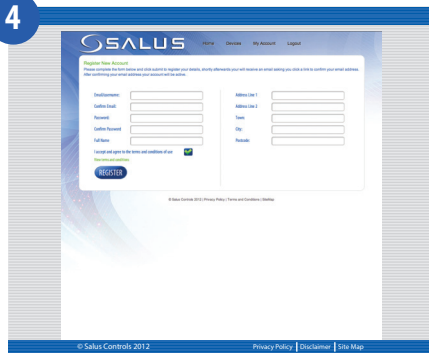

Fill in the online form and click REGISTER

5



The above screen will show and a confirmation email will be sent to you

14. Registering and operating your iT500 online

6

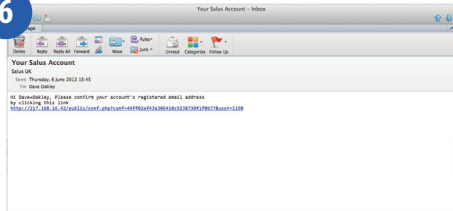

You will receive a confirmation email. Click on the link to complete your registration.

7



Now use your username and password to log in.

8

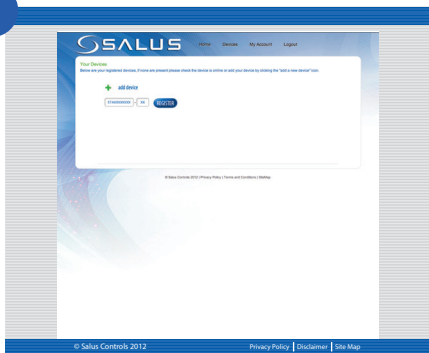

Enter the iT500 STA number (Please refer to page 8). Then press REGISTER.

9



Your iT500 will appear as above and is now ready to be controlled or viewed via your PC or Smartphone. Just click on the iT500 icon on your PC.

15. Download Smartphone App

Once you have registered your iT500 online you can also download the smartphone App from the iPhone App Store or the Android App Store depending on which kind of Smartphone you are using. Find the iT500 App on the App Store and click download. The App will automatically download to your Smartphone and once downloaded you can begin controlling your iT500 Thermostat.

www.salus-controls.com ————— Go to the [salus-controls.com](http://www.salus-controls.com) website.



Google play ——— Click on the relevant App Store Icon.



————— Find the SALUS iT500 App and click download.

16. Adding or renaming the iT500 in your device list



Enter your user ID and password.
Press **LOG IN**



When you first open the iT500 App your iT500 will appear in the device list and you can begin controlling it with your Smartphone.



If you add more than 1 iT500 to your device list, you may wish to rename the iT500 to "DOWNSTAIRS" for example. Click on **RENAME** and enter a new name.



If you forget your password, follow the on screen instructions.



For full information on PC and Smartphone operation please refer to the user manual.

17. Warranty

SALUS Controls warrants that this product will be free from any defect in materials or workmanship, and shall perform in accordance with its specification, for a period of two years from the date of installation. SALUS Controls sole liability for breach of this warranty will be (at its option) to repair or replace the defective product.

Customer Name:

Customer Address:

..... Post Code:

Tel No: Email:

Engineers Company:

Tel No: Email:

Installation Date:

Engineers Name:

Engineers Signature:

SALUS Controls plc

SALUS House

Dodworth Business Park South,

Whinby Road,

Dodworth, Barnsley S75 3SP

UK.

SALES: T: +44 (0) 1226 323961
E: sales@salus-tech.com

TECHNICAL: T: +44 (0) 1226 323961
E: tech@salus-tech.com

www.salus-controls.com



SALUS Controls is a member of the Computime Group

Maintaining a policy of continuous product development SALUS Controls plc reserve the right to change specification, design and materials of products listed in this brochure without prior notice.

Issue Date: Sept 2013