



Showering perfection™

mira
SHOWERS

Contents

Showering perfection	2-10	Overview	110
Introduction	2	Mira Vigour Manual	111
What's your idea of the perfect shower?	3-4	Mira Vigour Thermostatic	112
Our history and looking to the future	5-6	Mira Event XS Manual	113
Choosing your perfect shower	7-10	Mira Event XS Thermostatic	114
Mixer showers	11-66	Mira Extreme Thermostatic	115-116
Introduction	11-12	Mira ACE shower enclosure	117-146
Mira Mixer Showers features and benefits	13-14	Introduction	117-118
Overview	15-16	How to choose your perfect shower enclosure	119-120
Mira Agile	17-18	Overview	121-122
Mira Agile Eco	19	Mira ACE bathscreen	123-124
Mira Agile Accessories	20	Mira ACE pivot door - alcove	125-126
Mira Adept	21-22	Mira ACE pivot door - corner	127-128
Mira Adept Eco	23	Mira ACE pivot pentagon - corner	129-130
Mira Adept Accessories	24	Mira ACE bi-fold door - alcove	131-132
Mira Coda	25	Mira ACE bi-fold door - corner	133-134
Mira Coda Pro	26	Mira ACE bi-fold pentagon - corner	135-136
Mira Coda Pro with Diverter	27	Mira ACE sliding door - alcove	137-138
Mira Minilite	28	Mira ACE sliding door - corner	139-140
Mira Miniduo	29-30	Mira ACE quadrant	141-142
Mira Minilite Eco	31	Mira ACE corner - entry	143-144
Mira Miniduo Eco	32	Mira ACE accessories	145-146
Mira Element	33-34	Mira Beam shower enclosures	147-178
Mira Element SLT	35-36	Introduction	147-148
Mira Silver	37-38	How to choose your perfect shower enclosure	149-150
Mira Bijou	39	Overview	151-152
Mira Tabla	40	Mira Beam divider panels	153-154
Mira Discovery Dual	41-42	Mira Beam pivot door - alcove	155-156
Mira Discovery Concentric	43-44	Mira Beam pivot door - corner	157-158
Mira Discovery with Diverter	45-46	Mira Beam bi-fold door - alcove	159-160
Mira Gem 88	47	Mira Beam bi-fold door - corner	161-162
Mira Combiforce 415	48	Mira Beam sliding door - alcove	163-164
Mira Minibelle with 360 Showerhead	49-50	Mira Beam sliding door - corner	165-166
Mira Myline	51-52	Mira Beam quadrant	167-168
Mira Miniluxe	53	Mira Beam pivot pentagon - corner	169-170
Mira Miniluxe with Diverter	54	Mira Beam bi-fold pentagon - corner	171-172
Mira Realm	55	Mira Beam walk-in - alcove	173-174
Mira Realm with Diverter	55	Mira Beam walk-in - corner	175-176
Mira Montpellier	56	Mira Beam accessories	177-178
Mira Select	57-58	Shower trays & wall panels	179-183
Mira Select Flex	59-60	Mira Flight trays - introduction	179-180
Mira Excel	61-62	Mira Flight tray - quadrant	181
Mira Mode	63-64	Mira Flight tray - pentagon	181
Mira Twin Ended Pumps	65	Mira Flight tray - rectangle	182
Mira Extra and Mira Excel Bath Shower Mixers	66	Mira Flight tray - square	182
Digital showers	67-74	Mira Flight tray - riser conversion kit	183
Introduction	67-68	Mira tile upstand kit	183
Mira Digital Showers features and benefits	69	Mira Flight walk-in trays	183-184
Overview	70	Mira Flight Low trays	185-190
Mira Vision	71-72	Mira Flight Low trays - introduction	185-186
Mira Platinum	73-74	Mira Flight Low tray - square	187
Electric showers	75-106	Mira Flight Low tray - quadrant	187
Introduction	75-76	Mira Flight Low tray - pentagon	187
Mira Electric Showers features and benefits	77-78	Mira Flight Low tray - rectangle	187
Overview	79-80	Mira tile upstand kit	188
Mira Via	81-82	Mira Flight Low tray - riser conversion kit	188
Mira Jump	83	Mira Flight wall panels	189-192
Mira Zest	84	Mira Flight wall panels - introduction	189-190
Mira Sport	87-88	760 enclosure	191
Mira Sport Multi-fit™	89-90	800 enclosure	191
Mira Sport Thermostatic	91-92	1200 enclosure	191
Mira Sport Max with Airboost™	93-94	Accessories	193-210
Mira Elite ST	95-96	Introduction	193-194
Mira Orbis	97-98	Mira Eco	195-196
Mira Escape	99	Mira Everclear	197-198
Mira Azora	100	Mira 360	199-200
Mira Galena	101-102	Mira Showerhead range	201-204
Mira Advance ATL	103	Additional Mira accessories	205-206
Mira Advance Low Pressure	104	Mira mix & match fittings & valves	207-208
Mira Advance ATL Flex	105	Mira Excel taps & bath shower mixers	209
Mira Advance ATL Memory	106	Mira Discovery taps & bath shower mixers	210
Power showers	107-116	Support	211-213
Introduction	108	Get in touch	211-212
Mira Power Showers features and benefits	109	How to arrange a visit	213



Here at Mira, it's the details you care about that we care about. Whatever we do, from pioneering the latest technology to breaking the mould with innovative designs, it's all to make your showering experience the very best it can be. Now, some might think "a shower is a shower" but, we think differently. We understand that your shower is part of your daily routine. You rely on it, relax in it and trust it. You want to be proud of it, amazed by it and cleansed by it - sometimes physically, sometimes emotionally. We understand that not all showers are the same and that not everyone wants the same things from a shower. But, most importantly, we believe in the one thing we all want - *Showering perfection™*

Approval Marques



Assesses products for compliance with regulation 4 of the Water Supply (Water Fittings) Regulations 1999.



Developed by the BMA to raise awareness of bathroom products that when installed and used correctly use less water and save energy.



Certifies Type 2 thermostatic mixing valves for the domestic market to promote the safe use of hot water, with the immediate focus on social housing.



Awarded by the BEAB to products that have been evaluated against the highest European and International standards.



Waterwise is the leading authority on water efficiency in the UK. Every year they award their Marque to products that cut back on wasted water.



Awarded by the BEAB to products that have been additionally tested on performance relating to application in the care sector.



Shows that the product has been endorsed by the Royal National Institute of Blind People (RNIB).

What's your idea
of the perfect shower?

Functional?
Stylish?
Clever?
Extra safe?
Or all of the above?

Well, we've got showers that will clean and refresh you - a whole host in fact. But most people want more than that. So, we've also got showers with digital timers that keep you from being late for work. Showers with glass fascias that send your friends green with envy. And, showers with remote controls for when you just want to turn the shower on from your bed.

But it doesn't end there. We've got showers that look after the environment by saving up to 75% water. Showers that are breaking the mould with nifty little designs. And, showers with thermostatic controls that keep your little ones safe.

Quite simply, we've got a shower for every body.

90
YEARS
of Showering

Why we're still No.1 after 90 years.

For almost a century we've been designing, developing and building showers. To have been this successful for this long isn't all down to luck, it's also down to good old fashioned hard work and attention to every little detail.



We've always been a forward-thinking company

Since 1921 we have been leading the way in the UK showering market. Today, as part of the American family-run Kohler Co., we're doing exactly the same. By producing showers that constantly go above and beyond traditional showering, we have set a benchmark for quality that few can claim to match.



We think the future of showering is always just one idea away

We're perfectionists so we're always striving to make things better. That's why our ground-breaking Research and Development teams are constantly developing innovative designs and new ways to make your showering experience even more pleasurable.



We test, test and test again

We've got a reputation that's second to none – and we'd like to keep it that way. So, when it comes to testing our showers, we really put them through their paces. Every single shower undergoes a rigorous set of tests including a pressure test, to make sure there are no leaks, and a check against its product specification.



We save money and care for the environment

You probably already know that taking a quick shower rather than having a bath helps to save water. But, did you know you could do even more for the environment thanks to our water-efficient products? We've even won awards for them! You can find more information on these products by simply turning to pages 193-194.



We make things easy for you

Even in the simplest of showers, there's a whole host of complex technology on the inside. But on the outside, we design every Mira shower to be easy to choose, easy to use and easy to fit. So, while we concentrate on the techy bit, you just relax and enjoy the perfect shower, every time.



First for thermostatic

Way back in 1937 we developed the world's first thermostatic shower. Designed to bring safe and reliable showering to hospitals and schools by stabilising the water temperature, this revolutionary mixer instantly set the standard. Then, in 1959, we took it one step further by unveiling the first thermostatic mixer designed specifically for the UK home.

We're here if you need a helping hand

Choosing a shower can be a confusing process. But fear not, we're here for you every step of the way. For a start you'll find a whole host of helpful advice on our website, www.mirashowers.co.uk, where you can check specifications, compare showers and even download installation guides for all our products. However, if you'd rather speak to someone directly, just give us a call on **0844 571 5000**. For customers from the Republic of Ireland please call Modern Plant on **01 459 1344** – we're always happy to help.

For UK & NI
 Call 0844 571 5000
www.mirashowers.co.uk

For ROI
 Call Modern Plant on
 01 459 1344
www.mirashowers.ie

Choosing your shower

Step 1: What kind of water system do you have?

Low pressure gravity system



You'll know you have this system if:

There's a cold water tank in your loft and a hot water cylinder in your airing cupboard.

We recommend:

- Mixer showers (with optional pump for stronger flow)
- Digital mixer showers
- Power showers

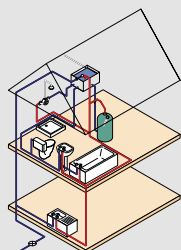

High pressure - mains pressure combination boiler



You'll know you have this system if:

You have a boiler the size of a small kitchen cupboard somewhere in your house – you won't have hot and cold water tanks.

We recommend:

- Mixer showers
- Digital mixer showers
- Energy-saving eco showers

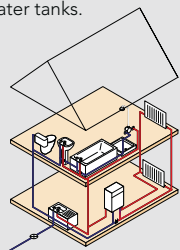

High pressure - mains pressure unvented



You'll know you have this system if:

You have a boiler the size of a small kitchen cupboard somewhere in your house.

We recommend:

- Mixer showers (for a powerful flow)
- Digital mixer showers (for a powerful flow)
- Energy-saving eco showers

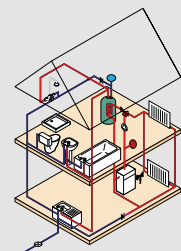

Cold mains supply



You'll know you have this system if:

You don't have stored hot water at all or, don't want to use up all the hot water when you have a shower.

We recommend:

- Electric showers (the higher the kW rating the stronger the flow)
- Pumped Mira Elite ST for low pressure cold water supplies*

*Must be tank fed

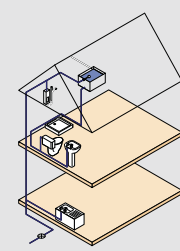

At a glance



Compatible with all systems.



Mains pressure combination boiler. Mains pressure unvented. Low pressure gravity with pump.



Low pressure gravity system.



Cold mains supply only.

NOTE: If in doubt, give us a call or contact a qualified plumber.

Step 2: What type of shower do you need?

If you're replacing a shower and you don't want to re-tile, it's worth checking the position of the hot and cold water pipes and the shape and size of the replacement shower. That way you'll be sure that the new shower fits over the old screw holes and onto the pipework. To make life easier, some of our mixer showers have adjustability on the inlet pipe centres.

Mixer showers

Mixer showers take water from both your hot and cold water supplies and mix it to create your ideal temperature.

- Most Mira mixers feature Magni-Flo™ which provides up to 3x more flow even on low pressure
- Optional Mira twin enduro pumps for low-pressure systems
- Range of styles and sizes
- Choice of temperature control – manual, pressure balanced or thermostatic
- Most mixers work on all water systems



Digital mixer showers

Digital mixers take water from your hot and cold supplies and mix it together. The digital technology ensures you enjoy the exact temperature, every time.

- Variants available for different systems
- Stabilises temperature digitally
- Additional warm up and lock off modes
- Easy to install
- Mixer unit can be mounted away from the shower, such as in the loft
- Reduced pipework
- Remote wireless control



Electric showers*

Electric showers take water from your cold water supply and warm it by passing it safely over heating elements contained within the unit.

- Works even if your boiler fails
- Works without the need for stored hot water
- All our electric showers are approved as water efficient because they use less water
- The pumped Mira Elite ST is available for low pressure systems



Power showers

Power showers take water from the stored hot and cold water supplies and mix it together to create your ideal temperature. All-in-one power showers have an in-built pump which also boosts the flow of water.

- Choose either an all-in-one or mixer shower and pump combination
- Perfect for homes with plenty of hot water
- Not suitable for high pressure systems



Eco showers

Our eco showers use flow regulators to limit the maximum flow of water, and our eco showerhead uses aerating technology to create the sensation of a normal, drenching flow while using a lot less water.

- Look for the BMA Water Efficiency logo and Waterwise marque

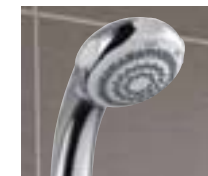

*If you're replacing an existing electric shower your installer will need to ensure that the installation complies with the latest wiring regulations.

Step 3: Our shower selector makes choosing easy

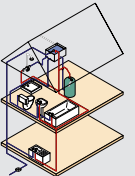

Low pressure gravity system
You'll have a cold water tank in your loft and a hot water cylinder in your airing cupboard.

Do you have a good supply of hot water, for example could you fill a bath?

YES Are you happy using some of your stored hot water for the perfect shower?

NO **WE RECOMMEND AN ELECTRIC SHOWER**

YES Showering is the most important part of my day.

NO I love showers, but I've got other things to do - like the washing up.

Do you take long showers or have lots of people queuing up to use it?

YES **WE RECOMMEND A MIXER SHOWER**
They give great performance but won't drain your hot water tank as fast as an all in one power shower

NO **WE RECOMMEND A MIXER SHOWER WITH A PUMP, A PUMPED DIGITAL SHOWER OR AN ALL IN ONE POWER SHOWER**

Is it important to be able to have a hot shower any time of the day?

NO I shower at regular times, when I know I'll always have hot water.

YES I grab a shower when I can, so I never know if I'll have hot water.

WE RECOMMEND A MIXER SHOWER OR PUMPED DIGITAL SHOWER
They take water from both your hot and cold supplies and mix it to create your perfect temperature

WE RECOMMEND MIRA ELITE ST
This is an electric shower with a difference. It has an internal pump, so you can use it on low pressure systems, and it heats the cold water supply as you use it

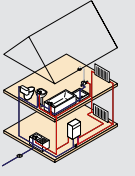

Mains pressure combination boiler
You'll have a boiler somewhere in your house, and you won't have hot or cold water tanks.

WE ALWAYS RECOMMEND A MIXER SHOWER OR A HIGH PRESSURE DIGITAL SHOWER
If you've got a combination boiler, always fit a mixer shower for great performance and the perfect shower experience

Need more help?
Call 0844 571 5000

For customers from the Republic of Ireland, call Modern Plant on 01 459 1344.

www.showeringperfection.co.uk

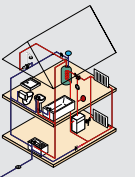

Mains pressure unvented system
You'll have a hot water cylinder in your airing cupboard but no cold water tank in your loft.

Are you happy using some of your stored hot water for the perfect shower?

YES Showering is the most important part of my day.

NO I love showers, but I've got other things to do - like the washing up.

Is it important to be able to have a hot shower any time of the day?

YES I grab a shower when I can, so I never know if I'll have hot water.

NO I shower at regular times, when I know I'll always have hot water.

WE RECOMMEND A MIXER SHOWER OR A HIGH PRESSURE DIGITAL SHOWER
They take water from both your hot and cold supplies and mix it to create your perfect temperature

WE RECOMMEND AN ELECTRIC SHOWER
They take water from your cold water mains supply and warm it by passing it safely over a heating element in the unit, so you won't use your hot water supply, and you can shower any time, day or night

WE RECOMMEND A MIXER SHOWER OR A HIGH PRESSURE DIGITAL SHOWER
They take water from both your hot and cold supplies and mix it to create your perfect temperature

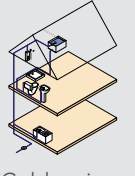

Cold mains supply
You won't have enough hot water, or don't want to use the hot water you have to shower.

Is your mains pressure reliable?

YES The pressure never changes.

NO The pressure can vary dramatically.

Would you prefer thermostatic control that gives great temperature stability?

YES **WE RECOMMEND A THERMOSTATIC ELECTRIC SHOWER**

NO **WE RECOMMEND AN ELECTRIC SHOWER**

WE RECOMMEND MIRA ELITE ST*
*Must be tank fed

Mixer showers

Mixer showers use water from both your hot and cold supplies then mix it to create your perfect temperature.

They're ideal if you have lots of hot water on tap and, if you have a high pressure system, a mixer shower should give you a more powerful flow than an electric one. On the other hand, if you have a low pressure system, you can boost the flow by adding a Mira shower pump (see page 65).

To find out what water system you have, turn to pages 7-8. Most Mira mixers work on all the common UK water systems, but it's important to check before installation.

Which temperature control?

Mixer showers have 3 different types of temperature control:

Manual – your shower will not compensate for changes in the incoming supply temperature or pressure and the shower temperature may change.

Pressure balancing – if you have a pressure balancing mixer, it will compensate for any change in water pressure and give you a constant showering temperature, provided the supply temperature remains constant.

Thermostatic – a thermostat constantly monitors the incoming water temperature and makes adjustments to keep the temperature constant. Thermostatic controls give you great temperature control and are ideal for people who are at risk such as the very young or elderly.

Pressed for space?

mini size maximum performance If space is an issue in your bathroom, look out for our 'Mini' symbol, shown on the left. This highlights our range of 'Mini' showers, which bring you the powerful performance of a mixer but with smaller valves.

Mixer shower contents

Mira Agile	17-18
Mira Agile Eco	19
Mira Agile Accessories	20
Mira Adept	21-22
Mira Adept Eco	23
Mira Adept Accessories	24
Mira Coda	25
Mira Coda Pro	26
Mira Coda Pro with Diverter	27
Mira Minilite	28
Mira Miniduo	29-30
Mira Minilite Eco	31
Mira Miniduo Eco	32
Mira Element	33-34
Mira Element SLT	35-36
Mira Silver	37-38
Mira Bijou	39
Mira Tabla	40
Mira Discovery Dual	41-42
Mira Discovery Concentric	43-44
Mira Discovery with Diverter	45-46
Mira Gem 88	47
Mira Combiforce 415	48
Mira Minibelle with 360 Showerhead	49-50
Mira Myline	51-52
Mira Miniluxe	53
Mira Miniluxe with Diverter	54
Mira Realm	55
Mira Realm with Diverter	55
Mira Montpellier	56
Mira Select	57-58
Mira Select Flex	59-60
Mira Excel	61-62
Mira Mode	63-64
Mira Twin Ended Pumps	65
Mira Extra and Mira Excel Bath Shower Mixers	66



Introducing Magni-Flo™ technology from Mira

Make your showering experience the very best it can be with our revolutionary Mira Magni-Flo™ technology.

The unique patented technology of Magni-Flo™ provides our mixers with up to 3 times more water flow than similar mixer showers*, even at low pressure. Making Mira Mixers the most powerful mixers available in the UK today.

*When tested under identical conditions against a range of similar mixers at 0.1 bar pressure, which is normal in homes with low pressure. Results show that mixers with Magni-Flo™ can give up to 3 times more flow than mixers from other shower companies.

To demonstrate the power of Magni-Flo™ here you can see a range of similar mixers all operating on a typical UK low pressure water system. Our Mira mixer with Magni-Flo™ delivers a significantly greater water flow compared to that of its competitors.



The impressive power of Magni-Flo™ also enables us to produce the only vertical valve on the market with the capability to spray from both showerheads at the same time at low pressure.



The high flow capacity combined with double the number of spray nozzles provides Mira mixers with far greater coverage. Giving you the ultimate shower spray experience.









View demo at:
www.mirashowers.co.uk/magni-flo

Mira mixer showers features and benefits

We have put together a handy guide to help you find your perfect mixer shower depending on the smart features and benefits you require. Simply take a look at the table below and select the features you need from your Mira mixer shower and then turn to the right page in the brochure where you can find out more.

Model	Page				
Mira Agile	17-18	✓	✓	-	-
Mira Agile Eco	19	✓	✓	✓	-
Mira Adept	21-22	✓	✓	✓	-
Mira Adept Eco	23	✓	✓	✓	-
Mira Coda	25	✓	-	-	-
Mira Coda Pro	26	✓	-	-	✓
Mira Coda Pro with Diverter	27	-	-	-	✓
Mira Minilite	28	✓	-	-	-
Mira Miniduo	29-30	✓	✓	-	-
Mira Minilite Eco	31	✓	-	✓	-
Mira Miniduo Eco	32	✓	-	✓	-
Mira Element	33-34	✓	-	-	-
Mira Element SLT	35-36	✓	-	✓	-
Mira Silver	37-38	✓	✓	-	-
Mira Bijou	39	✓	-	-	-
Mira Tabla	40	✓	-	-	-
Mira Discovery Dual	41-42	✓	✓	-	-
Mira Discovery Concentric	43-44	✓	✓	-	-
Mira Discovery with Diverter	45-46	✓	-	-	-
Mira Gem 88	47	-	-	-	-
Mira Combiforce 415	48	-	-	-	-
Mira Minibelle with 360 Showerhead	49-50	✓	✓	-	-
Mira Myline	51-52	✓	✓	-	✓
Mira Miniluxe	53	✓	✓	-	✓
Mira Miniluxe with Diverter	54	✓	✓	-	✓
Mira Realm	55	✓	-	-	-
Mira Realm with Diverter	55	✓	-	-	-
Mira Montpellier	56	✓	-	-	-
Mira Select	57-58	✓	✓	-	-
Mira Select Flex	59-60	✓	✓	-	-
Mira Excel	61-62	-	✓	-	-
Mira Mode	63-64	-	-	-	-

					
✓	-	✓	✓	-	✓
✓	-	✓	✓	-	✓
✓	-	✓	✓	-	✓
-	-	-	-	-	✓
-	-	-	-	-	✓
-	-	-	-	-	✓
-	-	✓	✓	-	✓
✓	-	-	-	-	✓
✓	-	-	-	-	✓
-	-	-	-	-	✓
-	-	-	-	-	✓
✓	-	-	-	-	✓
✓	-	-	-	-	✓
✓	-	-	-	-	✓
✓	-	-	-	-	✓
✓	-	-	-	-	✓
✓	-	-	-	-	✓
✓	-	-	-	-	✓
✓	-	-	-	-	✓
✓	-	-	-	-	✓
✓	✓	-	-	✓	✓
✓	✓	-	-	✓	✓
✓	✓	✓	-	-	✓
✓	✓	✓	✓	-	✓
✓	-	✓	-	-	✓
✓	✓	✓	✓	-	✓
✓	-	✓	✓	-	-
✓	-	-	-	-	✓
✓	✓	-	-	-	-
✓	-	-	-	-	✓
-	-	✓	-	-	-

Overview - mixer showers

We've got a wide range of designs to choose from. Some of these designs are available in different configurations – EV, BIR, BIV, ER and ERD, so you can choose the style and configuration to suit you.

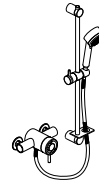

EV exposed variable
The shower control is mounted on the wall. Your shower comes with a showerhead, hose, clamp bracket and slide bar. Some models also come with a soap dish.



BIR built-in rigid
The controls and showerhead are both built into the wall. There's no hose or slide bar, so your shower has a minimalist look.



BIV built-in variable
The shower control is built into the wall for a smart, clean finish. The shower comes with a showerhead, hose, right-angled hose connector, clamp bracket and slide bar. Some models have a soap dish too.



ER exposed rigid
The shower control and showerhead are both mounted on the wall on a single riser bar.



ERD exposed rigid with diverter
The shower control and showerhead are both mounted on the wall on a single riser bar. The shower also has a second adjustable showerhead.



Mira Agile range
• S EV, EV & ERD
• Store EV+
• Sense EV+ & Sense ERD+
• Chrome
See pages 17-18.



Mira Agile Eco range
• S Eco EV & Eco EV
• Chrome
See page 19.



Mira Adept range
• BIV, BIR & BRD
• BIR+ & BRD+
• Chrome
See pages 21-22.



Mira Adept Eco range
• Eco BIV
• Chrome
See page 23.



Mira Coda & Diverter range
• EV & ERD
• Chrome
See pages 25-27.



Mira Minilite range
• EV & BIV
• Chrome
See page 28.



Mira Miniduo range
• EV & BIV
• Chrome
See pages 29-30.



Mira Minilite Eco range
• EV & BIV
• Chrome
See page 31.



Mira Discovery & Diverter
• Built-in valve
• Chrome
See pages 45-46.



Mira Gem 88 range
• EV, BIR & BIV
• Chrome
See page 47.



Mira Combiforce 415
• EV, BIR, BIV
• Chrome
See page 48.



Mira Minibelle with 360 showerhead
• EV
• Chrome
See pages 49-50.

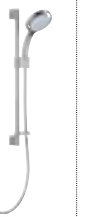

Mira Myline
• EV
• Chrome
See pages 51-52.



Mira Minilux
• ER
• Chrome
See page 53.



Mira Minilux with Diverter
Exposed valve with adjustable showerhead, chrome finish.
See page 54.



Mira Miniduo Eco range
• EV, BIR & BIV
• Chrome
See page 32.



Mira Element range
• EV, BIR & BIV
• Chrome
See pages 33-34.



Mira Element SLT range
• EV, BIR & BIV
• Chrome
See pages 35-36.



Mira Silver range
• EV, BIR & BIV
• Chrome
See pages 37-38.



Mira Bijou
• EV
• Chrome
See page 39.

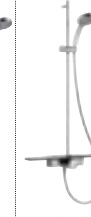

Mira Tabla
• EV
• Chrome
See page 40.

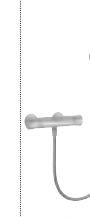

Mira Discovery Dual range
• EV, BIR & BIV
• Chrome
See pages 41-42.



Mira Discovery Concentric range
• EV, BIR & BIV
• Chrome
See pages 43-44.



Mira Realm/Realm with Diverter
• ER & ERD
• Chrome
See page 55.



Mira Montpellier ERD
Exposed valve with adjustable showerhead, chrome finish.
6" deluge head
8" deluge head
12" deluge head
See page 56.



Mira Select range
• EV, BIR & BIV
• Chrome
See pages 57-58.



Mira Select Flex
• EV
• Chrome
See pages 59-60.



Mira Excel range
• EV, BIR & BIV
• Chrome
See pages 61-62.



Mira Mode range
• BIR, ER
• Chrome
See pages 63-64.

Mira Agile

Expertly designed, this neat contemporary shower delivers a powerful showering experience in your new bathroom.



Mira Agile S EV
Exposed valve with adjustable fittings, chrome finish.
1.1736.401



Mira Agile ERD
Exposed valve with diverter, chrome finish.
1.1736.403



Mira Agile EV
Exposed valve with adjustable fittings, chrome finish.
1.1736.402



Mira Agile Store EV+
Exposed valve with adjustable fittings, chrome finish.
1.1736.413



Mira Agile Sense EV+
Exposed valve with adjustable fittings, chrome finish.
1.1736.412



Mira Agile Sense ERD+
Exposed valve with diverter, chrome finish.
1.1736.414



Product features

- Thermostatic temperature stability keeps showering safe for all the family
- Separate temperature and flow controls to fine tune your perfect shower (excludes Agile S EV which has one single control for on/off and temperature)
- Magni-Flo™ gives up to 3 times more flow than similar mixer showers even at low pressure
- Flush to wall unibody design eliminates conventional plumbing fixings for a beautifully smooth easy to clean form
- Revolutionary new installation system with 50mm pipe centres for quick and easy installation
- Compatible with patented Mira Agile plug-in accessories for ultimate flexibility – a world first! (excludes Agile S EV)
- Works on all systems and pressures
- 5 year guarantee

View demo at www.mirashowers.co.uk



Mira Agile Eco

Expertly designed, this neat contemporary shower delivers a great showering experience in your new bathroom whilst using up to 50% less water.



Mira Agile S Eco EV
Exposed valve with adjustable fittings, chrome finish.
1.1736.400



Mira Agile Eco EV
Exposed valve with adjustable fittings, chrome finish.
1.1736.422

Product features

- Thermostatic temperature stability keeps showering safe for all the family
- Mira Agile Eco EV - separate temperature and flow controls to fine tune your perfect shower
- Mira Agile S Eco EV - one single control for on/off and temperature
- Flush to wall unibody design eliminates conventional plumbing fixings for a beautifully smooth easy to clean form
- Saves up to 50% water compared to standard Agile S EV - meets code for sustainable homes requirements, whilst still maintaining a good showering experience
- Revolutionary new installation system with 50mm pipe centres for quick and easy installation
- Mira Agile Eco EV - Compatible with patented Mira Agile plug-in accessories for ultimate flexibility - a world first
- Multi-mode 90mm showerhead with rub-clean nozzles for easy limescale removal
- Minimum pressure required 0.5 bar
- 5 year guarantee

Mira Agile Accessories

The Mira Agile includes a range of optional accessories. Each one of these unique valve or wall mountable additions takes the showering experience to a completely new level.



Mira Agile Sense Module*
Digital display showing temperature for precise control. Integrates into the valve, displaying temperature and time, for precise control.
1.1736.421

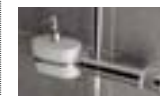

Mira Agile Cleanse Module
High quality handmade ceramic pumped dispenser. Compatible with the Mira Agile mixer shower, or as a stand-alone accessory.
1.1736.419

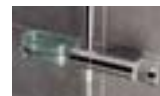

Mira Agile Store Module
Multi-function design, with the flexibility of a storage pot and soap dish. Compatible with the Mira Agile mixer shower, or as a stand-alone accessory.
1.1736.417



Mira Park Cleanse Module
Robust metal construction with chrome finish. Compatible with the Mira Agile mixer shower, or as a stand-alone accessory.
1.1736.420

Agile Sense Module features

- Auto updating radio controlled clock for accurate time display
- During showering, the display cycles between time and temperature
- Super long life battery
- Unique Mira patented design - a world first in showering

*Available early summer 2013

Agile Cleanse Module features

- Large capacity
- Robust metal support ring with chrome finish
- Unique Mira patented plug-in system connects directly to the Agile shower - a world first
- Wall mounting plate included for added flexibility

Agile Store Module features

- High quality glass effect plastic
- Robust metal support ring with chrome finish
- Unique Mira patented plug-in system connects directly to the Agile shower - a world first
- Wall mounting plate included for added flexibility

Agile Park Module features

- Unique Mira patented plug-in system connects directly to the Agile shower - a world first
- Wall mounting plate included for added flexibility
- Robust metal construction with chrome finish

Mira Adept

Carefully considered to combine a stylish, integrated look with great performance to deliver a perfect showering experience in your new bathroom.



Mira Adept BIV
Built-in valve with adjustable fittings, chrome finish.
1.1736.404



Mira Adept BIR
Built-in valve with fixed showerhead, chrome finish.
1.1736.405



Mira Adept BRD
Built-in valve with diverter, chrome finish.
1.1736.406



Mira Adept BIR+
Built-in valve with fixed showerhead, chrome finish.
1.1736.416



Mira Adept BRD+
Built-in valve with diverter, chrome finish.
1.1736.415

Product features

- Thermostatic temperature stability keeps showering safe for all the family
- Separate temperature and flow controls to fine tune your perfect shower
- Magni-Flo™ gives up to 3 times more flow than similar mixer showers even at low pressure
- Works on all systems and pressures
- 5 year guarantee
- Style matched accessories are available to complement your shower

View demo at:
www.mirashowers.co.uk



Mira Adept Eco

Carefully considered to combine a stylish, integrated look with great performance to deliver a perfect showering experience in your new bathroom whilst using up to 50% less water.



Mira Adept Eco BIV
Built-in valve with adjustable fittings, chrome finish.
1.1736.423



Product features

- Thermostatic temperature stability keeps showering safe for all the family
- Separate temperature and flow controls to fine tune your perfect shower
- Saves up to 50% water compared to standard Adept BIV – meets code for sustainable homes requirements, whilst still maintaining a good showering experience
- Style matched accessories are available to complement your shower
- Minimum pressure required 0.5 bar
- 5 year guarantee

Mira Adept Accessories

The Mira Adept includes a range of optional accessories. Each one of these unique valve mountable additions takes the showering experience to a completely new level.



Mira Adept Cleanse Module
High quality handmade ceramic pumped dispenser. Compatible with Mira Adept BRD models.
1.1736.424



Mira Adept Store Module
Multi-function design, with the flexibility of a storage pot and soap dish. Compatible with Mira Adept BRD models.
1.1736.418



Adept Cleanse Module features

- Distinctive modern design and added functionality to your showering space
- Robust metal support ring with chrome finish
- Unique Mira patented plug-in system connects directly to the Adept BRD and BRD+ showers - a world first

Adept Store Module features

- A modern high quality storage solution, adds convenience to your showering space.
- High quality glass effect plastic
- Robust metal support ring with chrome finish
- Unique Mira patented plug-in system connects directly to the Adept BRD and BRD+ showers - a world first

Mira Coda

Great shower. Great price. Mira Coda offers intuitive design and a great performance at an affordable price.



Mira Coda EV
Exposed valve with adjustable fittings, chrome finish.
2.1630.001

3 SPRAYS



Easy to fit optional extras



Bar valve exposed pipework installation elbows

The solution for installing any bar valve with exposed pipework:

- Fits any bar valve
- Built-in adjustability
- Easy to install and service
- Can accommodate pipework from any direction
- Concealed wall mounting

1.1712.002



Bar valve fixing kit

The fastest, easiest and most flexible way to install any bar valve:

- Fits any bar valve
- Built-in adjustability
- Easy to install
- Provides a solid wall fixing, even with loose pipework
- Watertight fit with the tiles

2.1663.017

Product features

- Thermostatic temperature stability keeps showering safe for all the family
- Maximum temperature stop for increased safety – with override for a hotter shower
- Separate temperature and flow controls to fine tune your perfect shower
- 3 spray showerhead with rub-clean nozzles for easy limescale removal

- Separate accessories available to make installation even easier
- Works on all systems and pressures
- 5 year guarantee

Mira Coda Pro

Easy to fit. Easy on the pocket. Mira Coda Pro offers performance at a fantastic price, and its easy to fit features make it a hit with installers.



Mira Coda Pro
Exposed valve with easy fit bar valve system.
2.1744.007

1 SPRAY



Product features

- Thermostatic temperature stability keeps showering safe for all the family
- Maximum temperature stop for increased safety – with override for a hotter shower
- Eco-flow function with override button for full flow

- Separate temperature and flow controls to fine tune your perfect shower
- Single spray showerhead with rub-clean nozzles for easy limescale removal

- Works on all systems and pressures - genuine performance from 0.1bar
- 5 year guarantee

Mira Coda Pro with Diverter

Raising the bar in showering performance. Mira Coda Pro with Diverter offers great performance at a fantastic price, with the added luxury of a deluge head and separate handshower.

2 SPRAYS



Mira Coda ERD
Exposed valve with
Diverter, chrome finish.
1.1744.018



Mira Minilite

Mini size. Maximum performance. Beautifully compact, it may be small but it really packs a punch.

1 SPRAY



Choose from the following configurations:



mini size
maximum
performance

Mira Minilite EV
Exposed valve with
adjustable fittings,
chrome finish.
1.1663.003



mini size
maximum
performance

Mira Minilite BIV
Built-in valve with
adjustable fittings,
chrome finish.
1.1663.007

Product features

- Thermostatic temperature stability keeps showering safe for all the family
- Separate temperature and flow controls to fine tune your perfect shower
- Easy to use flow and temperature override buttons let you increase either flow or temperature
- Divert between the overhead and hand held shower or have both heads on at once*
- Single spray 18.5cm deluge fixed showerhead with rub clean rubber nozzles for easy cleaning, plus separate 9cm showerhead
- Works on all systems and pressures - genuine performance from 0.1 bar
- 5 year guarantee
- * 0.25 bar minimum pressure required when running both outlets together

Product features

- Thermostatic temperature stability keeps showering safe for all the family
- One easy to use control for on/off and temperature
- Magni-Flo™ gives up to 3 times more flow than similar mixer showers even at low pressure
- Half the size of a normal mixer, helps save space in the bathroom
- EV models come with 110mm pipe centres
- Optional extended elbows pack is available for existing pipework between 133-153mm
- Single spray showerhead with rub-clean nozzles for easy limescale removal
- Works on all systems and pressures
- 3 year guarantee

View demo at:
www.mirashowers.co.uk/magni-flo



Mira Miniduo

Small on the outside. Big on the inside. It may be small on size but when it comes to features, it really packs a punch.

4 SPRAYS



Choose from the following configurations:



mini size
maximum
performance

Mira Miniduo EV
Exposed valve with adjustable fittings, chrome finish.
1.1663.004



mini size
maximum
performance

Mira Miniduo BIV
Built-in valve with adjustable fittings, chrome finish.
1.1663.008

Product features

- Thermostatic temperature stability keeps showering safe for all the family
- Separate temperature and flow controls to fine tune your perfect shower
- Magni-Flo™ gives up to 3 times more flow than similar mixer showers even at low pressure
- Half the size of a normal mixer, helps save space in the bathroom
- EV models come with 110mm pipe centres
- Optional extended elbows pack is available for existing pipework between 133-153mm
- 4 spray showerhead with rub-clean nozzles for easy limescale removal
- Works on all systems and pressures
- 3 year guarantee

View demo at: www.mirashowers.co.uk/magni-flo



Mira Minilite Eco

Save water. Save money. Our Minilite Eco saves up to 50% water compared to a standard Minilite, yet still delivers great performance – you could call it the greener way to get cleaner.

1 SPRAY



Choose from the following configurations:



mini size
maximum
performance

Mira Minilite EV Eco

Exposed valve with adjustable fittings and 6L flow regulator, chrome finish.

1.1663.239



mini size
maximum
performance

Mira Minilite BIV Eco

Built-in valve with adjustable fittings and 6L flow regulator, chrome finish.

1.1663.240

Product features

- Thermostatic temperature stability keeps showering safe for all the family
- One easy to use control for on/off and temperature
- Saves up to 50% water compared to standard Minilite
- Approved by the BMA and Waterwise as a water efficient product
- EV models come with 110mm pipe centres
- Optional extended elbows pack is available for existing pipework between 133-153mm

- Single spray showerhead with rub-clean nozzles for easy limescale removal
- Minimum pressure required 0.5 bar
- 3 year guarantee

Mira Miniduo Eco

Save water. Save money. Our Miniduo Eco with Ecoefficient™ technology saves up to 75% water compared to a standard Miniduo, yet still delivers a great performance – you could call it the greener way to get cleaner.

3 SPRAYS



Choose from the following configurations:



mini size
maximum
performance

Mira Miniduo EV with Eco showerhead

Exposed valve with adjustable fittings, chrome finish.

1.1663.241



mini size
maximum
performance

Mira Miniduo BIV with Eco showerhead

Built-in valve with adjustable fittings, chrome finish.

1.1663.242



mini size
maximum
performance

Mira Miniduo BIR with Eco showerhead

Built-in valve with fixed showerhead, chrome finish.

1.1663.243

Product features

- Thermostatic temperature stability keeps showering safe for all the family
- Separate temperature and flow controls to fine tune your perfect shower
- 3 spray Mira Eco showerhead saves up to 75% water compared to standard Miniduo at 0.5 bar pressure
- Approved by the BMA and Waterwise as a water efficient product
- EV models come with 110mm pipe centres
- Optional extended elbows pack is available for existing pipework between 133-153mm

- Minimum pressure required 0.5 bar
- 3 year guarantee

View demo at:
www.mirashowers.co.uk/ecoshowerhead



Mira Element

Simply affordable. Enjoy showering simplicity with an easy to use single control. You'll love the price too.

4 SPRAYS



Choose from the following configurations:



Mira Element EV
Exposed valve with adjustable fittings, chrome finish.
1.1656.001



Mira Element BIR
Built-in valve with fixed showerhead, chrome finish.
1.1656.003



Mira Element BIV
Built-in valve with adjustable fittings, chrome finish.
1.1656.002

Product features

- Thermostatic temperature stability keeps showering safe for all the family
- 1 easy to use control for on/off and temperature
- Magni-Flo™ gives up to 3 times more flow than similar mixer showers even at low pressure
- 4 spray showerhead with rub-clean nozzles, or a fixed single spray showerhead depending on the model you choose
- Works on all systems and pressures
- 5 year guarantee

View demo at:
www.mirashowers.co.uk/magni-flo



Mira Element SLT

Lift, twist and shower. The best performing single lever mixer shower on the market. You can fine-tune the settings easily to create your perfect shower every time.

5 SPRAYS



Choose from the following configurations:



Mira Element SLT EV
Exposed valve with adjustable fittings, chrome finish.
1.1656.011



Mira Element SLT BIR
Built-in valve with fixed showerhead, chrome finish.
1.1656.013



Mira Element SLT BIV
Built-in valve with adjustable fittings, chrome finish.
1.1656.012

Intuitive single lever control

Rotate for temperature control



Lift for flow control



The Element SLT has one simple lever that puts you in complete control of flow and temperature.

Product features

- Thermostatic temperature stability keeps showering safe for all the family
- With 'Lift and Twist' technology, one single lever control for flow and temperature
- Magni-Flo™ gives up to 3 times more flow than similar mixer showers even at low pressure
- Eco flow function uses up to 30% less water
- 11cm 5 spray showerhead with rub-clean nozzles, or a single spray deluge showerhead depending on the model you choose
- Works on all systems and pressures
- 5 year guarantee

View demo at: www.mirashowers.co.uk/magni-flo



Mira Silver

Beautifully simple in every way. Bringing both thermostatic temperature and flow control onto one simple to use dial, it makes showering beautifully simple, and stunningly affordable.

4 SPRAYS



Choose from the following configurations:



Mira Silver EV
Exposed valve with adjustable fittings, chrome finish.
1.1628.001



Mira Silver BIR
Built-in valve with fixed showerhead, chrome finish.
1.1628.002



Mira Silver BIV
Built-in valve with adjustable fittings, chrome finish.
1.1628.002

Product features

- Thermostatic temperature stability keeps showering safe for all the family
- Maximum temperature stop for increased safety
- One easy to use control for on/off and temperature
- Magni-Flo™ gives up to 3 times more flow than similar mixer showers even at low pressure
- 4 spray showerhead with rub-clean nozzles, or a fixed single spray showerhead depending on the model you choose
- Works on all systems and pressures
- 5 year guarantee

View demo at www.mirashowers.co.uk/magni-flo



Mira Bijou

Neat design. Neat bathroom. Cleverly designed with an integrated shelf to keep your bathroom clutter free and looking great.

1 SPRAY



Mira Bijou
Exposed valve with adjustable fittings, chrome finish.
1.1672.001



Product features

- Thermostatic temperature stability keeps showering safe for all the family
- One easy to use control for on/off and temperature
- Magni-Flo™ gives up to 3 times more flow than similar mixer showers even at low pressure
- 300mm shelf made of 10mm thick toughened glass

- Single spray showerhead with rub-clean nozzles for easy limescale removal
- Works on all systems and pressures
- 3 year guarantee

View demo at www.mirashowers.co.uk/magni-flo



Mira Tabla

Stylish storage. Sleek look. Contemporary design and a clever integrated shelf keep your bathroom clutter free and looking great.

5 SPRAYS



Mira Tabla
Exposed valve with adjustable fittings, chrome finish.
1.1672.010

Product features

- Thermostatic temperature stability keeps showering safe for all the family
- One easy to use control for on/off and temperature
- Magni-Flo™ gives up to 3 times more flow than similar mixer showers even at low pressure

- 500mm shelf made of 10mm thick toughened glass
- Integrated slide bar for a sleek look
- 5 spray showerhead with rub-clean nozzles for easy limescale removal

- Works on all systems and pressures
- 3 year guarantee

View demo at www.mirashowers.co.uk/magni-flo



Mira Discovery Dual

Discover great showering. Its sleek design will enhance any bathroom whilst delivering an invigorating shower every time.

4 SPRAYS



Choose from the following configurations:



Mira Discovery Dual EV
Exposed valve with adjustable fittings, chrome finish.
1.1609.001



Mira Discovery Dual BIR
Built-in valve with fixed showerhead, chrome finish.
1.1609.003



Mira Discovery Dual BIV
Built-in valve with adjustable fittings, chrome finish.
1.1609.002

Product features

- Thermostatic temperature stability keeps showering safe for all the family
- Maximum temperature stop for increased safety
- Magni-Flo™ gives up to 3 times more flow than similar mixer showers even at low pressure*
- Separate temperature and flow controls to fine tune your perfect shower
- 4 spray showerhead with rub-clean nozzles, or a fixed single spray showerhead depending on the model you choose
- Works on all systems and pressures
- 5 year guarantee

*Not available on Mira Discovery



Mira Discovery Concentric

Discover great showering. Stunningly sleek looks and a great performance.

4 SPRAYS



Choose from the following configurations:



Mira Discovery Concentric EV
Exposed valve with adjustable fittings, chrome finish.
1.1595.001



Mira Discovery Concentric BIR
Built-in valve with fixed showerhead, chrome finish.
1.1595.003



Mira Discovery Concentric BIV
Built-in valve with adjustable fittings, chrome finish.
1.1595.002

Product features

- Thermostatic temperature stability keeps showering safe for all the family
- Maximum temperature stop for increased safety
- Separate temperature and flow controls to fine tune your perfect shower
- Magni-Flo™ gives up to 3 times more flow than similar mixer showers even at low pressure
- Works on all systems and pressures
- 3 year guarantee



View demo at www.mirashowers.co.uk/magni-flo



Mira Discovery & Diverter

One great shower, two ways to enjoy it. Stylishly understated, the Diverter valve gives you the flexibility to combine it with any two water outlets, the choice is yours.

4 SPRAYS



Choose 2 from the following accessories to be added to your Mira Discovery & Diverter:



Mira Discovery & diverter**
Built-in valve with Diverter, chrome finish.
1.1691.001



Mira Discovery fittings kit*
Chrome finish.
2.1605.151



Mira Discovery fixed spray showerhead*
Chrome finish.
1.1595.244



Wall mounted bath filler*
1.1605.147



Overflow bath filler*
1.1605.140

Product features

- Thermostatic temperature stability keeps showering safe for all the family
- Maximum temperature stop for increased safety
- Two way diverter valve for ultimate versatility
- Magni-Flo™ gives up to 3 times more flow than similar mixer showers even at low pressure
- Choose a combination of any two water outlets from our selection of overhead showers, hand showers and bath fills
- Works on all systems and pressures
 - * 1 year guarantee
 - ** 3 year guarantee

View demo at:
www.mirashowers.co.uk/magni-flo



Mira Gem 88

Simply reliable. A refreshingly reliable performance, with clever anti-limescale technology.

3 SPRAYS



Choose from the following configurations:



Mira Gem 88 BIR
Built-in valve with fixed showerhead, chrome finish.
1.1557.005



Mira Gem 88 EV
Exposed valve with adjustable fittings, chrome finish.
1.1557.001



Mira Gem 88 BIV
Built-in valve with adjustable fittings, chrome finish.
1.1557.003

Product features

- Separate temperature and flow controls to fine tune your perfect shower
- Magni-Flo™ gives up to 3 times more flow than similar mixer showers even at low pressure
- Clearscale™ technology cuts limescale by half for a better performing, longer lasting shower
- Easy one hand adjustment of showerhead height

- 3 spray showerhead with rub-clean nozzles for easy limescale removal
- Built for low pressure systems
- 1 year guarantee

View demo at:
www.mirashowers.co.uk/magni-flo



Mira Combiforce 415

The perfect shower for combi-boiler owners. Pressure balancing technology makes the Mira Combiforce the perfect shower for combi-boiler owners.

3 SPRAYS



Choose from the following configurations:



Mira Combiforce 415 BIR
Built-in valve with fixed showerhead, chrome finish.
1.1542.009



Mira Combiforce 415 EV
Exposed valve with adjustable fittings, chrome finish.
1.1542.001



Mira Combiforce 415 BIV
Built-in valve with adjustable fittings, chrome finish.
1.1542.005

Mira Combiforce 415 BIV
Built-in valve with adjustable fittings, white/chrome finish.
1.1542.007

Product features

- Pressure balancing technology keeps the temperature constant, even if a tap is turned on elsewhere
- Maximum temperature stop for increased safety

- One easy to use control for on/off and temperature
- Magni-Flo™ gives up to 3 times more flow than similar mixer showers even at low pressure

- 3 spray showerhead with rub-clean nozzles for easy limescale removal
- 1 year guarantee

View demo at:
www.mirashowers.co.uk/magni-flo



Mira Minibelle with 360 Showerhead

It might be small, but it really packs a punch. Our high-performance upright valve and the ultimate in mini showers now includes the Mira 360 showerhead – 1 flip action, 4 unique sprays.

4 SPRAYS

SUITABLE FOR ALL SYSTEMS

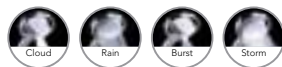

mini size
maximum
performance

Mira Minibelle with 360 showerhead
Exposed valve with adjustable fittings, chrome finish.
1:1660.016



Product features

- Thermostatic temperature stability keeps showering safe for all the family
- Separate temperature and flow controls to fine tune your perfect shower
- Magni-Flo™ gives up to 3 times more flow than similar mixer showers even at low pressure
- Best performing vertical valve on the market
- Cool Shield™ technology means the valve doesn't get hot during a shower
- Includes the Mira 360 showerhead featuring Flipstream™ technology - 1 flip action, 4 unique sprays
- Works on all systems and pressures
- 3 year guarantee



View demo at:
www.mirashowers.co.uk/360



Mira Myline

Streamlined showering. A unique showering solution offering a great performance even at low pressure.

4 SPRAYS

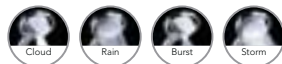

Mira Myline
Exposed valve with adjustable fittings, chrome finish.
1.1660.017

Product features

- Thermostatic temperature stability keeps showering safe for all the family
- Separate temperature and flow controls to fine tune your perfect shower
- Magni-Flo™ gives up to 3 times more flow than similar mixer showers even at low pressure
- Best performing vertical valve on the market
- Fully integrated shower pole for a streamlined look
- Cool Shield™ technology means the valve doesn't get hot during a shower
- Includes the Mira 360 showerhead featuring Flipstream™ technology - 1 flip action, 4 unique sprays
- Works on all systems and pressures - genuine performance from 0.1bar
- 5 year guarantee

View demo at:
www.mirashowers.co.uk/360



Mira Miniluxe

Mini size. Maximum performance. Iconically designed; the fully rigid riser and 18.5cm deluge showerhead make a real statement.

1 SPRAY



mini size
maximum
performance

Mira Miniluxe ER
Exposed valve with
fixed showerhead,
chrome finish.
1:1660.007



Product features

- Thermostatic temperature stability keeps showering safe for all the family
- Separate temperature and flow controls to fine tune your perfect shower
- Magni-Flo™ gives up to 3 times more flow than similar mixer showers even at low pressure
- Best performing vertical valve on the market
- All models come with a rigid riser bar for that contemporary look
- Cool Shield™ technology means the valve doesn't get hot during a shower
- Single spray 18.5cm deluge showerhead with rub-clean nozzles for easy limescale removal
- Works on all systems and pressures
- 3 year guarantee

View demo at:
www.mirashowers.co.uk/magni-flo



Mira Miniluxe with Diverter

Mini size. Maximum flexibility. Iconically designed; the fully rigid riser and fixed deluge overhead shower coupled with a hand held diverter showerhead make a real statement.

2 SPRAYS



mini size
maximum
performance

**Mira Miniluxe with
diverter ERD**
Exposed valve with
rigid riser and diverter,
chrome finish.
1:1660.015



Product features

- Thermostatic temperature stability keeps showering safe for all the family
- Separate temperature and flow controls to fine tune your perfect shower
- Magni-Flo™ gives up to 3 times more flow than similar mixer showers even at low pressure
- Best performing vertical valve on the market
- Divert between the overhead and hand held shower or have both heads on at once, even at low pressure
- All models come with a rigid riser bar for that contemporary look
- Cool Shield™ technology means the valve doesn't get hot during a shower
- Single spray 18.5cm deluge showerhead with rub-clean nozzles plus single spray handset
- Works on all systems and pressures
- 3 year guarantee

View demo at:
www.mirashowers.co.uk/magni-flo



Mira Realm and Mira Realm with Diverter

Classically designed with a rigid riser, deluge showerhead and hand held shower option. Mira Realm offers traditional styling with modern showering technology and performance.

1 SPRAY

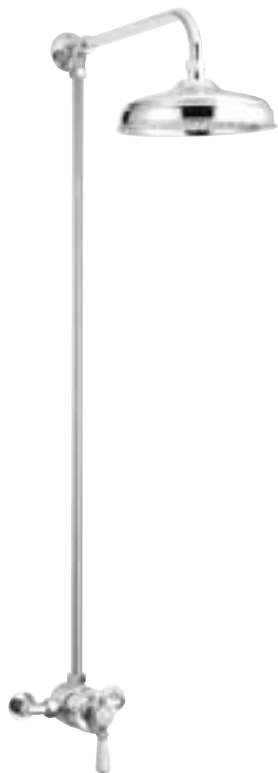

Mira Realm
Exposed valve with rigid riser.
1.1735.001



Mira Realm with diverter
Exposed valve with rigid riser and diverter, chrome finish.
1.1735.002

Product features

- Thermostatic temperature stability keeps showering safe for all the family
- Magni-Flo™ gives up to 3 times more flow than similar mixer showers even at low pressure
- Maximum temperature stop for increased safety
- One easy to use control for on/off and temperature
- Choose the height you want to shower at, the rigid riser bar height can be cut to length during installation
- Large 21cm deluge head for an unbeatable showering experience
- Deluge head has rub-clean rubber nozzles for easy limescale removal
- Divert between the overhead and hand held shower or have both heads on at once, even at low pressure

- Separate 8cm single spray hand shower with rub-clean rubber nozzles for easy limescale removal, hand shower only
- Works on all systems and pressures
- 5 year guarantee

View demo at: www.mirashowers.co.uk/magni-flo



Mira Montpellier

Big really is beautiful. Delivering a full, drenching flow through the fixed overhead shower, with the added flexibility of a handy diverter shower.

1 SPRAY



Mira Montpellier ERD
Exposed valve with adjustable showerhead, chrome finish.
6" deluge head
1.0.437.22.1
8" deluge head
1.0.437.21.1
12" deluge head
1.0.437.20.1



Product features

- Thermostatic temperature stability keeps showering safe for all the family
- Maximum temperature stop for increased safety
- One easy to use control for on/off and temperature
- Magni-Flo™ gives up to 3 times more flow than similar mixer showers even at low pressure
- Divert between the overhead and hand held shower or have both heads on at once, even at low pressure
- 15cm, 20cm or 30.5cm deluge showerheads available
- Works on all systems and pressures (20cm & 30.5cm deluge heads require at least 0.2 bar pressure)
- 1 year guarantee

View demo at: www.mirashowers.co.uk/magni-flo



Mira Select

Perfect for the style and safety conscious. With stylish looks, thermostatic control and great performance at low pressures, it is a fantastic choice for any bathroom and is safe for all the family.

4 SPRAYS



Choose from the following configurations:



Mira Select BIR
Built-in valve with fixed showerhead, chrome finish.
1.1592.007



Mira Select EV
Exposed valve with adjustable fittings, chrome finish.
1.1592.005



Mira Select BIV
Built-in valve with adjustable fittings, chrome finish.
1.1592.006

Product features

- Thermostatic temperature stability keeps showering safe for all the family
- Maximum temperature stop for increased safety
- Separate temperature and flow controls to fine tune your perfect shower
- Magni-Flo™ gives up to 3 times more flow than similar mixer showers even at low pressure
- Works on all systems and pressures
- 2 year guarantee



View demo at www.mirashowers.co.uk/magni-flo



Mira Select Flex

Perfect for the style and safety conscious. Designed to be amazingly flexible, the fantastic Select Flex has large, easy to use levers with highly visible graphics for great looks and extra safety.

1 SPRAY



Mira Select Flex
Exposed valve with adjustable fittings, chrome finish.
1.1679.001



Product features

- Thermostatic temperature stability keeps showering safe for all the family
- Maximum temperature stop for increased safety
- Separate temperature and flow controls to fine tune your perfect shower
- Developed in conjunction with the RNIB
- Magni-Flo™ gives up to 3 times more flow than similar mixer showers even at low pressure
- Easy to glide showerhead with extra long slide bar and hose for greater flexibility
- Slide bar can be corner mounted – ideal for smaller spaces
- An extra separate showerhead holder is available
- Cool Shield™ technology means the valve doesn't get hot during a shower

- Single spray Mira Everclear showerhead keeps limescale at bay
- Works on all systems and pressures
- 5 year guarantee

View demo at:
www.mirashowers.co.uk/magni-flo



Mira Excel

The UK's best selling mixer shower. Packed with features Excel is our best performing mixer and is the choice of the professional installer.

4 SPRAYS



Choose from the following configurations:



Mira Excel EV
Exposed valve with adjustable fittings, chrome finish.
1.1518.300



Mira Excel BIR
Built-in valve with fixed showerhead, chrome finish.
1.1518.307



Mira Excel BIV
Built-in valve with adjustable fittings, chrome finish.
1.1518.303

Product features

- Thermostatic temperature stability keeps showering safe for all the family
- Maximum temperature stop for increased safety – with override for a hotter shower
- Separate temperature and flow controls to fine tune your perfect shower
- Numbered temperature dial for set and forget control
- Magni-Flo™ gives up to 3 times more flow than similar mixer showers even at low pressure
- Unrivalled performance on any water system, even low pressure
- A ceramic flow control keeps limescale at bay - ideal if you have hard water

- 4 spray showerhead with rub-clean nozzles for easy limescale removal
- Works on all systems and pressures
- 5 year guarantee

View demo at www.mirashowers.co.uk/magni-flo



Excel accessorised with Mira 360 showerhead, fittings sold separately.

Mira Mode

Classically invigorating. A contemporary take on a classic design, delivering a truly invigorating shower from its huge deluge showerhead.

1 SPRAY



Choose from the following configurations:



Mira Mode BIR
Built-in valve with fixed showerhead, chrome finish.
1.0.437.61.1



Mira Mode ER
Exposed valve with fixed showerhead, chrome finish.
1.0.437.60.1

Product features

- Thermostatic temperature stability keeps showering safe for all the family
- Maximum temperature stop for increased safety
- One easy to use control for on/off and temperature
- Magni-Flo™ gives up to 3 times more flow than similar mixer showers even at low pressure
- Single spray 20cm deluge showerhead
- Works on all systems and pressures
- 1 year guarantee

View demo at: www.mirashowers.co.uk/magni-flo



Mira Twin Ended Pumps

Domestic twin impeller inlet shower pump simultaneously boosts hot and cold supplies.



Mira 1.5 bar Twin Ended Pump*
Domestic twin impeller inlet shower pump used to simultaneously boost hot and cold supplies to a single shower, white/black.
2.1745.001

Mira 2.0 bar Twin Ended Pump*
Domestic twin impeller inlet shower pump used to simultaneously boost hot and cold supplies to a single shower, white/black.
2.1745.002



Mira 3.0 bar Twin Ended Pump**
Domestic twin impeller inlet shower pump used to simultaneously boost hot and cold supplies to the whole bathroom, black/gold.
2.1745.003

Product features

- Generates flow rate of up to 30 litres per minute (1.5 bar Pump only)
- Supplied with 4 x 300mm braided flexible connectors each featuring push-fit connector (3.0 bar Pump only)
- Generates flow rate of up to 32 litres per minute (2.0 bar Pump only)
- Generates flow rate of up to 60 litres per minute (3.0 bar Pump only)
- Supplied with 4 x 190mm braided flexible connectors each featuring push-fit connector (1.5 and 2.0 bar Pumps only)
- Quiet continuously rated motor
- Integral flow switch for automatic operation

* 2 year guarantee
** 3 year guarantee

Mira Extra and Mira Excel bath shower mixers

A thermostatically controlled shower combined with bathfill (thermostatic bathfill on Mira Excel only) and a choice of 3 spray patterns for practical and enjoyable showering. An easy to install alternative to a wall mounted shower.

4 SPRAYS

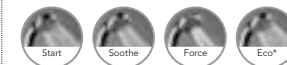

Mira Extra bath shower mixer with adjustable showerhead
White/chrome finish.
1.0.122.25.2



Mira Excel bath shower mixer with adjustable showerhead
White/chrome finish.
1.1598.001

Product features

- Thermostatic temperature control ensuring a constant and comfortable showering experience
- Separate flow and temperature controls
- Automatic maximum temperature reduction when user switches from bath to shower mode*
- Four spray showerhead with rub-clean rubber nozzles for easy cleaning*
- Unique inner sleeve reduces surface temperature for even more safety*
- Three spray showerhead with partial rub-clean rubber nozzles for easy cleaning**
- Approved to TMV2 standards – the highest domestic accolade for thermostatic temperature stability*
- For installation on the top of the bath
- Mira Excel BSM 5 year guarantee
- Mira Extra BSM 1 year guarantee

* Excel bath shower mixer only.
** Extra bath shower mixer only.



Digital showers

Digital showers are similar to mixer showers as they take water from both your hot and cold water supplies and then mix it to give you your ideal temperature.

However, there's one crucial difference. A digital shower uses a separate mixer unit and shower controls so you can mount the slim mixer unit away from the shower in an area which has easy access for servicing, such as a loft or even under some baths. This reduces the amount of pipework needed to install the shower, and means the shower controls take up less space in your shower area.

Our digital showers also come with a range of additional features:

- A warm-up feature, which gently heats the water to your ideal temperature, then switches the flow off until you're ready to get in.
- A timing feature, so you can set your precise showering time, saving energy and water.

Suitable for all water systems

All our digital showers come with a choice of either a high pressure digital valve specifically designed for mains pressure water systems or a pumped version for use on low pressure gravity systems, making Mira digital showers suitable for every home.

Digital shower contents

Mira Vision	71-72
Mira Platinum	73-74

Mira digital showers features and benefits

We have put together a handy guide to help you find your perfect digital shower depending on the smart features and benefits you require. Simply take a look at the table below and select the features you need from your Mira digital shower and then turn to the relevant page in the brochure where you can find out more.

Model	Page						
Mira Vision	71-72	✓	✓	✓	✓	✓	✓
Mira Platinum	73-74	✓	✓	✓	✓	✓	✓

Model	Page					
Mira Vision	71-72	✓	✓	✓	✓	✓
Mira Platinum	73-74	✓	✓	✓	✓	✓

Overview - digital mixer showers

We've got a range of stylish digital shower controls to choose from, including high pressure, pumped, rear and ceiling fed, BIR, UV and a bath fill option. If you would like more information on our digital mixer range please call us on **0844 571 5000** or visit **www.mirashowers.co.uk**, for customers from the Republic of Ireland please call Modern Plant on **01 459 1344** or visit **www.mirashowers.ie**



Mira Vision EV – rear fed

- Chrome fittings
- Combination pack, digital mixer included

See pages 71-72.



Mira Vision EV – ceiling fed

- Chrome fittings
- Combination pack, digital mixer included

See pages 71-72.



Mira Platinum EV – rear fed

- Chrome fittings
- Combination pack, digital mixer included

See pages 73-74.



Mira Platinum EV – ceiling fed

- Chrome fittings
- Combination pack, digital mixer included

See pages 73-74.

Mira Vision

One day all showers will be like this. Experience a new way of showering with the Mira Vision digital mixer shower. With its ultramodern design, wireless controller and ground breaking digital technology, it's the future of showering.

4 SPRAYS

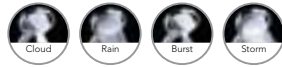

Mira Vision
Surface mounted model, rear fed digital shower, chrome finish.
High pressure
1.1797.003
Pumped
1.1797.004



Mira Vision
Surface mounted model, ceiling fed digital shower, chrome finish.
High pressure
1.1797.001
Pumped
1.1797.002

Product features

- Thermostatic temperature stability keeps showering safe for all the family
- Separate temperature and flow controls to fine tune your perfect shower
- Programmable functions to suit your lifestyle: temperature setting, warm-up mode, clock display and eco setting
- Wireless controller remotely controls the flow and temperature
- Additional controller available, enables control from a second location
- Quick, flexible and easy to install
- Ceiling or rear fed options
- High-pressure valve for mains pressurised systems or combination boilers
- Pumped valve for low pressure or gravity fed systems

- Includes Mira 360 showerhead featuring Flipstream™ technology – 1 flip action, 4 unique sprays
- Chrome finish
- 5 year guarantee

View demo at:
www.mirashowers.co.uk/360



Digital showers

Digital showers

Mira Platinum

It wakes up while you're still snoozing. Beautifully designed and easy to use, this wireless digital shower has got it all - innovation and great looks.

4 SPRAYS

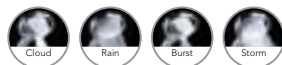

Mira Platinum
Surface mounted model, rear fed digital shower, chrome finish.
High pressure
1.1666.200
Pumped
1.1666.201



Mira Platinum
Surface mounted model, ceiling fed digital shower, chrome finish.
High pressure
1.1666.001
Pumped
1.1666.002

Product features

- Thermostatic temperature stability keeps showering safe for all the family
- Separate temperature and flow controls to fine tune your perfect shower
- Programmable functions to suit your lifestyle: temperature setting, warm-up mode, clock display and eco setting
- Wireless controller remotely controls the flow and temperature
- Additional controller available, enables control from a second location
- Quick, flexible and easy to install
- Ceiling or rear fed options
- High-pressure valve for mains pressurised systems or combination boilers
- Pumped valve for low pressure or gravity fed systems

- Includes Mira 360 showerhead featuring Flipstream™ technology – 1 flip action, 4 unique sprays
- Black/chrome finish
- 5 year guarantee

View demo at:
www.mirashowers.co.uk/platinum





Electric showers

Electric showers use water from your mains cold water supply only, so the chances are an electric shower would suit your home. They heat the water when you turn the shower on, passing it over a built-in heating element - similar to how a kettle works.

One reason to choose an electric shower is that it won't use up any of your stored hot water. So, if you have a limited supply of stored hot water, or you want to use it for something else, like a bath perhaps, an electric shower really makes sense. It's also ready to use any time of day or night.

Which temperature control?

Electric showers can come with 4 different types of temperature control:

Pressure stabilised – minimises temperature changes to ensure a consistent showering temperature, even if someone flushes the loo.

Advanced pressure stabilised – these showers control your showering temperature in a similar way to pressure stabilised models, but they also feature Opti-flo™ technology which gives you a wider selectable flow rate range. This means you can enjoy the full power of the shower even in the summer months when the incoming water temperature is higher.

Thermostatic – ensures that the temperature always stays to within +/-2 degrees, a safety feature that makes these showers ideal for those who have young or elderly family members.

Advanced thermostatic – the ultimate in safe showering. These showers utilise electronic technology to ensure that the showering temperature will always be consistent to within +/- 1 degree. All of the showers in our Mira Advance ATL range have been awarded the BEAB Care marque accreditation, which makes them ideal for the healthcare sector.

What are the key technologies?

Sensi-flo™ – prevents scalding in the event of a loss of water pressure or if the showerhead or hose become blocked.

Clearscale™ – incorporates DualElement™, phased shutdown and rub-clean nozzles to cut limescale by half so the shower performs better and lasts longer.

Opti-flo™ – gives you a wider selectable flow rate range which means you can enjoy the full power of the shower even in the summer months when the incoming water temperature is higher.

DualElement™ – the heater tank runs at cooler temperatures than conventional technology providing constant power throughout the element which reduces "hot spots" where limescale can accumulate.

Water-saving showers



All our electric showers meet the strict criteria set out by the Bathroom Manufacturers' Association (BMA) for using water efficiently.









Electric shower contents

Mira Vie	81-82
Mira Jump	83
Mira Zest	84
Mira Sport	87-88
Mira Sport Multi-fit™	89-90
Mira Sport Thermostatic	91-92
Mira Sport Max with Airboost™	93-94
Mira Elite ST	95-96
Mira Orbis	97-98
Mira Escape	99
Mira Azora	100
Mira Galena	101-102
Mira Advance ATL	103
Mira Advance Low Pressure	104
Mira Advance ATL Flex	105
Mira Advance ATL Memory	106

Mira electric showers features and benefits

We have put together a handy guide to help you find your perfect electric shower depending on the smart features and benefits you require. Simply take a look at the table below and select the features you need from your Mira electric shower and then turn to the right page in the brochure where you can find out more.

Model	Page				
Mira Vie	81-82	-	-	-	-
Mira Jump	83	-	-	-	-
Mira Zest	84	-	-	-	-
Mira Sport Range	85-86	-	-	✓	✓
Mira Sport	87-88	-	-	✓	✓
Mira Sport Multi-fit™	89-90	✓	-	✓	✓
Mira Sport Thermostatic	91-92	-	-	✓	✓
Mira Sport Max with Airboost™	93-94	-	-	✓	✓
Mira Elite ST	95-96	✓	-	✓	✓
Mira Orbis	97-98	✓	-	✓	✓
Mira Escape	99	✓	-	✓	✓
Mira Azora	100	✓	-	✓	✓
Mira Galena	101-102	✓	✓	-	-
Mira Advance ATL	103	✓	✓	-	-
Mira Advance Low Pressure	104	✓	✓	-	-
Mira Advance ATL Flex	105	✓	✓	-	-
Mira Advance ATL Memory	106				

							
✓	✓	-	-	-	-	-	-
✓	✓	✓	-	✓	-	-	-
✓	✓	-	-	-	-	-	-
✓	✓	✓	✓	✓	-	-	-
✓	✓	✓	✓	✓	-	-	-
✓	✓	✓	✓	✓	-	-	-
✓	✓	✓	✓	✓	-	-	-
✓	✓	✓	-	-	✓	-	-
✓	✓	✓	-	-	-	-	-
✓	✓	✓	-	-	-	-	-
✓	✓	✓	✓	✓	-	-	-
✓	✓	-	-	-	-	-	-
✓	✓	-	-	-	✓	-	-
✓	✓	-	-	-	-	-	✓
✓	✓	-	-	-	-	✓	-

Overview - electric showers

We've got a wide range of electric showers to choose from, which are available in different kilowatt power ratings. Look for a higher kilowatt rating if you want a more powerful flow. All of our electric showers are approved by the BMA as being Water Efficient. If you would like more information on any of our electric showers, please call us on **0844 571 5000** or visit **www.mirashowers.co.uk**, for customers from the Republic of Ireland please call modern plant on **01 459 1344** or visit **www.mirashower.ie**

When buying an Electric shower you will notice that the kilowatt ratings are given are based on 240 volts. As Ireland operates at 230 volts we have included a table that converts the power rating. If you have any queries please discuss this with your installer.

240v (UK)	230v (Ireland)
7.5kW	6.9kW
8.5kW	7.8kW
9.0kW	8.2kW
9.5kW	8.7kW
9.8kW	9.0kW
10.8kW	9.9kW



Mira Vie range
 • 8.5 kW, 9.5 kW & 10.8 kW (UK)
 • Chrome, white/chrome & satin chrome
 See pages 81-82.



Mira Jump
 • 8.5 kW, 9.5 kW & 10.8 kW (UK)
 • White/chrome
 See page 83.



Mira Zest range
 • 7.5 kW & 8.5 kW (UK)
 • White/chrome
 See page 84.



Mira Elite ST range
 • 9.8 kW & 10.8 kW (UK)
 • White/chrome, & satin/chrome
 See pages 95-96.



Mira Orbis range
 • 9.0 kW, 9.8 kW & 10.8 kW (UK)
 • White/chrome & black/chrome
 See pages 97-98.



Mira Escape range
 • 9.0kW, 9.8 kW (UK)
 • Chrome & satin chrome
 See page 99.



Mira Azora
 • 9.8 kW (UK)
 • Glass/chrome
 See page 100.



Mira Galena range
 • Slate effect
 See pages 101-102.



Mira Sport range
 • 7.5 kW, 9.0 kW, 9.8 kW & 10.8kW (UK)
 • White/chrome, white & chrome
 See pages 87-88.



Mira Sport Multi-fit™
 • 9.0 kW & 9.8 kW (UK)
 • White/chrome
 See pages 89-90.



Mira Sport Thermostatic range
 • 9.0 kW & 9.8 kW (UK)
 • White/chrome
 See pages 91-92.



Mira Sport Max with Airboost™
 • 9.0kW & 10.8 kW (UK)
 • White/chrome & white
 See pages 93-94.



Mira Advance ATL Flex range
 • 9.0 kW & 9.8kW (UK)
 • White/chrome
 See page 103.



Mira Advance Low Pressure
 • 9.0kW (UK)
 • White/chrome
 See page 104.

NOT AVAILABLE IN R.O.I.



Mira Advance ATL Memory range
 • 9.0 kW & 9.8 kW (UK)
 • White/chrome
 See page 105.



Mira Advance ATL Memory range
 • 9.0 kW & 9.8 kW (UK)
 • White/chrome
 See page 106.

Mira Vie

High spec. Low price. Built with the same quality and performance standards we set for all our showers, it combines an invigorating shower with great value for money.

4 SPRAYS



Choose from the following configurations:



Mira Vie
Electric shower,
white/chrome finish.
8.5kW 2.1539.390
9.5kW 2.1539.391
10.8kW 2.1539.392



Mira Vie
Electric shower,
satin/chrome finish.
10.8kW 2.1539.393



Mira Vie
Electric shower,
chrome finish.
8.5kW 2.1539.425
9.5kW 2.1539.426
10.8kW 2.1539.427

Product features

- Pressure stabilised temperature control maintains your selected showering temperature
- Separate power and temperature controls to fine tune your perfect shower
- Push button on/off so you can leave the power and temperature controls at your preferred setting
- Eco setting designed to save water and energy
- 4 spray showerhead with rub-clean nozzles for easy limescale removal
- All models are available in chrome or white/chrome and the 10.8kW version is available in satin/chrome too
- Available in 8.5kW, 9.5kW and 10.8kW power options
- 2 year guarantee
- For kW ratings in ROI see the conversion chart on page 80



Mira Jump

Jump to Mira. Specifically designed for easy replacement of right inlet electric showers. Retrofits Triton, Aqualisa and many other electric showers.

View demo at:
www.mirashowers.co.uk/jump

4 SPRAYS



Mira Jump
 Electric shower,
 white/chrome finish.
 8.5kW 1.1693.001
 9.5kW 1.1693.002
 10.8kW 1.1693.003



Product features

- Separate power and temperature controls to fine tune your perfect shower
- Push button on/off so you can leave the power and temperature controls at your preferred setting
- Eco setting designed to save water and energy
- Adjustable slide bar fits over holes left by a previous shower kit
- Clearscale™ technology cuts limescale by half for a better performing, longer lasting shower
- 4 spray showerhead with rub-clean nozzles for easy limescale removal
- Available in white/chrome
- Available in 8.5kW, 9.5kW and 10.8kW power options
- 2 year guarantee
- For kW ratings in ROI see the conversion chart on page 80

Mira Zest

Saves energy and water where it matters most. With a sleek stylish design complimented by eco friendly features, the great value Mira Zest is the perfect choice for the environmental and cost conscious.

4 SPRAYS



Mira Zest
 Electric shower,
 white/chrome finish.
 7.5kW 2.1539.200
 8.5kW 2.1539.201



Product features

- Pressure stabilised temperature control maintains your selected showering temperature
- Separate power and temperature controls to fine tune your perfect shower
- Easy one hand adjustment of showerhead height
- 4 spray showerhead with eco setting and rub-clean nozzles for easy limescale removal
- All models are available in white/chrome
- Available in 7.5kW and 8.5kW power options
- 2 year guarantee
- For kW ratings in ROI see the conversion chart on page 80



An Outstanding Performance

The Mira Sport range is well made, well loved and well established. A bestselling performer that never lets you down, Sport has been thoughtfully designed to enhance both performance and style. With a sleek and simple aesthetic, a solid build quality, multifunctional sprays and intelligent controls, this is a great all rounder that looks at home in any bathroom.



Mira Sport

The next generation is here. With a great new look and improved fittings, the new Mira Sport is still as reliable, easy to fit and easy to use as ever.



View demo at:
www.mirashowers.co.uk/newsport



RAIN



RAIN +



BURST



STORM



Mira Sport
 Electric shower,
 white/chrome finish.
 7.5kW 1.1746.001
 9.0kW 1.1746.002
 9.8kW 1.1746.003
 10.8kW 1.1746.004

Product features

- Advanced pressure stabilised temperature control keeps your selected showering temperature consistent
- Separate power and temperature controls to fine tune your perfect shower
- Push button on/off so you can leave the power and temperature controls at your preferred setting
- Sensi-flo™ prevents scalding in the event of a loss of water pressure or if the showerhead or hose become blocked
- Clearscale™ technology cuts limescale by half for a better performing, longer lasting shower
- Opti-flo™ optimises flow throughout the year
- Phased shutdown flushes hot water from the tank to make it safe for the next user
- Large 110mm 4 spray showerhead with rub-clean nozzles for easy limescale removal
- Adjustable slide bar fits over holes left by a previous shower kit
- Available in white/chrome
- Available in 7.5kW, 9.0kW, 9.8kW, and 10.8kW power options
- 2 year guarantee
- For kW ratings in ROI see the conversion chart on page 80



Mira Sport Multi-fit™

For the ultimate retrofit. Sport Multi-fit™ simply retrofits over more products than any other electric shower on the market. So left, right, top, bottom or rear Sport's got it covered.



RAIN



RAIN +



BURST



STORM



Mira Sport Multi-fit™
Electric shower,
white/chrome finish.
9.0kW 1.1746.009
9.8kW 1.1746.010

View demo at:
www.mirashowers.co.uk/newsport



Product features

- Advanced pressure stabilised temperature control keeps your selected showering temperature consistent
- Separate power and temperature controls to fine tune your perfect shower
- Push button on/off so you can leave the power and temperature controls at your preferred setting
- Sensi-flo™ prevents scalding in the event of a loss of water pressure or if the showerhead or hose become blocked
- Clearscale™ technology cuts limescale by half for a better performing, longer lasting shower
- Opti-flo™ optimises flow throughout the year
- Phased shutdown flushes hot water from the tank to make it safe for the next user
- Large 110mm 4 spray showerhead with rub-clean nozzles for easy limescale removal
- Adjustable slide bar fits over holes left by a previous shower kit
- Caters for electrical and water connections from the left, right, top, bottom or rear
- Available in white/chrome
- Available in 9.0kW and 9.8kW power options
- 2 year guarantee
- For kW ratings in ROI see the conversion chart on page 80

Mira Sport Thermostatic

Ultimate temperature control. New style, improved fittings and the added reassurance of thermostatic temperature control.



View demo at:
www.mirashowers.co.uk/newsport



RAIN



RAIN +



BURST



STORM



Mira Sport Thermostatic
 Electric shower,
 white/chrome finish.
 9.0kW 1.1746.005
 9.8kW 1.1746.006

Product features

- Thermostatic temperature stability keeps showering safe for all the family
- Separate power and temperature controls to fine tune your perfect shower
- Push button on/off so you can leave the power and temperature controls at your preferred setting
- Sensi-flo™ prevents scalding in the event of a loss of water pressure or if the showerhead or hose become blocked
- Clearscale™ technology cuts limescale by half for a better performing, longer lasting shower
- Phased shutdown flushes hot water from the tank to make it safe for the next user
- Large 110mm 4 spray showerhead with rub-clean nozzles for easy limescale removal
- Adjustable slide bar fits over holes left by a previous shower kit
- Available in white/chrome
- Available in 9.0kW and 9.8kW power options
- 2 year guarantee
- For kW ratings in ROI see the conversion chart on page 80



Mira Sport Max with Airboost™

The UK's best performing electric just got a boost. A sensational spray experience and performance that you simply won't find from any other electric shower on the market.

4 SPRAYS



Mira Sport Max with Airboost™
Electric shower, white/chrome finish.
9.0kW 1.1746.007
10.8kW 1.1746.008



View demo at:
www.mirashowers.co.uk/newsport

Product features

- Advanced pressure stabilised temperature control keeps your selected showering temperature consistent
- Separate power and temperature controls to fine tune your perfect shower
- Push button on/off so you can leave the power and temperature controls at your preferred setting
- Sensi-flo™ prevents scalding in the event of a loss of water pressure or if the showerhead or hose become blocked
- Clearscale™ technology cuts limescale by half for a better performing, longer lasting shower
- Opti-flo™ optimises flow throughout the year
- Airboost™ - a world first in flow boosting technology
- Phased shutdown flushes hot water from the tank to make it safe for the next user
- Large 110mm 4 spray showerhead with flow boosting technology
- Adjustable slide bar fits over holes left by a previous shower kit
- Available in 9.0kW and 10.8kW power options
- 2 year guarantee
- For kW ratings in ROI see the conversion chart on page 80



Mira Elite ST

The ideal choice for low pressure water systems. Perfect if your water pressure is too low or erratic for a standard electric or mixer shower.

4 SPRAYS



Choose from the following configurations:



Mira Elite ST
Electric shower,
white/chrome finish.
9.8kW 1.1563.230
10.8kW 1.1563.721



Mira Elite ST
Electric shower,
satin/chrome finish.
9.8kW 1.1674.001

Product features

- Advanced pressure stabilised temperature control keeps your selected showering temperature consistent
- Separate power and temperature controls to fine tune your perfect shower
- Select and forget control for your ideal shower at the touch of a button
- An integrated pump provides a strong and consistent flow, whatever the temperature
- Sensi-flo™ prevents scalding in the event of a loss of water pressure or if the showerhead or hose become blocked
- Clearscale™ technology cuts limescale by half for a better performing, longer lasting shower
- Opti-flo™ optimises flow throughout the year
- Phased shutdown flushes hot water from the tank to make it safe for the next user
- 4 spray showerhead with rub-clean nozzles for easy limescale removal
- Choose between stylish white/chrome and clean satin/chrome finishes (9.8kW only)
- Available in 9.8kW and 10.8kW power options
- 2 year guarantee
- For kW ratings in ROI see the conversion chart on page 80

*Gravity fed cold water cistern.



Electric showers

Electric showers

Mira Orbis

Designed to light up any bathroom. Boasting a sleek design and a stylish blue backlit digital temperature and time display, the Mira Orbis combines stunning looks with a whole-host of fantastic features.

4 SPRAYS



Mira Orbis
Electric shower,
black/chrome finish.
9.8kW 1.1647.007



Mira Orbis
Electric shower,
white/chrome finish.
9.0kW 1.1647.001
9.8kW 1.1647.002
10.8kW 1.1647.003

Product features

- Thermostatic temperature stability keeps showering safe for all the family
- Maximum temperature stop for increased safety
- Select and forget control for your ideal shower at the touch of a button
- Back-lit digital temperature and time display
- Sensi-flo™ prevents scalding in the event of a loss of water pressure or if the showerhead or hose become blocked
- Clearscale™ technology cuts limescale by half for a better performing, longer lasting shower
- 4 spray showerhead with rub-clean nozzles for easy limescale removal
- Available in white/chrome and the 9.8kW is available in black too
- Available in 9.0kW, 9.8kW and 10.8kW power options
- 2 year guarantee
- For kW ratings in ROI see the conversion chart on page 80



Electric showers

Electric showers

Mira Escape

The perfect place to escape to. Stunning, up-to-the-minute design mixed with thermostatic technology delivers performance and safety to any bathroom.

4 SPRAYS



Mira Escape
Electric shower,
chrome finish.
9.0kW 1.1563.730
9.8kW 1.1563.011



Mira Escape
Electric shower,
satin/chrome finish.
9.0kW 1.1563.729
9.8kW 1.1563.012



Mira Azora

Makes a statement in any bathroom. Simple frosted glass fascia perfectly complemented by smooth chrome features, for good-looks and a great performance every time.

4 SPRAYS



Mira Azora
Electric shower,
glass/chrome finish.
9.8kW 1.1634.001



Product features

- Thermostatic temperature stability keeps showering safe for all the family
- Maximum temperature stop for increased safety
- Separate power and temperature controls to fine tune your perfect shower
- Select and forget control for your ideal shower at the touch of a button
- Sensi-flo™ prevents scalding in the event of a loss of water pressure or if the showerhead or hose become blocked
- Clearscale™ technology cuts limescale by half for a better performing, longer lasting shower
- Phased shutdown flushes hot water from the tank to make it safe for the next user
- Slimline, contemporary design that looks great in any bathroom
- 4 spray showerhead with rub-clean nozzles for easy limescale removal
- Choose between stylish full chrome or satin/chrome finishes
- Available in 9.0kW and 9.8kW power options
- 2 year guarantee
- For kW ratings in ROI see the conversion chart on page 80

Product features

- Thermostatic temperature stability keeps showering safe for all the family
- Separate power and temperature controls to fine tune your perfect shower
- Select and forget control for your ideal shower at the touch of a button
- Thermostatic temperature stability keeps showering safe for all the family
- Sensi-flo™ prevents scalding in the event of a loss of water pressure or if the showerhead or hose become blocked
- Clearscale™ technology cuts limescale by half for a better performing, longer lasting shower
- Phased shutdown flushes hot water from the tank to make it safe for the next user
- 4 spray showerhead with rub-clean nozzles for easy limescale removal
- With a frosted glass fascia
- 9.8kW power rating
- 2 year guarantee
- For kW ratings in ROI see the conversion chart on page 80

Mira Galena

It's not just a pretty fascia. With minimal looks and packed with technology, it combines stunning style and great performance.

5 SPRAYS



Mira Galena
Electric shower,
silver glass finish.
9.8kW 1.1634.082



Mira Galena
Electric shower,
black flock finish.
9.8kW 1.1634.083



Mira Galena
Electric shower,
light stone finish.
9.8kW 1.1634.084



Mira Galena
Electric shower,
slate finish.
9.8kW 1.1634.117

Product features

- Thermostatic temperature stability keeps showering safe for all the family
- Separate power and temperature controls to fine tune your perfect shower
- Select and forget control for your ideal shower at the touch of a button
- Sensi-flo™ prevents scalding in the event of a loss of water pressure or if the showerhead or hose become blocked
- Clearscale™ technology cuts limescale by half for a better performing, longer lasting shower
- 5 spray showerhead with rub-clean nozzles for easy limescale removal
- 4 stylish finishes available
- 9.8kW power rating
- 2 year guarantee
- For kW ratings in ROI see the conversion chart on page 80



Mira Advance ATL

The perfect temperature all day, every day. Bringing you safe, precise, thermostatically controlled showering for complete peace of mind.

4 SPRAYS



Mira Advance ATL
Electric shower,
white/chrome finish.
9.0kW 1.1643.001
9.8kW 1.1643.003



Mira Advance Low Pressure

Ultimate safety and usability. Safe, precise, thermostatically controlled showering for complete peace of mind - even at low pressure.

4 SPRAYS



Mira Advance Low Pressure
Electric shower,
white/chrome finish.
9.0kW 1.1759.001

Mira Advance Flex Low Pressure
Electric shower,
white/chrome finish.
9.0kW 1.1759.003

NOT AVAILABLE IN R.O.I



Product features

- Thermostatic temperature stability keeps showering safe for all the family
- Separate temperature and flow controls to fine tune your perfect shower
- Select and forget control for your ideal shower at the touch of a button
- Adjustable Temperature Limit gives you the option of selecting your preferred maximum temperature from 8 different settings
- Phased shutdown flushes hot water from the tank to make it safe for the next user
- With a large on/off button, backlit buttons and an audible bleep to aid navigation, it's easy for everyone to use
- The easy to use slide bar and friction bracket can be adjusted with one hand and is wall or corner mountable
- Best in its class for reducing limescale build-up
- 4 spray showerhead with rub-clean nozzles for easy limescale removal
- All models are available in white/chrome
- Available in 9.0kW and 9.8kW power options
- 2 year guarantee
- For kW ratings in ROI see the conversion chart on page 80

Product features

- Thermostatic temperature stability keeps showering safe for all the family
- Separate temperature and flow controls to fine tune your perfect shower
- Select and forget control for your ideal shower at the touch of a button
- Adjustable Temperature Limit gives you the option of selecting your preferred maximum temperature from 8 different settings
- An integrated pump provides a strong and consistent flow at low pressure. Designed for gravity fed systems (minimum 80mm head pressure)
- Phased shutdown flushes hot water from the tank to make it safe for the next user
- With a large on/off button, backlit buttons and an audible bleep to aid navigation, it's easy for everyone to use
- Best in its class for reducing limescale build-up
- The easy to use slide bar and friction bracket can be adjusted with one hand and is wall or corner mountable
- 4 spray showerhead with rub-clean nozzles for easy limescale removal
- All models are available in white/chrome
- 9.0kW power rating
- For kW ratings in ROI see the conversion chart on page 80

*Gravity fed cold water cistern.

Mira Advance ATL Flex

Ultimate safety and usability. So safe and user friendly it's endorsed by the Royal National Institute of the Blind.

4 SPRAYS



supporting blind and partially sighted people

Mira Advance ATL Flex

Electric shower, white/chrome finish.

9.0kW 1.1643.005

9.8kW 1.1643.006



Product features

- Thermostatic temperature stability keeps showering safe for all the family
- Separate temperature and flow controls to fine tune your perfect shower
- Select and forget control for your ideal shower at the touch of a button
- Adjustable Temperature Limit gives you the option of selecting your preferred maximum temperature from 8 different settings
- Phased shutdown flushes hot water from the tank to make it safe for the next user
- Features a large, colour contrasted rotary lever with a large loop, making it easier to change the temperature
- The easy to use slide bar and friction bracket can be adjusted with one hand and is wall or corner mountable
- 1m slide bar and 2m hose for greater flexibility
- Best in its class for reducing limescale build-up
- 4 spray showerhead with rub-clean nozzles for easy limescale removal
- All models are available in white/chrome
- Available in 9.0kW and 9.8kW power options
- 2 year guarantee
- For kW ratings in ROI see the conversion chart on page 80

Mira Advance ATL Memory

Safety and functionality at the touch of a button. Bringing you safe, precise, thermostatically controlled showering plus three programmable memory functions to store your favourite flow and temperature settings, for complete peace of mind.

4 SPRAYS



Mira Advance ATL Memory

Electric shower, white/chrome finish.

9.0kW 1.1643.007

9.8kW 1.1643.008



Product features

- Thermostatic temperature stability keeps showering safe for all the family
- Separate temperature and flow controls to fine tune your perfect shower
- Select and forget control for your ideal shower at the touch of a button
- Adjustable Temperature Limit gives you the option of selecting your preferred maximum temperature from 8 different settings
- Phased shutdown flushes hot water from the tank to make it safe for the next user
- With a large on/off button, backlit buttons and an audible bleep to aid navigation, it's easy for everyone to use
- The easy to use slide bar and friction bracket can be adjusted with one hand and is wall or corner mountable
- Best in its class for reducing limescale build-up
- 4 spray showerhead with rub-clean nozzles for easy limescale removal
- All models are available in white/chrome
- Available in 9.0kW and 9.8kW power options
- 2 year guarantee
- For kW ratings in ROI see the conversion chart on page 80



Power showers

Nothing beats the exhilaration of standing under a truly drenching flow of cleansing water. Power showers from Mira come with an internal pump to boost the flow and give you a shower that delivers this stunning experience every single time.

Power showers mix water from both your hot and cold supplies on low pressure systems to give you your ideal temperature. If you've got a plentiful supply of hot water in your home, a power shower could be ideal.

If you'd like a powerful flow but would prefer a mixer shower, you can install a separate shower pump – see page 65 to find out more.

Which temperature control?

There are 2 different types of temperature control available with power showers. Simply choose the one that you'd be happiest with – you can see which shower comes with which type of control over the following pages.

Manual – your shower will not compensate for changes in the incoming supply temperature or pressure and the shower temperature may change.

Thermostatic – gives you great temperature control and are ideal for people who are at risk such as the very young or elderly.

Power shower contents

Mira Vigour Manual	111
Mira Vigour Thermostatic	112
Mira Event XS Manual	113
Mira Event XS Thermostatic	114
Mira Extreme Thermostatic	115-116

Mira power showers features and benefits

We have put together a handy guide to help you find your perfect power shower depending on the smart features and benefits you require. Simply take a look at the table below and select the features you need from your Mira power shower and then turn to the relevant page in the brochure where you can find out more.

Model	Page			
Mira Vigour Manual	111	✓	✓	-
Mira Vigour Thermostatic	112	✓	✓	✓
Mira Event XS Manual	113	✓	✓	-
Mira Event XS Thermostatic	114	✓	✓	✓
Mira Extreme Thermostatic	115-116	✓	✓	✓

Overview - power showers

We've got a stylish range of all-in-one power showers to choose from. These types of showers have a built-in pump which boosts the flow rate. You can achieve similar flow rates by fitting a shower pump to one of our contemporary or classic mixers. If you would like more information on any of our power shower range please call us on **0844 571 5000** or visit **www.mirashowers.co.uk**, for customers from the Republic of Ireland please call Modern Plant on **01 459 1344** or visit **www.mirashowers.ie**



Mira Vigour Manual
• White/chrome
See page 111.

Mira Vigour Thermostatic
• White/chrome
See page 112.

Mira Event XS Manual
• White/chrome & white
See page 113.



Mira Event XS Thermostatic
• White/chrome & white
See page 114.

Mira Extreme Thermostatic
• White/chrome
See pages 115-116.

Mira Vigour Manual

True invigoration. The perfect blend of performance and price.

5 SPRAYS



Mira Vigour Manual
Power shower,
white/chrome finish.
1.1532.354



Mira Vigour Thermostatic

True invigoration. The perfect blend of performance, price and safety.

5 SPRAYS



Mira Vigour Thermostatic
Power shower,
white/chrome finish.
1.1532.353



Product features

- Maximum temperature stop for increased safety
- Delivers an invigorating 12 litres of water a minute
- Available in white/chrome
- Separate temperature and flow controls to fine tune your perfect shower
- 5 spray showerhead with rub-clean nozzles for easy limescale removal
- 1 year guarantee

Product features

- Thermostatic temperature stability keeps showering safe for all the family
- Separate temperature and flow controls to fine tune your perfect shower
- Delivers an invigorating 14 litres of water a minute
- 5 spray showerhead with rub-clean nozzles for easy limescale removal
- Available in white/chrome
- 1 year guarantee

Mira Event XS Manual

A showering sensation. Brings powerful showering and practical features to your bathroom.

4 SPRAYS



Mira Event XS
Power shower,
white finish.
1.1532.014

Mira Event XS
Power shower,
white/chrome finish.
1.1532.003



Mira Event XS Thermostatic

Bursting with performance. Brings safe, powerful showering and practical features to your bathroom.

4 SPRAYS



Mira Event XS Thermostatic
Power shower,
white finish.
1.1532.013

Mira Event XS Thermostatic
Power shower,
white/chrome finish.
1.1532.002



Product features

- Separate power temperature and flow controls to fine tune your perfect shower
- Simply set your ideal flow and temperature and that's it
- Delivers an invigorating 14 litres of water a minute
- 4 spray showerhead with rub-clean rubber nozzles for easy limescale removal
- Available in white or white/chrome
- 1 year guarantee

Product features

- Thermostatic temperature stability keeps showering safe for all the family
- Separate temperature and flow controls to fine tune your perfect shower
- Select and forget control for your ideal shower at the touch of a button
- The special 'flow boost' feature delivers an invigorating 16 litres of water a minute
- 4 spray showerhead with rub-clean nozzles for easy limescale removal
- Available in white or white/chrome
- 1 year guarantee

Mira Extreme Thermostatic

Unrivalled by any other shower in its class. The ultimate power shower, with stylish modern push buttons and precise temperature control, it's the pinnacle of performance and safety.

4 SPRAYS



Mira Extreme Thermostatic
Power shower,
white/chrome finish.
1.1532.019



Product features

- Thermostatic temperature stability keeps showering safe for all the family
- Separate temperature and flow controls to fine tune your perfect shower
- Its easy to choose your ideal shower at the touch of a button
- Delivers an invigorating 16 litres of water a minute
- 4 spray showerhead with rub-clean nozzles for easy limescale removal
- Available in white/chrome
- 1 year guarantee





Mira ACE shower enclosures

Robust and easy to install, Mira ACE shower enclosures give watertight confidence in a simple strong design.

Thoughtfully engineered design details ensure durability and longevity and provide maximum flexibility on your installation with up to 29mm of adjustment for uneven walls. Frameless doors provide a premium feel and a wide range of door types and size options available to deliver an enclosure to complement any bathroom. Our investment in research and development keeps us at the forefront of design and technology so we can provide our customers with flexible robust shower solutions to suit any bathroom.

Combining design and technology

Planet gear

The planet gear mechanism, found on the bi-fold model, ensures correct alignment leading to a consistent smooth action. Magnetic strips along the top and bottom of the door ensure a strong consistent closure.

Double rollers

The double rollers on the sliding quadrant and corner entry doors provide a smooth consistent gliding action to give a high quality feel and performance throughout the product's life.

Unique design details

The high quality finish, achieved in-house, provides a premium feel to any bathroom.

Adjustable ball catch

The adjustable ball catch used on the pivot door, offers additional installation flexibility and performance. The catch can be adjusted to provide a high quality feel throughout the product's life.

Mira ACE shower enclosure contents

Mira ACE bathscreen	123-124
Mira ACE pivot door - alcove	125-126
Mira ACE pivot door - corner	127-128
Mira ACE pivot pentagon - corner	129-130
Mira ACE bi-fold door - alcove	131-132
Mira ACE bi-fold door - corner	133-134
Mira ACE bi-fold pentagon - corner	135-136
Mira ACE sliding door - alcove	137-138
Mira ACE sliding door - corner	139-140
Mira ACE quadrant	141-142
Mira ACE corner - entry	143-144
Accessories	145-146



Bi-fold door, planet gear mechanism



High quality polished silver finish



Sliding door, double roller bogeys



Pivot door, adjustable ball catch

How to choose your Mira ACE alcove or corner shower enclosure

Whatever you're looking for in a shower enclosure, it can be found within the new Mira ACE enclosure range. But which is right for you? Just follow these 3 simple steps:

Step 1 - preparation

Measure the width of your shower door but importantly also measure the space available in the bathroom to get in and out, and for the door to open.

Step 2 - choose your location

Are you installing the door in an alcove or corner site?

Step 3 - choose your door type: alcove or corner enclosure

Alcove enclosure

N.B. Remember to check that the door opening is wide enough for your needs

Pivot door - offers the widest opening for a given size of enclosure – just make sure that there is space in the bathroom for the door to open. Remember the door is reversible so can open to the left or right.

Bi-fold door - ideal if there is not enough space in the bathroom for a pivot door as the door folds inwards. May not be the best solution if your mobility is limited as you will need to move out of the way of the door to open it.

Slider - another door that does not intrude into the bathroom space and provides a very easy to use solution for widths of 1000mm and over.

Corner enclosure

N.B. Don't forget to order a side panel as well as a door to complete the enclosure. Remember to check that the door opening is wide enough for your needs.

Pivot door - offers the widest opening for a given size of enclosure – just make sure that there is space in the bathroom for the door to open. Remember the door is reversible so can open to the left or right.

Bi-fold door - ideal if there is not enough space in the bathroom for a pivot door as the door folds inwards. May not be the best solution if your mobility is limited as you will need to move out of the way of the door to open it.

Slider - another door that doesn't intrude into the bathroom space and provides a very easy to use solution for widths of 1000mm and over.

Quadrant - a very space efficient solution with its double sliding doors and elegant curved shape.

Corner entry - a space efficient square enclosure with double sliding doors giving more room for bathroom furniture and accessories near the showering area.



Overview - Mira ACE enclosures

Bathscreen - square

1450mm
800mm

Bathscreen - mini

1500mm
250mm

Shower curtain not included

Pivot alcove

Pivot alcove

760mm
800mm
900mm
1000mm

Pivot extended alcove

1200mm
1400mm

Pivot double extended alcove

1600mm
1700mm
1800mm

Pivot corner enclosure

Pivot corner enclosure

760 x 760mm
760 x 800mm
760 x 900mm
800 x 760mm
800 x 800mm
800 x 900mm

Pivot extended corner enclosure

1200 x 760mm
1200 x 800mm
1200 x 900mm
1400 x 760mm
1400 x 800mm
1400 x 900mm

Pivot double extended corner enclosure

1600 x 760mm
1600 x 800mm
1600 x 900mm
1700 x 760mm
1700 x 800mm
1700 x 900mm

Bi-fold alcove

Bi-fold alcove

700mm
760mm
800mm
900mm
1000mm

Bi-fold extended alcove

1100mm
1200mm
1400mm

Bi-fold double extended alcove

1500mm
1600mm
1700mm
1800mm

Pivot Pentagon

Pivot pentagon corner enclosure

900 x 900mm 1200 x 900mm

Bi-fold Pentagon

Bi-fold pentagon corner enclosure

900 x 900mm 1200 x 900mm

Bi-fold corner enclosure

Bi-fold corner enclosure

700 x 760mm
700 x 800mm
700 x 900mm
760 x 760mm
760 x 800mm
760 x 900mm

Bi-fold extended corner enclosure

800 x 760mm
800 x 800mm
800 x 900mm
900 x 760mm
900 x 800mm
900 x 900mm

Bi-fold double extended corner enclosure

1000 x 760mm
1000 x 800mm
1000 x 900mm
1100 x 760mm
1200 x 760mm
1200 x 800mm
1200 x 900mm

Sliding alcove

Sliding alcove

1000mm
1150mm
1200mm

Sliding corner

Sliding corner enclosure

1000 x 760mm
1000 x 800mm
1000 x 900mm
1150 x 760mm
1150 x 800mm
1150 x 900mm

Quadrant

Quadrant

800x800mm
900x900mm

Corner entry

Corner entry

800mm x 800mm
900mm x 900mm

Accessories

Filler profile

10mm

In-line panels

400mm 2x400mm

Side panels

760mm
800mm
900mm

Mira ACE bathscreen

The Mira range of bathscreens is designed with modern, clean lines and a high quality finish for a simple yet effective way to protect your bathroom while showering.



Configuration options

Bathscreen - square

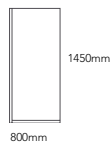
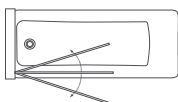

Bathscreen - mini

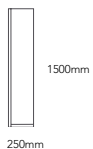

Shower curtain not included

Dimensions & tray compatibility

All sizes are in mm

Mira ACE square bath screen	size	frame finish option	glass
109640	800x1450	Silver	Clear

Mira ACE square bath mini	size	frame finish option	glass
109641	250x1500	Silver	Clear



5mm toughened safety glass

The toughened safety glass used on the Mira ACE bathscreen is 5mm thick. It provides peace of mind and a feeling of high quality.



Product features

- Semi frameless design gives contemporary styling
- Modern clean lines give your bathroom a premium feel
- Swings in or out for easy access and cleaning
- Frame adjustment for uneven walls
- 5mm toughened safety glass
- Power shower approved
- Height 1450mm
- Length 800mm
- 10 year guarantee



Mira ACE pivot door - alcove

The frameless pivot door is adjustable up to 29mm and has a ball catch closing mechanism that can be adjusted to deliver a firm closing action.



Configuration options

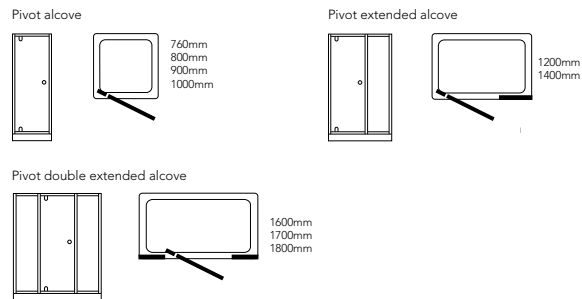

Dimensions & tray compatibility

All sizes are in mm

Mira ACE pivot door	size	frame finish option	glass	frame adjustment alcove door	frame adjustment corner enclosure	door opening	10mm filler kit (if required)	Flight tray compatibility	Flight Low tray compatibility
108348	760	Silver	Clear	698-756	720-749	542	108423	760x760	760x760
108349	800	Silver	Clear	736-794	758-787	580	108423	800x800	800x800
108350	900	Silver	Clear	836-894	858-887	680	108423	900x900	900x900
108351	1000	Silver	Clear	936-994	958-987	780	108423	1000x760	1000x760
								1000x800	1000x800
in-line panel	Create larger enclosures using the ACE in-line panel (see accessories pg 145-146 for more information).								
108403	400	Silver	Clear		29mm		108423	1200x760	1200x760
								1200x800	1200x800
								1200x900	1400x760
								1400x800	1600x760
									1700x760

*see pages 127-128 for pivot door corner enclosure

Product features

- Reversible door for left or right hand opening
- Perfect for alcove or corner installation
- 29mm of adjustment on each wall profile for out of true walls
- Adjustable ball catch closing mechanism ensures a solid closing action
- 6mm toughened safety glass
- Suitable for power showers
- Height from top of tray: 1830mm
- 10 year guarantee



Adjustable ball catch

The adjustable ball catch used on the pivot door, offers additional installation flexibility and performance. The catch can be adjusted to provide a high quality feel throughout the product's life.



Unique design details

The high quality finish, achieved in-house, provides a premium feel to any bathroom.



Mira ACE pivot door - corner

The frameless pivot door is adjustable up to 29mm and has a ball catch closing mechanism that can be adjusted to deliver a firm closing action.



Configuration options

Pivot corner enclosure

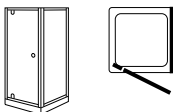

760 x 760mm
760 x 800mm
760 x 900mm
800 x 760mm

800 x 800mm
800 x 900mm
900 x 760mm
900 x 800mm

900 x 900mm
1000 x 760mm
1000 x 800mm
1000 x 900mm

Pivot extended corner enclosure

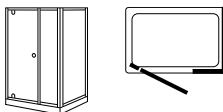

1200 x 760mm
1200 x 800mm
1200 x 900mm

1400 x 760mm
1400 x 800mm
1400 x 900mm

Pivot double extended corner enclosure

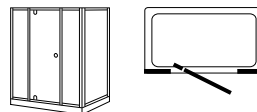

1600 x 760mm
1600 x 800mm
1600 x 900mm

1700 x 760mm
1700 x 800mm
1700 x 900mm

1800 x 760mm
1800 x 800mm
1800 x 900mm

Dimensions & tray compatibility

All sizes are in mm

Mira ACE pivot door	size	frame finish option	glass	frame adjustment alcove door	frame adjustment corner enclosure	door opening	10mm filler kit (if required)	Flight tray compatibility	Flight Low tray compatibility
108348	760	Silver	Clear	698-756	720-749	542	108423	760x760	760x760
108349	800	Silver	Clear	736-794	758-787	580	108423	800x800	800x800
108350	900	Silver	Clear	836-894	858-887	680	108423	900x900	900x900
108351	1000	Silver	Clear	936-994	958-987	780	108423	1000x760	1000x760
								1000x800	1000x800
side panels	Combine side panels with a door to create an enclosure. (see accessories pg 145-146 for more information).								
108371	760	Silver	Clear		720-749	n/a	n/a	n/a	n/a
108372	800	Silver	Clear		758-787	n/a	n/a	n/a	n/a
108373	900	Silver	Clear		858-887	n/a	n/a	n/a	n/a
in-line panel	Create larger enclosures using the ACE in-line panel (see accessories pg 145-146 for more information).								
108403	400	Silver	Clear		29mm		108423	1200x760	1200x760
								1200x800	1200x800
								1200x900	1400x760
								1400x800	1600x760
									1700x760



Adjustable ball catch

The adjustable ball catch used on the pivot door, offers additional installation, flexibility and performance. The catch can be adjusted to provide a high quality feel throughout the product's life.

Product features

- Reversible door for left or right hand opening
- Perfect for alcove or corner installation
- 29mm of adjustment on each wall profile for out of true walls
- Adjustable ball catch closing mechanism ensures a solid closing action
- 6mm toughened safety glass

- Suitable for power showers
- Height from top of tray: 1830mm
- 10 year guarantee



Mira ACE pivot pentagon - corner

The pentagon enclosure boasts minimalist styling, perfect when space is limited.



Configuration options

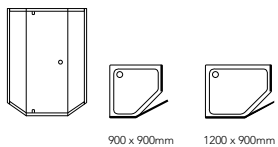

Dimensions & tray compatibility

All sizes are in mm

Mira ACE pivot pentagon	size	frame finish option	panel / door kit*	glass	frame adjustment alcove door	door opening	10mm filler kit (if required)	Flight tray compatibility	Flight Low tray compatibility
108348 109767	900 x 900	Silver	Door Panel	Clear	863-892	542	108423	900x900 Pentagon	900x900 Pentagon
108348 109768	1200 x 900	Silver	Door Panel	Clear	863-892 & 1163-1192	542	108423	1200x900 Pentagon	1200x900 Pentagon

*Panel and door kits need to combine to create unit.



Product features

- Reversible door for left or right hand opening
- For corner installation only
- 29mm of adjustment on each wall profile for out of true walls
- 4mm & 6mm toughened safety glass
- Power shower approved
- Height from top of tray: 1830mm

ACE shower enclosures

ACE shower enclosures

Mira ACE bi-fold door - alcove

The inward opening bi-fold door uses a planet gear mechanism and magnetic strips to ensure consistent alignment and closing performance throughout the lifetime of the product.



Configuration options

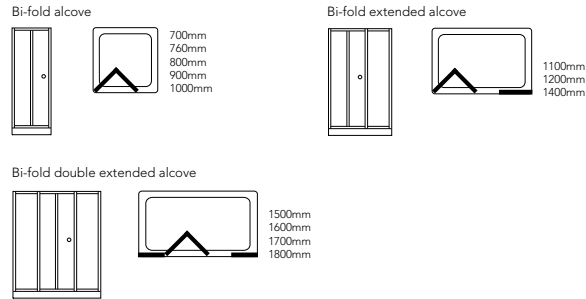

Planet gear

The planet gear mechanism, found on the bi-fold model, ensures correct alignment leading to a consistent smooth action. Magnetic strips along the top and bottom of the door ensure a strong closure.

Dimensions & tray compatibility

All sizes are in mm

Mira ACE bi-fold door	size	frame finish option	Glass	frame adjustment alcove door	frame adjustment corner enclosure	door opening	10mm filler kit (if required)	Flight tray compatibility	Flight Low tray compatibility
109750	700	Silver	Clear	638-696	660-689	375	108423	N/A	N/A
108352	760	Silver	Clear	698-756	720-749	440	108423	760x760	760x760
108353	800	Silver	Clear	736-794	758-787	478	108423	800x800	800x800
108354	900	Silver	Clear	836-894	858-887	577	108423	900x900	900x900
108355	1000	Silver	Clear	936-994	958-987	677	108423	1000x760	1000x760
								1000x800	1000x800
in-line panel	Create larger enclosures using the ACE in-line panel (see accessories pg 145-146 for more information).								
108403	400	Silver	Clear		29mm		108423	1200x760	1200x760
								1200x800	1200x800
								1200x900	1400x760
								1400x800	1600x760
									1700x760

*see pages 133-134 for bi-fold corner enclosure



Unique design details

The high quality finish, achieved in-house, provides a premium feel to any bathroom.

Product features

- Reversible door for left or right hand opening
- Perfect for alcove or corner installation
- 29mm of adjustment on each wall profile for out of true walls
- Planet gears ensure consistent alignment throughout the product's life
- 4mm toughened safety glass
- Power shower approved
- Height from top of tray: 1830mm
- 10 year guarantee



Mira ACE bi-fold door - corner

The inward opening bi-fold door uses a planet gear mechanism and magnetic strips to ensure consistent alignment and closing performance throughout the lifetime of the product.



Configuration options

Bi-fold corner enclosure

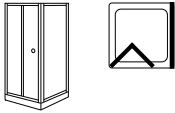

700 x 760mm	760 x 900mm	900 x 800mm
700 x 800mm	800 x 760mm	900 x 900mm
700 x 900mm	800 x 800mm	1000 x 760mm
760 x 760mm	800 x 900mm	1000 x 800mm
760 x 800mm	900 x 760mm	1000 x 900mm

Bi-fold extended corner enclosure

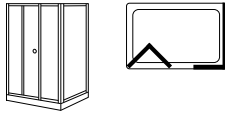

1100 x 760mm	1200 x 760mm	1400 x 760mm
1100 x 800mm	1200 x 800mm	1400 x 800mm
1100 x 900mm	1200 x 900mm	1400 x 900mm

Bi-fold double extended corner enclosure

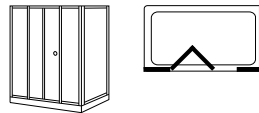

1500 x 760mm	1700 x 760mm	1800 x 760mm
1500 x 800mm	1700 x 800mm	1800 x 800mm
1500 x 900mm	1700 x 900mm	1800 x 900mm
1600 x 760mm		
1600 x 800mm		
1600 x 900mm		

Dimensions & tray compatibility

All sizes are in mm

Mira ACE bi-fold door	size	frame finish option	glass	frame adjustment alcove door	frame adjustment corner enclosure	door opening	10mm filler kit (if required)	Flight tray compatibility	Flight low tray compatibility
109750	700	Silver	Clear	638-696	660-689	375	108423	N/A	N/A
108352	760	Silver	Clear	698-756	720-749	440	108423	760x760	760x760
108353	800	Silver	Clear	736-794	758-787	478	108423	800x800	800x800
108354	900	Silver	Clear	836-894	858-887	577	108423	900x900	900x900
108355	1000	Silver	Clear	936-994	958-987	677	108423	1000x760	1000x760
								1000x800	1000x800
side panels	Combine side panels with a door to create an enclosure. (see accessories pg 145-146 for more information).								
108371	760	Silver	Clear		720-749	n/a	n/a	n/a	n/a
108372	800	Silver	Clear		758-787	n/a	n/a	n/a	n/a
108373	900	Silver	Clear		858-887	n/a	n/a	n/a	n/a
in-line panel	Create larger enclosures using the ACE in-line panel (see accessories pg 145-146 for more information).								
108403	400	Silver	Clear		29mm		108423	1200x760	1200x760
								1200x800	1200x800
								1200x900	1400x760
								1400x800	1600x760
									1700x760



Planet gear

The planet gear mechanism, found on the bi-fold model, ensures correct alignment leading to a consistent smooth action. Magnetic strips along the top and bottom of the door ensure a strong closure.

Product features

- Reversible door for left or right hand opening
- Perfect for alcove or corner installation
- 29mm of adjustment on each wall profile for out of true walls
- Planet gears ensure consistent alignment throughout the product's life
- 4mm toughened safety glass

- Power shower approved
- Height from top of tray: 1830mm
- 10 year guarantee



Mira ACE bi-fold pentagon - corner

The pentagon enclosure boasts minimalist styling, perfect when space is limited.



Configuration options

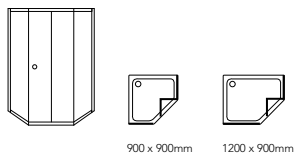

Dimensions & tray compatibility

All sizes are in mm

Mira ACE bi-fold pentagon	size	frame finish option	panel / door kit*	glass	frame adjustment alcove door	door opening	10mm filler kit (if required)	Flight tray compatibility	Flight Low tray compatibility
108352	900 x 900	Silver	Door	Clear	863-892	440	108423	900x900 Pentagon	900x900 Pentagon
108367			Panel						
108352	1200 x 900	Silver	Door	Clear	863-892 & 1163-1192	440	108423	1200x900 Pentagon	1200x900 Pentagon
108368			Panel						

*Panel and door kits need to combine to create unit.



Product features

- Reversible door for left or right hand opening
- For corner installation only
- 29mm of adjustment on each wall profile for out of true walls
- 4mm toughened safety glass
- Power shower approved
- Height from top of tray: 1830mm



Mira ACE sliding door - alcove

The Mira ACE sliding door delivers a consistent smooth gliding action through its double roller design and is an ideal option for larger shower spaces.



Configuration options

Sliding alcove

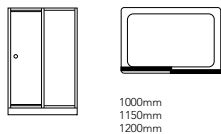

Unique design details

The high quality finish, achieved in-house, provides a premium feel to any bathroom.



6mm toughened safety glass

The toughened safety glass used on the Mira ACE sliding door is 6mm thick. It provides peace of mind and a feeling of high quality.

Dimensions & tray compatibility

All sizes are in mm

Mira ACE sliding door	size	frame finish option	glass	frame adjustment alcove door	frame adjustment corner enclosure	door opening	10mm filler kit (if required)	Flight tray compatibility	Flight Low tray compatibility
108400	1000	Silver	Clear	936-994	958-987	359	108423	1000x760 1000x800	1000x760 1000x800
109749	1150	Silver	Clear	1086-1144	1108-1137	420	108423	N/A	N/A
108401	1200	Silver	Clear	1136-1194	1158-1187	445	108423	1200x760 1200x800 1200x900	1200x760 1200x800



Double rollers

The double rollers on the sliding quadrant and corner entry doors provide a smooth, consistent gliding action to give a high quality feel and performance throughout the product's life.

Product features

- Reversible door for left or right hand opening
- Perfect for alcove or corner installation
- 29mm of adjustment on each wall profile for out of true walls
- Double rollers deliver smooth operation throughout the product's life
- 6mm toughened safety glass
- Power shower approved
- Height from top of tray: 1830mm
- 10 year guarantee



Mira ACE sliding door - corner

The Mira ACE sliding door delivers a consistent smooth gliding action through its double roller design and is an ideal option for larger shower spaces.



Configuration options

Sliding corner enclosure



1000 x 760mm
1000 x 800mm
1000 x 900mm
1150 x 760mm
1150 x 800mm
1150 x 900mm
1200 x 760mm
1200 x 800mm
1200 x 900mm

Dimensions & tray compatibility

All sizes are in mm

Mira ACE sliding door	size	frame finish option	glass	frame adjustment alcove door	frame adjustment corner enclosure	door opening	10mm filler kit (if required)	Flight tray compatibility	Flight Low tray compatibility
108400	1000	Silver	Clear	936-994	958-987	359	108423	1000x760 1000x800	1000x760 1000x800
109749	1150	Silver	Clear	1086-1144	1108-1137	420	108423	N/A	N/A
108401	1200	Silver	Clear	1136-1194	1158-1187	445	108423	1200x760 1200x800 1200x900	1200x760 1200x800
side panels	Combine side panels with a door to create an enclosure. (see accessories pg 145-146 for more information).								
108371	760	Silver	Clear		720-749	n/a	n/a	n/a	n/a
108372	800	Silver	Clear		758-787	n/a	n/a	n/a	n/a
108373	900	Silver	Clear		858-887	n/a	n/a	n/a	n/a



6mm toughened safety glass

The toughened safety glass used on the Mira ACE sliding door is 6mm thick. It provides peace of mind and a feeling of high quality.



Double rollers

The double rollers on the sliding quadrant and corner entry doors provide a smooth, consistent gliding action to give a high quality feel and performance throughout the product's life.

Product features

- Reversible door for left or right hand opening
- Perfect for alcove or corner installation
- 29mm of adjustment on each wall profile for out of true walls
- Double rollers deliver smooth operation throughout the product's life
- 6mm toughened safety glass
- Power shower approved
- Height from top of tray: 1830mm
- 10 year guarantee



Mira ACE quadrant

The Mira ACE double sliding door quadrant delivers a consistent smooth gliding action through its double roller design providing ease of access where space in the bathroom is limited.



Configuration options

Quadrant

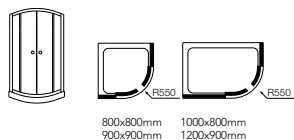

5mm toughened safety glass

The toughened safety glass used on the Mira ACE quadrant door is 5mm thick. It provides peace of mind and a feeling of high quality.

Dimensions & tray compatibility

All sizes are in mm

Mira ACE quadrant	size	frame finish option	panel / door kit*	glass	frame adjustment alcove door	door opening	10mm filler kit (if required)	Flight tray compatibility	Flight Low tray compatibility
108392	800 x 800	Silver	Panel	Clear	772-801	420	108423	800 Quad	800 Quad
108396	800 x 800	Silver	Door	Clear	772-801	420	108423	800 Quad	800 Quad
108393	900 x 900	Silver	Panel	Clear	872-901	490	108423	900 Quad	900 Quad
108397	900 x 900	Silver	Door	Clear	872-901	490	108423	900 Quad	900 Quad
109755	1000 x 800	Silver	Panel	Clear	972-1001 & 772-801	490	108423	1000x800 Quad LH/RH	1000x800 Quad LH/RH
109757	1000 x 800	Silver	Door	Clear	972-1001 & 772-801	490	108423	1000x800 Quad LH/RH	1000x800 Quad LH/RH
109756	1200 x 900	Silver	Panel	Clear	1172-1201 & 872-901	490	108423	1200x900 Quad LH/RH	1200x900 Quad LH/RH
109758	1200 x 900	Silver	Door	Clear	1172-1201 & 872-901	490	108423	1200x900 Quad LH/RH	1200x900 Quad LH/RH

*Panel and door kits need to combine to create unit.



Double rollers

The double rollers on the sliding quadrant and corner entry doors provide a smooth, consistent gliding action to give a high quality feel and performance throughout the product's life.

Product features

- Centre opening doors
- For corner installation only
- 29mm of adjustment on each wall profile for out of true walls
- Double rollers deliver smooth operation throughout the product's life
- 5mm toughened safety glass
- Power shower approved
- Height from top of tray: 1830mm
- 10 year guarantee



Mira ACE corner entry

The Mira ACE corner entry is a space efficient design that delivers a consistent smooth gliding action through its double roller design.



Configuration options

Corner entry enclosure

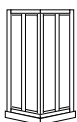

800 x 800mm
900 x 900mm



Unique design details

The high quality finish, achieved in-house, provides a premium feel to any bathroom.



6mm toughened safety glass

The toughened safety glass used on the Mira ACE corner entry is 6mm thick. It provides peace of mind and a feeling of high quality.

Dimensions & tray compatibility

All sizes are in mm

Mira ACE corner entry	size	frame finish option	glass	frame adjustment alcove door	door opening	10mm filler kit (if required)	Flight tray compatibility	Flight Low tray compatibility
108404 Doors LH Kit	800	Silver	Clear	29mm	380	108423	800x800	800x800
108405 Doors RH Kit	800	Silver	Clear	29mm	380	108423	800x800	800x800
108406 Doors LH Kit	900	Silver	Clear	29mm	450	108423	900x900	900x900
108407 Doors RH Kit	900	Silver	Clear	29mm	450	108423	900x900	900x900



Double rollers

The double rollers on the sliding quadrant and corner entry doors provide a smooth, consistent gliding action to give a high quality feel and performance throughout the product's life.

Product features

- Centre opening doors
- For corner installation only
- 29mm of adjustment on each wall profile for out of true walls
- Double rollers deliver smooth operation throughout the product's life
- 6mm toughened safety glass
- Power shower approved
- Height from top of tray: 1830mm
- 10 year guarantee



Mira ACE accessories



10mm filler section

Mira ACE 10mm filler section suitable to use with all doors, side panels and enclosures. Extend the width of a door, side panel and enclosure by 10mm.

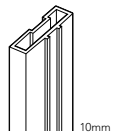

All sizes are in mm

Mira ACE filler section	size	frame finish option	glass	frame adjustment	door opening	10mm filler kit (if required)	Flight tray compatibility	Flight Low tray compatibility
108423	10	Silver	n/a	n/a	n/a	n/a	n/a	n/a

Side panels

Mira ACE side panels create corner enclosures when combined with a pivot, bi-fold and sliding doors.

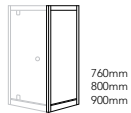

All sizes are in mm

Mira ACE side panels	size	frame finish option	glass	frame adjustment	door opening	10mm filler kit (if required)	Flight tray compatibility	Flight Low tray compatibility
108371	760	Silver	Clear	720-749	n/a	n/a	n/a	n/a
108372	800	Silver	Clear	758-787	n/a	n/a	n/a	n/a
108373	900	Silver	Clear	858-887	n/a	n/a	n/a	n/a

Product features (side panels only)

- For corner installation only
- 4mm toughened safety glass
- 29mm adjustment on each wall profile for out of true walls
- Power shower approved
- Height from top of tray: 1830mm
- 10 year guarantee

Mira ACE accessories



400mm inline panel

Mira ACE inline panel to suit pivot and bi-fold doors. Combine inline panel with pivot and bi-fold doors for an extended enclosure e.g. one inline panel combined with a standard 800mm pivot door = 1200mm width.

Pivot extended alcove

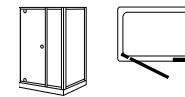

1200mm
1400mm

Pivot extended corner enclosure

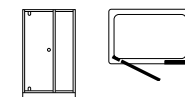

1200 x 760mm
1200 x 800mm
1200 x 900mm
1400 x 760mm
1400 x 800mm
1400 x 900mm

Pivot double extended corner enclosure

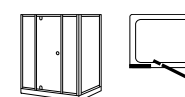

Also available for use with bi-fold door

1600 x 760mm
1600 x 800mm
1600 x 900mm
1700 x 760mm
1700 x 800mm
1700 x 900mm
1800 x 760mm
1800 x 800mm
1800 x 900mm

Product features

- For alcove or corner installation only
- 4mm toughened safety glass
- 29mm adjustment on each wall profile for out of true walls
- Power shower approved
- Height from top of tray: 1830mm
- 10 year guarantee

All sizes are in mm

Mira ACE inline panels	size	frame finish option	glass	frame adjustment	door opening	10mm filler kit (if required)	Flight tray compatibility	Flight Low tray compatibility
108403	400	Silver	Clear	n/a	n/a	108423	n/a	n/a





Mira Beam shower enclosures

Robust and easy to install, Mira Beam shower enclosures give watertight confidence in a simple strong design.

Thoughtfully engineered design details ensure durability and longevity and provide maximum flexibility on your installation with up to 29mm of adjustment for uneven walls. Frameless doors provide a premium feel and a wide range of door types and size options available to deliver an enclosure to complement any bathroom. Our investment in research and development keeps us at the forefront of design and technology so we can provide our customers with flexible robust shower solutions to suit any bathroom.

Combining design and technology

Coated Glass

High quality coated glass means your Beam enclosure will retain its premium look by being easy to clean.

Planet gear

The planet gear mechanism, found on the bi-fold model, ensures correct alignment leading to a consistent smooth action. Magnetic strips along the top and bottom of the door ensure a strong consistent closure.

Double rollers

The double rollers on the sliding quadrant and corner entry doors provide a smooth consistent gliding action to give a high quality feel and performance throughout the product's life.

Unique design details

The high quality finish, achieved in-house, provides a premium feel to any bathroom.

Adjustable ball catch

The adjustable ball catch used on the pivot door, offers additional installation flexibility and performance. The catch can be adjusted to provide a high quality feel throughout the product's life.

Mira Beam shower enclosure contents

Mira Beam divider panels	153-154
Mira Beam pivot door – alcove	155-156
Mira Beam pivot door – corner	157-158
Mira Beam bi-fold door – alcove	159-160
Mira Beam bi-fold door – corner	161-162
Mira Beam sliding door – alcove	163-164
Mira Beam sliding door – corner	165-166
Mira Beam quadrant	167-168
Mira Beam pivot pentagon – corner	169-170
Mira Beam bi-fold pentagon - corner	171-172
Mira Beam walk-in – alcove	173-174
Mira Beam walk-in – corner	175-176
Mira Beam accessories	177-178



Bi-fold door, planet gear mechanism

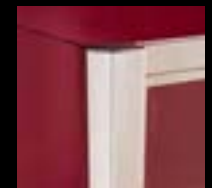

High quality polished silver finish

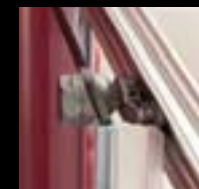

Sliding door, double roller bogeys



Pivot door, adjustable ball catch

How to choose your Mira Beam alcove or corner shower enclosure

Whatever you're looking for in a shower enclosure, it can be found within the new Mira Beam enclosure range. But which is right for you? Just follow these 3 simple steps:

Step 1 - preparation

Measure the width of your shower door but importantly also measure the space available in the bathroom to get in and out, and for the door to open.

Step 2 - choose your location

Are you installing the door in an alcove or corner site?

Step 3 - choose your door type: alcove or corner enclosure

Alcove enclosure

N.B. Remember to check that the door opening is wide enough for your needs

Walk-in - a walk-in enclosure has no door at all so you can just walk straight in and shower. Remember that there will always be some water splashing on the floor with a walk-in.

Pivot door - offers the widest opening for a given size of enclosure – just make sure that there is space in the bathroom for the door to open. Remember the door is reversible so can open to the left or right.

Bi-fold door - ideal if there is not enough space in the bathroom for a pivot door as the door folds inwards. May not be the best solution if your mobility is limited as you will need to move out of the way of the door to open it.

Slider - another door that does not intrude into the bathroom space and provides a very easy to use solution for widths of 1000mm and over.

Corner enclosure

N.B. Don't forget to order a side panel as well as a door to complete the enclosure. Remember to check that the door opening is wide enough for your needs.

Walk-in - a walk-in enclosure has no door at all so you can just walk straight in and shower. Remember that there will always be some water splashing on the floor with a walk-in.

Pivot door - offers the widest opening for a given size of enclosure – just make sure that there is space in the bathroom for the door to open. Remember the door is reversible so can open to the left or right.

Bi-fold door - ideal if there is not enough space in the bathroom for a pivot door as the door folds inwards. May not be the best solution if your mobility is limited as you will need to move out of the way of the door to open it.

Slider - another door that doesn't intrude into the bathroom space and provides a very easy to use solution for widths of 1000mm and over.

Quadrant - a very space efficient solution with its double sliding doors and elegant curved shape.

Pentagon - gives more usable space in the bathroom as the door opening is central.

Divider panel - allow an unobtrusive frameless structure with unique modern styling.



Overview - Mira Beam enclosures

Walk-in alcove

Walk-in alcove

1400 x 800mm
1700 x 700mm

1400 x 800mm
Right hand showering area

1700 x 700mm
Right hand showering area

80mm
Right hand tray low level

Walk-in corner entry

Walk-in corner entry

1400 x 800mm
1700 x 700mm

1400 x 800mm
Right hand showering area

1700 x 700mm
Right hand showering area

80mm
Right hand tray low level

Pivot alcove

Pivot alcove

760mm
800mm
900mm
1000mm

Pivot extended alcove

1200mm
1400mm

Pivot double extended alcove

1600mm
1700mm
1800mm

Pivot corner enclosure

Pivot corner enclosure

760 x 700mm
760 x 760mm
760 x 800mm
760 x 900mm
800 x 700mm
800 x 760mm
800 x 800mm
800 x 900mm

900 x 700mm
900 x 760mm
900 x 800mm
900 x 900mm
1000 x 700mm
1000 x 760mm
1000 x 800mm
1000 x 900mm

Pivot extended corner enclosure

1200 x 700mm
1200 x 760mm
1200 x 800mm
1200 x 900mm

1400 x 700mm
1400 x 760mm
1400 x 800mm
1400 x 900mm

Pivot double extended corner enclosure

1600 x 700mm
1600 x 760mm
1600 x 800mm
1600 x 900mm
1700 x 700mm
1700 x 760mm

1700 x 800mm
1700 x 900mm
1800 x 700mm
1800 x 760mm
1800 x 800mm
1800 x 900mm

Bi-fold alcove

Bi-fold alcove

760mm
800mm
900mm
1000mm

Bi-fold extended alcove

1200mm
1400mm

Bi-fold double extended alcove

1600mm
1700mm
1800mm

Bi-fold corner enclosure

Bi-fold corner enclosure

760 x 700mm
760 x 760mm
760 x 800mm
760 x 900mm
800 x 700mm
800 x 760mm

800 x 800mm
800 x 900mm
900 x 700mm
900 x 760mm
900 x 800mm
900 x 900mm

1000 x 700mm
1000 x 760mm
1000 x 800mm
1000 x 900mm

Bi-fold extended corner enclosure

1200 x 700mm
1200 x 760mm
1200 x 800mm
1200 x 900mm

1400 x 700mm
1400 x 760mm
1400 x 800mm
1400 x 900mm

Bi-fold double extended corner enclosure

1600 x 700mm
1600 x 760mm
1600 x 800mm
1600 x 900mm
1700 x 700mm
1700 x 760mm

1700 x 800mm
1700 x 900mm
1800 x 700mm
1800 x 760mm
1800 x 800mm
1800 x 900mm

Sliding alcove

Sliding alcove

1000mm
1200mm

Sliding corner

Sliding corner enclosure

1000 x 700mm
1000 x 760mm
1000 x 800mm
1000 x 900mm

1200 x 700mm
1200 x 760mm
1200 x 800mm
1200 x 900mm

Pivot Pentagon

Pivot pentagon corner enclosure

900 x 900mm
1200 x 900mm

Bi-fold Pentagon

Bi-fold pentagon corner enclosure

900 x 900mm
1200 x 900mm

Divider Panel

Divider Panel

800mm
900mm

1000mm
1200mm

Quadrant

Quadrant

800x800mm
900x900mm

1000x800mm
1200x900mm

Accessories

Filler profile

10mm

In-line panels

400mm
2x400mm

Side panels

760mm
800mm
900mm

Mira Beam divider panels

The Mira beam divider panels enable you to create the ultimate wet room look.

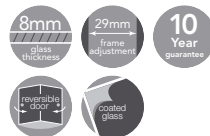

Configuration options

Divider Panel

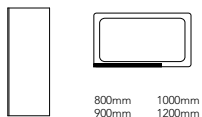

Dimensions & tray compatibility

All sizes are in mm

Mira Beam divider panels	size	frame finish option	glass	frame adjustment alcove door	frame adjustment corner enclosure	door opening	10mm filler kit (if required)	Flight tray compatibility	Flight Low tray compatibility
1.1721.423	800	Silver	Clear	n/a	755-784	n/a	n/a	1200x760	1200x760
								1200x800	1200x800
								1200x900	1200x900
								1400x700	1400x700
1.1721.424	900	Silver	Clear	n/a	855-884	n/a	n/a	1400x800	1400x800
								1400x800	1400x800
								1400x900	1400x900
								1400x760	1400x760
1.1721.425	1000	Silver	Clear	n/a	955-984	n/a	n/a	1400x700	1400x700
								1400x760	1400x760
								1400x800	1400x800
								1400x900	1400x900
								1500x700	1500x700
								1500x760	1500x760
1.1721.426	1200	Silver	Clear	n/a	1155-1184	n/a	n/a	1600x700	1600x700
								1600x760	1600x760
								1500x900	1500x900
								1700x700	1700x700
								1700x760	1700x760
								1700x900	1700x900

Combine side panels with a door to create an enclosure. (see accessories pg 177-178 for more information).

Product features

- 8mm frameless safety glass panels
- Coated glass for ease of cleaning
- Water-tight wall profile
- Height: 1950mm
- Unique 29mm adjustment system on wall profile
- Square-section bracing bar adjustable at point of installation
- Available with wet-room floor anchor kit
- Recommended for use with Flight trays & Flight Low trays
- Recommended minimum tray rim width is 30mm
- Lifetime guarantee



45° bracing bar



900x900 with 45° bracing bar



Beam shower enclosures

Beam shower enclosures

Mira Beam pivot door - alcove

The frameless pivot door is adjustable up to 29mm and has a ball catch closing mechanism that can be adjusted to deliver a firm closing action.



Configuration options

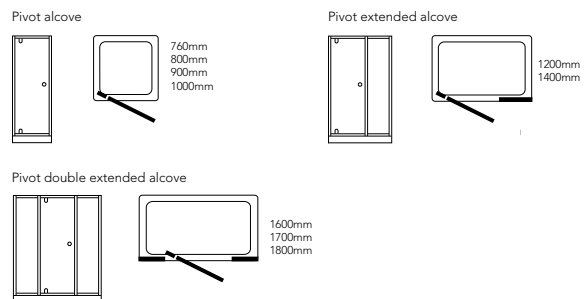

Dimensions & tray compatibility

All sizes are in mm

Mira Beam pivot door	size	frame finish option	glass	frame adjustment alcove door	frame adjustment corner enclosure	door opening	10mm filler kit (if required)	Flight tray compatibility	Flight Low tray compatibility
1.1721.403	760	Silver	Clear	698-756	720-749	542	1.1721.427	760x760	760x760
1.1721.404	800	Silver	Clear	736-794	758-787	580	1.1721.427	800x800	800x800
1.1721.405	900	Silver	Clear	836-894	858-887	680	1.1721.427	900x900	900x900
1.1721.406	1000	Silver	Clear	936-994	958-987	780	1.1721.427	1000x760	1000x760
								1000x800	1000x800
in-line panel	Create larger enclosures using the Beam in-line panel (see accessories pg 177-178 for more information).								
1.1721.413	400	Silver	Clear		29mm		1.1721.427	1200x760	1200x760
								1200x800	1200x800
								1200x900	1400x760
								1400x800	1600x760
									1700x760

*see pages 157-158 for pivot door corner enclosure

Product features

- Reversible door for left or right hand opening
- Perfect for alcove or corner installation
- 29mm of adjustment on each wall profile for out of true walls
- Adjustable ball catch closing mechanism ensures a solid closing action
- 6mm toughened safety glass - coated for easy cleaning
- Suitable for power showers
- Height from top of tray: 1900mm
- 10 year guarantee



Adjustable ball catch

The adjustable ball catch used on the pivot door, offers additional installation flexibility and performance. The catch can be adjusted to provide a high quality feel throughout the product's life.



Unique design details



Beam shower enclosures

Beam shower enclosures

Mira Beam pivot door - corner

The frameless pivot door is adjustable up to 29mm and has a ball catch closing mechanism that can be adjusted to deliver a firm closing action.



Configuration options

Pivot corner enclosure

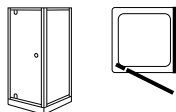

760 x 700mm	800 x 800mm	1000 x 700mm
760 x 760mm	800 x 900mm	1000 x 760mm
760 x 800mm	900 x 700mm	1000 x 800mm
760 x 900mm	900 x 760mm	1000 x 900mm
800 x 700mm	900 x 800mm	
800 x 760mm	900 x 900mm	

Pivot extended corner enclosure

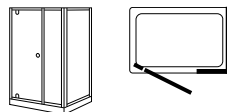

1200 x 700mm	1400 x 700mm
1200 x 760mm	1400 x 760mm
1200 x 800mm	1400 x 800mm
1200 x 900mm	1400 x 900mm

Pivot double extended corner enclosure

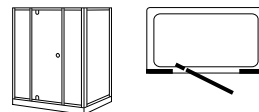

1600 x 700mm	1700 x 700mm	1800 x 700mm
1600 x 760mm	1700 x 760mm	1800 x 760mm
1600 x 800mm	1700 x 800mm	1800 x 800mm
1600 x 900mm	1700 x 900mm	1800 x 900mm

Dimensions & tray compatibility

All sizes are in mm

Mira Beam pivot door	size	frame finish option	glass	frame adjustment alcove door	frame adjustment corner enclosure	door opening	10mm filler kit (if required)	Flight tray compatibility	Flight Low tray compatibility
1.1721.403	760	Silver	Clear	698-756	720-749	542	1.1721.427	760x760	760x760
1.1721.404	800	Silver	Clear	736-794	758-787	580	1.1721.427	800x800	800x800
1.1721.405	900	Silver	Clear	836-894	858-887	680	1.1721.427	900x900	900x900
1.1721.406	1000	Silver	Clear	936-994	958-987	780	1.1721.427	1000x760	1000x760
								1000x800	1000x800
side panels	Combine side panels with a door to create an enclosure. (see accessories pg 177-178 for more information).								
1.1721.414	700	Silver	Clear	658-687	n/a	n/a	n/a	n/a	n/a
1.1721.415	760	Silver	Clear	720-749	n/a	n/a	n/a	n/a	n/a
1.1721.416	800	Silver	Clear	758-787	n/a	n/a	n/a	n/a	n/a
1.1721.417	900	Silver	Clear	858-887					
in-line panel	Create larger enclosures using the Beam in-line panel (see accessories pg 177-178 for more information).								
1.1721.413	400	Silver	Clear		29mm		1.1721.427	1200x760	1200x760
								1200x800	1200x800
								1200x900	1400x760
								1400x800	1600x760
									1700x760



Adjustable ball catch

The adjustable ball catch used on the pivot door, offers additional installation, flexibility and performance. The catch can be adjusted to provide a high quality feel throughout the product's life.

Product features

- Reversible door for left or right hand opening
- Perfect for alcove or corner installation
- 29mm of adjustment on each wall profile for out of true walls
- Adjustable ball catch closing mechanism ensures a solid closing action
- 6mm toughened safety glass - coated for easy cleaning
- Suitable for power showers
- Height from top of tray: 1900mm
- 10 year guarantee



Mira Beam bi-fold door - alcove

The inward opening bi-fold door uses a planet gear mechanism and magnetic strips to ensure consistent alignment and closing performance throughout the lifetime of the product.



Configuration options

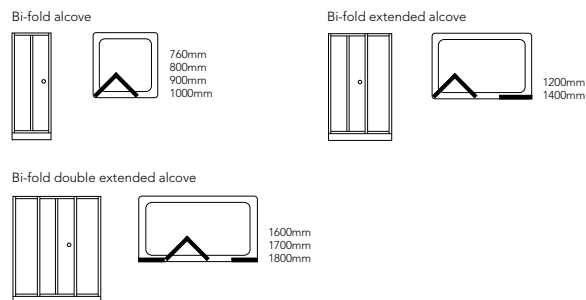

Planet gear

The planet gear mechanism, found on the bi-fold model, ensures correct alignment leading to a consistent smooth action. Magnetic strips along the top and bottom of the door ensure a strong closure.

Dimensions & tray compatibility

All sizes are in mm

Mira Beam bi-fold door	size	frame finish option	Glass	frame adjustment alcove door	frame adjustment corner enclosure	door opening	10mm filler kit (if required)	Flight tray compatibility	Flight Low tray compatibility
1.1721.407	760	Silver	Clear	698-756	720-749	440	1.1721.427	760x760	760x760
1.1721.408	800	Silver	Clear	736-794	758-787	478	1.1721.427	800x800	800x800
1.1721.409	900	Silver	Clear	836-894	858-887	577	1.1721.427	900x900	900x900
1.1721.410	1000	Silver	Clear	936-994	958-987	677	1.1721.427	1000x760	1000x760
								1000x800	1000x800
in-line panel	Create larger enclosures using the Beam in-line panel (see accessories pg 177-178 for more information).								
1.1721.413	400	Silver	Clear		29mm		1.1721.427	1200x760	1200x760
								1200x800	1200x800
								1200x900	1400x760
								1400x800	1600x760
									1700x760

*see pages 133-134 for bi-fold corner enclosure



Unique design details

The high quality finish, achieved in-house, provides a premium feel to any bathroom.

Product features

- Reversible door for left or right hand opening
- Perfect for alcove or corner installation
- 29mm of adjustment on each wall profile for out of true walls
- Planet gears ensure consistent alignment throughout the product's life
- 4mm toughened safety glass - coated for easy cleaning
- Power shower approved
- Height from top of tray: 1900mm
- 10 year guarantee



Mira Beam bi-fold door - corner

The inward opening bi-fold door uses a planet gear mechanism and magnetic strips to ensure consistent alignment and closing performance throughout the lifetime of the product.



Configuration options

Bi-fold corner enclosure

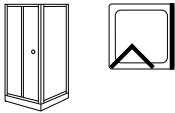

760 x 700mm	800 x 700mm	900 x 700mm	1000 x 700mm
760 x 760mm	800 x 760mm	900 x 760mm	1000 x 760mm
760 x 800mm	800 x 800mm	900 x 800mm	1000 x 800mm
760 x 900mm	800 x 900mm	900 x 900mm	1000 x 900mm

Bi-fold extended corner enclosure

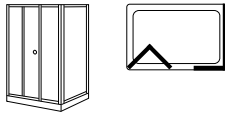

1200 x 700mm	1400 x 700mm
1200 x 760mm	1400 x 760mm
1200 x 800mm	1400 x 800mm
1200 x 900mm	1400 x 900mm

Bi-fold double extended corner enclosure

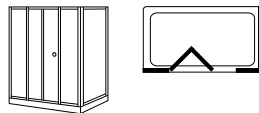

1600 x 700mm	1700 x 700mm	1800 x 700mm
1600 x 760mm	1700 x 760mm	1800 x 760mm
1600 x 800mm	1700 x 800mm	1800 x 800mm
1600 x 900mm	1700 x 900mm	1800 x 900mm

Dimensions & tray compatibility

All sizes are in mm

Mira Beam bi-fold door	size	frame finish option	glass	frame adjustment alcove door	frame adjustment corner enclosure	door opening	10mm filler kit (if required)	Flight tray compatibility	Flight Low tray compatibility
1.1721.407	760	Silver	Clear	698-756	720-749	440	1.1721.427	760x760	760x760
1.1721.408	800	Silver	Clear	736-794	758-787	478	1.1721.427	800x800	800x800
1.1721.409	900	Silver	Clear	836-894	858-887	577	1.1721.427	900x900	900x900
1.1721.410	1000	Silver	Clear	936-994	958-987	677	1.1721.427	1000x760	1000x760
								1000x800	1000x800
side panels	Combine side panels with a door to create an enclosure. (see accessories pg 177-178 for more information).								
1.1721.414	700	Silver	Clear		658-687	n/a	n/a	n/a	n/a
1.1721.415	760	Silver	Clear		720-749	n/a	n/a	n/a	n/a
1.1721.416	800	Silver	Clear		758-787	n/a	n/a	n/a	n/a
1.1721.417	900	Silver	Clear		858-887	n/a	n/a	n/a	n/a
in-line panel	Create larger enclosures using the Beam in-line panel (see accessories pg 177-178 for more information).								
1.1721.413	400	Silver	Clear		29mm		1.1721.427	1200x760	1200x760
								1200x800	1200x800
								1200x900	1400x760
								1400x800	1600x760
									1700x760



Planet gear

The planet gear mechanism, found on the bi-fold model, ensures correct alignment leading to a consistent smooth action. Magnetic strips along the top and bottom of the door ensure a strong closure.

Product features

- Reversible door for left or right hand opening
- Perfect for alcove or corner installation
- 29mm of adjustment on each wall profile for out of true walls
- Planet gears ensure consistent alignment throughout the product's life
- 4mm toughened safety glass - coated for easy cleaning
- Power shower approved
- Height from top of tray: 1900mm
- 10 year guarantee



Beam shower enclosures

Beam shower enclosures

Mira Beam sliding door - alcove

The Mira Beam sliding door delivers a consistent smooth gliding action through its double roller design and is an ideal option for larger shower spaces.



Configuration options

Sliding alcove

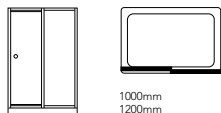

1000mm
1200mm



Unique design details

The high quality finish, achieved in-house, provides a premium feel to any bathroom.



6mm toughened safety glass

The toughened safety glass used on the Mira Beam sliding door is 6mm thick. It provides peace of mind and a feeling of high quality.

Dimensions & tray compatibility

All sizes are in mm

Mira Beam sliding door	size	frame finish option	glass	frame adjustment alcove door	frame adjustment corner enclosure	door opening	10mm filler kit (if required)	Flight tray compatibility	Flight Low tray compatibility
1.1721.411	1000	Silver	Clear	936-994	958-987	359	1.1721.427	1000x760 1000x800	1000x740 1000x800
1.1721.412	1200	Silver	Clear	1136-1194	1158-1187	445	1.1721.427	1200x760 1200x800 1200x900	1200x760 1200x800



Double rollers

The double rollers on the sliding and quadrant doors provide a smooth, consistent gliding action to give a high quality feel and performance throughout the product's life.

Product features

- Reversible door for left or right hand opening
- Perfect for alcove or corner installation
- 29mm of adjustment on each wall profile for out of true walls
- Double rollers deliver smooth operation throughout the product's life
- 6mm toughened safety glass - coated for easy cleaning
- Power shower approved
- Height from top of tray: 1900mm
- 10 year guarantee



Beam shower enclosures

Beam shower enclosures

Mira Beam sliding door - corner

The Mira Beam sliding door delivers a consistent smooth gliding action through its double roller design and is an ideal option for larger shower spaces.



Configuration options

Sliding corner enclosure

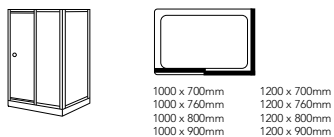

1000 x 700mm
1000 x 760mm
1000 x 800mm
1000 x 900mm

1200 x 700mm
1200 x 760mm
1200 x 800mm
1200 x 900mm

Dimensions & tray compatibility

All sizes are in mm

Mira Beam sliding door	size	frame finish option	glass	frame adjustment alcove door	frame adjustment corner enclosure	door opening	10mm filler kit (if required)	Flight tray compatibility	Flight Low tray compatibility
1.1721.411	1000	Silver	Clear	936-994	958-987	359	1.1721.427	1000x760 1000x800	1000x760 1000x800
1.1721.412	1200	Silver	Clear	1136-1194	1158-1187	445	1.1721.427	1200x760 1200x800	1200x760 1200x800
side panels	Combine side panels with a door to create an enclosure. (see accessories pg 177-178 for more information).								
1.1721.414	700	Silver	Clear		658-687	n/a	n/a	n/a	n/a
1.1721.415	760	Silver	Clear		720-749	n/a	n/a	n/a	n/a
1.1721.416	800	Silver	Clear		758-787	n/a	n/a	n/a	n/a
1.1721.417	900	Silver	Clear		858-887	n/a	n/a	n/a	n/a



6mm toughened safety glass

The toughened safety glass used on the Mira Beam sliding door is 6mm thick. It provides peace of mind and a feeling of high quality.



Double rollers

The double rollers on the sliding and quadrant doors provide a smooth, consistent gliding action to give a high quality feel and performance throughout the product's life.

Product features

- Reversible door for left or right hand opening
- Perfect for alcove or corner installation
- 29mm of adjustment on each wall profile for out of true walls
- Double rollers deliver smooth operation throughout the product's life
- 6mm toughened safety glass - coated for easy cleaning
- Power shower approved
- Height from top of tray: 1900mm
- 10 year guarantee



Beam shower enclosures

Beam shower enclosures

Mira Beam quadrant

The Mira Beam double door sliding quadrant delivers a consistent smooth gliding action through its double roller design providing ease of access where space in the bathroom is limited.



Configuration options

Quadrant

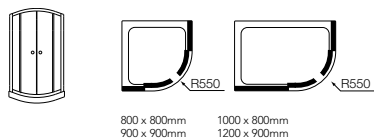

800 x 800mm
900 x 900mm

1000 x 800mm
1200 x 900mm



5mm toughened safety glass

The toughened safety glass used on the Mira Beam quadrant door is 5mm thick. It provides peace of mind and a feeling of high quality.

Dimensions & tray compatibility

All sizes are in mm

Mira Beam quadrant	size	frame finish option	panel / door kit*	glass	frame adjustment alcove door	door opening	10mm filler kit (if required)	Flight tray compatibility	Flight Low tray compatibility
1.1721.418	800 x 800	Silver	Panel	Clear	772-801	420	1.1721.427	800 Quad	800 Quad
1.1721.421	800		Door						
1.1721.419	900 x 900	Silver	Panel	Clear	872-901	490	1.1721.427	900 Quad	900 Quad
1.1721.422			Door						
1.1721.453	1000 x 800	Silver	Panel	Clear	972-1001 & 772-801	490	1.1721.427	1000x800 Quad LH/RH	1000x800 Quad LH/RH
1.1721.507			Door						
1.1721.454	1200 x 900	Silver	Panel	Clear	1172-1201 & 872-901	490	1.1721.427	1200x900 Quad LH/RH	1200x900 Quad LH/RH
1.1721.509			Door						

*Panel and door kits need to combine to create unit.



Double rollers

The double rollers on the sliding and quadrant doors provide a smooth, consistent gliding action to give a high quality feel and performance throughout the product's life.

Product features

- Centre opening doors
- For corner installation only
- 29mm of adjustment on each wall profile for out of true walls
- Double rollers deliver smooth operation throughout the product's life
- 5mm toughened safety glass - coated for easy cleaning
- Power shower approved
- Height from top of tray: 1900mm
- 10 year guarantee



Mira Beam pivot pentagon - corner

The pentagon enclosure boasts minimalist styling, perfect when space is limited.



Configuration options

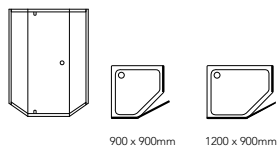

Unique design details

Dimensions & tray compatibility

All sizes are in mm

Mira Beam pivot pentagon	size	frame finish option	panel / door kit*	glass	frame adjustment alcove door	door opening	10mm filler kit (if required)	Flight tray compatibility	Flight Low tray compatibility
1.1721.403	900 x 900	Silver	Door	Clear	863-892	542	1.1721.427	900x900 Pentagon	900x900 Pentagon
1.1721.448	900		Panel						
1.1721.403	1200 x 900	Silver	Door	Clear	863-892 & 1163-1192	542	1.1721.427	1200x900 Pentagon	1200x900 Pentagon
1.1721.449	900		Panel						

*Panel and door kits need to combine to create unit.



900x900 option

Product features

- Reversible door for left or right hand opening
- For corner installation only
- 29mm of adjustment on each wall profile for out of true walls
- Adjustable ball catch closing mechanism ensures a solid closing action
- 4mm & 6mm toughened safety glass - coated for easy cleaning
- Power shower approved
- Height from top of tray: 1900mm
- 10 year guarantee



Mira Beam bi-fold pentagon - corner

The pentagon enclosure boasts minimalist styling, perfect when space is limited.



Configuration options

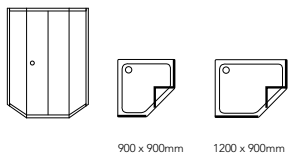

Planet gear

The planet gear mechanism, found on the bi-fold model, ensures correct alignment leading to a consistent smooth action. Magnetic strips along the top and bottom of the door ensure a strong closure.

Dimensions & tray compatibility

All sizes are in mm

Mira Beam Bi-fold pentagon	size	frame finish option	panel / door kit*	glass	frame adjustment alcove door	door opening	10mm filler kit (if required)	Flight tray compatibility	Flight Low tray compatibility
1.1721.407	900 x 900	Silver	Door	Clear	863-892	440	1.1721.427	900x900 Pentagon	900x900 Pentagon
1.1721.448			Panel						
1.1721.407	1200 x 900	Silver	Door	Clear	863-892 & 1163-1192	440	1.1721.427	1200x900 Pentagon	1200x900 Pentagon
1.1721.449			Panel						

*Panel and door kits need to combine to create unit.



1200x900 option

Product features

- Reversible door for left or right hand opening
- For corner installation only
- Planet gears ensure consistent alignment throughout the product's life
- 29mm of adjustment on each wall profile for out of true walls
- 4mm toughened safety glass - coated for easy cleaning
- Power shower approved
- Height from top of tray: 1900mm
- 10 year guarantee



Beam shower enclosures

Beam shower enclosures

Mira Beam walk-in - alcove

Defined by the smooth elegant curve of the glass panel, the Mira Beam walk-in offers the ultimate in luxury showering. The alcove walk-in installs between two walls for the most ultra-modern look and creative use of space.

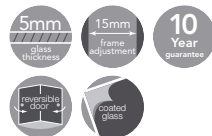

Configuration options

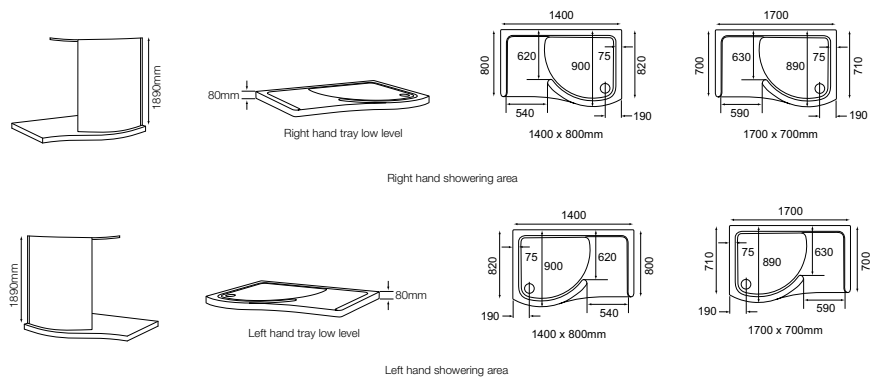

Dimensions, tray compatibility & pricing

All sizes are in mm

Mira Beam walk-in (alcove)	size	frame finish option	glass	end panel adjustment	door opening	18mm filler kit (if required)	flight tray compatibility
1.1721.569	1400x800	Silver	Clear	n/a	540	1.1721.573	1400x800 L/H 1400x800 R/H
1.1721.570	1700x700	Silver	Clear	n/a	590	1.1721.573	1700x700 L/H 1700x700 R/H



Product features

- Frameless panels give contemporary minimal styling
- Walk-in enclosure for a touch of luxury
- Reversible for left or right hand tray
- For installation in alcove
- Frame adjustment for uneven walls
- 5mm toughened safety glass
- Power shower approved*
- Height from top of tray: 1890mm
- 10 year guarantee

*Some splashing is unavoidable



Mira Beam walk-in - corner

Defined by the smooth elegant curve of the glass panel, the Mira Beam walk-in offers the ultimate in luxury showering. The walk-in enclosure installs in a corner for the most ultra-modern look and creative use of space.

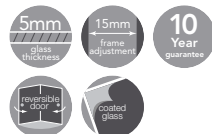

Configuration options

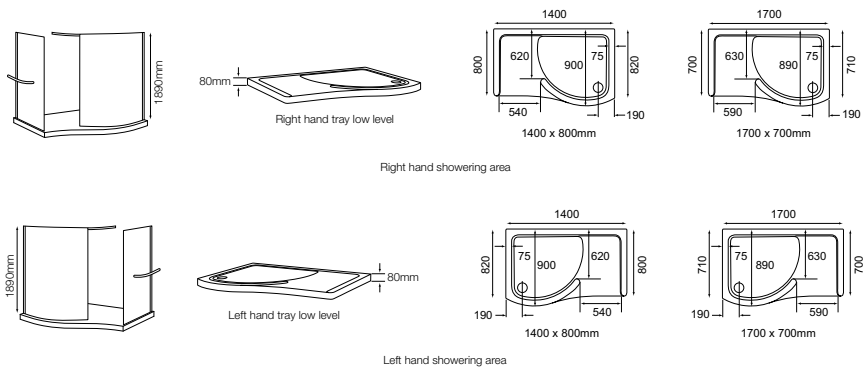

Dimensions, tray compatibility & pricing

All sizes are in mm

Mira Beam walk-in corner	size	frame finish option	glass	frame adjustment	door opening	18mm filler kit (if required)	flight tray compatibility
1.1721.571	1400x800	Silver	Clear	719-734	540	1.1721.573	1400x800 L/H 1000x800 R/H
1.1721.572	1700x700	Silver	Clear	630-646	590	1.1721.573	1700x700 L/H 1700x700 R/H



Product features

- Frameless panels give contemporary minimal styling
- Walk-in enclosure for a touch of luxury
- Reversible for left or right hand tray
- End panel included for corner installation
- Matching towel rail on the end panel, can be installed inside or outside the showering area
- Frame adjustment for uneven walls
- 5mm toughened safety glass
- Power shower approved*
- Height from top of tray: 1890mm
- 10 year guarantee

*Some splashing is unavoidable



Mira Flight Beam accessories

10mm & 18mm filler section

Mira Flight Beam filler section suitable to use with all doors, side panels and enclosures. Extend the width of a door, side panel and enclosure by 10mm or 18mm.

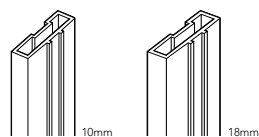

All sizes are in mm

Mira Flight Beam filler section	size	frame finish option	glass	frame adjustment	door opening	10mm filler kit (if required)	Flight tray compatibility	Flight Low tray compatibility
1.1721.427	10	Silver	n/a	n/a	n/a	n/a	n/a	n/a
1.1721.573	18	Silver	n/a	n/a	n/a	n/a	n/a	n/a

Side panels

Mira Flight Beam side panels create corner enclosures when combined with a pivot, bi-fold and sliding doors.

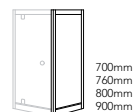

All sizes are in mm

Mira Flight Beam side panels	size	frame finish option	glass	frame adjustment	door opening	10mm filler kit (if required)	Flight tray compatibility	Flight Low tray compatibility
1.1721.414	700	Silver	Clear	658-687	n/a	n/a	n/a	n/a
1.1721.415	760	Silver	Clear	720-749	n/a	n/a	n/a	n/a
1.1721.416	800	Silver	Clear	758-787	n/a	n/a	n/a	n/a
1.1721.417	900	Silver	Clear	858-887	n/a	n/a	n/a	n/a

Mira Flight Beam accessories

400mm inline panel

Mira Flight Beam inline panel to suit pivot and bi-fold doors. Combine inline panel with pivot and bi-fold doors for an extended enclosure e.g. one inline panel combined with a standard 800mm pivot door = a 1200mm width.

Pivot extended alcove

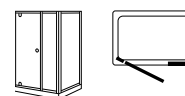

1200mm
1400mm

Pivot extended corner enclosure

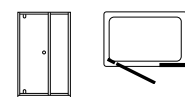

1200 x 700mm
1200 x 760mm
1200 x 800mm
1200 x 900mm

1400 x 700mm
1400 x 760mm
1400 x 800mm
1400 x 900mm

Pivot double extended corner enclosure

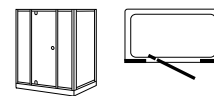

Also available for use with bi-fold door

1600 x 700mm
1600 x 760mm
1600 x 800mm
1600 x 900mm

1700 x 700mm
1700 x 760mm
1700 x 800mm
1700 x 900mm

1800 x 700mm
1800 x 760mm
1800 x 800mm
1800 x 900mm

All sizes are in mm

Mira Flight Beam inline panels	size	frame finish option	glass	frame adjustment	door opening	10mm filler kit (if required)	Flight tray compatibility	Flight Low tray compatibility
1.1721.413	400	Silver	Clear	n/a	n/a	1.1721.427	n/a	n/a



Product features (side panels only)

- 6mm toughened safety glass - coated for easy cleaning
- For corner installation only
- 29mm adjustment on each wall profile for out of true walls
- Power shower approved
- Height from top of tray: 1900mm
- 10 year guarantee

Product features

- 4mm toughened safety glass - coated for easy cleaning
- For alcove or corner installation only
- 29mm adjustment on each wall profile for out of true walls
- Power shower approved
- Height from top of tray: 1900mm
- 10 year guarantee



Mira Flight trays

Mira Flight is a shower tray that will never ever let you down – lighter, stronger, easier to fit and it's incredibly strong. We've brought the Mira Flight range bang up to date with a great new, sleek look, whilst retaining all of the great features you love about the product.

Lighter, tougher, easier to fit.

Incredibly strong, light and easy to fit, Mira Flight shower trays always keep their colour and kill bacteria to help stay in perfect harmony with your bathroom.

- Made from strong acrylic capped resin stone for a far tougher product
- Scratch, chip and discolouration resistant
- Includes BioCote® to reduce bacteria and mould growth by up to 99.9%
- Branded white walk-on waste adds to the stylish look
- Optional riser kit featuring strong 'push-fit' legs for solid floor applications
- Includes waste
- Variations with integral upstands for watertight performance



Mira Flight trays contents

Mira Flight tray - quadrant	181
Mira Flight tray - pentagon	181
Mira Flight tray - rectangle	182
Mira Flight tray - square	182
Mira Flight tray - riser conversion kit	183
Mira tile upstand kit	183
Mira Flight walk-in trays	183-184



Tray with integral upstands



Mira Flight square



Mira Flight quadrant



Mira Flight rectangle



Mira Flight pentagon

Mira Flight trays

For more detailed technical information please visit our website www.mirashowers.co.uk, for customers from the Republic of Ireland please visit www.mirashowers.ie

Mira Flight tray - quadrant

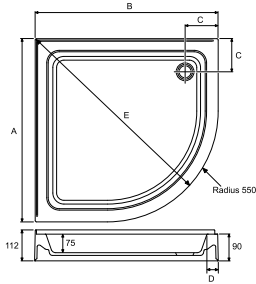

Left hand shown

Mira Flight tray - quadrant

Availability											
Size (mm)		Upstands	Product code		Riser conversion kit product code						
800	800	0	1.1783.040		1.1783.102						
800	800	2	1.1783.041		1.1783.102						
900	900	0	1.1783.042		1.1783.102						
900	900	2	1.1783.043		1.1783.102						
1000 x 800 L/H		0	1.1783.044		1.1783.105						
1000 x 800 R/H		0	1.1783.045		1.1783.105						
1200 x 900 L/H		0	1.1783.046		1.1783.105						
1200 x 900 R/H		0	1.1783.047		1.1783.105						

Dimensions (mm)											
Flat top						Upstands					
A	B	C	D	E	F	A	B	C	D	E	F
800	800	160	55	90	190	810	810	165	60	112	212
900	900	160	55	90	190	910	910	165	60	112	212
800	1000	160	55	90	190	N/A	N/A	N/A	N/A	N/A	N/A
900	1200	160	55	90	190	N/A	N/A	N/A	N/A	N/A	N/A

Mira Flight height with upstands

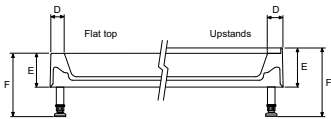

Mira Flight tray - pentagon

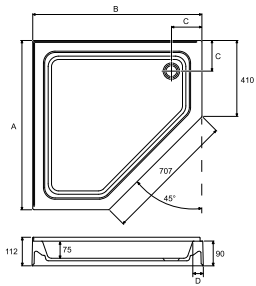

Left hand shown

Mira Flight tray - pentagon

Availability											
Size (mm)		Upstands	Product code		Riser conversion kit product code						
900	900	0	1.1783.050		1.1783.106						
900	900	2	1.1783.051		1.1783.106						
1200 x 900 L/H		0	1.1783.052		1.1783.106						
1200 x 900 R/H		0	1.1783.053		1.1783.106						

Dimensions (mm)											
Flat top						Upstands					
A	B	C	D	E	F	A	B	C	D	E	F
900	900	160	55	90	190	910	910	165	60	112	212
900	1200	160	55	90	190	N/A	N/A	N/A	N/A	N/A	N/A

Mira Flight trays

For more detailed technical information please visit our website www.mirashowers.co.uk, for customers from the Republic of Ireland please visit www.mirashowers.ie

Mira Flight tray - rectangle

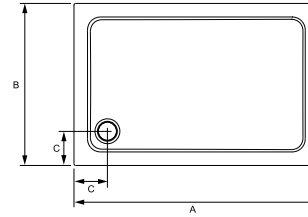

Mira Flight tray - rectangle

Availability											
Size (mm)		Upstands	Product code		Riser conversion kit product code						
900 x 760		0	1.1783.009		1.1783.101						
900 x 760		3	1.1783.010		1.1783.101						
900 x 760		4	1.1783.011		1.1783.101						
1000 x 760		0	1.1783.016		1.1783.104						
1000 x 760		3	1.1783.017		1.1783.104						
1000 x 760		4	1.1783.018		1.1783.104						
1000 x 800		0	1.1783.019		1.1783.104						
1000 x 800		3	1.1783.020		1.1783.104						
1000 x 800		4	1.1783.021		1.1783.104						
1200 x 760		0	1.1783.022		1.1783.104						
1200 x 760 LH		2	1.1783.023		1.1783.104						
1200 x 760 RH		2	1.1783.024		1.1783.104						
1200 x 760		3	1.1783.025		1.1783.104						
1200 x 760		4	1.1783.026		1.1783.104						
1200 x 800		0	1.1783.027		1.1783.104						
1200 x 800		3	1.1783.028		1.1783.104						
1200 x 800		4	1.1783.029		1.1783.104						
1200 x 900		0	1.1783.030		1.1783.104						
1200 x 900		3	1.1783.031		1.1783.104						
1200 x 900		4	1.1783.032		1.1783.104						
1400 x 800		0	1.1783.033		1.1783.107						
1500 x 760		4	1.1783.034		1.1783.107						

Mira Flight height with upstands

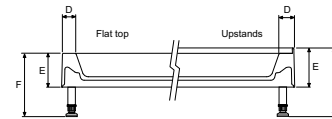

Dimensions (mm)											
Flat top						Upstands					
A	B	C	D	E	F	A	B	C	D	E	F
900	760	160	55	90	190	910	770	165	60	112	232-262
1000	760	160	55	90	190	1010	770	165	60	112	232-262
1000	800	160	55	90	190	1010	810	165	60	112	232-262
1200	760	160	55	90	190	1210	770	165	60	112	232-262
1200	800	160	55	90	190	1210	810	165	60	112	232-262
1200	900	160	55	90	190	1210	910	165	60	112	232-262
1400	800	160	55	90	190	N/A	N/A	N/A	N/A	N/A	N/A
N/A	N/A	N/A	N/A	N/A	N/A	1210	770	165	60	112	232-262

Mira Flight tray - square

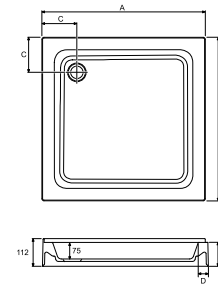

Mira Flight tray - square

Availability											
Size (mm)		Upstands	Product code		Riser conversion kit product code						
760	760	0	1.1783.001		1.1783.100						
760	760	2	1.1783.002		1.1783.100						
760	760	3	1.1783.003		1.1783.100						
760	760	4	1.1783.004		1.1783.100						
800	800	0	1.1783.005		1.1783.101						
800	800	2	1.1783.006		1.1783.101						
800	800	3	1.1783.007		1.1783.101						
800	800	4	1.1783.008		1.1783.101						
900	900	0	1.1783.012		1.1783.101						
900	900	2	1.1783.013		1.1783.101						
900	900	3	1.1783.014		1.1783.101						
900	900	4	1.1783.015		1.1783.101						

Dimensions (mm)											
Flat top						Upstands					
A	B	C	D	E	F	A	B	C	D	E	F
760	760	160	55	90	190	770	770	165	60	112	212
800	800	160	55	90	190	810	810	165	60	112	212
900	900	160	55	90	190	910	910	165	60	112	212

Mira Flight trays

For more detailed technical information please visit our website www.mirashowers.co.uk, for customers from the Republic of Ireland please visit www.mirashowers.ie

Mira Flight tray - NEW riser conversion kit

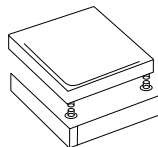

Mira Flight tray - NEW riser conversion kit

Availability		
Description	Part no.	No. of legs
Flight 760 square riser conversion kit	1-1783.100	5
Flight 900 square riser conversion kit	1-1783.101	5
Flight 1200 rectangle riser conversion kit	1-1783.104	7
Flight 1700 rectangle riser conversion kit	1-1783.107	7
Flight 1200 pentagon riser conversion kit	1-1783.106	9
Flight 900 quadrant riser conversion kit	1-1783.102	7
Flight 1200 quadrant riser conversion kit	1-1783.105	7

Mira tile upstand kit

Forms a seal to the tray and provides an upstand to tile onto

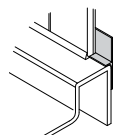

Mira tile upstand kit

Availability		
Description	Part no.	Length (m)
Mira tile upstand kit	1-1697.240.WH	3.6

Mira Flight walk-in trays

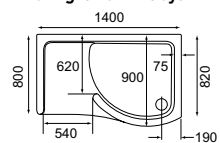

1400 x 800mm
Right hand shown

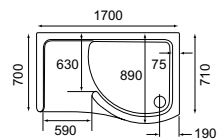

1700 x 700mm
Right hand shown

Flight walk-in trays (for Beam walk-in)

Availability					
Description	Part no.	Length (mm)	Width (mm)	Height (mm)	Riser conversion kit product code
1400x800 L/H	400825	1400	800	80	107404
1400x800 R/H	400826	1400	800	80	107404
1700x700 L/H	400821	1700	700	80	107403
1700x700 R/H	400822	1700	700	80	107403

Walk-in riser conversion kit

Availability	
Description	Part no.
Flight 1400x800 walk-in riser conversion kit	107404
Flight 1700x700 walk-in riser conversion kit	107403





Mira Flight Low trays

Made from durable acrylic resin stone, Mira Flight Low isn't just incredibly tough and unbelievably light, it's also one of the lowest trays on the market.

The lighter, tougher, lower shower tray.

Made from durable acrylic resin stone, Mira Flight Low isn't just incredibly tough and unbelievably light, it's also one of the lowest trays on the market.

- Low-profile 40mm shower tray with a smooth surface
- Made from strong acrylic capped resin stone for a far tougher product
- Scratch, chip and discolouration resistant
- Includes BioCote® to reduce bacteria and mould growth by up to 99.9%
- Flight Low vortex waste* sucks water from the tray
- Optional riser kit featuring strong 'push-fit' legs for solid floor applications

* Maximum flow rate 30 litres per minute.



Mira Flight Low trays contents

Mira Flight Low tray - square	187
Mira Flight Low tray - quadrant	187
Mira Flight Low tray - pentagon	187
Mira Flight Low tray - rectangle	187
Mira tile upstand kit	188
Mira Flight Low tray - riser conversion kit	188



Mira Flight Low trays

All Mira Flight Low trays are supplied with a Mira Flight Low Vortex Waste.

For more detailed technical information please visit our website www.mirashowers.co.uk, for customers from the Republic of Ireland please visit www.mirashowers.ie

Mira Flight Low tray - square

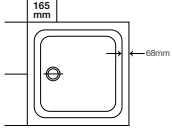

Mira Flight Low tray - square

Availability				
Length (mm)	Width (mm)	Height (mm)	Product code	Riser conversion kit product code
760	760	40	1.1697.014	1.1697.030
800	800	40	1.1697.010	1.1697.030
900	900	40	1.1697.009	1.1697.030
1000	1000	40	1.1697.040	1.1697.033

Mira Flight Low tray - quadrant

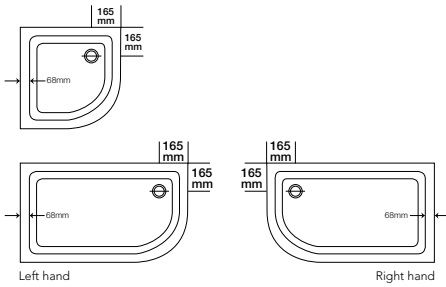

Mira Flight Low tray - quadrant

Availability				
Length (mm)	Width (mm)	Height (mm)	Product code	Riser conversion kit product code
800	800	40	1.1697.015	1.1697.035
900	900	40	1.1697.012	1.1697.035
1000	1000	40	1.1697.041	1.1697.267
1000 LH	800	40	1.1697.022	1.1697.037
1000 RH	800	40	1.1697.023	1.1697.037
1200 LH	900	40	1.1697.024	1.1697.037
1200 RH	900	40	1.1697.025	1.1697.037

Mira Flight Low tray - pentagon

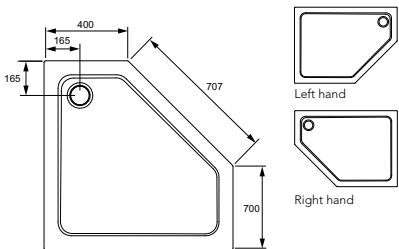

Mira Flight Low tray - pentagon

Availability				
Length (mm)	Width (mm)	Height (mm)	Product code	Riser conversion kit product code
900	900	40	1.1697.016	1.1697.036
1200 LH	900	40	1.1697.026	1.1697.036
1200 RH	900	40	1.1697.027	1.1697.036

Mira Flight Low trays

All Mira Flight Low trays are supplied with a Mira Flight Low Vortex Waste.

For more detailed technical information please visit our website www.mirashowers.co.uk, for customers from the Republic of Ireland please visit www.mirashowers.ie

Mira Flight Low tray - rectangle

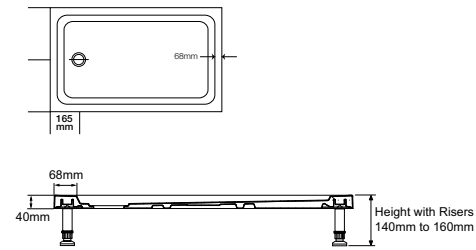

Mira Flight Low tray - rectangle

Availability				
Length (mm)	Width (mm)	Height (mm)	Product code	Riser conversion kit product code
900	760	40	1.1697.017	1.1697.030
1000	700	40	1.1697.045	1.1697.033
1000	760	40	1.1697.008	1.1697.033
1000	800	40	1.1697.007	1.1697.033
1100	800	40	1.1697.013	1.1697.033
1200	700	40	1.1697.046	1.1697.033
1200	760	40	1.1697.006	1.1697.033
1200	800	40	1.1697.005	1.1697.033
1200	900	40	1.1697.018	1.1697.033
1400	700	40	1.1697.047	1.1697.034
1400	760	40	1.1697.004	1.1697.034
1400	800	40	1.1697.019	1.1697.034
1400	900	40	1.1697.042	1.1697.034
1500	700	40	1.1697.048	1.1697.034
1500	760	40	1.1697.003	1.1697.034
1600	700	40	1.1697.020	1.1697.034
1600	760	40	1.1697.002	1.1697.034
1600	900	40	1.1697.043	1.1697.034
1700	700	40	1.1697.021	1.1697.034
1700	760	40	1.1697.001	1.1697.034
1700	900	40	1.1697.044	1.1697.034

Mira tile upstand kit

Forms a seal to the tray and provides an upstand to tile onto

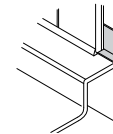

Mira low tray upstand kit

Availability		
Description	Part no.	Length (m)
Mira tile upstand kit	1.1697.240/WH	3.6

Mira Flight Low tray - riser conversion kit

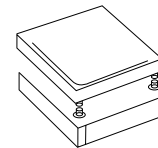

Mira Flight Low tray - riser conversion kit

Availability	
Description	Part no.
Flight low 900 square riser conversion kit	1.1697.030
Flight low 1200 rectangle riser conversion kit	1.1697.033
Flight low 1700 rectangle riser conversion kit	1.1697.034
Flight 900 quadrant riser conversion kit	1.1697.035
Flight 1000 quadrant riser conversion kit	1.1697.267
Flight low pentagon riser conversion kit	1.1697.036
Flight low 1200 quadrant riser conversion kit	1.1697.037



Mira Flight wall panels

Why not complete your installation the easy way by using the new Mira Flight wall panels. Easy to install, the Mira Flight wall panel works perfectly with both the new Mira enclosures and the acclaimed Mira Flight trays.



All Mira Flight walls stay protected for life with the antibacterial technology BioCote® which is incorporated into the manufacturing process itself.

- Reduces bacteria and mould by up to 99.9%.
- Unlike other protection, BioCote® will never wear off or wash away.



Mira design and technology

Flight walls are designed to complement the Mira Flight shower trays and are available in gloss white to offer a stylish contemporary finish to your bathroom. The walls are strong, durable and leak proof using patented Mira Flight technology so you can enjoy years of showering.

Mira Flight wall panels contents

760 enclosure	191
800 enclosure	191
1200 enclosure	191



Mira Flight basin splashback

Mira Flight wall panels

Fantastic in a bathroom setting, see our step by step installation video online at www.mirashowers.co.uk

Suitable for 760 enclosure

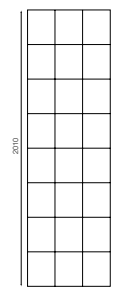

735
2010 x 735mm
760 Full Height Wall

Suitable for 800 enclosure

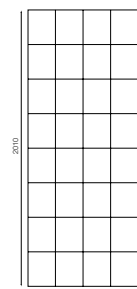

775
2010 x 775mm
800 Full Height Wall

Suitable for 1200 enclosure

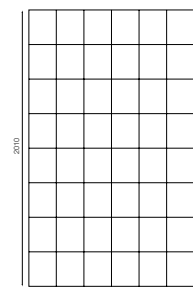

1175
2010 x 1175mm
1200 Full Height Wall

Bath splashback

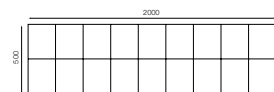

500 x 2000mm
Bath Splash back

Basin splashback

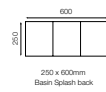

250 x 600mm
Basin Splash back



Full height wall panel

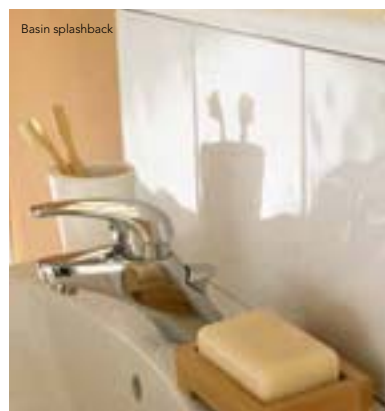

Basin splashback

Description	Nominal enclosure size (mm)	Width (mm)	Height (mm)	Product code
760 full height wall*	760	735	2010	1.1669.100
800 full height wall*	800	775	2010	1.1669.101
1200 full height wall*	900	1175	2010	1.1669.102
Basin splashback	N/A	600	250	1.1669.071
Bath splashback	N/A	2000	500	1.1669.072
Straight connector	N/A	N/A	N/A	1.1669.097
Corner connector	N/A	N/A	N/A	1.1669.085

*includes a corner joint



Wall panel accessories -
straight connector



Corner joint provided
with every panel



Full height wall panel with bath splashback



Shower trays & wall panels



Accessories

Perhaps you want to give your bathroom a makeover, or you'd simply like to replace an old shower part. At Mira we offer a wide range of accessories that are easy and simple to fit.

From showerheads that use less water to stylish soap dishes, you'll find whatever you're looking for here and most of our range will fit other makes and models of shower. So even if you're not lucky enough to currently own a Mira, you can still refresh your shower.

Experience the very latest in showering technology

Our design teams are constantly developing new and innovative showerheads to bring you an even better showering experience:

- Mira Eco is a water-saving showerhead that can help you save up to 75%* of the water you use when you shower, without noticing any difference to the flow. For more information and to view our production demo video, please visit www.mirashowers.co.uk/ecoshowerhead
- Mira Everclear is specially designed to stop limescale building up, so your showerhead gives a consistent flow and has a longer life.
- Pictured on the left, the Mira 360 is a brand new type of showerhead that literally turns showering on its head, bringing you a simple flip action to create four unique and invigorating sprays. For more information and to view our production demo video, please visit www.mirashowers.co.uk/360

*When compared to a Mira Logic showerhead at 0.5 bar pressure. Mira Eco is not suitable for electric showers or gravity fed systems under 0.5 bar pressure.

Accessories contents

Mira Eco	195-196
Mira Everclear	197-198
Mira 360	199-200
Mira showerhead range	201-204
Additional Mira accessories	205-206
Mira mix & match fittings & valves	207-208
Mira Excel taps & bath shower mixers	209
Mira Discovery taps & bath shower mixers	210

Mira Eco

Our Mira Eco showerhead saves up to 75%¹ water and still delivers a great performance - it's a greener way to get cleaner. We've got a range of finishes and models to choose from, so you can find the showerhead that matches your existing shower perfectly.

Adjustable spray showerheads



View demo at:
www.mirashowers.co.uk/ecoshowerhead



Mira Eco
3 spray adjustable showerhead, chrome finish.
2.1605.112



Mira Eco
3 spray adjustable showerhead, white finish.
2.1605.110

Fixed adjustable spray showerheads



Mira Eco BIR
3 spray fixed showerhead, chrome finish.
2.1668.004

Saving water by 75%¹

Saving water is good news for the environment and for your utility bills too. Choose a Mira Eco showerhead and you'll know you're using water as efficiently as possible, thanks to our groundbreaking technology. By delivering larger water droplets filled with air, Mira Eco creates a great showering sensation, while actually cutting the amount of water used by up to 75%¹, so you don't have to compromise on that exhilarating Mira feeling to do your bit for the environment.

Fitting a Mira Eco showerhead to your shower means you'll also save on the fuel bills, as there's less water to heat. Not only that, Mira Eco also comes with special 'wipe-clean' nozzles to keep limescale at bay.

Save water whatever your flow

Our water-saving technology works across all 3 of Mira Eco's spray patterns. So whether you prefer a gentle spray or a concentrated flow, you're still saving water and heating costs.

¹When compared to a Mira Logic showerhead at 0.5 bar pressure.

*Mira Eco is not suitable for electric showers or gravity fed systems under 0.5 bar pressure.

3 SPRAYS



Co-ordinating fittings kit



Mira Eco fittings kit
The Mira Eco adjustable showerhead can be used with your existing hose and fittings. If you'd prefer to update all of your fittings, the Mira Eco fittings kit is the perfect solution. Choose from a 1.25m or 1.75m hose.

1.25m hose

2.1605.163

1.75m hose

2.1605.164

Mira Logic showerhead



Mira Eco showerhead



Flow rates at 0.5 bar
Logic showerhead vs. Eco showerhead

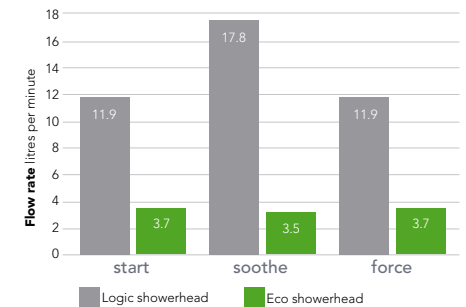

The Mira Eco showerhead uses on average 10.2 litres per minute less than the Mira Logic showerhead.



Mira Eco has been awarded the Waterwise Marque. Waterwise is the leading authority on water efficiency in the UK and each year they award the Marque to products that reduce water wastage or raise awareness of water efficiency.



We received a Gold Award for Mira Eco at the House Beautiful Awards 2009 which celebrates the best homes and interiors products. The innovative showerhead was named Eco Product of the Year for its environmentally friendly design.

Mira Everclear

The Mira Everclear showerhead fights limescale. Its unique design resists limescale build up with automatic self drain and integrated pins for easy cleaning of the nozzles.

1 SPRAY



Limescale fighting showerheads



Mira Everclear
Single spray
showerhead,
chrome finish.
2.1605.111

Co-ordinating fittings kit



Mira Everclear fittings kit
The Mira Everclear showerhead can be used with your existing hose and fittings. If you'd prefer to update all of your fittings, the Mira Everclear fittings kit is the perfect solution.

Chrome finish
2.1605.152

White finish
2.1616.036

Self cleaning technology

Over 60% of the population is affected by hard water. This often results in limescale build up, which doesn't just leave ugly marks on your shower, it can also clog up the nozzles which restricts the spray.

Mira Everclear features innovative technology which means the showerhead drains automatically before any limescale has time to build up.

When showering begins, the spray plate automatically pushes forward giving a comfortable wide spray. Turning off the water will automatically allow the spray plate to retract to the rest position. The showerhead drains away any residual water and small pins come through the spray plate to ensure it is cleared thoroughly, reducing any limescale build up. The spray plate can also be manually pressed for an extra clean if necessary.

Ideal for mixer showers

We designed Mira Everclear to be simple to fit. It's suitable for most mixer showers over 0.2 bar pressure, and electric showers over 9.0kW. We've got a range of finishes and models to choose from, so you can find the showerhead or fittings kit that matches your existing shower perfectly.

* Suitable for most mixers over 0.2 bar pressure and electric showers over 9.0kW.

Ordinary showerhead



Mira Everclear showerhead



The spray plate automatically pushes through small pins to prevent limescale build up. It can also be manually pressed for an extra clean if necessary.



Mira 360

Introducing the new Mira 360. A brand new range of shower fittings that have literally turned showering on its head. The Mira 360 comes complete with Flipstream™ technology – 1 flip action, 4 unique sprays. You choose the spray by rotating the showerhead on its axis.

4 SPRAYS

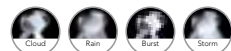

Adjustable spray showerheads



View demo at:
www.mirashowers.co.uk/360



Mira 360r
Rounded, soft and natural form.
4 spray showerhead, chrome/white finish.
2.1688.002



Mira 360m
Minimalist and contemporary design.
4 spray showerhead, chrome/white finish.
2.1688.001



Mira 360m
Minimalist and contemporary design.
4 spray showerhead, chrome/black finish.
2.1688.008



Mira 360i
An iconic and striking statement.
4 spray showerhead, chrome/black finish.
2.1688.004



Co-ordinating fittings kits and slide bar alternatives

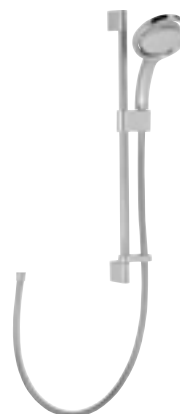

Mira 360 Classics fittings kit
A slide bar option, the new Mira 360 Classic fittings kit is available with the Mira 360m showerhead.
1.1688.005



Mira 360 Magnetic fittings kit
The ultimate, minimal, magnetic fittings kit comes with the stylish Mira 360i showerhead.
1.1688.006

The Mira showerhead range

Whether you're looking for a fixed, adjustable or power showerhead, we have the model to match. All of our showerheads are universal fit, so will fit with any standard shower hose. A simple screw thread connection makes installation quick and easy.

Single spray showerheads



- Mira Beat**
- Works with any shower on any system
 - Single spray mode
 - Rub-clean nozzles for easy limescale removal
 - Easy to fit - no tools required
 - Fits all hoses

Chrome
2.1703.011

White
2.1703.009



- Mira Nectar**
- Works with any shower on any system
 - Single spray mode
 - Rub-clean nozzles for easy limescale removal
 - Easy to fit - no tools required
 - Fits all hoses

Chrome
2.1703.003

White
2.1703.001



- Mira Everclear**
- Suitable for mixer showers +0.2 bar (not suitable for electric showers)
 - Prevents limescale build up
 - Automatic self-drain and self-cleaning
 - 1 simple refreshing spray pattern
 - Easy to fit
 - Fits all hoses

Chrome
2.1605.111

Adjustable spray showerheads



- Mira Beat**
- Works with any shower on any system
 - 4 different spray modes
 - Rub-clean nozzles for easy limescale removal
 - Easy to fit - no tools required
 - Fits all hoses

Chrome
2.1703.012

White
2.1703.010



- Mira Nectar**
- Works with any shower on any system
 - 4 different spray modes
 - Rub-clean nozzles for easy limescale removal
 - Easy to fit - no tools required
 - Fits all hoses

Chrome
2.1703.004

White
2.1703.002



- Mira Response**
- Works with any shower on any system
 - 4 different spray patterns
 - Rub-clean nozzles for easy cleaning
 - Easy to fit
 - Fits all hoses

Chrome/dark grey
2.1605.106

White/grey
2.1605.103

Adjustable spray showerheads



- Mira Logic**
- Works with any shower on any system
 - 4 different spray patterns
 - Easily adjustable sprays
 - Eco setting option
 - Easy to fit
 - Rub-clean nozzles for easy cleaning
 - Fits all hoses

Chrome
2.1605.176

White
2.1605.177



- Mira Discovery**
- Works with any shower on any system
 - 4 different spray patterns
 - Partial rub-clean nozzles for easy cleaning
 - Easy to fit
 - Eco setting option
 - Fits all hoses

Chrome
2.1605.109



- Mira Eco**
- Suitable for mixer showers +0.5 bar
 - 3 different aerating full coverage spray patterns
 - Reducing the amount of water means less energy is used
 - Rub-clean nozzles for easy cleaning
 - Fits all hoses

Chrome
2.1605.112

White
2.1605.110



- Mira Citrus 11cm**
- For use with mixer showers and electric showers over 9.0kW
 - 5 different spray patterns
 - Rub-clean nozzles for easy cleaning
 - Easy to fit
 - Fits all hoses

Chrome
2.1605.201



- Mira Citrus 14cm**
- For use with mixer showers and electric showers over 9.0kW
 - 5 different spray patterns
 - Rub-clean nozzles for easy cleaning
 - Easy to fit
 - Fits all hoses

Chrome
2.1605.115



- Mira Magna**
- Works with any shower on any system
 - 4 different spray patterns
 - Easily adjustable sprays
 - Easy to fit
 - Rub-clean nozzles for easy cleaning
 - Fits all hoses

Satin/chrome
2.1605.113

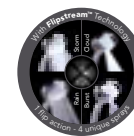

- Mira 360r**
- Works with any shower on any system
 - 4 different spray patterns: Rain, Burst, Storm & Cloud
 - Easily adjustable sprays with unique flip action
 - Easy to fit
 - Fits all hoses

White/chrome
2.1688.002

White/white
2.1688.003



- Mira 360m**
- Works with any shower on any system
 - 4 different spray patterns: Rain, Burst, Storm & Cloud
 - Easily adjustable sprays with unique flip action
 - Easy to fit
 - Fits all hoses

Black/chrome
2.1688.008

White/chrome
2.1688.001

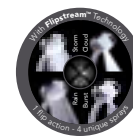

- Mira 360i**
- Works with any shower on any system
 - 4 different spray patterns: Rain, Burst, Storm & Cloud
 - Easily adjustable sprays with unique flip action
 - Easy to fit
 - Fits all hoses

Black/chrome
2.1688.004

Fixed spray showerheads

Suitable for mixer showers with built-in pipework.



Mira Logic

- Suitable for all mixer showers with built-in pipework
- 4 different spray patterns
- Easily adjustable sprays
- Easy to fit
- Rub-clean nozzles for easy cleaning

Chrome

2.1605.184



Mira Discovery

- Suitable for mixer showers +0.2 bar with built-in pipework

Chrome

1.1595.244



Mira Eco

- Suitable for mixer showers +0.5 bar with built-in pipework
- 3 different aerating full coverage spray patterns
- Rub-clean nozzles for easy cleaning
- Easy to fit

Chrome

2.1668.004



Mira Fixed showerhead arm only

- Shown above with Mira Deluge showerhead (not included but available separately)
- Designed for use with built-in mixer showers
- Easy to fit

Chrome

2.1605.131

Mira Deluge head only

- Shown above with Mira Fixed showerhead arm (not included but available separately)
- 1 deluge spray pattern
- 185mm diameter
- Angle adjustment for comfortable showering
- Rub clean nozzles
- Easy to fit
- Suitable for mixer showers +0.1 bar with built-in pipework

Chrome

2.1605.132

Power showerheads

Suitable for power showers and high pressure systems.



Mira Response

- Suitable for power showers and high pressure mixers
- 4 different spray patterns
- Rub-clean nozzles for easy cleaning
- Easy to fit
- Fits all hoses

Chrome/dark grey

2.1605.181

White/grey

1.0.411.82.2



Mira Logic

- Suitable for power showers and high pressure mixers
- 4 different spray patterns
- Easily adjustable sprays
- Easy to fit
- Rub-clean nozzles for easy cleaning
- Fits all hoses

Chrome

2.1605.178

White

1.1540.268



Mira Magna

- Suitable for power showers and high pressure mixers
- 4 different spray patterns
- Easily adjustable sprays
- Easy to fit
- Rub-clean nozzles for easy cleaning
- Fits all hoses

Satin/chrome

2.1588.077



Additional Mira accessories

From soap dishes to shower seats, with Mira you can add whatever you need to create your ideal shower.



- Mira Logic showerhead holder**
- A simple alternative to the traditional slide bar
 - Can make showering easier for children
 - Provides useful additional holder for your showerhead
 - Complete with wall fixings
 - Easy to fit

Chrome
2.1605.150
White
2.1605.149



- Mira Logic clamp bracket**
- Replacement for Mira Response Logic clamp brackets
 - Suitable for any 22mm slide bars
 - Easy to fit
 - Rubber grip for easy one-handed operation

Chrome
2.1605.128
White
2.1605.127



- Mira Logic soap dish**
- Easy to clean
 - Easy to fit
 - Includes wall fixings

Chrome
2.1605.195



- Mira Response soap dish**
- Easy to clean
 - Easy to fit
 - Includes wall fixings
 - Fits all 18mm and 22mm slide bars

Chrome
2.1605.126
White
2.1605.125



- Mira Logic wall outlet**
- To attach hose to water supply
 - Includes wall fixings
 - Fits all hoses

Chrome
2.1605.199



- Mira shower seat**
- Must only be fitted to solid walls
 - Includes wall fixings
 - Folds away when not in use
 - 150kg/23.5 stone weight limit

White/chrome
2.1536.129
White/white
2.1536.128



- Mira Premium shower seat**
- Slim-line design
 - Integrated drainage holes
 - Folds away when not in use
 - 150kg/23.5 stone weight limit

White/chrome
2.1731.001
Grey/white
2.1731.002



- Mira Response hose**
- Compatible with any shower and water system
 - Easy to fit
 - Steel encased in PVC
 - Brass conical ends
 - Free flowing and easy to clean

Chrome 1.25m
1.1605.167
Chrome 1.75m
1.1605.168



- Mira Logic hose**
- Works with any shower on any system
 - Easy to fit
 - Double interlocked
 - Strong stainless steel sleeve
 - Brass conical ends
 - Robust plastic inner
 - Free flowing and easy to clean

Chrome 1.25m
2.1605.166
Chrome 1.75m
2.1605.139



- Mira Beat slide bar**
- Works with any shower on any system
 - Twist and lock clamp bracket
 - Soap dish with integrated hose retaining ring/shower gel hook
 - Variable fixing centres for easy replacement of existing fittings
 - All fixings included

Chrome
2.1703.018
White/chrome
2.1703.017



- Mira Nectar slide bar**
- Works with any shower on any system
 - Twist and lock clamp bracket
 - Soap dish with integrated hose retaining ring/shower gel hook
 - Variable fixing centres for easy replacement of existing fittings
 - All fixings included

Chrome
2.1703.008
White/chrome
2.1703.007



- Response extra long fittings kit**
- Works with any shower on any system
 - 1.5m slidebar
 - Rubberised push button clamp bracket – making height adjustment easy even when wet
 - Gel hook/hose tidy
 - 2.0m easy to clean, strong and durable plastic hose
 - Includes wall fixings

White/chrome
1.0413.10.2

Mira mix & match fittings and valves

If you want to replace a worn part on your existing shower or perhaps update its look, you don't have to replace the whole product. Simply choose your ideal style and functions from our wide range of complete shower fittings, all sold individually.

Mira exposed valve only

Mix and match with your choice of fittings.



- Mira Discovery Concentric**
- Thermostatic temperature control
 - Separate flow and temperature controls
 - Maximum temperature stop

Chrome
1.1595.004



- Mira Combiforce 415**
- Pressure balancing technology
 - One single control for flow and temperature
 - Maximum temperature stop

Chrome
1.1542.011
White/chrome
1.1542.012



- Mira Discovery Dual**
- Thermostatic temperature control
 - Separate flow and temperature controls
 - Maximum temperature stop

Chrome
1.1609.004



- Mira Silver**
- Thermostatic temperature control
 - One single control for flow and temperature
 - Maximum temperature stop
 - Accepts falling, rising and rear supplies

Chrome
1.1628.004



- Mira Gem 88**
- Manual temperature control
 - Separate flow and temperature controls
 - Anti-limescale technology

Chrome
1.1557.007



- Mira Excel**
- Thermostatic temperature control
 - Separate flow and temperature controls
 - Maximum temperature stop

Chrome
1.1518.309

Mira built-in valve only

Mix and match with your choice of fittings.



- Mira Gem 88**
- Manual temperature control
 - Separate flow and temperature controls
 - Anti-limescale technology

Chrome
1.1557.009



- Mira Discovery Dual**
- Thermostatic temperature control
 - Separate flow and temperature controls
 - Maximum temperature stop

Chrome
1.1609.005



- Mira Silver**
- Thermostatic temperature control
 - One control for flow and temperature
 - Maximum temperature stop

Chrome
1.1628.005



- Mira Discovery Concentric**
- Thermostatic temperature control
 - Separate flow and temperature controls
 - Maximum temperature stop

Chrome
1.1595.005



- Mira Excel**
- Thermostatic temperature control
 - Separate flow and temperature controls
 - Maximum temperature stop

Chrome
1.1518.311

Mira two-way built-in diverter

Mix and match with your choice of built-in valve.



- Mira two-way built-in diverter**
- Built-in, lever control two-way diverter valve
 - Divert between the overhead shower and hand-held showerhead
 - Works on all systems and pressures

Chrome
1.1737.002

Mira fittings kits



- Mira Response**
- Works with any shower on any system
 - 4 spray patterns with rub-clean nozzles
 - 1.25m easy to clean, strong and durable plastic hose

Chrome
2.1605.156
White/chrome
2.1462.031



- Mira Beat**
- Works with any shower on any system
 - 4 spray showerhead with rub-clean nozzles for easy limescale removal
 - Slidebar with twist and lock clamp bracket
 - Soap dish with integrated hose retaining ring/shower gel hook
 - 1.25m easy to clean, strong and durable metal hose

Chrome
2.1703.016
White/chrome
2.1703.015



- Mira Nectar**
- Works with any shower on any system
 - 4 spray showerhead with rub-clean nozzles for easy limescale removal
 - Slidebar with twist and lock clamp bracket
 - Soap dish with integrated hose retaining ring/shower gel hook
 - 1.25m easy to clean, strong and durable metal hose

Chrome
2.1703.006
White/chrome
2.1703.005



- Mira Logic**
- Works with any shower on any system
 - 4 spray showerhead with rub-clean nozzles
 - Slidebar with push button clamp bracket
 - 1.25m metal hose with brass conical ends

Chrome
2.1605.154
White
2.1605.155



- Mira Discovery**
- Works with any shower on any system
 - 4 spray showerhead with partial rub-clean nozzles
 - Slidebar with twist and lock clamp bracket
 - 1.25m easy to clean, strong and durable plastic hose

Chrome
2.1605.151



- Mira Eco**
- Suitable for mixer showers +0.5 bar (not suitable for electric showers)
 - 3 different aerating spray patterns with full rub-clean nozzles for easy cleaning
 - Slidebar with push button clamp bracket
 - Choice of 1.25m or 1.75m metal hose with brass conical ends

Chrome 1.25m
2.1605.163
Chrome 1.75m
2.1605.164



- Mira Everclear**
- Suitable for mixer showers +0.2 bar
 - 1 simple refreshing spray pattern
 - Slidebar with push button clamp bracket
 - 1.25m metal hose with brass conical ends
 - Prevents limescale build up
 - Suitable for electric showers over 9.0kW

Chrome
2.1605.152
White
2.1616.036

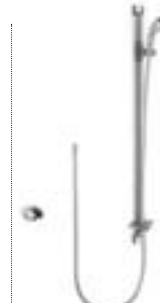

- Mira Flex**
- Suitable for mixer showers + 0.2 bar and electric showers + 9.0kW
 - Mira Everclear single spray limescale fighting showerhead
 - Easy-glide, extra long slide bar with friction clamp bracket for easy height adjustment
 - Gel hook/hose tidy and soap dish
 - 2m hose for increased flexibility
 - Includes an extra showerhead holder for additional height positioning
 - Includes wall fixings

Chrome
1.1603.125



- Mira 360 Classic/Mira 360 Magnetic**
- Works with any shower on any system
 - Mira 360m showerhead (360 Classic), 360i showerhead (360 Magnetic) with Flipstream™ technology
 - Slide bar (360 Classic), magnetic slide bar (360 Magnetic)
 - Clamp bracket
 - 1.25m metal hose with brass conical ends

White/chrome (360 Classic)
1.1688.005
Black/chrome (360 Magnetic)
1.1688.006

Taps & bath shower mixers

Our taps have been designed to match perfectly with the Mira Excel and Mira Discovery mixer showers, but they will also look great with most of our contemporary range. We've also got a selection of bath shower mixers (see page 66) which combine bath fill and an invigorating shower in one simple to use control.

If you would like more information on our taps and bath shower mixers please call us on **0844 571 5000** or visit www.mirashowers.co.uk, for customers from the Republic of Ireland please call Modern Plant on **01 459 1344** or visit www.mirashowers.ie

Mira Excel



Mira Excel basin pillar taps
 • Low and high pressure
 • ½" BSP connection
 1.1559.001



Mira Excel bath pillar taps
 • Low and high pressure
 • ½" BSP connection
 1.1559.002



Mira Excel monobloc basin mixer
 • Low and high pressure
 • ½" BSP connection
 1.1559.003



Mira Excel monobloc bidet mixer
 • Low and high pressure
 • ½" BSP connection
 1.1559.004



Mira Excel wall mounted bath shower mixer
 • High pressure
 • ½" BSP connection
 • Comes with showerhead hose and showerhead holder
 1.1559.006



Mira Excel monobloc bath shower mixer
 • High pressure
 • ½" BSP connection
 • Comes with showerhead hose and showerhead holder
 1.1559.005



Mira Excel deck mounted bath shower mixer
 • High pressure
 • ¾" BSP connection
 • Comes with showerhead hose and showerhead holder
 1.1559.007

Please turn to **pages 61-62** for the matching Excel showers

Mira Discovery



Mira Discovery basin pillar taps
 • High pressure
 • ½" BSP connection
 2.1612.001



Mira Discovery bath pillar taps
 • High pressure
 • ½" BSP connection
 2.1612.002



Mira Discovery monobloc basin mixer
 • Low and high pressure
 • ½" BSP connection
 2.1612.005



Mira Discovery monobloc bidet mixer
 • Low and high pressure
 • ½" BSP connection
 2.1612.006



Mira Discovery deck mounted bath mixer
 • Low and high pressure
 • ¾" BSP connection
 2.1612.003



Mira Discovery monobloc bath mixer
 • Low and high pressure
 • ½" BSP connection
 2.1612.008



Mira Discovery wall mounted bath shower mixer
 • Low and high pressure
 • ¾" BSP connection
 • Comes with showerhead hose and showerhead holder
 1.1612.007



Mira Discovery deck mounted monobloc bath shower mixer
 • Low and high pressure
 • ½" BSP connection
 • Comes with showerhead hose and showerhead holder
 1.1612.009



Mira Discovery deck mounted bath shower mixer
 • Low and high pressure
 • ¾" BSP connection
 • Comes with showerhead hose and showerhead holder
 1.1612.004

Please turn to **pages 41-46** for the matching Discovery showers

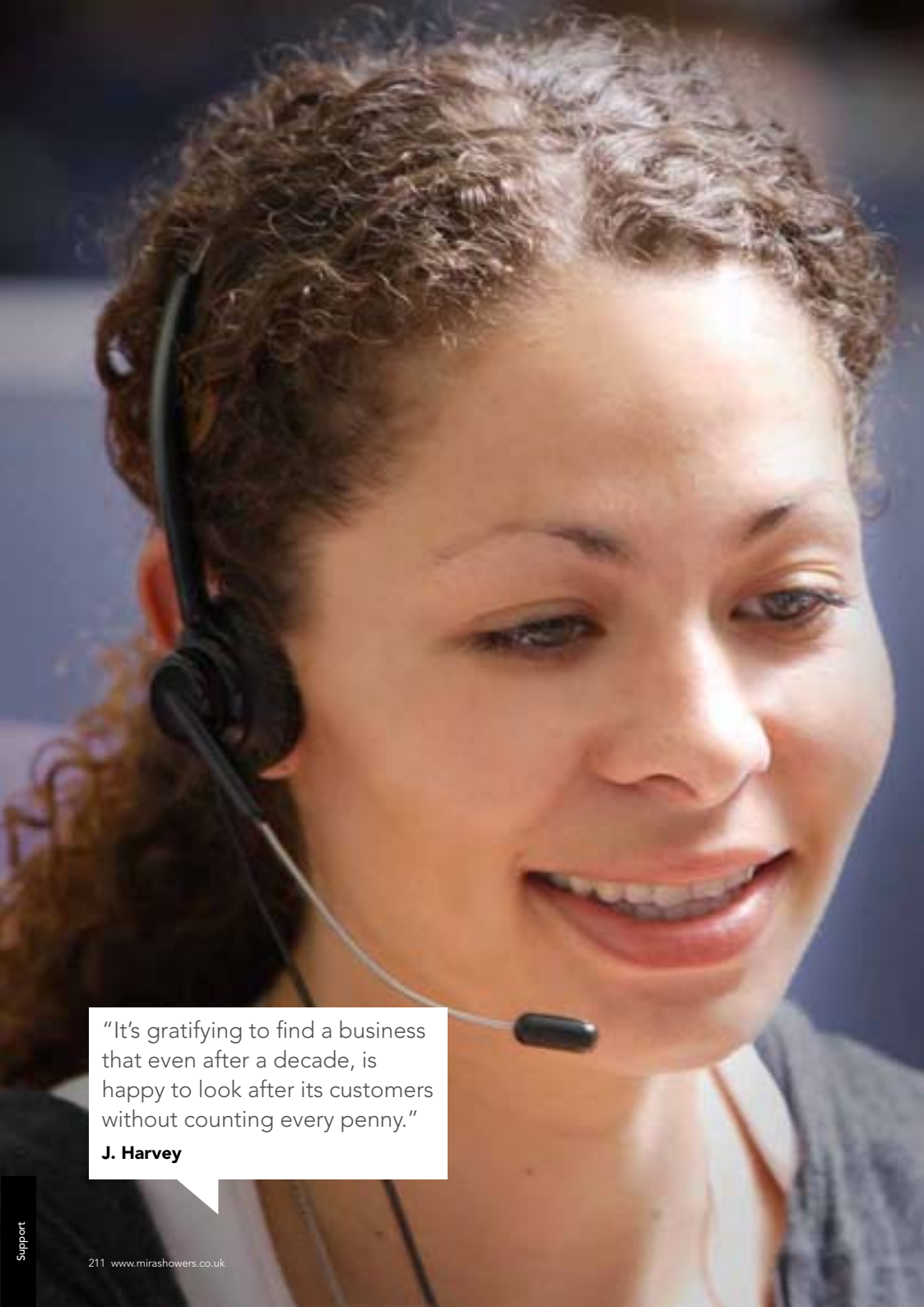

We're here to help. Get in touch whenever you need us.

If you're thinking about buying a Mira shower, or you already have a Mira but need a bit of help or advice, we're just a phone call away. Perhaps you need help working out which water system you have, or you might need a spare part or want us to arrange a visit from a service engineer. Whatever help you need, the good news is that when you buy a Mira, you can count on our dedicated Customer Services Team to provide lifetime support for your product.

It goes without saying that you'd prefer to talk to a friendly human being rather than working through an automated system or listening to tedious hold music. That's why we answer 85% of all calls within 15 seconds. All our Customer Service representatives are fully trained on Mira products and do at least 150 hours of extra training every year. We make sure they know every Mira product inside out, so they'll be able to help whatever question you have. If you'd like to speak to us over the phone, feel free to call on **0844 571 5000**.

If you live in the Republic of Ireland you should phone our service partner, Modern Plant, on **01 459 1344**. All their customer representatives are fully trained in Mira products so they'll be able to help whatever question you have.

Opening hours:
08:45 - 17:00, Monday - Thursday
08:45 - 16:00, Friday

We take service seriously

We know our excellent reputation depends on the service we provide. That's why we're always working to make our service second to none. It's also why we're the only shower manufacturer that's a member of the Institute of Customer Service.

The Institute of Customer Service is the professional body for customer service whose primary purpose is to lead customer service performance and professionalism. We have a strong commitment to continuous improvement of customer service and pride ourselves on this.

How to find help and advice online

Our website **www.mirashowers.co.uk** or **www.mirashowers.ie** if you live in the Republic of Ireland, puts you in touch with lots of useful information and advice at the click of a mouse:

- Use our online tools to identify your water system or choose your ideal shower.
- Compare the benefits of our showers by using our 'compare and select' feature.
- Look up any technical terms you don't understand in our glossary or check our Frequently Asked Questions.
- Watch our handy installation videos.

You can also view or download our installation and user guides for all our products, as well as a technical brochure. Once you've bought a Mira you can also register your guarantee quickly and easily using the simple online form.

"It's gratifying to find a business that even after a decade, is happy to look after its customers without counting every penny."

J. Harvey

How to arrange a visit from an engineer.

"What a total delight to be dealt with immediately when I called, no answer machine, efficient and friendly from the first call to the problem being solved by the engineer within minutes of him coming to the house. I really would like to say a very big thank you for restoring my faith in true service."

M Crisp



If you ever need hands-on help with your Mira, we can send an engineer out to you. Even if your warranty has expired, you can still call on us. We only charge by the visit and not by the hour, so you know you're getting good value for money.

- We aim to visit you within 3 working days of receiving your call.
- We should get your problem fixed the first time we come out.
- We can send spare parts to you within 2 working days of your call (as long as we have them in stock). We make sure the service we provide is to the same high standards as the products we make. With Mira you know you'll always enjoy the best of both worlds.

If you live in the UK or Northern Ireland and need help or advice, or you want to report a fault with a Mira product please call us on 0844 571 5000. If you live in the Republic of Ireland, please contact our service partner, Modern Plant, on 01 459 1344.

"Just to thank you for your superb service. In today's automated push-button options world, how refreshing to be able to speak to someone who will deal with the problem and see it through to completion."

D. Hopton

Getting in touch

If you have a question about our products or would like to talk to Mira Customer Services, please call us on 0844 571 5000, and for customers from the Republic of Ireland, please call Modern Plant on 01 459 1344. Alternatively you can visit www.mirashowers.co.uk/contactus

If you'd like to find out where your nearest Mira Showers showroom is, or you'd like to order another brochure, please call us on 0844 571 0005, and for customers from the Republic of Ireland, please call Modern Plant on 01 459 1344. Or visit our website: www.mirashowers.co.uk or for customers from the Republic of Ireland www.mirashowers.ie

www.mirashowers.co.uk

www.mirashowers.ie

www.kohler.co.uk

Kohler® family of businesses

We're owned by Kohler Co, one of the world leaders in bathroom design. KOHLER has been setting the standard for innovation, craftsmanship and new technology across the globe since 1873.

Kohler in the UK brings together a number of market-leading bathroom and shower brands, including KOHLER, Mira Showers, and RADA, to bring you an inspiring collection of bathroom sanitaryware, bathroom furniture, taps, showers and shower enclosures.

If you'd like to know more about the range of KOHLER products, please visit the websites above.



THE BOLD LOOK
OF
KOHLER

mira
SHOWERS

rada

Due to the process of continuous development, Mira reserves the right to make product changes without prior notice.



www.mirashowers.co.uk
www.mirashowers.ie

©2013 by Mira
Kohler Mira Ltd.

Customers in the UK & NI should contact:
Cromwell Road, Cheltenham,
Gloucestershire, GL52 5EP, United Kingdom

Brochure Enquiries. 0844 571 0005
Customer Services. 0844 571 5000

Customers in the ROI should contact:
Modern Plant Ltd. (Ireland), Otter House,
Nass Road, Clondaklin, Dublin 22

Brochure Enquiries. 1800 818 637
Customer Services. 01 459 1344

 www.mirashoweringperfection.co.uk

 www.facebook.com/mirashowers

 www.twitter.com/mirashowers

 www.pinterest.com/mirashowers

 www.youtube.com/kohlermiraltd

Showering perfection™

mira
SHOWERS