



ST9100S Timer

With Boiler Service Reminder / Shut-down Feature

INSTALLATION INSTRUCTIONS

Specification

Power Supply: 230V~, 50...60Hz, 10W
 Switch Action: 1 x Potential Free SPST, 1x 230Vac SPST
 Switch Rating: 230V~, 50...60Hz, 3(3)A max for both relays
 potential free relay rated 10mA at 12Vdc min
 Factory set clock
 Power Reserve: lifetime battery
 Programmes/Settings: permanently stored in NV RAM
 Approvals: Conforms to protection requirements of
 Directives 2006/95EC and 89/336EC

Introduction

ST9100S is an Electronic Timer which provides accurate time control for central heating systems and other applications. It has an in-built Boiler Service Reminder / Shut-down Feature developed to assist Social Housing Landlords to comply with the requirements of Regulation 36 of the Gas Safety (Installation & Use) Regulations 1998. This is intended as an aid to compliance but should not be used to replace the Landlord's existing Servicing procedures.

ST9100S is suitable for replacing a wide range of Timers on the market, and is a direct replacement for Honeywell ST6100S Timers without the need for re-wiring.

ST9100S Timers can be combined with other Honeywell controls such as Room Thermostats, Cylinder Thermostats, Wiring Centres and Zone or Diverting Valves to form a fully automatic central heating control system.

Mounting

If the ST9100S is replacing an existing ST6100S then the existing wall-plate and wiring may be used, subject to any required electrical checks.

The Timer should be mounted at a level where the display can be seen clearly, (1.2 to 1.5m from the floor) and the ambient temperature is within the range of 0 to 40°C. The ST9100S is for use in normal domestic environments.

CAUTION

Isolate power supply and make safe before wiring the unit to prevent electric shock and equipment damage. Installation should be carried out by a qualified electrician or competent heating engineer.

Mounting Options

RECOMMENDED CLEARANCE DISTANCES:
 ABOVE WALLPLATE: 110mm
 BELOW WALLPLATE: 100mm
 LEFT/RIGHT OF WALLPLATE: 10mm

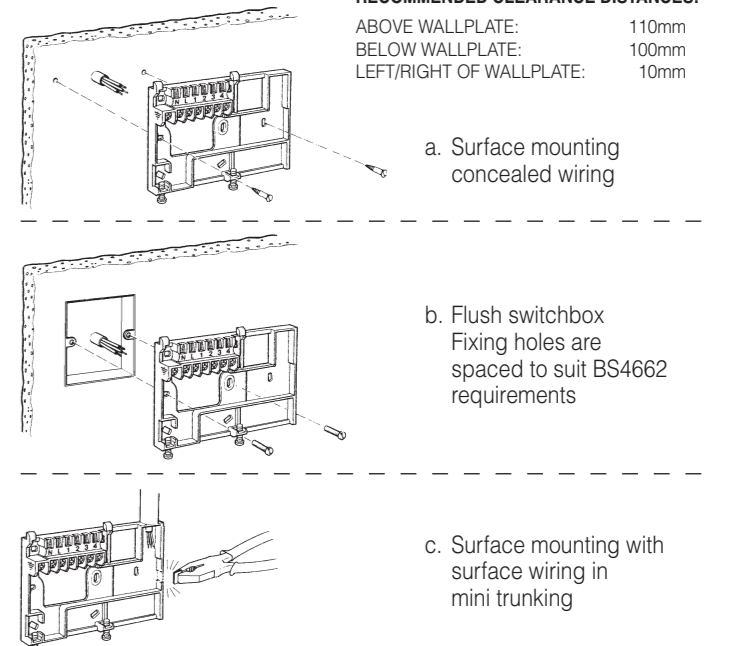

Ensure the mounting surface is supporting and fully covers the wiring wall-plate.

Wiring

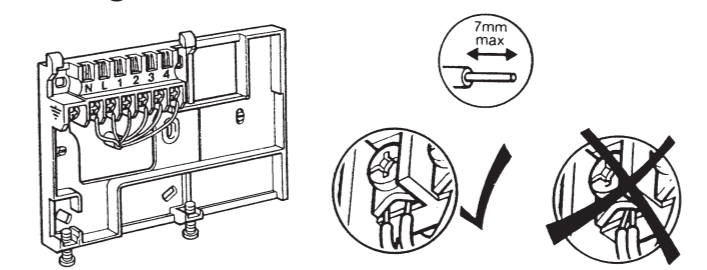

ALL WIRING MUST BE IN ACCORDANCE WITH I.E.E. REGULATIONS. THIS UNIT IS FOR FIXED WIRING ONLY.

A switch, having contact separation of at least 3mm in all poles (formerly Class 'A'), must be incorporated in the fixed wiring as a means of disconnecting the supply.

The unit is a Class II (double insulated) device. A parking terminal is provided for external earth continuity.

The system must be appropriately fused. A fuse rated at no more than 3 Amps should be installed.

The unit has 4 knockouts for surface wiring, care must be taken to ensure that the cable or mini-trunking completely fills the knockout hole without leaving any gaps.

Final Assembly

Clip the unit onto the hinges on the top of the wallplate and hinge down into position. Tighten the two securing screws using a screwdriver.

Switch on the power – the unit will now be operating according to the built-in programme. Note : the ST9100S is supplied with a factory set clock for faster installation.

Refer to ST9100S User Guide for programming details.

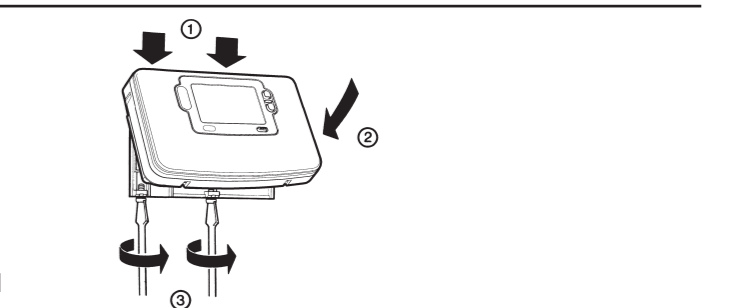

Set Service

Set Service parameters are listed in the table below, along with a description of the options that are possible.

| 'SET SERVICE' PARAMETER | Parameter ID | LoT™ Display Description | Default Value | Range of Values | Description [LoT™ Display Description] |
|--|--------------|--------------------------|---------------|-----------------|---|
| Enable or disable service alarm feature | AL | SERV MODE | 0 | 0, 1 | 0 = disabled [DISABLED] 1 = enabled [ENABLED] |
| Number of days till next Service | d | SERV DAYS | 364 | 001 to 400 | 001...400 [SET DAY COUNT] 000 = service is overdue |
| Number of days for advance warning | Ad | DAYS NOTICE | 28 | 0 to 28 | 0...28 [SET DAYS NOTICE] |
| Action taken at time-out | to | ACTION TYPE | 2 | 0, 1, 2 | 0 = no action, [NO ACTION] 1 = switch off, [SWITCH OFF] 2 = 'prompt' mode [PROMPT MODE] |
| Number of EXTRA HOUR button presses allowed in 'Prompt' mode | bP | 1HR BOOSTS | uL | uL, 1 to 99 | uL = unlimited number, [NUM BOOSTS] 1...99 = specified number of button presses, after which unit switches off |
| Enable telephone call number display | tC | SHOW PHONE | 0 | 0, 1 | 0 = disabled [DISABLED] 1 = enabled [ENABLED] |
| Enter telephone STD code | St | STD CODE | ----- | 1 | When a ⊕ ⊕ or ⊖ ⊖ button is first pressed the LoT™ Display shows a row of dashes which can be adjusted using ⊕ ⊕ or ⊖ ⊖ buttons, then verified using the OK button. |
| Enter telephone number | nU | NUMBER | ----- | 1 | When a ⊕ ⊕ or ⊖ ⊖ button is first pressed the LoT™ Display shows a row of dashes which can be adjusted using ⊕ ⊕ or ⊖ ⊖ buttons, then verified using the OK button. |
| * Reset 'SET SERVICE' parameters to default values | rS | ALRM RESET | 1 | 0,1 | 0 = do not reset [NO RESET] 1 = default parameters [RESET] |

* This parameter by default has a value of 1, unless any other parameter is adjusted, when it will change to 0. Set it to 1 to reset all parameters back to defaults

To Enter Set Service Mode:

- Enter **Installer Modes** (as described on Page 3) and navigate to **SET SERVICE** mode. In response to the query 'SET SERVICE OK ?' press the OK button to enter SET SERVICE.
- The message 'ENTER PIN' will now be displayed, along with the 4-digit entry code format 0---. The first digit will be flashing, to indicate it can be changed. Use the ⊕ ⊕ or ⊖ ⊖ buttons to set the first digit, and press OK to confirm the digit.
- At this point the first digit will stop flashing and the second digit will begin to flash, indicating it can be changed.
- Proceed in this way to enter the 4 digits of the PIN code. Upon confirming the last digit, if the PIN was incorrect, the message 'INVALID' will be displayed, and then the whole process will start again from step b. above.
- If the PIN was correct, the first SET SERVICE parameter AL will be available to change. This allows you to enable or disable all the service alarm features. At every step, the LoT™ Display will inform you what the parameter means and what option you have selected. The parameter ID is usually shown on the display separated by a colon from the parameter value.
- You can change the parameter value by pressing the ⊕ ⊕ or ⊖ ⊖ buttons. At this point the description in the LoT™ Display will change and the parameter value will flash. If you press OK the value will stop flashing and will be saved for use.
- Press OK to move to the next parameter available for editing. The parameter ID will change accordingly.
- Keep pressing OK to step around the list of parameters, and use ⊕ ⊕ or ⊖ ⊖ buttons to change the parameter value.
- Any parameter changes that have been confirmed with the OK button will be saved and used. Some parameters may be made invalid by a previous parameter setting, and these will be skipped over in the setting process.

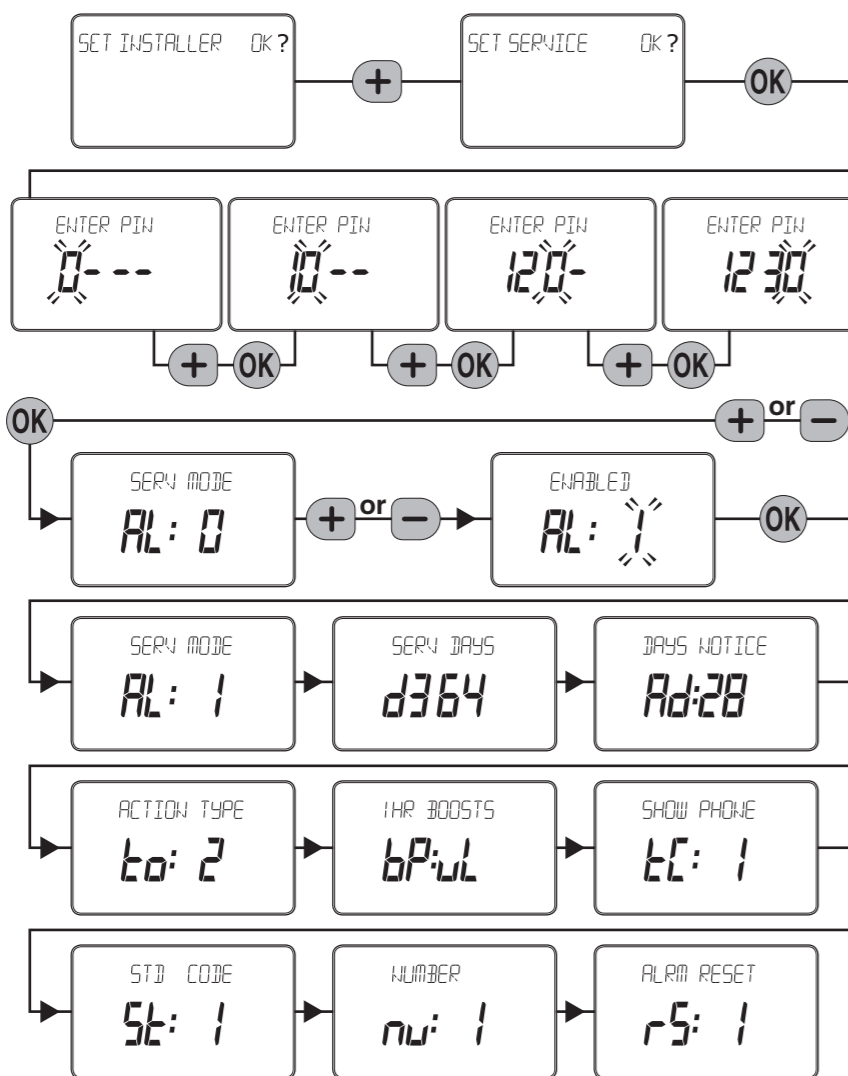

Change PIN

If you intend to change the PIN code, please ensure you take a note of the new code that you are setting.

The process for changing the current PIN code is as follows:

- Enter **Installer Modes** (as described on Page 3) and navigate to **CHANGE PIN** mode. In response to the query 'CHANGE PIN OK ?' press the OK button to enter **CHANGE PIN** mode.
- The message 'ENTER PIN' will now be displayed, along with the 4-digit entry code format 0---. The first digit will be flashing, to indicate it can be changed. Use the ⊕ ⊕ or ⊖ ⊖ buttons to set the first digit, and press OK to confirm the digit.
- At this point the first digit will stop flashing and the second digit will proceed to flash, indicating it can be changed.
- Proceed in this way to enter the 4 digits of the old PIN code. Upon confirming the last digit, if the PIN was incorrect, the message 'INVALID' will be displayed, and then the whole process will start again from step b. above.
- If the PIN was correct the message 'SET NEW PIN OK ?' will appear. As before, use the ⊕ ⊕ or ⊖ ⊖ buttons to set the digits, and the OK button to confirm. Upon confirming the final digit, the message 'PIN SET' will be displayed, and the new PIN code will be held on the screen for 5 seconds, to give you time to note it down.
- After setting the new PIN code, you will be taken back to the SETUP MENU.

What the User will See When a Service is Due

If the advance warning has been configured, the screen will flash this message every few seconds, and the User should telephone to arrange a service call before the final date when the service is due.

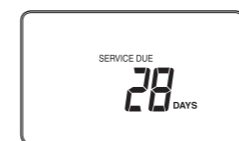

When the boiler service is overdue the screen will keep flashing the words 'SERVICE DUE' every second.

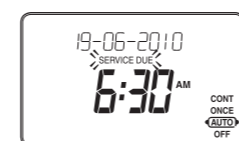

If the **NO ACTION** option has been selected, the unit will continue to operate as normal and the real time will continue to be shown.

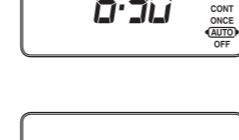

If the **SWITCH OFF** or **PROMPT** Actions have been selected, the 'SERVICE DUE' message will flash and the word 'OFF' will appear on the display. The boiler has been switched off to ensure the safety of the User. A service appointment should be arranged immediately.



In **PROMPT** operation, the User can obtain limited use of the boiler by pressing the **EXTRA HOUR** button. Each button press will allow operation of the boiler for 1 hour at a time, and the screen will display the message 'On 1h', as shown. A service appointment should be arranged immediately.



If a contact telephone number has been programmed into the ST9100S, a message will appear on the LoT™ Display indicating the number that should be called.

Honeywell Control Systems Ltd.

Arlington Business Park,
 Bracknell
 Berkshire
 RG12 1EB
 Technical Help Desk: 08457 678999
 www.honeywelluk.com



50022736-003 A
 © 2007 Honeywell International Inc.

Completion Checklist for Installation

- Check unit powers up correctly, and that the display does not remain blank.
- Set operating mode to **AUTO** and switch on and off using the **VERRIDE** button, to ensure the system is operating correctly.
- Check the factory-set day, date, and time are correct and adjust if necessary. Refer to User Guide for details.
- If required, enter Installer Setup Mode and adjust Installer Parameters to match the lifestyle and needs of the User. Remember to make a note of these parameter changes in the Configuration Data section of the User Guide.
- If required, enter Set Service Mode and enable the Boiler Service Reminder, and set the appropriate Service parameters.
- Explain the operation of the product to the User and help them to set their programme. There are 3 built-in profiles that can be used as a basis for typical User programmes.
- Explain when the User should contact someone to arrange a Service Visit, and what you have programmed to happen when the Service is overdue.
- If required, attach the self-adhesive programme guide label to the underside of the cover flap. The label is supplied in the box and requires to be peeled away from the backing material before use.
- Write the date of installation, your name and telephone number in the space provided in the User Guide, in the section 'Boiler & System Service Log'.
- Remember to leave the User Guide and Installation Instructions with the User and remind them to keep them in a safe place. This forms part of a Home Information Pack.

Resetting the Service Timer Function

If the Service Timer function is enabled you will be required to reset it after the boiler service has been carried out.

The process for resetting the Service Timer is as follows:

- Enter **Installer Modes** (as described on page 3) and navigate to **SET SERVICE** mode. In response to the query 'SET SERVICE OK ?' press the OK button to enter **SET SERVICE** mode.
- If you no longer require the Service Timer, disable it by setting parameter **AL** to **0** and confirm with the OK button.
- If you still require the Service Timer, set the number of days until the next service is due using parameter **d** and confirm with the OK button.
- Whilst in **SET SERVICE** mode, use the opportunity to change any other service parameters if required.
- Exit by moving the slider to the next position and back again to **RUN**.

This product and its associated documentation and packaging are protected by various intellectual property rights belonging to Honeywell Inc and its subsidiaries and existing under the laws of the UK and other countries. These intellectual and property rights may include patent applications, registered designs, unregistered designs, registered trade marks, unregistered trade marks and copyrights.

Honeywell reserves the right to modify this document, product and functionality without notice. This document replaces any previously issued instructions and is only applicable to the product(s) described.

This product has been designed for applications as described within this document. For use outside of the scope as described herein, refer to Honeywell for guidance. Honeywell cannot be held responsible for misapplication of the product(s) described within this document.

Manufactured for and on behalf of the Environment and Combustion Controls Division of Honeywell Technologies Sarl, Ecublens, Route du Bois 37, Switzerland by its Authorised Representative Honeywell Inc.

WIRING CONNECTIONS

ST9100S Internal Wiring

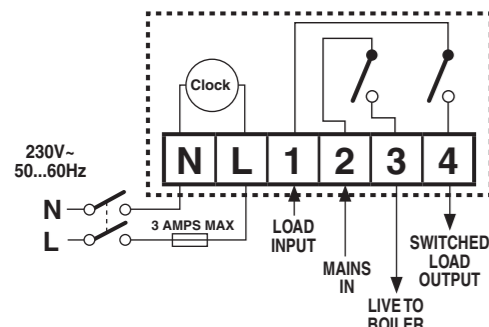

Notes

1. The ST9100S is a Class II (double insulated) device. An earth parking terminal is provided for earth wiring continuity, if required.
2. The ST9100S is a single channel timer designed for combi-boiler installations, and can be wired to shut down both heating and hot water after the service period.
3. Wiring can be done all at 230Vac, or the boiler control output connections can be contact closure potential free.
4. Where applicable, the ST9100S may also be used to control hot water systems independently.
5. Where applicable, multiple ST9100S timers may also be used to control Heating and Hot Water systems independently.
6. When connecting to a wireless receiver unit, the receiver MUST have permanent mains power from the fused spur, to operate correctly.

Connections to Combi Boiler

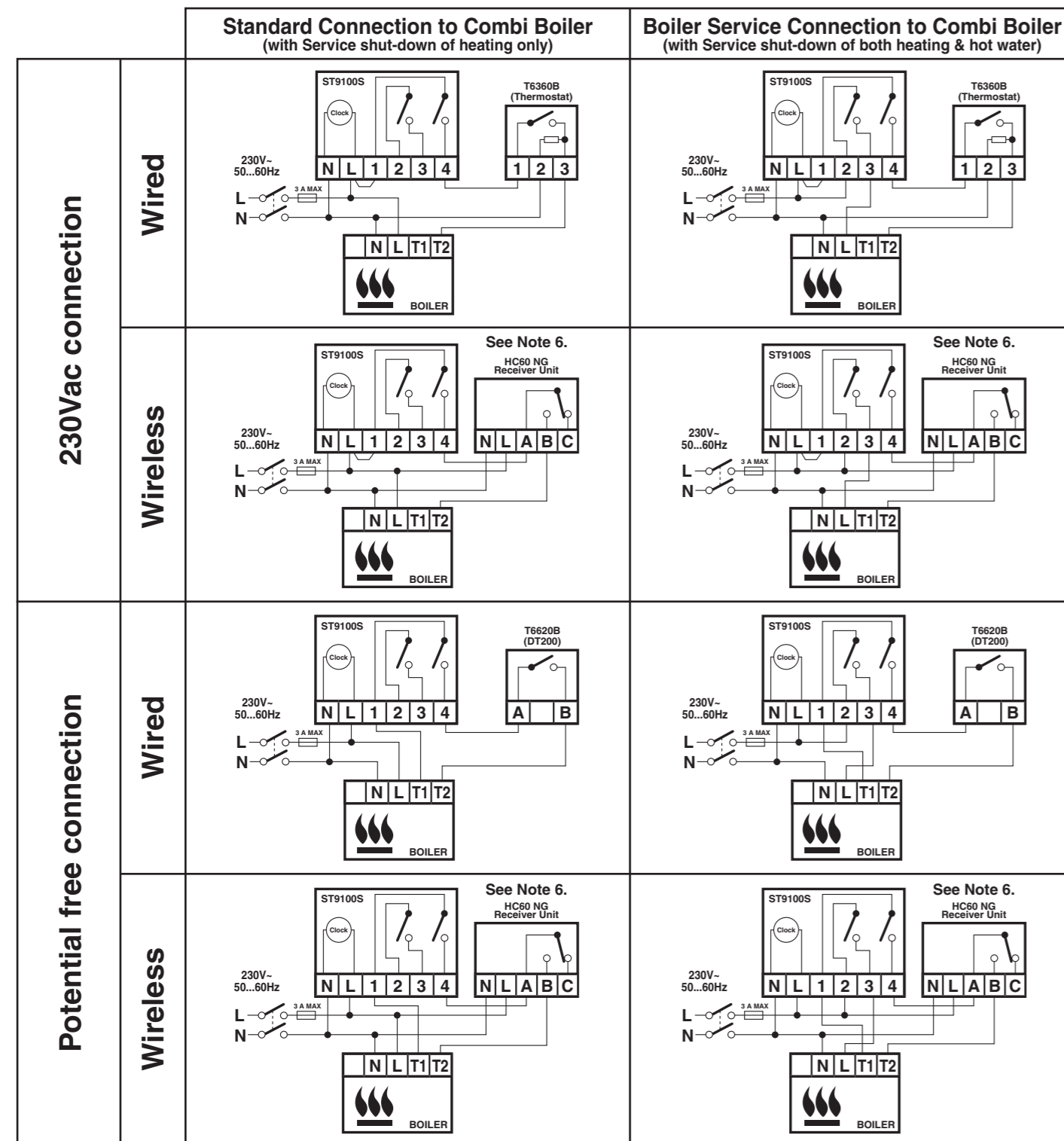

Replacement Wiring

If using the ST9100S to replace other Honeywell Timers, the equivalent wiring terminations are shown in the tables below.

| | | | | | | |
|--|---|---|----------------------|---|---|---|
| ST6100S | L | N | 1 | 2 | 3 | 4 |
| ST9100S | L | N | 1 | 2 | 3 | 4 |
| Note: If ST6100S terminals 2 and 3 do not have wires connected to them, there is no need to connect wires to ST9100S terminals 2 and 3. | | | | | | |
| ST6100A, ST6100C | L | N | 1 | 2 | | 4 |
| ST9100S | L | N | 1 | * | | 4 |
| * Note: If a connection is required at terminal 2 of the product to be replaced, the ST9100S cannot be used for this application. Use ST9100A or ST9100C instead. | | | | | | |
| ST7000B | L | - | - | 2 | | 3 |
| ** ST9100S | L | N | 1 Link to terminal L | * | | 4 |
| ** Note: a permanent mains supply must be provided for the ST9100 Timer | | | | | | |

Replacing Other Manufacturers' Time Controls

ST9100S Timers will mount directly onto many existing manufacturers' back-plates, without the need for re-wiring. However, they are also supplied complete with a wiring back-plate, should this not be the case.

Refer to Honeywell for wiring conversion diagrams (see Wiring Guide document EN3H 2393 UK01).

ADDITIONAL PRODUCT FEATURES

Boiler Service Reminder / Shut-down Feature

The ST9100S Service Interval Timer has been developed to assist Social Housing Landlords to comply with the requirements of Regulation 36 of the Gas Safety (Installation & Use) Regulations 1998. It is intended as an aid to compliance but should not be used to replace the Landlord's existing Servicing procedures.

The ST9100S performs like a standard Timer. In addition it can automatically provide a Service Reminder and can be set to Shut-down the heating / hot water system once the gas Boiler Service becomes overdue. This helps to eliminate the potential for an incident to occur after the Landlord's Safety Certificate has expired.

The operation of the Service Feature is flexible. The landlord or installer can set the following:

- The service interval, in days
- An advance reminder for the tenant, by counting down days until service is due
- A telephone number to call to arrange the service – displayed on the LCD screen
- How the timer will operate when the service interval has expired. The options include:
 1. Continued normal operation with a Reminder message
 2. Total shutdown of heating and hot water
 3. "Prompt" mode – shutdown that will allow repetitive manual over-ride for one hour at a time.

The Service feature is configured from a special Installer Mode called 'SET SERVICE'. Entry into this mode is only possible by entering a unique 4 digit PIN code.

Note: The ST9100S is supplied from the factory with the Service features DISABLED. They need to be enabled from the Installer Modes. See following section 'Installer Modes' for details.

Installer Modes

ST9100S has 3 Installer Modes that enable the product to be customized for the application and for the needs of the User. Each adjustable feature is called a Parameter, and is represented by a number or letter ID and a value. The Modes are:-

- **Installer Setup**
This is the same as the Installer Setup for standard ST9000 time controls. It allows features to be adjusted to suit user lifestyles or preferences, for example; backlight operation, automatic time-change, and selection of the default time programme. It is entered by a combination of button presses.
- **Set Service**
This is where the ST9100S Boiler Service Reminder and Shut-down Features can be set. This mode can only be entered by using a 4 digit PIN code. The factory supplied default PIN code is 0000
- **Change PIN**
This mode allows the 4-digit PIN code to be adjusted. It is itself protected by the PIN code. When the code is changed this new code is used to enter both SET SERVICE and CHANGE PIN modes.

To Enter & Navigate Around the Installer Modes:

- Ensure the slider is in the **RUN** position, then press and hold **OK** and **+** buttons together for 8 seconds. Ignore the 'NOT VALID' that is displayed for a few seconds. The message 'SET UP MENU' will show briefly, to indicate you have entered the Setup menu. The *LoT™ Display* will continue to show messages indicating which Installer Mode is possible to select, for example 'SET INSTALLER OK ?'
- Use the **+** or **-** buttons to navigate to the correct Installer Mode.
- Use the **OK** button to confirm you wish to enter that particular mode.

| Installer Mode | LoT™ Display Message |
|-----------------|----------------------|
| Installer Setup | 'SET INSTALLER OK ?' |
| Set Service | 'SET SERVICE OK ?' |
| Change PIN | 'CHANGE PIN OK ?' |

To Exit Installer Modes:

You can exit the Installer Modes at any time by moving the slider to the next position and then back again to **RUN**. Any changes that have been confirmed will be saved and used.

Note: The Installer Modes and the Setup Menu will exit automatically after 10 minutes if the slider is not moved and no adjustments have been made in this time.

Installer Setup

Installer Setup parameters are listed in the table below, along with a description of the options that are possible.

| INSTALLER PARAMETER | Parameter Number | LoT™ Display Description | Default Value | Range of Values | Description [LoT™ Display Description] |
|---|------------------|--------------------------|---------------|-----------------|--|
| 24hr or am/pm clock display | 1 | CLOCK MODE | 12 | 12, 24 | 12 = am/pm display, [AM-PM] 24 = 24hr display [24 HOUR] |
| Configure backlight operation (backlight consumes no additional energy) | 2 | BACKLIGHT | 2 | 0, 1, 2 | 0 = off, [NO B-LIGHT] 1 = on if button pressed, [B-L DELAY] 2 = on continuously [B-LIGHT ON] |
| Enable/disable auto time change | 3 | AUTO TIME | 1 | 0, 1 | 0 = disabled, [NO CHANGE] 1 = enabled [TIME CHANGE] |
| Number of ON/OFFs per day | 5 | ON PERIODS | 2 | 2, 3 | 2 = 2 on/off's per day, [2 PER DAY] 3 = 3 on/off's per day [3 PER DAY] |
| Select default time programme | 6 | DEF PROFILE | A | A, b, C | A = standard, [PROFILE A] b = at home, [PROFILE B] C = economy [PROFILE C] |
| * Reset all parameters | 8 | PROG RESET | 1 | 0, 1 | 0 = do not reset [RESET OFF] 1 = default parameters [RESET ON] |

* This parameter by default has a value of 1, if any other parameter is adjusted it will change to 0. Set it to 1 to reset all parameters back to defaults.

To Enter Installer Setup:

- Ensure the slider is in the **RUN** position, then press and hold the **OK** and **+** buttons together for 8 seconds. Ignore the 'NOT VALID' that is displayed for a few seconds. The message 'SET UP MENU' will show briefly, followed by 'SET INSTALLER OK ?'
- Press the **OK** button to take you into the Installer Mode Parameter Menu.
- Parameter 1 is now available to change. This is to allow you to change the clock format from 12 hour AM/PM to 24 hour. At every step, the *LoT™ Display* will inform you what the parameter means and what option you have selected. The parameter number is shown on the display separated by a colon from the parameter value.
- You can change the parameter value by pressing the **+** or **-** buttons. At this point the description in the *LoT™ Display* will change and the parameter value will flash. If you press **OK** the value will stop flashing and will be saved for use.
- Press **OK** to move to the next parameter available for editing. The parameter number will change accordingly.
- Keep pressing **OK** to step around the list of parameters, and use **+** or **-** buttons to change the parameter value.
- Any parameter changes that have been confirmed with the **OK** button will be saved and used.

To Exit Installer Setup:

You can exit Installer Mode at any time by moving the slider to the next position and then back again to **RUN**.

Note: Installer Mode will exit automatically after 10 minutes if the slider is not moved.

