

Radiator Thermostat RAS-D² Combi

BI-DIRECTIONAL VALVE WITH FLOW-SELECTABLE FEATURE

Installation of valve

The valve is a bi-directional valve * and can be installed horizontally or vertically in either the flow or return pipe.

A built in flow direction selection feature can be used to eliminate the risk of water hammer.

We recommend using a flat faced adjustable spanner and a soft cloth to protect the chrome surfaces when tightening up the connections.

Troubleshooting

In the unlikely event of water hammer being encountered turn the setting ring (see diagram 4) to the other setting.

Alternatively if commissioning the whole system, establish the flow direction through each valve using the diagrams below.

If the flow direction needs to be changed there is no need to remove the valve, simply turn the setting ring.

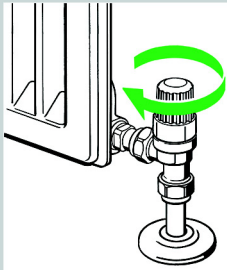

1
Close all radiator valves by turning the valve cover cap clockwise. Leave system to cool.

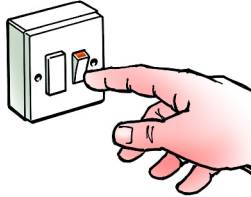

2
Start boiler/heating.

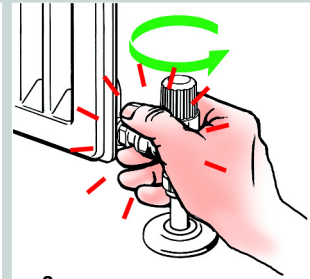

3
Open one valve and determine flow direction. Which pipe heats first?

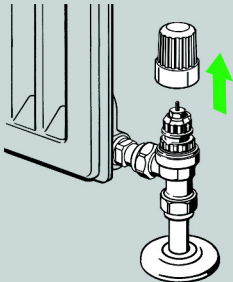

4
Remove cap and turn setting ring according to the drawings - the setting ring is turned by hand only.

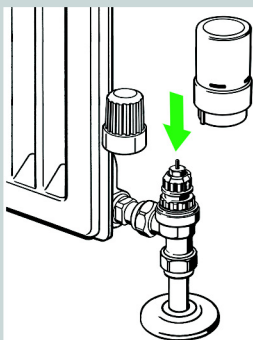
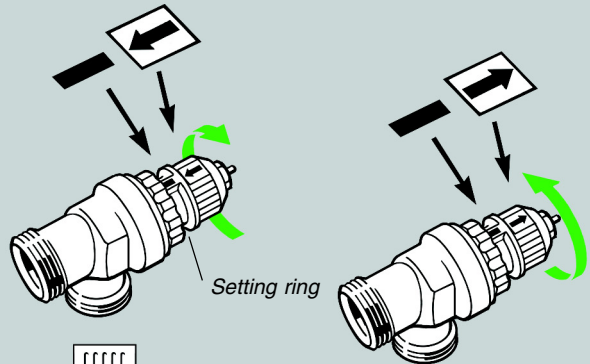

5
Repeat step 3 and 4 until all valves have been set correctly. Sensor may now be fitted or the valve cap temporarily refitted.

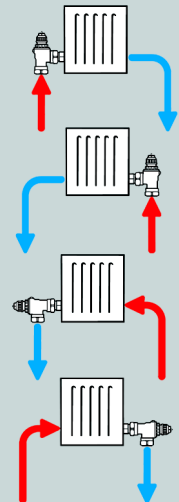
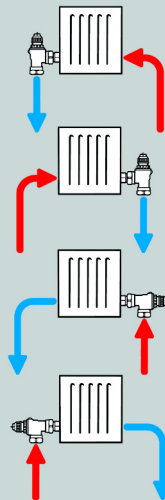

* Maximum pressure drop should not exceed 0.45 bar

Installation Guide

User Guide

Fitting the Sensor

1. Remove cap from valve and turn sensor to

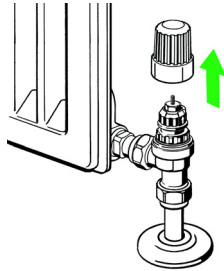

2. Press the sensor firmly onto the valve. **Sensor horizontal:** ensuring that the scale pointer is at top. **Sensor vertical:** ensuring that the scale pointer is at the front.

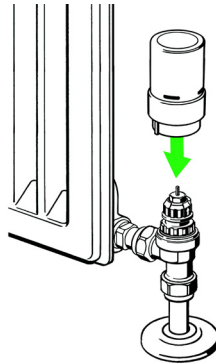

3. Whilst holding the sensor firmly on the valve secure connection by tightening the Allen screw using the enclosed key.

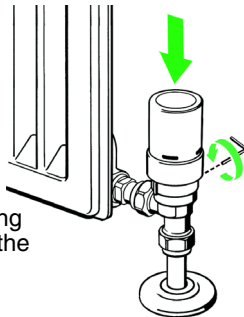

4. Set desired room temperature.

Removing the Sensor

Loosen the Allen screw (3). The sensor can now be separated from the valve.

Setting the desired room temperatures

The desired room temperature is set by turning the head. The temperatures obtained are approximately:

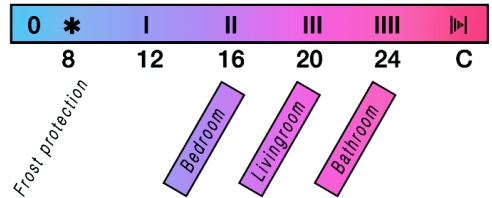

Do not cover the thermostat

The thermostat opens and closes as determined by the temperature around it. Therefore the sensor must never be hidden behind thick curtains, furniture, etc. Alternatively a thermostat with remote sensor should be used.

Positive SHUT-OFF feature:

The head can be turned past the * setting (a slight resistance will be felt) to setting "0" at which point the water flow is shut off completely. After also shutting the lockshield valve the radiator may be drained and removed for maintenance and decoration purposes.

Lockshield valve RLV-D is included in codes: Code no's 013G6016 and 013G6017



Removal of protective cap

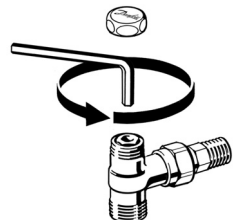

Balancing