



# JANUARY 2024

## PRODUCT CATALOGUE

OIL HEATING, REFUELLING AND LIQUID TRANSFER PRODUCTS



## ABOUT US

Atkinson Equipment Limited is a Wiltshire based precision engineering company. Our mainstay products are the Tankmaster Valve & Sight Gauge which we have been manufacturing in our machine shop since the late 1960's.

Fuel Transfer equipment is one of our core businesses. We stock all the components required to enable you to complete your fueling setup, whether its just a portable refueling setup, or drum mounted dispenser to a complete pumped refueling station.

✓ 60 YEARS EXPERIENCE IN OIL HEATING, FUEL TRANSFER & ADBLUE EQUIPMENT

### THE ATKINSON GROUP



### DISTRIBUTORS



OFFICIAL UK DISTRIBUTOR FOR:



## QUALITY

It is the policy of these Atkinson Group Companies to be totally committed to ensuring that customers and clients receive optimum quality products together with the highest possible levels of service.



# ORDERING & DELIVERY

## PHONE



01373 822220

## EMAIL



sales@atkinsonequipment.com

## FAX



01373 826996

Have an account with us? Please note minimum order value of £30 net goods when using credit account

STANDARD 2/3 DAY DELIVERY	PALLET ORDERS	OVER £750	OVER £450	OVER £360	UNDER £360
MAINLAND UK	P.O.A	-	-	<b>FREE</b>	£12.75
SCOTTISH HIGHLANDS & ISLANDS	P.O.A	-	<b>FREE</b>	£21.50	£28.00
CHANNEL ISLANDS	P.O.A	-	-	£26.00	£30.00
NORTHERN IRELAND	P.O.A	<b>FREE</b>	-	£27.00	£32.00
SOUTHERN IRELAND	P.O.A	<b>FREE</b>	-	£29.00	£36.50

## NEXT DAY SERVICES - MAINLAND UK ONLY

BEFORE 9:30AM	<b>£35.00</b>
BEFORE 10:30AM	<b>£30.00</b>
BEFORE 12:30PM	<b>£20.00</b>
SATURDAY DELIVERY	<b>£50.00</b>
PALLET RATE	<b>P.O.A</b>

## ROYAL MAIL - UP TO 2KG - UK MAINLAND

1ST CLASS POST - 0-1KG	<b>£4.50</b>
1ST CLASS POST - 1-2KG	<b>£7.75</b>

## OTHER

AIRFREIGHT - SPECIAL ORDER	<b>P.O.A</b>
COLLECTION - CONTACT US TO ARRANGE	<b>FREE</b>

Orders can be placed until 2pm Monday - Friday for same day despatch on off the shelf items.

**Please note:** Pallets may have an earlier cut off time.

# RETURNS

- Call or email us to obtain a returns reference number, this will need to be marked on the outside of the box.
- Carriage cost to return the item will be paid by the sender. We can arrange a collection but you will be charged.
- Refund will be for the product cost only, not including any carriage charge on original purchase.
- Goods must be returned within 14 days to receive a full refund, after this time we reserve the right to charge a 20% restocking fee.
- All of the above will only be valid if the item is returned unused, in it's original packaging and in a resaleable condition.
- Faulty goods will be returned to us, inspected and either repaired, replaced or credited at our discretion.
- Items which are built or manufactured to order, bespoke, or imported specifically at customer's request; Cancellations, may not be subject to a refund or only a partial refund may be applicable.

# CONTENTS

## OIL HEATING EQUIPMENT

OVERFILL PREVENTION VALVES / TANK ALARMS	6
TANK FILL POINTS / DRY BREAK COUPLINGS	7
TOP OFF TAKE VALVE	8
INLINE FILTER VALVES / TANKMASTER VALVE & SIGHT GAUGE	9
TANKMASTER SPARES & SERVICE KITS	10
PUSH BUTTON SIGHT GAUGES & SPARES	11
FUEL TANK LEVEL GAUGES / PRESSURE & VACUUM GAUGES	12
INLINE FILTERS & REPLACEMENT ELEMENTS	13-14
VENT & FILLER CAPS	15
TANK SECURITY / PRESSURE REGULATING VALVES	16
TANK WATER REMOVAL KITS	17
ANTI SIPHON VALVES / INLINE OIL METERS	18
FREE FALL FIRE VALVES & SPARES	19-20
LEVER / FUSIBLE HEAD / SOLENOID FIRE VALVES	20-21
FUELSOP CAPILLARY FIRE VALVES	21-22

## REFUELLING & LIQUID TRANSFER

FUEL DISPENSING NOZZLES / NOZZLE ACCESSORIES	29-31
HOSE FITTINGS & ACCESSORIES (SWIVEL JOINTS, TAILS, NON RETURN VALVES, CAM & GROOVE COUPLINGS, TIMERS & SWITCHES)	32-34
DIESEL DISPENSING HOSE KITS	35
FUEL DISPENSING HOSE	36-37
FUEL HOSE REELS	37-38
FLUID FLOW METERS	39
GPI/FLOMEC FLOW METERS	40-45
HAND PUMPS / DRUM PUMPS / CHEMICAL PUMPS	46-47
GPI/GPRO TRANSFER PUMPS & KITS / ACCESSORIES	48-50
FMT SWISS AG TRANSFER PUMPS	51
TRANSFER PUMP KITS	52
DIESEL MANAGEMENT SYSTEMS	53
WATER TRANSFER PUMPS / SUBMERSIBLE PUMPS	54-56
FUEL FILTERS & ELEMENTS	57-58
FMT PUMP SPARES	59
GPI FLOW METER SPARES & ACCESSORIES	60-61

## ADBLUE EQUIPMENT

ADBLUE PUMPS & KITS	63-64
ADBLUE NOZZLES	64-65
ADBLUE FLOW METERS / ADBLUE HOSE	65
DRY BREAK COUPLINGS	66
ADBLUE FITTINGS & ACCESSORIES	67

## PIPE & MISCELLANEOUS FITTINGS

PRESSURE RELIEF VALVES / GLUES & THREAD SEALING	69
BALL & GATE VALVES	69-70
MISCELLANEOUS PIPE FITTINGS (EQUAL, REDUCING NIPPLES, BUSHES, ELBOWS, COMPRESSION FITTINGS)	70-71
CREDIT ACCOUNT FORM / TERMS & CONDITIONS	72-76

# OIL HEATING EQUIPMENT



Everything you need for your heating oil storage tank. Valves, vent caps, fill points, top offtake valves, Tigerloop deaerators, fire valves, fire shut valves, contents gauges including sight gauges.

# OVERFILL PREVENTION VALVES

## FEATURES

- Universal Pattern, with plastic tank (with manhole) Fitting adaptor
- Extruded Aluminium float with cross drilled spindle
- Reduced ullage to 150mm

## PERFORMANCE CHARACTERISTICS

- Maximum Flow >580lpm
- Minimum Flow <50lpm
- Maximum Pressure 7 bar
- Maximum Spike pressure 12 bar
- Minimum Pressure 150mb
- Leak Rate when closed <2.5lpm
- Maximum Flow >580lpm



Designed to act as the fill point on both metal and plastic diesel tanks. The Filstop physically closes the inlet to the tank should the fuel level reach its maximum during delivery. This prevents the tank from being overfilled or bursting and hence reduces the risk of pollution and expensive clean up operation that might arise from such an occurrence.

PART NUMBER	DESCRIPTION
GV4000	For Plastic Tanks - 2" BSP C/W Fitted Flange & Nut
GV4300	For Steel Tanks - 2" BSP Parallel Threaded Body
GV4300-NPSM	For Steel Tanks - 2" NPSM Parallel Threaded Body
FC5080	Filler Cap - Green Plastic, C/W Chain & Fastener
PTF-NUT	Steel Hex Nut 2" BSP
GV5000	Overfill Prevention Valve Fitting Tool

## OVERFILL & BUND TANK ALARMS

Each alarm comes complete with the alarm unit and the probes that fit into the tank. All of our alarms are made in the UK and come complete with full, easy to understand installation instructions.

### OVERFILL ALARM

This unit provides warning of a possible overflow, giving time for action to avoid potential pollution. A 'test' feature is included for use before tank filling commences.

### BUND ALARM

Should a significant amount of fluid get between the tank and the bund the unit will emit a 90dB warning alarm. The unit can also be used as an underfill alarm.

### COMBINED OVERFILL & BUND ALARM

The features of both alarm types are incorporated in this one unit.



PART NUMBER	DESCRIPTION
TA1050	Bund Alarm, Battery 9vDC
TA1040	Bund Alarm, Mains 230V50hz
TA1010	Overfill Alarm, Battery 9vDC
TA1020	Overfill Alarm, Mains 230V50hz
	Low Level Alarm
TA1070	Combined Bund/Overfill - Battery/Reset Button
TA1055	Combined Bund/Overfill - Battery 9vDC
TA1080	Combined Bund/Overfill - Mains 230V50hz
TA1080-VF	Combined Bund/Overfill, Mains, With Volt Free contact on Bund
	Combined Low Level/Overfill, Mains 230V50hz

# TANK FILL POINTS

## PLASTIC TANK FILL POINT

This is suitable for use with all plastic tanks that can be accessed from the inside through a 'hatch'.

**Please note:** Requires a 2" hole to be cut in the top of the tank and the unit passed up through from the inside and the locking nut to be attached from the outside to hold this in place.

PART NUMBER	DESCRIPTION
PTF-NUT	Plastic Tank Nut - 2" BSP
PTF1000	Plastic Tank Fitting
PTF1050	Plastic Tank Fitting O-Ring - 55.5mm x 3mm
PTF-2/2	2" BSP Male x 2" BSP Male Hex Nipple
PTF3000	Complete Tank Inlet Point - 2" BSP Threaded



## REMOTE OFFSET FILL POINT KIT

Available with 2" hose tail connection or 2" male threaded connection according to whether you are fitting this to hose or iron pipework.

Comprises a non-return valve; ball valve; mounting bracket; elbow; polypropylene cap with chain; and appropriate 2" connector.

**TIP:** When fitting an offset fill point, you need to consider the fuel delivery driver may not be able to see the tank or the progress of the delivery. An offset fill point should therefore only be considered with an overfill prevention valve fitted or an overfill alarm fitted to the tank.

PART NUMBER	DESCRIPTION
BVP-5101	2" Remote Off Set Fill Point - Hose Tail
BVP-5100	2" Remote Off Set Fill Point - Threaded



## DRY BREAK COUPLING

The Atkinson dry break coupling for ADBLUE is designed to open and close automatically when the delivery hose is connected and disconnected.

The valve insures minimum liquid loss on disconnection even if connected or disconnected whilst filling is in progress.

### FEATURES:

- 2" BSP Female Thread
- EPDM Seal
- For Tanks up to 10,000 Litres
- 304 Stainless Steel
- 10 Bar Working Pressure

PART NUMBER	DESCRIPTION
DBC-1000-AB	Dry Break Coupling 2" Stainless Steel
DBC-DUSTCAP	Dust Cover for DBC-1000





Draw oil from your tank safely with the new Atkinson Tanktop, Top Offtake System. Leading the way into the world of Top Offtake, the Atkinson Tanktop is the **WORLDS FIRST** Top Offtake device with all of the necessary features and functions to responsibly draw oil from the top of a tank.

**Important Note:** The pressure is pre-set in the factory at a 1.5m negative head and this is not adjustable by the user (suitable for all known boilers on the market). If you require this to be pre-set to any other pressure between 0-5.5m negative head on request.

It is also recommended you have a Deaerator in your oil line and always use support tubes inside soft copper oil lines to ensure air tight joints when using compression joints.

PART NUMBER	DESCRIPTION
TTV-01-C	Tank Top Off Take Valve - For Plastic Tanks
TTV-01	Tank Top Off Take Valve - For Steel Tanks
TTV-FILTER	Replacement Filter Kit - Includes Filter and Viton O'rings
TTV-ASMODULE-C	Replacement Anti-Siphon Module
TTV-WEATHER	Weatherproof/Dust Cover Kit
TTV-FLOAT	Replacement Hose Kit - Includes 2m Suction Hose & Float
TTV-01-C-STRP	Tank Top Off Take Valve - For Steel Tanks with Rigid Pipe Fitment



## INLINE FILTER VALVES

Featuring an isolation valve, 50 micron nylon filter element, 1" BSP male tank-fitting adaptor.

Outlet is 3/8" BSP Female and this comes supplied with a 3/8" BSP Male to 10mm compression fitting as standard.

Comes supplied with a roll of PTFE tape and a 10mm plastic bottle of Heldite for the tank connection.

PART NUMBER	DESCRIPTION
AFV-1000	Inline Filter Valve Kit
AFV-1000-SP	Inline Filter Valve Kit without Heldite
AFV-1000-KIT	Replacement Filter & Seal Kit for AFV-1000
AFV-1000-KIT-V	Replacement Filter & Seal Kit for AFV-1000 - With Viton Gasket



Designed by Atkinson Equipment, featuring an isolation valve, 52 micron nylon filter element, 1" BSP male tank-fitting adaptor, hydraulic positioning nut and PTFE tape.

The outlet is 3/8" BSP Female and this comes supplied with 1x 3/8" BSP Male to 10mm compression fitting.

PART NUMBER	DESCRIPTION
AFV-2000	Atkinson Inline Filter Valve Kit
TM4660F	Replacement Filter & Seal Kit for AFV-2000 & AFV-1003



Designed by Atkinson Equipment, featuring an isolation valve, 52 micron nylon filter element, 1" BSP male tank-fitting adaptor, PTFE tape, and a backnut to lock the filter in the correct orientation once the adaptor has been tightened.

This has three outlets 3/8" BSP female, one either side of the body (not shown in picture) thus exiting at right angles to the tank, one to the left and one to the right. These outlets can be utilised using the two standard 3/8" x 10mm compression fittings (one supplied) or either one of these can be closed off using the 3/8" BSP blanking plug supplied.

PART NUMBER	DESCRIPTION
AFV-1003	Atkinson Inline Filter Valve Kit
TM4660F	Replacement Filter & Seal Kit for AFV-2000 & AFV-1003



## TANKMASTER VALVES & SIGHT GAUGE

PART NUMBER	DESCRIPTION
TM4790	Tankmaster Valve Body
TM4480	(1370mm) 4ft 6" PVC Tankmaster Sight Tube
TM4490	(1520mm) 5ft PVC Tankmaster Sight Tube
TM4500	(1830mm) 6ft ALU Tankmaster Sight Tube
TM4520	(2440mm) 8ft ALU Tankmaster Sight Tube
TM4521	(2743mm) 9ft ALU Tankmaster Sight Tube
TM4522	(3050mm) 10ft ALU Tankmaster Sight Tube
TM4480-A	(1370mm) 4ft 6" ALU Tankmaster Sight Tube
TM4490-A	(1520mm) 5ft ALU Tankmaster Sight Tube

### TANK EXTENSIONS

TM4542	(35mm) 1 1/4" x 1" M - 1/2" F BSP Aluminium Tank Extension
TM4545	(90mm) 3 1/2" x 1" M - 1/2" F BSP Aluminium Tank Extension
TM4549	(160mm) 6 1/2" x 1" M - 1/2" F BSP Aluminium Tank Extension
TM4547	(180mm) 7 1/2" x 1" M - 1/2" F BSP Aluminium Tank Extension



# TANKMASTER SPARES & FITTINGS

PART NUMBER	DESCRIPTION
TM4660F	Replacement Filter & Seal Kit
GFH3540	3/8" BSP - 15mm Compression Fitting
TM4175/TM4171	3/8" Nut & 10mm Olive
TM4175/TM4161	3/8" Nut & 3/8" Olive
TM4400	Set of 9 Replacment O'Rings
TM4326-SS	Mark II Filter Bowl - 1-1/4"
TM4310	On/Off Handwheel
TM4410	On/Off Handwheel Circlip
TM4155	Pull to Read Valve
TM4565	Tank Union & Valve
TM4675/TM4390	Bolt & Seal for Filter Bowl
TM4191-10	10mm Brass Olive
TM4161	3/8" Brass Olive
TM4071/TM4072	Tube Nipple & O'Ring
TM4172	Brass Insert for 10mm Soft Copper Pipe
TM4178	Brass Insert for 8mm Soft Copper Pipe
SG2170	Sight Shield Coupler
COM2180	Black Top Cap
TM4240	Union Nut
SG2000	Sight Gauge Green Ball Level Indicator



## TANKMASTER SERVICE KIT

Tankmaster series II service kit including everything you need to service your Tankmaster valve filter and sight tube. **Kit includes:**

- Filter Elements & Seals
- Tube Nipple
- Top Cap
- 2 Meters of Clear Sight Tubing

PART NUMBER	DESCRIPTION
TM4660SK	Tankmaster Service Kit



## TANKMASTER UPGRADE KIT

Tankmaster series I to series II upgrade kit. Everything you need to update your Tankmaster. **Kit includes:**

- Filter Elements & Seals
- O-Ring Kit
- Top Cap
- Filter Bowl & Bolt
- Nuts & Olives
- Filter Tube
- Tankmaster Body (Excludes valve or union)

PART NUMBER	DESCRIPTION
TM4790-UG	Tankmaster Upgrade Kit



## TANKMASTER SERVICE & UPGRADE KIT

This kit will enable you to upgrade your Tankmaster from a Series I to a Series II Tankmaster as well as servicing the unit. **Kit includes:**

- Filter Elements & Seals
- O-Ring Kit
- Top Cap
- Filter Bowl & Bolt
- Nuts & Olives
- Filter Tube
- Tankmaster Body (Excludes valve or union)
- Tube Nipple
- 2m of Sight Tubing

PART NUMBER	DESCRIPTION
TM4790UG/SK	Tankmaster Service & Upgrade Kit



## PUSH BUTTON SIGHT GAUGES

These push button gauges give a clear reading of the level of contents in a tank. They have unbreakable sight tubes and can be supplied in lengths to suit any tank depth. Sight Gauges should not be fitted to banded tanks; however, they may be used on any single skinned tank or in any area that is protected by a bund.

**Tip:** Always fit a gate valve to isolate the flow between the tank and the gauge in case you ever have to remove this for maintenance.

PART NUMBER	DESCRIPTION
SG1550	(1370mm) 4ft 6" x 1/2" Sight Gauge UPVC
SG1551	(1520mm) 5ft x 1/2" Sight Gauge UPVC
SG1552	(1830mm) 6ft x 1/2" Sight Gauge ALU
SG1554	(2440mm) 8ft x 1/2" Sight Gauge ALU
SG1556	(3050mm) 10ft x 1/2" Sight Gauge ALU
SG1557	(1370mm) 4ft 6" x 3/4" Sight Gauge UPVC
SG1558	(1520mm) 5ft x 3/4" Sight Gauge UPVC
SG1559	(1830mm) 6ft x 3/4" Sight Gauge ALU
SG1561	(2440mm) 8ft x 3/4" Sight Gauge ALU
SG1562	(3050mm) 10ft x 3/4" Sight Gauge ALU
SG1564	(1370mm) 4ft 6" x 1" Sight Gauge UPVC
SG1565	(1520mm) 5ft x 1" Sight Gauge UPVC
SG1566	(1830mm) 6ft x 1" Sight Gauge ALU
SG1568	(2440mm) 8ft x 1" Sight Gauge ALU
SG1570	(3050mm) 10ft x 1" Sight Gauge ALU

Please Note: UPVC sight shield supplied as standard on tubes up 5ft - Aluminium is supplied on 6-10ft models for rigidity.

Additional	Aluminium shield instead of UPVC on 4'6" to 5' Sight Gauges
------------	---



## PUSH BUTTON SIGHT GAUGE SPARES

PART NUMBER	DESCRIPTION
SG1195/96	1/2" Push Button Sight Gauge Union c/w Nut
SG1200/02	3/4" Push Button Sight Gauge Union c/w Nut
SG1210-12	1" Push Button Sight Gauge Union c/w Nut
PB5290	Push Button Sight Gauge Valve + Nipple

Valve and Nipple for the Push Button Sight Gauge. Screws directly into the Union (Various sizes available - see separate item unions). Spring Loaded Push Button Valve automatically defaults to the closed position.

COM2024	(1370mm) Sight Shield - UPVC - Per 4.5 ft Cut Length
COM2035	(1520mm) Sight Shield - UPVC - Per 5 ft Cut Length
COM2030	(1370mm) Sight Shield - Aluminium - Per 4'6" Cut Length
COM2040	(1830mm) Sight Shield - Aluminium - Per 6' Cut Length

SG2170	Sight Shield Coupler
COM2180	Top Cap, Black
COM2110	Top Stand Off Clip c/w Screws
COM2080	PVC Sight Tubing 30m Coil - Priced per Meter
COM2080	PVC Sight Tubing 60m Coil - Priced per Meter
COM2080	PVC Sight Tubing Cut Lengths - Priced per Meter



# FUEL TANK LEVEL GAUGES

## PIUSI OCIO

The Piusi Ocio Fuel Tank Gauge is a continuous reading, hydrostatic digital tank level monitoring device designed primarily for commercial diesel fuel tanks.

PART NUMBER	DESCRIPTION
P8-F0075510D	Piusi Ocio Fuel Tank Level Gauge 230v
P8-F00755S10	Piusi Ocio Desk - PC Software for up to 1 Tank
P8-F00755S00	Piusi Ocio Desk - PC Software for up to 4 Tanks
P8-F00755S20	Piusi Ocio Desk - PC Software for up to 8 Tanks
M5066-N	Additional Tube for Ocio / Televar Per Meter



## WATTS TELEVAR GAUGES

The Televar gauge is extremely popular for commercial and domestic sites where reliability and accuracy is essential.

With versions available for vertical, or horizontal tanks, each displays the tanks contents as a percentage of the total capacity, and is suitable for tanks from 0.9 m up to 3.0 m in height.

PART NUMBER	DESCRIPTION
D2000	Watts Televar Hydrostatic Contents Gauge - Vertical Tank
D2100	Watts Televar Hydrostatic Contents Gauge - Horizontal Tank
D2000-AB	Watts Televar Hydrostatic Contents Gauge - AdBlue Compatible



## FLOAT GAUGES

Simple, float operated gauges suitable for both oil and diesel/fuel tanks. We can supply a 'Combivent' fitting that fits over a 2" vent pipe and provides a 1-1/2" female thread that allow the gauge to simply screw into the top of this (making fitting extremely easy).

PART NUMBER	DESCRIPTION
D1600	(1.22m) 4ft Float Gauge - Empty/Full Display
D1620	(2m) 6.5ft Universal Float Gauge - Displayed in cm
V6164	Combivent Tank Fitting Adaptor - 1-1/2" BSP Male Threaded



## DRUM GAUGES

Drum Gauges for 205 Litre Drums - PVC Sight Tube, PVC Shield, Various Taps Available.

PART NUMBER	DESCRIPTION
DG1910	Drum Gauge with 3/4" Plastic Tap
DG1911	Drum Gauge with 3/4" Steel Tap
DG1890	3/4" Metal Tap Only
DG1909	3/4" Self Closing Tap Only
DG1900	3/4" Plastic Tap Only



# PRESSURE & VACUUM GAUGES

PART NUMBER	DESCRIPTION
GV01125531	Vacuum Gauge - 1/4" BSP Bottom Connection - 0-1 Bar
GV01415511	Vacuum Gauge - 1/8" BSP Bottom Connection - 0-1 Bar
GV391704000	Pressure Gauge 1/8" BSP - Glycerine Filled - 0-100 PSI
GV391704006	Pressure Gauge 1/4" BSP - Glycerine Filled - 0-30 PSI

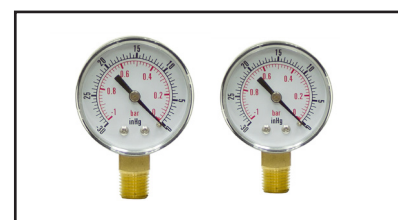

# INLINE FILTERS & REPLACEMENT ELEMENTS

## 1/4" ATKINSON FILTER

The Atkinson Inline Filter for heating oil tanks includes the same filter element as the Atkinson Tankmaster making it easy to order replacement filter elements and other spares for this filter.

1/4" to 10mm compression fitting and an aluminium steel filter bowl, it also includes the a nylon filter element.

PART NUMBER	DESCRIPTION
M5040-A	1/4" to 10mm Aluminium Inline Filter
M5040-A-V	1/4" Inline Filter with Compression Fittings & Isolation Valve
TM4660F	Replacement Filter Kit
TM4326-SS	Replacement Filter Bowl - Stainless Steel



## 1/4" & 1/2" FAG ALUMINIUM BOWL FILTER

General purpose 1/4" metal bowled filter for use with fluids not aggressive to the filter's component materials

PART NUMBER	DESCRIPTION
M5070	1/4" FAG All Aluminium Inline Filter
M5040-RF	Replacement 100 Micron S/S Filter Element
M5040-RPF	Optional 15 Micron Paper Filter Element
M5035	1/2" FAG All Aluminium Inline Filter



## 1/4" GIULIANI ANELLO PLASTIC BOWL FILTER

General purpose 1/4" plastic bowled filter with 15 micron paper element.

PART NUMBER	DESCRIPTION
M5074-P	1/4" Aluminium Head, Plastic Bowl Inline Filter c/w Paper Element
M5040-RF	Replacement 100 Micron S/S Filter Element
M5040-RPF	Optional 15 Micron Paper Filter Element
M-BRACKET-04-06	Support Bracket for 1/4" - 3/8" Filters



## 3/8" GIULIANI ANELLO ALUMINIUM BOWL FILTER

General purpose 3/8" metal bowled filter for use with fluids not aggressive to the filter's component materials.

PART NUMBER	DESCRIPTION
M5040-P	3/8" Aluminium Head, Plastic Bowl Inline Filter
M5040-RF	Replacement 100 Micron S/S Filter Element
M5040-RPF	Optional 15 Micron Paper Filter Element
M-BRACKET-04-06	Support Bracket for 1/4" - 3/8" Filters



## 3/8" ECONOMY ALUMINIUM BOWL FILTER

General purpose 3/8" plastic bowled filter for use with fluids not aggressive to the filter's component materials.

PART NUMBER	DESCRIPTION
M5040	3/8" Aluminium Head, Aluminium Bowl Inline Filter
M5040-RF	Replacement 100 Micron S/S Filter Element
M5040-RPF	Optional 15 Micron Paper Filter Element
M-BRACKET-04-06	Support Bracket for 1/4" - 3/8" Filters



# INLINE FILTERS & REPLACEMENT ELEMENTS

## 3/8" GIULIANI ANELLO WATER TRAP FILTER

This filter allows you to easily drain off any water collected from your heating oil, when you see any trapped water in the filter bowl simply open a valve to drain this off.

PART NUMBER	DESCRIPTION
GFH3578-W-3/8	3/8" Plastic Bowled Water Separator Filter
GFH3578-3/8-RF	Replacement 100 Micron S/S Filter Element
M503-BRACKET	Support Bracket for 3/8" - 1/2" Filters
GFH3578-3/8-GASKET	Replacement O-Ring Seal for Filter Bowl



## 1/2" GIULIANI ANELLO LOW PROFILE ALUMINIUM BOWL FILTER

General purpose 1/2" metal bowled filter for use with fluids not aggressive to the filter's component materials.

Low profile filter bowl for installations where room may be an issue

PART NUMBER	DESCRIPTION
M5035-A	1/2" Aluminium Head, Low Profile Metal Bowl Inline Filter
M5035-RF	Replacement 100 Micron S/S Filter Element
M5035-RPF	Optional 15 Micron Paper Filter Element
M503-BRACKET	Support Bracket for 3/8" - 1/2" Filters



## 1/2" GIULIANI ANELLO LOW PROFILE PLASTIC BOWL FILTER

General purpose 1/2" metal bowled filter for use with fluids not aggressive to the filter's component materials.

Low profile filter bowl for installations where room may be an issue

PART NUMBER	DESCRIPTION
M5035-P	1/2" Aluminium Head, Plastic Bowl Inline Filter
M5035-RF	Replacement 100 Micron S/S Filter Element
M5035-RPF	Optional 15 Micron Paper Filter Element
M503-BRACKET	Support Bracket for 3/8" - 1/2" Filters



## 3/4 & 1" GIULIANI ANELLO ALUMINIUM BOWL FILTER

General purpose 3/4" and 1" plastic bowled filter for use with fluids not aggressive to the filter's component materials.

PART NUMBER	DESCRIPTION
M5075	3/4" Aluminium Head, Metal Bowl Inline Filter
M5080	1" Aluminium Head, Plastic Bowl Inline Filter
M5080-RF	Replacement 100 Micron S/S Filter Element
M-BRACKET-12-16	Support Bracket for 3/4" - 1" Filters



# TANK ACCESSORIES - VENT & FILLER CAPS

## POLYPROPYLENE VENT CAPS

Push-fit green polypropylene cap that slips onto the top of 2" BSP male threaded vent pipes and then secured with two screws.

Screw in green polypropylene cap that screws into the of 2" BSP female thread vent pipes on storage tanks.

PART NUMBER	DESCRIPTION
V5090	Vent Cap <b>FOR 2" Male BSP Socket</b> , Green Polypropylene
V5095	Vent Cap <b>FOR 2" Female BSP Socket</b> , Green Polypropylene



## UNIVERSAL VENTATANK

A good quality universal vent cover for plastic or metal fuel storage tanks

Affixes into a cut hole in the tanks surface, and is secured by twisting down onto a t-bar which clamps to the underside - a flanged base then prevents any ingress of water into the tank.

Also features a coarse molded gauze which prevents the ingress of insects, blowing leaves and other debris.

PART NUMBER	DESCRIPTION
V5180	Universal Ventatank - upto 3", Green Polypropylene



## POLYPROPYLENE FILLER CAPS

2" BSP female threaded Fill Point Cap with chain, for all standard fuel storage tanks.

Also available without the attachment chain

PART NUMBER	DESCRIPTION
FC5080	2" BSP Green Polypropylene Filler Cap with Chain
FC5081	2" BSP Green Polypropylene Filler Cap less Chain



## ALUMINIUM FILLER CAP

Lugged Aluminium filler cap for heating oil or fuel tanks

2" BSP Female threaded with NBR Sealing Disc

PART NUMBER	DESCRIPTION
FC2000-AL	2" BSP Female Aluminium Filler Cap



## COMPLETE TANK INLET

This is suitable for use with all plastic tanks that can be accessed from the inside through a 'hatch'.

This requires a 2" hole to be cut in the top of the tank and the unit passed up through from the inside and the locking nut to be attached from the outside to hold this in place.

Comes complete with 'O' Ring; Locking Nut; Polypropylene Cap with Chain.

PART NUMBER	DESCRIPTION
PTF-3000	Complete Tank Inlet Point - 2" BSP Threaded



## SLUDGE VALVE

Fitted in the bottom of the rear of metal tanks (which are normally installed sloping backwards) to allow the escape of accumulated water and various other crud.

Note: Normally fitted to new metal tanks prior to installation.

PART NUMBER	DESCRIPTION
SV1760	3/4" Sludge Valve

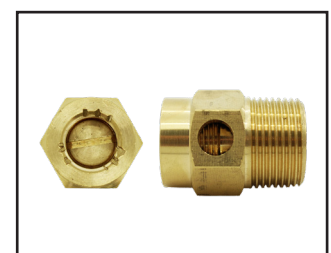

# TANK ACCESSORIES - TANK SECURITY

## LOCKING FILLER CAP

Locking cap for an oil storage tank filler point. The bottom threaded ring goes over the 2" threaded outlet on your tank and is then secured by the brass shear screw. The top cap then lines up with the elbow locking tab and is secured further by a padlock.

Strong aluminium construction cap with a hardened steel locking elbow and a brass shear screw.

PART NUMBER	DESCRIPTION
AFC-1000-L-R	2" BSP Locking Filler Cap



## LOCKING VENT CAP

Lock the vent cover permanently in position by inserting and fully tightening the grub screw followed by the Atkinson Shear Screw, which snaps off when tightened.

**Please Note:** This can only be fitted on tanks that have a 2" male fitting for the vent.

PART NUMBER	DESCRIPTION
LVC1000	Locking Vent Cap C/W Shear Screw
FC2000-LSS	Shear Screw Only



## LOCKING ANGLE FLOW VALVES

Unlike traditional gate valves and ball valves, the flow on this valve comes out at 90° rather than straight through.

These are 1" BSPF inlet and 1" BSPM outlet.

PART NUMBER	DESCRIPTION
GV3640	1" BSP Angle Flow Valve c/w Locking Bracket



## LOCKING GATE VALVE BRACKET

This fits a 1" Gate valve with 1" nipple attached - Please note: Price is for the bracket only.

PART NUMBER	DESCRIPTION
GFH3630	1" Locking Gate Valve Bracket



# TANK ACCESSORIES - PRESSURE REGULATING VALVES

## GOK FIXED PRESSURE REGULATING VALVE

GOK fixed pressure regulating valve, preset to 100mb outlet pressure.

Suitable for use with all appliances that require the pressure to be set at 100mb, e.g. vapour type appliances such as AGAs.

Comes complete with 10mm compression fittings to match your 10mm oil line.

PART NUMBER	DESCRIPTION
GV39300603	GOK Fixed pressure Regulating Valve - 100mb - 20l/hr - 0.5 to 6 Bar



## GOK ADJUSTABLE PRESSURE REGULATING VALVE

GOK adjustable pressure regulating valve, preset to 2.5 bar outlet pressure.

A suitable oil pressure regulator must be installed for the respective outlet pressure, if the operating pressure in the oil line exceeds the highest permitted inlet pressure of downstream fittings or consumer devices, e.g. oil heaters.

PART NUMBER	DESCRIPTION
GV3925-GOK	GOK 10mm Oil Pressure Regulator With Gauge - 0.2 - 5 Bar - 180l/hr





# TANK ACCESSORIES - WATER REMOVAL

If you have water in your heating oil tank this can cause several detrimental problems for your oil fired heating system including:

- Water can enter the heating system instead of the fuel and cause damage to the burner or boiler.
- Water can increase the growth of bacteria and as a result promote tank sludge.
- The presence of water will rapidly increase rusting of a metal tank and metal components in the heating system.
- Water can freeze in the tank which can then cause the fuel to degrade.
- Possibility of water freezing in the pipeline blocking flow to the heating system.

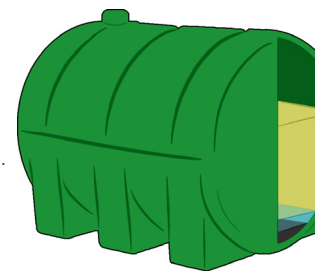

We now offer a complete solution to water removal from a heating oil storage tank.

**KOLOR KUT WATER FINDING PASTE** - This paste is designed to change colour when in contact with water. This is used on a dip stick that you dip into your tank to find out the level of water that is residing in the bottom.

Suitable only for use with Petrol, Diesel, Kerosene, Gas Oil, Heating Oil, Heavy Oil, and Lubricating Oil

PART NUMBER	DESCRIPTION
WFP-1000	Kolor Kut Water Finding Paste - 3oz Tube



**THE TANK SPONGE** - This is a polymer filled sock that can be placed into your tank on the end of a handy recovery string, this polymer will soak up the water only from all types of heating oil.

Leave in the tank for 24 hours, when the tank sponge is full it can be removed and replaced.

PART NUMBER	DESCRIPTION
WAS-10	Water Absorbant Tank Sponge - Up to 0.5L Capacity
WAS-15	Water Absorbant Tank Sponge - Up to 1L Capacity



**INLINE WATER TRAP FILTER** - An inline water separating filter with a clear bowl and a drain tap, to allow you to see and drain off any excess water in the system. 3/8" inline filter with a 100 micron stainless steel filter element. **See accessories on page 14.**

PART NUMBER	DESCRIPTION
GFH3578-W-3/8	3/8" Plastic Bowled Water Separator Filter



**AMAZON SUBMERSIBLE PUMP** - A 12v submersible pump easily connected to a standard garden hose and dropped into the tank to pump out the water from the bottom of your tank.

Leave in the tank for 24 hours, when the tank sponge is full it can be removed and replaced.

PART NUMBER	DESCRIPTION
P3900	Submersible Low Voltage Pump - 12v - 15mm OD Outlet



## Also available in kits:

### MINI KIT

**INCLUDES:**

Kolor Kut Water Finding Paste  
1L Tank Sponge

**PART NUMBER:** WRK-1000

### STANDARD KIT

**INCLUDES:**

Kolor Kut Water Finding Paste  
1L Tank Sponge  
Water Trap Filter

**PART NUMBER:** WRK-2000

### MAXI KIT

**INCLUDES:**

Kolor Kut Water Finding Paste  
1L Tank Sponge  
Water Trap Filter  
Submersible Pump

**PART NUMBER:** WRK-3000

# TANK ACCESSORIES - ANTI SIPHON VALVES

## GOK ANTI-SIPHON VALVE

Designed for use on oil tanks for domestic oil fired central heating systems, this valve will prevent the flow of fuel when there is no positive vacuum applied to the downstream side.

Adjustable between 0 and 4 metres negative head, this equates to 0 to -400mb

Brass Body with Nitrile Diaphragm

PART NUMBER	DESCRIPTION
GS2060	GOK Anti-Siphon Valve - 3/8"



## ATKINSON TANK TOP OFF TAKE VALVE

This innovative product has all the components required for drawing fuel oil from the top of the storage tank in one unit including and anti-siphon valve. **PLEASE NOTE** - Must be run with a deaerator or oil lifter (page 23-26)

More information and spare parts available on Page 7.

PART NUMBER	DESCRIPTION
TTV-01-C	Tank Top Off Take Valve - For Plastic Tanks
TTV-01	Tank Top Off Take Valve - For Steel Tanks



# VOLUMETRIC IN-LINE OIL METERS

## BRAUN HZ3 HEATING OIL METER

A high quality flowmeter for use with heating oils, where there is a relatively low flow rate, e.g. domestic properties, swimming pools, etc.

The HZ3 measures flow rates as low as 0.18 to 12 litres per hours using a non-resettable mechanical counter.

Comes complete with a pair of 1/4" BSPM x 10mm Compression Fittings, including free copper inserts.

PART NUMBER	DESCRIPTION
HZ3	Braun 0.18 - 12lph Heating Oil Flow Meter



## AQUA METRO HEATING OIL FLOW METER

Flowmeters for use with heating oils, the Aqua Metro range measures in increments of .01 litres and displays this on a non-resettable mechanical counter. For domestic and light industrial applications.

PART NUMBER	DESCRIPTION
F3794	Contoil VZO4 Flow Meter • 1-50lph • 1/8" BSP • 362 PSI • +60°C
F3794-P0.1	Contoil VZO4 Pulse Meter • 0.1L/pulse • 1/8" BSP • 362 PSI • +60°C
F3795	Contoil VZO8 Flow Meter • 4-135lph • 1/4" BSP • 362 PSI • +60°C
F3795-P.1	Contoil VZO8 Pulse Meter • 4-135lph • 1/4" BSP • 362 PSI • +60°C
F3790	Compression Fitting Kit for VZ04 - 1/8" BSPM -10mm (2 fittings)
F3791	Compression Fitting Kit for VZ08 - 1/4" BSPM -10mm (2 fittings)



These versions of the Aquametro oil meter range are designed for use in marine and industrial applications to measure fuel consumption of boilers, engines and generators.

**Please Note:** These mechanical fuel flow meters can be retrofitted to any existing boiler/burner systems, and are adaptable for installation indoors, outdoors, vertically, horizontally and diagonally.

PART NUMBER	DESCRIPTION
F3796	Contoil VZO15 Flow Meter • 10-400lph • 1/2" BSP • 232 PSI • +130°C
F3796-P.1	Contoil VZO15 Pulse Meter • 0.1L/pulse • 1/2" BSP • 232 PSI • +130°C
F3800	Contoil VZO20 Flow Meter • 30-1000lph • 3/4" BSP • 232 PSI • +130°C
F3801	Contoil VZO25 Flow Meter • 75-2000lph • 1" BSP • 232 PSI • +130°C
F3802	Contoil VZO40 Flow Meter • 225-6000lph • 1 1/2" BSP • 232 PSI • +130°C



# FREE FALL FIRE VALVES

The FEL Valves range of Free Fall Fire Valves are suitable for installation in either horizontal or vertical pipe work, and are designed to provide a positive, 100% shut off when used as a fuel isolating valve, or opening, when used as a fuel dump valve. A standard free fall valve assembly comprises of a valve, lever and weight, together with a fitting kit.



Various sizes available: 1/2", 3/4", 1", 1.5", and 2" BSP Tapered

PART NUMBER	DESCRIPTION
FV20-001	1/2" BSP Tapered (15mm) Free Fall Fire Valve Kit
FV20-003	3/4" BSP Tapered (20mm) Free Fall Fire Valve Kit
FV20-005	1" BSP Tapered (25mm) Free Fall Fire Valve Kit
FV20-009	1 1/2" Tapered BSP (40mm) Free Fall Fire Valve Kit
FV20-011	2" BSP Tapered (50mm) Free Fall Fire Valve Kit



Various sizes available: 1/2", 3/4", 1", 1.5", and 2" PN16 Flanged

PART NUMBER	DESCRIPTION
FV20-002	1/2" PN16 Flanged (15mm) Free Fall Fire Valve Kit
FV20-004	3/4" PN16 Flanged (20mm) Free Fall Fire Valve Kit
FV20-006	1" PN16 Flanged (25mm) Free Fall Fire Valve Kit
FV20-010	1 1/2" PN16 Flanged (40mm) Free Fall Fire Valve Kit
FV20-012	2" PN16 Flanged (50mm) Free Fall Fire Valve Kit



## FREE FALL FIRE VALVES - SPARES & ACCESSORIES

**FITTING KITS** - Each Free Fall Fire Valve purchased comes with a fitting kit, available as spares. Accessories are available to enhance the fire valve depending on the application, including; Manual and Electro-Manual Quick Release units, Electro-Magnetic Quik Release and Fusible Links.

PART NUMBER	DESCRIPTION
FV20-060	Small Kit for 15 - 50mm Valve Sizes
FV20-061	Medium Kit for 65 - 100mm Valve Sizes
FV20-062	Large Kit for 125 - 200mm Valve Sizes



### INDIVIDUAL KIT COMPONENTS

FV20-107	Caution Sign & Maintenance Card 150 x 100mm
FV20-100	Tension Spring for 15-40mm Valves
FV20-101	Tension Spring for 50-80mm Valves
FV20-080	316 Stainless Steel Cable 10m
FV20-081	316 Stainless Steel Cable 30m
FV20-080-G	Galvanised Steel Cable 7.5m
FV20-110	Cable Connectors
FV20-090	72°C Eutectic Soldered Fusible Link C/W 'S' Hooks
FV20-091	92°C Eutectic Soldered Fusible Link C/W 'S' Hooks
FV20-111	'S' Hook
FV20-070/M6	M6 Pulley Assembly - 40mm Diameter C/C Backplate
FV20-074/M6	M6 Brass Anchor C/W Backplate
FV20-102	Cable Turnbuckle
FV20-050/12	Lubricating Compound - Pack of 12

Valve mounted changeover switches provide position status via a robust, steel encased volt free changeover switch, rated to 230V 10 amps, allowing direct switching of pumps or relays upon valve actuation or 0.75 amp rated non-mercury normally open switches.

FV20-150	Valve Mounted Mercury Switch - Single Phase 10amp
FV20-151	Valve Mounted Mercury Switch - Three Phase 10amp

# FREE FALL FIRE VALVES - SPARES & ACCESSORIES

## MANUAL QUICK RELEASE

Designed for use with 'fusible link operated free fall fire valve' systems and provides manual release of fire valve systems

- Can be used with electro-mechanical fire valve systems
- 40mm red push button operation

PART NUMBER	DESCRIPTION
FV20-160	Manual Quick Release
FV20-161	Electro-Manual Quick Release

## ELECTROMAGNETIC MECHANISM

**E-Mag's** provide instant release of Free Fall Fire Valves when de-energised, they have a 2kVA power rating, 40Kg electromagnetic holding power as standard and a 'push to test' facility, ideal for remote valve closure.

The E-Mag is a standard electromagnet, which will de-magnetise on loss of power, the E-Mag 2 version has inbuilt auxiliary volt free changeover contacts, which signal valve status.

PART NUMBER	DESCRIPTION
FV20-162	24v DC Electro-Magnetic Valve Release Mechanism
FV20-163	110v AC Electro-Magnetic Valve Release Mechanism
FV20-164	230v AC Electro-Magnetic Valve Release Mechanism
FV20-165	24v DC E-Mag 2 C/W Volt Free Contacts
FV20-166	110v AC E-Mag 2 C/W Volt Free Contacts
FV20-167	230v AC E-Mag 2 C/W Volt Free Contacts

## OTHER FIRE VALVES

### LEVER FIRE VALVE

Good quality Lever Fire Valve Kits, available in 3/8", 1/2", and 3/4" BSP Female threaded, each kit includes:

- 1 Lever Fire Valve Body
- 1 Spring
- 9m of Stainless Steel Wire
- 1 Anchor
- Pulleys
- 6 Ferrules
- 1 Eutectic Soldered Link

PART NUMBER	DESCRIPTION
FV10-010	Lever Operated Fire Valve & Kit - 3/8"
FV10-011	Lever Operated Fire Valve & Kit - 1/2"
FV10-012	Lever Operated Fire Valve & Kit - 3/4"

### FUSIBLE HEAD FIRE VALVE

Also known as a "Handwheel Fire Valve" - This is a top quality all-brass construction Fusible Head Fire Valve, which will isolate the downstream supply of oil should the handwheel be turned to the off position or should the heat from a fire melt the eutectic soldered link on the handwheel.

This 3/8" BSP Female threaded inlet / outlet valve comes complete with 10mm copper compression fittings.

PART NUMBER	DESCRIPTION
FV2010	Fusible Head Fire Valve - 3/8" to 10mm Compression Fittings

### SOLENOID & MOTORISED OIL CONTROL VALVES

Solenoid valves from Banico are suitable for water, oil, air, inert gases and other fluids non-corrosive for copper alloys, with viscosity up to 2 Engler.

PART NUMBER	DESCRIPTION
FV20-635	1/4" Solenoid Valve 240v
FV20-640	3/8" Solenoid Valve 240v
FV20-641	1/2" Solenoid Valve 240v
FV20-642	3/4" Solenoid Valve 240v
FV20-643	1" Solenoid Valve 240v

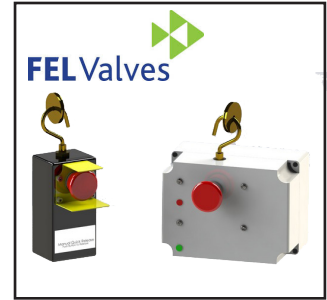

# OTHER FIRE VALVES

## REPLACEMENT COILS

PART NUMBER	DESCRIPTION
FV20-650	240v Coil for Solenoid Valve
FV20-665	110v Coil for Solenoid Valve
FV20-655	24v AC Coil for Solenoid Valve



## ELECTRO THERMAL LINK

Electro thermal fusible link for use in boiler houses - For installing in a position where a fire hazard may occur, e.g. Above a burner, an air heater or boiler.

PART NUMBER	DESCRIPTION
FV20-170	Electro Thermal Link 72°C
FV20-155	Wall Mounted Manual Change Over 'Knock Off' Switch - 240v



# THERMOSTATIC CAPILLARY FIRE VALVES



## FUELSTOP THERMOSTATIC FIRE VALVE

### WHAT IS IT?

A capillary fire valve is a legal requirement for fuel burners. They provide automatic shut off in the event of an overheat within a fuel burning appliance and fail safe shut off in the event of capillary or sensor failure.

### HOW DOES IT WORK?

If the temperature in the fuel burning appliance exceeds the temperature range appropriate for that valve, the liquid inside the capillary expands and causes the valve to shut down, cutting off the supply of fuel to the appliance immediately.



## 3 KEY PARTS OF THE FUELSTOP

- 1** The **VALVE BODY** - which is installed outside the external wall of the property.
- 2** The **CAPILLARY** - this runs from the valve body to inside the property, inside the boiler housing next to the oil burner.
- 3** The **VALVE SENSOR** - detects the expansion from the capillary and will shut off the valve.

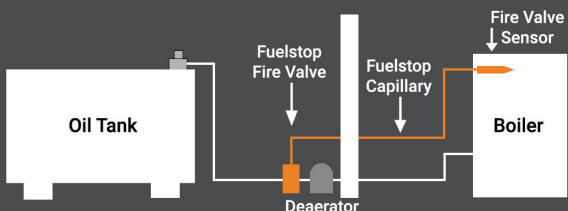

## TECHNICAL INFORMATION

CONNECTION SIZES	HEIGHT (to top flat of dome)	WIDTH (without fittings)	DEPTH (diameter of dome)
3/8" (10mm) connection Max Fuel Flow Rate 180ltr/hr at 1.2m head	72mm	49mm	47mm
1/2" (15mm) connection Max Fuel Flow Rate 360ltr/hr at 1.2m head	74mm	57.4mm	47mm

The high flow rate characteristics make the Fuelstop TFVs ideal for suction lift applications. 3/8" Valves are rated at 180 litres/hr and 1/2" valves are rated at 360 litres/hr, both measured at a 1.2m head.

Due to the speciality liquid filled capillaries the valves are far more stable in cold weather conditions and are more resilient to vibration.

# THERMOSTATIC CAPILLARY FIRE VALVES

## 72°C FIRE VALVES - 3/8" CONNECTION

PART NUMBER	DESCRIPTION
FVC-7201510	3/8" (10mm Compression) 72°C Thermostatic Fire Valve - <b>1.5m</b>
FVC-720310	3/8" (10mm Compression) 72°C Thermostatic Fire Valve - <b>3m</b>
FVC-720610	3/8" (10mm Compression) 72°C Thermostatic Fire Valve - <b>6m</b>
FVC-721010	3/8" (10mm Compression) 72°C Thermostatic Fire Valve - <b>10m</b>
FVC-721210	3/8" (10mm Compression) 72°C Thermostatic Fire Valve - <b>12m</b>
FVC-721510	3/8" (10mm Compression) 72°C Thermostatic Fire Valve - <b>15m</b>
FVC-722010	3/8" (10mm Compression) 72°C Thermostatic Fire Valve - <b>20m</b>
FVC-722510	3/8" (10mm Compression) 72°C Thermostatic Fire Valve - <b>25m</b>
FVC-723510	3/8" (10mm Compression) 72°C Thermostatic Fire Valve - <b>35m</b>

## 72°C FIRE VALVES - 1/2" CONNECTION

FVC-7201512	1/2" BSP 72°C Thermostatic Fire Valve - <b>1.5m</b>
FVC-720312	1/2" BSP 72°C Thermostatic Fire Valve - <b>3m</b>
FVC-720612	1/2" BSP 72°C Thermostatic Fire Valve - <b>6m</b>
FVC-721012	1/2" BSP 72°C Thermostatic Fire Valve - <b>10m</b>
FVC-721212	1/2" BSP 72°C Thermostatic Fire Valve - <b>12m</b>
FVC-721512	1/2" BSP 72°C Thermostatic Fire Valve - <b>15m</b>
FVC-722012	1/2" BSP 72°C Thermostatic Fire Valve - <b>20m</b>
FVC-722512	1/2" BSP 72°C Thermostatic Fire Valve - <b>25m</b>
FVC-723512	1/2" BSP 72°C Thermostatic Fire Valve - <b>35m</b>

## 95°C FIRE VALVES - 3/8" CONNECTION

FVC-950210	3/8" (10mm Compression) 95°C Thermostatic Fire Valve - <b>2m</b>
FVC-950310	3/8" (10mm Compression) 95°C Thermostatic Fire Valve - <b>3m</b>
FVC-950610	3/8" (10mm Compression) 95°C Thermostatic Fire Valve - <b>6m</b>
FVC-951010	3/8" (10mm Compression) 95°C Thermostatic Fire Valve - <b>10m</b>
FVC-951210	3/8" (10mm Compression) 95°C Thermostatic Fire Valve - <b>12m</b>
FVC-951510	3/8" (10mm Compression) 95°C Thermostatic Fire Valve - <b>15m</b>
FVC-952010	3/8" (10mm Compression) 95°C Thermostatic Fire Valve - <b>20m</b>
FVC-952510	3/8" (10mm Compression) 95°C Thermostatic Fire Valve - <b>25m</b>
FVC-953510	3/8" (10mm Compression) 95°C Thermostatic Fire Valve - <b>35m</b>

## 95°C FIRE VALVES - 1/2" CONNECTION

FVC-9501512	1/2" BSP 95°C Thermostatic Fire Valve - <b>2m</b>
FVC-950312	1/2" BSP 95°C Thermostatic Fire Valve - <b>3m</b>
FVC-950612	1/2" BSP 95°C Thermostatic Fire Valve - <b>6m</b>
FVC-951012	1/2" BSP 95°C Thermostatic Fire Valve - <b>10m</b>
FVC-951212	1/2" BSP 95°C Thermostatic Fire Valve - <b>12m</b>
FVC-951512	1/2" BSP 95°C Thermostatic Fire Valve - <b>15m</b>
FVC-952012	1/2" BSP 95°C Thermostatic Fire Valve - <b>20m</b>
FVC-952512	1/2" BSP 95°C Thermostatic Fire Valve - <b>25m</b>
FVC-953512	1/2" BSP 95°C Thermostatic Fire Valve - <b>35m</b>

## FIRE VALVE SUPPORT BRACKETS

A simple, yet robust and secure means of mounting any Fuelstop Capillary Fire Valve Body to any surface.

PART NUMBER	DESCRIPTION
FV30-032	Thermostatic Fire Valve Phial Clip
FV30-033	Thermostatic Fire Valve Support Bracket

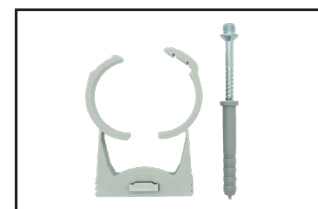

# DEAREATORS - TIGERLOOP

A Tigerloop makes a one-pipe system possible for all types of oil heating installations helping to ensure environmental safety, cost effectiveness and reliability.

- **Effective deaeration** - In an oil heating system using a Tigerloop, all oil passes through the automatic oil de-aerator, which effectively removes all gas/air bubbles from the system. This eliminates oil pump and nozzle problems associated with gas/air in the oil.
- Only the amount of oil that is actually burned will be drawn from the tank., which means lower flow of oil and less sludge in the system, reducing risk of nozzle and filter clogging.
- Eliminates the need for a return line to the tank which lowers risk of dirt/sludge being released from the tank and no risk for return line leakage.
- The working temperature of the oil pump is used for pre-heating the oil to at least room temperature. This eliminates problems associated with cold oil and allows cleaner combustion.

## Installation Example - External

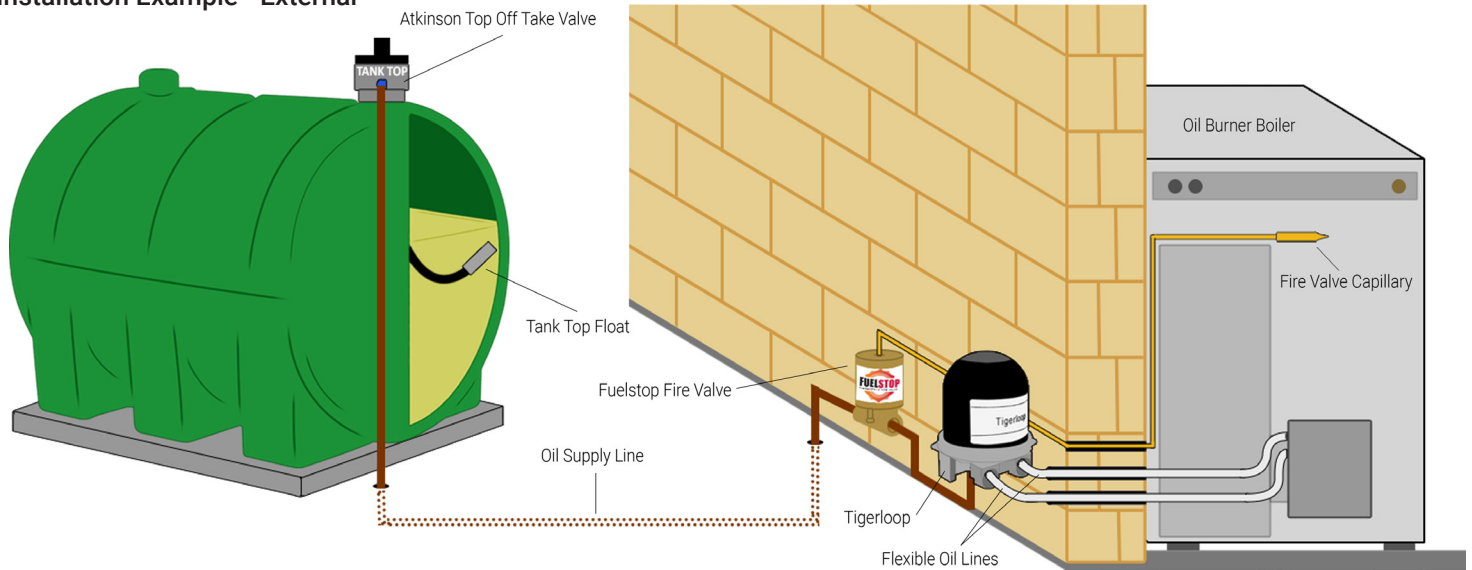

## TIGERLOOP ORIGINAL

**For external mounting only.** This device is NOT permitted for indoor installation as it vents contaminated air into its surrounding environment, this could create explosion or health hazards in confined spaces and therefore must be fitted on the outside wall of any premises.

- **Max Nozzle Capacity** - 110lph
- **Max Return Oil Pumped into Tigerloop** - 120lph
- **Max Flow** - 230lph
- **Max Deaerating Capacity** - 8lph
- **Max Operating Temperature** - 60°C
- **Operating Pressure** +0.5 / -0.6 Bar

PART NUMBER	DESCRIPTION
TL6000	Tigerloop Original - External Fitting Only
TL6050	Tigerloop Fitting Kit - External Fitting - Includes x2 Braided Lines & Fittings



## TIGERLOOP BIO

A de-aerator with all the benefits of a Tigerloop Original that can be fitted internally. With the addition of a simple to fit 10mm vent pipe the removed air can be vented safely to the outside, ensuring only pure oil is passed through to the burner.

- **Max Nozzle Capacity** - 110lph
- **Max Return Oil Pumped into Tigerloop** - 120lph
- **Max Flow** - 230lph
- **Max Deaerating Capacity** - 8lph
- **Max Operating Temperature** - 60°C
- **Operating Pressure** +0.5 / -0.6 Bar

PART NUMBER	DESCRIPTION
TL7000	Tigerloop Bio - Internal and External Fitting
TL6051	Tigerloop Fitting Kit - Internal Fitting - Includes x2 Braided Lines & Fittings



# DEAREATORS - TIGERLOOP

## TIGERLOOP COMBI 3

For external mounting only, similar to the basic Tigerloop Original, but featuring a disposable 15 Micron Particulate filter. The Combi Bio 3 design also comes with a control valve and an optional integrated vacuum gauge for full control and easy troubleshooting.

- **Max Nozzle Capacity** - 110lph
- **Max Return Oil Pumped into Tigerloop** - 120lph
- **Max Flow** - 230lph
- **Max Deaerating Capacity** - 8lph
- **Max Operating Temperature** - 60°C
- **Operating Pressure** +0.5 / -0.6 Bar

PART NUMBER	DESCRIPTION
TL61101-C	Tigerloop Combi 3 - External Fitting C/W Control Valve
TL61101-CG	Tigerloop Combi 3 - External Fitting C/W Control Valve & Vacuum Gauge
TL6052	Fitting Kit for Tigerloop Combi



## TIGERLOOP BIO COMBI

For internal and external mounting, the Tigerloop Combi Bio is developed for Biofuel (bio-liquids) produced to EN 14213, heating oil and C2 kerosene. The installation is done with fewer connections simplifying work and reducing the risk of leakage. Includes a disposable 15 micron particulate filter.

- **Max Nozzle Capacity** - 110lph
- **Max Return Oil Pumped into Tigerloop** - 120lph
- **Max Flow** - 230lph
- **Max Deaerating Capacity** - 8lph
- **Max Operating Temperature** - 60°C
- **Operating Pressure** +0.5 / -0.6 Bar

PART NUMBER	DESCRIPTION
TL7000-C	Tigerloop Bio Combi - External & Internal Fitting C/W Control Valve
TL7000-CG	Tigerloop Bio Combi - C/W Control Valve & Vacuum Gauge
TL7000-C-F	Tigerloop Combi Bio Filter Insert (Nickle Mesh)



## TIGERLOOP PLUS

For external mounting, the flagship of the Tigerloop range, the Plus features a disposable 15 Micron Particulate Filter, and an outlet pressure gauge. Developed to meet the highest demands for cleaner, air-free oil.

- **Max Nozzle Capacity** - 110lph
- **Max Return Oil Pumped into Tigerloop** - 120lph
- **Max Flow** - 230lph
- **Max Deaerating Capacity** - 8lph
- **Max Operating Temperature** - 60°C
- **Operating Pressure** +0.5 / -0.6 Bar

PART NUMBER	DESCRIPTION
TL61101-P	Tigerloop Plus - External & Fitting C/W Control Valve & Vacuum Gauge



## TIGERLOOP TWIN

Internal and external mounting versions, the Tigerloop Twin is comprised of two units of standard Tigerloop conveniently connected in parallel and combined with a separate oil filter. The oil filter (tank connection) can be installed on either side of the unit. The Tigerloop Twin is for larger capacity burners up to 2000 kW.

- **Max Nozzle Capacity** - 200lph
- **Filtration Grade** - 100 - 150 Micron
- **Max Flow** - 400lph
- **Max Deaerating Capacity** - 16lph
- **Max Operating Temperature** - 60°C
- **Operating Pressure** +0.5 / -0.6 Bar

PART NUMBER	DESCRIPTION
TL61101-T	Tigerloop Twin - External Fitting
TL7000-T	Tigerloop Twin - Internal Fitting



## TIGERLOOP SPARES & ACCESSORIES

PART NUMBER	DESCRIPTION
TL61101-F	1 Replacement Filter for Tigerloop Combi - 50-70 Micron Filter
PTF1050	Replacement O-Ring for Filter Bowl - Tigerloop Combi
TL43006	Replacement Mesh Filter for Tigerloop Combi Bio
TL61101-PF	Replacement Filter for Tigerloop Plus
TL6050	Tigerloop Fitting Kit - For External Fitting Only
TL6051	Tigerloop Fitting Kit - For Internal Fitting Only
TL61101-B	Spare Tigerloop Wall Bracket



# DEAREATORS - GOK

## GOK GS PRO-FI 3

**For internal mounting only.** The GS Pro-Fi 3 combines a de-aeration device with filter and shut off valve in one quick to install module, also suitable for bio-fuels. This product is not self-priming and a priming pump is required for initial installation.

- **Max Oil in Pump Cycle** - 80lph
- **Max Oil at Burner Jet** - 120lph
- **Pipework Connections** - 3/8" BSP
- **Max Deaerating Capacity** - 5lph
- **Max Operating Temperature** - 80°C
- **Max Operating Pressure** - 16 Bar

PART NUMBER	DESCRIPTION
GS2000	GOK Internal Fitting Deaerator
GS2000-KIT	GOK Deaerator Fitting Kit
GS2000-FILT	Replacement Filter 50-70 Micron for GS2000
GS2050	GOK Priming Pump for GS2000

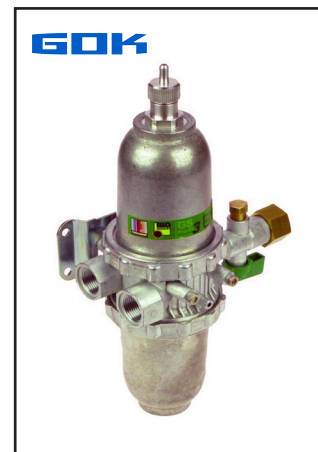

## OIL LINE ACCESSORIES

### INLINE ISOLATION VALVES

All come complete with 10mm compression outlet and there is a choice of inlet. The inlet can be 1/4" BSP Male; 1/4" BSP Female; or 10mm Compression fitting as required (Note: 1/4" BSP thread is virtually identical to 8mm thread).

PART NUMBER	DESCRIPTION
SG2095	Inline Isolation Valve - 1/4" BSP Male to 10mm Compression Fitting
SG2095-F	Inline Isolation Valve - 1/4" BSP Female to 10mm Compression Fitting
SG2095-10-10	Inline Isolation Valve - 10mm x 10mm Compression Fitting
TL6005	1000mm x 1/4" BSPM to 1/4" BSPF Flexible Oil Line
TL6006	1063mm x 1/4" BSPM Swivel Cone Elbow to 1/4" BSPM Steel Braided Hose



## OIL LIFTERS

Oil lifters are used to ensure a head of oil above the burner to provide a gravity feed supply. Inbuilt pump and micro switches call for oil when the reservoir gets low and switches itself off when full.

Maximum lift is 8 metres and the maximum distance to the oil tanks is 100 metres.

Oil lifters can also be fitted with a leak detection tray, this will isolate the oil pump from emptying and refilling the reservoir if it detects a leak.

- **Max Lift Height** - 8m
- **Max Horizontal Run** - 100m
- **Outlet Flowrate** - 8lph (at 8m vertical & 25m horizontal)
- **Power Supply** - 230v
- **Overflow Outlet** - 1/2" BSP
- **Outlet Flowrate** - 15lph (at 5m vertical & 25m horizontal)
- **Inlet/Outlet Connection** - 3/8" BSP
- **Power Consumption** - 50w



### 3L OIL LIFTER

PART NUMBER	DESCRIPTION
OL-3L-CW-DT	OUF-88 - 3L Oil Lifter with Leak Detector & Drip Tray
OL-3L-KIT	OUF-88 - 3L Oil Lifter with Leak Detector, Drip Tray and Weatherproof Box
OL-3L-DT	Drip Tray <b>ONLY</b> for 3L Oil Lifter
OL-3L-DT-WP-BOX	Weatherproof Box <b>ONLY</b> for 3L Oil Lifter fitted with Drip Tray (600mm x 400mm x 230mm)

### 12L OIL LIFTER

PART NUMBER	DESCRIPTION
OL-12L-CW-DT	OUF-88 MAXI - 12L Oil Lifter with Leak Detector & Drip Tray
OL-12L-KIT	OUF-88 MAXI - 12L Oil Lifter with Leak Detector, Drip Tray and Weatherproof Box
OL-12L-DT	Drip Tray <b>ONLY</b> for 12L Oil Lifter
OL-12L-DT-WP-BOX	Weatherproof Box <b>ONLY</b> for 12L Oil Lifter fitted with Drip Tray (800mm x 600mm x 300mm)

# OIL LIFTERS

## OIL LIFTER SPARES

PART NUMBER	DESCRIPTION
OL-PCB	PCB Circuit Board for OUF-88 & MAXI (3L & 12L) Versions
OL-DT-PCB	OUF-88 Leak Detector PCB Board
OL-FLOAT	Stainless Steel Float for OUF-88 & MAXI Versions
OL-PROBE-ASSY	Probe and Stainless Steel Float Assemble for OUF-88 & MAXI Versions
OL-PUMP	Pump and Motor for OUF-88 Oil Lifter - Includes; Pump, Motor, Pipe, Clips

## OIL TRANSFER PRESSURE PUMPS

These GP Oil Transfer Pumps are designed for oil installations using dead leg pipework with no return. Controlled by an internal pressure switch only operating when fuel is required by the appliance(s), ideal for multiple appliance systems even when appliances are at different heights.

- **Flow Rate** - 30lph
- **Connection Size** - 3/8" BSP Female
- **Power Supply** - 230v
- **Dimensions** - 240 x 330 x 205 (mm)
- **Motor Protection** - IP-20
- **Max Pressure** - 3.5 Bar



PART NUMBER	DESCRIPTION
OL-GP30	GP30 Oil Transfer Pressure Pump - Multiple Appliances (30lph)
OL-GP30-TWIN	GP30 Twin Oil Transfer Pressure Pump - Multiple Appliances (30lph)

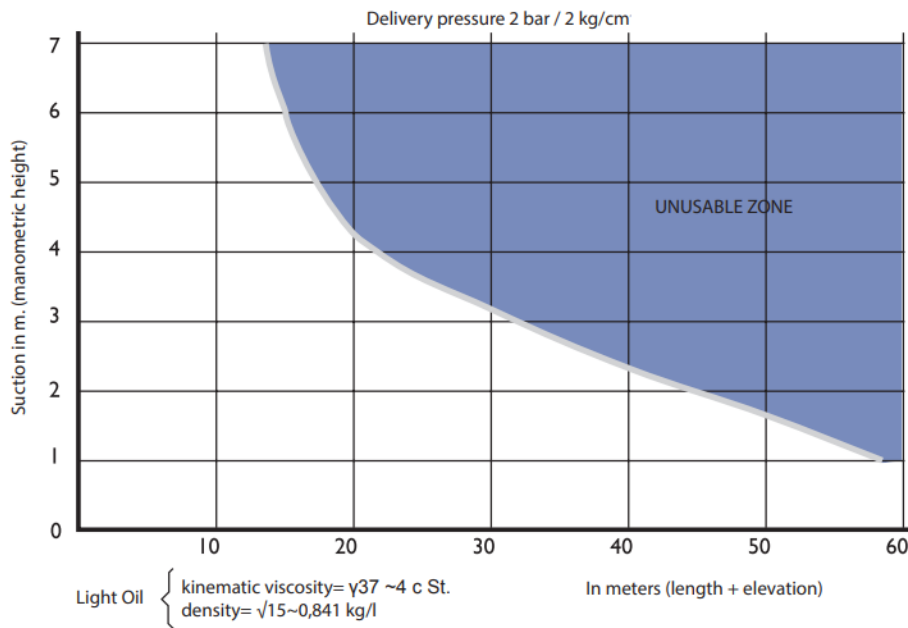

## COMPRESSION FITTINGS

PART NUMBER	DESCRIPTION
GFH3541	10mm - 8mm Straight Compression
MF101010-CCC-B	10mm T (10x10x10) Compression
GFH3530	10mm - 10mm Straight Compression
MF1004-CM-90-B	10mm - 1/4" 90° Compression
MF1008-CM-B	10mm - 1/2" Straight Compression
MF1006-CM-B	10mm - 3/8" Straight Compression
GFH3540	3/8" - 15mm Straight Compression
MFM1010-MM-90B	10mm - 10mm 90° Compression
MF06-PLUG-B	3/8" BSPT Brass Blanking Plug
GV3770	2" BSP F/F Brass Gate Valve w/ Painted Steel On/Off Wheel
GV3640	1" BSP F/F Brass Gate Valve c/w Locking Bracket

# DRAUGHT STABILISERS/REGULATORS

## TIGEX 25 DRAUGHT STABILISERS FOR MOUNTING ON BRACKET PLATE

In almost all heating installations, the draught created in the chimney is greater than that required by the boiler. The draught can vary from 0 up to 100 Pa during the heating season. The variations depend on differences in temperature as well as wind conditions. The consequences of an unstable draught are lower efficiency, incomplete combustion and breakdowns. A stable draught is important irrespective of whether you use oil, gas or other solid fuels.



➤ **Output** - Up to 25kw   ➤ **Max Chimney Height** - Up to 8m   ➤ **Max Chimney Diameter/Area** - Ø130 mm/169 cm<sup>2</sup>

PART NUMBER	DESCRIPTION
TL60300E	Tigex 25 without adaptor
TL60390-130E	Tigex 25 With Adapter Round Pipe Ø130
TL6150E	Tigex 150 without adaptor
TL61590-130-1	Adapter for round pipe Ø130 to Tigex 150
TL61590-150-1	Adapter for round pipe Ø150 to Tigex 150
TL61800E	Tigex 180 without adaptor
TL61890-200-1	Adapter for round pipe Ø200 to Tigex 180

PART NUMBER	DESCRIPTION
TL60362	Tigex 25 adapter for insulated T with OD 133mm (SUITS TL60300E)
TL60363	Tigex 25 adapter for insulated T with OD 153mm (SUITS TL60300E)
TL60364	Tigex 25 adapter for insulated T with OD 183mm (SUITS TL60300E)

# REFUELLING & LIQUID TRANSFER

---



We stock all the components required to enable you to complete your fueling setup, whether its just a portable refueling setup, or drum mounted dispenser to a complete pumped refueling station. Our products include ranges from the worlds leading manufacturers in their field.

## FUEL DISPENSING NOZZLES - MANUAL

**MANUAL NOZZLES** - Manual dispensing nozzles are recognised for their efficiency, low flow rates, simplicity to use and their low price. They can be used on many fuel transfer systems, mainly those that are gravity fed. See our range of manual nozzles with various connection sizes and applications.

### 3/4" ADBLUE NOZZLE

Suitable for use with AdBlue. Plastic Polypropylene bodied manual nozzle with stainless steel spout. 3/4" Hosetail connection and viton seals to protect against aggressive fluids.

PART NUMBER	DESCRIPTION
TN6000-AB	Manual 3/4" AdBlue Nozzle



### 1" BSPF SELF 3000 NOZZLE

Suitable for use with both petroleum and diesel and comes complete with a swivel as standard. Available with either 1" female swivel inlet and 1" OD spout; or 3/4" female swivel inlet and 1" OD spout. Viton Seals.

PART NUMBER	DESCRIPTION
P8-F0065000A	Self 3000 1" BSPF Swivel, 1" OD Spout
P8-00065001A	Self 3000 3/4" BSPF Swivel, 1" OD Spout



### 1" BSPF SELF 2000 NOZZLE

Suitable for use with both petroleum and diesel and comes complete with a swivel as standard. Available with either 1" female swivel inlet and 1" OD spout; or 3/4" female swivel inlet and 1" OD spout. NBR Seals.

PART NUMBER	DESCRIPTION
TN6000	Self 2000 1" BSPF Swivel, 1" OD Spout
TN6000-1	Self 2000 3/4" BSPF Swivel, 1" OD Spout



## FUEL DISPENSING NOZZLES - AUTOMATIC

**AUTOMATIC NOZZLES** - Automatic dispensing nozzles are equipped with a device that automatically shuts off the flow when the tank is full. These are mainly used on pumped fuel transfer systems. Various flow rates available to suit most applications on or off a forecourt.

### 3/4" NPT GPI PETROL NOZZLE

Great Plains Industries automatic nozzle. Comes with straight spout and 3/4 inch NPT inlet for unleaded fuel. Approved for use with GPI pumps and kits.

PART NUMBER	DESCRIPTION
GP110121-8	GPI 3/4" NPT Petrol Automatic Nozzle



### 3/4" BSPF ADBLUE NOZZLE

100% compatible with Adblue. Stainless steel body and spout, with a max flow rate of 40lpm. Also can be used with solvents and corrosive mediums.

PART NUMBER	DESCRIPTION
M3700-ABSS	AdBlue 3/4" BSPF Stainless Steel Nozzle



### 3/4" BSPF HUSKY X-MATE NOZZLE

Automatic diesel nozzle with a maximum flow rate of 60lpm and 3/4" BSPF inlet. Reinforced spout bushing & sensing port behind spout to prevent wear.

PART NUMBER	DESCRIPTION
M3701	Husky X-Mate 3/4" Diesel Nozzle



# FUEL DISPENSING NOZZLES - AUTOMATIC

## 1" BSPF TDW-11A NOZZLE

Suitable for diesel. 1" BSP Female Swivel inlet. 1" OD Spout. Comes complete with Swivel as standard (various material resistant to oil/diesel). Cannot be used on a gravity feed system, requires a pumped system.

PART NUMBER	DESCRIPTION
M3700-SS	1" BSPF Swivel, 1" OD Spout Automatic Diesel Nozzle - 60lpm



## 1" BSPF HUSKY 1GS NOZZLE

Suitable for diesel. 1" BSP Female Swivel inlet. 28.5mm OD Spout. Sensing port behind spout to prevent click offs. Anti-air lock feature for easy priming of pump.

PART NUMBER	DESCRIPTION
M3700	Husky 1" BSPF Swivel, 1" OD Spout Automatic Diesel Nozzle - 100lpm



## 1" BSPF HUSKY VIII HIGH FLOW NOZZLE

Suitable for diesel. 1" BSPF, maximum flow rate 250lpm. Durable die cast aluminium body with full scuff guard Spout bushing & sensing port behind spout.

PART NUMBER	DESCRIPTION
M3711	Husky 1" BSPF, 35mm OD Spout Automatic HS Diesel Nozzle - 250lpm



## 1" BSPF ZVA SLIMLINE NOZZLE

Suitable for diesel and petrol. Due to their slimline spout, these diesel and petrol nozzles are ideal for both domestic and commercial vehicle refuelling at a maximum flow rate of 80lpm

PART NUMBER	DESCRIPTION
M3702-4.1H	ZVA 1" BSPF, 24.5mm OD Spout Automatic Fuel Nozzle - 80lpm



## 1" BSPF ZVA 25 HIGH FLOW NOZZLE

Suitable for diesel and petrol and biodiesel upto B5. 1" BSPF, Supplied with 1" F BSP Swivel, ATEX, EN13012 and TUV-SUD Approved.

PART NUMBER	DESCRIPTION
M3702-25.4.1	ZVA 1" BSPF, High Flow Automatic Fuel Nozzle - 140lpm



## 1.5" BSPF ZVA 32 SUPER HIGH FLOW NOZZLE

Suitable for diesel and petrol. 1.5" BSPF, supplied with 1 1/2" BSPF swivel. Max flow rate: 200lpm. 2 position stay open latch, ATEX, EN13012 and TUV-SUD approved.

PART NUMBER	DESCRIPTION
M3702-32	ZVA 1.5" BSPF, Super High Flow Automatic Fuel Nozzle - 200lpm



## 1.5" BSPF HUSKY 1690 HIGH FLOW NOZZLE

Suitable for diesel. 1.5" BSPF, specially designed for heavy duty applications including rail, tanker or filling fuel storage tanks.

PART NUMBER	DESCRIPTION
M3715	Husky 1.5" BSPF, 35mm OD Spout Heavy Duty Nozzle - 375lpm



# FUEL DISPENSING NOZZLES - AUTOMATIC

## 1" BSPF ZVA SLIMLINE NOZZLE

Suitable for diesel and petrol. Due to their slimline spout, these diesel and petrol nozzles are ideal for both domestic and commercial vehicle refuelling at a maximum flow rate of 80lpm

PART NUMBER	DESCRIPTION
M3702-4.1H	ZVA 1" BSPF, 24.5mm OD Spout Automatic Fuel Nozzle - 80lpm



## 1" BSPF ZVA 25 HIGH FLOW NOZZLE

Suitable for diesel and petrol and biodiesel upto B5. 1" BSPF, Supplied with 1" F BSP Swivel, ATEX, EN13012 and TUV-SUD Approved.

PART NUMBER	DESCRIPTION
M3702-25.4.1	ZVA 1" BSPF, High Flow Automatic Fuel Nozzle - 140lpm



## 1.5" BSPF ZVA 32 SUPER HIGH FLOW NOZZLE

Suitable for diesel and petrol. 1.5" BSPF, supplied with 1 1/2" BSPF swivel. Max flow rate: 200lpm. 2 position stay open latch, ATEX, EN13012 and TUV-SUD approved.

PART NUMBER	DESCRIPTION
M3702-32	ZVA 1.5" BSPF, Super High Flow Automatic Fuel Nozzle - 200lpm



## 1" BSPF ZVA SLIMLINE PETROL NOZZLE

Suitable for gasoline (also with ethanol content up to E 85), diesel, fuel oil, biodiesel. Not suitable for viscous oils Due to their slimline spout, these diesel and petrol nozzles are ideal for both domestic and commercial vehicle refuelling at a maximum flow rate of 80lpm.

PART NUMBER	DESCRIPTION
ZVA4.1R	GREEN, Unleaded petrol nozzle with green cover - 1" BSPF / 80lpm

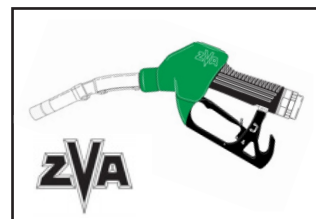

## 1" BSPM ZVA ADBLUE NOZZLE - COMMERCIAL

Suitable for diesel and petrol and biodiesel upto B5. 1" BSPF, Supplied with 1" F BSP Swivel, ATEX, EN13012 and TUV-SUD Approved.

PART NUMBER	DESCRIPTION
M3702-25.4.1	ZVA 1" BSPF, High Flow Automatic Fuel Nozzle - 140lpm

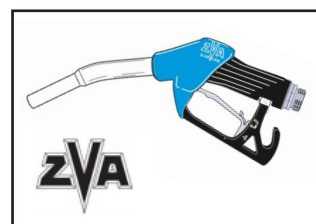

## 1" BSPM ZVA ADBLUE NOZZLE - FOR CARS

Automatic nozzle for Light Vehicle AdBlue® urea solution. 1" BSP male Swivel with integrated Volume Flow Switch. Max. flowrate 10 l/min., recommended flow rate at service stations 4-5 l/min.

PART NUMBER	DESCRIPTION
M3702-32	ZVA 1.5" BSPF, Super High Flow Automatic Fuel Nozzle - 200lpm



# FUEL DISPENSING NOZZLES - ACCESSORIES

## 1" BREAKAWAY STAINLESS STEEL COUPLING

This breakaway swivel joint, made from stainless steel, is suitable for use with adblue. This has 3/4" Inlet connects to gun, 1" outlet connects to hose. Reusable.

PART NUMBER	DESCRIPTION
M3700-ABSS-BR1BSP	Nozzle Holster for a Various Range of Nozzles



## BREAKAWAY CONNECTORS

PART NUMBER	DESCRIPTION
GFH3900	Non Reuseable, 1" Breakaway Connector
GFH3890	Non Reuseable, 3/4" Breakaway Connector
M3700-ABSS-BR3/4BSP	Reuseable, 3/4" S/S Breakaway Swivel for AdBlue



## HOSE FITTINGS & ACCESSORIES

### SWIVEL TAILS

PART NUMBER	DESCRIPTION
GFH2400	1" BSPM Swivel Hose Tail for 25mm Hose Barb - Tapered
M3700-ABSS-SW07TAIL	3/4" BSPM Stainless Steel (316) Swivel Hose Tail for 19mm Hose Barb

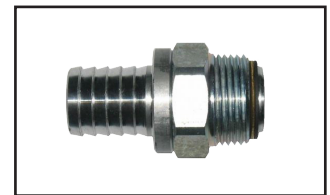

### SWIVEL JOINTS

These are often fitted between the end of the hose and the nozzle so that it can be twisted around to the correct orientation.

PART NUMBER	DESCRIPTION
GFH3475-34-34	3/4" BSPM X 3/4" BSPF Swivel Joint
GFH3475-34	3/4" BSPM x 1" BSPF Swivel Joint
GFH3475	1" BSPM x 1" BSPF Swivel Joint
GFH3475-SS	1" BSPM x 1" BSPF Stainless Steel (316) Swivel Joint



### FIXED HOSE TAILS

PART NUMBER	DESCRIPTION
GFH3390	3/4" BSPM Fixed Hose Tail to suit 25mm ID Hose
GFH3400	3/4" BSPM Fixed Hose Tail to suit 19mm ID Hose
GFH3400-SS	3/4" BSPM Stainless Steel Fixed Hose Tail to suit 19mm ID Hose



GFH3440	1" BSPM Fixed Hose Tail to suit 25mm ID Hose
GFH3445	1" BSPT Fixed Hose Tail for 1" ID Hose - Aluminium
GFH3380	1" BSPM Fixed Hose Tail to suit 19mm ID Hose
GFH3380T	1" BSPTM Fixed Hose Tail to suit 19mm ID hose
GFH3407	2" BSPT * 2" Hosetail BZP & Colour Pass MH-32/32
MF1616-FHT-B	1" BSPF to 25mm Hosetail Brass

### SWIVEL ELBOWS

PART NUMBER	DESCRIPTION
GFH3475-90	1" BSP M/F Swivel Elbow MD-45A 90 Degree
GFH3476-90	3/4" BSPM - 1" BSP 90 Degree Swivel
GFH3525	1" M & 1" F BSP Elbow (G2-1-BK) BS1256 BMFL-16
GFH3525-B	1" BSP M * 1" BSP F Equal Elbow 90Deg MFL-16 10547





# HOSE FITTINGS & ACCESSORIES

## Y STRAINER

Brass body with 500 micron stainless strainer element. 1" size available

PART NUMBER	DESCRIPTION
M5056	1" Brass Y Strainer - F/F



## NON-RETURN VALVES

Non-Return Valves are fitted in the end of the fuel line to prevent fuel running back out of the hose line. These are essential for use where the pump requires an initial prime to get it working and you wish to maintain the prime thereafter.

All threads are BSP and the flow direction is either Female In and Female Out or Male In and Female Out, Sizes available from 3/8" to 2" with Female to Female ports and 1/2" to 2" with Male to Female ports.



PART NUMBER	DESCRIPTION
GV3930	3/8" Non-Return Valve
GV3932	1/2" BSP F/F Non-Return Valve
GV3934-FO	3/4" Strainer Only
GV3935	1" BSP F/F Non-Return Valve
GV3910-F	1" Strainer Only
GV3975	2" BSPM Parallel x 2" Male Taper
GV3934-SS	NON RETURN VALVE 3/4" STAINLESS STEEL

## CAM & GROOVE COUPLINGS

Camlocks (also known as cam and groove couplings) enable you to quickly connect and disconnect your hose and pipework. They are designed to carry gases, powders, liquids, vapours and granules. Camlock couplings operate by opening the coupler arms and inserting the adaptor into the coupler. The arms are folded down into position to complete a tight join.

Available in both 1 inch and 2 inch. Made from high quality pressure cast aluminium.

- ▶ Types **A** and **D** are **BSP Female Threaded** Connections
- ▶ Types **B** and **F** are **BSP Male Threaded** Connections
- ▶ Types **C** and **E** have **Hose Tail** Connections

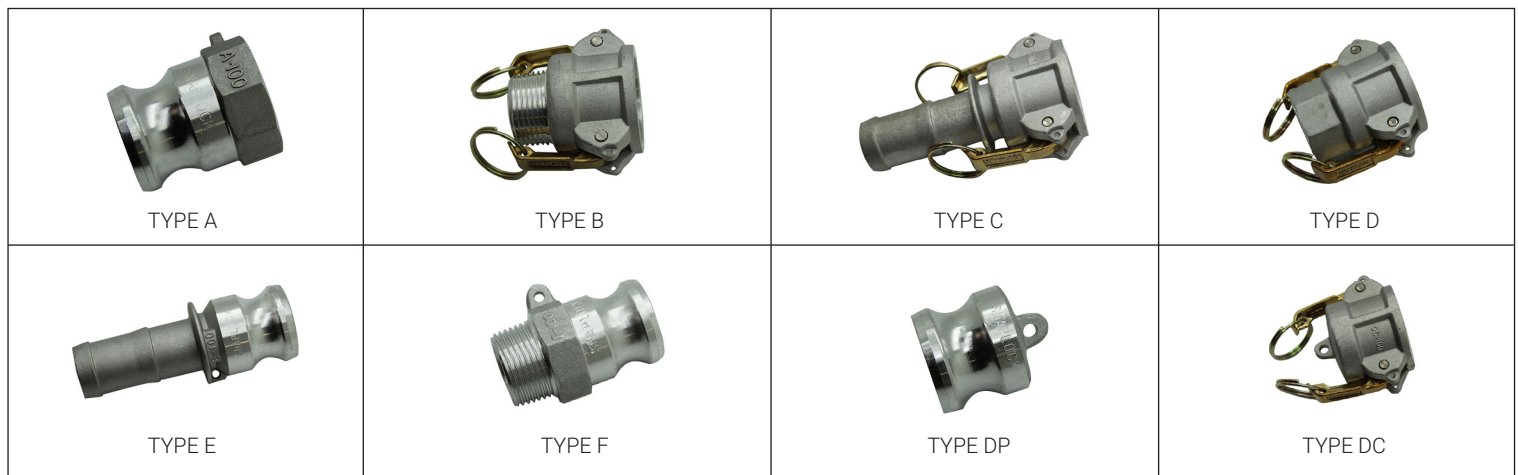

## 3/4" CAM & GROOVE COUPLINGS

Used for IBC bottom outlet connection - made from polypropylene.

PART NUMBER	DESCRIPTION
GFH4-A075PP	3/4" Polypropylene Cam & Groove Coupling - Type A
GFH4-C075PP	3/4" Polypropylene Cam & Groove Coupling - Type C

# HOSE FITTINGS & ACCESSORIES

## 1" CAM & GROOVE COUPLINGS

PART NUMBER	DESCRIPTION
GFH4-A100AL	1" Aluminium Cam & Groove Coupling - Type A
GFH4-B100AL	1" Aluminium Cam & Groove Coupling - Type B
GFH4-C100AL	1" Aluminium Cam & Groove Coupling - Type C
GFH4-D100AL	1" Aluminium Cam & Groove Coupling - Type D
GFH4-E100AL	1" Aluminium Cam & Groove Coupling - Type E
GFH4-F100AL	1" Aluminium Cam & Groove Coupling - Type F
GFH4-DC100AL	1" Aluminium Cam & Groove Coupling - Type DC
GFH4-DP100AL	1" Aluminium Cam & Groove Coupling - Type DP

## 2" CAM & GROOVE COUPLINGS

PART NUMBER	DESCRIPTION
GFH4-A200AL	2" Aluminium Cam & Groove Coupling - Type A
GFH4-B200AL	2" Aluminium Cam & Groove Coupling - Type B
GFH4-C200AL	2" Aluminium Cam & Groove Coupling - Type C
GFH4-D200AL	2" Aluminium Cam & Groove Coupling - Type D
GFH4-E200AL	2" Aluminium Cam & Groove Coupling - Type E
GFH4-F200AL	2" Aluminium Cam & Groove Coupling - Type F
GFH4-DC200AL	2" Aluminium Cam & Groove Coupling - Type DC
GFH4-DP200AL	2" Aluminium Cam & Groove Coupling - Type DP

## TIMERS, SWITCHES & CONNECTORS

PART NUMBER	DESCRIPTION
PP25	Tri Pole Rocker Switch
PP01	Touch Timer Switch, IP66, 220-230v, Adjustable from 1 Sec to 2 Hrs
PP08	Rocker Switch, IP55, Single Pole (Legrand)



## DIESEL DISPENSING HOSE KITS

<p><b>HOSE KIT WITH STRAIGHT CONNECTION</b></p>	<p><b>HOSE KIT WITH 90° GATE VALVE CONNECTION</b></p>	<p><b>HOSE KIT WITH 90° DROP ELBOW CONNECTION</b></p>
---	---	---

### DISPENSING KIT WITH STRAIGHT CONNECTION

Suitable for where the hose does not kink downwards immediately. Comes complete with 1" BSPM tank connector; 1" gate valve; length of 1" cloth reinforced diesel delivery hose; and a 1" manual nozzle.

PART NUMBER	DESCRIPTION
GFH3603	Straight Connection Diesel Dispensing Kit - 3m Hose
GFH3603-4	Straight Connection Diesel Dispensing Kit - 4m Hose
GFH3603-5	Straight Connection Diesel Dispensing Kit - 5m Hose
GFH3603-6	Straight Connection Diesel Dispensing Kit - 6m Hose

# DIESEL DISPENSING HOSE KITS

PART NUMBER	DESCRIPTION
GFH3603-7	Straight Connection Diesel Dispensing Kit - 7m Hose
GFH3603-8	Straight Connection Diesel Dispensing Kit - 8m Hose
GFH3603-9	Straight Connection Diesel Dispensing Kit - 9m Hose
GFH3603-10	Straight Connection Diesel Dispensing Kit - 10m Hose

## DISPENSING KIT WITH 90° GATE VALVE CONNECTION

Ideal for use where the hose drops immediately it comes out of the tank. Comes complete with 1" BSPM tank connector; 1" 90° gate valve (with handwheel facing forward); length of 1" cloth reinforced diesel delivery hose; and a 1" manual nozzle.

PART NUMBER	DESCRIPTION
GFH3650	90° Gate Valve Connection Diesel Dispensing Kit - 3m Hose
GFH3650-4	90° Gate Valve Connection Diesel Dispensing Kit - 4m Hose
GFH3650-5	90° Gate Valve Connection Diesel Dispensing Kit - 5m Hose
GFH3650-6	90° Gate Valve Connection Diesel Dispensing Kit - 6m Hose
GFH3650-7	90° Gate Valve Connection Diesel Dispensing Kit - 7m Hose
GFH3650-8	90° Gate Valve Connection Diesel Dispensing Kit - 8m Hose
GFH3650-9	90° Gate Valve Connection Diesel Dispensing Kit - 9m Hose
GFH3650-10	90° Gate Valve Connection Diesel Dispensing Kit - 10m Hose

## DISPENSING KIT WITH 90° DROP ELBOW CONNECTION

Ideal for use where the hose drops immediately it comes out of the tank. Comes complete with 1" BSPM tank connector; 1" gate valve; 1" 90° Drop Elbow; length of 1" cloth reinforced diesel delivery hose; and a 1" manual nozzle.

PART NUMBER	DESCRIPTION
GFH3655	90° Drop Elbow Connection Diesel Dispensing Kit - 3m Hose
GFH3655-4	90° Drop Elbow Connection Diesel Dispensing Kit - 4m Hose
GFH3655-5	90° Drop Elbow Connection Diesel Dispensing Kit - 5m Hose
GFH3655-6	90° Drop Elbow Connection Diesel Dispensing Kit - 6m Hose
GFH3655-7	90° Drop Elbow Connection Diesel Dispensing Kit - 7m Hose
GFH3655-8	90° Drop Elbow Connection Diesel Dispensing Kit - 8m Hose
GFH3655-9	90° Drop Elbow Connection Diesel Dispensing Kit - 9m Hose
GFH3655-10	Elbow Connection Diesel Dispensing Kit - 10m Hose

GFH3600	Economy Hose Kit with Gate Valve, 3m Hose & Nozzle
GFH3565	Hose Only, Per Metre

## ADBLUE IBC GRAVITY HOSE KIT

This IBC gravity feed kit is perfect accessory pumping AdBlue from your IBC. This IBC gravity hose kit is supplied in a range of hose lengths and is complete with a Manual Nozzle, Cam Fittings and an Adaptor for connecting to an IBC outlet ball valve.

- ▶ 3m, 4m and 5m hose lengths available
- ▶ Suitable for – AdBlue
- ▶ 3/4" manual nozzle with S/S spout
- ▶ Cam fittings and and adaptor or IBC connection



PART NUMBER	DESCRIPTION
GFH3000-IBC-AB	IBC Gravity Feed Hose Kit - 3m
GFH4000-IBC-AB	IBC Gravity Feed Hose Kit - 4m
GFH5000-IBC-AB	IBC Gravity Feed Hose Kit - 5m

# FUEL DISPENSING HOSE

## PVC NITRILE CLOTH REINFORCED HOSE 3/4" & 1"

An alternative to rubber hose, this reinforced PVC nitrile diesel fuel hose is a strong, effective and affordable alternative for conveying diesel oil through gravity feed lines. It is a hardwearing product that offers excellent oil, fuel and abrasion resistance to ensure longevity. **Available in 3/4" or 1" c/w Aluminium BSP Male Tails.**

- ▶ **Outer Diameter for 3/4" - 1 1/4"**      ▶ **Working Pressure for 3/4" - 75 PS.I**      ▶ **Burst Pressure - 300 PS.I**
- ▶ **Outer Diameter for 1" - 1 3/8"**      ▶ **Working Pressure for 1" - 60 PS.I**      ▶ **Burst Pressure - 240 PS.I**



PART NUMBER	DESCRIPTION
P7501.6	1.6m x 3/4" (19mm ID) Hose c/w Crimped Aluminium BSP Male Tails
P7502	2m x 3/4" (19mm ID) Hose c/w Crimped Aluminium BSP Male Tails
P7503	3m x 3/4" (19mm ID) Hose c/w Crimped Aluminium BSP Male Tails
P7504	4m x 3/4" (19mm ID) Hose c/w Crimped Aluminium BSP Male Tails
P7506	6m x 3/4" (19mm ID) Hose c/w Crimped Aluminium BSP Male Tails
P7508	8m x 3/4" (19mm ID) Hose c/w Crimped Aluminium BSP Male Tails
P7510	10m x 3/4" (19mm ID) Hose c/w Crimped Aluminium BSP Male Tails
GFH3550	3/4" Hose Only - Per Meter

P4001.6	1.6m x 1" (25mm ID) Hose c/w Crimped Aluminium BSP Male Tails
P4002	2m x 1" (25mm ID) Hose c/w Crimped Aluminium BSP Male Tails
P4003	3m x 1" (25mm ID) Hose c/w Crimped Aluminium BSP Male Tails
P4004	4m x 1" (25mm ID) Hose c/w Crimped Aluminium BSP Male Tails
P4006	6m x 1" (25mm ID) Hose c/w Crimped Aluminium BSP Male Tails
P4008	8m x 1" (25mm ID) Hose c/w Crimped Aluminium BSP Male Tails
P4010	10m x 1" (25mm ID) Hose c/w Crimped Aluminium BSP Male Tails
GFH3565	1" Hose Only - Per Meter

## NBR/PU/PVC STEEL REINFORCED HOSE 3/4" & 1"

Two-layer hose in thermoplastic PVC, PU, Nitrile Rubber compound with embedded galvanised steel spiral with polyester yarn reinforcement for suction and delivery of oils, blue diesel, diesel, bio diesel. **Available in 3/4" or 1" c/w Aluminium BSP Male Tails.**

- ▶ **Outer Diameter for 3/4" - 28mm**      ▶ **Working Pressure for 3/4" - 16 Bar**      ▶ **Burst Pressure - 48 Bar**
- ▶ **Outer Diameter for 1" - 35.5mm**      ▶ **Working Pressure for 1" - 16 Bar**      ▶ **Burst Pressure - 48 Bar**



PART NUMBER	DESCRIPTION
P7501.6-V	1.6m x 3/4" (19mm ID) Steel Reinforced Hose c/w Crimped Aluminium BSP Male Tails
P7502-V	2m x 3/4" (19mm ID) Steel Reinforced Hose c/w Crimped Aluminium BSP Male Tails
P7503-V	3m x 3/4" (19mm ID) Steel Reinforced Hose c/w Crimped Aluminium BSP Male Tails
P7504-V	4m x 3/4" (19mm ID) Steel Reinforced Hose c/w Crimped Aluminium BSP Male Tails
P7506-V	6m x 3/4" (19mm ID) Steel Reinforced Hose c/w Crimped Aluminium BSP Male Tails
P7508-V	8m x 3/4" (19mm ID) Steel Reinforced Hose c/w Crimped Aluminium BSP Male Tails
P7510-V	10m x 3/4" (19mm ID) Steel Reinforced Hose c/w Crimped Aluminium BSP Male Tails
GFH3550-V	GFH3550-V

P4001.6-V	1.6m x 1" (25mm ID) Steel Reinforced Hose c/w Crimped Aluminium BSP Male Tails
P4002-V	2m x 1" (25mm ID) Steel Reinforced Hose c/w Crimped Aluminium BSP Male Tails
P4003-V	3m x 1" (25mm ID) Steel Reinforced Hose c/w Crimped Aluminium BSP Male Tails
P4004-V	4m x 1" (25mm ID) Steel Reinforced Hose c/w Crimped Aluminium BSP Male Tails

# FUEL DISPENSING HOSE

PART NUMBER	DESCRIPTION
P4006-V	6m x 1" (25mm ID) Steel Reinforced Hose c/w Crimped Aluminium BSP Male Tails
P4008-V	8m x 1" (25mm ID) Steel Reinforced Hose c/w Crimped Aluminium BSP Male Tails
P40010-V	10m x 1" (25mm ID) Steel Reinforced Hose c/w Crimped Aluminium BSP Male Tails
GFH3565-V	1" Hose Only - Per Meter

## ADBLUE COMPATIBLE HOSE 3/4"

3/4" diameter soft PVC hose with Polyurethane underlayer with polyester yarn reinforcement and PU adhesive middle layer, for pressurized transfer oil, diesel oil, blue diesel and urea.

**Outer Diameter for 3/4"** - 26mm

**Working Pressure for 3/4"** - 15 Bar

**Burst Pressure** - 45 Bar



PART NUMBER	DESCRIPTION
GFH3550-POL	3/4" AdBlue Delivery Hose - Per Meter
GFH3550-AB	3/4" AdBlue Polipo Hose Suction Hose - Per Meter
GFH3550-PVC	3/4" AdBlue Blue PVC Hose - Per Meter

## GPI STATIC BONDED HOSE

Static wire prevents static electricity buildup for safe operation. Durable grounded hose with spring support to avoid kinking. For use with AC or DC electric pumps.

**Hose Type** - Anti-Static Bonded

**Connection** - 3/4 in. NPT x 3/4 in. Zinc Hose Fitting



PART NUMBER	DESCRIPTION
GP110187-502	10ft (3m) 3/4" GPI Static Bonded Hose c/w 3/4" NPT Tails
GP110187-501	12ft (3.6m) 3/4" GPI Static Bonded Hose c/w 3/4" NPT Tails

# FUEL HOSE REELS



Fuel hose reels are often used when a tank installation has a long length of delivery hose attached, installing a hose reel creates a simple, convenient storage solution for this. Also, when the tank is situated a distance away from the dispensing point is another reason to install a hose reel, to reduce the risk of the hose being left or dragging along the floor when refuelling is complete. All of our hose reels are 'spring rewind', this means the hose automatically retracts after use so there is no need to manually reel the hose back in.

## SPRING REWIND HOSE REELS

Available to suit hose lengths up to 40 metres. SAV versions are Stainless Steel models or PAV for Painted Mild Steel models. See table below for models and maximum capacities.

**Tip 1:** Use Stainless Steel where the Hose Reel is to be stored externally/used for Adblue and use Painted Mild Steel where the Hose Reel is going to be stored internally.

**Tip 2:** If you are likely to leave some of the hose on the reel when using this then choose a steel reinforced hose so that it cannot collapse on the reel and restrict the flow. Remember that the longer the length of hose the slower the flow of fluid in any case.

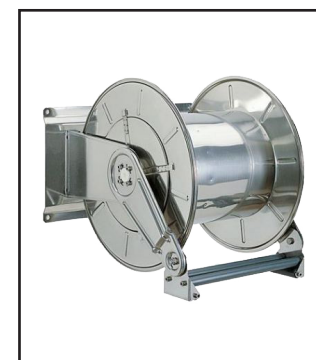

## STAINLESS STEEL & PAINTED MILD STEEL HOSE REELS

PART NUMBER	CAPACITY 1" HOSE	CAPACITY 3/4" HOSE
SAV1200 / PAV1200	8m	13m
SAV1300 / PAV1300	15m	18m
SAV3501 / PAV3501	13m	20m
SAV6001 / PAV6001	30m	40m

# FUEL HOSE REELS

## STAINLESS STEEL & PAINTED MILD STEEL HOSE REELS

PART NUMBER	DESCRIPTION
GFH-SAV1200	1" BSP In, 3/4" BSP Out Stainless Steel Spring Rewind Hose Reel - 8m 1" Hose / 13m 3/4" Hose
GFH-SAV1300	1" BSP In, 3/4" BSP Out Stainless Steel Spring Rewind Hose Reel - 15m 1" Hose / 18m 3/4" Hose
GFH-SAV3501	1" BSP In, 3/4" BSP Out Stainless Steel Spring Rewind Hose Reel - 13m 1" Hose / 20m 3/4" Hose
GFH-SAV6001	1" BSP In, 3/4" BSP Out Stainless Steel Spring Rewind Hose Reel - 30m 1" Hose / 40m 3/4" Hose
ADD	Adblue Convertible for Stainless Steel Reels
GFH-SAV-ABSEAL	Adblue Conversion Inlet Seal Kit Only For Stainless Steel Hose Reels

GFH-PAV1200	1" BSP In, 3/4" BSP Out Painted Mild Steel Spring Rewind Hose Reel - 8m 1" Hose / 13m 3/4" Hose
GFH-PAV1300	1" BSP In, 3/4" BSP Out Painted Mild Steel Spring Rewind Hose Reel - 15m 1" Hose / 18m 3/4" Hose
GFH-PAV3501	1" BSP In, 3/4" BSP Out Painted Mild Steel Spring Rewind Hose Reel - 13m 1" Hose / 20m 3/4" Hose
GFH-PAV6001	1" BSP In, 3/4" BSP Out Painted Mild Steel Spring Rewind Hose Reel - 30m 1" Hose / 40m 3/4" Hose
GFH-PAV1200-AD	1" BSP In, 3/4" BSP Out Painted Mild Steel Spring Rewind Hose Reel - <b>FOR ADBLUE</b>

## SWIVELLING WALL BRACKETS

Swivel Wall Bracket, available in Stainless Steel and Painted Mild Steel for use with Spring Rewind Hose Reels. See table below to match your bracket to your hose reel.

PART NUMBER	USE WITH SPRING REWIND HOSE REEL
SAV-BRKT20 / PAV-BRKT20	SAV1200 / PAV1200
SAV-BRKT22 / PAV-BRKT22	SAV1300 / PAV1300
SAV-BRKT30 / PAV-BRKT30	SAV3501 / PAV3501

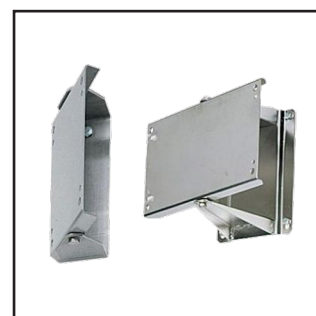

PART NUMBER	DESCRIPTION
ALL BRACKETS	Swivel Brackets for all Stainless Steel & Painted Mild Steel Hose Reels

**PLEASE NOTE: Hose is NOT Supplied with any reel above, please see pages 35 - 36 for Hose**

## HOSE BUMPERS & SPARES

Hose bumpers are fitted to the hose to prevent the nozzle being pulled back into the reel during rewind. These are available for both 3/4" or 1" hose.

PART NUMBER	DESCRIPTION
GFH-HB4940	Hose Bumper for 1" ID Hose
GFH-HB4941	Hose Bumper for 3/4" ID Hose



GFH-PAV-RS	Spring for Ratchet - Kit 12
GFH-PAV1300-SPRING	Main Rewind Spring for Hose Reel 1300
GFH-PAV1200-SPRING	Main Reqind Spring for Hose Reel 1200
GFH-PAV-KIT-93	Ratchet Arm & Spring
GFH-SAV-ABSEAL	Viton / Viton Inlet Seal for S/S Hose Reels - Kit 20 New

# FLUID FLOW METERS

We stock a great range of flow meters suitable for a wide variety of uses; our selection includes both mechanical and digital flow meters able to measure oil, diesel, fuel, water or heating oil. Fuel flow meters are essential in the management and monitoring of fuel quantities as they are dispensed. All featured flow meters provide high quality, smooth performance coupled with highly accurate dispensing. These products are designed to meet the high demands needed for commercial and agricultural use.

## FMT MECHANICAL OVER GEAR METER

Oval gear mechanical flow meter for various inline installations. Suitable for use with Diesel and Lubricants.

- ▶ **Batch Counter** - 3 Digit Ressetable, Calibrated 100ml
- ▶ **Connections** - 1" BSP Female Inlet, 1" BSP Female Outlet
- ▶ **Cummulative Counter** - Six digits, non-resettable lpm
- ▶ **Flow Rate** - 2-100 lpm (accuracy deteriorates outside this range)
- ▶ **Max Working Temperature** - 40°C
- ▶ **Ambient Working Temperature** - +10°C - +50°C
- ▶ **Accuracy** - +/- 1%



PART NUMBER	DESCRIPTION
P-23-192	1" BSP Oval Gear Flow Meter 2 - 100lpm

## FMT ELECTRONIC TURBINE METER

Electronic turbine flow meter for various inline installations. Suitable for use with Diesel and Lubricants.

- ▶ **Batch Counter** - 5 Digit Counter, Ressetable to Zero
- ▶ **Connections** - 1" BSP Female Inlet, 1" BSP Female Outlet
- ▶ **Nominal Pressure** - 3.5 Bar / 50 PSI
- ▶ **Flow Rate** - 15-100 lpm (accuracy deteriorates outside this range)
- ▶ **Max Working Temperature** - 40°C
- ▶ **Ambient Working Temperature** - +10°C - +50°C
- ▶ **Accuracy** - +/- 1%



PART NUMBER	DESCRIPTION
P-23-295	1" BSP Electronic Turbine Flow Meter 15 - 100lpm

## PIUSI K24 ADBLUE METER

Digital Turbine Meter, compact easy readable display. Display can be rotated in 4 different positions.

- ▶ **Counter** - 5 Digit Partial and 6 Digit Totaliser
- ▶ **Connections** - 1" M BSP Inlet/Outlet c/w Socket
- ▶ **Accuracy** - +/- 1%
- ▶ **Display** - LCD electronic display (2 x AAA batteries)
- ▶ **Flow Rate** - 6-100ltrs Per Min
- ▶ **Pressure** - 10 Bar / 145 PSI
- ▶ **Max Working Temperature** - -10°C / +50°C
- ▶ **Fluid Viscosity** - 2.5 - 3.5 CST



PART NUMBER	DESCRIPTION
P8-F0040710A	1" BSP Male Piusi K24 AdBlue Flow Meter 6-100ltrs Per Min

## GPI M30-L8B MECHANICAL FUEL METER

This quick-fit modular fuel meter is easy to install, easy to use, and easy to maintain. It is designed for the field measurement of thin viscosity petroleum fuel only and intended for use with pump systems in the 114 L/m flow range. Using mechanical gears, this meter translates flow data from a nutating disk into calibrated units which are indicated on the face of the meter. The M30 is equipped with both BSPP and Flange connections which allows it to be installed on all threaded pump outlets or modular GPI products.

- ▶ **Meter Type** - Nutating Disc
- ▶ **Flow Range** - 19-114lpm
- ▶ **Max Working Pressure** - 50 PSI
- ▶ **Max Batch Total** - 999.9
- ▶ **Max Cumulative Total** - 999,999.9
- ▶ **Inlet/Outlet Threads** - 1" BSPP



PART NUMBER	DESCRIPTION
GP165100-06	1" BSPP GPI M30-L8B Mechanical Fuel Flow Meter - Accuracy +/- 2%

MAIN DISTRIBUTER OF

# GPI FLOMEC

FLOWMETERS

**Great Plains Industries** are one of the leading manufacturers of fluid flow meters, flow sensors, flow monitors and flow control equipment. GPI have become the first choice supplier for fuel meters, water meters, chemical meters and general purpose flow measurement.

As a UK GPI supplier we have an extensive range of digital turbine flow meters, suitable for low to medium viscosity fluids. These come with a choice of construction materials and end fittings. Most GPI digital turbine meters are ATEX certified for hazardous areas and are available in a range of materials including: Aluminium, Stainless Steel, Brass, Nylon, PVC and PVDF.

## 01 ECONOMY FUEL & WATER METERS

These 01 Meters are basic economy models. The 01A for petrol, diesel and kerosene, and the 01N for water and light chemicals. The battery powered electronic displays on both models are calibrated to read litres and gallons.

- Accurate, reliable and lightweight meter with rugged aluminium housing and sealed electronic circuitry
- Powered by two AAA batteries that are easy to replace
- Factory calibrated for petroleum fuel with a choice of gallon and litre measurement
- Works well on any pump or gravity feed system with at least 3-30 GPM (10-100lpm) flow range
- Applications: Fuel, Diesel, Kerosene
- Available size: 1" BSPF

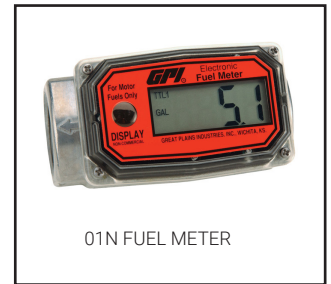

01N FUEL METER

PART NUMBER	DESCRIPTION
GP113255-12	01A52LM 1" BSP Aluminium Flow Meter, 10-100lpm - Accuracy +/- 2.5%

- Simple, small and sturdy Electronic Digital Water Meter with rugged nylon housing
- Mount on the end of a hose or a pipe, in-line
- Complete meter, including turbine assembly, microprocessor and LCD readout.
- Works well on any pump or gravity feed system with at least 3-30 GPM (10-100lpm) flow range
- Applications: Water, Light Chemicals
- Available size: 1" ISO



01N WATER METER

PART NUMBER	DESCRIPTION
GP113255-6	01N12LM 1" ISO Nylon Flow Meter, 10-100lpm - Accuracy +/- 5%

## THE Q9 DISPLAY

The Q9 is the latest version of the popular **FLOMEC** computer display. It incorporates many of the most requested features over the years including low battery indication and the ability to display custom units with a name label. Optional plug-in daughterboards for 4-20mA, scaled pulse, and external power supply are easily added as original equipment or as a retrofit in the field. All of the daughterboard parameters are addressable through the two buttons on the Q9 display. An additional new feature is the ability to display velocity as well as rate and totals.

Packaged in the same form as the familiar 09 display, the Q9 operates on two AAA batteries with approximately 2 years of operation and maintains all of the same intrinsically safe approvals of past products.

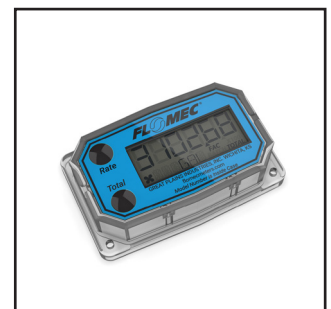

PART NUMBER	DESCRIPTION
	Q9 Computer Display Only



## A1 COMMERCIAL GRADE METERS

A1 Series Meters are designed as self-contained, battery-powered units. Select the A1 Series when you need an accurate, basic meter. They are available in Aluminium or Nylon. Use the Aluminum model for petroleum products. Nylon meter for use in water or non-aggressive chemical applications.

- ▶ Unique package combines Turbine and LCD into a self-contained, compact, economical meter
- ▶ Local Display Computer features: 2 Totals (1 Resettable, 1 Cumulative); Rate of Flow and User Configuration
- ▶ Output capabilities available to communicate with process control equipment
- ▶ Lightweight, compact design allows for easy installation
- ▶ AAA Alkaline battery life: 2 years
- ▶ Available sizes: Nylon - Low Flow, 1" / Aluminium - Low Flow, 1" & 2"



### 1. PRODUCT IDENTIFIER

<b>A1</b>	A1 Series Turbine Meters
-----------	--------------------------

### 2. ELECTRONIC CHOICE

LOCAL COMPUTER W/ DISPLAY, METER MOUNTED

<b>Q9</b>	Q9 Computer Display
-----------	---------------------

LOCAL COMPUTER W/ DISPLAY & MODULE, METER MOUNTED

<b>P9</b>	Q9 2-Button Computer w/ Scaled Pulse Out Module, includes External Power and 10 ft. of Cable
-----------	--

<b>42</b>	Q9 2-Button Computer w/ 4-20mA Module, includes Scaled Pulse Out and 10 ft. of Cable
-----------	--

MODULE, METER MOUNTED (NO DISPLAY)

<b>PO</b>	Pulse Out (unscaled) Conditioned Signal Module w/Cable
-----------	--

RETROFIT COMPUTER KIT (DISPLAY ONLY)

<b>R9</b>	Q9 2-Button Computer Retrofit Kit (Replaces Q9 Display)
-----------	---

NO ELECTRONICS - TURBINE ONLY

<b>XX</b>	No Electronics-Turbine Only
-----------	-----------------------------

### 3. CALIBRATION OF COMPUTER / DISPLAY

<b>GM</b>	Gallons Per Minute (For Use With Q9, P9, 42, R9 Electronics Only)
-----------	---

<b>LM</b>	Litres Per Minute (For Use With Q9, P9, 42, R9 Electronics Only)
-----------	--

<b>XX</b>	No Calibration (Use With PO & XX Electronics Choice Only)
-----------	---

### 4. TURBINE MATERIAL & SIZE

<b>A025</b>	Aluminum - Low Flow
-------------	---------------------

<b>A100</b>	Aluminum - 1 Inch
-------------	-------------------

<b>A200</b>	Aluminum - 2 Inch
-------------	-------------------

<b>N025</b>	Nylon - Low Flow
-------------	------------------

<b>N100</b>	Nylon - 1 Inch
-------------	----------------

<b>X###</b>	No Turbine (Specify Turbine Housing size in place of the # # #)
-------------	---

### 5. FITTING TYPE

<b>N</b>	NPT (Female)
----------	--------------

<b>I</b>	ISO Taper (Female) ISO 7
----------	--------------------------

<b>B</b>	BSPP (Female) (A025 & A100 models only) (ISO 228)
----------	---

<b>X</b>	No Turbine
----------	------------

### 6. PACKAGING and HAZARDOUS AREA RATING:

<b>A1</b>	Standard or Low Flow, 1 inch (w/Q9 & R9 Electronics Choice)
-----------	---

<b>A2</b>	Standard, 2 inch (w/Q9 & R9 Electronics Choice)
-----------	---

<b>B1</b>	Standard or Low Flow, 1 inch Turbine Only
-----------	---

<b>B2</b>	Standard, 2 inch Turbine Only
-----------	-------------------------------

<b>B3</b>	Display Only
-----------	--------------

### PART NUMBER EXAMPLE

<b>1</b>	<b>2</b>	<b>3</b>	<b>4</b>	<b>5</b>
<b>A1</b>	<b>Q9</b>	<b>LM</b>	<b>A100</b>	<b>B</b>

### TRADE PRICE

All prices on customized part numbers will be priced on availability - Contact us for a quote
---

Alternatively, please see page 39 for current prices on the most popular products within this range. These may be subject to change, enquire with us for more information.

## G2 INDUSTRIAL GRADE METERS

The Industrial Grade Meters are unique in the fact that they allow you to design a meter to meet your exact application. Therefore choosing a turbine depends on fitting type, line size, chemical compatibility, flow rate, pressure rating and temperature range. When selecting a G2 Series Meter there is a wide range of materials and sizes to choose from.

- ▶ Meters are designed for thin fluids < 100 cp
- ▶ Modular design allows for use with Output Modules, Sensors and Remote Transmitters
- ▶ 2 Totals (Batch = Resettable, Cumulative = Non resettable); Rate of Flow, Factory calibrated in gallons or litres
- ▶ High accuracy meter
- ▶ AAA Alkaline battery life: 2 years
- ▶ Available sizes: 1/2", 3/4", 1", 1 1/2", 2" (depending on meter type)

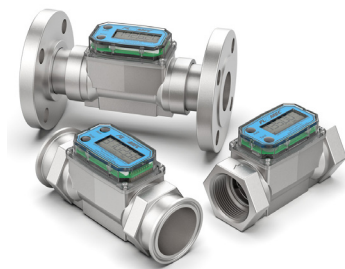

### 1. PRODUCT IDENTIFIER

<b>G2</b>	G2 Series Turbine Meters
-----------	--------------------------

### 2. SIZE AND BODY MATERIAL

#### ALUMINIUM BODY

<b>A05</b>	1/2" Aluminum
<b>A07</b>	3/4" Aluminum
<b>A10</b>	1" Aluminum
<b>A15</b>	1-1/2" Aluminum
<b>A20</b>	2" Aluminum

#### STAINLESS STEEL BODY

<b>S05</b>	1/2" Stainless Steel
<b>S07</b>	3/4" Stainless Steel
<b>S10</b>	1" Stainless Steel
<b>S15</b>	1-1/2" Stainless Steel
<b>S20</b>	2" Stainless Steel

#### HIGH PRESSURE STAINLESS STEEL BODY - NON-APPROVED VERSION - SAFE AREA ONLY

<b>H05</b>	1/2" Stainless Steel (3000 psi)
<b>H07</b>	3/4" Stainless Steel (3000 psi)
<b>H10</b>	1" Stainless Steel (3000 psi)
<b>H15</b>	1-1/2" Stainless Steel (3000 psi)
<b>H20</b>	2" Stainless Steel (3000 psi)

#### PVDF BODY

<b>P05</b>	1/2" PVDF
<b>P07</b>	1" PVDF

### 3. FITTING TYPE

#### THREADED

<b>N</b>	NPT (Female)
<b>I</b>	ISO (Female) or RC: Series Taper British Standard Pipe (ISO 7)

#### FLANGED

<b>F</b>	Class 150 ANSI Flange (S10, S15 & S20 only)
----------	---

#### SANITARY

<b>T</b>	Sanitary Fitting (S05, S07, S10, S15 & S20 only) (NOT Food Grade)
----------	---

#### NO TURBINE BODY

<b>X</b>	No Turbine
----------	------------

### 4. ELECTRONIC CHOICE

#### LOCAL COMPUTER W/ DISPLAY, METER MOUNTED

<b>Q9</b>	Q9 Computer Display
-----------	---------------------

#### LOCAL COMPUTER W/ DISPLAY & MODULE, METER MOUNTED

<b>P9</b>	Q9 2-Button Computer w/ Scaled Pulse Out Module, includes External Power and 10 ft. of Cable
<b>42</b>	Q9 2-Button Computer w/ 4-20mA Module, includes Scaled Pulse Out and 10 ft. of Cable

#### MODULE, METER MOUNTED (NO DISPLAY)

<b>PO</b>	Pulse Out (unscaled) Conditioned Signal Module w/Cable
-----------	--

#### 4. ELECTRONIC CHOICE

RETROFIT COMPUTER KIT (DISPLAY ONLY)

<b>R9</b>	Q9 2-Button Computer Retrofit Kit (Replaces 09 Display)
-----------	---

NO ELECTRONICS - TURBINE ONLY

<b>XX</b>	No Electronics-Turbine Only
-----------	-----------------------------

#### 5. CALIBRATION OF COMPUTER / DISPLAY

<b>GM</b>	Gallons Per Minute (For Use With Q9, P9, 42, R9 Electronics Only)
<b>LM</b>	Litres Per Minute (For Use With Q9, P9, 42, R9 Electronics Only)
<b>XX</b>	No Calibration (Use With PO & XX Electronics Choice Only)

#### 6. PACKAGING and HAZARDOUS AREA RATING:

WITH FM, ATEX & IEC APPROVAL FOR HAZARDOUS AREA (**NOT AVAILABLE ON HIGH PRESSURE S/S VERSIONS**)

<b>A</b>	05 Thru 10 Turbines, Turbine Only or w/Q9 Electronics
<b>B</b>	15 & 20 Turbines, Turbine Only or w/Q9 Electronics
<b>C</b>	15 & 20 Turbines w/Q1 Electronics
<b>D</b>	10 Turbines with ANSI Flange Turbine Only or w/Q9, Q1 Electronics
<b>E</b>	15 & 20 Turbines with ANSI Flange Turbine Only or w/Q9, Q1 Electronics

NON-APPROVED VERSION - SAFE AREA ONLY

<b>V</b>	05 Thru 10 Turbines, Turbine Only or w/Q9 Electronics, 05 Thru 20 Electronics Only (Q9 Replacement Kit or R9 Retrofit Kit)
<b>W</b>	15 & 20 Turbines, Turbine Only or w/Q9 Electronics, 05 Thru 10 Turbines w/Q1 Electronics
<b>X</b>	15 & 20 Turbines w/Q1 Electronics, 05 Thru 20 Turbines w/P9, 42, PO Electronics
<b>Y</b>	10 Turbines with ANSI Flange Turbine Only or w/Q9, Q1, P9, 42, PO Electronics
<b>Z</b>	15 & 20 Turbines with ANSI Flange Turbine Only or w/Q9, Q1, P9, 42, PO Electronics
<b>H</b>	10 Turbines with ANSI Flange w/81, 82 & 83 Electronics
<b>F</b>	05 Thru 20 Turbines w/81, 82 & 83 Electronics
<b>G</b>	15 & 20 Turbines with ANSI Flange w/81, 82 & 83 Electronics

#### PART NUMBER EXAMPLE

<b>1</b>	<b>2</b>	<b>3</b>	<b>4</b>	<b>5</b>	<b>6</b>
<b>G2</b>	<b>A05</b>	<b>I</b>	<b>Q9</b>	<b>LM</b>	<b>A</b>

#### TRADE PRICE

All prices on customized part numbers will be priced on availability - Contact us for a quote

Alternatively, please see page 39 for current prices on the most popular products within this range. These may be subject to change, enquire with us for more information.

#### TM WATER SERIES METERS

The TM Series Water Meters are durable, accurate and economical. They are an ideal alternative to other traditional water meters. The TM series offers flow rate and flow total indication which helps to monitor water flow in waste water applications, water treatment and sub-metering applications. There are seven different sizes and a choice of either Spigot or NPT and BSPP fittings. The electronic display is battery powered and are calibrated to read in gallons, litres per minute and on some models cubic feet.

- ▶ Displays in gallons, litres and cubic feet Indicates Batch, Cumulative Totals and Rate of Flow
- ▶ Available in Spigot, NPT, BSP (1 in., 1-½ in. and 2 in. only), 150 ANSI Flange (3 in. and 4 in. only) and DIN Flange (3 in. and 4 in. only) fittings
- ▶ Lightweight, compact design allows for easy installation
- ▶ AAA Alkaline battery life: 2 years
- ▶ Meets Schedule 80 PVC specifications

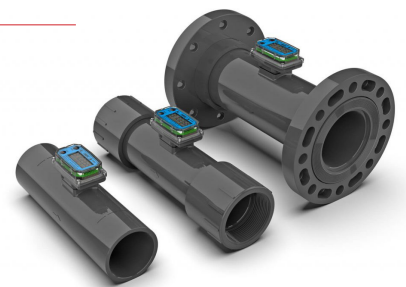

#### 1. PRODUCT IDENTIFIER

<b>TM</b>	TM Series Water Meters
-----------	------------------------

#### 2. TURBINE SIZE AND FITTINGS

WITH SPIGOT (PIPE) ENDS

<b>05S</b>	1/2" Spigot
<b>07S</b>	3/4" Spigot
<b>10S</b>	1" Spigot
<b>15S</b>	1 1/2" Spigot
<b>20S</b>	2" Spigot
<b>30S</b>	3" Spigot
<b>40S</b>	4" Spigot

## 2. TURBINE SIZE AND FITTINGS

WITH FEMALE NPT FITTINGS

<b>05N</b>	1/2" Spigot
<b>07N</b>	3/4" Spigot
<b>10N</b>	1" Spigot
<b>15N</b>	1 1/2" Spigot
<b>20N</b>	2" Spigot
<b>30N</b>	3" Spigot
<b>40N</b>	4" Spigot

WITH FEMALE BSP FITTINGS

<b>10B</b>	1" BSP, Female
<b>15B</b>	1 1/2" BSP, Female
<b>20B</b>	2" BSP, Female

WITH 150# ANSI FLANGE

<b>30F</b>	3" Flange, ANSI
<b>40F</b>	4" Flange, ANSI

WITH DIN PN10/16 FLANGE

<b>30D</b>	3" Flange, DIN
<b>40D</b>	4" Flange, DIN

## 4. ELECTRONIC CHOICE

LOCAL COMPUTER W/ DISPLAY, METER MOUNTED

<b>Q9</b>	Q9 Computer Display
<b>Q1</b>	Q9 2-Button Computer, Vertical Mount (90° Adaptor)

LOCAL COMPUTER W/ DISPLAY & MODULE, METER MOUNTED

<b>P9</b>	Q9 2-Button Computer w/ Scaled Pulse Out Module, includes External Power and 10 ft. of Cable
<b>42</b>	Q9 2-Button Computer w/ 4-20mA Module, includes Scaled Pulse Out and 10 ft. of Cable

MODULE, METER MOUNTED (NO DISPLAY)

<b>PO</b>	Pulse Out (unscaled) Conditioned Signal Module w/Cable
-----------	--

RETROFIT COMPUTER KIT (DISPLAY ONLY)

<b>R9</b>	Q9 2-Button Computer Retrofit Kit (Replaces Q9 Display)
-----------	---

NO ELECTRONICS - TURBINE ONLY

<b>XX</b>	No Electronics-Turbine Only
-----------	-----------------------------

## 5. CALIBRATION OF COMPUTER / DISPLAY

<b>GM</b>	Gallons Per Minute (For Use With Q9, P9, 42, R9 Electronics Only)
<b>LM</b>	Litres Per Minute (For Use With Q9, P9, 42, R9 Electronics Only)
<b>XX</b>	No Calibration (Use With PO & XX Electronics Choice Only)

## 6. PACKAGING

<b>A</b>	05 Thru 10 Turbine Only, 05 Thru 10 Turbine w/Q9 Electronics, X9 and R9 Electronics Kit (Replacement Computer)
<b>B</b>	15 Thru 20 Turbine Only, 15 Thru 20 Turbine w/Q9 Electronics
<b>C</b>	05 Thru 20 Turbine w/Q1, P9, 42, PO Electronics
<b>D</b>	30N, 30S Turbine Only, 30N, 30S Turbine w/Q9, Q1, P9, 42, PO Electronics, 40S Turbine Only, 40S Turbine w/Q9, Q1, P9
<b>E</b>	30F, 30D Turbine Only, 30F, 30D, Turbine w/Q9, Q1, P9, 42, PO Electronics, 40N, 40F, 40D Turbine Only

## PART NUMBER EXAMPLE

<b>1</b>	<b>2</b>	<b>3</b>	<b>4</b>	<b>5</b>	<b>TRADE PRICE</b>
<b>TM</b>	<b>10B</b>	<b>Q9</b>	<b>LM</b>	<b>B</b>	All prices on customized part numbers will be priced on availability - Contact us for a quote

Alternatively, please see page 39 for current prices on the most popular products within this range. These may be subject to change, enquire with us for more information.

# PRICED GPI FLOW METERS

We have selected a handful of meters which we think are the most popular out of their ranges and have priced them accordingly to save time on quoting, please note these can change at any time due to the fluctuation of exchange rates.

## A1 COMMERCIAL GRADE METERS

PART NUMBER	DESCRIPTION
GP6353	Aluminium - A1Q9LMA025IA1 - 1" (0.25" Bore) Low Flow, ISO - 1-10lpm
GP6340	Aluminium - A1Q9LMA100BA1 - 1" BSP - 10-190lpm - Accuracy +/- 1.5%
GP6400	Aluminium - A1Q9LMA200IA2 - 2" ISO - 100-1135lpm - Accuracy +/- 1.5%
GP6355	Nylon - A1Q9LMN025IA1 - 1" (0.25" Bore) Low Flow, ISO - 1-10lpm - Accuracy +/- 1.5%
GP6360	Nylon - A1Q9LMN100IA1 - 1" ISO - 10-190lpm - Accuracy +/- 1.5%

## G2 INDUSTRIAL GRADE METERS - STAINLESS STEEL

PART NUMBER	DESCRIPTION
G2S05IQ9LMA	Stainless Steel 1/2" ISO Female - 3.8-37.9lpm - Accuracy +/- 1.5%
G2S07IQ9LMA	Stainless Steel 3/4" ISO Female - 7.6-75.7lpm - Accuracy +/- 1%
G2S07NQ9LMA	Stainless Steel 3/4" NPT Female - 7.6-75.7lpm - Accuracy +/- 1%
G2S10IQ9LMA	Stainless Steel 1" ISO Female - 18.9-190lpm - Accuracy +/- 1%
G2S15IQ9LMB	Stainless Steel 1 1/2" ISO Female - 38-380lpm - Accuracy +/- 0.75%
G2S20IQ9LMB	Stainless Steel 2" ISO Female - 76-760 lpm - Accuracy +/- 0.75%

## G2 INDUSTRIAL GRADE METERS - STAINLESS STEEL, HIGH PRESSURE- Non-Approved Version - SAFE AREA ONLY

PART NUMBER	DESCRIPTION
G2H05IQ9LMV	Stainless Steel, High Pressure - 1/2" ISO Female - 3.8-37.9lpm - Accuracy +/- 1.5%
G2H07IQ9LMV	Stainless Steel, High Pressure 3/4" ISO Female - 7.6-75.7 lpm - Accuracy +/- 1%
G2H10IQ9LMV	Stainless Steel, High Pressure 1" ISO Female - 18.9-190lpm - Accuracy +/- 1%
G2H15IQ9LMW	Stainless Steel, High Pressure 1 1/2" ISO Female - 38-380lpm - Accuracy +/- 0.75%
G2H20IQ9LMW	Stainless Steel, High Pressure 2" ISO Female - 76-760lpm - Accuracy +/- 0.75%

## G2 INDUSTRIAL GRADE METERS - ALUMINIUM

PART NUMBER	DESCRIPTION
G2A05IQ9LMA	Aluminium - 1/2" ISO Female - 3.8-37.9lpm - Accuracy +/- 1.5%
G2A07IQ9LMA	Aluminium - 3/4" ISO Female - 7.6-75.7lpm - Accuracy +/- 1%
G2A10IQ9LMA	Aluminium - 1" ISO Female - 18.9-190lpm - Accuracy +/- 1%
G2A10NQ9LMA	Aluminium - 1" NPT Female - 18.9-190lpm - Accuracy +/- 1%
G2A15IQ9LMB	Aluminium - 1 1/2" ISO Female - 38-380lpm - Accuracy +/- 0.75%
G2A20IQ9LMB	Aluminium - 2" ISO Female - 76-760lpm - Accuracy +/- 0.75%

## TM SERIES WATER METERS

PART NUMBER	DESCRIPTION
TM05SQ9LMA	1/2" Spigot Connection Water Flow Meter c/w Q9 Display - 3.8-38lpm - Accuracy +/- 3%
TM10BQ9LMA	1" BSP Connection Water Flow Meter c/w Q9 Display - 3.8-38lpm - Accuracy +/- 3%
TM15BQ9LMB	1 1/2" BSP Connection Water Flow Meter c/w Q9 Display - 38-380lpm - Accuracy +/- 3%
TM20BQ9LMB	2" BSP Connection Water Flow Meter c/w Q9 Display - 76-760lpm - Accuracy +/- 3%

# HAND/DRUM/CHEMICAL PUMPS

## STEEL LEVER DRUM PUMP

A light duty lever hand pump for use with Diesel fuel, Kerosene and lightweight or medium weight oils. Supplied complete with a suction pipe to fit into a barrel. Up to 1 litre per stroke.

PART NUMBER	DESCRIPTION
P3930	Steel Lever Drum Pump



## CAST IRON ROTARY DRUM PUMP

A light duty Rotary Hand Pump for use with diesel fuel, kerosene and lightweight or medium weight oils. Supplied complete with a suction pipe to fit into a barrel. Approximately 1 litre every 3 revolutions.

PART NUMBER	DESCRIPTION
P-13-055	Cast Iron Rotary Drum Pump



## GPI RP-10 ROTARY HAND PUMP

The RP-10 - 10 GPM (38 L/min) /100 revolutions manual fuel transfer hand pump has 1 in. FNPT inlet and 3/4 in. NPT outlet connection use with petrol, diesel and kerosene. Lightweight but extremely durable aluminum housing to resist scratches and corrosion. KIT INCLUDES:

- ▶ The RP-10-UL Up to 10 gallons per 100 revolutions hand pump
- ▶ Anti-siphon valve
- ▶ Dispensing hose
- ▶ Telescopic suction pipe
- ▶ Nozzle and bung adapter
- ▶ Handle locking cable

PART NUMBER	DESCRIPTION
GP123000-06	RP-10-UL Pump Kit
GP123503-1	RP-10 Overhaul Kit - Includes: Vanes, Springs, Shaft Seal Kit



## GPI HP-100 ROTARY HAND PUMP

The HP-100 Dual-flow hand pump is a premium hand pump that is reliable and versatile. For high volume fuel transfer, use the high handle position. The HP-100 generates twice the flow of any other hand pump. For heavier fluids or for easier pumping, use the second stroke setting. In either handle position, expect economical, trouble-free operation. KIT INCLUDES:

- ▶ The HP-100 Up to 50 Gal per 100 strokes hand pump
- ▶ Telescopic suction pipe
- ▶ Dispensing hose
- ▶ Lockable lever
- ▶ Nozzle and bung adapter

PART NUMBER	DESCRIPTION
GP114000-7	HP-100-PO Dual Flow Pump Only
GP114000-5	HP-100-NUL Dual Flow Pump Kit

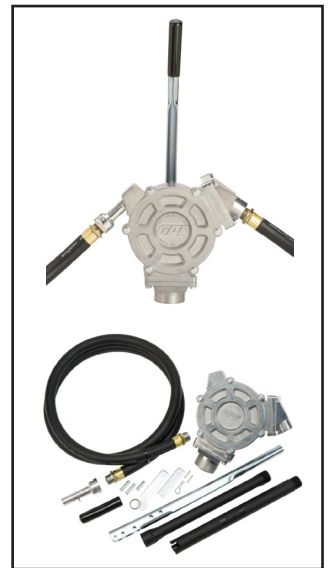

GP114000-10	HP-100-UL Dual Flow Pump Kit
GP114505-2	HP-100 Overhaul Kit
GP123504-1	HP-100 Anti Siphon Vent Kit
GP114014-2	HP-100 Handle
GP114510-503	HP-100 Hardware Kit

# HAND/DRUM/CHEMICAL PUMPS

## PIUSI ROTARY HAND PUMP FOR ADBLUE

This rotary hand pump for AdBlue, manufactured by Piusi is a cost effective way of transferring AdBlue from a drum. Often used when only low volumes are being dispensed and power is not available for an electric pump.

PART NUMBER	DESCRIPTION
P8-F00332050	Piusi Rotary Hand Pump for Adblue - Drum Adaptor
P8-F00332080	Piusi Rotary Hand Pump for Adblue - c/w Hoses and Drum Adaptor



## ROTARY HAND PUMP FOR ADBLUE

This rotary hand pump for AdBlue, is a cost effective way of transferring AdBlue from a drum. Often used when only low volumes are being dispensed and power is not available for an electric pump.

PART NUMBER	DESCRIPTION
AB-RHP-1000	Rotary Hand Pump for AdBlue w/ Telescopic Suction Tube



## LEVER HAND PUMP FOR ADBLUE

This lever hand pump for AdBlue, is a cost effective way of transferring AdBlue from a drum. Often used when only low volumes are being dispensed and power is not available for an electric pump.

PART NUMBER	DESCRIPTION
AB-CM2100-A	AdBlue Lever Hand Pump - c/w Suction & Hose
AB-CM2100-A	2" BSP Adaptor to 2" Butress Male Thread (Plastic Drums)



## PISTON DRUM PUMP - POLYPROPYLENE

Self priming Vertical Lift Pump designed for use with antifreeze, detergents etc. Polypropylene construction with steel plunger rod & viton seals. Complete with 2" polypropylene bung adaptor for use on 55 gallons.

PART NUMBER	DESCRIPTION
P3940	Piston Drum Pump, PP, Mild Steel, Viton



## PISTON DRUM PUMP - NYLON

Self priming Vertical Lift Pump designed primarily for use with lacquer thinners, Urea, AdBlue, DEF. Nylon construction with stainless steel plunger rod & PTFE seals Complete with 2" polypropylene bung adaptor.

PART NUMBER	DESCRIPTION
P3942	Piston Drum Pump, Nylon, SS, PTFE



## CHEMICAL ROTARY HAND PUMP

Pump body & handle are constructed using glass filled Polypropylene' Vanes made out of Ryton. Complete with 3 pc threaded suction tube for use on 50 Litre (15 gallon) to 205 Litre (55 gallon) drums

PART NUMBER	DESCRIPTION
P3945	Rotary Drum Pump, PRP, Ryton, Viton



## DRILL PUMPS

These convenient little drill pumps can be used in all sorts of temporary applications. Suitable for both diesel and water. They require any sort of drill capable of receiving a 6mm/8mm drill shaft to operate them.

PART NUMBER	DESCRIPTION
P-Drill-3/4	Drill Pump, 3/4" Threads, 50lpm, NBR Impellor
P-Drill-1/2	Drill Pump, 1/2" Hosetails, 25lpm, NBR Impellor



As well as being a supplier of GPI flow meters we also list a wide range of GPI/GPro transfer pumps, delivering long-lasting, low maintenance gear and vane pumps for mobile installations such as mounting to a barrel, skid tank, or onto a truck bed tank of 100 gallons or less. They offer a variety of flow rates from 19 - 132 LPM. All GPI pumps are constructed of all aluminum parts with powder-coated motor housings that never rust. Pumps are available as pump only or as part of a kit.

**\*PLEASE NOTE:** GPI/GPro pump prices are inclusive of shipping from USA and supplied ex works from our factory with an average 2 week lead time. Standard UK/international carriage terms from our factory apply.

### UL LISTED PUMPS

UL Listed means that the product has been tested by UL to nationally recognized safety and sustainability standards. Additionally, it has been found to be free from a reasonably foreseeable risk of fire, electric shock in a Division 2 environment. All pumps marked as **UL LISTED** come with UL certification.

### ATEX APPROVED PUMPS

ATEX certification ensures that equipment will work safely in explosive environment without causing any accident if used as per the manufacturer's recommendations. Equipment used in explosive atmosphere within the European Union (EU) and the European Economic Area (EEA) must be ATEX certified. All pumps marked as **ATEX APPROVED** come with ATEX certification.



## G8P 12V 30LPM PORTABLE GEAR PUMP KIT - UL LISTED

The G8P is ideal for on the go fueling for off-road and marine vehicles, landscaping, light industrial, and more. It features a rotary gear design, a 12 V(dc) motor, delivering gas station equivalent flow rates up to 8 GPM for gasoline, diesel fuel and kerosene. Made from durable, lightweight cast aluminum, G8P is 20% lighter than similar portable pumps, and its comfort grip handle provides increased maneuverability when you need it most. The motor is U.L. Listed to U.S. and Canadian safety standards.

- ▶ Connecting cable – Length: 12ft (3.6m)
- ▶ Connection inlet/outlet – 3/4" NPT Female
- ▶ Dispensing Hose - Buna-N, 8ft. (2.4m) x 5/8 IN.
- ▶ Flow rate – 30 L/min
- ▶ Max Pressure – 10 PSI (0.69 Bar)
- ▶ Suction Hose – 8ft suction hose with strainer

PART NUMBER	DESCRIPTION
GP147000-01	12v 30lpm 1" GPI G8P Transfer Pump Kit



## EZ-8 12V 30LPM GEAR PUMP KIT - UL LISTED

GPI EZ-8 Fuel Transfer Pump features a rotary gear design and is made from durable, lightweight corrosion-resistant diecast aluminum. The 12-VDC motor delivers gas station equivalent flow rates (up to 8 GPM) for gasoline, diesel fuel, ethanol blends, and kerosene. The EZ-8 is ideal for on the go fueling for agricultural and automotive applications and is the pump of choice for refueling recreational vehicles. The EZ-8 comes with a manual unleaded nozzle, fuel hose, power cord and adjustable suction pipe or as a pump only option.

- ▶ Connecting cable – Length: 15ft (4.6m)
- ▶ Connection – Inlet - 1" NPTF / Outlet - 3/4" NPTF
- ▶ Dispensing Hose - Buna-N, 10ft. (3.05m) x 5/8 IN.
- ▶ Flow rate – 30 L/min
- ▶ Max Pressure – 15 PSI (1.03 Bar)
- ▶ Suction Pipe - Telescoping 15 IN. to 40 IN. x 1" NPT

PART NUMBER	DESCRIPTION
GP137200-01	12v 30lpm 3/4" GPI EZ-8 Transfer Pump Only
GP137100-01	12v 30lpm 3/4" GPI EZ-8 Transfer Pump Kit w/ Manual Nozzle, 3m Hose

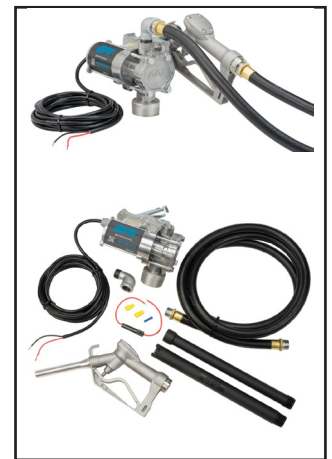

## M-150S-MU/AU 12V 57LPM GEAR PUMP KIT - UL LISTED

The GPI M-150S series is the pump of choice for agricultural, automotive and construction applications dispensing gasoline, diesel fuel, and kerosene with flow rates up to 57 L/min. The M150S features a self-priming rotary gear design, a 12-volt (dc) motor, and a lightweight cast aluminum body that resists corrosion. It comes with a manual/automatic unleaded nozzle, a telescoping suction pipe to fit tank depths between 15" and 40", convenient spin collar for easy installation, a lockable nozzle holder to deter theft & fuel dispensing hose.

- ▶ Connecting cable – Length: 18ft (5.5m)
- ▶ Connection – Inlet - 1" NPTF / Outlet - 3/4" NPTF
- ▶ Dispensing Hose - Buna-N, 12ft. (3.7m) x 5/8 IN.
- ▶ Flow rate – 57 L/min
- ▶ Max Pressure – 15 PSI (1.03 Bar)
- ▶ Suction Pipe - Telescoping 15 IN. to 40 IN. x 1" NPT

PART NUMBER	DESCRIPTION
GP110000-99	12v 57lpm 3/4" GPI M-150S-MU Transfer Pump Kit - Manual Nozzle
GP110000-100	12v 57lpm 3/4" GPI M-150S-AU Transfer Pump Kit - Automatic Nozzle





# GPI TRANSFER PUMPS



## M-180S-MU/AU 12V 69LPM GEAR PUMP KIT - UL LISTED

The GPI M-180S fuel transfer pump features a rotary gear design and is made from durable and light weight cast aluminum. The 12-VDC motor delivers flow rates up to 69lpm. The M-180S is a GPI best-seller, providing longer run times and reliable performance year over year. The M-180S series is the pump of choice for agricultural, automotive and construction applications using gasoline, diesel fuel and kerosene. The M-180S comes with a manual/automatic leaded nozzle, fuel hose, power cord & adjustable suction pipe.

- ▶ Connecting cable – Length: 18ft (5.5m)
- ▶ Connection – Inlet - 1" NPTF / Outlet - 1" NPTF
- ▶ Dispensing Hose - Buna-N, 12ft. (3.7m) x 5/8 IN.
- ▶ Flow rate – 69 L/min
- ▶ Max Pressure – 15 PSI (1.03 Bar)
- ▶ Suction Pipe - Telescoping 15 IN. to 40 IN. x 1" NPT

PART NUMBER	DESCRIPTION
GP110300-1	12v 69lpm 1" GPI M-180S-MU Transfer Pump Kit - Manual Nozzle
GP110300-2	12v 69lpm 1" GPI M-180S-AU Transfer Pump Kit - Automatic Nozzle

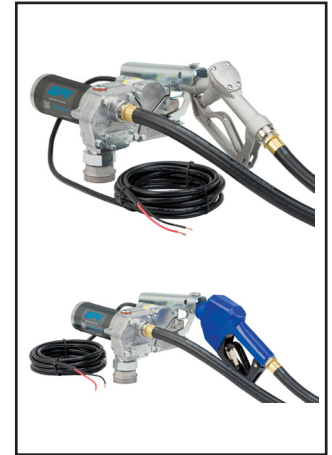

## M-240S-MU 24V 57LPM GEAR PUMP KIT - UL LISTED

M-240S-MU Fuel Transfer Pump, Manual Unleaded Nozzle, 15 GPM (57 L/min), 15 ft. (4.6 m) Power cord, 3/4 in. x 12 ft. (3.7 m) dispensing hose, Suction pipe. Rotary gear design reduces wear and high quality 24-VDC motor provide more operating hours for maximum value.

- ▶ Connecting cable – Length: 18ft (5.5m)
- ▶ Connection – Inlet 1" NPTF / Outlet 3/4" NPTF
- ▶ Dispensing Hose - Buna-N, 8ft. (3.7m) x 5/8 IN.
- ▶ Flow rate – 57 L/min
- ▶ Max Pressure – 15 PSI (1.03 Bar)
- ▶ Suction Pipe - Telescoping 15 IN. to 40 IN. x 1" NPT

PART NUMBER	DESCRIPTION	TRADE PRICE
GP110000-70	24v 57lpm 3/4" GPI M-240S-MU Transfer Pump Kit	POA



## M-115S-AU 115V 45LPM GEAR PUMP KIT - UL LISTED

115 Volt AC Fuel Pumps are designed for stationary locations and offers a 30 minute duty cycle from a permanent magnet motor. Comes with 12 ft. of 3/4"-inch Grounded Hose, automatic unleaded nozzle, lockable nozzle holder, dispensing hose w/static wire, telescoping suction pipe & tank adapter.

- ▶ Connecting cable – N/A
- ▶ Connection – Inlet - 1" NPTF / Outlet - 3/4" NPTF
- ▶ Dispensing Hose - Buna-N, 12ft. (3.7m) x 3/4"
- ▶ Flow rate – 45 L/min
- ▶ Max Pressure – 15 PSI (1.03 Bar)
- ▶ Suction Pipe - Telescoping 15 IN. to 40 IN. x 1" NPT

PART NUMBER	DESCRIPTION	TRADE PRICE
GP110000-82	115v 45lpm 3/4" GPI M-115S-AU Transfer Pump Kit	POA



## HEAVY DUTY DC VANE PUMPS

### PRO20-230PO 230V 76LPM VANE PUMP - UL LISTED

Fluid Compatibility: Gasoline up to E15, Diesel up to B20, Kerosene, AVGAS, Jet A. Center Base Inlet with Check Valve, Easy access fuel strainer, Vacuum breaker ready, Extended duty cycle exceeds industry standard, Field replaceable switch and vanes, Thermally protected motor.

- ▶ Operating Temp – -20°F TO 125°F (-29°C TO 52°C)
- ▶ Connection – Inlet/Outlet - 1" NPTF
- ▶ Flow rate – 76 L/min
- ▶ Max Pressure – 22 PSI (1.52 Bar)

PART NUMBER	DESCRIPTION
GP523000-01	230v 76lpm 1" GPI PRO20-230PO Transfer Pump Only



### \*COMING SOON\*

V20 76LPM MODULAR ATEX APPROVED PUMP IN 230V & 115V



## PRO35-115 230/115V 132LPM VANE PUMP - UL LISTED

Fluid Compatibility: Gasoline up to E15, Diesel up to B20, Kerosene, AVGAS, Jet A. Compatible with Hose Reel, High Pressure Pump & High Flow Rate. Available as pump only or as part of a kit with flow meter, nozzle & hose options. Factory set at 115V 60HZ and optional to wire as 230V 60HZ

- ▶ Operating Temp – -20°F TO 125°F (-29°C TO 52°C)
- ▶ Flow rate – 132 L/min
- ▶ Connection – Inlet - 1 1/4" NPTF / Outlet - 1" NPTF
- ▶ Max Pressure – 25 PSI (1.72 Bar)

PART NUMBER	DESCRIPTION	TRADE PRICE
PRO35-115*	230v/115v, 135lpm PRO35-115 - Pump Only or Kit	POA



## V25-012/24PX 12V/24V 94LPM VANE PUMP - UL LISTED & ATEX APPROVED

Quick-Fit modular design eliminate dangerous leaks. Four bolts and an O-ring quickly attach a filter, meter or both. Equipped with Safe Stop Power Down - 30 minute auto power down with easy reset, Pump 750 gallons uninterrupted, prevents misuse.

- ▶ Operating Temp – -20°F TO 125°F (-29°C TO 52°C)
- ▶ Flow rate – 94 L/min
- ▶ Connection – Inlet/Outlet - 1" NPT
- ▶ Voltage – Available in 12v & 24v

PART NUMBER	DESCRIPTION
GP170000-01	12v, 94lpm V25-012PX Heavy Duty Vane Pump Only
GP170001-01	24v, 94lpm V25-024PX Heavy Duty Vane Pump Only



## G20-012PX 12V 76LPM GEAR PUMP - UL LISTED & ATEX APPROVED

The G20-012PX features a new modular design with simple 4-bolt connection points to complement our Quick-Fit accessories. Attach a filter, meter or both quickly and easily. The 12V motor delivers flow rates up to 20 GPM. Featuring a rotary gear design and powder coated die cast aluminum body to ensure a long life with minimal maintenance.

- ▶ Operating Temp – -20°F TO 125°F (-29°C TO 52°C)
- ▶ Flow rate – 76 L/min
- ▶ Connection – Inlet/Outlet - 1" NPTF
- ▶ Max Pressure – 15 PSI

PART NUMBER	DESCRIPTION
GP162000-01	12v, 76lpm G20-012PX Gear Pump Only
GP165100-06	M30-L8B Mechanical Meter 1" BSP/G20 Quick Fit Flange - 19-114lpm
GP129500-01	G20 Modular Quick Fit Flange Filter Kit, Includes Filter
GP129340-07	Replacement Filter 94.6lpm, 10 Micron, 1-3/8-12 UNF



## POLYPROPYLENE TELESCOPIC RIGID SUCTION PIPE

Versatile telescoping design fits most standard tank sizes. Comes with a 15 inch extension pipe for larger tanks. Compatible with 1 inch inlet GPI Pumps for use with gasoline, E15, diesel, biodiesel, and kerosene.

PART NUMBER	DESCRIPTION
GP-110241-01	Polypropylene Telescopic Suction Pipe



## UL APPROVED COMPONENTS DISPENSING KIT

This kit has been designed to bolt on to a variety of pumps to provide a full dispensing kit of UL approved components. \*NB: suitable for This kit includes:

- ▶ Static Bonded Fuel Hose - 1" x 5.4m - **UL APPROVED**
- ▶ Automatic Nozzle - 1" NPT, 1" Spout - **UL APPROVED**
- ▶ Composite Suction Pipe - 1" NPT (15" - 40")
- ▶ Extension Suction Pipe - 14.5"
- ▶ Power Cord Kit - 18ft (5.5m) \*12/24V DC only. AC pumps should be connected by a professional.

**COMPATIBILITY**  
Pumps marked with:



Are compatible with this kit.

PART NUMBER	DESCRIPTION
GP-DISPENSINGKIT-HF	UL Approved Dispensing Kit





We stock top quality Swiss/German made FMT pumps, which are built to withstand the most vigorous of use. Their pumps provide very small tolerances of their pumps provide for a most efficient suction and delivery performance.

### FMT 12V DC TRANSFER PUMP

The pump can be used in a mobile or stationary application, where a battery has to be used, e.g. on a construction site, in agriculture, on boats, etc. Suitable for Diesel.

- ▶ Connecting cable – Length: 3m
- ▶ Connection inlet/outlet – 1" Female
- ▶ Pump design – Vane pump, Self Priming
- ▶ Flow rate – 35lpm / 54lpm
- ▶ Max Pressure – 1.6 / 1.8 Bar
- ▶ Suction height – 3m

PART NUMBER	DESCRIPTION
P-23-012	12v 35lpm 1" FMT Transfer Pump, 1.6 Bar - c/w Cable & Clips
P-23-406	12v 54lpm 1" FMT Transfer Pump, 1.8 Bar - c/w Cable & Clips



### FMT 24V DC TRANSFER PUMP

- ▶ Connecting cable – Length: 3m
- ▶ Connection inlet/outlet – 1" Female
- ▶ Pump design – Vane pump, Self Priming
- ▶ Flow rate – 35lpm / 54lpm
- ▶ Max Pressure – 1.6 / 1.8 Bar
- ▶ Suction height – 3m

PART NUMBER	DESCRIPTION
P-23-405	24v 35lpm 1" FMT Transfer Pump, 1.6 Bar - c/w Cable & Clips
P-23-407	24v 54lpm 1" FMT Transfer Pump, 1.8 Bar - c/w Cable & Clips



### FMT 110V TRANSFER PUMP

The very small tolerances of this pump provide for a most efficient suction and delivery performance. Complete with integral bypass, on/off switch, thermoprotection switch.

- ▶ Connecting cable – Length: 1.8m
- ▶ Connection inlet/outlet – 1" Female
- ▶ Pump design – Vane pump, Self Priming
- ▶ Flow rate – 60lpm / 100lpm
- ▶ Max Pressure – 1.8 Bar
- ▶ Suction height – 5m

PART NUMBER	DESCRIPTION
P-23-430-006	110v 60lpm 1" FMT Transfer Pump, 1.8 Bar
P-23-055	110v 100lpm 1" FMT Transfer Pump, 1.8 Bar



### FMT 230V TRANSFER PUMP

- ▶ Connecting cable – Length: 1.8m
- ▶ Connection inlet/outlet – 1" Female
- ▶ Pump design – Vane pump, Self Priming
- ▶ Flow rate – 60lpm / 100lpm
- ▶ Max Pressure – 1.8 Bar
- ▶ Suction height – 5m

PART NUMBER	DESCRIPTION
P-23-430	230v 60lpm 1" FMT Transfer Pump, 1.8 Bar
P-23-433	230v 100lpm 1" FMT Transfer Pump, 1.8 Bar



# LIQUID TRANSFER PUMP KITS

## TANK INSTALLERS PUMP KIT

Designed by Atkinson Equipment, this tank installers transfer kit is designed as for transferring fuel from one tank to the other. With various pump options available this can be tailored to suit your application.

- ▶ FMT Pump (Voltage of choice)
- ▶ x2 dust plugs for hoses
- ▶ x1 10mtr 1" hose fitted with cam couplings and a y-strainer (filter)
- ▶ x1 5m 1" Hose fitted with cam couplings
- ▶ x2 dust caps for hoses



PART NUMBER	DESCRIPTION
TIK-1235	Tank Installers Kit w/ 12v, 35lpm Pump
TIK-1260	Tank Installers Kit w/ 12v, 60lpm Pump
TIK-1110	Tank Installers Kit w/ 110v, 60lpm Pump
TIK-1000	Tank Installers Kit w/ 230v, 60lpm Pump
TIK-1100	Tank Installers Kit w/ 230v, 100lpm Pump

## PORTABLE FUEL TRANSFER PUMP KIT

Designed by Atkinson Equipment, this portable diesel transfer kit is designed as a ready to use portable refuelling pump solution for diesel dispensing from drums or small tanks to refuel vehicles. In some applications like constructions sites, agriculture or boats, a battery powered pump is the only option. This kit has a choice of voltages to suit your application.

- ▶ FMT Pump (Voltage of choice)
- ▶ All fittings included: swivel, integral bypass, non-return valve, strainer, jubilee clips, hose tails & PTFE tape
- ▶ 4.6M 3/4" single piece of hose - choice of the length of the supply/delivery on each side of the pump is left up to you. Cut according to your own application.
- ▶ Manual Nozzle – 60lpm



PART NUMBER	DESCRIPTION
P-23-012-KIT	12v DC - 35lpm Battery Powered Portable Pump Kit
P-23-008-KIT	12v DC - 60lpm Battery Powered Portable Pump Kit
P-23-430-006-KIT	110v - 60lpm Mains Powered Portable Pump Kit
P-23-034-KIT	230v - 60lpm Mains Powered Portable Pump Kit
P-23-036-KIT	230v - 100lpm Mains Powered Portable Pump Kit

## ATKINSON FUELBOX

The Atkinson Fuel Box has been developed to add value to a popular industry refuelling product. The Swiss self-priming pump and flowmeter have a 3-year return to supplier warrantee. As well as the unique 3-year warrantee, the Atkinson Fuel Box incorporates its own automatic on/off switch so that when the nozzle is taken out of its holster the pump automatically switches on and when the nozzle is replaced the pump automatically switches off (just like a garage forecourt pump).

- ▶ FMT Pump (Voltage of choice)
- ▶ Hose – 4m of 3/4" Delivery Hose
- ▶ Flow Meter – 3 Digit Batch, 6 Digit Cumulative
- ▶ Flow Rate – 35 or 60lpm
- ▶ Nozzle – Automatic Shut Off
- ▶ Warranty – 3 years manufacturers



PART NUMBER	DESCRIPTION
FB-12	12v - Fuel Dispensing Box 35lpm c/w 4mtrs Hose + Auto Nozzle
FB-24	24v - Fuel Dispensing Box 35lpm c/w 4mtrs Hose + Auto Nozzle
FB-110	110v - Fuel Dispensing Box 60lpm c/w 4mtrs Hose + Auto Nozzle
FB-230	230v - Fuel Dispensing Box 60lpm c/w 4mtrs Hose + Auto Nozzle
FB-PED	Fuel Box Pedestal
FB-13-KIT	Quick Coupling - Tube & Screws
FB-11	Quick Coupling Adaptor

# DIESEL MANAGEMENT SYSTEMS

**WHAT IS A DIESEL MANAGEMENT SYSTEM?** - Diesel management systems are designed to monitor and control fuel consumption within your fleet. They accurately measure and track fuel inventories and how fuel is dispensed. This information is then stored in systems and reported to the manager through the use of web portals to provide this useful data. See below installation example of the FMT Diesel Management Systems:

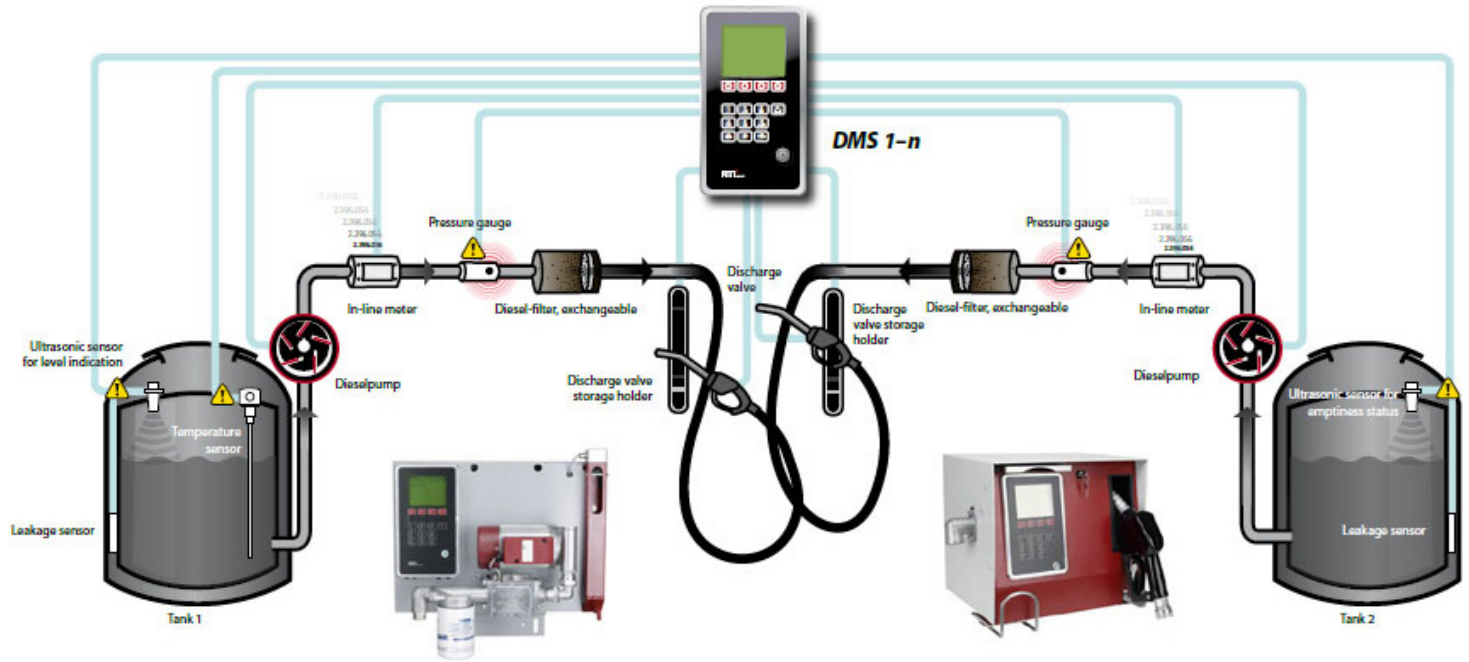

## DMS DISPENSING BOX

All in one diesel dispensing kit, includes; 60lpm pump, filter, 6m hose, automatic nozzle.  
Available in 230v 60lpm or 100lpm

- FMT Pump (P-23-430)
- In-line meter NUMERlxx<sup>3</sup>, three digits
- Automatic nozzle valve with swivel joint
- On/Off switch through control valve
- Discharge hose, 6 m, DN 19, G 1" male, G 1" female
- Foot valve with filter



PART NUMBER	DESCRIPTION
P-23-513-100	FMT Diesel Dispensing Box - 230v, 60lpm
P-23-423	FMT Diesel Dispensing Box - 230v, 100lpm

## DMS ISLAND PUMP

All in one diesel dispensing island pump kit, includes; 60lpm pump & filter. Hose & nozzle available as extras or as part of the DMS Island kit. Available in 230v 60lpm or 100lpm

- FMT Pump (P-23-430)
- In-line meter NUMERlxx<sup>3</sup>, three digits
- Automatic nozzle valve with swivel joint
- On/Off switch through control valve
- Discharge hose, 6 m, DN 19, G 1" male, G 1" female
- Foot valve with filter

PART NUMBER	DESCRIPTION
P-23-370	FMT Diesel Dispensing Island Pump Only - 230v, 60lpm
P-23-372	FMT Diesel Dispensing Island Pump Only - 230v, 100lpm
P-23-371	FMT DMS Dispensing Island Pump w/ 6m Hose & Nozzle - 230v, 60lpm
P-23-372	FMT DMS Dispensing Island Pump w/ 6m Hose & Nozzle - 230v, 100lpm
P-23-209	FMT Replacement Canister Filter for FMT Pumps
P-23-069	FMT DMS I-Buttons, Black, 10 Per Pack



Pedrollo are an Italian pump manufacturer who have been making pumps and motors in San Bonifacio since 1974 and are now globally recognised as a leading manufacturer in the water pumps industry. The extensive ranges of Pedrollo pumps cover most agricultural, domestic and industrial applications and are constantly evolving to remain some of the most efficient available.

## CENTRIFUGAL PUMPS

Any pump that utilises centrifugal force to create a large amount of pressure in fluid is a centrifugal pump. This results in a pumping action. The easiest way to imagine is water being flicked up off of a car tyre on a wet road. Rather than like most pumps utilising a scooping action created by the vanes or blades on the impeller, a centrifugal pump pumps from the centrifugal force.

Centrifugal pumps can pump continuously at high flow rates and at a very high pressure. Consequently making the centrifugal pump cost effective and reliable. We have a wide range of centrifugal pumps ranging from standard, medium flow to high flow.

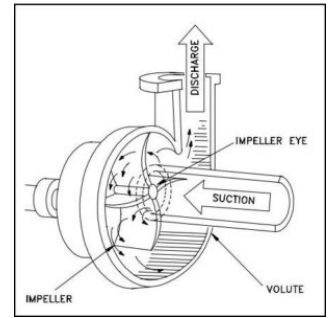

## SELF PRIMING / LIQUID RING PUMPS

A self-priming centrifugal pump is a solution to pumps becoming air-bound when air gets into the pump. It does this by mixing air with water to create a fluid that can be pumped and has similar properties to regular water. The pump gets rid of the air and pumps the water, just like a standard centrifugal pump.

These pumps are different than a standard centrifugal pump as it has a built-in water reservoir into the unit which allows it to rid pump and suction line of air by recirculating the water in the pump on the priming cycle. The water reservoir can be located above or in front of the impeller. Either way the self-priming ability of the pump comes from the pump's ability to keep the water after it first primes.

When the pump is priming, the air enters the pump and mixes with the water in the impeller. The air and water are transferred together by centrifugal action of the impeller into the water reservoir. Consequently the air naturally rises and the water sinks.

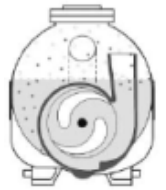

Now that the water is free of air it is heavier than air-laden water. It flows by gravity back down to the impeller chamber which is then mixed with more air being transferred through the suction line. Once all of the air has been removed and vacuum created in the suction line, the atmospheric pressure forces water into the suction line towards the impeller and begins pumping.

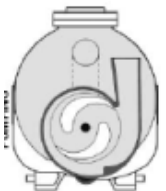

The water within the pump stops recirculating and it begins pumping. The next time the pump starts it will 'self-prime'. It will be able to mix the air and water in the casing to create fluid that is pump-able. The pump's prime will be complete and will begin pumping again.

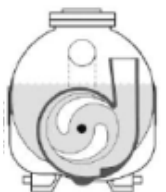

## PERIPHERAL PUMPS

Peripheral pumps have an impeller which has a large amount of small, radial double-flow vanes arranged at its periphery. This impeller then rotates in a large concentric casing channel with an outlet and inlet opening. As the fluid circulates repeatedly between the impeller and the casing channel the energy transferred to it is extremely high.

The fluid transfers along the circumference, from the inlet to the outlet of the casing increasing the pressure. Between the outlet is an arranged stripper. The inlet then prevents a hydraulic short circuit between the high-pressure and the low-pressure side of the casing channel. Peripheral pumps are often designed as close-coupled pumps. This is because of the large increase in energy, they can be small in size.

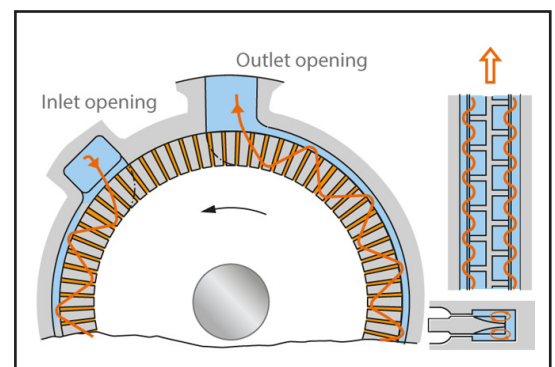

# WATER/DIESEL TRANSFER PUMPS

## PEDROLLO CP132A CENTRIFUGAL TRANSFER PUMP

Suitable for use with clean water and liquids that are not chemically aggressive towards the materials from which the pump is made. As a result of their reliability and the fact that they are easy to use, these pumps are widely used in domestic and civil applications such as the distribution of water in combination with small and medium sized pressure sets, for transferring liquids and for the irrigation of gardens and allotments.

- Flow rate up to 160 L/min (59.6 m<sup>3</sup>/hr)
- Dynamic head up to 58m
- Available in 230v & 400v
- Temperature (min/max) -10 °C to +90 °C



PART NUMBER	DESCRIPTION
P3224	230v Single Phase CPM132A Pedrollo Centrifugal Pump - 1" BSP
P3241	400v Three Phase CP132A Pedrollo Centrifugal Pump - 1" BSP

## PEDROLLO HF50A MEDIUM FLOW CENTRIFUGAL TRANSFER PUMP

The high efficiency and continuous duty capabilities makes these pumps ideal for use in activities such as flood and spray irrigation, drawing water from lakes, rivers and wells, or for any number of different industrial applications where the characteristics of high flow rates and mid to low head are required. The pump should be installed in an enclosed environment, or at least sheltered from inclement weather.

- Flow rate up to 600 l/min (36,0 m<sup>3</sup>/h)
- Head up to 39 m
- Available in Single Phase 230v & Three Phase 400v
- Temperature (min/max) -10 °C to +90 °C



PART NUMBER	DESCRIPTION
P3490-1	230v Single Phase HFM50A Pedrollo Medium Flow Centrifugal Pump - 1 1/2" BSP
P3490-3	400v Three Phase HF50A Pedrollo Medium Flow Centrifugal Pump - 2" BSP

## PEDROLLO CK50/80 SELF PRIMING TRANSFER PUMP

Suitable for use with diesel, clean water that does not contain abrasive particles and liquids that are not chemically aggressive towards the materials from which the pump is made. As a specific result of the pump's operating principle they are suitable for use in all situations where a compact self-priming pump is required or where the fluid supply is limited, irregular or contains air.

- Flow rate up to 50 l/min (3,0 m<sup>3</sup>/h)
- Head up to 51 m
- Available in Single Phase 230v & Three Phase 400v
- Temperature (min/max) -10 °C to +90 °C



PART NUMBER	DESCRIPTION
P3150-1	230v Single Phase CKM50 Pedrollo Self Priming Pump - 3/4" BSP
P3150-3	400v Three Phase CK50 Pedrollo Self Priming Pump - 3/4" BSP
P3150-1BP	230v Single Phase CKM50BP Pedrollo Self Priming Pump w/ Internal By-Pass - 3/4" BSP
P3180	230v Single Phase CKM80 Pedrollo Self Priming Pump - 1" BSP
P3180-3	400v Three Phase CK80 Pedrollo Self Priming Pump - 1" BSP

## PEDROLLO 2-5CR TRANSFER PUMP

Suitable for use with clean water and liquids that are not chemically aggressive towards the materials from which the pump is made. As a result of their quietness, these pumps are widely used in domestic applications such as the distribution of water in combination with small and medium sized pressure sets, and for the irrigation of gardens and allotments, etc.

- Flow rate up to 130 l/min (7,8 m<sup>3</sup>/h)
- Head up to 67 m
- Available in Single Phase 230v
- Temperature of the liquid from -10 °C to +40 °C



PART NUMBER	DESCRIPTION
P3330	230v Single Phase 3CRM80 Pedrollo Stainless Steel Multi-Stage Pump - 1" BSP / 70lpm
P3340	230v Single Phase 4CRM80 Pedrollo Stainless Steel Multi-Stage Pump - 1" BSP / 80lpm
P3350	230v Single Phase 3CRM100 Pedrollo Stainless Steel Multi-Stage Pump - 1" BSP / 110lpm

# WATER/DIESEL TRANSFER PUMPS



## PEDROLLO PK60/65/100 PERIPHERAL END SUCTION TRANSFER PUMP

Suitable for use with clean water that does not contain abrasive particles and liquids that are not chemically aggressive towards the materials from which the pump is made. Thanks to their reliability, the fact that they are easy to use and are economical, they are ideal for domestic use and in particular for distributing water in combination with small pressure sets and for the irrigation of gardens and allotments.

- ▶ Flow rate up to 90 l/min (5,4 m<sup>3</sup>/h)
- ▶ Head up to 100 m
- ▶ Available in Single Phase 230v & Three Phase 400v
- ▶ Temperature of the liquid from -10 °C to +60 °C

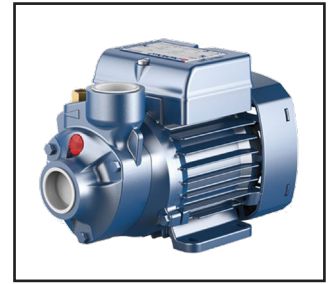

PART NUMBER	DESCRIPTION
P3300	230v Single Phase PKM60 Pedrollo Peripheral Pump - 1" BSP / 5-40lpm
P3310	230v Single Phase PKM65 Pedrollo Peripheral Pump - 1" BSP / 5-50lpm
P3320	230v Single Phase PKM100 Pedrollo Peripheral Pump - 1" BSP / 5-70lpm

# SUBMERSIBLE PUMPS

## PEDROLLO TOP SUBMERSIBLE TRANSFER PUMP

The TOP series of clear water drainage pumps is recommended for emergency draining of small flooded areas, rooms, cellars, garages, the disposal of waste water in the home and for emptying drainage traps. Supplied with 10mtrs electric cable and hose connector. Will drain down to 14mm level.

- ▶ Flow rate up to 360 l/min (21,6 m<sup>3</sup>/h)
- ▶ Head up to 14,50 m
- ▶ Available in Single Phase 230v
- ▶ Temperature of the liquid to +40 °C



PART NUMBER	DESCRIPTION
P3360	230v TOP 1 Pedrollo Submersible Pump - 20-140lpm
P3370	230v TOP 2 Pedrollo Submersible Pump - 20-220lpm
P3380	230v TOP 3 Pedrollo Submersible Pump - 20-260lpm
P3390	230v TOP 4 Pedrollo Submersible Pump - 20-320lpm
P3400	230v TOP 5 Pedrollo Submersible Pump - 20-400lpm

## ECONOMY LOW VOLTAGE SUBMERSIBLE PUMP

Used to pump small volumes of liquid from one tank to the other. Suitable for diesel, kerosene & water. Body size is 140mm x 40mm. This submersible pump can easily be connected to a standard garden hose and dropped into the tank to pump out the water from the bottom of your tank.

- ▶ Flow rate up to 32lpm
- ▶ Available in 12v DC



PART NUMBER	DESCRIPTION
P3900	12v DC Amazon Submersible Pump - 18lpm



# FUEL FILTERS & ELEMENTS

## GROZ WATER BLOCK/PARTICULATE FUEL TANK FILTER

A range of Fuel Filters to suit different types of fuels in agricultural & industrial applications. Durable & light-weight design for easy installation on mobile & stationary fuel tanks and on gasoline & diesel fuel pumps. This comes complete with a water-block 10 micron element and a replacement water block & particulate filter element is available, as is a 10 micron particulate only version.

- ▶ Connection size – 1" BSP Threaded
- ▶ Suitable for – Diesel, Bio Diesel, Petrol & Kerosene
- ▶ Replacement available – Particulate Only Element or Water + Particulate Element



### PART NUMBER

### DESCRIPTION

GFH3579-W	Groz Water-Block & Particulate Filter - Complete Unit
GFH3579-P-ELMNT	Replacement Particulate Only Filter Element - 10 Micron
GFH3579-W-ELMNT	Replacement Water-Block & Particulate Filter Element - 10 Micron

## GOLDENROD WATER BLOCK/PARTICULATE FUEL TANK FILTER - 95LPM

**Important note:** These are genuine Golden Rod Filters & Elements and are not 'grey imports/forges'. For removing microscopic particles (15 microns) of rust, sand, dirt, scale and lint. 366 sq. inches of filter surface for efficient action. Unit works well by itself where water is not a problem, or in combination with the water block fuel filter for added protection from water in the fuel.

- ▶ Connection size – 1" BSP Threaded
- ▶ Suitable for – Diesel, Bio Diesel, Petrol & Kerosene
- ▶ Maximum flow rate of 95 Ltrs Per Min



### PART NUMBER

### DESCRIPTION

GFH3590	Goldenrod Particulate Only Filter - Complete Unit - 15 Micron
GFH3590-W	Goldenrod Water-Block & Particulate Filter - Complete Unit - 15 Micron
GFH3579-W-ELMNT	Replacement Water-Block & Particulate Filter Element - 10 Micron

## FILTER BOWL SPANNER

Ring Spanner for tightening filter bowls. Black Plastic Wrench for filter bowl type filters like the Goldenrod, Baldwin and Groz filters.

### PART NUMBER

### DESCRIPTION

GFH3579-S	Filter Wrench for ALL the above Filter Bowls
-----------	--



## GILBARCO PARTICULATE ONLY FUEL TANK FILTER - 50LPM

This Pumped Filter System, up to 50 lpm, comprises a 'head' that is permanently fitted inline with replaceable 'elements' that are removed and disposed of once spent (similar to a car filter). The 'head' and the 'filter elements' are sold separately. This is a particulate filter only and does not eliminate water if present in the oil.

**Tip:** It is often a good idea to purchase a spare filter element to keep on the shelf ready to replace.

- ▶ Connection size – 1" BSP, 1" UNF Nose
- ▶ Suitable for – Diesel, Bio Diesel, Petrol & Kerosene
- ▶ Maximum flow rate of 50 Ltrs Per Min



### PART NUMBER

### DESCRIPTION

GFH3581-A	Aluminium Head - For 1" BSPF Inlet/Outlet Filters, 1" UNF Nose
GFH3580	Gilbarco 10 Micron Particulate Only - 50lpm

# FUEL FILTERS & ELEMENTS

## GPI WATER-BLOCK / PARTICULATE FUEL TANK FILTER - 67LPM

This Pumped Filter System, up to 67 lpm, comprises a 'head' that is permanently fitted inline with replaceable 'elements' that are removed and disposed of once spent (similar to a car filter). The 'head' and the 'filter elements' are sold separately. Versions of the element are often available containing Hydrosorb powder that absorbs and eliminates any water contained in the diesel.

- Connection size – 1" BSP, 1" UNF Nose
- Maximum flow rate of 67 Ltrs Per Min
- Suitable for – Diesel



PART NUMBER	DESCRIPTION
GFH3581-A	Aluminium Head - For 1" BSPF Inlet/Outlet Filters, 1" UNF Nose
GP129300-01	GPI 10 Micron Particulate Only Pumped Filter Element - 67lpm
GP129300-02	GPI 10 Micron Water & Particulate Pumped Filter Element - 67lpm

## CIM-TEK WATER-BLOCK / PARTICULATE FUEL TANK FILTER FOR BIO-DIESEL - 95LPM

This Pumped Filter System, up to 95 lpm, comprises a 'head' that is permanently fitted inline with replaceable 'elements' that are removed and disposed of once spent (similar to a car filter). The 'head' and the 'filter elements' are sold separately. Particulate filter only. **Tip:** It is often a good idea to purchase an additional filter to keep on the shelf ready to replace a spent element.

- Connection size – 1" BSP, 1" UNF Nose
- Maximum flow rate of 95 Ltrs Per Min
- Suitable for – Diesel, Bio Diesel



PART NUMBER	DESCRIPTION
GFH3581-A	Aluminium Head - For 1" BSPF Inlet/Outlet Filters, 1" UNF Nose
GP129340-04	Cim-Tek 2 Micron Water & Particulate Pumped Filter Element - 95lpm

## GPI WATER-BLOCK / PARTICULATE FUEL TANK FILTER - 150LPM

This Pumped Filter System, up to 150 lpm, comprises a 'head' that is permanently fitted inline with replaceable 'elements' that are removed and disposed of once spent (similar to a car filter). The 'head' and the 'filter elements' are sold separately. **Tip:** Do ensure you select the correct head and element according to the flow type/ rate/ requirement of your particular system.

- Connection size – 1" BSP, 1" UNF Nose
- Maximum flow rate of 150 Ltrs Per Min
- Suitable for – Diesel, Bio Diesel



PART NUMBER	DESCRIPTION
GP906005-67	Aluminium Head - For 1" NPT Inlet/Outlet Filters, 1.5" UNF Nose
GP129320-02	GPI 10 Micron Water & Particulate Pumped Filter Element - 113lpm
GP129340-05	Cim-Tek 2 Micron Water & Particulate Pumped Filer Element for Bio Diesel - 150lpm
MF1616N-MM-B	1inNPT*1inBSPT M/M EQUAL CONNECTOR BRASS

## GIULIANI ANELLO PARTICULATE FUEL TANK FILTER

Giuliani Anello is an Italian manufacturer who have produced these high quality inline heating oil filters for over 50 years. Strainer filter for diesel, fuel oil and air with aluminium cover and bowl. General purpose metal bowled filters for use with fluids not aggressive to the filter's component materials.

- Connection size – 1" BSP Threaded
- Maximum temperature: 90°C
- Suitable for – diesel, fuel oil and air



PART NUMBER	DESCRIPTION
M5080	1" 100 Micron Inline Metal Bowled Filter
M5080-RF	Replacement 100 Micron Stainless Steel Filter Element

# FMT PUMP SPARES

## REPLACEMENT VANES

Vane pumps have a rotor and vanes which slide in and out, they are self priming due to the contact between the vanes and pump housing. The vanes are therefore subject to normal wear which can be increased by the presence of debris or excess dry running, causing them to snap and temporarily jam. They are designed to be serviceable items and replaced when necessary. See below for a list of vanes and other spares relating to the FMT pumps;

There are a few different types of vanes that go into the FMT pumps depending on their voltage and flow rate, also some pumps only need 5 vanes whereas others will need 6. The age of your pump will also be a factor to consider, due to a new style of vane for newer style pumps. These are easy to differentiate by their colour and shape, see below to help identify what vane set you require.



<b>NEW STYLE - FOR USE WITH:</b>	
230V, 60LPM (P-23-430/23-100)	
110V, 60LPM (P-23-054)	
<b>X6 VANES REQUIRED</b>	
<b>PART NUMBER:</b>	P-89-254
<b>TRADE PRICE:</b>	£4.60 Per Vane



<b>OLD STYLE - FOR USE WITH:</b>	
230V, 60LPM (P-23-034)	
<b>BEFORE 2010</b>	
<b>X6 VANES REQUIRED</b>	
<b>PART NUMBER:</b>	P-89-254-OLD
<b>TRADE PRICE:</b>	£6.50 Per Vane



<b>FOR USE WITH:</b>	
230V, 100LPM (P-23-102)	
110V, 100LPM (P-23-055)	
<b>X6 VANES REQUIRED</b>	
<b>PART NUMBER:</b>	P-89-304
<b>TRADE PRICE:</b>	£4.60 Per Vane



<b>FOR USE WITH:</b>	
12V, 35LPM (P-23-012)	
<b>X5 VANES REQUIRED</b>	
<b>PART NUMBER:</b>	P-89-429
<b>TRADE PRICE:</b>	£4.60 Per Vane

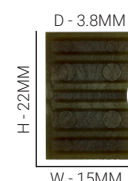

<b>FOR USE WITH:</b>	
12V, 60LPM (P-23-406)	
<b>X5 VANES REQUIRED</b>	
<b>PART NUMBER:</b>	P-89-398
<b>TRADE PRICE:</b>	£4.60 Per Vane

## OTHER FMT SPARES

PART NUMBER	DESCRIPTION
P-82-673	FMT NBR O-Ring 62 x 1.5mm - 60lpm Pump
P-82-515	FMT Ring Gasket - Split Design - 60lpm Pump
P-23-988	FMT Pump Bypass Assembly
P-00-208	FMT 230V Red Rocker Switch for Pump
P-23-209	FMT Canister Filter 30mic + Water 1.5" F Thread
P-23-298	FMT Flow Meter Counter Assembly
P-82-661	FMT O-Ring - 72 X1.5 - 23-102/23-433 100lpm Pump Only
P-82-521	FMT O'Ring Gasket Split Design for 23-102 - 100lpm Pump Only
P-84-432	Cover Ring Gasket Split Design for 23-433 - 100lpm Pump Only
P-85-358	FMT Cone Seat Nipple, 1" M-M, C/W O-ring
P-23-218	FMT Cone Seat Union to 1" BSP to suit P-85-358
P-23-069	FMT DMS I-Buttons, Black, 10 Per Pack
P-82-357	O-ring for P-23-192 Flowmeter

 P-23-209	 P-23-298
 P-82-661	 P-82-515
 P-00-208	 P-23-988

# GPI FLOW METER ACCESSORIES

## FM/ATEX APPROVED SENSOR KIT

The Factory Mutual (FM and ATEX) Approved Sensor is designed for use with any G2 Turbine Meter when rotor pulse data is required and the meter is located within a hazardous location.

- ▶ The output signal is compatible with existing FLOMEC® remote electronics. Use on G2 "Turbine Only" model.
- ▶ This kit includes pickup, screws, cover plate and jam nut.

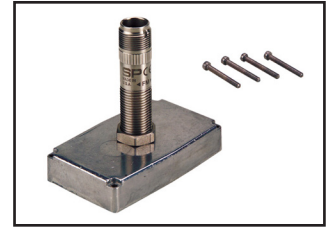

PART NUMBER	DESCRIPTION
GP120077-01	GPI FM Approved Sensor Kit
GP120077-02	GPI ATEX Approved Sensor Kit
GP113524-01	GPI Connector Kit for FM/ATEX Approved Sensor Kit

## 30M CABLE KITS FOR REMOTE KITS

Extended length cables for Output Module and Remote Kits, the standard length provided with the units is 3m. Ideal for applications that require longer distances between the meter and display.

- ▶ Output Cable Kit, 30m for Conditioned Signal Output Module. 3 Core.
- ▶ Remote Cable Kit, 30m for Standard and FM Approved Remote Kits. 2 Core.

PART NUMBER	DESCRIPTION
GP125066-500	GPI Remote Cable Kit (100ft) Belden #9501 - 2 Conductor
GP113272-500	GPI Remote Cable Kit (100ft) Belden #9363 - 3 Conductor



## PULSE ACCESS MODULE

The Pulse Access Module provides an unscaled, digital signal from your GPI meter by accessing circuitry from the on-board computer readout. This kit comes complete, ready to install, with a circuit assembly, coverplate assembly and 10 ft. of cable. The Pulse Access Module requires both a GPI Turbine and an 09/Q9 Computer Electronics which are sold separately. Use with G2 Meters Only.

- ▶ Provides a digital Open Collector signal.
- ▶ Operating temperature range of +14° F to +140° F (-10° C to +60° C)
- ▶ Can transmit signal up to 5,000 ft.
- ▶ Communicates with most digital process control devices and its easy to install.

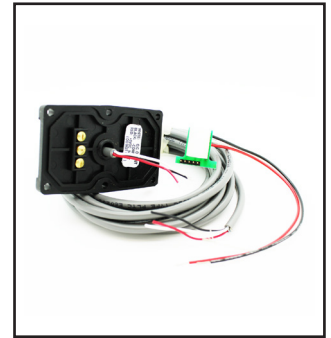

PART NUMBER	DESCRIPTION
GP125060-10	GPI Pulse Out/Ext Power/Scaled Pulse Module - For Q9 Display
GP125060-1	GPI Pulse Out/Ext Power/Scaled Pulse Module - For 09 Display

## 4-20MA MODULE FOR G2

Combine the 4-20 mA Module with an Industrial Grade Turbine and Display Electronics to provide an industry standard analog signal for connection to a wide variety of chart recorders, display equipment and process control equipment. This module outputs an analog signal which is directly proportional to the frequency of the digital output. With some simple adjustments, you can scale the module to represent whatever range is desired (minimum range of 75Hz). Kit comes with circuit, assembly, enclosure and screws.

- ▶ Voltage: 7 to 30 V (dc)
- ▶ Cable: 10 ft. (3 m), Belden #9363



PART NUMBER	DESCRIPTION
GP125100-10	GPI 4-20mA Module Assembly - For Q9 Display
GP125100-1	GPI 4-20mA Module Assembly - For 09 Display

# GPI FLOW METER ACCESSORIES

## CONDUIT ADAPTER KIT

The Conduit Adapter allows you to enclose wiring from the magnetic pickup. The kit includes a turbine meter cover with a 1 inch male NPT conduit fitting and screws for plastic or metal installation.



PART NUMBER	DESCRIPTION
GP113437-01	GPI Conduit Adaptor Kit

## CONDITIONED SIGNAL OUTPUT MODULE

This module provides an unscaled, amplified, digital signal capable of transmission up to 5,000 ft. There is no need for additional signal conditioning or amplification devices to achieve the desired digital signal. Use on G2 "Turbine Only" model. The module is factory assembled for Open Collector signal output and operates from an external 9 to 35 volt power source. By changing terminal connections and adding a battery kit, the module provides a self-powered 6-volt Square Wave signal.



- Connection: Three wire
- Connector: Hubble PG7
- Frequency: 0 to 750 Hz
- Signal Type: Open Collector (NPN)
- Power: External 9 to 35 V (dc), approximately 1 mA

PART NUMBER	DESCRIPTION
GP113435-10	GPI Conditioned Signal Output Module - For Q9 Display
GP113435-1	GPI Conditioned Signal Output Module - For 09 Display

## FM APPROVED REMOTE KIT ASSEMBY

The Factory Mutual (FM) Approved Remote Kit Assembly modifies FLOMEC® Electronic Digital Meters for applications in specialized situations including remote indication and high or low fluid temperature metering applications. This kit provides the versatility of panel mounting of the LCD readout up to 100 ft. (30 m) from the turbine. This kit consists of a sensor module, a dust cover assembly and 10ft. (3 m) of cable. Requires a complete meter with display.



- Magnetic Pickup: 1.3 k Ohm, 90
- Signal Type: Sine Wave
- Cable: 10 ft. (3 m)
- Voltage: Peak to Peak 10 mV to 500 mV
- Frequency: 11 to 750 Hz

PART NUMBER	DESCRIPTION
GP113275-10	GPI FM Approved Remote Kit Assembly - For Q9 Display
GP113275-1	GPI FM Approved Remote Kit Assembly - For 09 Display

## EXTERNAL POWER MODULE

Combine the External Power Module and the GPI Pulse Access Module to provide external power capabilities to a GPI Electronic Digital Meter. The module is designed to provide regulated power to the Computer Electronics. The batteries then become a backup or auxiliary power source. If desired, a pulse output may be accessed. The unscaled, digital signal is capable of transmission up to 5,000 ft. Voltage: 7 to 30 V (dc) @ 1 mA

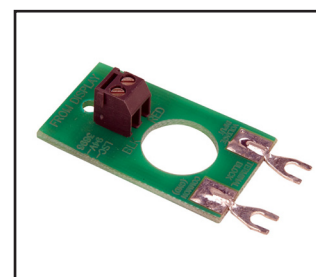

PART NUMBER	DESCRIPTION
GP125070-1	GPI External Power Module - 7 - 30v DC

## TWIN LITHIUM BATTERIES

Replacement battery kit for G2 & A1 flow meters with 09 displays. Please note – these will have to be shipped via courier due to Royal Mail restrictions.



PART NUMBER	DESCRIPTION
GP113520-1	GPI Twin Lithium Battery Replacement Kit

# ADBLUE EQUIPMENT



Dispensing AdBlue (DEF) from either drums or IBC#s can be undertaken by using either a manual or an electric operated pump. We offer a number of solutions for transferring product from storage container to vehicle.

# ADBLUE PUMPS & KITS

## ADBLUE DIAPHRAGM PUMP

We offer the full range of Adblue transfer pumps with all voltages from 12v, 24v, 230v, 110v. Suitable for the transfer of Adblue/Urea. We can supply these pumps individually or as part of various kits.



- ▶ Connection size – 1" BSP, 1" UNF Nose
- ▶ Maximum flow rate of 30 Ltrs Per Min
- ▶ Suitable for – AdBlue
- ▶ Available in 12v, 24v, 110, & 230v

PART NUMBER	DESCRIPTION
AB23030	AdBlue Electric Diaphragm Pump - 230v
AB01230	AdBlue Electric Diaphragm Pump - 12v
AB02430	AdBlue Electric Diaphragm Pump - 24v
AB11030	AdBlue Electric Diaphragm Pump - 110v

## ADBLUE IBC PUMP KITS - AUTOMATIC OR MANUAL

Self priming diaphragm pump mounted on an IBC hanging plate. The pump comes complete with 4m of delivery hose and 1m of suction hose, including SEC adaptor for IBC connection. These pumps are available with automatic or manual nozzle and has the option of adding an inline digital flow meter. **Kit contains: 32plm self priming diaphragm pump, mounting plate, 4m delivery hose, 1m suction hose, choice of manual or automatic nozzle & SEC adaptor for IBC connection.**



- ▶ Connection size – 1" BSP, 1" UNF Nose
- ▶ Maximum flow rate of 30 Ltrs Per Min
- ▶ Choice of Manual or Automatic nozzle
- ▶ Available in 12v, 24v, 110, & 230v

PART NUMBER	DESCRIPTION
AB-IBC1000	AdBlue IBC Pump Kit - Manual Nozzle, 230v
AB-IBC1000-F	AdBlue IBC Pump Kit - Manual Nozzle, 230v C/W Flow Meter
AB-IBC1000-12	AdBlue IBC Pump Kit - Manual Nozzle, 12v
AB-IBC1000-12-F	AdBlue IBC Pump Kit - Manual Nozzle, 12v C/W Flow Meter
AB-IBC1000-24	AdBlue IBC Pump Kit - Manual Nozzle, 24v
AB-IBC1000-24-F	AdBlue IBC Pump Kit - Manual Nozzle, 24v C/W Flow Meter
AB-IBC1000-110	AdBlue IBC Pump Kit - Manual Nozzle, 110v
AB-IBC1000-110-F	AdBlue IBC Pump Kit - Manual Nozzle, v C/W Flow Meter

AB-IBC2000	AdBlue IBC Pump Kit - Automatic Nozzle, 230v
AB-IBC2000-F	AdBlue IBC Pump Kit - Automatic Nozzle, 230v C/W Flow Meter
AB-IBC2000-12	AdBlue IBC Pump Kit - Automatic Nozzle, 12v
AB-IBC2000-12-F	AdBlue IBC Pump Kit - Automatic Nozzle, 12v C/W Flow Meter
AB-IBC2000-24	AdBlue IBC Pump Kit - Automatic Nozzle, 24v
AB-IBC2000-24-F	AdBlue IBC Pump Kit - Automatic Nozzle, 24v C/W Flow Meter
AB-IBC2000-110	AdBlue IBC Pump Kit - Automatic Nozzle, 110v
AB-IBC2000-110-F	AdBlue IBC Pump Kit - Automatic Nozzle, v C/W Flow Meter

## ADBLUE IBC ROTARY HAND PUMP KIT

A rotary hand pump suitable for dispensing adblue, on a panel plate for mounting on an IBC. The system is an Adblue hand pump mounted on a sturdy hanging IBC plate. Kit includes 1m suction pipe with SEC connector, 4m delivery hose, nozzle holster & manual nozzle.

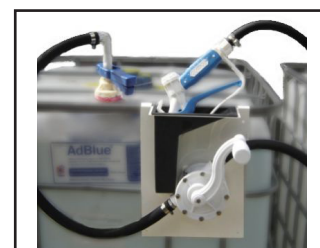

- ▶ Delivery Hose - 3/4" Polipo
- ▶ Maximum flow rate 21 Ltrs Per Min
- ▶ Suction Hose - 3/4" PVC
- ▶ Pump Material - Plastic Polypropelene

PART NUMBER	DESCRIPTION
AB-IBC-RHP	IBC Plate Mounted Rotary Hand Pump

# ADBLUE PUMPS & KITS

## ADBLUE IBC GRAVITY HOSE KIT

This IBC gravity feed kit is perfect accessory pumping AdBlue from your IBC. This IBC gravity hose kit is supplied in a range of hose lengths and is complete with a Manual Nozzle, Cam Fittings and an Adaptor for connecting to an IBC outlet ball valve.

- ▶ 3m, 4m and 5m hose lengths available
- ▶ Suitable for – AdBlue
- ▶ 3/4" manual nozzle with S/S spout
- ▶ Cam fittings and and adaptor or IBC connection



PART NUMBER	DESCRIPTION
GFH3000-IBC-AB	IBC Gravity Feed Hose Kit - 3m
GFH4000-IBC-AB	IBC Gravity Feed Hose Kit - 4m
GFH5000-IBC-AB	IBC Gravity Feed Hose Kit - 5m

## PIUSI ROTARY HAND PUMP FOR ADBLUE

This rotary hand pump for AdBlue, manufactured by Piusi is a cost effective way of transferring AdBlue from a drum. Often used when only low volumes are being dispensed and power is not available for an electric pump.

PART NUMBER	DESCRIPTION
P8-F00332050	Piusi Rotary Hand Pump for Adblue - Drum Adaptor
P8-F00332080	Piusi Rotary Hand Pump for Adblue - c/w Hoses and Drum Adaptor



## ROTARY HAND PUMP FOR ADBLUE

This rotary hand pump for AdBlue, is a cost effective way of transferring AdBlue from a drum. Often used when only low volumes are being dispensed and power is not available for an electric pump.

PART NUMBER	DESCRIPTION
AB-RHP-1000	Rotary Hand Pump for AdBlue w/ Telescopic Suction Tube



## LEVER HAND PUMP FOR ADBLUE

This lever hand pump for AdBlue, is a cost effective way of transferring AdBlue from a drum. Often used when only low volumes are being dispensed and power is not available for an electric pump.

PART NUMBER	DESCRIPTION
AB-CM0500	AdBlue Lever Hand Pump - c/w Suction & Hose
AB-CM2100-A	2" BSP Adaptor to 2" Butress Male Thread (Plastic Drums)



## ROTARY HAND PUMP FOR ADBLUE

This kit comprises of the AdBlue rotary hand pump with telescopic suction pipe, dispensing hose, drum adaptor and stainless steel spout.

PART NUMBER	DESCRIPTION
AB-RHP-KIT	Rotary Hand Pump for AdBlue w/ Telescopic Suction Tube



# ADBLUE NOZZLES

## 3/4" ADBLUE MANUAL NOZZLE

Suitable for use with AdBlue. Plastic Polypropylene bodied manual nozzle with stainless steel spout. 3/4" Hosetail connection and viton seals to protect against aggressive fluids.

PART NUMBER	DESCRIPTION
TN6000-AB	Manual 3/4" AdBlue Nozzle
TN7000-AB	Manual 3/4" AdBlue Nozzle w/ Blue Soft Grip





# ADBLUE NOZZLES

## 3/4" ADBLUE AUTOMATIC NOZZLE

100% compatible with Adblue. Stainless steel body and spout, with a max flow rate of 40lpm. Also can be used with solvents and corrosive mediums.

PART NUMBER	DESCRIPTION
M3700-ABSS	AdBlue 3/4" BSPF Stainless Steel Nozzle



## 3/4" HOSETAIL ADBLUE AUTOMATIC NOZZLE - PLASTIC BODY

100% compatible with Adblue. Plastic body and S/S spout, with a max flow rate of 40lpm. Also can be used with solvents and corrosive mediums.

PART NUMBER	DESCRIPTION
M3700-AB	AdBlue 3/4" Hosetail Plastic Nozzle - 5-40lpm



## ADBLUE NOZZLE ACTUATION MAGNET

Magnet actuator for stainless steel nozzles for Adblue dispensing. When used in conjunction with an Adblue nozzle which is fitted with a magnetic spout, the collar prevents your AdBlue dispensing pump from being able to dispense DEF/AdBlue into anything other than the AdBlue tank.

PART NUMBER	DESCRIPTION
M3700-ABSS- MAGNET	Automatic Dispensing Nozzle Actuation Magnet

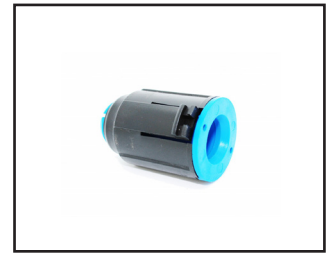

# ADBLUE FLOW METERS

## GPI ECONOMY WATER FLOW METER

Sturdy, small and simple Electronic Digital Water Meter with solid nylon housing, complete meter including turbine assembly, microprocessor and LCD readout. Works well on any pump or gravity feed system with at least 3-30 GPM (10-100lpm) flow range.

PART NUMBER	DESCRIPTION
GP113255-6	GPI 01N52LM 1" Nylon Flow Meter - 100lpm



## PIUSI K24 ADBLUE METER

Digital Turbine Meter, compact easy readable display. Display can be rotated in 4 different positions.

- ▶ **Counter** - 5 Digit Partial and 6 Digit Totaliser
- ▶ **Connections** - 1" M BSP Inlet/Outlet c/w Socket
- ▶ **Accuracy** - +/- 1%
- ▶ **Display** - LCD electronic display (2 x AAA batteries)
- ▶ **Flow Rate** - 6-100ltrs Per Min
- ▶ **Pressure** - 10 Bar / 145 PSI
- ▶ **Max Working Temperature** - -10°C / +50°C
- ▶ **Fluid Viscosity** - 2.5 - 3.5 CST

PART NUMBER	DESCRIPTION
P8-F0040710A	1" BSP Male Piusi K24 AdBlue Flow Meter



# ADBLUE HOSE

## ADBLUE COMPATIBLE HOSE 3/4"

3/4" diameter soft PVC hose with Polyurethane underlayer with polyester yarn reinforcement and PU adhesive middle layer, for pressurized transfer oil, diesel oil, blue diesel and urea.

- ▶ **Outer Diameter for 3/4"** - 26mm
- ▶ **Working Pressure for 3/4"** - 15 Bar
- ▶ **Burst Pressure** - 45 Bar

PART NUMBER	DESCRIPTION
GFH3550-POL	3/4" AdBlue Delivery Hose - Per Meter
GFH3550-AB	3/4" AdBlue Suction Hose - Per Meter
GFH3550-PVC	3/4" AdBlue Blue PVC Hose - Per Meter



# DRY BREAK COUPLINGS

**WHAT IS A DRYBREAK COUPLING?** - A dry break coupling (also called a dry connect or a dry disconnect coupling) is a fitting that features an automatic mechanism to seal off both ends of a line when the hose is disconnected. On disconnection both the hose and tank units close automatically and spill free disconnection is achieved.

Drybreak couplings can be used most applications where the transfer where fluids are hazardous, toxic, corrosive or flammable. This off course includes bulk fluid transfer application such as loading and unloading of tank truck, rail road, special boats, bunkering and also you can use in Paint and Ink Industries.

## ATKINSON DRYBREAK COUPLING - 2"

The Atkinson dry break coupling for AdBlue is designed to open and close automatically when the delivery hose is connected and disconnected. The valve insures minimum liquid loss on disconnection even if connected or disconnected whilst filling is in progress.

- ▶ 2" BSP Female Thread
- ▶ EPDM Seal
- ▶ For Tanks up to 10,000 Litres
- ▶ 304 Stainless Steel
- ▶ 10 Bar Working Pressure



PART NUMBER	DESCRIPTION
DBC-1000	Dry Break Coupling 2" Stainless Steel
DBC-DUSTCOVER	Dust Cover for DBC-1000
MF3232-MM-S	2" Stainless Steel Male Nipple
MF3232-MF-90-S	2" Stainless Steel Male - Female 90 degree
MF3232-FF-90-S	2" Stainless Steel Female - Female 90 degree
MF3232-FF-45-S	2" Stainless Steel Female - Female 45 degree

## TODO-MATIC DRYBREAK COUPLING TANK UNIT - 3"

119mm TODO Tank Unit 3 BSP Fm St/St c/w Viton Seal for safe fluid handling. Designed for safe and easy with minimum operator intervention. TODO-MATIC couplings offer an unbeatable combination of technical, safety and performance features.

- ▶ Valves open and close automatically on connection and disconnection
- ▶ Reduces spillages to virtually zero
- ▶ Simple single action operation, no levers or switches to operate



PART NUMBER	DESCRIPTION
DB-5531X-4407	TODO 3" BSP Female Tank Unit

## TODO-MATIC DRYBREAK COUPLING HOSE UNIT - 2"

70mm TODO Hose Unit 2 BSP Fm St/St c/w Viton seals for safe fluid handling. Designed for safe and easy with minimum operator intervention. TODO-MATIC couplings offer an unbeatable combination of technical, safety and performance features.

- ▶ Valves open and close automatically on connection and disconnection
- ▶ Reduces spillages to virtually zero
- ▶ Simple single action operation, no levers or switches to operate



PART NUMBER	DESCRIPTION
DB-9200G-4407	TODO 2" BSP Female Hose Unit

## TODO-MATIC DRYBREAK COUPLING HOSE UNIT - 3"

119mm TODO Hose Unit 3 BSP Fm St/St c/w Viton seal for safe fluid handling. Designed for safe and easy with minimum operator intervention. TODO-MATIC couplings offer an unbeatable combination of technical, safety and performance features.

- ▶ Valves open and close automatically on connection and disconnection
- ▶ Reduces spillages to virtually zero
- ▶ Simple single action operation, no levers or switches to operate



PART NUMBER	DESCRIPTION
DB-9200G-4407	TODO 2" BSP Female Hose Unit

# ADBLUE FITTINGS

We stock a wide range of AdBlue fittings, including hose tails, swivel joints, non return valves, and adaptors to suit your application and installation.

PART NUMBER	DESCRIPTION
GV3934-SS	3/4" Non Return Valve - Stainless Steel
GV3934-FO	3/4" Non Return Valve - Strainer Only
M3700-ABSS-BR1BSP	Breakaway Swivel, S/S - 1"F - 3/4"M BSP
M3700-ABSS-BR3/4BSP	Breakaway Swivel, S/S - 3/4"F - 3/4"M BSP
M3700-ABSS-SW07TAIL	Swivel Hose Tail, 3/4"M - 19mm Hose Barb
AB230-PP-TAIL	Plastic Hosetail 3/4" to 1" BSPM
AB230-PP-90	90 Degree 1"M to 1"F Threaded Coller
AB230-PP-MM	1" M - M Adaptor
P8-F16073000	1" Female to Female Adaptor Stainless Steel
AB230-PP-90-FF	1" 90 Degree Elbow with "O" Rings
AB-IBC-SEC	IBC Suction Coupling SEC/CDS
AB-IBC-SUCTION	SEC/CDS IBC Suction Pipe & Connection for SEC Coupling
AB230-PP-F-TAIL	AdBlue Polypropylene Hose Tail 1" BSPF Collar,



# PIPE & MISCELLANEOUS FITTINGS

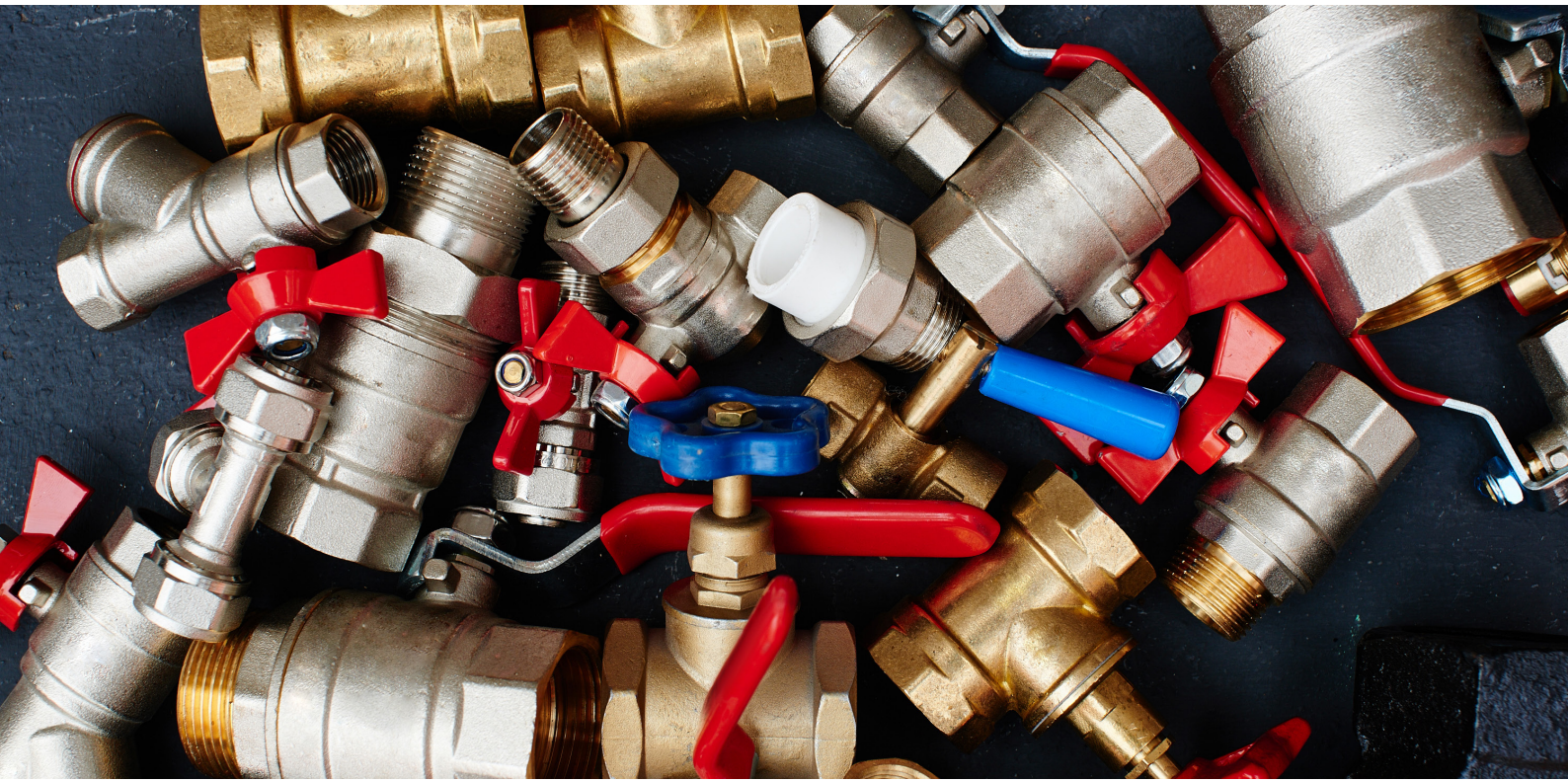

This section contains pipe fittings, gate and ball valves and other miscellaneous spares.

# PRESSURE RELIEF VALVES

## ADJUSTABLE NYLON BODY

A pressure relief valve is a valve used to control or limit the pressure in a system, which can build up due to a process upset, instrument or equipment failure. The pressure is relieved by allowing the fluid to escape through the valve and then through an auxiliary passage out of the system back into the supply tank.

- ▶ **Inlet** - 3/4" NPT Male Thread
- ▶ **Outlet** - 3/4" NPT Female Thread
- ▶ **Max Working Temperature** - 60°C
- ▶ **Pressure Range** - 0-14 Bar / 0-203 PSI
- ▶ **Max Working Pressure** - 17 Bar / 246 PSI



PART NUMBER	DESCRIPTION
GV3924	3/4" NPT Nylon Bodied Pressure Relief Valve
GV3924-PP	3/4" BSP M/M, 60°C Max, PP Body, Viton Seal, SS Sprng, 10 Bar Pressure Relief Valve

## ADJUSTABLE BRONZE BODY

A pressure relief valve is a valve used to control or limit the pressure in a system, which can build up due to a process upset, instrument or equipment failure. The pressure is relieved by allowing the fluid to escape through the valve and then through an auxiliary passage out of the system back into the supply tank.

- ▶ **Inlet** - 3/4" NPT Male Thread
- ▶ **Outlet** - 3/4" NPT Female Thread
- ▶ **Max Working Temperature** - 80°C
- ▶ **Pressure Range** - 0-27.5 Bar / 0-203 PSI
- ▶ **Max Working Pressure** - 27 Bar / 400 PSI



PART NUMBER	DESCRIPTION
GV3924-30	3/4" NPT Bronze Bodied Pressure Relief Valve - Reccomend Higher Pressures Only
MF1212N-FM-B	3/4" NPT Female to 3/4" BSP Male Hex Adaptor - Brass
MF1212N-MF-B	3/4" NPT Male to 3/4" BSP Female Hex Adaptor - Brass

# GLUES & THREAD SEALING

## HELDITE & BONDLOC

There are various products that are used for sealing the threads when screwing fuel products together – this depends to some degree on the size of the thread and the strength of the bond required.

We carry a number of sealants from Bondloc in 250 ml containers (complete with spout) such as B243 Nutloc (medium strength) and B270 Threadloc (high strength).

We can supply Heldite, Bondloc and PTFE tape in convenient sizes.



PART NUMBER	DESCRIPTION
M5001	Heldite - General Purpose Sealant, 7ml
M5005	Heldite - General Purpose Sealant, 125ml
M5010	Heldite - General Purpose Sealant, 250ml
M2370	Bondloc B243 Nutloc - Medium Strength Sealant, 250ml
M2355	Bondloc B270 Threadloc, High Strength Sealant, 250ml
M5020	Roll of PTFE Tape

# BALL VALVES & GATE VALVES

## LEVER BALL VALVES - F/F BSP

BSP Female to Female ports, plated brass body and vinyl coated on/off lever. These are available in all sizes. All those listed are British Gas approved for use in gas systems.



PART NUMBER	DESCRIPTION
GV3641	1/4" F/F BSP Lever Ball Valves
GV3643	1/2" F/F BSP Lever Ball Valves
GV3644	3/4" F/F BSP Lever Ball Valves
GV3645	1" F/F BSP Lever Ball Valves
GV3660	2" F/F BSP Lever Ball Valves
SG2091	1/4" Micro Ball Valve - M/F
SG2091-04-FF	1/4" Micro Ball Valve - F/F

# BALL VALVES & GATE VALVES

## T HANDLE BALL VALVE

2024-1980, 1" BSP Ball valve F/F  
T-Handle Red

PART NUMBER	DESCRIPTION
GV3645-TF	1" T Handle Ball Valve



## GATE VALVES

BSP Female to Female ports, brass body and painted steel on/off handwheel. These are available in several sizes. A 1" Control Valve is also available (the handwheel can be orientated to face towards you, rather than being on the top, with the outlet facing straight down).

PART NUMBER	DESCRIPTION
GV3530	1" BSP F/F Brass Gate Valve w/ Painted Steel On/Off Wheel
GV3640	1" BSP F/F Brass Gate Valve c/w Locking Bracket



# MISCELLANEOUS PIPE FITTINGS

## EQUAL NIPPLES - M/M - MALLEABLE IRON

PART NUMBER	DESCRIPTION
MF1616-MM	1" M/M Equal Nipple - Malleable Iron
MF3232-MM	2" M/M Equal Nipple - Malleable Iron

## EQUAL NIPPLES - M/M - BRASS

TL6010	1/4" M/M Equal Nipple - Brass
MF1616-MM-B	1" M/M Equal Nipple - Brass
MF1616N-MM-B	1inNPT*1inBSPT M/M EQUAL CONNECTOR BRASS

## EQUAL NIPPLES - M/M - 316 STAINLESS STEEL

MF3232-MM-S	2" M/M Equal Nipple - 316 Stainless Steel
-------------	---

## REDUCING NIPPLES - M/M - MALLEABLE IRON

PART NUMBER	DESCRIPTION
MF1612-MM	1" to 3/4" M/M Reducing Nipple - Malleable Iron

## REDUCING NIPPLES M/M - BRASS

MF0604-MM-B	3/8" to 1/4" M/M Reducing Nipple - Brass
MF1612-MM-B	1" to 3/4" M/M Reducing Nipple - Brass

## REDUCING BUSHES - M/F - MALLEABLE IRON

PART NUMBER	DESCRIPTION
MF1208-MF	3/4" to 1/2" M/F Reducing Bush - Malleable Iron
MF1608-MF	1" - 1/2" M/F Reducing Bush - Malleable Iron
MF1612-MF	1" to 3/4" M/F Reducing Bush - Malleable Iron

## REDUCING BUSHES - M/F - BRASS

PART NUMBER	DESCRIPTION
MF1208-MF-B	3/4" to 1/2" M/F Reducing Bush - Brass
MF1612-MF-B	1" to 3/4" M/F Reducing Bush - Brass

# MISCELLANEOUS PIPE FITTINGS

## EQUAL 90° ELBOWS - F/F - MALLEABLE IRON

PART NUMBER	DESCRIPTION
-------------	-------------

MF1616-FF-90	1" F/F Equal 90° Elbow - Malleable Iron
--------------	---

## EQUAL 90° ELBOWS - M/F - MALLEABLE IRON

PART NUMBER	DESCRIPTION
-------------	-------------

GFH3525	1" M/F Equal 90° Elbow - Malleable Iron
MF3232-MF-90	2" M/F Equal 90° Elbow - Malleable Iron

## EQUAL 90° ELBOWS - M/F - 316 STAINLESS STEEL

PART NUMBER	DESCRIPTION
-------------	-------------

MF3232-MF-90-S	2" M/F Equal 90° Elbow - 316 S/S
----------------	----------------------------------

## EQUAL 45° ELBOWS - F/F - 316 STAINLESS STEEL

PART NUMBER	DESCRIPTION
-------------	-------------

MF3232-FF-45-S	2" F/F Equal 45° Elbow - 316 S/S
----------------	----------------------------------

## COMPRESSION FITTINGS

PART NUMBER	DESCRIPTION
-------------	-------------

GFH3541	10mm - 8mm Straight Compression
MF101010-CCC-B	10mm T (10x10x10) Compression
GFH3530	10mm - 10mm Straight Compression
MF1004-CM-90-B	10mm - 1/4" 90° Compression
MF1008-CM-B	10mm - 1/2" Straight Compression
MF1006-CM-B	10mm - 3/8" Straight Compression
GFH3540	3/8" - 15mm Straight Compression
MFM1010-MM-90B	10mm - 10mm 90° Compression



COMPANY QUALITY MANAGEMENT

# APPLICATION FOR A CREDIT ACCOUNT AF022

(PLEASE USE WITH AF008 - TERMS & CONDITIONS FOR THE SUPPLY OF GOODS)

To open an account with Atkinson Equipment Limited, please provide the following information:

COMPANY NAME:							
TRADING ADDRESS:				POSTCODE:			
REGISTERED OFFICE: (If different to the above)				POSTCODE:			
TELEPHONE:		FAX:		EMAIL:			
YEARS TRADING?		DATE OF INCORPORATION:					
COMPANY REGISTRATION NUMBER:							
ARE YOU A SOLE TRADER?		YES	NO	PARTNERSHIP?		YES	NO
If sole trader/partnership, please give the name of the proprietors or partners:							
NAME/ADDRESS:				POSTCODE:			
NAME/ADDRESS:				POSTCODE:			
To make trading with us more efficient, please advise the following:							
To whom and where should invoices be posted?							
Who is responsible for the payment of your account?							
Who is responsible for buying in your company?							
YOUR BANK NAME & ADDRESS:							
						POSTCODE:	

BUSINESS REFERENCE (1)				BUSINESS REFERENCE (2)			
		POSTCODE:				POSTCODE:	
TEL:		EMAIL:		TEL:		EMAIL:	

Please state the nature of your business by ticking the appropriate boxes below:

Heating / Plumbing	<input type="checkbox"/>	Agricultural	<input type="checkbox"/>	Storage Tanks	<input type="checkbox"/>	Fuel based	<input type="checkbox"/>
Hydraulic & Hose	<input type="checkbox"/>	Commercial	<input type="checkbox"/>	Industrial	<input type="checkbox"/>	Other	<input type="checkbox"/>
If Other, please list your primary business here:							

**PLEASE NOTE: Payment is due 30 days from the end of the month of invoice.** Failing to comply with these terms will result in the suspension of your account and the possible withdrawal of your credit account facility, making the total account balance upon demand.

APPLICANT SIGNATURE:	
PLEASE PRINT NAME:	

DATE:	
POSITION:	



# GENERAL BUSINESS TERMS & CONDITIONS

## ATKINSON EQUIPMENT LIMITED - TERMS & CONDITIONS FOR THE SUPPLY OF GOODS

In these conditions, the following definitions apply:

**"BACK END DEFECTS"** means surface defects caused during the manufacture of the material.

**"BUSINESS DAY"** means a day (other than a Saturday, Sunday or public holiday) when banks in London are open for business;

**"BESPOKE GOODS"** means the goods manufactured by the Supplier in accordance with the Specification;

**"CONDITIONS"** means the terms and conditions set out in this document, as amended from time to time in accordance with clause 11.3;

**"CONTRACT"** means the contract between the Supplier and the Customer for the sale and purchase of the Goods in accordance with these Conditions and the Order;

**"CUSTOMER"** means the person or firm who purchases the Goods from the Supplier;

**"DELIVERY LOCATION"** means the location set out in the Order or such other location as the parties may agree from time to time;

**"FORGE MAJEURE EVENT"** means any event, circumstance or cause beyond a party's reasonable control, including, without limitation: acts of God, flood, drought, earthquake or other natural disaster; epidemic or pandemic; COVID-19; terrorist attack, civil war, civil commotion or riots, war, threat of or preparation for war, armed conflict, imposition of sanctions, embargo, or breaking off of diplomatic relations; nuclear, chemical or biological contamination or sonic boom; any law or any action taken by a government or public authority, including without limitation imposing an export or import restriction, quota or prohibition, or failing to grant a necessary licence or consent; collapse of buildings, fire, explosion or accident; any labour or trade dispute, strikes, industrial action or lockouts; non-performance by suppliers or subcontractors; and interruption or failure of utility service.

**"GOODS"** means the goods, including the Bespoke Goods (or any part of them), set out in the Order;

**"ORDER"** means the Customer's order for the Goods, as set out in the Customer's written or verbal acceptance of the Supplier's quotation;

**"SPECIFICATION"** any specification for the Goods, including any related plans and drawings, that is provided by the Customer to the Supplier; and

**"SUPPLIER"** means Atkinson Equipment Limited, a private company limited by shares and incorporated in England and Wales with company number 01050233

### 1.2 INTERPERTATION

- (a) A person includes a natural person, corporate or unincorporated body (whether or not having separate legal personality).
- (b) A reference to a party includes its personal representatives, successors and permitted assigns.
- (c) A reference to a statute or statutory provision is a reference to it as amended or re-enacted. A reference to a statute or statutory provision includes all subordinate legislation made under that statute or statutory provision.
- (d) Any words following the terms including, include, in particular, for example or any similar expression shall be construed as illustrative and shall not limit the sense of the words, description, definition, phrase or term preceding those terms.
- (e) A reference to writing or written includes fax and email.

### 2. BASIS OF CONTRACT

- 2.1** These Conditions apply to the Contract to the exclusion of any other terms that the Customer seeks to impose or incorporate, or which are implied by trade, custom, practice or course of dealing.
- 2.2** The Order constitutes an offer by the Customer to purchase the Goods in accordance with these Conditions. The Customer is responsible for ensuring that the terms of the Order and the Specification (if applicable) are complete and accurate.
- 2.3** The Order shall only be deemed accepted when the Supplier acknowledges acceptance of the Order either orally or in writing, at which point the Contract shall come into existence.
- 2.4** The Customer acknowledges that it has not relied on any statement, promise, representation, assurance or warranty made or given by or on behalf of the Supplier which is not set out in the Contract.
- 2.5** Any samples, drawings, descriptive matter, or advertising produced by the Supplier and any descriptions or illustrations contained in the Supplier's website, catalogues or brochures are produced for the sole purpose of giving an approximate idea of the Goods described in them. They shall not form part of the Contract or have any contractual force.
- 2.6** A quotation for the Goods given by the Supplier shall not constitute an offer. A quotation shall only be valid for a period of 3 days from its date of issue.

### 3. GOODS

- 3.1** The Goods are described in the Supplier's website, catalogues, brochures or the Specification.
- 3.2** To the extent that the Goods are to be manufactured by the Supplier in accordance with a Specification supplied by the Customer, the Customer shall indemnify the Supplier against all liabilities, costs, expenses, damages and losses (including any direct, indirect or consequential losses, loss of profit, loss of reputation and all interest, penalties and legal and other reasonable professional costs and expenses) suffered or incurred by the Supplier in connection with any claim made against the Supplier for actual or alleged infringement of a third party's intellectual property rights arising out of or in connection with the Supplier's use of the Specification. This clause 3.2 shall survive termination or expiry of the Contract.
- 3.3** The Supplier reserves the right to amend the specification of the Goods or the Specification of the Bespoke Goods if required by any applicable statutory or regulatory requirements or in line with any manufacturer's amendments.
- 3.4** The Supplier may, at the request of the Customer, provide technical written or oral advice to the Customer regarding use of the Goods, provided that such advice is given at the Customer's sole risk and the Supplier shall not be liable for any loss, damage or claim arising there from.

### 4. DELIVERY & CARRIAGE

- 4.1** The Supplier shall deliver the Goods to the Delivery Location at any time after the Supplier notifies the Customer that the Goods are ready.
- 4.2** Delivery of the Goods shall be completed on the Goods' arrival at the Delivery Location. Any dates quoted for delivery are approximate only, and the time of delivery is not of the essence of the Contract.
- 4.3** The Supplier shall not be liable for any delay in delivery of the Goods that is caused by a Force Majeure Event or the Customer's failure to provide the Supplier with adequate delivery instructions or any other instructions that are relevant to the supply of the Goods.
- 4.4** If the Supplier fails to deliver the Goods, its liability shall be limited to the cost of the Goods. The Supplier shall have no liability for any failure to deliver the Goods to the extent that such failure is caused by a Force Majeure Event or the Customer's failure to provide the Supplier with adequate delivery instructions or any other instructions that are relevant to the supply of the Goods.
- 4.5** If the Goods were damaged prior to arrival at the Delivery Location, the Customer must notify the Supplier in writing within three Business Days of the delivery.
- 4.6** If the Supplier delivers up to and including 5% more or less than the quantity of Goods ordered the Customer may not reject them, but on receipt of notice from the Customer that the wrong quantity of Goods was delivered, a pro rata adjustment shall be made to the Order invoice.
- 4.7** The Supplier may deliver the Goods in installments, which shall be invoiced and paid for separately. Any delay in delivery or defect in an instalment shall not entitle the Customer to reject them or cancel any other instalment.
- 4.8** Where the Goods are intended for international delivery:
  - (a) the Goods only comply with UK laws, regulations or standards, unless the Supplier states otherwise. It is the responsibility of the Customer to check the Goods comply with any relevant country specific standards.

# GENERAL BUSINESS TERMS & CONDITIONS

---

## 4. DELIVERY & CARRIAGE

---

- (b) the Goods only comply with UK laws, regulations or standards, unless the Supplier states otherwise. It is the responsibility of the Customer to check the Goods comply with any relevant country specific standards;
- (c) the Customer will be responsible for payment of any such import duties and taxes and the Customer should contact their local customs office for further information before placing an Order;
- (d) the Customer must comply with all applicable laws and regulations of the country for which the Goods are destined. The Supplier accepts not liability for the Customer breaking any such law.

## 5. WARRANTY & CLAIMS

---

**5.1** The Supplier warrants that on delivery, and for the period outlined in the manufactures warranty provided with the Goods or 12 months in respect of the Bespoke Goods manufactured by the Supplier, the Goods shall:

- (a) conform with their description and any applicable Specification; and
- (b) be free from material defects in design, material and workmanship

**5.2** Subject to clause **5.4**, if:

- (a) the Customer gives notice in writing to the Supplier during the warranty period within a reasonable time of discovery that some or all of the Goods do not comply with the warranty set out in clause **5.1**;
- (b) the Supplier is given a reasonable opportunity of examining such Goods; and
- (c) subject to clause **5.3**, the Customer (if asked to do so by the Supplier) returns such Goods to the Supplier's place of business at the Customer's cost, the Supplier shall, at its option, repair or replace the defective Goods, or refund the price of the defective Goods in full.

**5.3** Prior to any return of the Goods, the Customer must obtain authorisation from the Supplier via email or telephone.

**5.4** The Supplier shall not be liable for the Goods' failure to comply with the warranty set out in clause **5.1** in any of the following circumstances:

- (a) the Customer makes any further use of such Goods after giving notice in accordance with clause **5.2**;
- (b) the defect arises because the Customer failed to follow the Supplier's oral or written instructions as to the storage, commissioning, installation, use and maintenance of the Goods or (if there are none) good trade practice regarding the same;
- (c) the defect arises as a result of the Supplier following the drawing, design or specification supplied by the Customer;
- (d) the Customer alters or repairs such Goods without the written consent of the Supplier;
- (e) the defect arises as a result of fair wear and tear, wilful damage, negligence, or abnormal storage or working conditions; or
- (f) the Goods differ from their description or the Specification as a result of changes made to ensure they comply with applicable statutory or regulatory requirements.

**5.5** For the avoidance of doubt, the following is not covered by the applicable warranty set out in clause **5.1**, the natural characteristics of the materials used to manufacture the Goods (including but not limited to grain, colour variations, cracks, holes and flaws due to the manufacture of the material e.g. Back End Defects) will not be accepted as a defect.

**5.6** Except as provided in this clause **5**, the Supplier shall have no liability to the Customer in respect of the Goods' failure to comply with the warranty set out in clause **5.1**.

**5.7** The terms implied by sections **13** to **15** of the Sale of Goods Act 1979 are, to the fullest extent permitted by law, excluded from the Contract.

**5.8** These Conditions shall apply to any repaired or replacement Goods supplied by the Supplier.

## 6. TITLE & RISK

---

**6.1** The risk in the Goods shall pass to the Customer upon completion of delivery.

**6.2** Title to the Goods shall not pass to the Customer until the Supplier receives payment in full (in cash or cleared funds) for the Goods and any other goods that the Supplier has supplied to the Customer in respect of which payment has become due, in which case title to the Goods shall pass at the time of payment of all such sums.

**6.3** Until title to the Goods has passed to the Customer, the Customer shall:

- (a) store the Goods separately from all other goods held by the Customer so that they remain readily identifiable as the Supplier's property;
- (b) not remove, deface or obscure any identifying mark or packaging on or relating to the Goods;
- (c) maintain the Goods in satisfactory condition and keep them insured against all risks for their full price from the date of delivery;
- (d) notify the Supplier immediately if it becomes subject to any of the events listed in clause 8.2; and
- (e) give the Supplier such information relating to the Goods as the Supplier may require from time to time.

**6.4** Subject to clause **6.5**, the Customer may resell or use the Goods in the ordinary course of its business (but not otherwise) before the Supplier receives payment for the Goods. However, if the Customer resells the Goods before that time:

- (a) it does so as principal and not as the Supplier's agent; and
- (b) title to the Goods shall pass from the Supplier to the Customer immediately before the time at which resale by the Customer occurs.

**6.5** If before title to the Goods passes to the Customer, the Customer becomes subject to any of the events listed in clause **8.2**, then, without limiting any other right or remedy the Supplier may have:

- (a) the Customer's right to resell the Goods or use them in the ordinary course of its business ceases immediately; and
- (b) the Supplier may at any time:
  - (i) require the Customer to deliver up all Goods in its possession which have not been resold, or irrevocably incorporated into another product; and
  - (ii) if the Customer fails to do so promptly, enter any premises of the Customer or of any third party where the Goods are stored in order to recover them.

## 7. PRICE & PAYMENT

---

**7.1** The price of the Goods shall be the price set out in the Order.

**7.2** The Supplier may, at any time before delivery, increase the price of the Goods to reflect any increase in the cost of the Goods that is due to:

- (a) any factor beyond the Supplier's control (including foreign exchange fluctuations, increases in taxes and duties, and increases in labour, materials and other manufacturing costs);
- (b) any request by the Customer to change the delivery date(s), quantities or types of Goods ordered, or the Specification thereof; or
- (c) any delay caused by any instructions of the Customer or failure of the Customer to give the Supplier adequate or accurate information or instructions.

# GENERAL BUSINESS TERMS & CONDITIONS

---

## 7. PRICE & PAYMENT

7.3 The price of the Goods:

- (a) unless the Order states otherwise, includes the costs and charges of packaging, insurance and transport of the Goods, which shall be invoiced to the Customer; and
- (b) excludes amounts in respect of value added tax ("VAT"), which the Customer shall additionally be liable to pay to the Supplier at the prevailing rate, subject to the receipt of a valid VAT invoice.

7.4 Payment for the Goods must be in advance (i.e. on placing the Order), in full and in cleared funds, of the delivery to the bank account nominated by the Supplier or via credit or debit card. In the case of a Customer with a credit account, payment shall be in accordance with the credit terms agreement between the parties. Time for payment shall be of the essence of the Contract.

7.5 The Supplier reserves the right to claim interest, compensation and reasonable costs under the Late Payment of Commercial Debts (Interest) Act 1998 ("the Act") and it is agreed that the term implied by that Act shall apply after any judgment as well as before. If for any reason the Act does not apply interest shall be payable on overdue amounts at 8% over the Bank of England Base Rate from time to time, but at 8% a year for any period when the base rate is below 0%.

7.6 The Customer shall pay all amounts due under the Contract in full without any set-off, counterclaim, deduction or withholding (except for any deduction or withholding required by law). The Supplier may at any time, without limiting any other rights or remedies it may have, set-off any amount owing to it by the Customer against any amount payable by the Supplier to the Customer.

## 8. TERMINATION & SUSPENSION

8.1 If the Customer becomes subject to any of the events listed in clause 8.2, without limiting its other rights or remedies, the Supplier may terminate the Contract with immediate effect by giving written notice to the Customer.

8.2 For the purposes of clause 8.1, the relevant events are:

- (a) the Customer fails to pay any amount due under the Contract on the due date for payment and remains in default not less than 14 days after being notified to make such payment;
- (b) the Customer commits a material breach of any term of the Contract and (if such breach is remediable) fails to remedy that breach within 14 days of that party being notified in writing to do so;
- (c) the Customer suspends, or threatens to suspend, payment of its debts, or admits inability to pay its debts, or (being a company or limited liability partnership) is deemed unable to pay its debts within the meaning of section 123 of the Insolvency Act 1986, or (being a sole trader) is deemed either unable to pay its debts or as having no reasonable prospect of so doing, in either case, within the meaning of section 268 of the Insolvency Act 1986, or (being a partnership) has any partner to whom any of the foregoing apply;
- (d) a petition is filed, a notice is given, a resolution is passed, or an order is made, for or in connection with the winding up of the other party (being a company, limited liability partnership or partnership);
- (e) an application is made to court, or an order is made, for the appointment of an administrator, or a notice of intention to appoint an administrator is given or an administrator is appointed, over the Customer (being a Company);
- (f) the Customer's financial position deteriorates to such an extent that in the Supplier's opinion the Customer's capability to adequately fulfil its obligations under the Contract has been placed in jeopardy; and
- (g) (being a sole trader) the Customer dies or, by reason of illness or incapacity (whether mental or physical), is incapable of managing his or her own affairs or becomes a patient under any mental health legislation.

8.3 If the Customer becomes subject to any of the events listed in clause 8.2(a) to clause 8.2(g), or the Supplier reasonably believes that the Customer is about to become subject to any of them, then the Supplier may, without limiting its other rights or remedies:

- (a) the Supplier may suspend provision of the Goods under the Contract or any other contract between the Customer and the Supplier;
- (b) terminate the Contract or any other contract between the Customer and the Supplier with immediate effect by giving written notice to the Customer; and/or
- (c) require payment upon or in advance of delivery in respect of any undelivered Goods.

8.4 On termination of the Contract for any reason the Customer indemnifies the Supplier in respect of all costs and expenses (including, but not limited to, any legal costs or disbursements) incurred for or on behalf of the Supplier in enforcing its rights under this clause 8.

8.5 On termination of the Contract for any reason the Customer shall immediately pay to the Supplier all of the Supplier's outstanding unpaid invoices and interest and, in respect of Goods supplied but for which no invoice has been submitted, the supplier shall submit an invoice, which shall be payable by the Customer immediately on receipt.

8.6 Termination or expiry of the Contract, however arising, shall not affect any of the parties' rights, remedies, obligations and liabilities that have accrued as at termination.

8.7 Clauses which expressly or by implication survive termination or expiry of the Contract shall continue in full force and effect.

## 9. LIMITATION OF LIABILITY

9.1 The restrictions on liability in this clause 9 apply to every liability arising under or in connection with the Contract including liability in contract, tort (including negligence), misrepresentation, restitution or otherwise.

9.2 Nothing in the Contract limits any liability which cannot legally be limited, including liability for:

- (a) death or personal injury caused by its negligence, or the negligence of its employees, agents or subcontractors (as applicable);
- (b) fraud or fraudulent misrepresentation;
- (c) breach of the terms implied by section 12 of the Sale of Goods Act 1979;
- (d) defective products under the Consumer Protection Act 1987; or
- (e) any matter in respect of which it would be unlawful for the Supplier to exclude or restrict liability.

9.3 Subject to clause 9.2:

- (a) the Supplier shall under no circumstances whatsoever be liable to the Customer, whether in contract, tort (including negligence) for: loss of profit; loss of sales or business; loss of agreements or contracts; loss of anticipated savings; loss of or damage to goodwill; loss of use or corruption of software, data or information; and indirect or consequential loss arising under or in connection with the Contract; and
- (b) the Supplier's total liability to the Customer in respect of all other losses arising under or in connection with the Contract, whether in contract, tort (including negligence), breach of statutory duty, or otherwise, shall in no circumstances exceed the price of the Goods ordered to which the claim relates.

## 10. FORCE MAJEURE

Neither party shall be in breach of this Contract nor liable for delay in performing, or failure to perform, any of its obligations under this Contract if such delay or failure result from a Force Majeure Event. If the period of delay or non-performance continues for four weeks, the party not affected may terminate this Contract by giving 14 days written notice to the affected party.

# GENERAL BUSINESS TERMS & CONDITIONS

## 11. GENERAL

### 11.1 Assignment and other dealings.

- (a) The Supplier may at any time assign, transfer, mortgage, charge, subcontract or deal in any other manner with all or any of its rights or obligations under the Contract.
- (b) The Customer may not assign, transfer, mortgage, charge, subcontract, declare a trust over or deal in any other manner with any or all of its rights or obligations under the Contract without the prior written consent of the Supplier.

### 11.2 Entire agreement.

- (a) This Contract constitutes the entire agreement between the parties and supersedes and extinguishes all previous agreements, promises, assurances, warranties, representations and understandings between them, whether written or oral, relating to its subject matter.
- (b) Each party agrees that it shall have no remedies in respect of any statement, representation, assurance or warranty (whether made innocently or negligently) that is not set out in the Contract. Each party agrees that it shall have no claim for innocent or negligent misrepresentation or negligent misstatement based on any statement in the Contract.

### 11.3 Variation. No variation of this Contract shall be effective unless it is in writing and signed by the parties (or their authorised representatives).

### 11.4 Waiver. No failure or delay by a party to exercise any right or remedy provided under the Contract or by law shall constitute a waiver of that or any other right or remedy, nor shall it prevent or restrict the further exercise of that or any other right or remedy. No single or partial exercise of such right or remedy shall prevent or restrict the further exercise of that or any other right or remedy.

### 11.5 Severance. If any provision or part-provision of the Contract is or becomes invalid, illegal or unenforceable, it shall be deemed modified to the minimum extent necessary to make it valid, legal and enforceable. If such modification is not possible, the relevant provision or part-provision shall be deemed deleted. Any modification to or deletion of a provision or part-provision under this clause 11.5 shall not affect the validity and enforceability of the rest of the Contract.

### 11.6 Notices:

- (a) Any notice or other communication given to a party under or in connection with the Contract shall be in writing, addressed to that party at its registered office (if it is a company) or its principal place of business (in any other case) or such other address as that party may have specified to the other party in writing in accordance with this clause 11.6, and shall be delivered personally, sent by pre-paid first class post or other next working day delivery service, commercial courier, or email.
- (b) A notice or other communication shall be deemed to have been received: if delivered personally, when left at the address referred to in clause 11.6(a); if sent by pre-paid first class post or other next working day delivery service, at 9.00 am on the second Business Day after posting; if delivered by commercial courier, on the date and at the time that the courier's delivery receipt is signed; or, if sent by email, one Business Day after transmission.
- (c) The provisions of this clause 11.6 shall not apply to the service of any proceedings or other documents in any legal action.

### 11.7 Third party rights. No one other than a party to this Contract shall have any right to enforce any of its terms.

### 11.8 Governing law. The Contract, and any dispute or claim (including non-contractual disputes or claims) arising out of or in connection with it or its subject matter or formation, shall be governed by and construed in accordance with the law of England and Wales.

### 11.9 Jurisdiction. Each party irrevocably agrees that the courts of England and Wales shall have exclusive jurisdiction to settle any dispute or claim (including non-contractual disputes or claims) arising out of or in connection with this Contract or its subject matter or formation.

## IMPORTANT

Please read the terms and conditions carefully and then print, sign, date, and email/fax back to us. Without this form being filled in a credit account cannot be set up.

COMPANY NAME: .....

NAME: .....

SIGNED: .....

DATE: .....

[www.atkinsonequipment.com](http://www.atkinsonequipment.com)

PHONE



01373 822220

EMAIL



[sales@atkinsonequipment.com](mailto:sales@atkinsonequipment.com)

FAX



01373 826996