

**ARCTIC  
HAYES**

**PRODUCT  
CATALOGUE**



[www.arctic-hayes.com](http://www.arctic-hayes.com)  
[sales@arctic-hayes.com](mailto:sales@arctic-hayes.com)  
0113 271 5245  
9 Millshaw Park Ave, Leeds, LS11 0LR

**GREAT KIT.  
JOB DONE.**

# ARCTIC HAYES

We are committed to supporting our customers with the highest levels of service. Head quartered in Leeds, we are among the UK's largest suppliers of professional plumbing tools and equipment. Our best-known products include Arctic Spray pipe freeze, Vortex gas and Sleepsafe Carbon Monoxide alarms. Our product range comprises over 450 items borne from continual investment in product development, quality systems and in our people. As a customer of Arctic Hayes you benefit from dealing with a knowledgeable team who deliver an efficient service you can rely on.

**GREAT KIT.  
JOB DONE.**



Our Chinese office is situated in the busy manufacturing city of Shenzhen. The Chinese team ensure excellent communication between our business partners in China, Taiwan and Hong Kong and our Head Office in Leeds UK. Our trusted team help us manage our Far-East supply chain and mitigate any risk to purchasing and manufacturing goods in China.

By working closely together, our UK and Chinese teams allow us to provide a full sourcing solution, which includes support in the manufacturing process, factory audits and pre-shipment inspections. Alongside this, they ensure all logistical requirements are taken care of, avoiding unnecessary delays or inconveniences. This ensures we receive high quality products, at competitive prices, when we need them.

We focus on the social and ethical responsibilities of our manufacturing partners and are working to BSCI and SEDEX standards with all suppliers.

Arctic Hayes is ISO9001:2015 certified which insures we are customer focused as well as ensuring our quality management systems are based on a commitment to continuous development and improvement.

By implementing ISO14001:2015 we are committed to reducing our environmental impact, increasing reuse or recycling of our own waste materials, improve our resource efficiency and protecting the environment.

Where applicable products conform to UK regulations (UKCA and European directives(CE).



# CHECK OUT OUR WEBSITE!

With over 450 products available

Find out Frequently Asked Questions

NEW Freeze Selector, which freeze is best for you!

News, reviews and information

Partnership opportunities

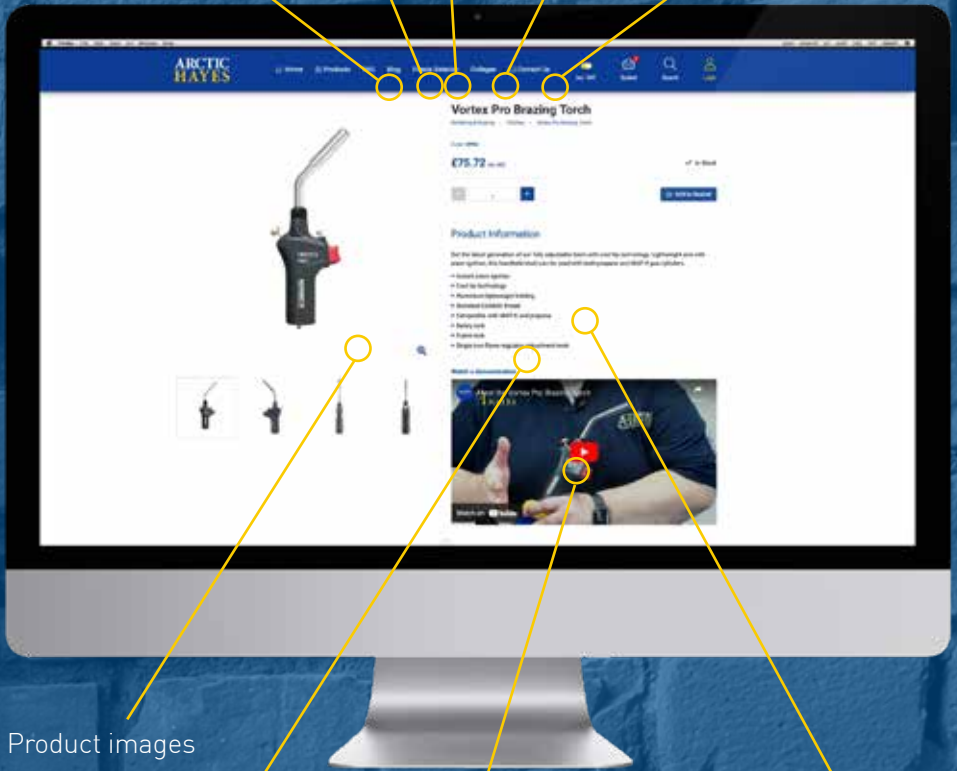

Product images

Download safety data sheets

Watch how-to-use videos

Full product information

[www.arctic-hayes.com](http://www.arctic-hayes.com)

# HOW TO ORDER?

Before you call or email us, our frequently asked questions section on our website could help you find a quick solution?

## PHONE

You can reach our sales office during the following hours:

Mon-Thur ..... 8:30am - 5pm

Fri ..... 8:30am - 4pm

**Tel: +44(0)113 271 5245**

## EMAIL

We aim to reply to all enquiries the same day.



**sales@arctic-hayes.com**

## ONLINE

Set up your online account now for easy ordering.

- Check stock for delivery.
- Quick order history to save time.
- View more product details.
- Suggested products.
- Manage your account.
- Mobile friendly.
- Merchant portal.

**Order Now!**

**www.arctic-hayes.com**

## IN BRANCH

Arctic Hayes products are available from all good plumbing merchants.

**Call for your nearest stockist**

# CONTENTS

## PIPE FREEZE

Aero Freeze Kits & Accessories	Page 13 - 22
Pro Freeze Kits & Accessories	Page 23 - 34
Electric Kits & Accessories	Page 35 - 43



## SMOKE PRODUCTS

Smoke Matches	Page 47 - 48
Smoke Cartridges & Pellets	Page 49 - 54
Smoke Sticks, Refills & Powdered smoke	Page 55 - 58



## AEROSOL GREASE & SOLUTION

Leak Detection	Page 61 - 66
Maintenance & Multi-Purpose	Page 67 - 70
Silicone & Grease Products	Page 71 - 72



## SOLDERING & BRAZING

Gas & Torches	Page 75 - 80
Soldering & Brazing Packs	Page 81 - 86
Soldering & Brazing Mats	Page 87 - 88



## CARBON MONOXIDE, HEAT & SMOKE

CO, Heat & Smoke Alarms	Page 91 - 100
Aerosol Alarm Testers	Page 101 - 102



## SERVICING ESSENTIALS

Gauges & Hoses	Page 105 - 116
Radiator Servicing	Page 117 - 120
Asset Protection & Dust Sheets	Page 121 - 134
Abrasives & Brushes	Page 135 - 143
Report Pad & Labels/Tags	Page 145 - 146
Heat resistant products	Page 147 - 148
Specialist & Identification Tapes	Page 151 - 156



## SERVICING TOOLS

Pipe Cutters & Benders	Page 159 - 164
Test Pump & Accessories	Page 165 - 169
Servicing Tools	Page 171 - 176



# CONTENTS

## MAGNETIC FILTERS & SCALE REDUCERS

Domestic Products  
Commercial Products  
Industrial Products

Page 179 - 189  
Page 191 - 193  
Page 195 - 196



## TEST EQUIPMENT

Temperature  
Gas & Pressure  
Electrical

Page 199 - 208  
Page 209 - 212  
Page 213 - 219



## FIX IT FAST RANGE

Washers & Kits  
Split-Klick Washers  
Washers & Fixings

Page 223 - 227  
Page 229 - 232  
Page 234 - 240



## ACCESS PANELS

Lightweight Plastic  
1 Hour Fire Rated

Page 243  
Page 244



## PPE & CLEANING

Personal Protective Equipment  
Cleaning Products

Page 247 - 252  
Page 253 - 260



## WINTER PRODUCTS

Heating Appliances  
Winter Accessories

Page 263 - 266  
Page 267 - 270

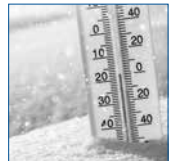



# PIPE FREEZE

The premium pipe freeze range.



## **AERO PIPE FREEZE KITS**

Pages: 13-22



## **PRO PIPE FREEZE KITS**

Pages: 23-34



## **ELECTRIC PIPE FREEZE KITS**

Pages: 35-43



# PIPE FREEZE!

## WHY FREEZE PIPES?

Arctic Hayes pipe freeze products enable repairs and maintenance of pipework without the need to drain down the whole system saving time, effort and money.

Our pipe freeze products form a temporary ice-plug in the pipe so work can be carried out with minimum disruption.

## BENEFITS

- Reduces job time, on average, by 85% (based on a 2 hour drain down and refill).
- No need to locate stop-cock or service valves.
- Reduces potential for water spillage and property damage.



# WHAT PIPES CAN BE FROZEN?

Pipe freeze products can be used on a range of pipes including:

**Copper**  **Plastic**  **Lead**   
**Steel**  **Iron**

\*Please refer to the freeze guide for guidance on the amount of refrigerant and freeze times for the different pipe materials

# WHEN SHOULD I USE PIPE FREEZE?

Pipe freeze products can be used on a range of plumbing jobs without draining down the whole system.

## Uses Include:



Can be used for central heating repairs and installations

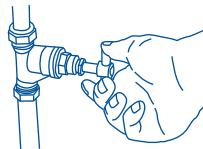

Installing & repairing stopcocks and service valves

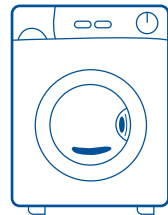

Plumbing in washing machines or dishwashers



Cistern washer replacements



Installing shower units



Installing or replacing taps or washers



## HORIZONTAL & VERTICAL

Being able to complete a freeze on both horizontal and vertical pipes, allows our pipe freeze kits to be used in most situations.

Most of our pipe freeze products can create simultaneous dual freezes allowing for sections of pipe to be completely isolated. This means that valves, pumps or branches, can be added or removed with minimal effort or mess.



# WHICH KIT IS RIGHT FOR ME?

We offer a range of pipe freeze products starting with disposable freeze kits perfect for DIY jobs. Most professional kits capable of dual freeze and electric freeze kits for larger projects that need pipes isolating for a prolonged period of time.

**Aero:** Ideal for professional or DIY use. These disposable kits contain enough refrigerant to perform one freeze on 22mm or 28mm and two freezes on 15mm (ZEK2 only). Suitable for changing radiator valves, stop-cocks, tap washers, showers and many other plumbing tasks.

View the range (pages 13-22)



**Pro:** Supplied with extra features such as re-usable components and dual freeze capability\*. Pro kits are available in different models and can freeze pipes from 8mm to 61mm external diameter.

View the range (pages 23-34)

\*All kits apart from ZESOLO & ZEWA.



**Electric:** A comprehensive range of electric pipe freeze kits, for every application. Available in various models and voltages (110v & 230v), to freeze pipes from 8mm to 61mm external diameter.

View the range (pages 35-43)



# AERO PIPE FREEZE

For professional and DIY use.



**Scan** to view Aero range, view technical specifications and watch **'HOW-TO-USE'** videos

# THE ORIGINAL THE BEST!

Arctic Hayes Pipe Freezer was  
**invented in 1966** making  
us the **original** and the **best**  
Pipe Freeze on the market



By using Pipe Freeze as your **first choice** you'll  
make light work of many plumbing and heating  
jobs, **increasing** your efficiency, availability and  
ultimately - **your profit margin.**

# AERO DISPOSABLE PIPE FREEZE KITS

## KEY FEATURES

- Easy to use, freezes pipes in minutes
- Portable and non-flammable
- Suitable for horizontal or vertical freeze
- No need to locate stop-cock or service valves
- Reduces job time, on average, by 85%





**The original pipe freeze kit.** Ideal for small single-use plumbing jobs. Suitable for a single freeze on 8-15mm (¼"-½") horizontal or vertical pipes.

• **CODE: ZEK1**

### KIT CONTAINS

- 1 x Aero Pipe Freeze 150ml Can
- 1 x Freeze Jacket
- 2 x Cable Ties
- 1 x Instruction manual



**The mid-size pipe freeze kit.** Suitable for two 15mm (½") freezes or one larger 22 or 28mm (¾" or 1") freeze where more refrigerant may be required.

• **CODE: ZEK2**

### KIT CONTAINS

- 1 x Aero Pipe Freeze 300ml Can
- 2 x Freeze Jackets
- 4 x Cable Ties
- 1 x Instruction manual



# AERO PIPE FREEZE SPRAY

Trusted in the industry for over 55 years.  
Freezes pipes in as little as 3 minutes with  
the ice-plug lasting up to 35 minutes.

- **CODE: ZE1** - 150ml Can
- **CODE: ZE2** - 300ml Can



## KEY FEATURES

- Low global warming potential
- Save time, effort and money

# HOW TO USE GUIDE



## STEP ONE

Set up involves switching off the pump to ensure the water is not flowing and closing any valves. The system temperature should be cool, ideally below 20°C.



## STEP TWO

Attach the freeze jacket to the pipe, ensure it's as secure as possible. Fit the cable ties to each end and tighten.



## STEP THREE

Make a small incision in the top. Take the can of pipe freeze and add the nozzle to the can and you're ready to go.



## STEP FOUR

Insert the straw into the jacket and spray for around 10 seconds. Leave for a few seconds to avoid any flooding in the jacket (you'll see refrigerant leaking out the jacket if you spray too much). Repeat until you have used the dose indicated on the side of the can or you hear the click sound, which indicates the ice plug has formed. Wait a further five minutes, or 10 minutes if the pipe is plastic.

## STEP FIVE

Now you can safely carry out your job with no need to drain down. Pipe freeze reduces your total job time by up to 85% on average.



## STEP SIX

Always allow the jacket to defrost before removing. Once job is complete, cut the cable ties off and remove the jacket.



# AERO DUAL PIPE FREEZE KIT

Get more out of this kit with the extra freeze spray and re-usable jackets.  
Suitable for multiple 8, 15, 22 ,28 or 1 x 35mm (¼", ½", ¾", 1" or 1 ½") freezes

• **CODE: ZEDUAL835**

## KIT CONTAINS

- 2 x Aero Pipe Freeze 300ml Cans
- 1 x 8-20mm (¼" - ¾") Re-usable Freeze Jacket
- 1 x 22-35mm (¾" - 1 ½") Re-usable Freeze Jacket
- 1 x Lightweight soft case



# AERO ELITE PIPE FREEZE KIT

**The largest aero pipe freeze kit.** With two re-usable jacket sizes to allow a wider variety of work and three canisters of pipe freeze to perform more longer jobs where more refrigerant is required. Suitable for multiple 8, 15, 22, 28 or 35mm (1/4", 1/2", 3/4", 1" or 1 1/2") freezes, with dual freeze capability on horizontal or vertical pipe.

• **CODE: ZELITE1**



## KIT CONTAINS

- 3 x Aero Pipe Freeze 300ml Cans
- 2 x 8-20mm (1/4" - 3/4") Re-usable Freeze Jackets
- 2 x 22-35mm (3/4" - 1 1/2") Re-usable Freeze Jackets
- 1 x Sturdy Carry Case

# PIPE FREEZE JACKETS

- Intended for use with aero freeze sprays
- Rugged construction with rip-stop material
- Fast and secure drawstring toggles
- Suitable for copper, steel, lead, iron & plastic pipes
- Foam insulation



Re-usable jacket for use on 8-20mm (1/4" - 3/4") pipes.

• **CODE: ELITE820**

---



Re-usable jacket for use on 22-35mm (3/4" - 1 1/2") pipes.

• **CODE: ELITE2235**

---



Disposable jacket for use on 8-28mm pipes (1/4" - 1") pipes.  
Supplied with 2 x cable ties.

• **CODE: ASM01**

# AERO PIPE FREEZE GUIDES

Guides are based on copper pipe work at no more than 20°C (68°F) ambient temperature.  
For higher temperatures use at least 25% more Arctic Hayes Aero Pipe Freeze.  
Expected dose time is how long it should take to inject the refrigerant dose.

## ZE1 (150ml Can) FREEZE GUIDE

TYPE	PIPE Ø	DOSE PER FREEZE	EXPECTED DOSE TIME	PAUSE	ICE PLUG LIFE
Copper, Steel, Lead or Iron	8 - 15mm (1/4" - 1/2")	1 Can	3 min	5 min	30-35 min
	22mm (3/4")	2 Cans*	10 min	5 min	30-35 min
	28mm (1")	2 Cans*	10 min	5 min	20-30 min
Plastic	15mm (1/2")	1 Can	3 min	10 min	35 min
	22mm (3/4")	2 Cans*	15 min	10 min	35 min

## ZE2 (300ml Can) FREEZE GUIDE

TYPE	PIPE Ø	DOSE PER FREEZE	EXPECTED DOSE TIME	PAUSE	ICE PLUG LIFE
Copper, Steel, Lead or Iron	8 - 15mm (1/4" - 1/2")	1/2 Can	3 min	5 min	30-35 min
	22mm (3/4")	1 Can	10 min	5 min	30-35 min
	28mm (1")	1 Can	10 min	5 min	20-30 min
Plastic	15mm (1/2")	1/2 Can	3 min	10 min	35 min
	22mm (3/4")	1 Can	15 min	10 min	35 min

## ZELITE1 (300ml Can) FREEZE GUIDE

TYPE	PIPE Ø	JACKET VELCRO COLOUR	DOSE PER CAN	EXPECTED DOSE TIME	PAUSE	ICE PLUG LIFE
Copper, Steel, Lead or Iron	8 - 15mm (1/4" - 1/2")	GREEN	1/2 Can	3 min	5 min	30-35 min
	22mm (3/4")	GREEN OR RED	1 Can	10 min	5 min	30-35 min
	28mm (1")	RED	1 Can	10 min	5 min	20-30 min
	35mm (1 1/2")	RED	2 Can	15 min	5 min	15-20 min
Plastic	15mm (1/2")	GREEN	1/2 Can	3 min	10 min	35 min
	22mm (3/4")	RED	1 Can	15 min	10 min	35 min

The use of compression, push-fit or press-fittings is recommended.  
DO NOT solder near ice plug or refrigerant vapour.  
Where possible open a tap/valve etc, to verify that the pipe is frozen.

# PRO PIPE FREEZE

Designed for heating & plumbing engineers who carry out regular pipework repairs and maintenance.



**Scan** to view Pro range, view technical specifications and watch **'HOW-TO-USE'** videos



# 8-22mm (1/4" - 3/4") PRO PIPE FREEZE KIT

Our most popular professional pipe freeze kit, the ZEPRO, contains everything you need to start regularly freezing the most common pipe sizes. Designed for heating and plumbing engineers with dual freeze capability and reusable components.

Freezes 8-22mm (1/4" - 3/4") pipes for up to 30 minutes.

• **CODE: ZEPRO**



## KIT CONTAINS

- 1 x Pro Pipe Freeze 600g / 509ml Can
- 2 x 8-15mm (1/4" - 1/2") Freeze Jackets
- 2 x 15-22mm (1/2" - 3/4") Freeze Jackets
- 2 x 1m Nylon Connection Hose
- 1 x Regulator Valve
- 1 x Digital Dosing Scale
- 1 x Dual Freeze T-Connector
- 1 x Instruction manual

# 8-22mm (1/4" - 3/4") SOLO PIPE FREEZE KIT

This lightweight alternative to our best selling ZEPRO comes in a lightweight soft case. Ideal for heating and plumbing professionals or DIY use.

Freezes 8-22mm (1/4" - 3/4") pipes for up to 30 minutes.

• **CODE: ZESOLO**



## KIT CONTAINS

- 1 x Pro Pipe Freeze 600g / 509ml Can
- 1 x 8-15mm (1/4" - 1/2") Freeze Jacket
- 1 x 15-22mm (1/2" - 3/4") Freeze Jacket
- 1 x 1m Nylon Connection Hose
- 1 x Regulator Valve
- 1 x Digital Dosing Scale
- 1 x Instruction manual

# 8-35mm (1/4" - 1 1/2") COMMERCIAL PIPE FREEZE KIT

This Pro Kit comes in a lightweight soft case, and includes three of the most common jacket sizes. Suited to heating and plumbing engineers, it is ideal for commercial plumbing jobs, with dual freeze capability and reusable components.

Freezes 8-35mm (1/4" - 1 1/2") pipes for up to 30 minutes.

• **CODE: ZECOM**



## KIT CONTAINS

- 1 x Pro Pipe Freeze 600g / 509ml Can
- 2 x 8-15mm (1/4" - 1/2") Freeze Jackets
- 2 x 15-22mm (1/2" - 3/4") Freeze Jackets
- 2 x 28-35mm (1" - 1 1/2") Freeze Jackets
- 2 x 1m Nylon Connection Hose
- 1 x Regulator Valve
- 1 x Digital Dosing Scale
- 1 x Dual Freeze T-Connector
- 1 x Instruction manual

# 8-35mm (1/4" - 1 1/2") UTILITY PIPE FREEZE KIT

Designed primarily for single freeze applications, such as water meter installation or replacement.

Freezes 8-35mm (1/4" - 1 1/2") pipes for up to 30 minutes.

• **CODE: ZEWA**



## KIT CONTAINS

- 2 x Pro Pipe Freeze 600g / 509ml Cans
- 1 x 8-15mm (1/4" - 1/2") Freeze Jacket
- 1 x 15-22mm (1/2" - 3/4") Freeze Jacket
- 1 x 28-35mm (1" - 1 1/2") Freeze Jacket
- 1 x 1m Nylon Connection Hose
- 1 x Regulator Valve
- 1 x Digital Dosing Scale
- 1 x Instruction manual

# 8-61mm (1/4" - 2 1/2") INDUSTRIAL PIPE FREEZE KIT

Featuring larger jackets for bigger diameter pipes, this professional kit is ideal for larger commercial and industrial scale pipe freeze projects, with dual freeze capability and reusable components.

Freezes 8-61mm (1/4"-2 1/2") pipes for up to 30 minutes.

• **CODE: ZEIND**



## KIT CONTAINS

- 2 x Pro Pipe Freeze 600g / 509ml Cans
- 2 x 8-15mm (1/4" - 1/2") Freeze Jackets
- 2 x 15-22mm (1/2" - 3/4") Freeze Jackets
- 2 x 28-35mm (1" - 1 1/2") Freeze Jackets
- 2 x 35-42mm (1 1/2" - 1 3/4") Freeze Jackets
- 2 x 54-61mm (2" - 2 1/2") Freeze Jackets
- 2 x 1m Nylon Connection Hose
- 1 x Regulator Valve
- 1 x Digital Dosing Scale
- 1 x Dual Freeze T-Connector
- 1 x Instruction manual



## KEY FEATURES

- Fastest pipe freeze spray on the market
- Freeze pipes in as little as 90 seconds
- Up to 6 freezes per can
- Non-flammable
- Eco-friendly refrigerant
- For use with all Arctic Hayes Pro kits

# PRO PIPE FREEZE SPRAY

Pro formulation pipe freeze in a 600g canister.  
Suitable for use with all Arctic Hayes pro freeze kits.

• **CODE: ZEP1** - 509ml Can



Can be used for central heating repairs and installations

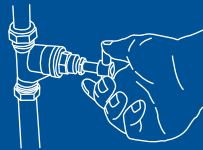

Installing & repairing stopcocks and service valves



Cistern washer replacements

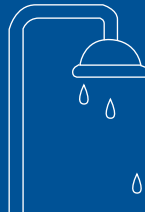

Installing shower units

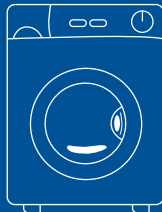

Plumbing in washing machines or dishwashers



Installing or replacing taps or washers

# PRO PIPE FREEZE JACKETS

Re-usable freezing jackets made from high quality rip-stop nylon for use with all pro pipe freeze kits.



For use on 15-22mm  
( $\frac{1}{2}$ " -  $\frac{3}{4}$ " ) pipes.  
**CODE: MUFF1**



For use on 28-35mm  
(1" - 1 $\frac{1}{2}$ " ) pipes.  
**CODE: MUFF2**



For use on 35-42mm  
(1 $\frac{1}{2}$ " - 1 $\frac{3}{4}$ " ) pipes.  
**CODE: MUFF3**



For use on 54-61mm  
(2" - 2 $\frac{1}{2}$ " ) pipes.  
**CODE: MUFF4**





For use on 8-15mm  
[ $\frac{1}{4}$ "- $\frac{1}{2}$ " ] pipes.  
**CODE: MUFFO**

# PRO PIPE FREEZE ACCESSORIES

Professional pipe freeze accessories are available in most kits and can also be purchased individually.

## Nylon Connection Hoses



For use with all Pro kits.

- **CODE: NTB04 (1m length)**
- **CODE: NTB04B30M (30m length)**

## Dual Freeze T-Connector



Required to carry out dual freeze. For use with all Pro kits.

**CODE: ETC04**

## Digital Dosing Scale



Refrigerant dosing digital scale is calibrated to allow accurate dosing of pro freeze spray, minimising refrigerant wastage.

- **CODE: DIGISCALE**

## Regulator Valve



Allows for a much more precise application of refrigerant than the press-top disposable kit.

**CODE: VPOL**

# PRO PIPE FREEZE GUIDE

Guide is based on copper pipe work at no more than 20°C (68°F) ambient temperature.  
For higher temperatures use at least 25% more Arctic Hayes pro pipe freeze.

## FREEZE GUIDE

PIPE Ø	DOSE PER FREEZE	JACKET CODE	COLOUR	ICE PLUG LIFE
8 - 15mm (1/4-1/2")	100g	MUFF0	YELLOW	10 MINS
15mm (1/2")	200g	MUFF1	GREEN	20 MINS
22mm (3/4")	300g	MUFF1	GREEN	25 MINS
28mm (1")	500g	MUFF2	RED	30 MINS
35mm (1 1/2")	600g	MUFF2	RED	30 MINS
42mm (1 3/4")	1000g	MUFF3	WHITE	30 MINS
54mm (2")	1850g	MUFF4	BLACK	30 MINS
61mm (2 1/2")	2250g	MUFF4	BLACK	30 MINS

\* NOTE: empty ZEP1 can with brass valve weighs approx 250g

The use of compression, push-fit or press-fittings is recommended.  
DO NOT solder near ice plug or refrigerant vapour.  
Where possible open a tap/valve etc, to verify that the pipe is frozen.



# ELECTRIC PIPE FREEZE

Perfect for large projects or where pipes need to be isolated for a prolonged period of time.



**Scan** to view Electric range, view technical specifications and watch **'HOW-TO-USE'** videos

# BENEFITS OF ELECTRIC FREEZE

- **Long-term savings** - No consumable refrigerants required
- **Variable voltage** - 110v or 230v machines
- **Flexibility** - Freeze 8 - 61mm pipes
- **Quick Results** - Initial ice-plug forms in around 10 minutes for 8mm pipes and approx 20 minutes for 28mm pipes.



# 8-28mm (1/4" - 1") MINI ELECTRIC FREEZE KIT

The mini is the smallest and most easily portable of the electric freeze kits. Ideal for domestic or large-scale contract and commercial plumbing jobs up to 28mm (1") diameter pipes. Aluminium freeze heads are designed to fit straight onto a 28mm (1") pipes, adding reducers 8-22mm (1/4" - 3/4") to the heads allows the freezing of smaller pipes.

- Unit weight: 23.6kg
- **CODE: AH28** - 230V



## KIT CONTAINS

- 4 x Pairs of clamp head reducers:  
8mm (1/4"), 10mm (3/8"), 15mm (1/2"), 22mm (3/4")
- 1 x Pair of cotton gloves
- 1 x 200ml freeze cream
- 2 x Optimum freeze towels
- 2 x Fixing straps
- 1 x User Instructions



# AH28 REPLACEMENT REDUCERS

Replacement 8mm (1/4"), 10mm (3/8"), 15mm (1/2"), 22mm (3/4") reducers available for AH28  
(Sold in separate pairs per reducer size)

- CODE: RDC208 - 8mm (1/4")
- CODE: RDC210 - 10mm (3/8")
- CODE: RDC215 - 15mm (1/2")
- CODE: RDC222 - 22mm (3/4")



# 8-42mm (1/4" - 1 3/4") DOMESTIC ELECTRIC FREEZE KIT

The 42mm (1 3/4") is the most popular of the electric freeze kits. Ideal for domestic or large-scale contract and commercial plumbing jobs up to 42mm (1 3/4") diameter pipes. Aluminium freeze heads are designed to fit straight onto a 42mm (1 3/4") pipe, adding reducers 8-35mm (1/4 - 1 1/2") to the heads allows the freezing of smaller pipes.

- Unit weight: 25.5kg
- **CODE: AH42** - 230V
- **CODE: AH42/110** - 110V

## KIT CONTAINS

- 6 x Pairs of clamp head reducers: 8mm (1/4"), 10mm (3/8"), 15mm (1/2"), 22mm (3/4"), 28mm (1"), 35mm (1 1/2")
- 1 x Pair of cotton gloves
- 1 x 200ml freeze cream
- 2 x Optimum freeze towels
- 2 x Fixing straps
- 1 x User Instructions





# AH42 REPLACEMENT REDUCERS

Replacement 8mm (3/8"), 10mm (3/8"), 15mm (1/2"), 22mm (3/4"), 28mm (1"), 35mm (1 1/2") reducers available for AH35

(Sold in separate pairs per reducer size)

- CODE: RDC408 - 8mm (3/8")
- CODE: RDC410 - 10mm (3/8")
- CODE: RDC415 - 15mm (1/2")
- CODE: RDC422 - 22mm (3/4")
- CODE: RDC428 - 28mm (1")
- CODE: RDC435 - 35mm (1 1/2")

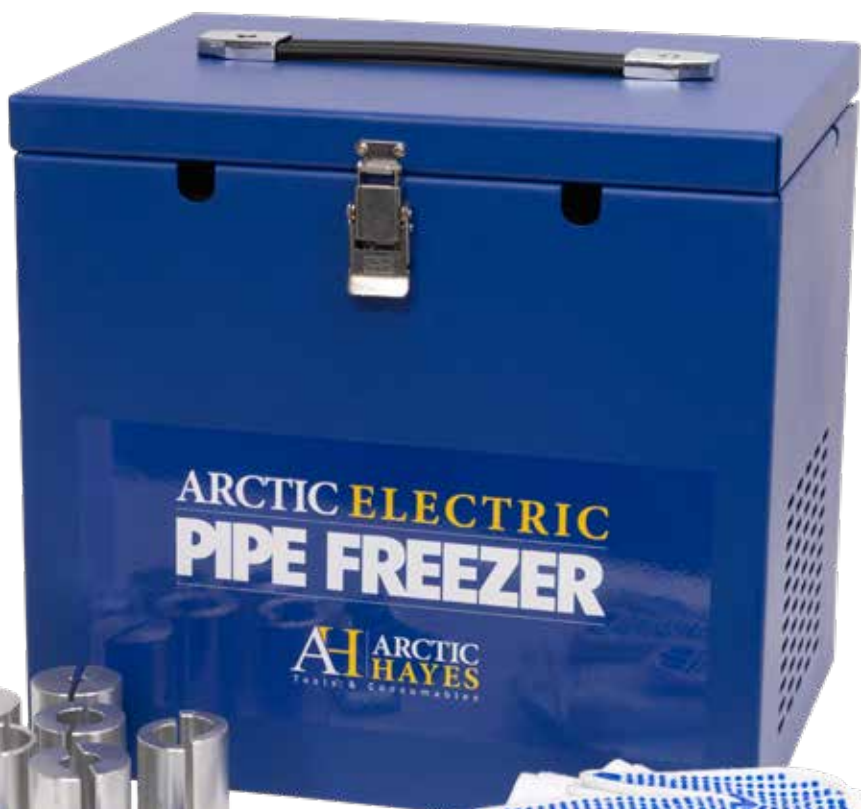

# 8-61mm (1/4" - 2 1/2") INDUSTRIAL ELECTRIC FREEZE KIT

The largest of the electric freeze kit, Industrial electric kit will handle large scale plumbing jobs and come equipped to freeze pipes from 8mm to 61mm (1/4" - 2 1/2"). Aluminium freeze heads are designed to fit straight onto a 61mm (2 1/2") pipe, adding reducers 8-54mm (1/4" - 2") to the heads allows the freezing of smaller pipes.

- **CODE: AH61/110** - 110V
- **CODE: AH61/230** - 230V

## KIT CONTAINS

- 9 x Pairs of clamp head reducers:  
8mm (1/4"), 10mm (3/8"), 15mm (1/2"),  
22mm (3/4"), 28mm (1"), 35mm (1 1/2")  
42mm (1 3/4"), 49mm (1 3/4"), 54mm (2")
- 1 x Pair of cotton gloves
- 1 x 200ml freeze cream
- 2 x Optimum freeze towels
- 2 x Fixing straps
- 1 x Instruction manual

Replacement 8mm (1/4"), 10mm (3/8"), 15mm (1/2"), 22mm (3/4"), 28mm (1"), 35mm (1 1/2"), 42mm (1 3/4"), 49mm (1 3/4"), 54mm (2") reducers available for AH61 (Sold in separate pairs per reducer size)

## ARCTIC HAYES

**WARNING: BEFORE OPERATING, ALWAYS READ THE INSTRUCTIONS CAREFULLY. ALWAYS WEAR YOUR SAFETY GEAR. ALWAYS USE THE PROPER TOOLS AND EQUIPMENT. ALWAYS FOLLOW THE SAFETY INSTRUCTIONS.**

### 1. ATTACHING THE FREEZER HEAD

Always use the correct size pipe and use the correct size of pipe and clamp.

Place the head on the pipe.



Use the side and top clamps to secure the head.



Tighten the clamps.



If the pipe is too small or too large, it will not fit. Always use the correct size pipe and clamp. Always use the correct size of pipe and clamp. Always use the correct size of pipe and clamp.



## ARCTIC ELECTRIC PIPE FREEZER INSTRUCTIONS

### 2. OPERATING THE FREEZER

Insert the power cord into the power outlet. Plug the power cord into the power outlet. Plug the power cord into the power outlet.



Set the temperature control knob to the desired temperature. Turn the temperature control knob to the desired temperature. Turn the temperature control knob to the desired temperature.

When the pipe reaches the desired temperature, the freezer will stop. When the pipe reaches the desired temperature, the freezer will stop. When the pipe reaches the desired temperature, the freezer will stop.

Apply a hot liquid to the pipe to melt the ice. Apply a hot liquid to the pipe to melt the ice. Apply a hot liquid to the pipe to melt the ice.

Always check the water in the pipe for the freezer to work. Always check the water in the pipe for the freezer to work. Always check the water in the pipe for the freezer to work.

High ambient temperatures (20°C/70°F) will reduce the freezing rate. High ambient temperatures (20°C/70°F) will reduce the freezing rate. High ambient temperatures (20°C/70°F) will reduce the freezing rate.

Always use the correct size pipe and clamp. Always use the correct size pipe and clamp. Always use the correct size pipe and clamp.

Always use the correct size pipe and clamp. Always use the correct size pipe and clamp. Always use the correct size pipe and clamp.

Always use the correct size pipe and clamp. Always use the correct size pipe and clamp. Always use the correct size pipe and clamp.

### 3. REMOVING THE FREEZER

When ready to remove the freezer, disconnect the power cord. When ready to remove the freezer, disconnect the power cord. When ready to remove the freezer, disconnect the power cord.



### 4. TROUBLESHOOTING

- The pipe is not freezing. Check the power cord and the power outlet.
- The pipe is not freezing. Check the power cord and the power outlet.
- The pipe is not freezing. Check the power cord and the power outlet.
- The pipe is not freezing. Check the power cord and the power outlet.
- The pipe is not freezing. Check the power cord and the power outlet.

### FREEZER TIMES

The graph shows the approximate times for freezing pipes. The graph shows the approximate times for freezing pipes. The graph shows the approximate times for freezing pipes.



### NOTE

Always use the correct size pipe and clamp. Always use the correct size pipe and clamp. Always use the correct size pipe and clamp.

# ARCTIC ELECTRIC PIPE FREEZER

**AH** ARCTIC HAYES  
TOOLS & CONSUMABLES

# ELECTRIC FREEZE ACCESSORIES

Replacement accessories for all electric pipe freeze machines.

## FREEZE CREAM



• CODE: TGS001

## FREEZE STRAPS

• Pair



• CODE: BLS001

## FREEZE HEAD TOWEL WRAPS

• Pair



• CODE: TWL001

## FREEZE HANDLING GLOVES

• Pair



• CODE: GLV001

## FREEZE HEAD SCREWS



• CODE: FMSK28/42

# COLLEGES & TRAINING PARTNERS

## Educational Incentives

ARCTIC HAYES supply the premium pipe freezing range for plumbing and heating engineers. Contact us today to discuss our educational incentives on our full range of over 450 products and all the benefits below.

## Enhance your Curriculum

Including pipe freeze training as part of your student's curriculum, enables live demonstrations, a chance to ask questions and attain a certificate of completion to enhance their course qualifications.

## Sponsored Bays

Enhance your training bays with branded posters, high quality images and logos.

We can create banners specific to pipe freeze or any other product categories.





# **SMOKE** **PRODUCTS**

Ideal for flues, chimneys, spillage  
and air flow testing.

## **SMOKE MATCHES**

Pages: 47-48



## **CARTRIDGES & PELLETS**

Pages: 49-54



## **SMOKE STICKS & POWDER SMOKE**

Pages: 55-58





# SMOKE MATCHES

Ideal for spillage test & initial flue draw testing.



# SMOKE MATCHES



- **CODE: A333000** - Tub of 25
- **CODE: A333075** - Tub of 75
- **CODE: 333000B** - Tub of 100
- **CODE: PH009B** - Box of 12
- **CODE: PH009** - Display box of 72 boxes

# SMOKE MATCH PLUME KIT

Smoke match plume kit is supplied with two tubs of 25 Smoke Matches to aid the installer carrying spillage tests on gas appliances.

- **CODE: A338001** - Plume kit
- **CODE: A338000** - Single plume

## KITS CONTAINS

- 1 x Smoke plume
- 2 x 25 Smoke matches

## KEY FEATURES

- Clean to use, no residue
- Cool to touch after burning
- Protective resealable tubs
- 20 second burn time
- 0.75m<sup>3</sup> approx of dense smoke



# SMOKE PELLET & MATCH HOLDER

Used to test for chimney and flue leakages, blockages, air flow visualisation and drain testing.

- **CODE: PHSPHS**



## KEY FEATURES

- Safe and easy to use
- High grade aluminium
- Holds pellets and matches

A blue-tinted photograph of a roof with a chimney emitting smoke. The chimney is a brick structure on top of a gabled roof. A plume of dark smoke rises from the chimney against a clear blue sky. The roof is covered in dark, wavy tiles. The overall scene is dimly lit, giving it a moody, industrial feel.

# **SMOKE CARTRIDGES & PELLETS**

Variable smoke volume, burn time and smoke colours,  
make our smoke cartridges and pellets ideal  
for a wide range of safety testing

# 3G WHITE & ORANGE SMOKE CARTRIDGES

- **CODE: A333003** - Pack of 10
- **CODE: 333003C** - Tub of 50
- **CODE: 333003B** - Tub of 100
- **CODE: A334003** - Pack of 10 (Orange\*)

## KEY FEATURES

- 5m<sup>3</sup> approx of dense smoke
- 45 second burn time (White)
- 60 second burn time (Orange)
- Complies with BS5440-1



\* Coloured smoke may stain surfaces and leave residue

# 5G WHITE SMOKE PELLETS

- **CODE: PHB006** - Tube of 6

## KEY FEATURES

- 7m<sup>3</sup> approx of dense smoke
- 30 second burn time
- Complies with BS5440-1



# 5G WHITE SMOKE PELLETS

- **CODE: A333005** - Tub of 6
- **CODE: 333005B** - Tub of 15
- **CODE: 333005C** - Tub of 45

## KEY FEATURES

- 5m<sup>3</sup> approx of dense smoke
- 40 second burn time
- Complies with BS5440-1



# 5G WHITE ENCAPSULATED SMOKE PELLETS

- **CODE: PH030** - Tub of 10
- **CODE: PH530** - Tub of 50

## KEY FEATURES

- 15m<sup>3</sup> approx of dense smoke
- 30 second burn time
- Complies with BS5440-1



# 8G WHITE / RED ENCAPSULATED SMOKE PELLETS

- **CODE: PH025** - Tub of 10
- **CODE: PH025C** - Tub of 10 (Red\*)
- **CODE: PH525** - Tub of 50
- **CODE: PH125** - Tub of 100

## KEY FEATURES

- 24m<sup>3</sup> approx of dense smoke
- 60 second burn time
- Complies with BS5440-1



\* Coloured smoke may stain surfaces and leave residue

# 9G WHITE & ORANGE SMOKE CARTRIDGES

- **CODE: A333009** - Pack of 10
- **CODE: 333009B** - Tub of 50
- **CODE: A3334009** - Pack of 10 (Orange\*)
- **CODE: 334009B** - Pack of 50 (Orange\*)

## KEY FEATURES

- 8.5m<sup>3</sup> approx of dense smoke
- 75 second burn time (White)
- 100 second burn time (Orange)
- Complies with BS5440-1



\* Coloured smoke may stain surfaces and leave residue

# 13G WHITE / RED SMOKE PELLETS

- **CODE: PH001** - Tube of 6
- **CODE: PH118** - Tub of 100
- **CODE: PH001C** - Tube of 6 (Red\*)

## KEY FEATURES

- 18m<sup>3</sup> approx of dense smoke
- 40 second burn time
- Complies with BS5440-1



\* Coloured smoke may stain surfaces and leave residue

# 13G WHITE SMOKE PELLETS

- **CODE: A333013** - Tub of 8
- **CODE: 333013B** - Tub of 20
- **CODE: 333013C** - Tub of 40

## KEY FEATURES

- 13m<sup>3</sup> approx of dense smoke
- 45 second burn time
- Complies with BS5440-1



# 18G ORANGE SMOKE CARTRIDGES

- **CODE: A334018** - Pack of 5 (Orange\*)

## KEY FEATURES

- 17m<sup>3</sup> approx of dense smoke
- 150 second burn time
- Complies with BS5440-1



\* Coloured smoke may stain surfaces and leave residue



# **SMOKE STICKS** **& POWDER SMOKE**

Smoke-sticks & powder smoke  
exclusive to Arctic Hayes.



# SMOKE STICKS

Ideal for testing slight air movement, gas spillages and mandatory CO spillage checks for boiler/case spills after fitting or re-fitting smoke alarms, air filters, fume hoods, air balancing, fans, photography, special effects and much more.

- **CODE: A333113** - Smoke pen & 3 refills
- **CODE: A333103** - Refill pack of 3
- **CODE: A333110** - Smoke pen & 6 refills
- **CODE: A333100** - Refill pack of 6

## KEY FEATURES

- 30 minute burn time per stick

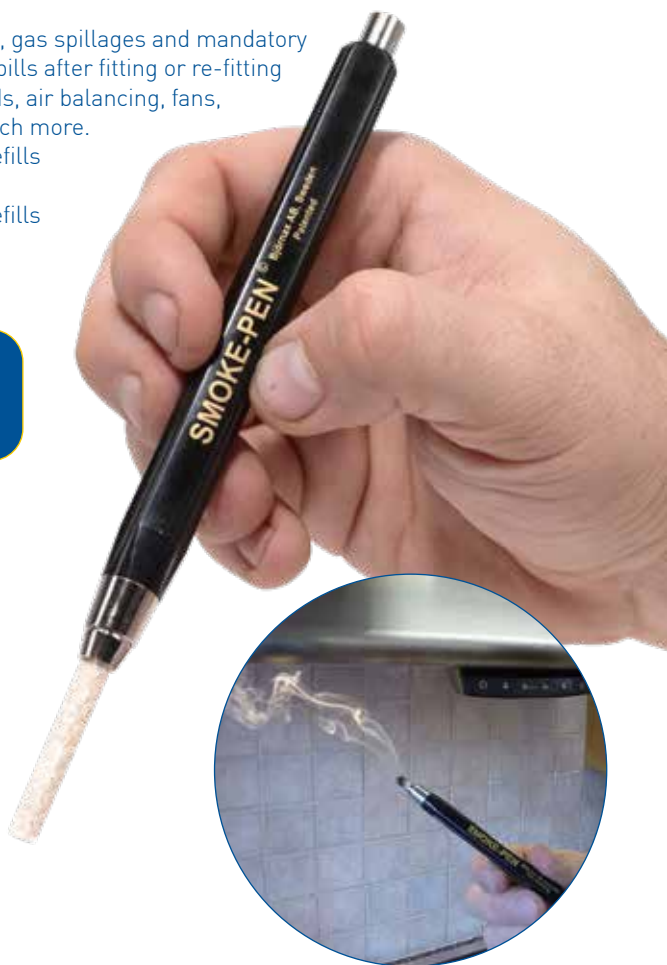

# POWDERED SMOKE

For the air balancing industry, the energy conservation industry, smoke and fire prevention, special effects. Provides a smoke that looks and reacts just as our successful smoke emitters, in a reliable and simple dispensing system.

• **CODE: FP-SMOKE201**

## KEY FEATURES

- Requires no ignition source or flame
- Eco-friendly way to dispense non-toxic smoke
- A small squeeze provides enough smoke for draft detection or negative pressure around a door
- Multiple pumps can provide up to 4m<sup>3</sup> (140ft<sup>3</sup>)



# MIXED SMOKE KIT

Smoke products are a vital tool in the heating and ventilation industry. This kit contains a range of smoke products including smoke matches, pellets, cartridges, smoke sticks & refills.

• **CODE: MSK100**



# 100 PIECE KIT

DESCRIPTION	QTY	BURN TIME	SMOKE VOLUME
SMOKE MATCHES (CODE: A333000)	25	20 SECONDS	0.75m3
3G WHITE SMOKE CARTRIDGES (CODE: A333003)	10	45 SECONDS	5m3
3G ORANGE SMOKE CARTRIDGES (CODE: A334003)*	10	60 SECONDS	5m3
5G WHITE SMOKE PELLETS (CODE: A333005)	6	40 SECONDS	5m3
8G WHITE SMOKE CARTRIDGES (CODE: PH025)	10	60 SECONDS	24m3
9G WHITE SMOKE CARTRIDGES CODE: (A333009)	10	75 SECONDS	8.5m3
9G ORANGE SMOKE CARTRIDGES (CODE: A334009)*	10	100 SECONDS	8.5m3
13G WHITE SMOKE PELLETS (CODE: A333013)	8	45 SECONDS	13m3
18G ORANGE SMOKE CARTRIDGES (CODE: A334018)*	5	150 SECONDS	17m3
SMOKE PELLET AND MATCH HOLDER (CODE: PHSPHS)	1	N/A	
SMOKE MATCH PLUME (CODE: A338000)	1	N/A	
SMOKE STICK PEN	1	30 MIN PER STICK	
SMOKE STICK REFILLS (CODE: A333113)	3	30 MIN PER STICK	
SMOKE CARRY CASE	1	N/A	

\* Coloured smoke may stain surfaces and leave residue



# **AEROSOL, GREASE & SOLUTIONS**

Consumables for the  
heating and plumbing industry.

## LEAK DETECTION

Pages: 61-66



## MAINTENANCE & MULTI-PURPOSE

Pages: 67-70



## SILICONE & GREASE

Pages: 71-72





# **LEAK** **DETECTION**

Specially formulated to trace positive pressure leaks in pipelines and fittings.

# LEAK DETECTOR

Specially formulated to trace positive pressure leaks in pipelines and fittings. No need to submerge parts or lines to test. Non-flammable and non-corrosive, suitable for use on gas, air and nitrogen leaks. The micro-porous foam instantly highlights the smallest of leaks.

- **CODE: PH026A** - 250ml atomiser
- **CODE: PH026A5** - 500ml atomiser
- **CODE: PH026M** - 120ml brush on
- **CODE: PH026** - 250ml brush on

## KEY FEATURES

- Safe to use in confined areas
- Meets requirements of BS EN 14921:2010



# CLEAR LEAK DETECTOR

Specially formulated to trace positive pressure leaks in pipelines and fittings. No need to submerge parts or lines to test. Non-flammable and non-corrosive, suitable for use on gas, air and nitrogen leaks. The micro-porous foam instantly highlights the smallest of leaks.

## KEY FEATURES

- Safe to use in confined areas
- Non-flammable
- Non - corrosive
- Meets requirements of BS EN 14921:2010



- **CODE: PH027A** - 250ml with atomiser
- **CODE: PH027B** - 250ml with brush in cap
- **CODE: PH027A5** - 500ml with atomiser



# CLEAR LEAK DETECTOR SOLUTION

Detects gas, air and nitrogen leaks. A micro-porous foam instantly highlights the smallest of leaks.

• **CODE: PH027** - 1 litre bottle

## KEY FEATURES

- Safety cap
- Non-flammable
- Non-corrosive
- Built in sprinkler for controlled application
- Meets requirements of BS EN 14921:2010



# LEAK DETECTOR SPRAY

Used to trace costly and potentially dangerous gases and compressed air leaks. Produces a micro-porous foam designed to identify the smallest leaks.

• **CODE: PH020** - 400ml can

## KEY FEATURES

- Safe to use in confined spaces
- Non-corrosive
- Non-flammable
- Aerosol delivery for high powered application
- Meets requirements of BS EN 14921:2010



# AQUAPEA IN-LINE PIPE REPAIR

By introducing advanced formula polymer AQUAPEA into the water system, you can repair leaks within an hour, and without having to carry out costly excavations.

- **CODE: APBL1** - 4-10 lpm use
- **CODE: APYE1** - 10-15 lpm use
- **CODE: APOR1** - 15-20 lpm use
- **CODE: APRE1** - 20-25 lpm use



\* lpm - litres per minute

## HOW IT WORKS

**STEP 1** - Introduce the AQUAPEA into the water at an external meter chamber.

**STEP 2** - The AQUAPEA is drawn to the leak by the flow of escaping water.

**STEP 3** - Kept under pressure, the advanced polymer forms through and around sealing the leak.

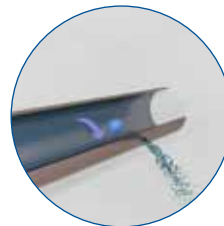
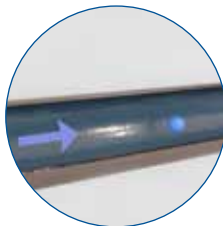
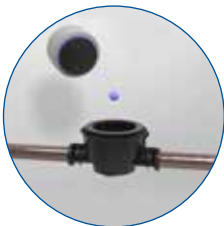

# LASTING **IN-LINE REPAIRS** WITHOUT EXCAVATION

By introducing advanced formula polymer AQUAPEA into the water system, you can repair leaks within an hour, without having to carry out costly excavations.

---

## QUICK RESULTS **LONG -TERM SAVINGS**



**Immediate Response** AQUAPEA can be implemented as soon as the leak is discovered and validated.



**Easy To Use** AQUAPEA can be without needing to excavate or replace pipework.



**Planet Saving** Eliminates on-site excavations. This dramatically reduces the environmental impact of any pipe fix.



**A Long Term Solution** Laboratory tests prove the AQUAPEA is a long term solution as the polymer bonds strongly, adhering to any type of commonly used pipe material.



**Fast Customer Satisfaction** AQUAPEA gets to the leak and repairs it fast, giving customers a fix within one hour.



**Multiple Cost Savings Across Networks** AQUAPEA can be used across networks to reduce the cost of repairs and leakage.

---

## THE **RANGE**

The AQUAPEA comes in a range of 4 sizes, each is colour coded depending on the application and the size of the hole or split in the pipework.



4-10 lpm



10-15 lpm



15-20 lpm



20-25 lpm

\*NOTE: Not for use on potable water from boulder to property



# **MAINTENANCE** **& MULTI-PURPOSE**

Suitable for heating and plumbing jobs and general maintenance around the home.

# SPRAY DUSTERS

New eco-friendly **non flammable** formulation with a high powered aerosol application to force dust and debris out of hard to reach areas such as burner jets, heat exchangers or keyboards. Features a detachable nozzle straw.

- **CODE: ZE29** - 120ml can
- **CODE: ZE294** - 300ml can

## KEY FEATURES

- 99.5% lower global warming potential
- High powered application
- Non-flammable
- Non-corrosive



\* NOTE: Do not invert can whilst in use as liquid will be dispensed

# ANTI RUST PROTECTION SPRAY

An all in one clear coating, designed to protect HVAC-Systems, metals and PCB components by providing a hard clear coating. Inhibits corrosion by creating an oxygen barrier.

- **CODE: ACCAN400** - 400ml can



'HOW-TO-USE' video

## KEY FEATURES

- Goes on clear, stays clear
- Non- conductive to electricity
- Allows for heat transfer
- Can be applied to all metals
- Designed to protect vulnerable PCB's
- UV stable and retains a flex
- Modified acrylic polymer base



# CRACK-IT SHOCK FREEZE RELEASE

**First the freeze, then the penetration.**

Freeze action breaks the corrosion seal and allows the penetrating oil to reach the corroded area. Fast working, Crack-It releases seized items in as little as 1-2 minutes.

• **CODE: CI/400** - 400ml can



## KEY FEATURES

- 2 in 1 maintenance spray
- Prevents future corrosion

\* NOTE: Flammable

# PVC PIPE CEMENT

This non-drip thixotropic solvent based pipe cement is for use on non-pressurised PVC and ABS thermoplastic pipes and conduits.

- **CODE: PVCC125** - 125ml
- **CODE: PVCC250** - 250ml

## KEY FEATURES

- Can be used in low and high temperature soil and waste pipework



\* NOTE: Flammable

# AEROSOL TRIPLE PACK

- 1 x Leak detector spray (PH020)
- 1 x Silicone spray (PH040)
- 1 x Crack-it spray (CI/400)
- **CODE: AEP3**



# SILICONE & GREASE PRODUCTS

Ideal for lubricating rubber, plastic and other materials.





# SILICONE SPRAY & GREASE

An ideal plumbers grease, designed to lubricate rubber, plastics and other materials. Suitable for use on taps, valves and other water fittings.

- **CODE: 665016** - 100g tube
- **CODE: 665016-TUB** - 100g tub
- **CODE: 665017** - 500g tub
- **CODE: PH040** - 400ml can



## KEY FEATURES

- Lubricates rubber, plastic and other materials
- Compliant with UK water fitting bylaws
- WRAS approved



# ANTI-SEIZE GREASE

Designed for use on all static fasteners, bolts, flanges, metal interfaces and other mechanisms prone to seizure. Applying when assembling helps prevent corrosion. Apply a thin film onto dust free, clean surface.

- **CODE: ASG50**

## KEY FEATURES

- WRAS Approved
- Prevents corrosion
- Prevents mechanical seizure





# **SOLDERING & BRAZING**

Vortex gases offer superior performance  
over traditional products.

## **GASES & TORCHES**

Pages: 75-80



## **SOLDERING & BRAZING PACKS**

Pages: 81-86



## **SOLDERING & HEAT MATS**

Pages: 87-88

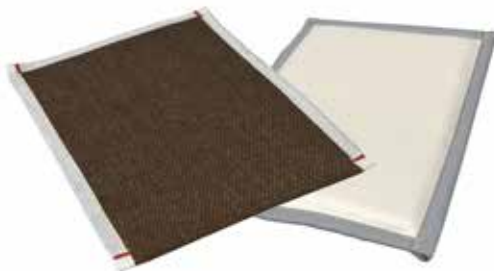



# **GASES & TORCHES**

High quality torches and superior Vortex gases.

# WHY CHOOSE VORTEX GAS?

Unique formulations are accepted by all major couriers. Meaning a happy courier. Pallets of Vortex gas unlike other gases can be bulk stored without concern, meaning happier insurers.

## 10% HOTTER 60% FASTER

than other MAP-X style gases.

### KEY FEATURES

- Conforms to the latest EN ISO 11118:2015
- CGA 600 thread
- Non refillable canisters
- TPED approved

## 5% HOTTER 50% FASTER

than other Propane style gases.



- **CODE: VG1** - 400g MAP-X gas
- **CODE: VG2** - 400g Propane gas

# VORTEX MAP-X GAS TWIN PACK

• CODE: VG1TWIN



## KITS CONTAINS

- 2 x MAP-X 400g canisters

# VORTEX MAP-X GAS TRIPLE PACK

• CODE: VG1TRIO



## KITS CONTAINS

- 3 x MAP-X 400g canisters

# GT3 GAS TORCH

The Arctic Hayes new addition GT3 is fast and effective for all brazing/ soldering applications, with its choice of 3 x interchangeable burner heads it's also great for Intricate/stripping and burning jobs.

• **CODE: GT3**

## COMES WITH 3 INTERCHANGEABLE BURNER TIPS

1. Super Fine Burner gives a more pronounced fine flame for more intricate jobs.
2. Turbo Power Burner a precise flame pattern for everyday soldering & brazing jobs.
3. Super Wide Burner gives a wider spread flame, great for roof repairs & paint removal.



### KEY FEATURES

- Instant piezo ignition
- Standard CGA600 thread compatible with Map-X and Propane gas
- Flame lock
- Flame regulator adjustment knob

# PRO BRAZING TORCH

Vortex Brazing Torch is lightweight, durable and easy to use. Designed for use with MAP-X and Propane gas cylinders with CGA600 thread.

• **CODE: VPRO**



## KEY FEATURES

- Piezo ignition
- Aluminium lightweight handle
- Super Cyclone burner tube
- Standard CGA 600 thread
- Compatible with Map-X and Propane gas with CGA600 thread
- Safety lock
- Flame lock
- Flame regulator adjustment knob







# SOLDERING & BRAZING PACKS

A selection of packs ideal for a range of soldering jobs.

# PRO BRAZING TORCH PACKS

- **CODE: VPROM** - Brazing torch with MAP-X gas
- **CODE: VPROP** - Brazing torch with Propane gas

## KITS CONTAINS

- 1 x Pro brazing torch
- 1 x MAP-X or Propane 400g canister



Pro brazing torch supplied with either one canister of MAP-X or Propane gas.

# PRO BRAZING TORCH PACKS

Brazing torch supplied with either a canister of MAP-X or Propane Gas.

- **CODE: VT3GBOXM** - Brazing torch with MAP-X 400g canister
- **CODE: VT3GBOXP** - Brazing torch with Propane 400g canister



## KIT CONTAINS

- 1 x VT3 Brazing Torch
- 1 x Super Cyclone Burner Tube
- 1 x Cyclone Burner Tube
- 1 x Fine Flame Burner Tube
- 1 x Map-X or Propane Gas

1. Fine Flame Burner gives a more pronounced fine flame for more intricate jobs.
2. Super Cyclone Burner gives a stronger burn pattern for everyday use.
3. Cyclone Burner gives a softer and more accurate flame.



Supplied with either one canister of MAP-X or Propane gas.

# VORTEX HOT BAGS

An all in one solution for your soldering and brazing needs, supplied in a stylish hard-wearing tool bag. Kit comes with either MAP-X or Propane gas and tool bag can be purchased individually.

- **CODE: ATBG1** - 15" Tool bag only
- **CODE: HOTBAGP** - Propane pack
- **CODE: HOTBAGM** - MAP-X pack

## KIT CONTAINS

- 1 x 15" tool bag
- 1 x Vortex Pro torch
- 1 x MAP-X or Propane gas
- 1 x Pack of 8 steel wool
- 1 x Solder mat 1200°C
- 1 x Pack of 10 abrasive strips





## KIT CONTAIN

- 1 x 15" Tool bag
- 1 x Solder mat 1200°C
- 1 x Vortex Pro torch
- 1 x 15mm pipe cutter
- 1 x 22mm pipe cutter
- 1 x Vortex Map-X gas

• CODE: HOTBAGK1



## KIT CONTAIN

- 1 x 15" Tool bag
- 1 x Solder mat 1200°C
- 1 x Vortex Pro torch
- 1 x Vortex Propane gas
- 1 x Abrasive carbide roll
- 1 x 1200mm x 750mm work mat
- 1 x 15mm pipe cutter

• CODE: HOTBAGK4

# VORTEX SOLDERING HOT BAGS

Essential kits for the everyday plumbing engineer or DIYer. An all-in-one solution to your soldering and brazing needs, which has everything you need. Ready to use in a stylish multi pocket bag (Bag also available separately Code:VORTEXBAG1).

## KIT CONTAINS

- 1 x Vortex bag
- 1 x Vortex Pro torch
- 2 x Vortex Map-X gas



• CODE: VBKIT1



## KIT CONTAINS

- 1 x Vortex bag
- 1 x Solder mat 1200°C
- 1 x Vortex Pro torch
- 1 x Vortex Map-X gas
- 1 x 15mm Pipe cutter
- 1 x 22mm Pipe cutter

• CODE: VBKIT3



## KIT CONTAINS

- 1 x Vortex bag
- 1 x Solder mat 1200°C
- 1 x Vortex Pro torch
- 1 x Vortex Map-X gas

• CODE: VBKIT5



# **SOLDERING & HEAT MATS**

Extra protection when working with  
high-temperature equipment.



# PROFESSIONAL SOLDER MAT

Premium construction offering high-performance protection during soldering and brazing.

• **CODE: VSM1**

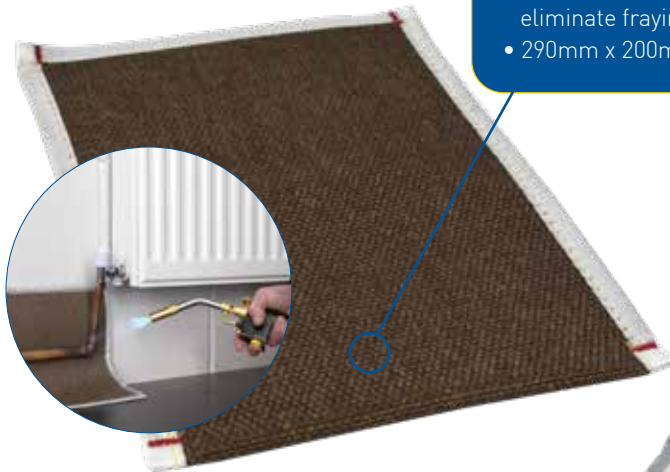

## KEY FEATURES

- Withstands temperatures up to 1200°C
- Multi-layered and double thickness construction
- Woven glass fibre edge binding to eliminate fraying
- 290mm x 200mm



# PROFESSIONAL HEAT MAT

Premium high temperature heat mat, offers extra protection when using high-temperature soldering and brazing equipment or when maximum heat protection is required. Highest rated heat mat in the range.

• **CODE: VPHM1**

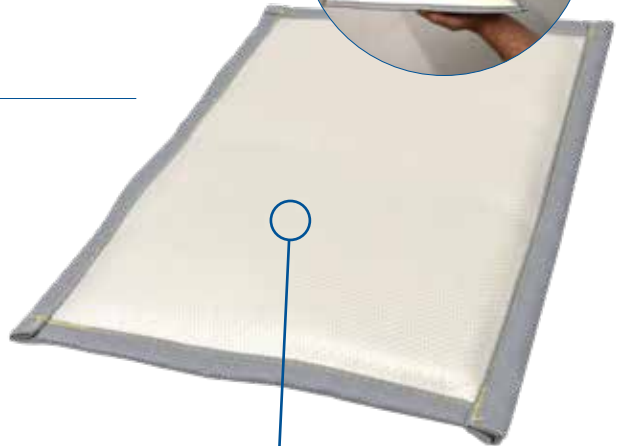

## KEY FEATURES

- Withstands temperatures up to 1800°C
- Multi-layered construction
- Extra protection against high temperatures
- 290mm x 200mm



'**DEMO**' video



# **CARBON MONOXIDE, SMOKE & HEAT DETECTION**

Essential protection against the dangers of carbon monoxide, heat and smoke.

## CARBON MONOXIDE, HEAT & SMOKE ALARMS

Pages: 91-100



## ALARM TESTERS

Pages: 101-102



A man in a blue shirt and apron is shown from the side, looking up and working on a white smoke alarm mounted on a ceiling. He is using a small black tool to adjust the alarm. The background is a light-colored ceiling with a grid pattern.

# **CARBON MONOXIDE, SMOKE & HEAT ALARMS**

Designed for all domestic environments  
such as homes, caravans and boats.

# 10 YEAR CARBON MONOXIDE ALARM

An easy to use and reliable self-contained carbon monoxide alarm. An essential product in all domestic environments such as homes, caravans and boats. The unit comes with a ten year warranty and a built-in battery.

• **CODE: COA10**



## KEY FEATURES

- 3 Visual LED readout
- Test / silence button
- Memory function
- Loud 85 decibel audible alarm
- Standby current: <12uA
- Alarm current: <30mA
- Operating temperature: 5 - 40°C
- Operating humidity: 20-90% R.H
- Sensor type: Electrochemical
- Lithium battery - 10 Year sealed for life
- Certified to BS EN 50291-1:2018 & BS EN 50291-2:2019

\*Should be installed by a competent person and is designed to protect individuals from the acute effects of carbon monoxide exposure. It will not fully safeguard individuals with specific medical conditions, however, if in doubt it is imperative that a medical practitioner is consulted.

# 7 YEAR CARBON MONOXIDE ALARM

This carbon monoxide alarm comes with a 7 year warranty and built-in battery. Ideal for homes, caravans, and boats the alarm warns against dangerous levels of the odourless, tasteless and colourless carbon monoxide gas.

• **CODE: COA7**



## KEY FEATURES

- 3 Visual LED readout
- Test / silence button
- Loud 85 decibel audible alarm
- Standby current: <math><2.5\mu\text{A}</math>
- Alarm current: <math><30\text{mA}</math>
- Operating temperature: 5 - 40°C
- Operating humidity: 20-90% R.H
- Sensor type: Electrochemical
- Lithium battery - 7 Year sealed for life
- Certified to BS EN 50291-1:2018 & BS EN 50291-2:2019

\*Should be installed by a competent person and is designed to protect individuals from the acute effects of carbon monoxide exposure. It will not fully safeguard individuals with specific medical conditions, however, if in doubt it is imperative that a medical practitioner is consulted.

# PERSONAL CARBON MONOXIDE ALARM

Lightweight, compact personal alarm for early detection of carbon monoxide. Ideal for heating engineers, emergency responders, for use at work, home or on holiday. Alarm activated when carbon monoxide levels exceed 30ppm.

• **CODE: PC01**

## KEY FEATURES

- Durable and shock resistant
- Powered by Li-ion battery
- Lightweight and compact
- 75dB audible alarm
- LED indicators
- 3 year sensor
- Sealed for life battery
- Free-standing design
- Belt clip and hanging hook



# VISUAL CARBON MONOXIDE PATCHES

Changes colour from red to black when exposed to carbon monoxide. This detector is recommended to be a supplementary / back up device to an audible alarm but can be used instead of an audible alarm.

• **CODE: PH019HC** - Single pack

• **CODE: PH019AC** - Twin pack

## KEY FEATURES

- Reacts to low-level Carbon Monoxide (<50ppm)
- Doesn't require batteries or mains power
- One colour change carbon monoxide
- Does not give audible alert



# WIRELESS INTERLINKED SMOKE & HEAT ALARMS!

The Smoke (SM10L) and Heat (HT10L) alarms are wireless interlinked with up to 40 devices.

• **CODE: SMHT3PK**

## KIT CONTAINS

- 1 x Heat alarm
- 2 x Smoke alarms

**X2**



## Smoke Alarm Specification:

- Power supply: CR17450 3V
- Lithium battery (sealed for life)
- 10 Years from activation
- Battery is not replaceable
- Sensor chamber protected by insect screen
- Interlink up to 40 devices
- Complies with:  
BS EN 14604:2005/AC:2008

## Sensitivity & Time:

- Alarm volume: >85dB at 3 meters
- Alarm sensitivity: 0.10 - 0.16dB /m
- Hush time: Approx 8 minutes



KM 694336  
BS EN14604:2005/AC:2008



**TRIPLE  
PACK!**

**WIRELESS INTERLINK  
UP TO 40 DEVICES!**



**X1**



### Heat Alarm Specification:

- Power supply: CR17450 3V
- Lithium battery (sealed for life)
- 10 Years from activation
- Battery is not replaceable
- Interlink up to 40 devices
- Complies with: BS EN 5446-2:2003

### Sensitivity & Time:

- Alarm volume: >85dB at 3 meters
- Alarm sensitivity: 54°C ~ 70°C
- Hush time: Approx 8 minutes



KM 715769  
BS 5446-2:2003

Meets requirements of 2022 Scottish legislation for fire alarms in homes.  
Suitable for installations complying to BS 5839-6 Grade F1.

# 10 YEAR WIRELESS INTERLINKED SMOKE ALARM

Keep safe with this Arctic Hayes Smoke Alarm. Photo optical technology reacts faster than alarms using ionisation technology where particles are smouldering giving advanced warning before flames take hold.

• CODE: SM10L



KM 694336

BS EN14604:2005/AC:2008



## KEY FEATURES

- Interlink up to 40 devices
- Test / silence button
- Sensor chamber protected by insect screen
- Alarm volume: 85dB at 3 meters
- Alarm sensitivity: 0.10-0.16dB/m
- Hush time: Approx 8 minutes
- Lithium battery - 10 Year sealed for life
- Certified to BS EN 14604:2005/AC:2008

Meets requirements of 2022 Scottish legislation for fire alarms in homes.  
Suitable for installations complying to BS 5839-6 Grade F1.

# 10 YEAR WIRELESS INTERLINKED HEAT ALARM

Keep safe with this Arctic Hayes Heat Alarm. The most advanced and reliable method of heat detection. For best protection heat alarms should be installed as part of a complete fire protection system.

• **CODE: HT10L**



## KEY FEATURES

- Interlink up to 40 devices
- Test / silence button
- High precision NTC thermistor
- Alarm volume: 85dB at 3 meters
- Alarm sensitivity: 54°C ~ 70°C
- Hush time: Approx 8 minutes
- Lithium battery - 10 Year sealed for life
- Certified to: BS 5446-2:2003

Meets requirements of 2022 Scottish legislation for fire alarms in homes.  
Suitable for installations complying to BS 5839-6 Grade F1.

# PHOTO-ELECTRIC SMOKE ALARM

An easy to use and reliable photoelectric smoke alarm. Toast-proof technology means less prone to false alarms caused by cooking fumes. An essential product in all domestic environments, designed for use in homes, caravans and boats.

• **CODE: SA1**



## KEY FEATURES

- Toast-proof technology
- Test / silence button
- Loud 85 decibel audible alarm
- Standby current: <math><12\mu\text{A}</math>
- Alarm current: <math><15\text{mA}</math>
- Operating temperature:  $-10 - 60^{\circ}\text{C}$
- Operating humidity: 95 RH ( $40 \pm 2^{\circ}\text{C}$ )
- Smoke Sensor Life: 3 Years
- Operates on a 9v battery (included)
- Certified to EN14604:2005

# 10 YEAR SMOKE & CARBON MONOXIDE ALARM

Combined carbon monoxide & smoke alarm is easy to use and self-contained. Designed for use in all domestic environments such as homes, caravans and boats, especially where space is limited. This two-in-one alarm tests for both carbon monoxide and smoke operating on a 9v battery.

• **CODE: COS10**



## KEY FEATURES

- 2 LED readouts
- Loud 85 decibel audible alarm
- CO alarm memory
- Standby current: <math>< 15\mu\text{A}</math>
- Alarm current: <math>< 30\text{mA}</math> Ambient
- Operating temperature: 5~40°C
- Operating humidity: 20~90%R.H
- CO sensor: Electrochemical
- CO sensor Life: 10 Years
- Smoke sensor Life: 10 Years
- Certified to EN14604:2005, EN50291-1:2018, EN50291-2:2019



# AEROSOL ALARM TESTERS

Simple and easy to use for designed to test smoke and carbon monoxide alarms.



# CARBON MONOXIDE ALARM TESTER

Contains low levels of carbon monoxide gas, sufficient to trigger a reaction from carbon monoxide sensors within carbon monoxide alarms.

- **CODE: PHC0520** - 400ml can

## KEY FEATURES

- Up to 7 tests per can
- Designed to test all carbon monoxide alarms
- Can be used to test Flue Gas Analysers
- Will not damage alarm sensors



# SMOKE ALARM TESTER

Designed to test the sensor in smoke alarms. Ensure your alarms are always in working order to protect your home or workplace.

- **CODE: PH043A** - 150ml can

## KEY FEATURES

- Testing of Smoke Alarms is recommended by the fire brigade
- Designed to test all smoke alarms
- Up to 40 tests per can





# **SERVICING** **ESSENTIALS**

From gauges and hoses to radiator servicing kits and asset protection.



## GAUGES & HOSES

Pages: 105-116



## RADIATOR SERVICING

Pages: 117-120



## ASSET PROTECTION & DUST SHEETS

Pages: 121-134



## ABRASIVES & BRUSHES

Pages: 135-143



## REPORT PAD, TAGS & LABELS

Pages: 145-146



## HEAT RESISTANT

Pages: 147-148



## SPECIALIST & IDENTIFICATION TAPES

Pages: 151-156



A large coil of dark blue hose is the central focus, set against a light blue background. The hose is coiled in a circular pattern, with a metal fitting visible at the top left and a black strap at the top right. The text is centered within the coil.

# GAUGES & HOSES

A range of water gauges, U-Gauges  
and testing accessories.

# U-FLOW WATER GAUGE

This innovated design enables simple measurement, with opposing flow-rate measures on each side of the body, so you can measure the flow rate in litres or gallons per minute. This is a vital piece of equipment when preparing a new installation. Simple to read and easy to use, this is a must-have for plumbers.

• **CODE: A888000**

## KEY FEATURES

- Compatible with the AH02 stem thermometer
- Measure in metric or imperial (L/GAL)
- Robust, heat resistant
- Flow measure range: 1-5 GAL & 4-22 L



'HOW-TO-USE' video



# WATER PRESSURE TEST GAUGE

Used to test water pressure in bar (0-11) or psi (0-160). The water pressure test gauge can also be connected to 1/2" or 3/4" male threads. Ideal for testing pipework prior to installation of appliances.

• CODE: WPG1

## KEY FEATURES

- 250mm robust braided hose
- Protective rubber boot on gauge
- Compatible with most standard domestic, garden & washing machine taps

# WATER PRESSURE TEST KIT

An all in one kit to test water, flow and temperature. (All sold separately)

• **CODE: WPTK3**



## KIT CONTAINS

- 1 x Water Pressure Test Gauge
- 1 x U-Flow Water Gauge
- 1 x Stem Thermometer

# U-VIEW U-GAUGES

Flexible manometer for testing gas service pressure testing on heating systems, these U-Flex Gauges are available in 3 sizes.

- **CODE: A664030** - 30Mbar / 12" WG
- **CODE: A664032** - 60Mbar / 24" WG
- **CODE: A664034** - 120Mbar / 48" WG



## KEY FEATURES

- Robust flexible tube
- Dual scale measures WG & Mbar
- Heavy duty metal fitting
- Zero adjustment



# U-VIEW U-GAUGES

The clear lid makes this U-Gauge easy to view, protects the scale and is always ready to use.

- **CODE: A664035** - 30Mbar gauge
- **CODE: A664036** - 60Mbar gauge



## KEY FEATURES

- Available in two sizes: 30Mbar / 12" WG, 60Mbar / 24" WG
- Non-spill sealing

# MANOMETER FLUID

Get quick and accurate gauge readings with manometer fluid from Arctic Hayes. 60ml bottle can be used with any U-Flow and U-Gauges.

- **CODE: A664018**

## KEY FEATURES

- Fills up to 60Mbar / 24" WG gauge
- De-ionised water wetting agent
- Algacide anti-foaming agent
- Anti-standing agent
- For use with U-Flow & U-Gauges



# 10L COLLAPSIBLE BUCKET

This compact, convenient, and versatile collapsible bucket beats the everyday standard bucket when storage is limited. Its portability makes this an essential tool if at work, home or play.

• **CODE: CWB10L**



## KEY FEATURES

- BPA-FREE
- Robust handle makes carrying easy
- Made from TPR & PP
- Pop-up to open when using and collapses to flat for space saving.
- Open sizes: base dia: 200mm  
bucket mouth dia:285mm, height: 250mm
- Space saving fold away o/a size:  
dia: 290mm, height: 330mm
- Weight: 518g



## 20L FOLDING BUCKET

This durable, flexible, folding bucket is great for everyday jobs if at work, home or play, with its durability guarantees long lasting performance.

• CODE: CWB20L



### KEY FEATURES

- Flexible handles make carrying easy
- Made from 500D PVC
- Perfect water carrier for all those plumbing & building jobs
- Open sizes: base dia: 290mm  
bucket mouth dia: 290mm, height: 300mm
- Space saving fold away o/a size:  
dia: 290mm, width: 140mm, height: 450mm
- Weight: 404g

# 14L POUR & SCOOP HEAVY DUTY BUCKET

If it's heavy duty, robust and versatility you need this is the bucket for you with an integrated scoop and pour functions, this is great for all jobs including carrying/pouring liquids, solids or semi-solids.

• **CODE: PSBUCK14L**

## KEY FEATURES

- 14 litre – 3-gallon Capacity
- Flat back scoop and easy pouring spout
- Metal handle and comfortable plastic hand grip
- Extra thick ribs to add strength
- Calibrated for gallons and litres
- Made in UK from 100% recycled plastics



# 14L HEAVY DUTY BUCKET

This rugged everyday bucket helps makes jobs easy with its balanced weight distribution and durability.

• **CODE: BUCK14L**

## KEY FEATURES

- 14 litre – 3-gallon Capacity
- Pouring spout allows allows pouring with minimal spillage
- Measuring scale on inside of bucket, litres & gallons
- Metal handle with plastic grip
- Made in UK from 100% recycled plastics



## 1/8" BORE SILICONE TUBE

- 2m Length
- Internal Diameter: 4mm (1/8")
- Outer Diameter: 8mm (5/16")
- Wall Thickness: 2mm (3/32")
- Suitable for natural gas (not LPG)
- Suitable for use with U-Gauges & U-Flow Gauges
- **CODE: A664048**



## 1/4" BORE RUBBER HOSE

- 2m & 20m Lengths
- Internal Diameter: 6mm (1/4")
- Outer Diameter: 10mm (3/8")
- Wall Thickness: 1.65mm (1/16")
- Suitable for natural gas (not LPG)
- Suitable for use with U-Gauges & U-Flow Gauges
- **CODE: A664050** - 2 metre
- **CODE: A664054** - 20 metre



## 1/4" BORE NEOPRENE HOSE

- 2m & 20m Lengths
- Internal Diameter: 6mm (1/4")
- Outer Diameter: 10mm (3/8")
- Wall Thickness: 1.65mm (1/16")
- Suitable for use with LPG & natural gas
- Suitable for use with U-Gauges & U-Flow Gauges
- **CODE: A664051** - 2 metre
- **CODE: A664053** - 20 metre



# 10m & 15m DRAIN DOWN HOSES

Internal diameter: 1/2" outer diameter 3/4" (12.7mm ID x 19.05mm OD)

Made from flexible and tough natural red-rubber hose that will not kink or tear with regular use.

- **CODE: A664047** - 10 metre
- **CODE: 664047-15** - 15 metre

**NO  
KINKS!**

## KIT CONTAINS

- 1 x 10m or 15m rubber hose
- 1 x Thumb screw hose clip
- 2 x Reusable velcro ties

# 10m DRAIN DOWN HOSE & CARRY BAG

Perfect waterproof storage solution for your drain down hose kit with strong handles for easy carrying.

- **CODE: 664047-BAG** - Bag only
- **CODE: A664047-PROMO** - Bag & 10m hose



A person is shown from the side, kneeling on a blue carpeted floor. They are using a black adjustable wrench to work on a radiator. A white radiator valve is visible, and a stream of water is dripping from it into a bright green rectangular plastic tray placed on the floor. The background is a light-colored wall with vertical blinds. The entire image has a blue color overlay.

# **RADIATOR** **SERVICING**

Essential servicing equipment to keep radiators in top condition.

# RADIATOR DRAINING KIT

Helps avoid unnecessary mess, damage to floors and carpets from spillage. For maximum protection always work with absorbent sheeting.

Universal kit applies to 8mm to 22mm pipe bores.

• **CODE: DT1**

## KIT CONTAINS

- 1 x Draining tray
- 4 x Water diverting collars
- 4 x Reusable sealing straps
- 1 x Water resistant barrier gel sachet
- 1 x Step-by-step detailed instructions



## 1.5 LITRE ABSORBENT SHEETS

**5 PACK!**

Ideal for when repairing leaking boilers, servicing radiators, repairing taps and washing machines.

• **CODE: A445027**

### KEY FEATURES

- Ultra absorbent
- Holds 1.5 / 2 litres of water
- Size: 900mm x 600mm
- Pack of 5





## RADIATOR VALVE CHANGE KIT

Used for changing radiator valves without draining down, use on 15mm & 22mm pipework.

• **CODE: A664130**



## RADIATOR BLEED KEY

Brass radiator air vent key with easy to turn clock key type handle for releasing air from water filled radiators.

• **CODE: A66058**

## 10m & 15m DRAIN DOWN HOSES

Internal diameter: 1/2" outer diameter 3/4" (12.7mm ID x 19.05mm OD)

Made from flexible and tough natural red-rubber hose that will not kink or tear with regular use.

• **CODE: A664047** - 10 metre

• **CODE: A664047-15** - 15 metre

### KIT CONTAINS

- 1 x 10m or 15m rubber hose
- 1 x Thumb screw hose clip
- 2 x Reusable velcro ties





# EASI BLEED DRAINING KIT

A simple solution for broken radiator bleed valves. It can be used on any radiator. You do not need to drill any pilot holes in the radiator as the product is designed to self drill into the radiator wall.

• **CODE: AHEB2**



**DAMAGED BLEED VALVE**



# ASSET PROTECTION & DUST SHEETS

High quality asset protection for  
floors, surfaces and furniture.

# PROFESSIONAL WORK MATS

All Arctic Hayes work mats are resistant to oil, water, bleaches, detergents, heating additives and more. Can be used for internal and external use. 100% polyester, professional work mats are waterproof and anti-slip. All mats come with a free storage bag.



# SMALL, MEDIUM & LARGE WORK MATS

- **CODE: WM1** - 1200mm x 750mm
- **CODE: WM2** - 1800mm x 850mm
- **CODE: WM3** - 1800mm x 1500mm

## KEY FEATURES

- Resistant to a number of chemicals including bleaches, detergents, solvents
- Water & oil resistant
- Anti-slip
- Waterproof & washable
- For interior or exterior use
- Handy slits for working around pipes
- Includes a free storage bag



**ARCTIC  
HAYES**  
**WORK MAT**  
1800mm x 850mm

**ARCTIC  
HAYES**

# TRADESMAN'S RUNNER

• CODE: WM4 - 3200mm x 700mm

## KEY FEATURES

- Resistant to a number of chemicals including bleaches, detergents & solvents
- Water & oil resistant
- Anti-slip
- Waterproof & washable
- For interior or exterior use
- Includes a free storage bag

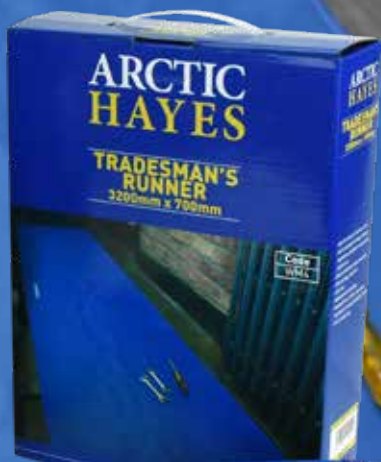



## FOAM RUBBER KNEELING MAT

An essential tool for every plumber and trades person. Helps to protect knees from hard surfaces and flooring during routine maintenance work.

• **CODE: KM2** - 463mm x 215mm

### KEY FEATURES

- 30mm thickness
- 100% NBR Foam rubber
- Light weight
- Anti-slip
- Wipe clean
- Interior/Exterior use



# KNEELING MAT

Helps to protect knees from hard surfaces and flooring during routine maintenance work.

• **CODE: KM463** - 463mm x 215mm

## KEY FEATURES

- 30mm thickness
- 100% NBR Foam rubber
- Light weight, anti-slip & wipe clean
- Interior/Exterior use



# PADDED KNEELING MAT

An essential tool for every plumber and trades person. Helps to protect knees from hard surfaces and flooring during routine maintenance work.

• **CODE: KM1** - 455mm x 250mm

## KEY FEATURES

- Easy storage
- Thick foam construction



# SURFACE PROTECTOR

A thick, foam-backed mat ideal for protecting all work surfaces from tools.

• **CODE: SP1** - 900mm x 670mm

## KEY FEATURES

- Wipe-able for long life
- Waterproof to prevent leak-through



# PREMIUM MAINTENANCE MATS

Premium, heavy-duty work and maintenance mat ideal for working around radiators. Suitable for both interior and exterior work.

- **CODE: PMM1** - 1350mm x 800mm
- **CODE: PMM2** - 1350mm x 2000mm

## KEY FEATURES

- Waterproof & wipe-able
- Handy slits for around pipes
- Absorbent to prevent spillages



# PREMIUM PLUMBERS RUNNER

Premium, heavy-duty work and maintenance mat ideal for hallways or long length floors. Suitable for both interior and exterior work.

- **CODE: PPR1** - 3500mm x 670mm

## KEY FEATURES

- Used by all trades
- Absorbent to prevent spillages





# 100m CARPET PROTECTOR

100m roll of self-adhesive floor protector ideal for protecting carpets during DIY or maintenance work. The easy-peel adhesive is strong enough to stick to carpets and stay in place during work without damaging pile when removed.

**Not suitable for use on hard floors.**

• **CODE: A666019** - 520mm x 100m

FOR TEMPORARY USE ONLY. Replace within 14 days for normal traffic areas, and within 7 days for high traffic areas.

## KEY FEATURES

- Super tough polythene film
- Protects carpets from dirt and spillages
- Ideal for home decorating and DIY purposes

\*\*\*READ FULL INSTRUCTIONS ON WHERE TO USE/NOT TO USE

# 25m & 50m CARPET PROTECTOR

Excellent protection for carpets during refurbishment and decoration. Every tradesman should have some!

- **CODE: CP1** - 600mm x 25m
- **CODE: CP1-50M** - 600mm x 50m



## KEY FEATURES

- Self adhesive
- Rip-resistant construction
- Quick and simple to apply and remove

FOR TEMPORARY USE ONLY. Replace within 14 days for normal traffic areas, and within 7 days for high traffic areas or in direct sunlight.

\*\*\*READ FULL INSTRUCTIONS ON WHERE TO USE/NOT TO USE

# 25m & 50m **HARD FLOOR PROTECTOR**

Excellent protection for hard-floors during refurbishment and decoration. Every tradesman should have some!

- **CODE: HFP1** - 600mm x 25m
- **CODE: HFP1-50M** - 600mm x 50m



FOR TEMPORARY USE ONLY. Do not leave film in place for longer than 30 days for normal traffic areas, replace within 14 days for high traffic areas or in direct sunlight.

## **KEY FEATURES**

- Suitable for most hard floors
- Rip-resistant construction
- Quick and simple to apply and remove

\*\*\*READ FULL INSTRUCTIONS ON WHERE TO USE/NOT TO USE

# **HARD FLOOR & CARPET PROTECTOR DISPLAY**

We highly recommend ordering in the display box for maximum impact!

- **CODE: FPDB1**

## **KITS CONTAIN**

- 1 x Display box
- 3 x Hard floor protector (HFP1)
- 6 x Carpet protector (CP1)



## 1.5 LITRE ABSORBENT SHEETS



### KEY FEATURES

- Ultra absorbent
- Holds 1.5 / 2 litres of water
- Size: 900mm x 600mm
- **CODE: A445027**

# 5 PACK!

## LAMINATED DUST SHEET

### KEY FEATURES

- Multi-purpose & reusable
- Machine washable
- Highly absorbent
- Water and paint resistant
- Polythene backing
- 3.6m x 2.8m (12' x 9')
- **CODE: A666013**



## HEAVY DUTY CALICO DUST SHEET

### KEY FEATURES

- 100% cotton
- Multi-purpose & reusable
- Machine washable
- Hard-wearing
- Home or industrial applications
- 3.6m x 2.8m (12' x 9')
- **CODE: A666012**



# COTTON TWILL DUST SHEET

Protect floors and carpets during painting or other maintenance work with our cotton twill dust sheet. Suitable for use in the home or industrial applications, machine washable and reusable.

• **CODE: AD62822**

## KEY FEATURES

- 100% natural cotton
- Multi-purpose & reusable
- Can be used to protect furniture
- Machine washable
- Professional quality
- 3.6m x 2.8m (12' x 9')



# STAIR RUNNER COTTON DUST SHEET

Protect your stairs or hallway during painting or other maintenance work with our cotton stair runner dust sheet. Medium duty, suitable for use in the home or for industrial applications.

• **CODE: A666009**

## KEY FEATURES

- 100% natural cotton
- Reusable and durable
- Machine washable
- 7.3m x 0.9m (24' x 3')



## SPRING LOADED STAIR RODS

Telescopic rods for use on stairs to hold dust sheets or plumbers runners to help reduce the possibility of trips and slips.

• **CODE: A666030**

## KEY FEATURES

- Holds dust sheets and other types of sheeting into the foot well of each stair
- Use time and time again
- Handy bag with shoulder straps
- Set of 14 spring loaded rods

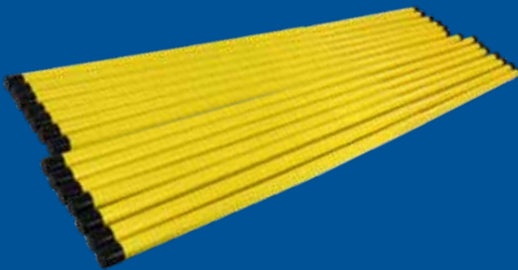

# WHITE SHOWER CURTAINS

- **CODE: A211001** - 1800mm drop, 1800mm width
- **CODE: A211002** - 2000mm drop, 1800mm width

## KEY FEATURES

- CIBA antibacterial & fungal protection
- Rust resistant metal eyelets
- Easy clean & machine washable
- Water resistant 100% polyester fabric
- Cling resistant weighted hem



\*Rings and pole not included.

# WORK IN PROGRESS DOOR BANNER & ROD

Place across doorways to stop people entering whilst work is being carried out. Spring loaded for added tension. Safety sign measures 450mm x 450mm with an adjustable rod measuring 550mm - 900mm.

- **CODE: WIPI** - Door banner & rod
- **CODE: WIPS** - Door banner only
- **CODE: DWBRODS-12** - Rod only



# **ABRASIVES & BRUSHES**

High quality products for specialist  
cleaning applications.



# HEAT EXCHANGER CLEANING BLADES

Velcro blade specially designed for cleaning flue deposits from heat exchange fins.

- **CODE: A664150** - 200mm
- **CODE: A664151** - 400mm

## KEY FEATURES

- Light-weight
- Durable velcro cleaning surface
- Double-ended for extended life and usability
- Less damage to heat exchangers than other cleaning materials



# VELCRO BLADE

200mm Velcro blade specially designed for cleaning flue deposits from heat exchange fins.

- **CODE: A664152** - 200mm

## KEY FEATURES

- Light-weight
- Durable velcro cleaning surface
- Screw fit block end
- Less damage to heat exchangers than other cleaning materials



# WATERPROOF ABRASIVE CARBIDE STRIPS

Long-lasting, waterproof, non clogging silicone carbide abrasive strips. Perfect for cleaning copper tubes before soldering or roughing up plastic pipes before jointing.

• **CODE: A662100**

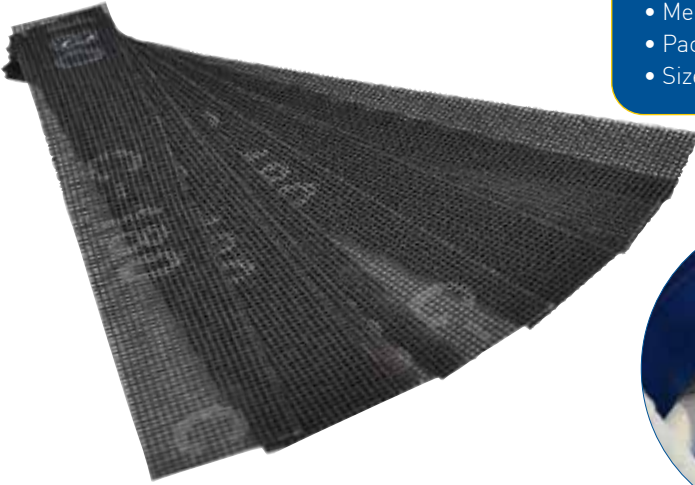

## KEY FEATURES

- Medium grade - 180 grit
- Pack of 10
- Size: 38mm x 250mm



# WATERPROOF ABRASIVE CARBIDE ROLL

Continuous roll of silicone carbide abrasive, perfect for cleaning copper tubes before soldering, or roughing up plastic pipes before jointing. Lengths can be cut to size.

• **CODE: A662102**

## KEY FEATURES

- Medium grade - 180 grit
- Size: 38mm x 5m

## EMERY CLOTH

Durable and flexible J-weight Emery Cloth 180 Grit. Produced from Aluminium Oxide, resin bonded for improved grit adhesion giving longer lasting anti-static capabilities.

• **CODE: EC50**

### KEY FEATURES

- Medium grade - 180 grit
- Size: 50mm x 50m



## STEEL WOOL

0.45kg medium Grade 1 steel wool for general purpose work, cleaning of copper pipes and plumbing fittings, paint removal, paint and metal preparation such as car bodywork.

• **CODE: WB28**



## STEEL WOOL PADS

Pack of 8 medium Grade 1 steel wool pads for general purpose work, cleaning of copper pipes and plumbing fittings, paint removal, paint and metal preparation such as car bodywork.

• **CODE: WB8**



# COPPER FITTING CLEANING BRUSHES

Steel wire brush perfectly designed for cleaning internal copper fittings and pipes. Ideal for use on pipe jointing and when changing fittings on copper pipe-work.

- **CODE: A664113** - 10mm
- **CODE: A664114** - 15mm
- **CODE: A664112** - 22mm
- **CODE: A664116** - 28mm

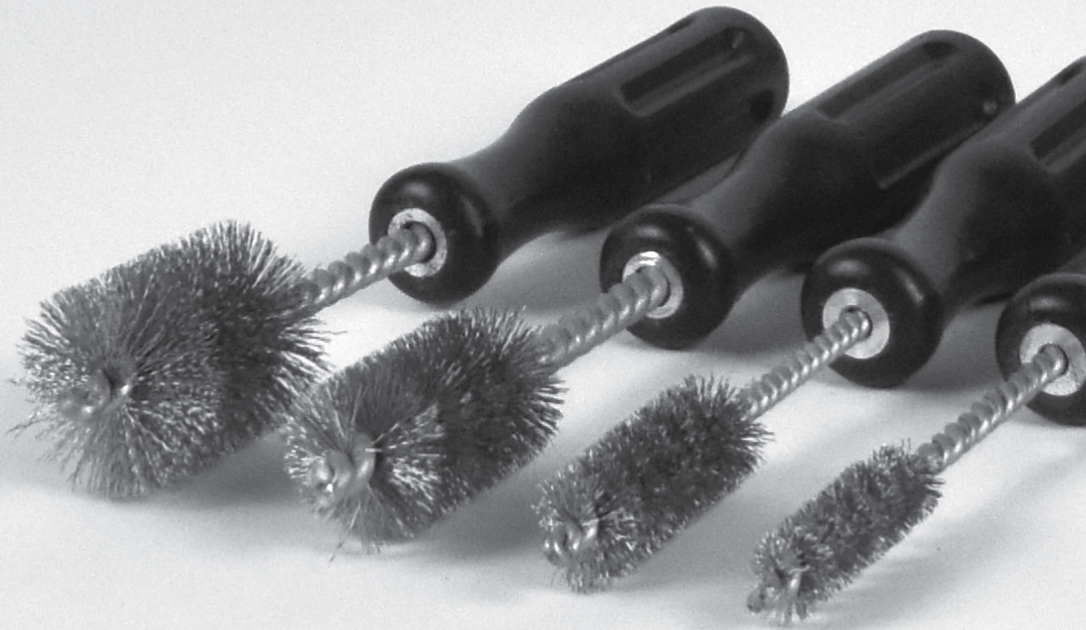

## KEY FEATURES

- For cleaning internal pipes and fittings
- Steel wire brush heads
- 4 sizes: 10mm, 15mm, 22mm & 28mm

# 4-IN-1 PIPE CLEANING QUAD BRUSH

This unique 4-in-1 wire brush is both light and ergonomic. Features two different bore sizes and is suitable for cleaning copper pipes both internal & external.

• CODE: A66060

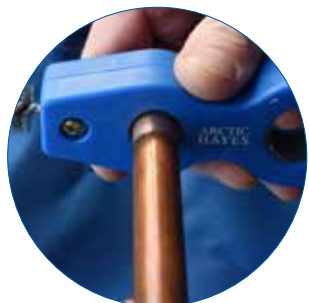

## KEY FEATURES

- Fits 15mm & 22mm copper pipes
- Lightweight and portable
- Hard wearing and durable



## 3 PIECE FLUE BRUSH SET

3 piece flue brush set of various sizes and shapes for easy flue cleaning and brushing.

• **CODE: A664105**

### SET CONTAINS

- 1 x 50mm diameter nylon brush with 405mm long loop handle
- 1 x 50mm x 15mm flat brush with 405mm long loop handle
- 1 x 15mm diameter brush with 405mm long loop handle

## 7 PIECE PREMIUM FLUE BRUSH SET



7 piece premium flue brush cleaning rod and head set in various lengths to accommodate various size or shape flues.

• **CODE: A664109**

### SET CONTAINS

- 1 x 305mm handle
- 1 x 305mm handle extension rod
- 1 x brush head, nylon (15mm dia x 150mm long)
- 1 x brush head, nylon (25mm dia x 72mm long)
- 1 x brush head, nylon (50mm dia x 150mm long)
- 1 x brush head, steel (20mm dia x 56mm long)
- 1 x brush head, soft bronze (15mm dia x 56mm long)

# 7 PIECE DOMESTIC FLUE BRUSH SET

7 piece flue brush cleaning rod and head set in various lengths to accommodate various size or shape flues.

• **CODE: A664107**

## SET CONTAINS

- 1 x 305mm handle
- 1 x 125mm handle
- 1 x 305mm extension rod
- 1 x brush elliptical head, nylon (50mm dia x 305mm long)
- 1 x brush head, nylon (50mm dia x 203mm long)
- 1 x brush head, nylon (50mm dia x 12.5mm long)
- 1 x 305mm flat cleaning blade



# FLUX BRUSHES

Specially shaped for applying flux or glue onto joints and threads. Ideal for use when coating copper fittings, connections and pipe-work.

- **CODE: A66054** - Tub of 3
- **CODE: A66056** - Pack of 10
- **CODE: A66055** - Tub of 25



## KEY FEATURES

- 200mm length
- 30mm bristle length





# BOOST YOUR SALES & MARGINS

High Margin, Fast Moving Product Lines!

## MERCHANDISING STAND

- Display **best-selling** Arctic Hayes tools and consumables for the heating and plumbing market on a high quality durable light up **display stand**.
- **High-quality**, engaging and colourful point of sale display stands can have a huge impact on sales figures.
- Make the **right impression**, drive impulse purchases and grab customers attention!
- **Risk-free!** Regular stock reviews and the ability to swap non-moving stock for new lines.
- Initial stock order **support** available.



A hand holding a pen, with a blue overlay and text. The background is a solid blue color. A hand is holding a pen, with the pen tip pointing towards the bottom left. The text is overlaid on the image.

# **REPORT PAD** **TAGS OR LABELS**

Stay safe, organised and complaint.

# LANDLORD & HOMEOWNERS RECORD PAD

Suitable for landlord inspections, servicing and appliance checks for homes and caravans. Issued in accordance with the gas safety regulations for installation and use.

• CODE: 663010-NUM



## KEY FEATURES

- Pad of 25 A4 forms in triplicate
- Sequentially numbered

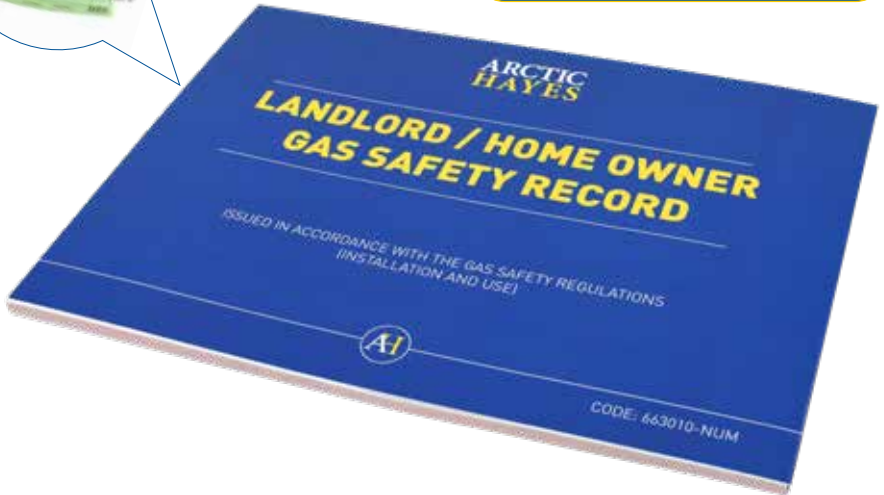

# DANGER SAFETY WARNING DO NOT USE LABELS

• CODE: A663060

## KEY FEATURES

- Can be used as label or tag
- Pack contains 10 labels and 10 strong zip ties





# HEAT RESISTANT PRODUCTS

Quality restoration and maintenance products.

## 125ml HIGH TEMP ROPE ADHESIVE

A specially formulated high temperature rope fixative adhesive designed for fixing thermal rope/tape and ceramic fibre seal to oven, stove and boiler doors.

• **CODE: A661014**

### KEY FEATURES

- Liquid adhesive
- For use with our braided glass yarn
- Temperature resistant up to 1250°C



## BRAIDED GLASS YARN

Asbestos-free braided glass yarn for high temperature sealing in flues, boilers, stoves, ovens and other heating applications. Maximum working temperature 600°C.

- **CODE: ROPE6MM**- 6mm x 2m
- **CODE: A661020**- 6mm x 5m
- **CODE: A661021**- 6mm x 10m
- **CODE: ROPE10MM**- 10mm x 2m
- **CODE: A661022**- 10mm x 5m
- **CODE: A661023**- 10mm x 10m
- **CODE: A661024**- 12mm x 5m



## BRAIDED GLASS YARN KIT

- **CODE: ROPEKIT6**- 6mm x 2m & 125ml adhesive
- **CODE: ROPEKIT10**- 10mm x 2m & 125ml adhesive



A large roll of white tape is shown in the lower half of the image, set against a solid blue background. The tape is unrolled slightly, showing its texture and the inner core. The top half of the image is a plain blue gradient.

# **SPECIALIST &** **IDENTIFICATION TAPES**

Various tapes used daily by DIY and trade professionals.

## **SPECIALIST TAPES**

Pages: 151-154



## **IDENTIFICATION TAPES**

Pages: 155-156





# **SPECIALIST TAPES**

Tapes to carry out all your plumbing applications.



# 12m STANDARD PTFE TAPE

Specially designed to help seal threads on fittings. Suitable for use on water and oxygen lines, taps and fittings. Not suitable for use with gas lines or gas fittings.

• **CODE: A662016**

## KEY FEATURES

- Approved to EN751-3:2022
- Non-flammable thread sealant
- Resistant to all acids, alkalis and solvents
- Suitable for use with oxygen lines and drinking water
- Size: 12mm x 12m



# 5m GAS PTFE TAPE

High density, EN certified gas PTFE thread sealant tape. Suitable for use on gas and oil lines, taps and fittings.

• **CODE: A662014**

## KEY FEATURES

- Approved to EN751-3:2022
- Suitable for threads up to 50mm
- Size: 12mm x 5m





## ALUMINIUM FOIL TAPE

45m roll of aluminium foil tape. Superior to duct tape and recommended for use where a moisture barrier is required as well as low temperature resistance.

• **CODE: A662021** - 40µm tape

### KEY FEATURES

- 50mm wide
- 45m length roll
- 40µm thickness

---

## PRS10 50mm CLOSURE PLATE TAPE

A specially manufactured tape for the secure and safe sealing of gas fire back-plates.

• **CODE: A662012** - 50mm x 25m

### KEY FEATURES

- Meets requirements of 10.3.2.1A
- Service temperature 5°C to 100°C



# SILICONE REPAIR TAPE

Resistant to petrol, oils, acids, solvents, salt water and UV rays, this silicone repair tape is an excellent electrical insulator ready to repair most plumbing jobs.

• **CODE: A662018** - 3m

## KEY FEATURES

- Withstands extreme temperatures from -65°C to 260°C
- Withstands pressure up to 700psi
- Excellent electrical insulator up to 8000V



# 25mm & 50mm GENERAL PURPOSE CLOTH TAPE

Adhesive tape with a hard-wearing cloth backing. Durable and flexible tape ideal for general purpose jointing, sealing, repairing, bundling and joining polythene sheeting.

• **CODE: 662020-25** - 25mm x 50m

• **CODE: A662020** - 50mm x 50m

## KEY FEATURES

- Service temperature range: -20°C to +60°C
- Colour: Silver





# **IDENTIFICATION TAPES**

Tapes to keep you safe and compliant.

# GAS ID TAPES

This gas pipeline identification tape is printed with the basic identification colours as emphasised by Health & Safety Regulations. Should be applied to any gas installation.

**CODE: 662030-50M** - 50mm x 50m

**CODE: A662036** - 38mm x 33m





# SERVICING TOOLS

A range of premium quality tools  
designed to make the job easier.

## PIPE CUTTERS & BENDERS

Pages: 159-164



## TEST PUMP & ACCESSORIES

Pages: 165-169



## SERVICING TOOLS

Pages: 171-176





# PIPE CUTTERS & BENDERS

Widely used for all aspects of plumbing work, air conditioning, ventilation systems and more.





## 6mm-38mm DEBURRER

The Arctic Hayes deburring tool quickly and neatly deburrs internal/external pipes 6mm - 38mm. For use on plastic, copper, aluminium and brass pipes.

• **CODE: DEBURR1**

### KEY FEATURES

- Internal/External deburring tool
- Zinc alloy cutting blades
- Ergonomic design
- Quick and efficient
- Robust PP outer



# U-CUT PIPE CUTTERS

Don't waste time trying to cut pipes that you cannot get to with conventional blades! Get quick, neat cuts with these specially designed pipe cutters with a small body that allows movement in tight jobs.

- **CODE: A443001** - 15mm
- **CODE: A443002** - 22mm
- **CODE: A443004** - 15mm & 22mm (twin pack)
- **CODE: A443005** - 15mm & 22mm spare wheels



## KEY FEATURES

- Heavy duty zinc die-cast body
- Hardened and tempered steel cutting wheel
- Supplied with spare cutting wheel
- Available in 15mm & 22mm

# U-CUT PIPE CUTTERS



# PROFESSIONAL PIPE BENDER

This high-quality professional pipe bender is perfect for both 15mm and 22mm copper & light grade stainless steel pipes. Create ripple free and precise bends with this heavy duty and durable professional tool.

• **CODE: PB1522**

## KEY FEATURES

- Supplied with 15mm & 22mm aluminium die cast formers
- Non-slip handle is comfortable to grip and operate
- Widely used in plumbing, air conditioning, ventilation systems, automotive heating systems and more





## PROFESSIONAL MINI PIPE BENDER

Made from durable aluminium. With its ergonomic handle design, it accurately bends 6mm, 8mm & 10mm pipes up to 180°

• **CODE: PB6810**

### KEY FEATURES

- 3-in-1 180° pipe bender
- Create ripple-free precise bends
- Widely used in plumbing, air conditioning, ventilation systems, automotive heating systems and more





# TEST PUMP & ACCESSORIES

A superior pressure vessel pump  
and adapters.

## DIGITAL PRESSURE VESSEL HAND PUMP

Easy to read, accurate and is made from a robust aluminium tube with strong ABS plastic parts with a long 3m hose. Ideal when working in hard to reach places such as charging expansion vessels on boilers.

• **CODE: DHP1**

**3m  
HOSE!**

### KEY FEATURES

- 4 x pressure range units: PSI, BAR, KPA, KG/CM<sup>2</sup>
- Range: 0.0 - 8BAR (to 0.1 decimal place)
- Sturdy footplate
- 3 x Spare adaptors



# PRESSURE SERVICE KIT

Designed for use to repair Schrader valves.

• **CODE: PSK22**



## KIT CONTAINS

- 1 x Schrader core removal tool
- 1 x Multi function core removal tool
- 10 x Schrader cores
- 10 x Dust caps



# EXPANSION PRESSURE VESSEL SERVICE KIT

Schrader extension and small repair kit when working on pressure vessels.

• **CODE: A221004**



## KIT CONTAINS

- 1 x 180mm Pressure Vessel Angle Adaptor
- 1 x Schrader core removal tool
- 3 x Schrader cores

\*All kits are compatible with Digital Hand Pump (DHP1)



## 150mm PRESSURE VESSEL STRAIGHT ADAPTOR

### KEY FEATURES

- Help access those difficult to reach pressure vessel valves
- Male / Female Schrader connections
- Length: 150mm
- **CODE: EXT100**



## 180mm PRESSURE VESSEL ANGLE ADAPTOR

### KEY FEATURES

- Help access those difficult to reach pressure vessel valves
- Male / Female Schrader connections
- Length: 180mm
- **CODE: ANG180**



## 450mm PRESSURE VESSEL STRAIGHT ADAPTOR

### KEY FEATURES

- Help access those difficult to reach pressure vessel valves
- Quick release female Schrader connection
- Length: 450mm
- **CODE: EXT450**



\*All adaptors are compatible with Digital Hand Pump (DHP1)

# 1200mm PRESSURE VESSEL LONG ADAPTOR

## KEY FEATURES

- Help access those difficult to reach pressure vessel valves
- Quick release female Schrader connection
- Length: 1200mm
- **CODE: EXT1200**



# PRESSURE TEST NIPPLES

## KEY FEATURES

- Facilitate the checking of pressure
- Small hole restricts gas flow
- **CODE: A664040** - Pack of 3
- **CODE: 664040-U** - Single

# GAS PRESSURE TEST TEE KIT

## KEY FEATURES

- 3 way pressure test tee with pump & hose
- Consists of a 1/4" BSPT fitting on a 3 way test tee with 200mm of hose and a hand pump
- Used to pressurise and check the soundness of gas pipework in conjunction with a U-Gauge
- **CODE: A664043**



# CHECK OUT OUR WEBSITE!

With over 450 products available

Find out Frequently Asked Questions

NEW Freeze Selector, which freeze is best for you!

News, reviews and information

Partnership opportunities

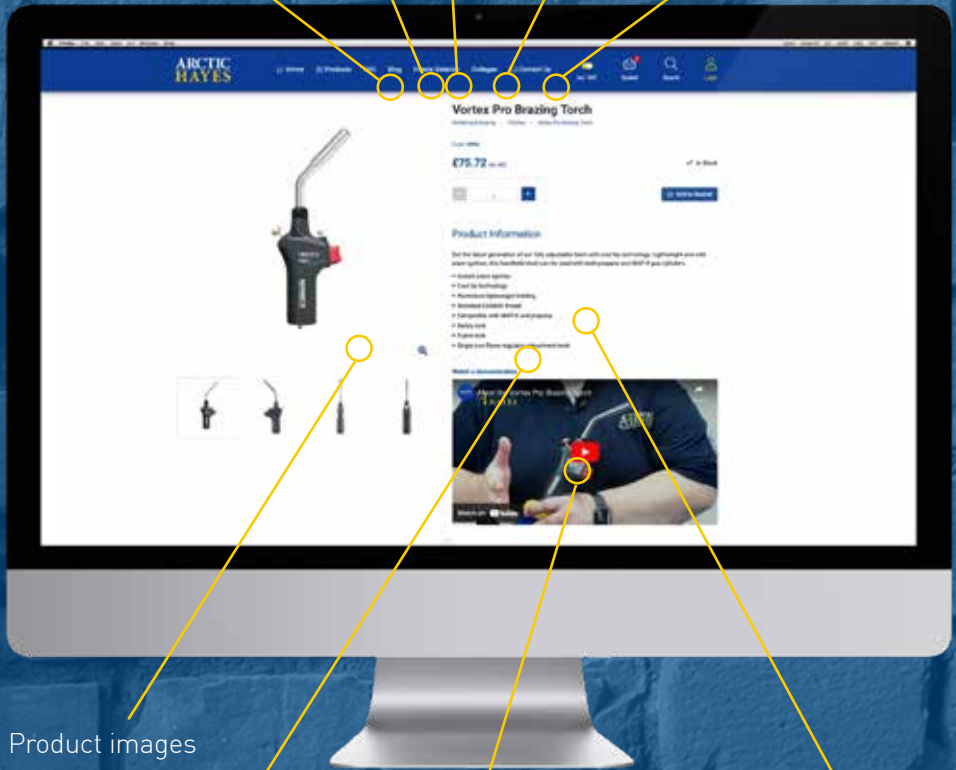

Product images

Download safety data sheets

Watch how-to-use videos

Full product information

[www.arctic-hayes.com](http://www.arctic-hayes.com)



# SERVICING TOOLS

High quality tools that help you do the job accurately, quickly and safely.

# HEAVY DUTY CONTINUITY BONDS

Provide a temporary continuity to earth when disconnecting or connecting gas pipes with heavy duty continuity bonds. This product is manufactured using flexible multi-strand 10mm<sup>2</sup> cable to conform to current Gas Safety Regulations.

• **CODE: 664015-BG**

## KEY FEATURES

- 1.2m PVC cable
- For pipes up to 25mm diameter
- Rated to 150A / 250V
- Fully coated handles for extra protection

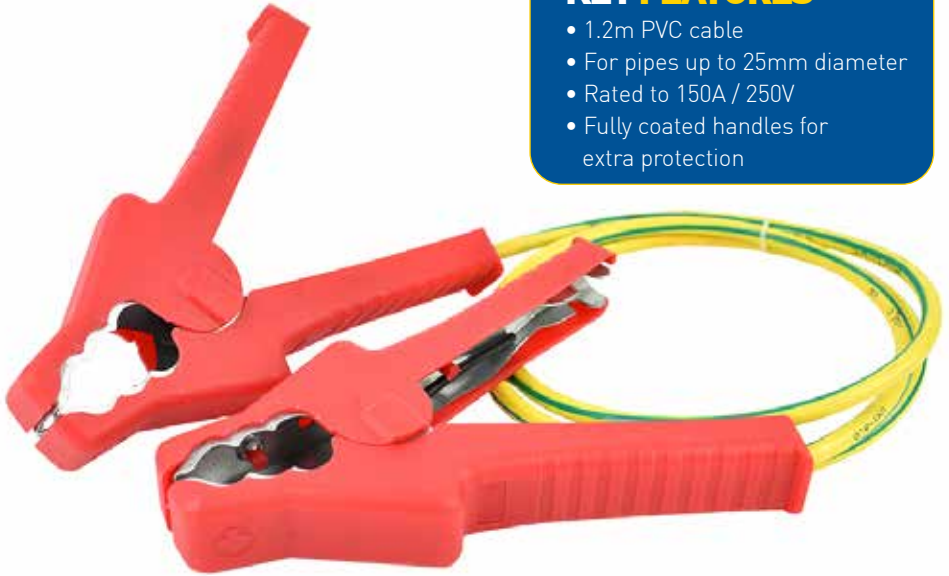

# ECONOMY CONTINUITY BONDS

## KEY FEATURES

- Provide a temporary continuity to earth when connecting / disconnecting gas pipes
- 1.2m PVC cable
- For pipes up to 25mm dia
- Rated to 150A / 250V
- **CODE: A664016**



# MORE THAN JUST YOUR AVERAGE MAGNETIC TAPES MEASURES

8 metre tape measures are impact resistant with ABS with TPR injection, These tape measures have a 25mm blade with a 0.12mm thickness and also anti rust coated. CLASS II accurate within 0.7mm over 2m.

• **CODE: TAPE825** - 8 metre

Blade Lock



Belt Clip



Anti-Rust



Double Magnetic  
Hook



Double Sided  
Measurement



Metric & Imperial  
Measurement

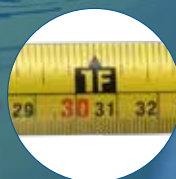

## 200mm (8") ADJUSTABLE WRENCH

A high-quality smooth action 200mm (8") adjustable wrench with a comfortable grip. Save time swapping spanners for different sized nuts. This essential tool will help you on a wide range of plumbing jobs.

• **CODE: AW8**

### KEY FEATURES

- 38mm wide jaw
- Chrome vanadium steel
- Slimline deep reach jaws



## LONG REACH SCREWDRIVERS

### KEY FEATURES

- 1 x 300mm slotted screwdriver
- 1 x 300mm PD2 screwdriver
- Chrome vanadium steel
- Twin density handle
- Magnetic tip
- **CODE: A66008**



## MONOBLOC SPANNERS WITH TOMMY BAR

### KIT FEATURES

- 3 x Spanners (8-9mm, 10-11mm, 12-13mm)
- 1 x Tommy bar
- Release and tighten bolts
- Carbon structural steel
- **CODE: MBS3**



## 4-IN-1 UNIVERSAL STOPCOCK KEY

The Arctic Hayes 4-in-1 Universal Stockcock Key is manufactured from galvanised steel with a robust cast iron head.



### KEY FEATURES

- Galvanised steel with a robust cast head
- High torque T-bar handle
- Also used to lift access covers
- **CODE: SCK41**

## COOKER STABILITY CHAIN QUICK RELEASE

### KEY FEATURES

- For installation of domestic gas cooking appliances
- Fitted with snap hook for quick release
- **CODE: A663100**





## METAL MAGNETIC TRAY

Perfect for keeping small metal objects in one place such as nuts, bolts and screws. Won't mark surfaces and can be attached vertically.

• **CODE: MAG1**

### KEY FEATURES

- Soft rubber magnets won't mark surfaces
- Strong magnet technology for holding small metal objects
- 150mm x 65mm



## ABS PLASTIC MAGNETIC BOWL

Perfect for keeping small metal objects in one place such as nuts, bolts and screws. Won't mark surfaces.

• **CODE: MAG2**

### KEY FEATURES

- Premium quality ABS plastic
- Strong magnet technology for holding small metal objects
- 109mm x 78mm



## MAGNETIC PEN-STYLE PICK UP TOOL

### KEY FEATURES

- Magnetic tip with pocket clip
  - Extendible telescopic rod
  - Pen style design
  - Pick up weight: 2.7kg
- **CODE: A664000**





# MAGNETIC FILTERS, SCALE REDUCERS & ACCESSORIES

Domestic, commercial and industrial magnetic  
and scale filtration systems.

## DOMESTIC PRODUCTS

Pages: 179-189



## COMMERCIAL PRODUCTS

Pages: 191-193



## INDUSTRIAL PRODUCTS

Pages: 195-196





# DOMESTIC PRODUCTS

Magnetic filters, scale reducers  
and accessories.

# 22mm & 28mm CENTRAMAG NYLON FILTER

Easy in-line installation is the key factor of the new Centramag 2, Constituting to multiple installation options, added with the new 9 dirt separators to ensure protection against harmful debris entering the boiler. With a added bonus of 2 year manufacturers warranty and a 10 year magnet warranty.

- **CODE: TRAPCMAG2** - 22mm
- **CODE: TRAPMAG28** - 28mm

## KEY FEATURES

- In line installation
- Multiple installation options
- 9 dirt separators -maximising non-magnetic capture
- Bi-directional flow
- Triple seal isolating valves
- Compact installations
- Air vent doubles up as a dosing port for chemical inhibitor
- High grade EPDM seals
- Quick release magnet for rapid service
- Controlled flow within the filter
- Maximum 3 bar pressure
- Maximum operating temp 100°C
- 10 year magnet warranty
- 2 year warranty



'HOW-TO-USE' video



# 22mm GENESIS BRASS FILTERS

Designed for installation in small or restricted access areas. With the in-line system filter it is easy to install and fast and convenient to clean. With the aid of triple radial high performance epdm seals. Manufactured from high quality robust brass. Can be fitted horizontally and vertically comes with a 25 year warranty.

- **CODE: TRAPGEN-WOV** - Without valves
- **CODE: TRAPGEN-WV** - With valves

## KEY FEATURES

- Built in slip socket
- Robust brass body
- Triple radial seal
- Low level plug and drain valve provided
- Fits at a 50 degree angle
- Compact installation
- Captures magnetic and non-magnetic particles captured
- Fits horizontal, vertical and at angles
- Easy clean without disassembly
- 10000 gauss neodymium magnet
- Lidless unit, no need to replace seal
- Maximum 10 bar pressure
- Maximum operating temp 100°C
- 25 year warranty



'HOW-TO-USE' video



10,000 Gauss neodymium magnet

Isolating valves have 2 internal & 1 external O-rings

Less mechanical connections, means fewer chances of leaks

Fully brass built filter

3 O-rings means less chance of leaking. Can be installed up to 50°

Drain off Isolating valves have 2 internal & 1 external O-rings

Specially formed lugs make opening the drain off much easier

Drain off designed to fit washing machine connector, to enable drain off

Cap Cover has built in key to open drain off valve

# 22mm QUANTUM MINI BRASS FILTER

Where space is compact, and space is at a premium. We have designed a super-compact powerful magnetic filter to fit where other filters don't fit. Comes with a 25 year warranty.

• CODE: TRAPQUAN22



'HOW-TO-USE' video



## KEY FEATURES

- Built in slip socket
- Incorporated valves at no extra cost
- Triple radial seal
- Low level plug and drain valve
- Compact installation
- Captures magnetic and non-magnetic particles
- Fits at various angles
- Easy clean without disassembly
- 10000 gauss neodymium magnet
- Lidless unit, no need to replace seals
- Maximum 10 bar pressure
- Maximum operating temp 100°C
- 25 year warranty



# 15mm & 22mm ELECTROLYTIC SCALE REDUCERS

Uses electrolytic principles to prevent the build-up of scale throughout the home, and remains effective over many years dependent on water usage. It works by altering the structure of the hardness salts.

- **CODE: TRAPSCALE15** - 15mm
- **CODE: TRAPSCALE22** - 22mm



## KEY FEATURES

- WRAS approved
- Whole house protection
- Durable nickel plated unit
- Additional hexagon supports at both ends to make installation easier
- No maintenance or chemicals required
- No earth bonding required
- Maximum 10 bar pressure
- Maximum operating temp 80°C
- 1 year warranty

# 15mm MAGNETIC SCALE REDUCER

Ideal for single use appliances without the use of any chemicals. Compact and easy to install with compression fittings. Economical solution for anti-scale prevention with no running costs once fitted.

- **CODE: TRAPMAGSCAL15**



## KEY FEATURES

- Strong magnet
- Effective treatment for cold water
- No moving parts
- Ideal for combi boilers
- Prolongs appliance life
- Maximum 10 bar pressure
- Maximum operating temp 80°C
- 1 year warranty



## POWER FLUSH CONNECTOR

Fits quickly and easily connects to flushing machines. It is fitted by simply replacing the filter body with the adapter. The flushing adapter fits the genesis filter with and without valves.

• **CODE: TRAPFLUSH**

### KEY FEATURES

- Made from robust brass
- Extra 3rd seal for protection
- Full flow for efficiency
- Maximum 10 bar pressure
- Maximum operating temp 100°C
- 1 year warranty

## 15mm, 1/2", 3/4" AUTO AIR VENTS

Removes micro bubbles from the system prevents component damage and system failure, reducing downtime and maintenance costs.

• **CODE: TRAPAVENT15** - 15mm

• **CODE: TRAPAVENT12** - 1/2"

• **CODE: TRAPAVENT34** - 3/4"



### KEY FEATURES

- Special valve construction ensures valve is closed completely
- Protects against scale and lime long lasting valve seat
- Robust floats which cannot rupture
- Safety shut off
- Robust brass body
- Works with high temperature and/or high-pressure system environments
- Maximum 10 bar pressure
- Maximum operating temp 110°C
- 1 year warranty

# 22mm CENTRAVENT DEAERATOR

Works non-stop to effectively remove circulating air and micro bubbles from system water. Thanks to the special construction and the solid valve seat, the leak proof air release valve always closes perfectly, this avoids the sputtering and unwanted entry of air from outside the system.

• **CODE: TRAPDEAR**

## KEY FEATURES

- Built in slip socket
- Triple radial seal
- Compact installation
- Removes micro bubbles
- Lidless unit
- Prevents rust
- Maximum 6 bar pressure
- Maximum operating temp 110°C
- 10 year warranty



'HOW-TO-USE' video



# 1/2" WATER SHOCK ARRESTOR MECHANICAL

Maintenance free device to prevent water hammering in plumbing systems. No need to re-pressurize annually. Brass body with polymer piston, steel spring and EPDM seals.

• **CODE: TRAPSHOCK12**



## KEY FEATURES

- Suitable for potable water, hot, cold and refrigeration circuits
- 1/2" BSP male threaded connection
- Spring loaded
- Maximum 40 bar pressure
- Maximum operating temp 90°C
- 1 year warranty

# 1/2" WATER SHOCK ARRESTOR DIAPHRAGM

When you have a water meter or non-return valve, water shock arrestors are vital to prevent water hammering. This product has a butyl membrane that is suitable for drinking water.

• **CODE: TRAPSHOCK12/DIA**



## KEY FEATURES

- Stainless steel body
- Brass threaded connection
- 100% factory tested
- 0.16 litre capacity
- MIG welded
- Maximum 10 bar pressure
- Maximum operating temp 100°C
- 1 year warranty

# POWER HAMMER

The power hammer has been designed to remove debris from the radiator by agitating the radiator via a SDS drill. This is formed by special high intensity rubber.

• **CODE: TRAPHAMMER**

## KEY FEATURES

- Saves time
- Doesn't mark the radiator
- No need to use a rubber mallet
- Easily agitated by an SDS drill
- Radiator does not need removing to eliminates cold spots



# EXPANSION VESSEL BRACKET

The expansion vessel bracket to be firmly and accurately connected to the heating system. This is designed for installations where space is limited.

• **CODE: TRAPEXV**



## KEY FEATURES

- Manual air vent
- 3 bar safety valve
- Suitable for vessels from 2 to 25 litres (dependent on wall and wall fixings)

# EXPANSION VESSEL SERVICE VALVE

This prevents draining down the whole heating which prevents losing time and chemical inhibitor. Easy point to re pressurize the expansion vessel, drain via washing machine hose and add chemical inhibitor whilst you have the added benefit of the filling loop adapter.

• **CODE: TRAPEXVALVE**



## KEY FEATURES

- Easy drain point access
- Incorporated filling loop assembly
- Allows expansion vessel to be isolated

# BOOST YOUR SALES & MARGINS

High Margin, Fast Moving Product Lines

- Display **best-selling** Arctic Hayes tools and consumables for the heating and plumbing market on a high quality durable light up **display stand**.
- **High-quality**, engaging and colourful point of sale display stands can have a huge impact on sales figures.
- Make the **right impression**, drive impulse purchases and grab customers attention!
- **Risk-free!** Regular stock reviews and the ability to swap non-moving stock for new lines.
- Initial Stock Order **Support** Available.



Wall Panel  
Size: 600mm x 1100mm



Medium-Small Stand  
Size: 800mm x 1500mm



Medium-Tall Stand  
Size: 660mm x 2000mm



Tall Stand  
Size: 1000mm x 2000mm



# **COMMERCIAL** **PRODUCTS**

Magnetic filters, scale reducers  
and accessories.



# 1", 1 1/4", 1 1/2" COMMERCIAL BRASS FILTER

For removing both magnetic and non-magnetic dirt particles from the water system. The unique 10000 gauss magnetic field technology guarantees unprecedented fast, optimal dirt separation. Even the smallest magnetite particles are removed, maximising system performance as well as protecting costly system components.

- **CODE: TRAPMAX1** - 1"
- **CODE: TRAPMAX14** - 1 1/4"
- **CODE: TRAPMAX12** - 1 1/2"



## KEY FEATURES

- Robust brass body
- Triple radial seal
- Fits at a 50 degree angle
- Compact installation
- Captures magnetic & non-magnetic particles
- Horizontal, vertical and at various angles
- Easy clean without disassembly
- Lidless unit
- No need to replace seal
- Full bore flow
- Maximum 6 bar pressure
- Maximum operating temp 110°C
- 10 year warranty



'HOW-TO-USE' video

# 1/2", 1" & 1 1/2" SCALEMATIC

Scalematic can be used to treat a whole house or can be used to treat specific equipment to prevent scale formation, supplied in a copper housing with BSP ranging from 1/2" to 1 1/2" which can easily be installed into all common plumbing systems. Manufactured in the UK.

- **CODE: TRAPSCAL12** - 1/2"
- **CODE: TRAPSCAL1** - 1"
- **CODE: TRAPSCAL112** - 1 1/2"

## KEY FEATURES

- Protects against scale and lime
- Whole house protection
- No need to replace salt regularly
- Sealed unit, no moving component
- Maximum 16 bar pressure
- Maximum operating temp 110°C
- 10 year warranty



# COLLEGES & TRAINING PARTNERS

## Educational Incentives

ARCTIC HAYES supply the premium pipe freezing range for plumbing and heating engineers. Contact us today to discuss our educational incentives on our full range of over 450 products and all the benefits below.

## Enhance your Curriculum

Including pipe freeze training as part of your student's curriculum, enables live demonstrations, a chance to ask questions and attain a certificate of completion to enhance their course qualifications.

## Sponsored Bays

Enhance your training bays with branded posters, high quality images and logos.

We can create banners specific to pipe freeze or any other product categories.



A blue-tinted photograph of an industrial facility, likely a water treatment plant. The scene is filled with large pipes, valves, and machinery. In the foreground, a large horizontal pipe curves from the left. In the background, several vertical cylindrical tanks are visible. The overall atmosphere is industrial and technical.

# INDUSTRIAL PRODUCTS

Magnetic filter

# 2" FLOWMATIC INDUSTRIAL FILTER

2" capacity with an automatic air vent for deaeration and a built-in lidless feature to prevent leakages. Made from the finest high grade robust stainless steel and with rustproof 12000 gauss neodymium magnets.

• **CODE: TRAPFLOW2**



## KEY FEATURES

- Fits at a 50 degree angle
- Easy clean without disassembly
- Lidless unit, no need to replace seal
- Maximum 12 bar pressure
- Maximum operating temp 110°C
- 10 year warranty
- Weight: 28.6Kg / per unit





# TEST EQUIPMENT

For all your Gas, Pressure, Temperature  
and Electrical needs.

## TEMPERATURE TESTING

Pages: 199-208



## GAS & PRESSURE TESTING

Pages: 209-212



## ELECTRICAL TESTING

Pages: 213-219





# TEMPERATURE TESTING

A varied range of different thermometers and thermometer kits.



# IR99 3-IN-1 THERMOMETER

The IR-99 3-in-1 thermometer is a clamp thermometer, infrared thermometer and stem thermometer, all in one instrument.

• **CODE: A998724**

## KEY FEATURES

- Max / Min and Hold function
- User selectable °C or °F
- Clamp opening approx 1" (25mm)
- Response time less than 1 second
- Automatic power off function
- IR temperature resolution 0.1°C/°F
- Optical resolution: 1:1
- Resolution 0.1°C/°F
- Basic accuracy 2% of reading
- Battery: 1 x CR 2032 button (included)



IR temperature range: -35°C to +260°C (-31°F to 500°F)

Probe temperature range: -40°C to +260°C (-40°F to 500°F)

Clamp temperature range: -40°C to +200°C (-40°F to 392°F)

# STEM THERMOMETER

A simple to use thermometer ideal for testing liquids, semi-solid and solid materials.

• **CODE: AH02**

## KEY FEATURES

- Max / Min and Hold function
- User selectable °C or °F
- 145mm x 4mm probe length
- Probe protective sheath
- Automatic power off function
- IP rating 54
- Conforms to EMC and RoHS Directive
- CE and UKCA Compliant
- Battery: 1 x 3V CR1220 button cell (included)



Temperature range: -55°C ~ 330°C (-58°F ~ 626°F)

# COMPACT DIGITAL THERMOMETER

Combines a modern compact design effective device for liquids, semi-solids and solids

• **CODE: AHCT1**

## KEY FEATURES

- Max / Min and Hold function
- User selectable °C or °F
- Programmable audible alarm at high and low temperature limits
- 100mm x 3.5mm probe length
- Automatic power off function
- Conforms to EMC and RoHS Directive
- CE and UKCA Compliant
- Battery: 1 x 1.5V button cell (included)



Temperature range: -50°C ~ 150°C (-58°F ~ 302°F)

# NON-CONTACT INFRARED DIGITAL THERMOMETER

Perfect for measuring the temperature of hard to reach objects. Unique 12 point circular measurement area allows clear and accurate readings. Supplied in a protective carry case.

• **CODE: AH650**

## KEY FEATURES

- Max and Data Hold function
- Laser target pointer
- Colourful LCD display for easy read
- Adjustable upper and low limit alarm
- D:S 12-1 (distance to spot ratio)
- Automatic power off function
- Conforms to EMC and RoHS Directive
- EN60825 compliant for laser
- CE and UKCA Compliant
- Battery: 2 x 1.5V AAA (included)

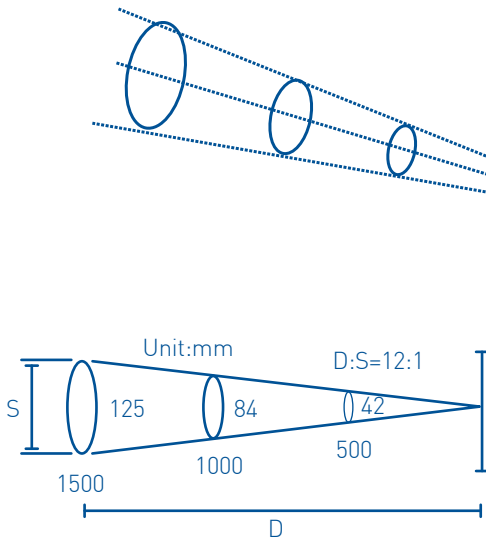

Temperature range:  $-30^{\circ}\text{C} \sim 380^{\circ}\text{C}$  ( $-22^{\circ}\text{F} \sim 716^{\circ}\text{F}$ )

# DIFFERENTIAL DUAL INPUT THERMOMETER KIT 1

Provides engineers with everything needed to accurately measure temperatures. The kit has been designed to be a useful tool for gas, heating and plumbing professionals. Ideal for flow and return differential for balancing radiators as well as cold water inlet and hot water outlet temperatures.

• **CODE: AHKT1**

## KEY FEATURES

- Max / Min / Hold & AVG functions
- Backlight feature
- 2 x K / J Type ports
- Probes and Thermocouples meet EN 60584
- Conforms to EMC and RoHS Directive
- CE and UKCA Compliant
- Battery: 1 x 9V (included)



# KIT CONTAINS



1 x Dual input thermometer (AHTH)



1 x Robust Case & Batteries included



1 x Air & liquid temperature probe (TPA1)



1 x Surface temperature probe (TPS1)



2 x 1M K-Type thermocouple wires (TC1)



2 x Pipe clamp temperature probes (TPPC1)

Temperature range:

K-Type: -200°C ~ 1370°C [-328°F ~ 2498°F] | J-Type: -200°C ~ 1100°C [-328°F ~ 2012°F]

# DIFFERENTIAL DUAL INPUT THERMOMETER KIT 2

Provides engineers with everything needed to accurately measure temperatures. The kit has been designed to be a useful tool for gas, heating and plumbing professionals. Ideal for flow and return temperature differential when balancing radiators.

• **CODE: AHKT2**



## KEY FEATURES

- Max / Min / Hold & AVG functions
- Backlight feature
- 2 x K / J Type ports
- Thermocouples meet EN 60584
- Conforms to EMC and RoHS Directive
- CE and UKCA Compliant
- Battery: 1 x 9V (included)

## KIT CONTAINS

- 1 x Dual input thermometer (AHTH)
- 2 x Pipe clamp temperature probes (TPPC1)
- 2 x 1M K-Type thermocouple wires (TC1)
- 1 x Protective carry case
- Batteries included



Temperature range:

- K-Type: -200°C ~ 1370°C (-328°F ~ 2498°F)
- J-Type: -200°C ~ 1100°C (-328°F ~ 2012°F)

# DUAL INPUT DIFFERENTIAL THERMOMETER

Delivers a fast response reading and covers a wide range of temperature range. Takes the temperature measurement in most heating, ventilation, cold storage and air conditioning applications.

• **CODE: AHTH**

## KEY FEATURES

- Max / Min / Hold & AVG functions
- User selectable °C or °F
- Backlight feature
- 2 x K / J Type ports
- 2 x 1m K-Type Thermocouples included
- Conforms to EMC and RoHS Directive
- CE and UKCA Compliant
- Comes with protective carry case
- Battery: 1 x 9V (included)



Temperature range:

- K-Type: -200°C ~ 1370°C (-328°F ~ 2498°F)
- J-Type: -200°C ~ 1100°C (-328°F ~ 2012°F)



## K-TYPE AIR & LIQUID TEMPERATURE PROBE

Measure both air and liquid temperature including water, oils, detergents, semi-solids and non toxic chemicals.

• **CODE: TPA1**

### KEY FEATURES

- Exposed thermocouple bead, covered by a perforated stainless steel probe allowing the free passage of air and liquid
- Can be used with any K-Type thermometer or multimeter
- Compliance: BS EN60584-1, BS EN60584-3
- 100mm probe length, 5mm diameter
- 1m Curly cable
- RoHS compliant

Temperature range: -40°C ~ 250°C (-40°F ~ 482°F)



## K-TYPE SURFACE TEMPERATURE PROBE

Measures temperature of radiators, hot plates and pipes and ideal for temperature measurements on all flat surfaces.

• **CODE: TPS1**

### KEY FEATURES

- 15mm Spring loaded thermocouple tip
- Can be used with any K-Type thermometer or multimeter
- Compliance: BS EN60584-1, BS EN60584-3
- 100mm probe length, 5mm diameter
- 1m Curly cable
- RoHS compliant

Temperature range: -40°C ~ 600°C (-40°F ~ 1112°F)





## K-TYPE PIPE CLAMP TEMP PROBE

Ideal for checking the flow and return temperature differential when balancing radiators.

• **CODE: TPCC1**

### KEY FEATURES

- Quick response plates suitable for 4-40mm dia pipes
- Spring load jaw for secure grip
- Can be used with any K-Type thermometer or multimeter
- Compliance: BS EN60584-1, BS EN60584-3
- Cable length 1m
- RoHS compliant

Temperature range: -40°C ~ 100°C (-40°F ~ 212°F)

## 1M K-TYPE THERMOCOUPLE

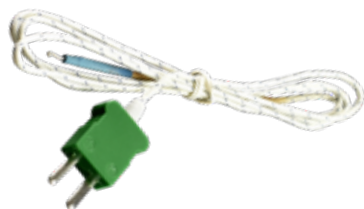

### KEY FEATURES

- Measure air & liquid temperature
- Use with any K-Type compatible thermometer or multimeter
- **CODE: TC1**

Temperature range: -40°C ~ 200°C  
-40°F ~ 392°F

## K-TYPE VELCRO STRAP PROBE



### KEY FEATURES

- 320mm x 20mm Velcro strap
- 2 metre long lead
- Maximum temperature: 150°C
- **CODE: A8125**

Temperature range: -40°C ~ 150°C  
-40°F ~ 302°F



# **GAS & PRESSURE TESTING**

For tracing gas leaks & pressure testing.

# COMBUSTIBLE GAS LEAK DETECTOR

An essential testing tool for high performance electronic detection of combustible gases.

• **CODE: A998721**



## KEY FEATURES

- Heated semiconductor gas sensor
- High - low leak sensitivity selector
- 7 LED tri-coloured visual leak level indicator
- Variable intensity audible alarm
- Ambient concentration reset
- 15.5" flexible stainless steel probe
- Detection of Methane / Hydrocarbon gases
- Sensitivity as small as 5ppm
- Operating temperature: 0°C-40°C (32°F-104°F)
- Battery: 4 x AA (included)

## KIT CONTAINS

- 1 x Combustible gas leak detector
- 1 x Specialised gas test bottle
- 1 x Robust carry case
- 1 x Instruction manual
- 4 x Batteries included

# DIGITAL DIFFERENTIAL PRESSURE METER KIT

Measures gauge / differential pressure from -55.4 in H<sup>2</sup>O (±2 psi), it features 11 selectable units of measure: H<sup>2</sup>O, psi, bar, mbar, kPa, inHg, mmHg, ozin, ftH<sup>2</sup>O, cmH<sup>2</sup>O, kgcm. Additional features include Data hold, auto power off disabled and backlight feature.

• **CODE: A998673**

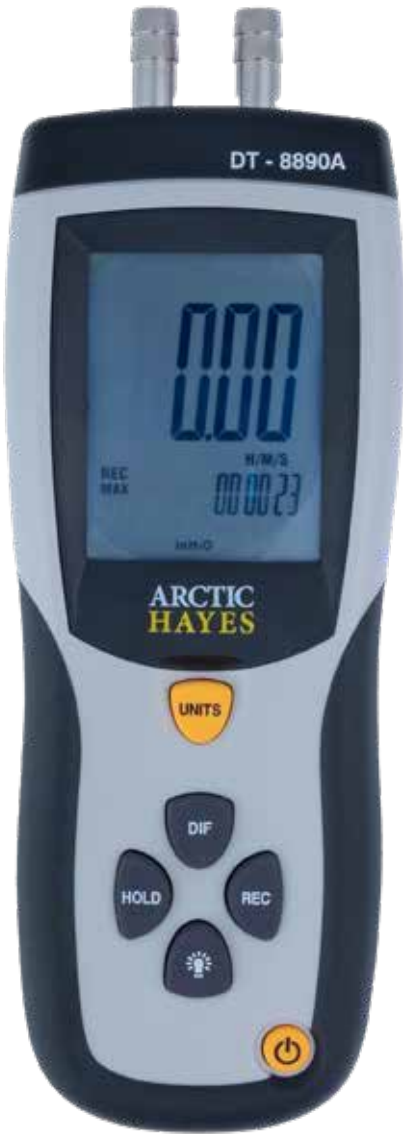

## KIT CONTAINS

- 1 x Digital differential pressure meter
- 2 x Connection hose
- 1 x Robust carry case
- 1 x Instruction manual
- 1 x Battery: 9V (included)



FUNCTION	RANGE	RESOLUTION	FUNCTION	RANGE	RESOLUTION
inH <sup>2</sup> O	55.40	0.01	ozin <sup>2</sup>	32.00	0.01
psi	2.000	0.001	ftH <sup>2</sup> O	4.612	0.001
mbar	137.8	0.1	cmH <sup>2</sup> O	140.6	0.1
kPa	13.79	0.01	kgcm <sup>2</sup>	0.140	0.001
inHg	4.072	0.001	bar	0.137	0.001
mmHg	103.4	0.1			

# GAS LEAK DETECTOR

Used to identify the presence of combustible gases such as natural gas, methane, propane, butane and ammonia in appliances, valves, pipes and fittings.

• **CODE: AH61**

## KEY FEATURES

- Detects between 50ppm to 1000ppm
- High/Low sensitivity setting
- Audible and visual alarm
- Auto power off
- Operating conditions: 0°C ~ 50°C (32°F ~ 122°F) 20 to 80% RH
- Conforms to EMC and RoHS Directive
- CE and UKCA Compliant
- Battery: 2 x 1.5V AAA Alkaline (included)



# DIGITAL PRESSURE VESSEL CHECKER

Ideal to check pressures in expansion pressure vessels within heating systems. Ideal size for plumbing use with an accurate gauge that gives readings in PSI, kPa, and BAR.

• **CODE: AHTP5**

## KEY FEATURES

- Range: 5-100 PSI
- Accuracy:  $\pm(1\% + 0.5)$  PSI
- Peak & Hold function
- LED light tip helps you find the valve easily
- Auto power off
- PSI, kPa & BAR
- Battery: 2 x 1.5V AAA (included)





# ELECTRICAL TESTING

A range of essential electrical testing equipment.

# DIGITAL VOLTAGE INDICATOR

A two pole voltage indicator and continuity tester. Compact, lightweight design. Voltage indicators are an essential measuring tool for all trades and are used to make sure there is no risk of electrocution when working with live circuits.

• **CODE: AHVOLT1**

## KEY FEATURES

- Built in flashlight
- Continuity detection range: 0-550K $\Omega$
- Voltage range: 12-690V AC/DC
- Compliance: EN 61243-3 & EN 61010-1, CATIII 690V & CATIV 600V & IP64
- Indicates live circuits
- Self test function
- Accurate and reliable two-pole voltage and audible continuity testing
- Supplied with pole covers that meet GS38 standard
- Battery: 2 x 1.5V AAA (included)



Temperature range: -10°C ~ 55°C (-14°F ~ 131°F)

# NON-CONTACT ATEX VOLTAGE DETECTOR

ATEX approved non-contact AC Voltage Detector is easy to use. Just touch the tip against a terminal strip, outlet or supply cord and the tester will indicate if voltage is present.

Voltage detection is indicated by both visual and audible, multicolour LED's. The flash and beep rate increase the closer you get to the voltage source.

As well as general use this ATEX certified version is approved for use in hazardous areas such as chemical plants, oil refineries and offshore rigs as well as gas / explosive environments.

• **CODE: AHATEX12**



**ATEX  
CERTIFIED!**



## TECHNICAL INFORMATION!

- Range:  
12V to 1000V  
100V to 1000V
- Frequency:  
50Hz / 60Hz
- Compliance:  
CAT IV 1000V rated IP67 rated  
2m drop-proof rated ATEX certified  
(II 2 G Ex ib IIB T4)
- Power Supply:  
2 x 1.5V AAA batteries (included)



# NON-CONTACT VOLTAGE DETECTOR

Professional easy to use voltage detector, designed to detect AC voltage from 12V - 1000V. When probe is placed near the AC voltage the signal indicator will flash red and beeper will sound.

• **CODE: AH12**

## KEY FEATURES

- Voltage range: 12-1000V AC / 48V - 1000V AC 50/60Hz
- Operating conditions: 0°C to +40°C / 32°F to 104°F
- Compliance: CATIII 1000V EN 61010-1
- Double insulated for safety around live circuits
- Audible and visual alarm
- Distinguish between live and neutral
- Conforms to LVD, EMC and RoHS Directive
- CE and UKCA Compliance
- Battery: 2 x 1.5V AAA (included)



# MULTI-FUNCTION SCREWDRIVER

More than just a screwdriver! Perform all essential testing to outlets and small electrical appliances with this multi-function screw driver. Self-testing, safe and easy to use.

• **CODE: A664072**

## KEY FEATURES

- AC voltage test-contact: 70 to 250VAC
- AC voltage test-non-contact: 70 to 600VAC
- DC voltage test: up to 250VDC
- Polarity test: 1.5V to 36VDC
- Continuity check: 0 to 50M ohM
- Detects microwave leakage:  $\geq 5\text{MW/sq cm}^2$
- Self-test: extra-safe
- Conforms to EN61010-1
- Battery: 2 x LR41 (included)



# PROFESSIONAL DIGITAL CLAMP METER

Easy to use clamp meter with a large trigger jaw and rotary dial makes adjusting between features simple. Can be used to measure current up to 600A AC and voltage up to 600V AC.

• **CODE: AH206**



## KEY FEATURES

- Max / Min and Hold function
- Double colour backlight screen
- Audible and visual alarm
- 6000 counts true RMS
- Built in flashlight
- Overload protection
- 25mm Jaw opening size
- Max current: 600A AC, Without DCA
- Max voltage: 600V AC / DC
- Compliance: CATIII 600V, EN 61010-1, EN 61010-2-033
- Includes 1m K-Type Thermocouple & adaptor (to EN 60584)
- Conforms to LVD, EMC and RoHS Directive
- CE and UKCA Compliant
- Battery: 2 x 1.5V AAA (included)

Temperature range: -20°C ~ 1000°C (-4°F to 1832°F)

## FUSED MULTIMETER TEST LEADS

Fully compliant fuse leads which conform to the requirements of EN61010 and HSE GS38 regulations.

• **CODE: A998780**



# COMPACT DIGITAL MULTIMETER

A high-performing, auto-ranging multimeter with temperature function. This device can measure voltage, electrical current, resistance, capacitance as well as measuring NCV.

• **CODE: AH113**



## KEY FEATURES

- Max / Min and Hold function
- Backlight function
- Removable probe covers to meet GS38
- 6000 counts true RMS
- Built in flashlight
- Overload protection
- Max voltage: 600V AC / DC
- Compliance: CATIII 600V
- Includes 1m K-Type Thermocouple & adaptor (to EN 60584)
- Conforms to LVD, EMC and RoHS Directive
- CE and UKCA Compliant
- Battery: 2 x 1.5V AAA (included)



Temperature range: -20°C ~ 1000°C (-4°F to 1832°F)



# PROFESSIONAL DIGITAL MULTIMETER

A high-performing, auto-ranging multimeter with temperature function. The device can measure voltage, electrical current, resistance and capacitance.

• **CODE: AH118**

## KEY FEATURES

- Max / Min and Hold function
- Backlight function
- Removable probe covers to meet GS38
- 6000 counts true RMS
- Built in flashlight
- Overload protection
- Max voltage: 750V AC, 1000V DC
- Compliance: CATIII 1000V, CATIV 600V
- Includes 1m K-Type Thermocouple & adaptor (to EN 60584)
- Conforms to LVD, EMC and RoHS Directive
- CE and UKCA Compliant
- Battery: 2 x 1.5V AAA (included)

**INPUT JACK LED INDICATION!**



Temperature range: -20°C ~ 1000°C (-4°F to 1832°F)

## REPAIR AND CALIBRATION

Arctic Hayes offers a comprehensive range of calibration and repair services aimed at keeping your test equipment maintained, accurate and functional to the highest standards and at very competitive prices.

Our professional calibration service is staffed by accredited engineers and our service laboratories are fully equipped with the latest calibration instrumentation.

All our calibration certificates and test equipment are traceable to National Standards. Any test equipment repaired by us will also be fully calibrated before being dispatched to ensure the repair was successful and the meter is operating correctly.

All instruments calibrated or repaired at our laboratory are cleaned, adjusted (where necessary) and test leads (where supplied) are also checked to ensure that your meter is operating at its full potential.

We offer a calibration recall service and we aim to have all instruments tested within 7 working days from receipt, and we can tailor our service to suit your specific requirements.

# **FIX IT FAST** **RANGE**

O-rings, washers and fixings that are perfect for every day jobs.

## **WASHER & O-RING KITS**

Pages: 223-227



## **SPLIT KLICK WASHERS**

Pages: 229-232



## **FIXINGS & WASHERS**

Pages: 234-240





# **WASHERS & O-RING KITS**

A range of washers & O-rings to manage every plumbing application.



# IMPERIAL & METRIC O-RING WASHER KITS

18 universal O-Ring sizes in one sturdy case, nitrile rings resist heat, most petroleum and silicone fluids, hydraulic and non-aromatic fuels and solvents.

- **CODE: BOXM** - 225 piece metric
- **CODE: BOXP** - 225 piece imperial

## KITS CONTAINS

BOXM

- |                    |                    |
|--------------------|--------------------|
| • 20 x 3mm x 1mm   | • 5 x 9mm x 2mm    |
| • 20 x 4mm x 1mm   | • 5 x 10mm x 2mm   |
| • 20 x 4.5mm x 2mm | • 5 x 12mm x 3mm   |
| • 20 x 5mm x 2mm   | • 5 x 13mm x 3mm   |
| • 20 x 6mm x 2mm   | • 5 x 14mm x 2.5mm |
| • 20 x 6mm x 2.5mm | • 5 x 17mm x 2.5mm |
| • 20 x 6mm x 3mm   | • 5 x 18mm x 4mm   |
| • 20 x 7mm x 2mm   | • 5 x 20mm x 2mm   |
| • 20 x 8mm x 2mm   | • 5 x 22mm x 2mm   |



## KITS CONTAINS

BOXP

- |                       |                         |
|-----------------------|-------------------------|
| • 10 x 3/32" x 15/64" | • 10 x 3/8" x 9/16"     |
| • 20 x 1/8" x 1/4"    | • 10 x 7/16" x 5/8"     |
| • 20 x 5/32" x 9/32"  | • 10 x 1/2" x 11/16"    |
| • 20 x 3/16" x 5/16"  | • 10 x 9/16" x 3/4"     |
| • 15 x 7/32" x 11/32" | • 10 x 5/8" x 13/16"    |
| • 15 x 1/4" x 3/8"    | • 10 x 11/16" x 7/8"    |
| • 15 x 5/16" x 7/16"  | • 10 x 3/4" x 15/16"    |
| • 10 x 3/8" x 1/2"    | • 10 x 3/4" x 1"        |
| • 10 x 5/8" x 3/4"    | • 10 x 13/16" x 1-1/16" |



\* Sizes measure internal diameter and thickness

# TAP WASHER KIT

170-piece tap washer kit with a variety of the most commonly used tap washers in different materials. Supplied in a handy carry box with a snap-lock lid and 12 compartments to keep washers separate.

• **CODE: TWKIT**



## KIT CONTAINS

- 55 x Vacca flat washers, 4 sizes: 3/8", 1/2", 5/8", 3/4"
- 15 x Vacca dome washers, 2 sizes: 1/2", 3/4"
- 30 x Dome delta/arm washers, 2 sizes: 1/2", 3/4"
- 20 x Tantofex tap washers, 2 sizes: 1/2", 3/4"
- 50 x Cap & lining fibre washers, 2 sizes: 1/2", 3/4"

# PLUMBERS FIRST AID KIT

Essential 210-piece plumbers' washer and olive kit with an assortment of 9 of the most commonly used sizes. Handy pack to keep in a work van or in the home.

• **CODE: FRWKIT**



## KIT CONTAINS

- 30 x Fibre washers Y.I.F: 1/2"
- 20 x MT ball-cock washers: 1/2"
- 20 x Fibre ball valve seat washers: 1/2"
- 10 x Rubber bottle trap washers, 2 sizes: 1 1/4", 1 1/2"
- 50 x Cap & lining washers, 2 sizes: 1/2", 3/4"
- 20 x Rubber shower flex washers, 1/2"
- 10 x Washing machine hose washers, 3/4"
- 35 x Fibre flexi tap con washers, 2 sizes: 1/2", 3/4"
- 15 x Compression olives: 15mm & 22mm

# FIBRE WASHER KIT

Pack of 330 fibre washers of various sizes ideal to suit a variety of jobs. Designed for use in applications such as flexible tap connectors and taps, and where the washer is likely to be subject to high clamping pressures. Contains a mix of 14 of the most common size washers.

• **CODE: FWKIT**

## KIT CONTAINS

- 270 x Red fibre washers,  
7 sizes: 9 x 6.4mm, 12.6 x 8.3mm,  
16 x 10mm, 15.5 x 11.5mm, 19 x 13.5mm,  
22 x 14.6mm, 22 x 17mm
- 35 x Fibre washers,  
3 sizes: 1", 1.2", 3/4"
- 15 x Ball valve seating washers,  
2 sizes: 1.2", 3/4"
- 10 x Top body washers,  
2 sizes: No. 3, No. 4



# BALL VALVE WASHER KIT

Ball valve washer kit containing 106 pieces. A variety of the most commonly used ball washers plus other essential ball valve pieces. Supplied in a handy carry box with a snap-lock lid and 12 compartments to keep washers separate.

• **CODE: BVKIT**

## KIT CONTAINS

- 20 x Black ball tap washers,  
2 sizes: 1/2" x 1/8", 3/4" x 1/8"
- 40 x Red ball tap washers,  
2 sizes: 1/2" x 1/8", 3/4" x 1/8"
- 3 x High pressure seats (white)
- 3 x Low pressure seats (red)
- 20 x Fibre washer ball seats, 1/2"
- 10 x Cotton pins,  
2 sizes: 1/8" x 7/8", 7/8" x 3/16"
- 5 x Diaphragm washers, 1 1/4"
- 2 x Armstrong diaphragm washers
- 2 x Torbeck diaphragm washers
- 1 x Fluid master seal





## PLUMBERS WASHER KIT

A popular choice for plumbers, 144-piece washer kit for various plumbing jobs.

• **CODE: A557000**

### KIT CONTAINS

- 12 x 16.5\* 6mm
- 12 x 24\* 11mm
- 12 x 19.5\* 5mm
- 12 x 15.5\* 4mm
- 12 x 12\* 4mm
- 12 x 32\* 5mm
- 12 x 19\* 10mm
- 12 x 19\* 11mm
- 12 x 24\* 15mm
- 12 x 22\* 12mm
- 12 x 18\* 15mm
- 12 x 24\* 20mm



## O-RING WASHER KIT

144-piece O-Ring kit for various plumbing jobs.

• **CODE: A557001**

### KIT CONTAINS

- 12 x 22\* 1.8mm
- 12 x 14\* 2.65mm
- 12 x 24\* 1.8mm
- 12 x 26\* 2.65mm
- 12 x 27\* 2.65mm
- 12 x 32\* 2.65mm
- 12 x 30\* 3.5mm
- 12 x 22\* 2.65mm
- 24 x 29\* 2.65mm
- 12 x 29\* 3.5mm
- 12 x 33\* 1.8mm

# BOOST YOUR SALES & MARGINS

High Margin, Fast Moving Product Lines

- Display **best-selling** Arctic Hayes tools and consumables for the heating and plumbing market on a high quality durable light up **display stand**.
- **High-quality**, engaging and colourful point of sale display stands can have a huge impact on sales figures.
- Make the **right impression**, drive impulse purchases and grab customers attention!
- **Risk-free!** Regular stock reviews and the ability to swap non-moving stock for new lines.
- Initial Stock Order **Support** Available.



Wall Panel  
Size: 600mm x 1100mm



Medium-Small Stand  
Size: 800mm x 1500mm



Medium-Tall Stand  
Size: 660mm x 2000mm



Tall Stand  
Size: 1000mm x 2000mm



# **SPLIT KLICK** **WASHERS**

Save time and money with long lasting fittings.

**Split Klick washers** save time and money with long-lasting fit. There's no need to disconnect pipework when fitting, and our wide range of Split Klick products ensures you can get work done quickly and easily, no matter the job type.

- Nylon 6
- 15,000psi Compressive strength
- Min working temperature: -50°C
- Max working temperature: 190°C

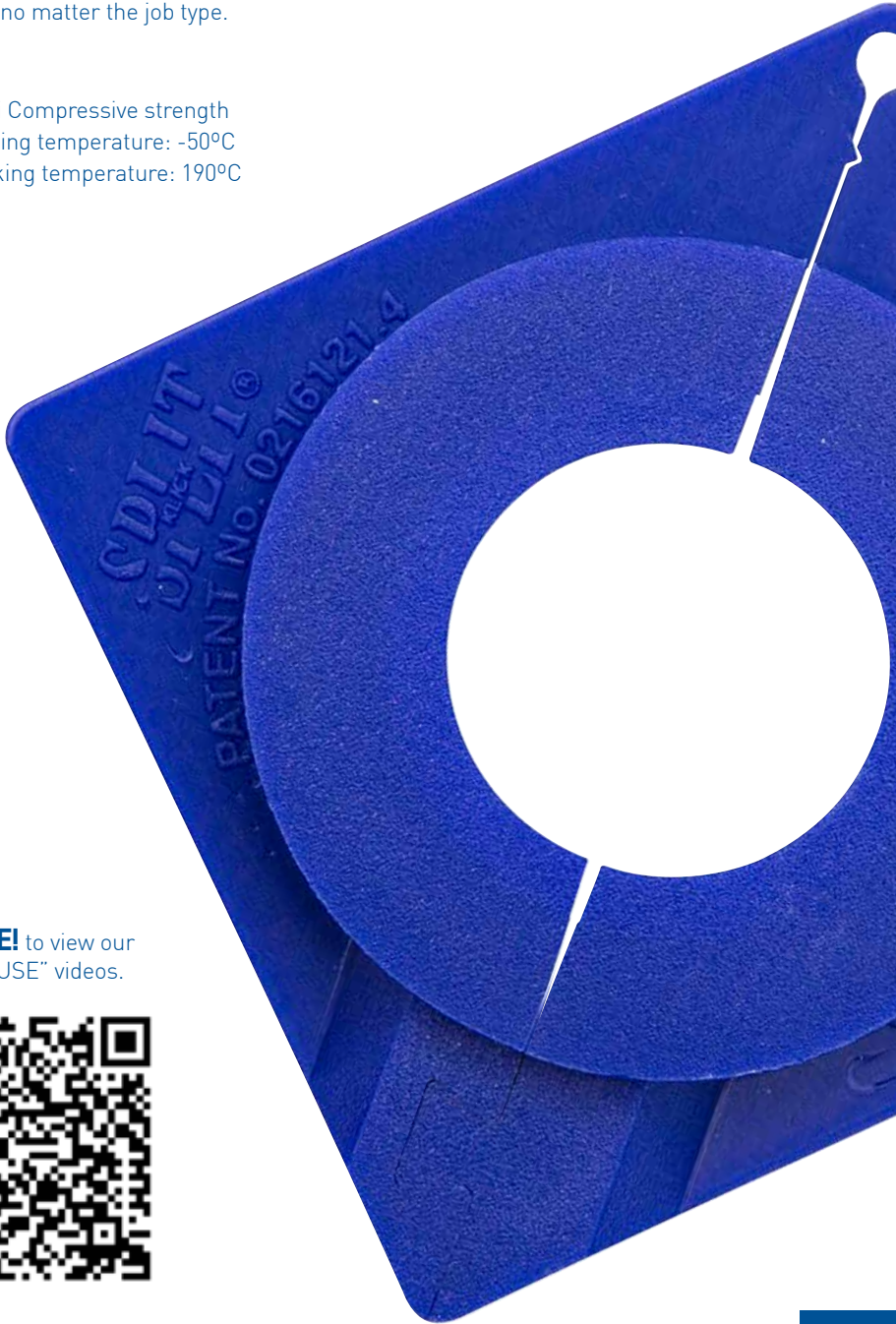

**SCAN ME!** to view our "HOW-TO-USE" videos.



# SPLITKICK TOP HAT WASHERS

## TOP HAT WASHERS

Far stronger installation than conventional methods and will last for a lifetime. Allows you to replace old washers without disconnecting pipe-work, saving you valuable time. Ideal for use under baths or on fittings in sinks.

- **CODE: SK1/001** - Single
- **CODE: SK1/002** - Twin pack
- **CODE: SK1PK10** - Pack of 10

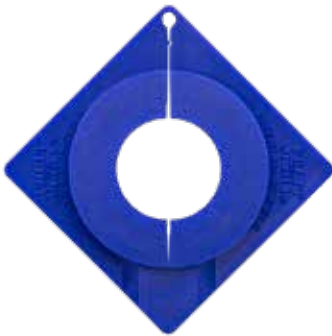

- Suitable for either 1/2" or 3/4" pipes
- No need to disconnect supply or tap
- Washer can be cut to fit larger pipe

## CENTRALISING WASHERS

The unique Split Klick Centralising Washer automatically locates your tap correctly, eliminating the need to use silicone or putty. It makes fitting taps easier, quicker and gives a stronger and longer lasting installation.

- **CODE: SK2/001** - Single
- **CODE: SK2/002** - Twin pack
- **CODE: SK2PK10** - Pack of 10



- Suitable for 1/2" taps
- Easy and quick to fit
- Centralises taps with no mess and no fuss



# SPLITKLICK TOP HAT WASHERS

## MONOBLOC SINGLE WASHER

Monobloc washers centralise the tap during installation. No more slipping, no more frustration and a far stronger and more professional result.

- **CODE: SK3/001** - Single



- Automatically centralises fittings
- Unique, patented design
- Fits a single-bar fixing

## MONOBLOC DOUBLE WASHER

Monobloc washers centralise the tap during installation. No more slipping, no more frustration and a far stronger and more professional result.

- **CODE: SK4/001** - Single



- Automatically centralises fittings
- Unique, patented design
- Fits a double-bar fixing



# **WASHERS & FIXINGS**

A range of essential plumbing washers and fixings.

# FIBRE WASHERS

ALL PACKED IN A DISPLAY BAG FOR USE WITH EURO HOOKS



**1" - 30mm x 21.5mm**

- Pack of 3
- CODE: FWASH1

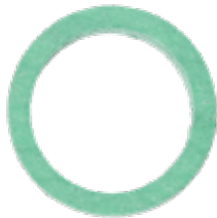

**1/2" - 18.5mm x 14.2mm**

- Pack of 8
- CODE: FWASH12



**3/4" - 24 mm x 18mm**

- Pack of 6
- CODE: FWASH34



## DIVERTER PACK OF 7

- 3 x 1/2"
- 3 x 3/4"
- 1 x 1"
- CODE: FWDP5



## 1 1/4" BALL VALVE DIAPHRAGMS

- Pack of 5
- CODE: W2



## SIAMP DIAPHRAGM WASHER

- Single
- CODE: W1



## 1/2" BALL VALVE RUBBER WASHERS

- Pack of 5
- CODE: W3 - Black (12.50mm x 3.25mm)
- CODE: W17 - Red (13mm x 3.25mm)



## 1/2" BALL VALVE SEATING WASHERS

- Pack of 5
- CODE: W4 (22.20mm x 12mm x 1.75mm)



## 1/2" x 1/8" BALL VALVE SEATING WASHER

- Pack of 5
- CODE: W33



## 1/2" x 1/4" BALL VALVE SEATING WASHER

- Pack of 5
- CODE: W34



## BALL VALVE REPAIR KIT

- CODE: W35

## HUSHFLOW WASHERS

This Hush flow washer is used on older model inlet valves that have screw type caps.



- **CODE: W16** - Single
- **CODE: W163** - 3 Pack

## HUSHFLOW DIAPHRAGM WASHERS - 1/4 TURN

This hush flow washer is for use on newer inlet valves that have a 1/4 turn twist lock mechanism.



- **CODE: HFW14** - Single
- **CODE: HFW143**- 3 Pack

## HUSHFLOW WASHERS PACKS

NEVER FAIL WITH THIS HUSH FLOW 4 PACK as contains 2 x washers for old style inlet valves & 2 x washers for newer 1/4 turn inlet vaves.

- **2 x W16**
- **2 x HFW14**



- **CODE: HFW4P**

\* NOTE: Plastic insert may vary in colour, in red or white, this indicates year of manufacture and has no effect on the function of the washer



## HOLDTITE FLAT TYPE WASHERS

- Pack of 5
  - **CODE: W5** - 1/2" [18.60mm x 12mm x 1.75mm]
  - **CODE: W6** - 3/4" [25.05mm x 4.86mm x 5.25mm]
  - **CODE: W7** - 3/8" [15.80mm x 4.65mm x 4.60mm]
  - **CODE: W20** - 5/8" [2 Pack] [4.86mm x 5.25mm]
- 



## 1/2" PEGLER WASHERS

- Pack of 5
  - **CODE: W9** - [15.50mm x 3.45mm x 4.65mm]
- 



## MT DRAW OFF TAP WASHERS

- Pack of 5
  - **CODE: W27** - [14.00mm x 4.00mm x 2.75mm]
- 



## 3/4" WASHING MACHINE WASHERS

- Pack of 5
  - **CODE: W26** - [24.00mm x 12.00mm x 2.00mm]
- 



## 1/2" SHOWER HOSE WASHERS

- Pack of 5
  - **CODE: W25** - [19.30mm x 10.00mm x 1.60mm]
- 



## DELTA TAP WASHERS

- Pack of 5
  - **CODE: W21** - 1/2" - [15.75mm x 5.00mm x 5.30mm]
  - **CODE: W22** - 3/4" - [18.42mm x 4.50mm x 5.12mm]
- 



## FLEXIBLE TAP CONNECTOR WASHERS

- Pack of 10
- **CODE: W31** - 1/2" - [19.10mm x 11.25mm x 1.50mm]
- **CODE: W32** - 3/4" - [24.10mm x 14.30mm x 1.50mm]

## PUMP FIBRE WASHERS

- Pack of 2
- **CODE: W15** - {44.50mm x 31.60mm x 1.50mm}



## PRESTEX WASHERS

- Pack of 5
- **CODE: W23** - 1/2" - {18.25mm x 15.00mm x 1.75mm}
- **CODE: W24** - 3/4" - {23.88mm x 19.85mm x 1.65mm}



## FIBRE PILLAR TAP WASHERS

- Pack of 2
- **CODE: W8** - 1/2" - {38.00mm x 22.00mm x 1.50mm}
- **CODE: W10** - 3/4" - {44.00mm x 29.00mm x 1.50mm}



## POLY WASHERS

- Pack of 5
- **CODE: W11** - 1" Tank - {64.00mm x 34.00mm x 1.50mm}
- **CODE: W12** - 1.1/4" Basin - {60.00mm x 43.00mm x 1.50mm}
- **CODE: W13** - 1.1/2" Sink - {89.00mm x 43.00mm x 1.50mm}
- **CODE: W14** - 1.1/4" Sink - {89.00mm x 49.00mm x 1.50mm}
- **CODE: W28** - 1/2" Pillar Tap - {38.00mm x 22.00mm x 1.50mm}
- **CODE: W29** - 3/4" Pillar Tap - {44.00mm x 29.00mm x 1.50mm}



## UNIVERSAL TOP HAT WASHERS

- Pack of 5
- **CODE: W30**



## 4.1/2" ROUND SYPHON DIA. WASHERS

- Pack of 5
- **CODE: W19**



## 5" OVAL SYPHON DIA. WASHERS

- Pack of 5
- **CODE: W18**



# FIX IT FAST RANGE

Fix It Fast offers a range of fuses, screws and accessories to make completing jobs quick, easy, and efficient. Choose from our range of glass fuses, electrical connector sockets, and sealing brass discs.

## PRESSURE TEST NIPPLES



- CODE: A664040 - Pack of 3
- CODE: 664040-U - Single

## HOSE CLIPS



- Pack of 2
- CODE: A556018 - 18 x 25mm

## 20mm QUICK BLOW FUSE



- Pack of 3
- CODE: A556021 - 2A

## 2.5mm x 200mm CABLE TIES

- Pack of 100



- CODE: TIES200

## 4.8mm x 200mm CABLE TIES

- Pack of 100



- CODE: A666095

## 4.8mm x 300mm CABLE TIES

- Pack of 100



- CODE: TIES300

## SEALING BRASS DISKS



- CODE: A556028 - 1" 3 Pack
- CODE: A556029 - 3/4" 4 Pack

## RADIATOR BLEED KEY



- CODE: A66058

## PLASTIC METER BOX KEYS

- Pack of 2



- CODE: A66044



## 3 & 5 WAY ELECTRICAL CONNECTOR & SOCKET

Provides a receptacle for connectors when they are mounted to a printed circuit board. Essential fittings to create protection for the connection it is housing.

- **CODE: A556093** - 3 Way
- **CODE: A556094** - 5 Way

### KEY FEATURES

- 3 & 5-way pin
- Snap-lock latches, which allows for a quick release and polarization
- Free hanging or panel mount
- Wire-to-wire or wire-to-board
- Maximum 20A
- 250V



## 3-5 WAY CONNECTOR WITH STRAIN RELIEF

3-5 way plug allows quick and easy installation of a range of products relating to a wiring centre. There is now no need to open the wiring centre to attempt to trace wires back to old, broken components. Now you can cut the old cable, install the new component and wire it in using this useful and time efficient device.

- **CODE: PLUG35**

### KEY FEATURES

- Built in cable strain relief
- One piece securing faceplate
- Strong holding clips
- Maximum 20A
- 250V





# ACCESS PANELS

High quality access panels,  
compliant to Part J Building Regulations.

**LIGHT WEIGHT  
ABS PLASTIC**

Page: 243



**1 HOUR FIRE  
RATED**

Page: 244



# LIGHT WEIGHT ABS PLASTIC

Our access panel range offers a simple, low cost, high quality solution to provide protected openings in ceilings and walls for access to building engineering services. The injection moulded slim profile produces a lightweight solution, enabling an easy fit installation into all types of wall or ceiling construction.



## KEY FEATURES

- UV stable ABS
- Snap friction catch
- Can be fastened easily into position with a suitable adhesive
- Can be painted to match surface

CODE	OVERALL SIZE	CUT OUT SIZE	DOOR SIZE
APS100	130mm x 180mm	100mm x 150mm	95mm x 145mm
APS150	194mm x 272mm	150mm x 230mm	145mm x 222mm
APS200	248mm x 248mm	200mm x 200mm	195mm x 195mm
APS300	357mm x 357mm	300mm x 300mm	292mm x 292mm
APS350	412mm x 412mm	350mm x 350mm	348mm x 348mm
APS450	523mm x 523mm	450mm x 450mm	448mm x 448mm
APS560	630mm x 630mm	560mm x 560mm	552mm x 552mm

# 1 HOUR FIRE RATED

A simple, low cost, high quality solution to provide protected openings in ceilings and walls for access to building engineering services. Powdered coated white satin fire rated access panel with tamper-proof lock.



## KEY FEATURES

- 1 hour fire rated robust steel panel
- Certified to BS EN1634-1:2008 & BS EN1634-2:1999
- Smoke tested to BS EN1634-3:2004
- UKAS acoustic test to 34dB reduction
- Suitable for walls and ceilings
- Powdered coated white satin RAL 9010
- Tamper-proof lock

CODE	OVERALL SIZE	CUT OUT SIZE	DOOR SIZE	CLEAR SIZE DOOR OPEN
FRPS1	350mm x 350mm	305mm x305mm	295mm x 295mm	220mm x 264mm

A worker wearing a white hard hat and a light-colored jacket is holding several boxes of Elpbort cleaning products. The background is a blurred industrial setting. The text is overlaid on the image.

# **PERSONAL PROTECTIVE EQUIPMENT & CLEANING PRODUCTS**

Keeping you, your employees and customers safe.

## **PERSONAL PROTECTIVE EQUIPMENT**

Pages: 247-252



## **CLEANING PRODUCTS**

Pages: 253-260





# **PERSONAL PROTECTIVE EQUIPMENT**

Designed to all the relevant standards.



# OVERSHOE CARPET PROTECTORS

Waterproof shield brand overshoes to protect your customers, carpets and floors whilst working indoors.

• **CODE: A445040**

## KEY FEATURES

- One size fits all
- Hand-sealed polythene
- Elasticated for extra grip
- Box of 100



# HEAVY DUTY OVERSHOES

PVC-soled overshoes. Strong and resistant to chemical splashes and dust.

• **CODE: 7775NON**

## KEY FEATURES

- One size fits most shoes
- 55gsm type 5B&6B PB material
- Non-linting
- Anti-static material



# SAFETY GOGGLES

## KEY FEATURES

- Confirms to EN166
- Optical Class: 1
- B - Medium impact energy
- **CODE: A445010**



# NAVY BUMP CAP

## KEY FEATURES

- 100% Cotton
- Vent holes
- EN812:2012
- CE Certified
- **CODE: A7735**



# GRIPSTER NITRILE GLOVES

These patented, fish scale gloves offer superior performance with unparalleled strength and grip. These fit for purpose gloves provide protection for a wide variety of heavy duty applications.

- **CODE: GRIP50BKM** - Medium (Box of 50)
- **CODE: GRIP50BKL** - Large (Box of 50)
- **CODE: GRIP50BKXL** - Extra Large (Box of 50)



## KEY FEATURES

- Patented non-slip design
- Fish scale surface for wet and dry grip
- Traction Grip inside and out for extra grip
- Latex free
- Powder Free
- Ambidextrous
- Colour- Black
- 50 Dispenser box



**TRACTION GRIP:**

Best in class for oily grip as tested by Satra UK



**NITRILE:** 100% Nitrile. No issues with latex protein allergy and better chemical and puncture resistance than latex



**DEXTERITY:** CE LEVEL 5. THE MAXIMUM.



**FIT:** The stretch formula Nitrile allows gloves to fit more snugly than traditional household gloves.



**STRENGTH:** While regular blue disposable gloves break easily, Gripster gloves are the strongest gloves about!.





## PUGGY PU WORK GLOVES

Featuring a very tough polyurethane coating with extreme abrasion resistance. Maximum flexibility and manoeuvrability make these gloves popular with scaffolders and plumbers as they are grippy without being restrictive.

- **CODE: 445036M** - Medium
- **CODE: A445036** - Large
- **CODE: 445036XL** - Extra Large

### KEY FEATURES

- Nylon liner glove
- Polyurethane palm coated
- Machine knitted
- Integral elasticated wrist
- Score - 4 1 3 1



## VINYL GLOVES

100% synthetic PVC vinyl gloves, suitable for use in the medical, food, mechanical and industrial sectors. Pre-powdered and easy to remove.

- **CODE: 445035S** - Small
- **CODE: 445035M** - Medium
- **CODE: A445035** - Large
- **CODE: 445035XL** - Extra Large

### KEY FEATURES

- Contains no latex or protein
- Medical grade
- Box of 100

# NITRILE GLOVES

Super-thin, more comfortable and with more grip than vinyl.

- **CODE: 445044S** - Small
- **CODE: 445044M** - Medium
- **CODE: A445044** - Large
- **CODE: 445044XL** - Extra Large

## KEY FEATURES

- Hypo-allergenic, unlike latex
- High quality disposable products
- Liquid-proof and oil-resistant
- Ideal for general lightweight handling
- Box of 100



# LATEX GLOVES

Made from a strong, durable and elastic latex to provide maximum flexibility, comfort and protection.

Not suitable for medical use, non-sterile.

- **CODE: 445030S** - Small
- **CODE: 445030M** - Medium
- **CODE: A445030** - Large
- **CODE: 445030XL** - Extra Large

## KEY FEATURES

- Ambidextrous
- Pre-powdered
- Grade A latex gloves
- Box of 100





# **CLEANING** **PRODUCTS**

Keep all your work area and tools clean and safe.

# ANTI-BACTERIAL SPRAY

Ideal for cleaning larger surfaces or pre-treating areas such as walls, floors or UPVC window frames before wiping clean.

• **CODE: ABSPRAY**

## KEY FEATURES

- Dermatologically tested
- ZERO levels of skin irritation recorded
- Biodegradable
- Free from preservatives



# HEAVY DUTY WIPES & REFILL

These new Anti-Bacterial 'Quad Fabric' Wipes have increased strength and greater absorbency.

- CODE: ABWIPES - Tub of 80
- CODE: ABWIPES-REFILL - 80 wipe refill

## KEY FEATURES

- The abrasive side removes the most stubborn and dried-on filth
- The smooth side soaks up any excess, leaving no mess
- Dermatologically tested
- Biodegradable





# ULTRAGRIME PRO BIO WIPES

100% plastic free, and created from plant-based biodegradable fibres which will biodegrade within 6 months in the right conditions. The perfect solution if you have tough messes to clean but don't want to use harmful chemicals and plastic products.

• **CODE: UGW100B**

## KEY FEATURES

- Bigger at a massive 38cm x 25cm
- Super strong & soft cloth like fabric
- Stays wet and useable for over an hour
- Don't dry out when lid is left open for days
- 3-in-1 action for efficient cleaning- Lifts, Cleans, Protects
- Removes grease, paint, silicone, uncured PU foam and adhesives
- Dispenses 1 wipe at a time
- Safe for all surfaces
- Dermatologically tested. Safe on skin
- Alcohol-free with vitamin E and aloe extract formula
- Pack of 100 wipes



## 3 PLY BLUE ROLL

Heavy duty construction makes this blue roll ideal for engineering or mechanical environments and suitable to keep in the back of a work van or domestic car for those unexpected spills

• **CODE: A445031**



### KEY FEATURES

- Highly absorbent, heavy duty
- 3-ply
- 97 Sheets per roll



## 2 PLY BLUE ROLL

Ideal for engineering or mechanical environments and suitable to keep in the back of a work van or domestic car for those unexpected spills.

• **CODE: A445034**

### KEY FEATURES

- Highly absorbent, heavy duty
- 2-ply
- 379 Sheets per roll
- Pack of 6

# WHITE & MIXED COTTON RAGS

White / Mixed colour rags for heavy duty or industrial cleaning. Ideal all-purpose cleaning cloths. Not recommended for polishing.

- **CODE: RAG1** - 10kg Mixed Rags
- **CODE: RAG2**- 10kg White Rags



## KEY FEATURES

- Durable & reusable
- Machine washable
- Ideal for heavy industrial cleaning
- Cost-effective cleaning solution
- Mixed or White Rags



# 1.5 LITRE ABSORBENT SHEETS

Ideal for when repairing leaking boilers, servicing radiators, repairing taps and washing machines.

• **CODE: A445027**

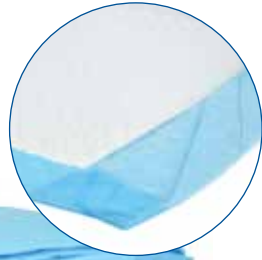

## KEY FEATURES

- Ultra absorbent
- Holds 1.5 / 2 litres of water
- Size: 900mm x 600mm
- Pack of 5

# 21" x 34" RUBBLE SACK

Keep on top of waste management on jobs and in the workplace. Lightweight but hard wearing and easy to transport, these rubble sacks are perfect for keeping a jobsite safe and tidy.

• **CODE: A998734**

## KEY FEATURES

- Colour: Grey
- Ldpe 100% environmentally friendly pure recycled.
- 440 gauge
- 110 Micron
- Litreage: 60L
- Carrying weight: max 25kg
- Strong welded base seal



# 21" x 29" RUBBLE SACKS

Keep on top of your waste management with our heavy duty black rubble sacks. Say goodbye to the splitting and stretching of cheaper variations on the market. Ideal for both domestic and commercial use. Suitable for all types of rubbish – brick, block, timber, plaster, gravel – our rubble sacks are robust enough to carry the lot. Wash and reuse over and over again.

• **CODE: BRS1**

## KEY FEATURES

- Heavy duty
- Hold up to 60 Litre / 20kg
- 350 gauge
- 87.5 Micron
- 500mm x 760mm
- 10 bags per roll





# **WINTER** **PRODUCTS**

Keep warm and safe all year round.

## HEATING APPLIANCES

Pages: 263-266



## WINTER ACCESSORIES

Pages: 267-270



# HEATING APPLIANCES

Appliances that meet all  
the necessary certification.



# 2kW FAN HEATER

2kW portable fan heater suitable for occasional use in well-insulated areas. Ideal for temporary heating for councils, housing associations and social housing.

• **CODE: A998770**

## KEY FEATURES

- 2 heat settings: 1000W, 2000W
- Cool/warm/hot heater settings
- Power indicator light
- Adjustable thermostat
- Thermal automatic cut-out and overheating protection
- Safety thermal fuse built in
- Dual thermal automatic cut out
- Integral carry handle
- Certified to EN60335-1 & EN60335-2-30
- BEAB approved



# 2kW CONVECTOR HEATER

2kW convector heater with adjustable thermostat, best used in well-insulated spaces or for occasional use. Suitable for temporary heating for councils, housing associations and social housing.

• **CODE: A998730**

## KEY FEATURES

- On-off control
- Floor standing
- 3 heat settings: 750W, 1250W, 2000W
- Thermostatic on/off control
- Resettable overheat cut-out
- Integrated handle
- Adjustable thermostat
- Automatic thermal cut-off
- Thermal fuse
- Certified to EN60335-1 & EN60335-2-30



# 2kW OIL FILLED RADIATOR

2kW 9-fin oil filled radiator suitable for occasional use in well-insulated areas. Suitable for temporary heating for councils, housing associations and social housing.

• **CODE: A998775**

## KEY FEATURES

- 220~240V, 50Hz, 2kW
- With 9 fins, fin size: 120 x 550mm
- 3 heat settings (800, 1200, 2000W)
- Adjustable thermostat
- Automatic thermal cut-off
- Thermal fuse
- Anti-tip switch
- Cable length: 1.45M with cord storage
- Integrated handle
- Castors for easy movement
- Certified to EN60335-1 & EN60335-2-30





# **WINTER** **ACCESSORIES**

Be prepared for the cold weather.

## TURN UP BLACK BEANIE

• CODE: AHBB1

### KEY FEATURES

- Double layer knit beanie
- Turn up



## BLACK BEANIE

• CODE: AHBB2

### KEY FEATURES

- Double layer knit beanie



## BLACK SNOOD

One size fits most with an elastic draw string toggle made from breathable material.

• CODE: AHBS1



# WINTER KIT

Winter Essentials to keep you moving! A must have van or car essential over the winter period.

• **CODE: WK400**

## KEY FEATURES

- De-icer melts ice as low as  $-10^{\circ}\text{C}$
- Screen wash effective to as low as  $-5^{\circ}\text{C}$
- Screen wash makes up to 2 litres dilution



## KIT CONTAINS

- 1 x 400ml De-icer Spray
- 1 x 500ml Screen Wash
- 1 x Ice Scraper

## 400ml DE-ICER SPRAY

### KEY FEATURES

- Fast acting formula
- Rapidly melts ice as low as -10c
- CODE: DEICE400



## ICE SCRAPER

### KEY FEATURES

- Robust PP scraper
- Foam covered handle for comfort grip
- CODE: AHICE1



## 500ml CONCENTRATED SCREEN WASH

### KEY FEATURES

- Helps prevent freezing
- Effective to as low as -5c
- Removes dirt & insect deposits
- MAKES UP TO 2 LITRES
- CODE: SCREEN500

# ARCTIC HAYES



[www.arctic-hayes.com](http://www.arctic-hayes.com)  
[sales@arctic-hayes.com](mailto:sales@arctic-hayes.com)  
0113 271 5245  
9 Millshaw Park Ave, Leeds, LS11 0LR

**GREAT KIT.  
JOB DONE.**