

# Flexi Lite Slab and Foot Kit

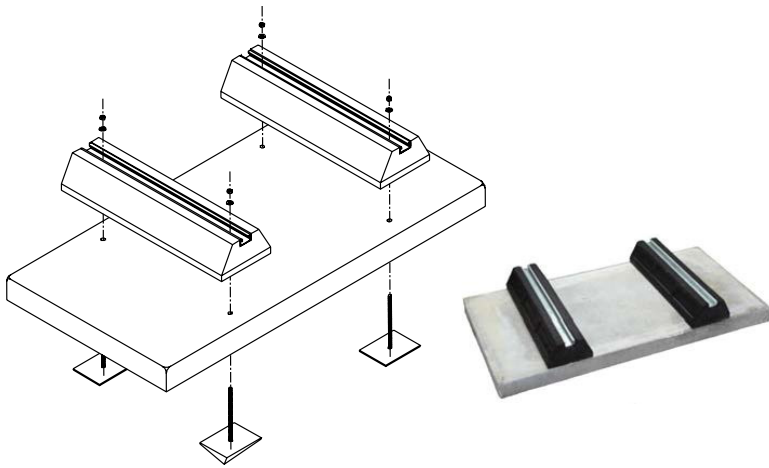

# Flexi



# Lite Slab and Foot Kit

A low cost innovative solution for floor mounting air conditioning units and ASHP. The FLEXI Lite Slab and Foot kit avoids the high cost and time consuming need to construct a concrete base and comes complete with FLEXI rubber mounting feet. It can be delivered to site with minimum preparation and can be assembled in minutes. It also suits most brands of domestic air source heat pumps and air conditioning units.

## Features

- Low cost and rapid installation time
- Easy to transport and locate
- Safe working load – 600kg
- Simple to construct
- Fixing pack to secure feet to the slab
- Fixing pack to secure a heat pump to the feet

## Related Products

**Wooden Guard**  
**ASHP Soakaway**  
**Collection Tray**  
**Floor Bracket Kit**

## The Package

- Flexi Slab • 2 or 3 x Flexi Feet
- 4 x Fixing Plate • Fixings
- Installation Instructions



1. Position the light weight slab in the required location of the ASHP unit.



2. Place both feet on the light weight slab to match the pitch of ASHP feet.



3. Insert all 4 base plates through the light weight slab and reposition to the required location of the ASHP unit.



4. Place both feet onto the threads and secure with nuts and washers.



5. Secure the ASHP units onto the kit - the installation is complete.

Part Code	Description	Width	Height	Length	Weight	Safe Working Load*
FF-UC3	Flexi Slab Kit (2 x 600mm Feet) 41mm strut	600mm	175mm	1200mm	27.5kg	600kg
FF-UC3-3	Flexi Slab Kit (3 x 600mm Feet) 41mm strut	600mm	175mm	1200mm	31kg	600kg
FF-UC3-ASN	Flexi Slab Kit (2 x 600mm Narrow Feet) M10 strut	600mm	175mm	1200mm	31kg	600kg
FF-UC3-XL	Flexi Slab Kit - Extra Large (2 x 600mm Feet) 41mm strut	865mm	175mm	1650mm	47kg	600kg
FF-UC-PLATE-KIT	Ultralite Slab & Fixing Plate Kit - 4 Plates & Fixings					

The Pump House sales team are available to answer your questions or queries on this product. Our experts are waiting for your call **+44 (0)115 900 5858** or if you prefer send an email to **sales@pumph.co.uk** or visit **www.pumph.co.uk**

