

# BRISTAN

TAPS & SHOWERS

## Installation Instructions & User Guide

Please leave these instructions with the end user

Product code: Z2 1/2 C

D6

### Specifications

**Dynamic Water Pressure**  
Min: 0.5 bar Max: 5.0 bar



**Maximum Static Pressure: 10.0 bar**

If the supply pressure is above 3 bar, a pressure reducing valve must be fitted

### Maximum Operating Temperature

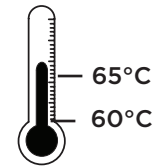

60-65°C recommended



The Flow Valve is timed and will shut off in 15 ± 5 seconds

\*This will vary depending on system pressure

### Inlet Connections

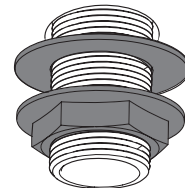

1/2" Male BSP Tap connector

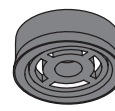

5/Ltr Flow Regulator Pre-Fitted

### Tools You'll Need

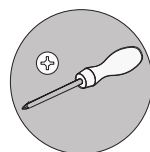

Cross screwdriver

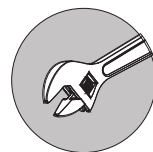

Adjustable spanner

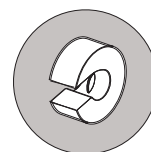

Pipe cutter

### Prior to Installation

All products manufactured and supplied by Bristan are safe provided they are installed, used correctly and receive regular maintenance in accordance with these instructions.

This product has been tested to the Water Regulations Advisory Scheme (WRAS) and satisfies the requirements of the Water Supply (Water Fittings) Regulations 1999 and current bylaws. For full Installation Requirements & Notes (IRN) please visit [wras.co.uk/directory](http://wras.co.uk/directory).

We recommend isolation valves to be fitted to the inlet water supplies to ensure ease of future maintenance.

Before installing these taps the water supply must be thoroughly flushed in order to remove any swarf, solder etc. This product must not be modified in any way as this will invalidate the guarantee.

### Pack Contents

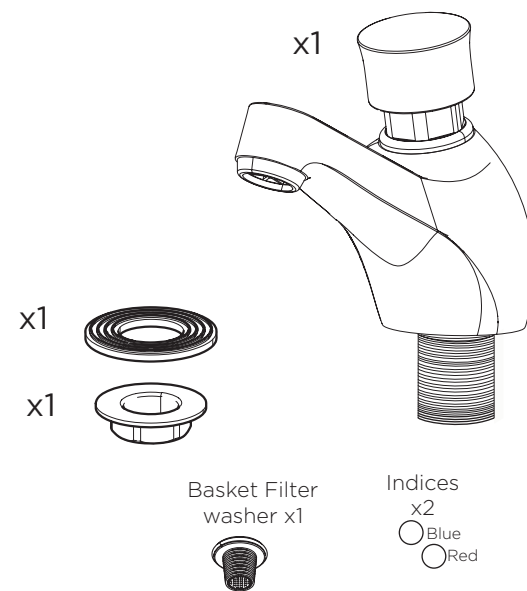

x1

x1

Basket Filter washer x1

Indices x2

Blue

Red

### Spare Parts For Your Tap

To replace any spare parts for your tap, why not scan the QR Code or visit [www.bristan.com](http://www.bristan.com) and search for your product.



### Installation

1

Fit the tap to the basin.

3

3

Connect the hot and cold water supplies to the threaded tails.

5

Turn on water supply for a few minutes and check all joints and connections for any leaks.

Turn on water supply

2

Secure the taps to the basin by using the washer and metal backnut below the basin

4

**Important**  
If the supply pressure is above 3 bar a pressure reducing valve must be fitted

**Important**  
Please ensure that the correct colour indice is fitted

Please fit the basket filter washer into the tail in the order shown

Depending on chosen hot or cold water supply, fit indice (supplied)

### Operation

Push down to get flow of water

The tap will shut off up to 15 ± 5 seconds\*

## Maintenance - Cartridge Cleaning

**1**

Remove indice and unscrew the retaining screw

Remove handle.

**2**

Unscrew the valve and pull out the valve from the tap body

**3**

To gain access to the flow limiter you need to separate the valve.

The top of the valve will need to be pull up, whilst twisting the lower part.

**4**

When you remove the valve the flow limiter it may be in different positions with the valve

Pull out of this end

Push through the end

**5**

Rinse the flow limiter and valve body, if necessary wash with warm soapy water

O'rings

Apply grease around the valve body, in particular the 2 o'rings

**6**

Place flow limiter back in position and secure the valve together.

Replace handle

**Important**  
Prior to doing any maintenance or servicing the isolation valves **must** be turned to the closed/off position.

## General Cleaning

Your fitting has a high quality finish and should be treated with care to preserve the visible surfaces.

All surfaces will wear if not cleaned correctly, the only safe way to clean your mixer tap is to wipe with a soft damp cloth. Stains can be removed using washing up liquid. All bath cleaning powders and liquids will damage the surface of your fitting, even the non-scratch cleaners.

**Note:** Never use abrasive detergents or disinfectants or those containing alcohol, hydrochloric acid or phosphoric acid.

## Troubleshooting

Symptom	Cause	Remedy
No flow or low flow rate	Partially closed isolation valve.	Open isolation valve.
	Instantaneous water heater cycles on and off as flow rate or pressure is too low.	Increase water flow rate or pressure through system.
	Head of water is below the minimum distance required.	5 meters minimum required.
	Hot or cold water being drawn off elsewhere causing pressure changes or instantaneous boiler temperature changes.	Do not use other water outlets when using the taps.
	Airlock or partial blockage in the supply pipework.	Flush through pipework to ensure removal of debris and any airlocks.
Water dripping from taps	This is normal for a short time after using the taps.	This is caused by residual water tension, the build up of water in the tap body.
	If water continues to drip, possibly due to the ceramic disc valves	Remove valves and clean, refer to 'Maintenance' section before starting any maintenance.
Taps do not turn on	Closed isolation valve.	Open isolation valve.
	Mains water supply turned off.	Turn on mains water supply.

## Maintenance- Flow Straightener

**1**

Unscrew the flow straightener and soak in descaler.

**2**

Rinse the flow straightener

**3**

Replace the flow straightener into spout

## Notes

Please use this space for any notes you or your installer may have regarding the installation/plumbing of this product.

At Bristan, we want to make things as easy as possible for our customers. That's why we offer solid guarantees on all our products, effective from the date of purchase, to give you peace of mind. To start your free **guarantee** simply scan the QR code and register your product. Alternatively visit [www.bristan.com/register](http://www.bristan.com/register) to register your product via a computer.



For full guarantee terms and conditions visit [www.bristan.com/guarantees](http://www.bristan.com/guarantees).

*We Know & We Care*