

**radbot 1**  
Intelligent radiator  
thermostat

Instruction manual

<b>Topic</b>	<b>Page no.</b>
What's in the box?	3
Safety instructions	4
Compatibility	4
Getting started	4
About Radbot 1	4
Get to know your Radbot 1	5
Installing Radbot 1	6
Finding an ideal location	7
Removing the old thermostat	8
Fitting the correct adaptor	8
Installing the batteries	9
Fitting Radbot 1	9
Using Radbot 1	10
Setting the temperature	11
Additional temperature settings	11
Temperature set back feature	11
Using the Boost function	12
Additional features	12
Replacing the batteries	13
Maintenance	13
Troubleshooting	14
Technical specifications	15
LED pattern	15

# What's in the box?

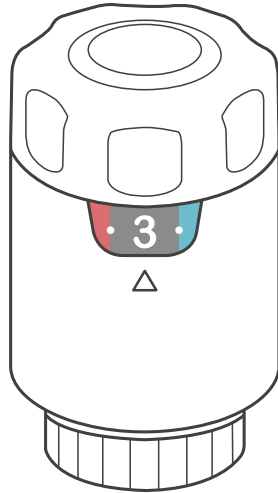

Radbob 1 Intelligent radiator thermostat

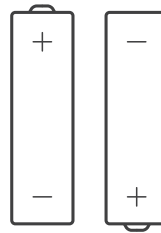
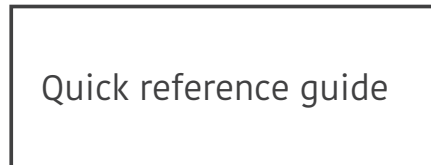

2 X AA batteries

## Adaptors

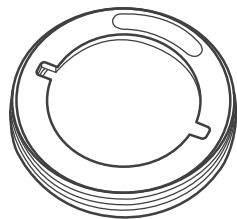

M30x1.5

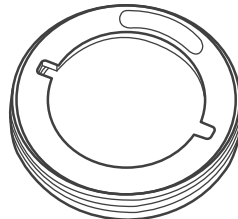

M30x1.0

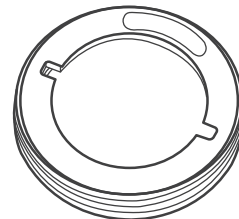

M28x1.5

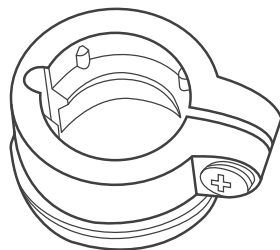

RA

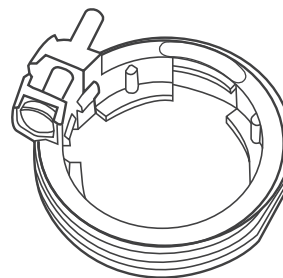

RAVL

# Safety instructions



## Read these instructions carefully before you begin the installation

Secure meters will not be liable for any damage or loss arising from incorrect installation or use of the device or components.

- Take care when installing and using Radbot 1 as radiators and pipes may be hot if your heating is on.
- Radbot 1 is for indoor use only and must be protected from humidity.
- Do not attempt to dismantle or modify the device in any way.
- The battery cover must only be removed to replace the batteries.
- Batteries should be kept away from small children.
- We recommend to fix any pre-existing problems with your radiators, valves or pipework prior to installing Radbot 1.



Dispose of responsibly. Do not throw electrical equipment and batteries into the household waste. The product is regulated under the Waste Electrical and Electronic Equipment Directive (WEEE)

## Compatibility

The device is compatible with most wet central heating systems that use radiators, including:



- Combi, system, and heat only boilers
- District heating with individual radiators
- Heat pumps (with flow temps  $>45^{\circ}\text{C}$ )



Radbot 1 will not work with electrical heating systems or electric radiators.

## Getting started

This guide provides instructions to install, set up and use Radbot 1.

More information on the product including How to videos, FAQs and customer support details, can be found at [www.securemeters.com](http://www.securemeters.com).

## About Radbot 1

Radbot 1 lets you to control the heating of your rooms by regulating the flow of hot water through the radiator they are fitted onto. With intelligent in-built logic, it senses the temperature and occupancy status in a room and automatically adjusts the heating to provide you the desired comfort. This ensures each room is warm when you are using it and that you are not wasting energy in heating empty rooms.

## Get to know your Radbot 1

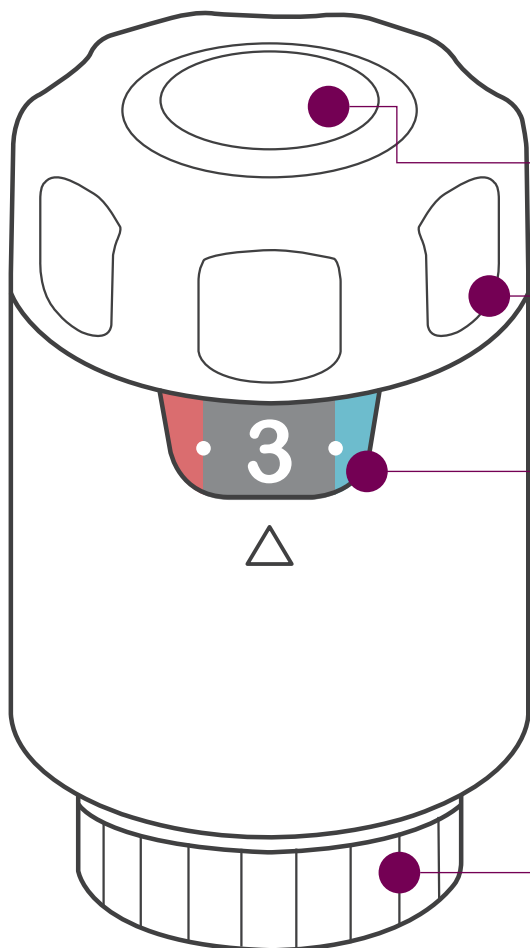

### **Boost button**

Provides 30 mins heating boost

### **Control wheel**

Used to set the comfort level

### **Temperature dial**

Shows comfort setting on a scale of 1-5

### **Retaining ring**

Used to secure radbot to your radiator valve

### **Battery Cover**

Slide cover off/on to insert or remove batteries

### **Battery compartment**

Uses 2 AA batteries

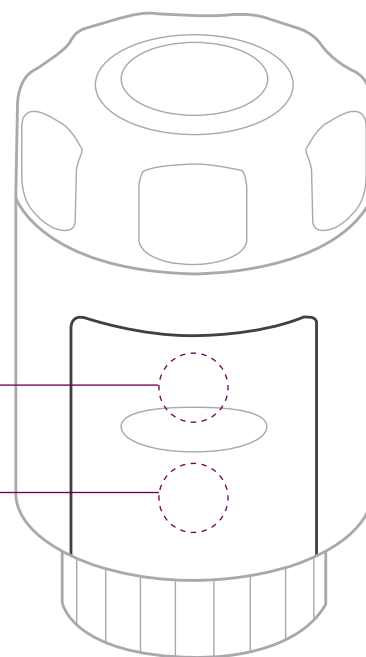

# Installing Radbot 1

# 1. Finding the ideal location

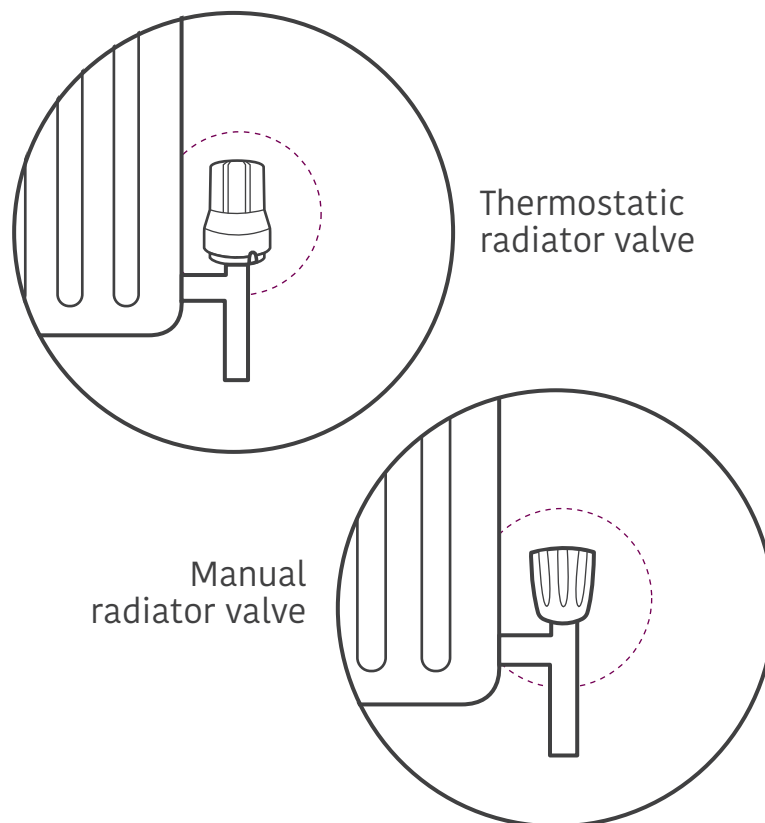

## Where to install

Radbot 1 can be installed on any radiator that already has an existing thermostatic radiator valve. However, ensure that the device has a free flow of air to sense the temperature and predict occupancy.

If any of your radiators have manual valves you will first need to replace these with thermostatic valves. We recommend using a qualified plumber for this job.

## Where not to install

Do not cover the thermostat behind curtains, radiator panels or furniture.

Radbot 1 must not be installed in the same room as your main thermostat. This can cause your heating to be permanently on if the thermostat is set to a higher temperature than the radiator valve.

## 2. Removing the old thermostat

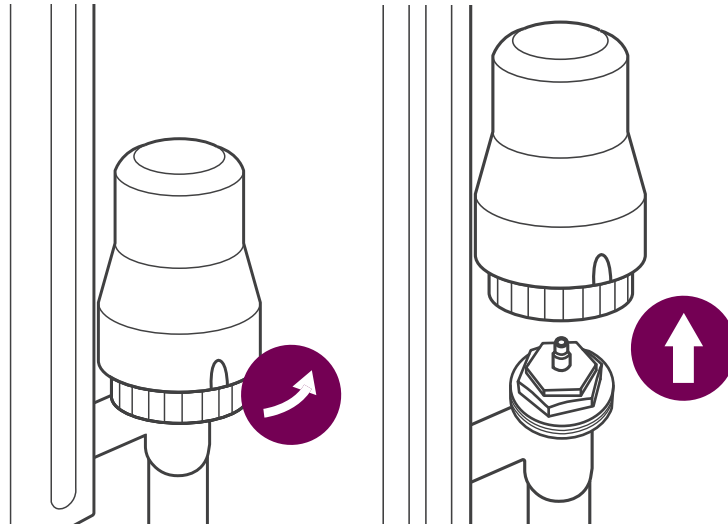

Loosen the retaining ring at the base of the valve and lift off the old thermostat.

Tip - Replace leaking or corroded valves before you install Radbot 1. Get advice from a plumber if you are unsure how to do this.

## 3. Fitting the correct adaptor

### Adaptor selection

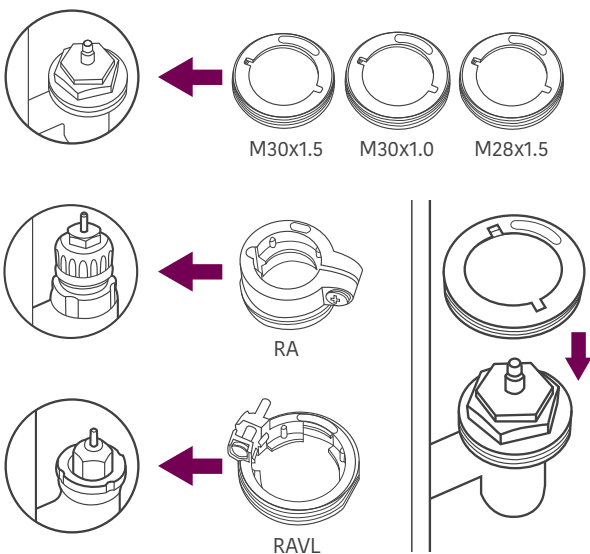

Securing the adaptor

- 1 Study the adaptor selection diagram. Different adaptors are provided to enable Radbot 1 to be fitted to the majority of radiators found within the UK and Europe.
- 2 Slide the adaptor over the radiator valve and check if it is the correct size - it should fit securely around the valve.  
  
Note: If required, try fitting each adaptor until you find the ideal match.
- 3 Secure the adaptor to the metal valve by screwing it clockwise (M30x1.5, M30x1.0 & M28x1.5) or use a small screw driver to tighten the locking screw (RA & RAVL)



## 4. Installing the batteries

After securing the correct adaptor on the radiator valve, insert the batteries as shown.

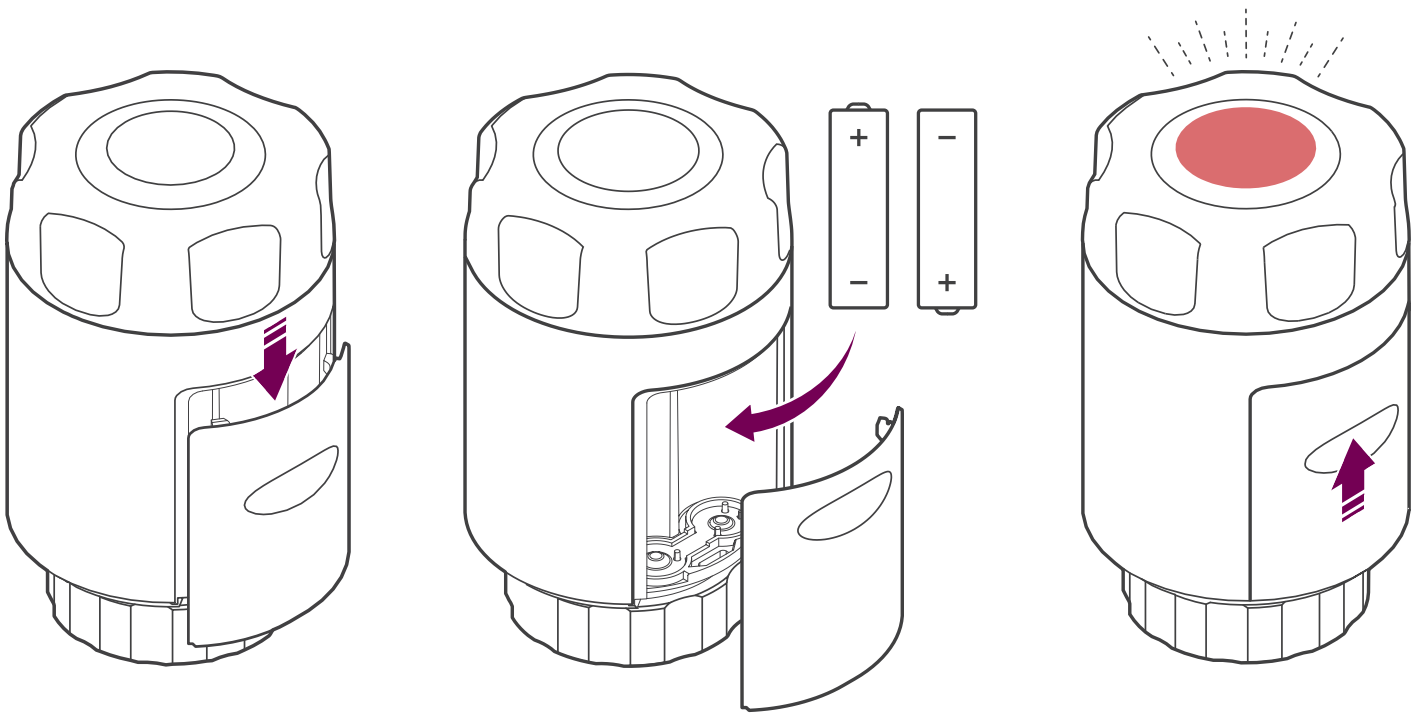

Note: If the batteries are properly fitted, the LED should give one long red flash to indicate the device is active.

## 5. Fitting Radbot 1

After you insert the batteries, it is important NOT to press the boost button or turn the temperature wheel until the device is installed onto the radiator. \*

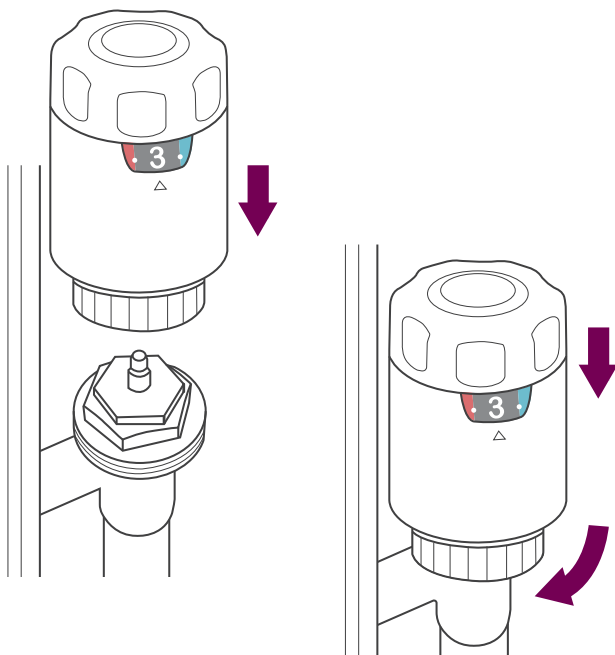

- 1 Using the retaining ring, tighten Radbot 1 on the adaptor, while rotating the unit to ensure the temperature dial is facing towards you in a position where it can be easily read.
- 2 Hand tighten the retaining ring ensuring the device is securely fixed on the radiator valve.
- 3 The device is now ready for first use.

\* Pressing the boost button or turning the temperature wheel prior to installation can move the valve plunger from its factory set position making it difficult to install Radbot 1. If this happens accidentally, remove the batteries for ~ 2 minutes, reinsert and wait 60 seconds then restart the process.

# Using Radbot 1

## Setting the temperature

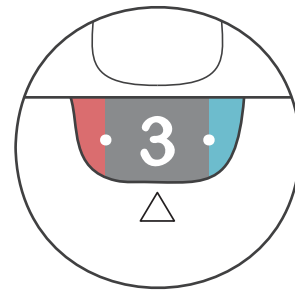
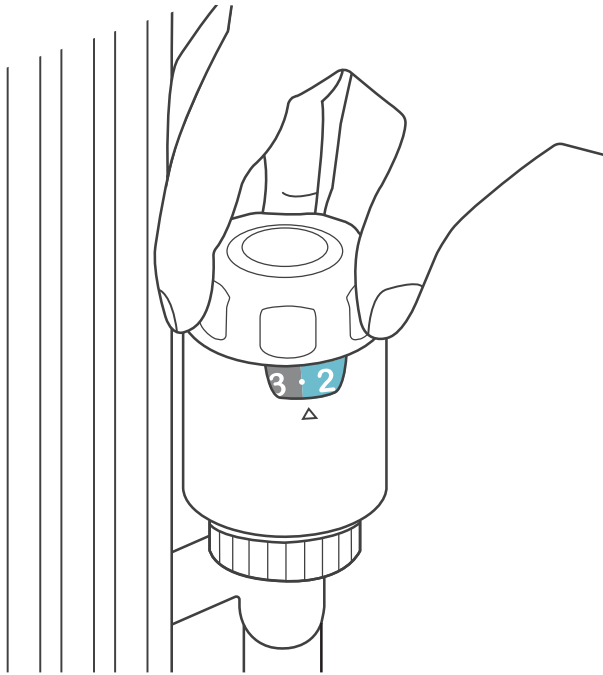

- Rotate the control wheel to set the temperature.
- The temperature dial has five settings to adjust the temperature according to your comfort. The mid point is set at 19°C on scale 3.
- Rotate the dial from 1 to 5 in counterclockwise direction to increase the temperature. Rotate it from 5 to 1 in clockwise direction to decrease the temperature.
- Each click on the dial changes the set point by 1°C, each full number by 2°C.

---

## Additional temperature settings



Sets the room temperature to the maximum allowable setting of 24°C

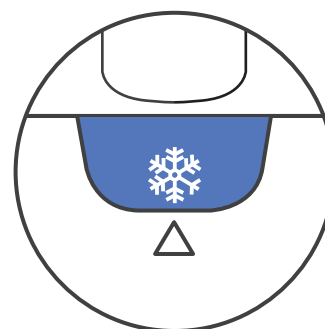

Activates the frost protection mode and sets the temperature to 6°C

## Temperature set back

Radbot 1 saves energy by setting back the temperature in a room when it detects the room is not being used. It works to save energy. As the dial is turned towards the cold end of the scale, the maximum allowed energy-saving temperature setback will be increased, and vice versa.

## Using the Boost function

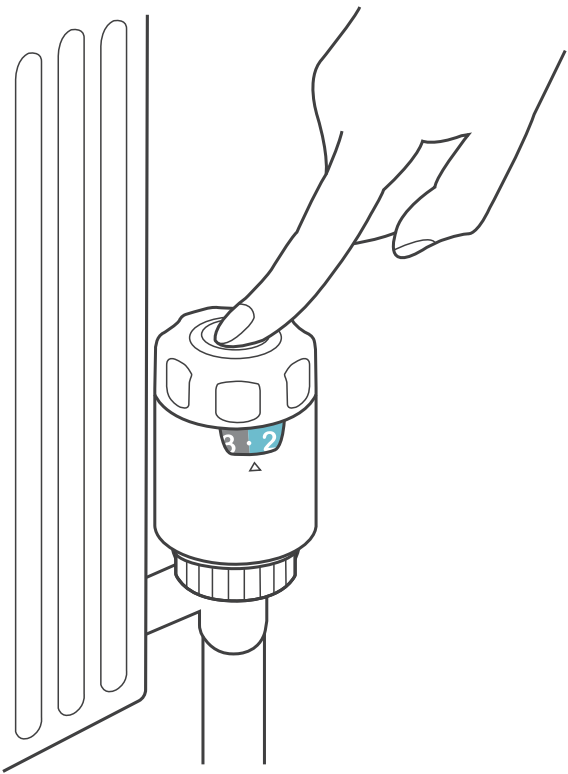

If you are feeling cold, press the Boost button. The thermostat will temporarily increase the temperature to the maximum set point for the duration of 30 minutes. At the end of this cycle, the device will revert to the previously selected set point.

Pressing the boost rather than adjusting the temperature dial is the best option for a temporary increase in heat as Radbot 1 will automatically revert to a normal temperature without anyone having to remember to turn the dial back down.

If the room temperature has already achieved the maximum temperature range supported by Radbot 1, the Boost function will not be activated.

If you press the boost by accident, you can cancel it by temporarily turning the temperature dial down and then resetting to the normal level you want for the room.

---

## Additional features

### Valve pin maintenance cycle

Over time, radiator valve pins can become stuck if not used regularly. To keep the valve functioning correctly, Radbot 1 automatically performs a weekly cycle (Decalcination) where the valve is opened fully and then returned to its normal position.

### Frost protection

If the dial is positioned to the snowflake, the device will be in FROST mode. The temperature set point will be nominally lowered to 6 °C to save energy, but high enough to prevent frost damage. If high humidity is detected the temperature set point may be raised to reduce the risk of condensation.

# Replacing the batteries

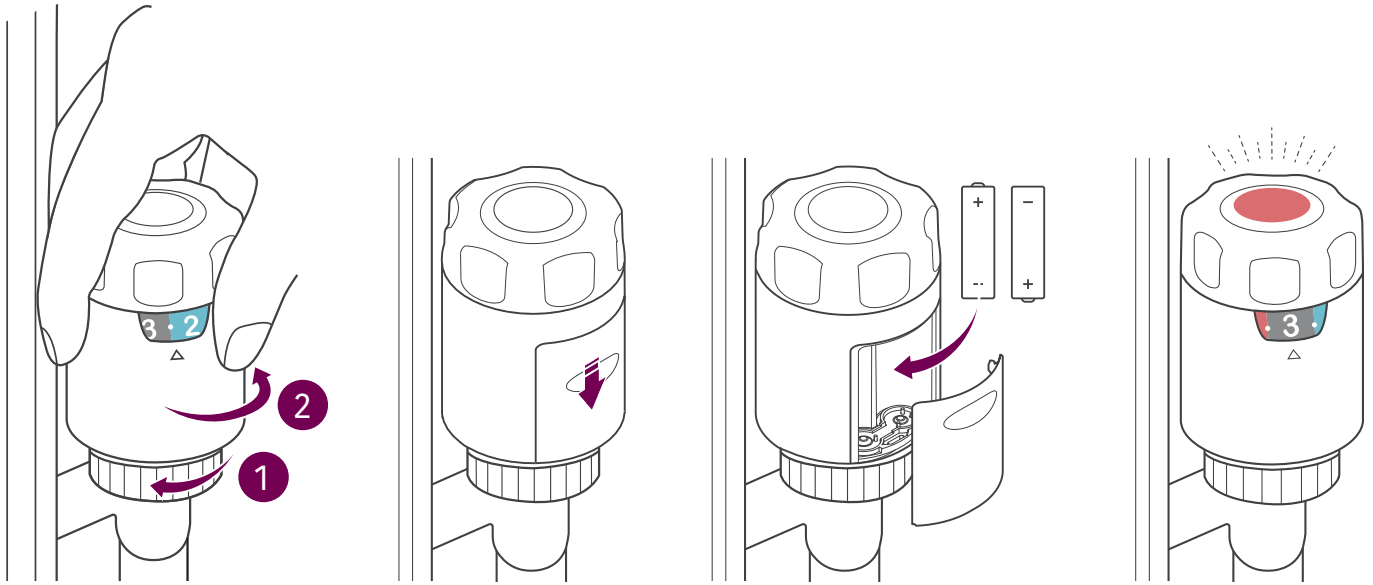

Alternatively remove the unit from the radiator, replace the batteries and repeat the installation procedure.

Note: We recommend that new batteries should be inserted within 5 mins of removing the old batteries to ensure Radbot 1 retains its internal memory of recent occupancy events and heating schedule.

## Maintenance

### Batteries

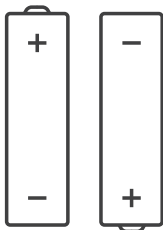

2 X AA batteries

- Under typical operating conditions the batteries should last 2 years.
- The red LED will flash continually to indicate a low battery warning. This is displayed until the batteries run out.

# Troubleshooting

PROBLEM	REASON	SOLUTION
Room gets too hot	Batteries have run out Radbot 1 has not been tightened sufficiently to valve so the pin is unable to close the valve	Replace with new batteries Check connection and if loose, push down Radbot 1 and tighten retaining nut
Radiator will not turn off	Radbot 1 has not been tightened sufficiently to valve - pin not able to close valve	Check connection and if loose, push down Radbot 1 and tighten the retaining nut
Radbot 1 will not respond to controls	Batteries depleted	Replace with new batteries
Rapid flashing LED and no other activity	Device is mal-functioning due to hardware/software fault	Check with customer support
Room temperature control seems strange.	Batteries were left flat or out for an extended period, or the device was moved to a new room, and the device has to re-learn time of day and room use.  The device cannot function due to obstruction or blocking.	The device will re-learn over the course of a few days.  Replace batteries before they are completely exhausted  Check device is not covered by objects (e.g. curtains) and ensure adequate air circulation around device.
Valve is loose on radiator.	Retaining ring has not been tightened sufficiently. Pin was not fully retracted during installation.	Tighten retaining ring.  If still loose remove and reinstall Radbot checking valve adaptor.

# Technical specifications

Product description	Electronic radiator controller incorporated control, type 1 action
Recommended use	Residential/similar use, indoor only
Type code	SCV100
Size (including retaining ring)	L x W x H = 90 mm x 55 mm x 55 mm
Weight (including batteries)	Approx 164 grams
Power	2 x 1.5 V (LR6) AA alkaline batteries
Power consumption	3 µW sleep, 1.5 W peak
Battery life (normal operating conditions)	2 years
Temperature range (working)	0 to 40°C
Temperature range (storage)	-20 to 60°C
Max water circulation temperature	90°C
Temperature set point range	15°C to 24°C, Frost protection 6°C
Temperature set point interval	1°C
Motor	Linear motion 5.8 mm max
Pin force	70 N max
Protection class	IP30
Pollution degree	2
Others	Ball pressure test verified at 75°C

## LED pattern

Name	When	Description
Power-on	When the batteries are inserted	One long (~1s) flash to indicate the device is active
Boost	On starting boost mode	Immediate long flash on releasing the Boost button, medium flash every 2s for two minutes and then flash every 8s for up to about 30 minutes if the room is not dark.
Acknowledge	Acknowledging adjustment of the dial	Single flash once the dial position has been changed
Low Battery	Low battery warning	Repeated medium flash every 2s until battery is exhausted or replaced. Most Radbot 1 features will not operate.
Fault	When a hardware or software unrecoverable failure is detected	Continual rapid flashing, more than once per second, until battery exhausted or replaced. Radbot 1 will not operate.



Secure Meters (UK) Ltd  
Secure House, Lulworth Close, Chandler's Ford  
Eastleigh, SO53 3TL, United Kingdom

Secure Meters (Sweden) AB  
Repslagaregatan 43, Box 1006, SE-611 32  
Nykoping, Sweden

