



For a cleaner conscience

# ENVi®

Next generation electric showers



Visit [tritonshowers.co.uk/envisupport](https://tritonshowers.co.uk/envisupport)  
or scan the **QR code** for instant access to  
ENVi® Product Support.



## Installation Instructions

Please read this book thoroughly and familiarise yourself with all instructions before commencing installation and keep it for future reference.

The installation **MUST** be carried out by a suitably qualified person, **in the sequence of this instruction book**.

### IMPORTANT SAFETY ADVICE

The ENVi® shower system **MUST BE** switched off at the isolating switch when not in use. This is a safety procedure recommended for all electrical appliances.

The shower head and hose supplied with this product are safety critical parts of your shower. Failure to use genuine Triton parts may cause injury and invalidate your guarantee.

# IMPORTANT SAFETY INFORMATION

Products manufactured by Triton are safe and without risk, provided they are installed, used and maintained in good working order in accordance with our instructions and recommendations.

- ⚠ **WARNING: DO NOT** operate the shower if there is a possibility of frozen water within the heater or pipes feeding the shower.
- ⚠ **DO NOT** operate the shower if the shower head or spray hose becomes damaged.
- ⚠ **DO NOT** restrict flow out of shower by placing shower head in direct contact with your body or any other surface.
- ⚠ **DO NOT** operate the shower if water ceases to flow during use.
- ⚠ **WARNING:** If restarting the shower immediately after stopping, be aware that a slug of hot water could be expelled for the first few seconds.
- ⚠ Any spray head must be descaled regularly.
- ⚠ Fit only shower heads and hoses recommended by the manufacturer and never fit any additional device to restrict the water outlet flow.
- ⚠ The outlet must not be connected to any tap or fitting other than those specified by the manufacturer.
- ⚠ This appliance is intended to be permanently connected to the water mains and not connected by a hose set.
- ⚠ The water inlet of this appliance must only be connected to mains cold water supply. The water inlet must never be connected through any other water heating system.
- ⚠ **WARNING:** This appliance is not to be used for a potable water supply.
- ⚠ A suitable double pole isolation switch for supply disconnections must be incorporated in the fixed wiring circuit in accordance with current wiring regulations. See Electrical Installation section for further details.
- ⚠ The water inlet of this appliance shall not be connected to inlet water obtained from any other water heating system.
- ⚠ Mains water pressure only.
- ⚠ Minimum Dynamic inlet pressure 70kPa (0.7 bar)  
Maximum Static inlet pressure 1000kPa (10 bar)

This book contains all the necessary fitting and operating instructions for your electric shower. Care taken during the installation will provide a long, trouble-free life from your shower.

## ⚠ **WARNING** ⚠

This appliance can be used by children aged from 3 years and above and persons with reduced physical, sensory or mental capabilities or lack of experience and knowledge if they have been given supervision or instruction concerning use of the appliance in a safe way and understand the hazards involved. Children may not play with the appliance. Cleaning and user maintenance shall not be made by children.

# IMPORTANT SAFETY INFORMATION

## GENERAL

- Isolate the electrical and water supplies before removing the cover.
- Read all of these instructions and retain them for later use.
- **DO NOT** take risks with plumbing or electrical equipment.
- Isolate electrical and water supplies before proceeding with the installation.
- The Tri-HUB must be mounted vertically onto a wall or plinth.
- Contact Customer Experience (see back page), if any of the following occur:
  - If it is intended to operate the shower at pressures above the maximum or below the minimum stated.
  - If the unit shows a distinct change in performance.
- If it is intended to operate the shower in areas of hard water (above 200 ppm temporary hardness), a scale inhibitor may have to be fitted. For advice on the scale inhibitor, contact Customer Experience.
- The shower head must be cleaned regularly with descalent to remove scale and debris, otherwise restrictions to the flow on the outlet of the unit will result in reduced thermostatic performance.
- This product is not suitable for mounting into steam rooms, steam cubicles or exposed to outdoor elements.

## PLUMBING

- The plumbing installation must comply with Water Regulations, Building Regulations or any particular regulations as specified by Local Water Company or Water Undertakers and should be in accordance with BS EN 806.
- The supply pipe must be flushed to clear debris before connecting to the shower unit.
- **DO NOT** solder fittings near the shower unit as heat can travel along pipework and damage components.
- **DO NOT** fit any form of outlet flow control as the outlet acts as a vent for the heater can.
- **DO NOT** use excessive force when making connections to the flexible hose or shower head, finger tight is sufficient.
- All plumbing connections must be completed before making the electrical connections.

## ELECTRICAL

- The installation must comply with BS 7671 'Requirements for electrical installations' (IEE wiring regulations), building regulations or any particular regulations as specified by the local Electrical Supply Company.
- This appliance **MUST** be earthed.
- In accordance with 'The Plugs and Sockets etc. (Safety) Regulations 1994', this appliance is intended to be permanently connected to the fixed wiring of the electrical mains system.
- Make sure all electrical connections are tight to prevent overheating.
- A 30mA residual current device (RCD) **MUST** be installed in all UK electric and pumped shower circuits. This may be part of the consumer unit or a separate unit.
- Switch off immediately at isolating switch if water ceases to flow during use.
- Other electrical equipment i.e. extractor fans, pumps, must not be connected to the circuits within the unit.
- Switch off at the isolating switch when not in use. This is a safety procedure recommended with all electrical appliances.
- As with all electrical appliances it is recommended to have the shower and installation checked at least every two years by a competent electrician to ensure there is no deterioration due to age and usage.

# CONTENTS

	Page
Important Safety Information .....	2
Introduction	
Advice to Users .....	5
Product Fiche .....	5
Specification .....	6
WEEE Policy Statement .....	6
Dimensions and Connections .....	7
Main Components .....	8
Installation Requirements	
Plumbing .....	9
Diagrammatic View .....	10
Electrical .....	11
Tri-HUB Installation	
Positioning .....	13
Step by Step Instruction .....	14
ENVi® Controller Installation	
Positioning .....	16
Data Cable Installation.....	16
Step by Step Instruction .....	17
Commissioning ENVi® Shower System .....	18
Maintenance	
Inlet Filter .....	21
Rechargeable Battery Replacement .....	21
Freezing Precaution .....	22
Thermal Purge .....	24
Error Codes .....	25
Fault Diagnostics .....	26
UK Service policy / Guarantee, etc. ....	Rear

# INTRODUCTION

Please read this book thoroughly and familiarise yourself with all instructions before commencing installation.

Please keep it for future reference.

The shower installation **MUST** be carried out by a suitably qualified person, in the sequence of this fitting instruction.

## ADVICE TO USERS

**IMPORTANT:** When first installed the Tri-HUB will be empty of water. It is essential that the heater assembly should contain water before the heating elements are switched on. It is vital that the commissioning procedure is followed. Failure to carry out this operation will result in damage to the unit and will invalidate the guarantee.

The following points will help you understand how the shower operates:

- a) The electric heating elements operate at a constant rate. It is the rate of water passing over the heater elements which determines the water temperature. The slower the water flow, the hotter the water becomes; the faster the water flow, the cooler the water.
- b) During winter, the mains water supply will be cooler than in the summer. The water flow rate will therefore vary between seasons, the thermostatic control of the Tri-HUB will automatically maintain the desired temperature.
- c) The temperature controls can be adjusted to provide shower temperatures between 32°C and 46°C (or ambient if cold mode is activated). At any selected showering temperature the unit will automatically provide the optimum flow rate possible.

**IT IS ADVISED THAT WHERE THE PROPERTY IS LEFT UNATTENDED FOR AN EXTENDED PERIOD OF TIME, THAT THE WATER AND ELECTRICITY SUPPLIES TO THE Tri-HUB ARE ISOLATED.**

PRODUCT FICHE		
Model	9.0W	10.5kW
Load Profile	XS	XS
Energy Efficiency Class	A	A
Energy Efficiency (%)	39	39
Annual Electricity Consumption (kwh)	476	474
Sound Power Level (db)	15	15

# SPECIFICATION

<b>Electrical</b>		
Nominal Power Rating at 240V	9.0kW	10.5kW
Nominal Power Rating at 230V	8.3kW	9.6kW
Supply Fuse/Miniature Circuit Breaker (MCB)	40Amps	45Amps
Residual Current Device (RCD)	30mA	30mA
Isolation Switch	45Amp Double Pole isolating switch (with 3mm minimum contact gap)	
Supply Cable	16mm <sup>2</sup> Maximum (refer to 'Electrical Requirements')	
<b>Water Supply</b>		
Supply Type	Mains pressure cold water only	
Minimum Pressure (Dynamic)	70kPa (0.7 bar)	
Maximum Pressure (Static)	1000kPa (10 bar)	
Inlet Water Temperature	2°C - 28°C	
Inlet Water Connection	15mm Stem (suitable for push-fit and compression fittings)	
Outlet Water Connection	15mm Stem (suitable for push-fit and compression fittings)	
<b>Ambient Temperature</b>	5°C to 40°C	
<b>Battery (within Tri-HUB)</b>	Lithium LIR2032 3.7V Rechargeable Battery	

## Accreditations



Intertek



IP25

## WEEE Directive – Policy Statement

As a producer and a supplier of electric showers, Triton Showers is committed to the protection of the environment via our own environmental policy and the compliance with the **WEEE directive**.

Triton Showers is fully registered with the Environment Agency under the following schemes:

Repic: Producers take-back scheme (PTS), registration number WEE/EJ3466QV

Valpak: Distributor take-back scheme (DTS), registration number DTS-501317-1



All our electric products are labelled accordingly with the crossed out wheeled bin symbol. This indicates, for disposal purposes at end of life, that these products must be taken to a recognised collection points, such as local authority sites/local recycling centres; this will be free of any charges. **Do not return to Triton Showers.**

# DIMENSIONS & CONNECTIONS

## ENVi® Controller (including Wall Fixing Bracket)

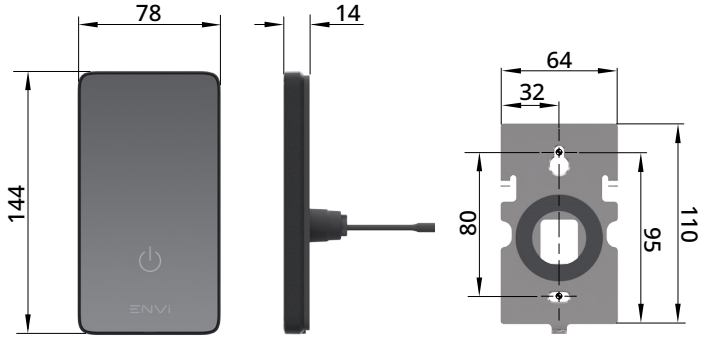

## ENVi® Tri-HUB

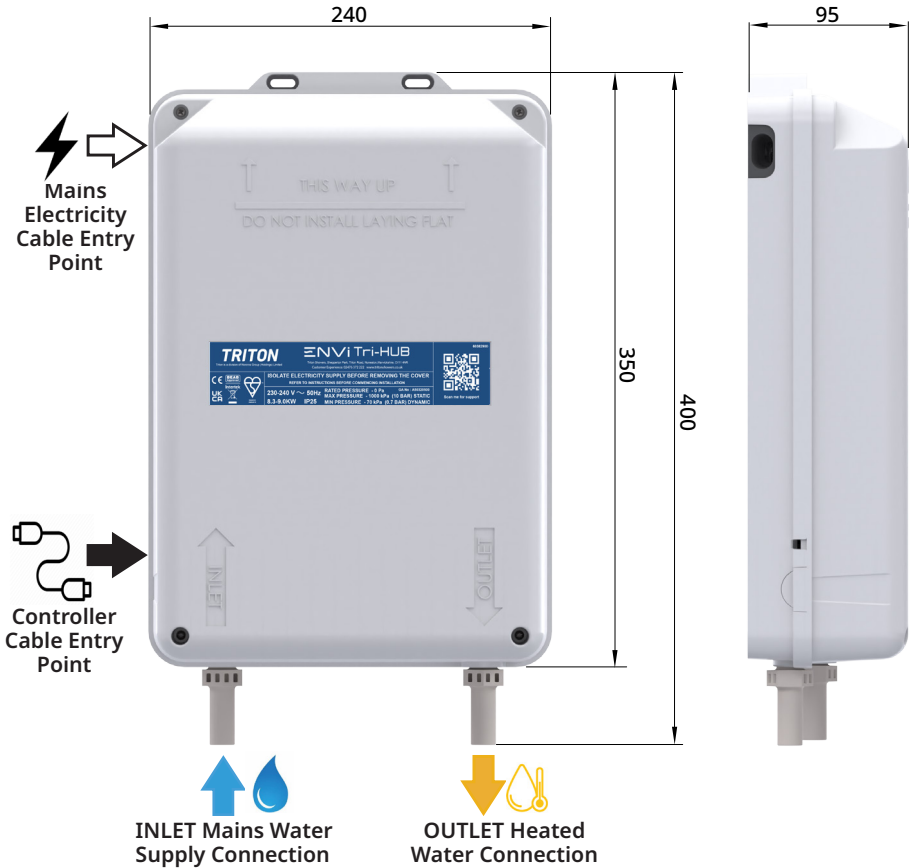

# MAIN COMPONENTS



1. Mains Cable Entry Grommet
2. Inlet Connector
3. Outlet Connector
4. Terminal Block
5. Data Cable Connector
6. Rechargeable Battery Holder
7. Data Cable Clamp
8. Wall Fixing Positions
9. Tri-HUB Front Cover
10. Inlet Filter Assembly
11. Thermal Safety Cut-Out
12. Main Printed Circuit Board
13. Heater Element Assembly
14. Control Valve
15. Flow Sensor
16. Inlet Thermistor
17. Outlet Thermistor
18. Solenoid Valve
19. Front Cover Fixings
20. ENVi® Controller
21. Controller Fixing Bracket
22. Data Cable
23. Rechargeable Battery



# INSTALLATION REQUIREMENTS

## PLUMBING REQUIREMENTS

Please read **IMPORTANT SAFETY INFORMATION** and **SPECIFICATION** sections before undertaking the plumbing installation.

**NOTE:** If the recommended dynamic pressure and flow is not available, there could be a noticeable reduction in performance from the shower head.

If it is intended to operate the shower at pressures above the maximum or below the minimum stated, contact Customer Experience for advice.

1. The Tri-HUB **MUST NOT** be positioned where it will be subjected to freezing conditions. Any pipework **MUST BE** insulated to avoid being frozen.
2. The installation must be in accordance with Water Regulations/Bylaws.
3. **DO NOT** use jointing compounds on any pipe fittings for the installation.
4. **DO NOT** solder fittings near the shower unit as heat can travel along pipework and damage components.
5. Compression or demountable push-fit fittings can be used to connect to the shower Inlet and Outlet connectors.
6. **NOTE:** DO NOT use non-demountable push-fit fittings on the Inlet and Outlet as this will prevent servicing and may invalidate the warranty of the product.
7. **Important:** An additional full bore stop valve (complying with Water Regulations) must be fitted in the mains water supply to the shower as an independent means of isolating the water to carry out maintenance or servicing. If this isolator and/or Tri-HUB is fitted in a loft space, the loft must have a fixed access ladder and be boarded, with appropriate lighting from the access point to the isolator.
8. **Important:** Before completing the connection of the water supply to the inlet of the shower, flush out the pipework to remove all swarf and system debris.
9. **Important:** The Tri-HUB must be mounted on a even vertical surface otherwise the Tri-HUB's inbuilt sensors will not allow for the ENVi® shower to operate.
10. **Position of the shower:** Refer to **Fig.1** for correct location of the Tri-HUB. Always mount the Tri-HUB vertically and allow enough room for the installation of elbows or straight connectors onto the Inlet and Outlet stems at the base of the Tri HUB.

**IMPORTANT Water Regulations:** It is required that the shower head be 'constrained by a fixed or sliding attachment so that it can only discharge water at a point not less than 25mm above the spill-over level of the relevant bath, shower tray or other fixed appliance'.

If the riser kit is supplied with a 'soap dish hose retainer' or bespoke 'hose retainer', it will in most cases meet this requirement. If the shower head can still be placed within a bath, basin or shower tray within the 25mm limit, then a double check valve, or similar, **MUST be fitted in the supply pipework to prevent back-flow.**

# INSTALLATION REQUIREMENTS

Fig.1 Diagrammatic view.

Tri-HUB must be connected to a single outlet kit recommended by the manufacturer.

**WARNING**  
 The Tri-HUB **MUST NOT** be positioned where it will be subjected to freezing conditions.

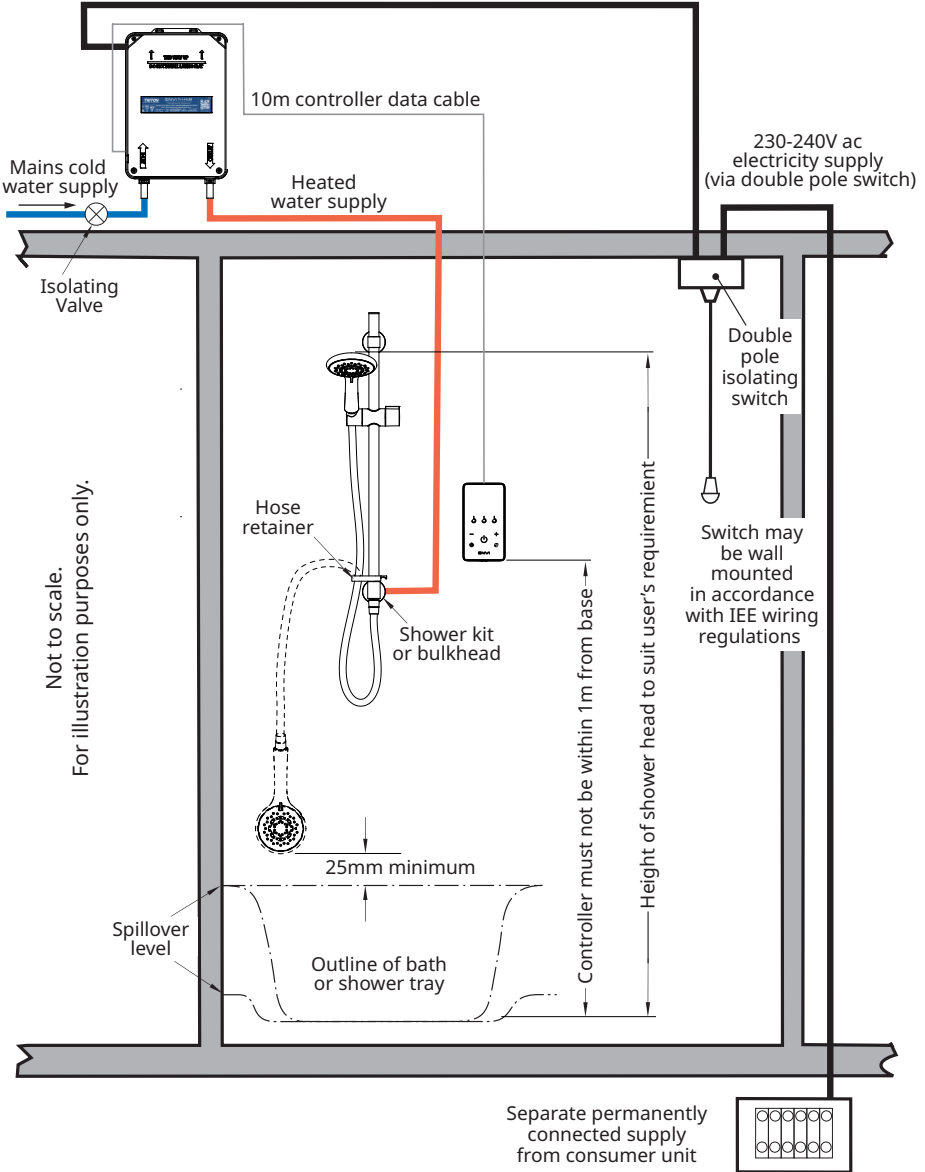

# INSTALLATION REQUIREMENTS

## ELECTRICAL REQUIREMENTS

Please read **IMPORTANT SAFETY INFORMATION** and **SPECIFICATION** sections before undertaking the electrical installation.

The installation, supply cable and circuit protection must conform with BS 7671 (IEE wiring regulations) and be sufficient for the amperage required.



**WARNING:** This Appliance must be earthed by connecting the supply cable earth conductor to the terminal block within the appliance.

The following notes are for guidance only:

1. The Tri-HUB must only be connected to a 230-240V AC supply. Any drops in voltage due to localised heavy demand may reduce the shower's performance
2. The electrical rating of the Tri-HUB is shown on the rating label (**Fig.3**) which is positioned on the front of the Tri-HUB cover.
3. Before making any sort of electrical connection within the installation make sure that no terminal is live. If in any doubt, switch off the whole installation at the mains supply and remove the correct fuse.
4. The Tri-HUB must be connected to its own independent electrical circuit. **IT MUST NOT** be connected to a ring main, spur socket outlet, lighting circuit or cooker circuit.
5. The electrical supply must be adequate for the loading of the unit and existing circuits.
6. Check your consumer unit (main fuse box) has a main switch rating of 80Amps or above and that it has a spare fuse way which will take the fuse or Miniature Circuit Breaker (MCB) necessary for the shower rating.
7. If your consumer unit has a rating below 80A or if there is no spare fuse way, then the installation will not be straightforward and may require a new consumer unit serving the house or just the shower. Contact a professional electrician/local electricity company for advisement.
8. For close circuit protection **DO NOT** use a rewirable fuse. Instead use a suitably rated Miniature Circuit Breaker (MCB) or cartridge fuse. Triton recommend the following circuit protection: **9.0kW variant - 40Amp 10.5kW variant - 45Amp**
9. A 30mA residual current device (RCD) **MUST** be installed in all UK electric shower circuits. This may be part of the consumer unit or a separate unit. A suitably rated RCBO could be used if the RCD is not present and the consumer is compatible with the RCBO.

Fig.2

Twin and earth PVC insulated cable Current carrying capacity		
Installed in an insulated wall	In conduit trunking	Clipped direct or buried in a non-insulated wall
6mm <sup>2</sup> 32A	6mm <sup>2</sup> 38A	6mm <sup>2</sup> 46A
10mm <sup>2</sup> 43A	10mm <sup>2</sup> 52A	10mm <sup>2</sup> 63A
16mm <sup>2</sup> 57A	16mm <sup>2</sup> 69A	16mm <sup>2</sup> 85A

Note: Cable Selection is dependent on derating factors

Fig.3



# INSTALLATION REQUIREMENTS

10. A 45 amp double pole isolating switch with a minimum contact gap of 3mm in both poles must be incorporated in the circuit. It must have a mechanical indicator showing when the switch is in the OFF position, and the wiring must be connected to the switch without the use of a plug or socket outlet.
11. The switch must be accessible and clearly identifiable, but out of reach of a person using a fixed bath or shower tray/cubicle, except for the cord of a cord operated switch, and should be placed so that it is not possible to touch the switch body while standing in a bath or shower tray/cubicle. It should be readily accessible to switch off after use.
12. Where shower cubicles are located in any rooms other than bathrooms, all socket outlets in those rooms must be protected by a 30mA RCD.
13. The current carrying capacity of the cable must be at least that of the shower circuit protection (**Fig.2**). To obtain full advantage of the power provided by the shower, use the shortest cable route possible from the consumer unit to the Tri-HUB.
14. The electrical circuit to the Tri-HUB should be separated from other circuits by at least twice the diameter of the cable or conduit. The current rating will be reduced if the cabling is bunched with others, surrounded by thermal loft or wall insulation or placed in areas where the ambient temperature is above 30°C. Under these conditions, derating factors apply and it will be necessary to select a larger cable size (**Fig.2**). In the majority of installations, the cable will unavoidably be placed in one or more of the above conditions. This being so, it is strongly recommended to use a minimum of 10mm<sup>2</sup> cabling throughout the shower installation. In any event, it is essential that individual site conditions are assessed by a competent electrician in order to determine the correct cable size and permissible circuit length.

**Fig.4 Tri-HUB Wiring Diagram**

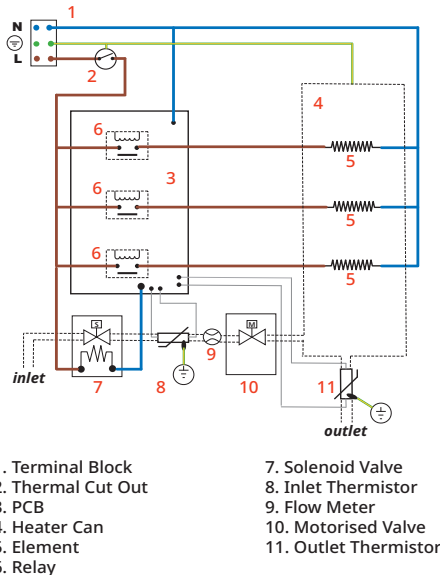

# TRI-HUB INSTALLATION

## POSITIONING THE Tri-HUB

The Tri-HUB may be installed in a loft space, in a convenient cupboard space, or the bathroom environment, provided there is access and enough room for maintenance and the ambient temperature is within the stated parameters listed on **Pg.6**. Always position the Tri-HUB in a dry area, but it must be well ventilated and not covered with towels, sheets, etc.

Ensure the Tri-HUB is installed in a position that will minimise the length of pipe runs to the shower head/accessory fittings. Triton recommend that the length of pipe should **NOT** exceed 3 metres, as the length of pipework will influence any losses in water temperature and response time when showering temperature settings on the ENVi® Controller are changed.

To avoid any significant flow losses, the pipework should be designed and installed such that bends or the use of elbows are minimised. The Tri-HUB should also be positioned so the flow is not significantly affected by other taps and appliances being operated elsewhere on the premises.

All pipework **MUST** be rigidly supported to avoid any strain on the connections and vibrations during use.

The Tri-HUB must always be mounted vertically on a even surface which covers the full width and length of the backplate. **DO NOT MOUNT IT HORIZONTALLY** as inbuilt sensors will not allow for the ENVi® shower to operate.

Allow enough room at the base of Tri-HUB to allow for plumbing fixings to be connected to the Inlet and Outlet stems.

The Tri-HUB must always be positioned so that there is easy access for servicing and maintenance.

If a suitable wall is not available for mounting, then a support structure similar to that in **Fig.5** should be manufactured and used.

## INSTALLING IN THE LOFT

If the Tri-HUB is being installed in a loft area, then the following requirements must be met for future servicing purposes:

- There must be no risk of the Tri-HUB, inlet water supply pipe or outlet heated water pipe becoming frozen.
- The Tri-HUB must not be covered with any form of insulating material that may give rise to electrical circuits overheating during periods of high ambient temperature.
- A safe means of access must be provided into the loft, e.g. via a fixed loft ladder.
- The Tri-HUB must be installed in an accessible and safe location.
- Ceiling joists must be adequately boarded to provide safe and unobstructed access to, from, and around the Tri-HUB.
- There must be adequate lighting in the loft for servicing purposes.

**Fig.5**

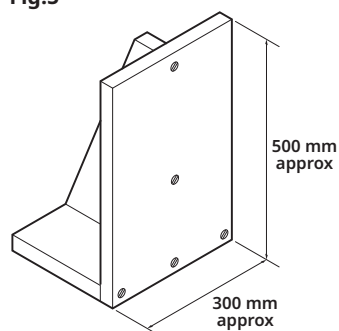

# TRI-HUB INSTALLATION

Step  
**1**

After choosing the appropriate location for the Tri-HUB, remove the front cover by loosening the 4 fixing screws.

**NOTE:** These screws are captive and cannot be completely removed from the cover.

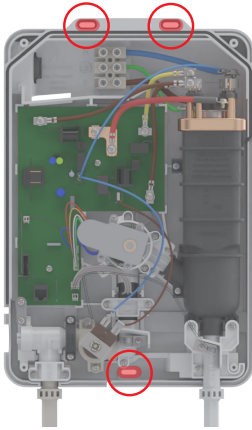

Fixing  
Screws

Step  
**2**

Position the Tri-HUB on the wall and using the backplate enclosure as a template, mark the fixing positions holes.

Drill and plug the holes in the wall.

Secure the Tri-HUB to the wall.

**IMPORTANT:** DO NOT use adhesives or any other substrate as a method of fixing the Tri-HUB to the wall.

Step  
**3**

Install all shower accessories as per the instructions that are supplied in the individual accessories pack.

Complete all the necessary plumbing pipework.

Ensure that any soldering of pipework is done away from the Tri-HUB as heat can travel along pipework and damage components.

**IMPORTANT:** Before connecting the Tri-HUB to the plumbing pipework, flush out the pipework for approximately 60 seconds to remove any swarf or debris.

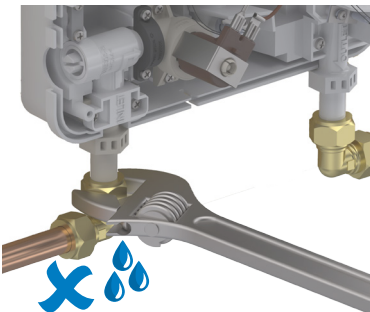

Step  
**4**

With the Tri-HUB mounted to the wall, connect the plumbing pipework.

Tighten all pipe connection fittings, but **DO NOT** overtighten.

Turn on the mains water supply and check the pipe work for leaks.

**NOTE:** At this stage of the installation no water can flow through the Tri-HUB.

# TRI-HUB INSTALLATION

Step  
**5**

Route the electricity supply cable in to the Tri-HUB through the cable entry grommet.

Insert the conductors into the appropriate position on the terminal block.

**NOTE: The Earth conductor must be sleeved. The outer sheath of any conductor must be stripped to a minimum.**

Fully tighten the terminal block screws and make sure that no cable insulation is trapped under the screws.

**IMPORTANT: Loose connections can result in cable overheating.**

**DO NOT SWITCH ON THE ELECTRICITY SUPPLY TO THE TRI-HUB.**

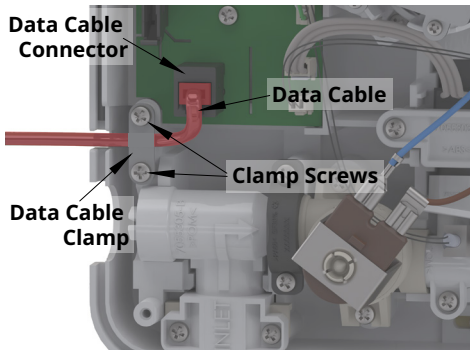
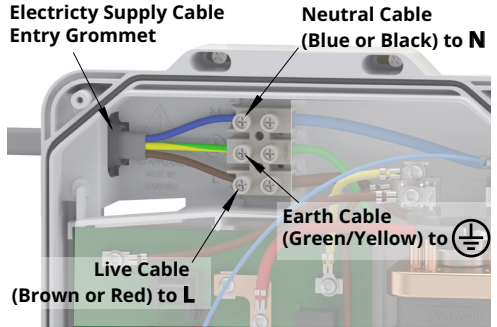

Step  
**6**

Connect one end of the data cable to the connector on the printed circuit board within the Tri-HUB.

Ensure that the cable is clamped using the Tri-HUB's internal data cable clamp and screws.

Step  
**7**

Insert the rechargeable button battery (supplied in the pack) into the battery holder on the printed circuit board, noting the correct orientation of the '+' terminal.

**NOTE: If the rechargeable battery is not installed correctly, the Commissioning procedure cannot be carried out and the Tri-HUB will be unable to monitor for freezing conditions.**

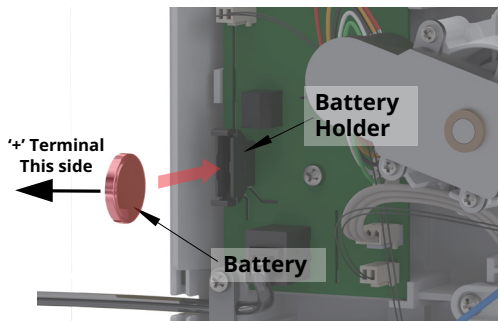

Step  
**8**

Re-fit the Tri-HUB front cover and secure in position by tightening the 4 fixing screws (see Step 1).

# ENVi® CONTROLLER INSTALLATION

The ENVi® Controller is connected to the Tri-HUB via the 10 metre data cable supplied, the distance between the Tri-HUB and Controller **MUST** be within this distance (including any allowance for the routing of the cable).

**IMPORTANT:** The ENVi® Controller has been designed to allow for installation within a bathroom environment. However, consideration should be given to the location, as water splashing onto the controller glass could trigger false activation during use.

**IMPORTANT:** The controller must be located whereby the user can start and stop the shower immediately.

## DATA CABLE INSTALLATION

**IMPORTANT: UNDER NO CIRCUMSTANCES SHOULD THE DATA CABLE BE EXTENDED OR SHORTENED, AS NOT ONLY WILL IT IMPAIR THE PERFORMANCE OF THE SHOWER, BUT IT WILL ALSO INVALIDATE THE GUARANTEE.**

The data cable is not supplied factory fitted and will need to be attached to the Tri-HUB and ENVi® controller during installation.

The installer **MUST** ensure appropriate care is taken to ensure the orientation features on the connector are correctly aligned during cable attachment (**step 3**). Damage to the pins will cause data connection issues and may render the unit inoperable.

A 30mm diameter hole needs to be made within the showering area to allow for the data cable connection.

Run the data cable from the Tri-HUB into the showering area. Make sure there is enough slack cable at the controller end for the removal of the Controller for future maintenance. Approximately 150mm protruding length should be sufficient.

If the data cable is being routed through wall cavities, chased into solid walls, or surface mounted, then appropriate trunking/conduit **MUST** be used. Data cables **MUST** be fitted in a way so that they can later be removed for maintenance or servicing.



Using the fixing bracket and a spirit level, locate the bracket in the desired location. Remember to consider your cable routing position and that clearance below the ENVi® Controller will be required for screwdriver access.

Hold the fixing bracket in position and mark the top and bottom screw fixing holes. Remove the fixing bracket from the wall then drill and plug the wall for the fixing positions.

**NOTE:** An appropriate drill bit should be used. If the wall is brick, plasterboard or a soft building block, appropriate wall plugs and screws should be fitted.

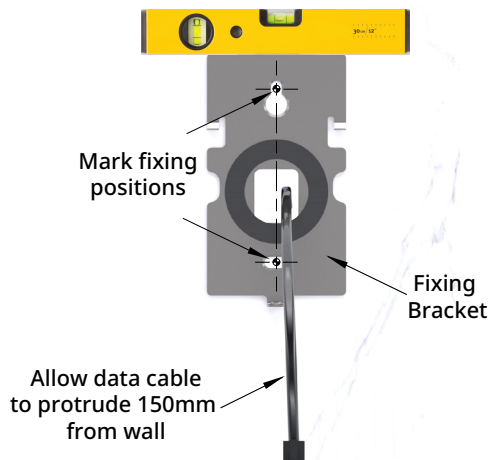



# ENVi® CONTROLLER INSTALLATION

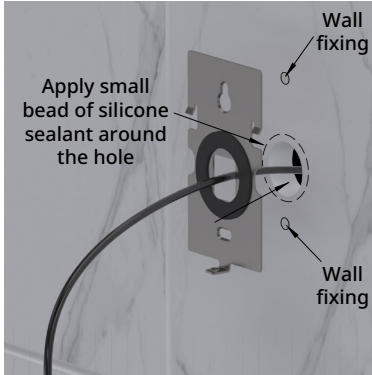

Step  
2

Apply a small bead of silicone sealant around the Ø30mm hole, to seal the bracket to the wall.

Secure the fixing bracket to the wall using the appropriate fixings.

Whilst securing the fixing bracket to the wall, the data cable must be pulled through so that approximately 150mm protrudes from the wall, this will help make the connection to the controller easier.

Step  
3

Connect the data cable connector socket from the ENVi® Controller to the data cable protruding from the fixing bracket.

**NOTE:** Care should be taken when connecting the cable so as not to damage the locking tab of the data cable connector.

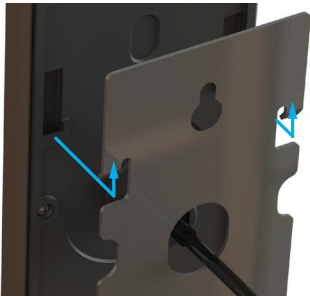

Step  
4

Push the excess data cable/data cable connector through the hole within the fixing bracket and back into the wall cavity.

Align the fixing lugs on the back of the ENVi® Controller with the fixing lugs on the fixing bracket, then offer the Controller up to the fixing bracket. Slide the ENVi® Controller upwards to engage the fixing lugs.

Step  
5

Insert and tighten the fixing screw in the bottom of the ENVi® Controller. **DO NOT** overtighten the screw.

**DO NOT** turn on the electricity supply to the Tri-HUB until you are ready to start commissioning.



# COMMISSIONING ENVi® SHOWER SYSTEM

Before using the ENVi® shower system, final checks and commissioning must be undertaken. Please follow the steps below.

**IMPORTANT:** It is recommended that during the commissioning procedure the outlet connections and plumbing are checked for any water leakage.

You may need help from an additional person to assist in this process.

Resolve any leaks or plumbing issues, and after fixing, repeat the commissioning process to be confident that the pipework and water connections do not have any water leakage.



The ENVi® shower system can be purchased with a variety of different shower kits and fixed head options, always ensure that any fixed head or shower head is removed for commissioning. Attach the appropriate end of the shower hose (if supplied) to the shower outlet using the supplied hose washer seal - **DO NOT** overtighten.

Position the other end of the shower hose to the bath or tray waste.



Ensure the electricity and water supplies to Tri-HUB are ON, and the Data Cable is connected to both the ENVi® Controller and Tri-HUB as described in the installation sections of this book. When the Start/Stop  icon is illuminated, touch it to wake the shower. The TRITON logo will appear briefly, this will then be replaced with the instructions to start the commissioning process.

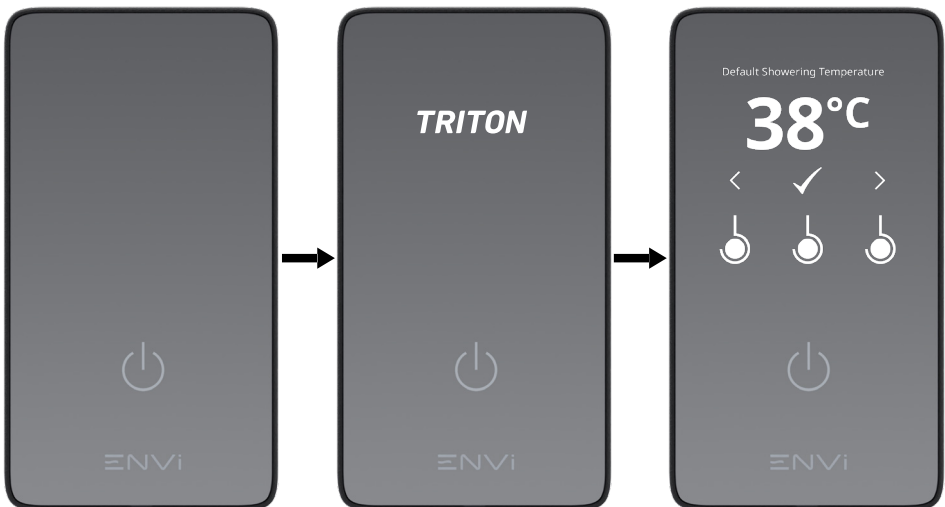

# COMMISSIONING ENVi® SHOWER SYSTEM

## Step 3

Set the 'Default Showering Temperature'.

This sets the target showering temperature when no user profile is selected whilst showering.

Touch the circular symbols under the left < and right > chevrons to set the desired temperature.

Touch the circular symbol under the tick ✓ to set the temperature.



## Step 4

Set the 'Default Showering Time'.

This sets the duration of the shower timer, after which the Tri-HUB will automatically enter phased shut down and go to standby.

Touch the circular symbols under the left < and right > chevrons to set the desired time, the time changes in 30 second intervals.

Touch the circular symbol under the tick ✓ to set the temperature.



## Step 5

Start the ENVi® shower system's automatic commissioning process.

Touch the circular symbol under the tick ✓ to start the commissioning. The back symbol ↶ will take you back to the Default Showering Temperature screen (Step 3).

The system will now prime with water and undertake an important routine to prepare the Tri-HUB for use. The display on the ENVi® controller will change to show the progress, it will take approximately 2 minutes to complete. The routine will restart automatically if it fails.

DO NOT prematurely terminate the commissioning process, the ENVi® controller will display a message when complete before reverting to 'Standby'.

**NOTE: Water will flow through the system during commissioning.**



# ENVi® SHOWER COMMISSIONING



Now Commissioning is complete, reattach any shower head and/or fixed head to the system using the hose washers supplied; DO NOT overtighten. Start the ENVi® shower system and check the shower head/fixed head connection for water leakage.

**The ENVi® shower system is now ready for operation.**

**Refer to ENVi® User Guide for details on use and customisation.**

# MAINTENANCE

## INSTRUCTIONS FOR INSTALLERS AND SERVICE ENGINEERS ONLY

### Inlet Filter Maintenance

It is recommended that the filter is periodically cleaned to maintain the performance of the Tri-HUB.

**Isolate the electricity and water supplies before commencing.**

Remove the front cover from Tri-HUB by untightening the screws in the 4 corners.

The inlet filter is located on the bottom LH side of the Tri-HUB and can be removed by either a flat bladed screw driver or adjustable spanner; remove by unscrewing anti-clockwise.

With the filter removed, inspect the O-ring for damage. Do not over tighten the filter cap on reassembly.

When cleaning the filter mesh, **DO NOT** use a sharp object as it will cause damage. It is preferable to use an old toothbrush or similar.

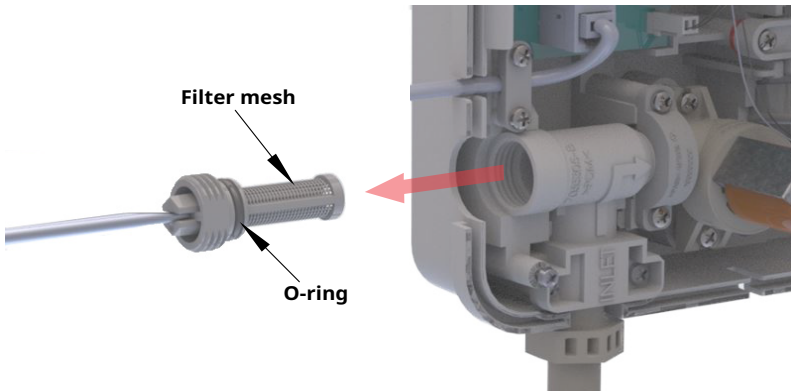

### Rechargeable Battery Cell Replacement

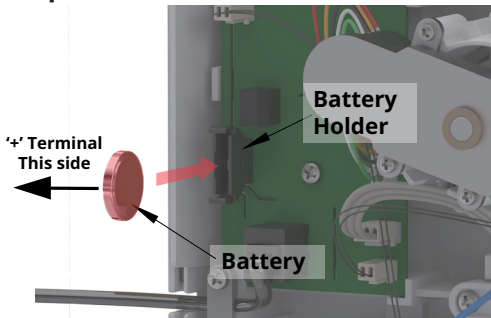

**Isolate the electricity supply before commencing.**

Remove the front cover from Tri-HUB by untightening the screws in the 4 corners.

Remove the existing rechargeable battery and replace with an LIR2032 3.6V or 3.7V **rechargeable** battery noting, the correct orientation of the '+' terminal.

**ONLY FIT RECHARGEABLE BATTERIES**

**NOTE:** If the rechargeable battery is not installed correctly, the Commissioning procedure cannot be carried out and the Tri-HUB will be unable to monitor for freezing conditions.

# MAINTENANCE

## Freezing Precaution

Installing the ENVi® Tri-HUB where it is possible to be subjected to freezing conditions could cause critical damage. The ENVi® Shower System periodically reads the ambient temperature of the air within the Tri-HUB and will display a two-stage warning if it has been subjected to cold conditions.



### Freezing Precaution Warning

If the Tri-HUB records an ambient air temperature of 3°C or below, the freezing precaution warning will be displayed in the top-right corner of the display whilst the shower is running. This icon will appear on subsequent showering sessions, even if the ambient temperature within the Tri-HUB has risen above the threshold temperature.

This warning can be reset by navigating to the Freezing Precaution sub-menu within the System Settings menu. Access the System Settings menus by touching the Start/Stop icon  for 3 seconds whilst the controller is in standby.

Select the 'Reset Lockout' menu option and touch the circular symbol under the tick  to confirm. The Freezing Precaution Warning icon will not be displayed during showering sessions unless the Tri-HUB records an ambient temperature which falls below the threshold again.

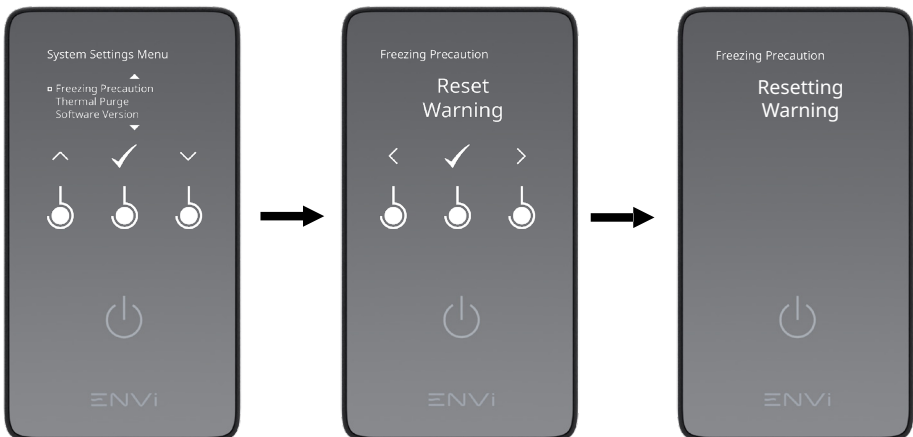

# MAINTENANCE

## Freezing Precaution Lockout

If the Tri-HUB records an ambient temperature of 1°C or below, the shower will be disabled. Touching the Start/Stop icon  whilst the controller is in standby will display the Freezing Precaution Error Code.

To remove this lockout, the Freezing Precaution procedure will need to be performed.

To access the Freezing Precaution procedure:

- Navigate to and select the 'Freezing Precaution' sub-menu within the System Settings menu.
- Navigate to the 'Remove Lockout' option by touching the circular symbols under the left < and right > chevrons and touch the circular symbol under the tick ✓ to confirm.
- The controller will ask 'Press Required Keys for Access' to commence the procedure. Touch the circular symbols (highlighted red) together that previously appeared under the left < and right > chevrons for five seconds.

**NOTE: These controls will not be illuminated whilst viewing this screen, but will still be able to be pressed.**

- Follow the on-screen instructions to complete the procedure. Water will be flowing during the Leak and Temperature tests. Beware of potential leaks or overheating.

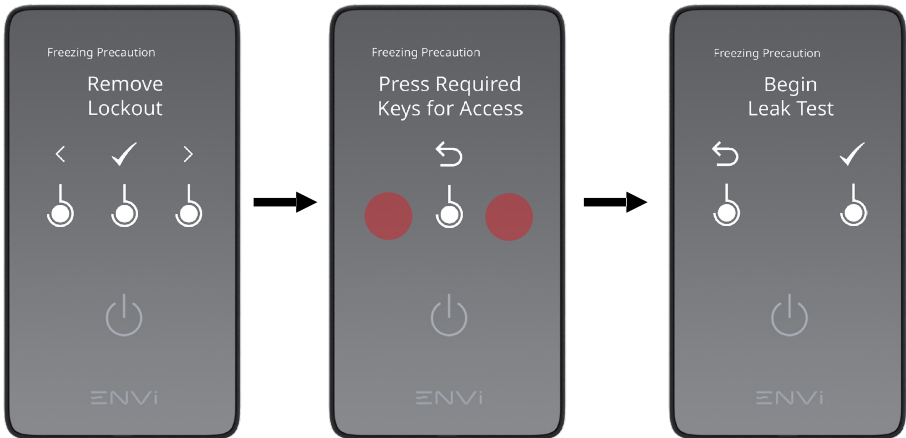



If the product passes the Freezing Precaution procedure, the lockout will be removed and the ENVi® shower system can be used as normal. If the product fails the Freezing Precaution procedure, please contact the Triton Customer Experience team for further assistance: 024 7637 2222

# MAINTENANCE

## Thermal Purge

ENVi® shower system has a built-in procedure to thermally cleanse the Tri-HUB and associated pipework in the shower system, which can be initiated if the system has not been used for an extended period of time and may have been subjected to stagnant water. This cleansing is achieved by running the shower at 55°C for an extended period of time.

To perform the thermal purge procedure, navigate to and select the 'Thermal Purge' setting within the System Settings main menu. Access the System Settings menus by touching the Start/Stop icon  for three seconds whilst the controller is in standby.

Then either touch the circular symbol under the tick  to commence the thermal purge routine, or the circular symbol under the back  to return to the System Settings menu.

**IMPORTANT: DO NOT stand under, or put your hand under, the flow of water from the shower outlet whilst thermal purge is running. The control panel will state when purging is complete and the shower is safe to use.**

The shower will heat the water to 55°C and run for three minutes. On completion, the shower will perform a phased shut down to restore the water temperature inside the shower to a safe level. The thermal purge routine can be stopped at any time by touching the Start/Stop icon , though only do this if the control panel is installed a safe distance away from the water flow.

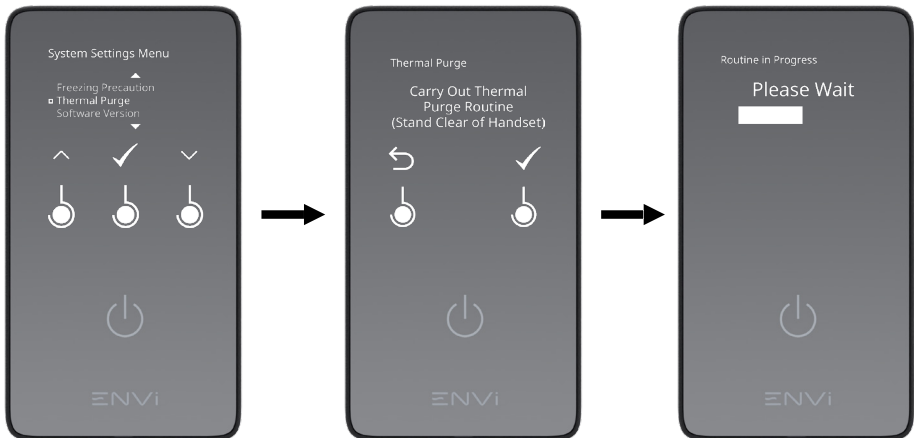



# ERROR CODES



The ENVi® shower system automatically checks the operation of the Tri-HUB. In the event that a fault is detected, an error message will be displayed on the ENVi® controller when attempting to start a showering session.

All error messages contain an error code and a QR code. Scanning this QR code with a compatible device (e.g. a smartphone) will link to the ENVi® Product Support page on the Triton website.

This page will provide guidance on what to do next when a particular error message is displayed.

Visit [tritonshowers.co.uk/envisupport](https://tritonshowers.co.uk/envisupport) or scan the **QR code** below for instant access to ENVi® Product Support.



# FAULT DIAGNOSTICS

**IMPORTANT: Isolate the electricity supply and remove the circuit fuse before attempting any fault finding inside the Tri-HUB.**

<b>Problem</b>	<b>Cause</b>	<b>Action</b>
<b>1</b> Shower inoperable, will not operate.	<b>1.1</b> Interrupted power supply.	<b>1.1.1</b> Blown fuse or circuit breaker. Check supply. Renew or reset fuse or circuit breaker. If it fails again, consult a qualified electrician. <b>1.1.2</b> Power cut? Check other appliances and if necessary, contact local Electricity Supply Co.
	<b>1.2</b> Thermal cut-out operated.	<b>1.2.1</b> The safety thermal cut-out device has operated. Have the ENVi® shower system checked. Contact Triton Customer Experience team.
	<b>1.3</b> RE002 (NTC) Error message.	<b>1.3.1</b> The Tri-HUB PCB has an NTC safety device which has operated. Wait until the shower temperature returns to normal and NTC resets.
	<b>1.4</b> RE003 (NTC) Error message.	<b>1.4.1</b> The Tri-HUB PCB has an NTC safety device which has operated 3 times. Have the ENVi® shower system checked. Contact Triton Customer Experience team.
	<b>1.5</b> CE001 Error message (Data connection between Tri-HUB and controller is lost).	<b>1.5.1</b> Check the data cable for damage and check connectors on each end of cable are correctly assembled or replace data cable between the controller and Tri-HUB.
	<b>1.6</b> FP001 Error message (Frost protection flag has been activated).	<b>1.6.1</b> The Tri-HUB has been exposed to potentially freezing conditions, the pipework needs to be checked. Contact Triton Customer Experience team.
	<b>1.7</b> LF001 Error message (Low Flow condition).	<b>1.7.1</b> Insufficient water flow to operate the Tri-HUB. <ul style="list-style-type: none"> <li>- Check water supply to the Tri-HUB.</li> <li>- Check that the shower hose's have been installed correctly onto the DuElec® diverter (if fitted).</li> <li>- Check shower head is not blocked.</li> <li>- Check shower hose is not restricted.</li> <li>- Check that the inlet filter is not blocked.</li> </ul>
	<b>1.8</b> Unit malfunction.	<b>1.8.1</b> Have the ENVi® shower system checked. Contact Triton Customer Experience team.
<b>2</b> Water too hot.	<b>2.1</b> Incorrect temperature set on the ENVi® controller.	<b>2.1.1</b> Adjust the temperature control to the preferred setting.
	<b>2.2</b> Unit malfunction.	<b>2.2.1</b> Have the ENVi® shower system checked. Contact Triton Customer Experience team.

# FAULT DIAGNOSTICS

Problem	Cause	Action
3 Water too cool or cold.	3.1 Incorrect temperature set on the ENVi® controller.	3.1.1 Adjust the temperature control to the preferred setting.
	3.2 Unit malfunction.	3.2.1 Have the ENVi® shower system checked. Contact Triton Customer Experience team.
4 Water will not stop flowing from unit unless switched off at isolating switch.	4.1 Unit malfunction.	4.1.1 Have the ENVi® shower system checked. Contact Triton Customer Experience team.
5 Shower varies from normal tempertaure to cold during use.	5.1 TH002 Error message (Over Temperature condition).	5.1.1 ENVi® shower system has detected high water temperature in the heater assembly and removed electricity to the elements. Wait until the water temperature drops and resets the sensors.
	5.2 LF001 Error message (Low Flow condition).	5.2.1 Insufficient water flow to operate the Tri-HUB. - Wait until water flow returns to normal. - Check shower head is not blocked. - Check shower hose is not restricted. - Check water supply to the Tri-HUB. - Check that the Inlet filter is not blocked.
	5.3 Unit malfunction.	5.3.1 Have the ENVi® shower system checked. Contact Triton Customer Experience team.

To purchase a genuine Triton spare part for your product, please visit **[www.tritonshowers.co.uk/spares](http://www.tritonshowers.co.uk/spares)** for product codes and prices. Alternatively please call our Customer Experience team on **024 7637 2222** to order direct. Please have your model name available.

## UK SERVICE POLICY

**In the event of a product fault or complaint occurring, the following procedure should be followed:**

### **DO NOT REMOVE THE PRODUCT**

1. Telephone Customer Experience on **024 7637 2222** having available your details including post code, the model number and power rating of the product, together with the date of purchase and, where applicable, details of the particular fault.
2. If required, the Customer Experience Advisor will arrange for a qualified engineer to call.
3. All products attended to by a Triton service engineer must be installed in full accordance with the Triton installation guide applicable to the product. Every product pack contains an installation guide, however, they can also be downloaded free at [www.tritonshowers.co.uk](http://www.tritonshowers.co.uk).
4. Our engineer will require local parking and if a permit is required, this must be available to the engineer on arrival at the call.
5. If loft access is required for isolation or to complete a repair, the loft must have a fixed access ladder and be boarded, with appropriate lighting from the access point to and around the repair area.
6. It is essential that you or an appointed representative, who must be over 18 years of age, is present for the duration of the service engineer's visit. If the product is in guarantee you must produce proof of purchase.
7. Where a call under the terms of guarantee has been booked and the failure is not product related (i.e. scaling and furring, incorrect water pressure, pressure relief device operation or electrical/plumbing installation fault) a charge will be made. A charge will also be issued if nobody is at the property when the service engineer calls or adequate parking/permit is not available.
8. If the product is no longer covered by the guarantee an up-front fixed fee will be charged before the site visit.
9. Your receipt must be retained as proof of purchase. Should proof of purchase not be available on an 'in-guarantee' call, or should the service engineer find that the product is no longer under guarantee, the engineer will charge the same fixed price and will request payment prior to departing. If payment is not made on the day an administration charge will be added to the fixed charge.
10. If a debt is outstanding from a previous visit, or from any other Triton purchase, Triton reserves the right to withhold service until the debt has been settled.
11. Triton takes the health, safety and wellbeing of its employees very seriously and expects customers to treat all staff members with respect. Should any employee feel threatened or receive abuse, either verbally or physically, Triton reserves the right to withhold service.

### **Replacement Parts Policy**

In line with AMDEA guidelines, Triton retains functional spares for as long as there is a market for them and in most cases, well beyond. Due to the vast array of product types, the life cycle of products can vary and therefore so can the length of time parts can be supplied. Spare parts can be ordered via our online spare parts store or by telephoning Triton Customer Experience team on **024 7637 2222**. Payment should be made by credit / debit card (excluding American Express or Diners Card). Payment can also be made by pre-payment of a pro-forma invoice, by cheque or postal order.

**Telephone orders are based on information given during the call. Before contacting Triton, please verify your requirements using the Triton website or your professional installer. Triton cannot accept liability for incorrect part identification.**

## TRITON UK STANDARD GUARANTEE

This guarantee applies only to products installed within the United Kingdom and does not apply to products used commercially. This guarantee does not affect your statutory rights.

With the exception of accessories, Triton guarantee the product against all manufacturing defects for a period of **2 years** (for domestic use only) from the date of purchase, provided that it has been installed by a competent person in full accordance with the fitting instructions.

All accessories such as shower heads, hoses and riser rails carry a **1 year** parts only guarantee against manufacturing defects.

Any part found to be defective during this guarantee period we undertake to repair or replace at our option without charge, so long as it has been properly maintained and operated in accordance with the operating instructions and has not been subject to misuse or damage. This product must not be taken apart, modified or repaired except by a person authorised by Triton.

### **What is not covered:**

1. Breakdown due to:
  - a) use other than domestic use by the property occupants;
  - b) wilful act or neglect;
  - c) any malfunction resulting from the incorrect use or quality of electricity, gas or water or incorrect setting of controls;
  - d) failure to install in accordance with this installation guide.
2. Claims for missing parts once the product has been installed.
3. Repair costs for damage caused by foreign objects or substances.
4. Total loss of the product due to non-availability of parts.
5. Compensation for loss of use of the product or consequential loss of any kind.
6. Call out charges due to an abortive visit or where no fault has been found with the appliance.
7. The cost of repair or replacement of isolating switches, electrical cable, fuses and/or circuit breakers or any other accessories installed at the same time. Replacement of a Pressure Relief Device that only activates when the shower outlet is blocked is also excluded.
8. The cost of routine maintenance, adjustments, overhaul modifications or loss or damage arising therefrom, including the cost of repairing damage, breakdown, malfunction caused by corrosion, furring, frost or exposure to freezing conditions.
9. Callout charges where the water supply cannot be isolated, this includes consequential losses arising from unserviceable supply valves, or inaccessible product or valves located in a loft space without suitable access.

**For the latest Terms & Conditions please see:**

**[www.tritonshowers.co.uk/terms](http://www.tritonshowers.co.uk/terms)**

PLEASE NOTE PRODUCT REGISTRATION IS ONLY AVAILABLE TO UNITS PURCHASED & INSTALLED IN THE UK

Triton Showers  
Triton Road  
Nuneaton  
Warwickshire, CV11 4NR

Triton is a division of Norcross Group (Holdings) Limited

Triton reserve the right to change product specification without prior notice. E&OE. © TRITON SHOWERS 2023

Customer Experience: **024 7637 2222**

Trade Installer Hotline: **024 7637 8344**

[www.tritonshowers.co.uk](http://www.tritonshowers.co.uk)

E-mail: [serviceenquiries@tritonshowers.co.uk](mailto:serviceenquiries@tritonshowers.co.uk)

E-mail: [technical@tritonshowers.co.uk](mailto:technical@tritonshowers.co.uk)