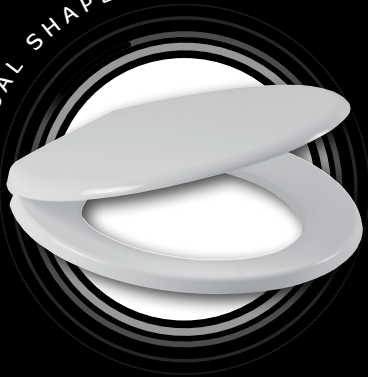


# TOILET SEATS

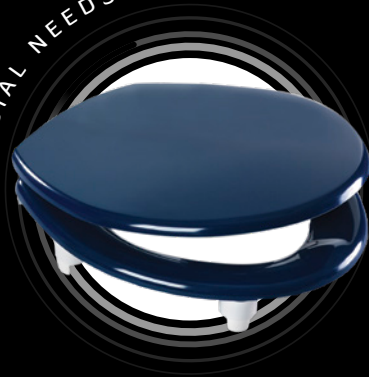
UNIVERSAL SHAPE



D SHAPE



SPECIAL NEEDS



**wirquin**

# HOW TO SELECT YOUR PERFECT WIRQUIN TOILET SEAT

## 1 - APPLICATION

	Application	Assets
THERMOSET		Hygienic: Naturally anti-bacterial Scratch, UV & chemical resistant Resilient: Extremely strong & durable
THERMOPLASTIC		Shatterproof 100% recyclable
MOULDWOOD		Heavy weight Gloss finish

## 2 - PAN SHAPE AND SIZE

### > IDENTIFY YOUR PAN SHAPE



Traditional

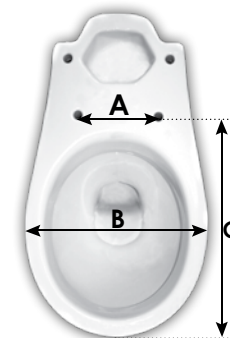


D-Shape



Bespoke

### > CHECK DIMENSIONS OF THE SEAT AND PAN



- A: Distance between the middle of the 2 holes in the pan
- B: Width of the pan
- C: Projection from the middle of the 2 holes up to the front of the pan.

## 3 - HINGE TYPE



BOTTOM FIX

Bottom fixing is a traditional type of fitting where the underside of the mounting holes are accessible to allow the tightening of the hinge fixings.



TOP FIX

Top fixing is required when there is a limited/no access to the underside of the hinge mounting holes (blind hole pans).



QUICK RELEASE

Quick release for easy removal of the seat without tools, enabling thorough cleaning for maximum hygiene



SOFT CLOSE

Soft close incorporating specialist dampers for a gentle, quiet closing action, offering added safety. No more trapped fingers.



LOCK PLUS

Lock + is a clever innovation that stops seat movement by filling the gap between the bolt and the pan.  
 Lock plus is included as standard with the Modufix range.

## PAN MATRIX

> DISCOVER OUR PAN MATRIX ON OUR WEBSITE



[www.wirquin.co.uk](http://www.wirquin.co.uk)

1. SELECT YOUR MANUFACTURER
2. SELECT YOUR SUITE
3. FIND YOUR MATCHING SEAT



Melody toilet seat with Ideal Standard (Sandringham 21)



GAP BETWEEN THE PAN AND BOLT LEADS TO A LOOSE SEAT



LOCK + FILLS THE GAP, PREVENTING MOVEMENT

► *easy to install*

► fits all pan types

► can be fitted & unfitted as many times as required

**STANDARD CLOSE RANGE**

Packed by 10's, individually shrink wrapped, cost effective options for contracts

NEON (20719017) Full details page 14
Toilet seat and sandwich cover Sold by 10's
INTERNATIONAL (20722783) Page 14
Toilet seat and sandwich cover Sold by 10's

**UNIVERSAL SHAPE**

Choice of hinges. Ideal for specifications

FLAMENCO (20120361)	FLAMENCO (20120362)	FLAMENCO (20120363)
Full details page 16		
Toilet seat and sandwich cover, bottom fix plastic hinge	Toilet seat and sandwich cover, bottom fix stainless steel hinge	Toilet seat and sandwich cover, top fix stainless steel hinge
MELODY (20120349)	MELODY (20120350)	MELODY (20120351)
Full details page 16		
Toilet seat and sandwich cover, bottom fix plastic hinge	Toilet seat and sandwich cover, bottom fix stainless steel hinge	Toilet seat and sandwich cover, top fix stainless steel hinge

**SOFT CLOSE RANGE**

Soft close and Top fix options using 304 grade stainless steel hinges

FUSION (20120354) Full details page 18	MADRIDIO (20120262) Full details page 21
Toilet seat and fully wrap over cover	Toilet seat and semi wrap over cover
VIP (20120357) Full details page 21	MAESTRO - D-SHAPE (20120360) Full details page 29
Toilet seat and sandwich cover	Toilet seat and semi wrap over cover

**modufix**<sup>®</sup>

> 5 HINGE POSSIBILITIES!

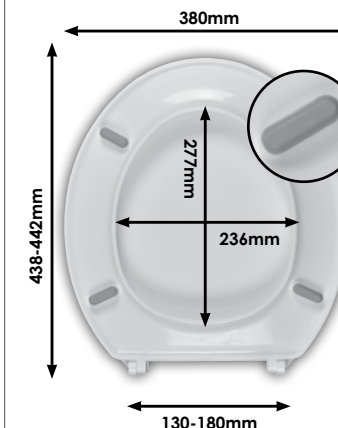
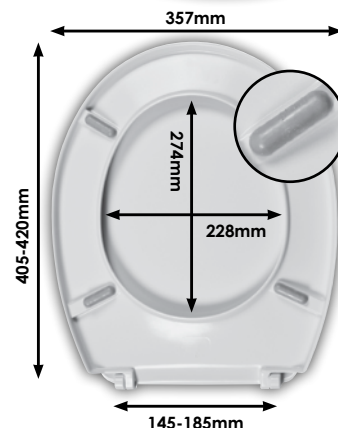
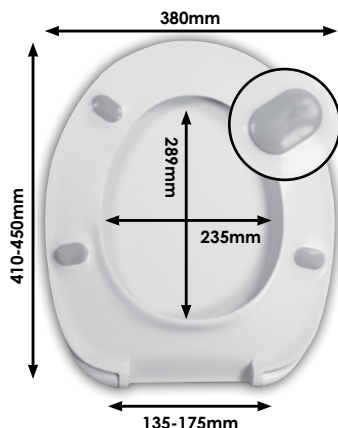


**UPGRADE  
your  
SALES**



**1 - CHOOSE YOUR SEAT**

Description	UNIVERSAL HD TS 1	UNIVERSAL MD TS 1	UNIVERSAL MD PP 1
Reference	20120338	20120339	20120347
EAN code			
Packaging	Individually boxed	Individually boxed	Individually boxed
Multiples / Pack	05 per outer / 90 per pallet	05 per outer / 90 per pallet	05 per outer / 90 per pallet
Weight	2,1 kg	1,3 kg	1,3 kg
Hinge Feature	Bottom	Bottom	Bottom
Hinge material	Plastic	Plastic	Plastic
Features and benefits	<ul style="list-style-type: none"> <li>Ideal for heavy duty use</li> <li>Includes a FOC plastic hinge</li> </ul>	<ul style="list-style-type: none"> <li>Ideal for medium duty use</li> <li>Includes a FOC plastic hinge</li> </ul>	<ul style="list-style-type: none"> <li>Ideal for medium duty use</li> <li>Includes a FOC plastic hinge</li> </ul>



**2 - CHOOSE YOUR HINGE**

**20120342**

- Soft close
- Quick release
- Top fix
- Adjustable
- Lock +

**20120343**

- Soft close
- Quick release
- Top fix
- Adjustable
- Lock +

**20120344**

- Top fix
- Adjustable
- 304 Stainless steel
- Lock +

**20120345**

- Bottom fix
- Adjustable
- 304 Stainless steel
- Lock +



# UNIVERSAL SHAPE

## TOILET SEATS



DESCRIPTION	WEIGHT (KG)	PAGE NUMBER
NEON	0,9	14
INTERNATIONAL	1,0	14
CALYPSO	1,3	15
FLAMENCO	1,3	16
MELODY	1,3	16
SAPPHIRE	1,3	17
FIRST	1,7	18
FUSION	1,7	18
EMERALD	1,8	19
TANGO	1,7	19
SAXON	1,6	20
MADRIDIO	2,1	21
VIP	2,3	21
SONATA	2,5	22 + 23
CAVALCADE	3,5	24
WOODY PARAMOUNT	2,7	25
WOODY	2,5	25
WOODY LUX	3,5	26

› OUR SEATS FIT MOST STANDARD PANS AND COME IN A CHOICE OF COVERS INCLUDING DISHED, DOMED OR FLAT DESIGNS.

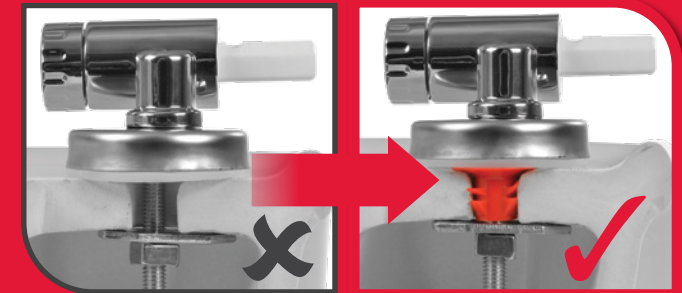
# LOCK<sup>+</sup>

▶ holds the seat in place!

- › SECURE YOUR SEAT
- › STOP SEAT MOVEMENT
- › INCREASE SEAT LIFESPAN



## STOP SEAT MOVEMENT



**BEFORE**



GAP BETWEEN THE PAN AND BOLT SEAT LEADS TO A LOOSE SEAT

**AFTER**

LOCK + FILLS THE GAP, PREVENTING MOVEMENT

**NOW AVAILABLE AS A SPARE**

Please note, you should refer to individual seat pages to consider if LOCK+ is compatible. LOCK+ is only compatible when specified and we do not guarantee the fit outside of the specifications.

DESCRIPTION	REFERENCE	MULTIPLE	APPLICATION
 Red LOCK+	<b>20120454</b>	15 pairs per bag	6mm Ø bolts
 White LOCK+	<b>20120455</b>	15 pairs per bag	8mm Ø bolts

**MODUFIX  
TOILET SEATS**


**UNIVERSAL SHAPE  
TOILET SEATS**

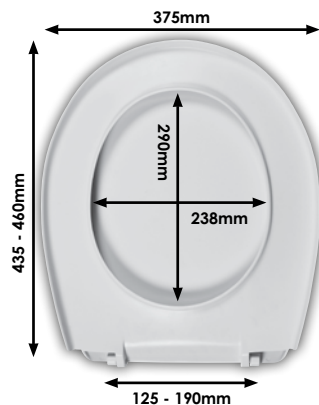
**D- SHAPE  
TOILET SEATS**

**SPECIAL NEEDS  
TOILET SEATS**

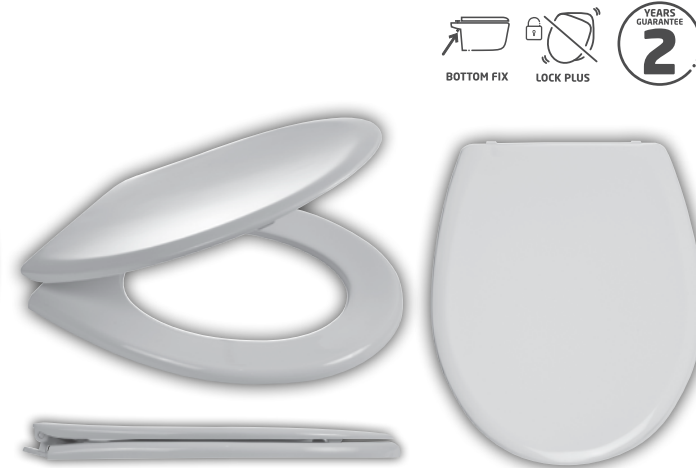
**SPARES & ACCESSORIES**

**SEAT NEON**

Description	<b>WHITE SEAT + COVER</b>	
Reference	<b>20719017</b>	
EAN code	5017134130911	
Packaging	Individually shrink wrapped and boxed by 10	
Multiples / Pack	10 per box / 180 per pallet	
Weight	0,9 kg	
Hinge Feature	Bottom Fix	
Hinge material	Plastic	
		
Features and benefits	<ul style="list-style-type: none"> <li>• Material: Thermoplastic</li> <li>• Shatterproof and 100% recyclable material</li> <li>• Lightweight: cost effective</li> </ul>	

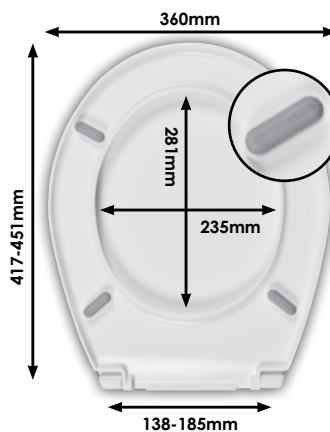


**DIAGRAM - 20719017**  
Full dimensional details per hinge p37



**SEAT INTERNATIONAL**

Description	WHITE SEAT + COVER		BLACK SEAT + COVER
Reference	<b>SNL11WH</b>	<b>20722783</b>	<b>SNL11BL</b>
EAN code	5017134116649	3375537226672	5017134117011
Packaging	Individually boxed	Individually shrink wrapped + boxed by 10	Individually boxed
Multiples / Pack	05/100	10/180	05/100
Weight	1,0 kg		
Hinge Feature	Bottom Fix		
Hinge material	Plastic		
			
Features and benefits	<ul style="list-style-type: none"> <li>• Material: Thermoplastic</li> <li>• Shatterproof and 100% recyclable material</li> <li>• Ideal for renovating work</li> </ul>		



**DIAGRAM - SNL11WH**  
Full dimensional details per hinge p37



SEAT

CALYPSO

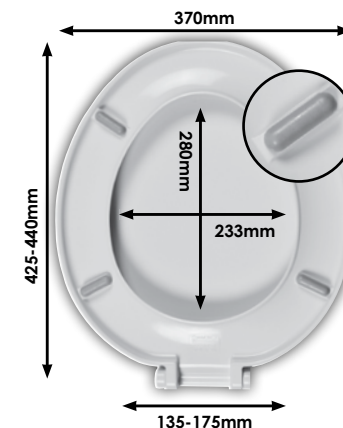


DIAGRAM - SCA11WH  
Full dimensional details  
per hinge p38

Description	WHITE SEAT + COVER		BLACK SEAT + COVER	WHITE SEAT ONLY
Reference	SCA11WH	SCA21WH	SCA21BL	SCA61WH
EAN code	5012158689414	5012158650537	5012158650261	5024139039064
Packaging	Individually boxed	Pack of 5		
Multiples / Pack	05 per outer / 100 per pallet		05 per box / 150 per pallet	
Weight	1,3 kg			
Hinge Feature	Bottom Fix			
Hinge material	White Plastic		Black Plastic	White Plastic
Features and benefits	<ul style="list-style-type: none"> <li>• Material: Thermoset</li> <li>• Resistant to scratches, UV and chemicals</li> <li>• Resilient: extremely strong, durable and hard wearing</li> <li>• Hygienic: made of naturally antibacterial material</li> <li>• Ideal for contract purposes for medium traffic areas</li> <li>• Colour matching Hinge material</li> </ul>			

**MODUFIX  
TOILET SEATS**




**UNIVERSAL SHAPE  
TOILET SEATS**

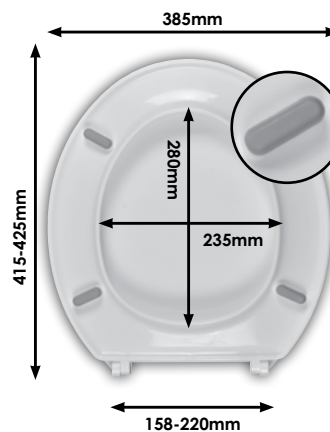
**D- SHAPE  
TOILET SEATS**

**SPECIAL NEEDS  
TOILET SEATS**

**SPARES & ACCESSORIES**

**SEAT FLAMENCO**




Description	WHITE SEAT + COVER		
Reference	20120361	20120362	20120363
EAN code	5017134133158	5017134133165	5017134133172
Packaging	Individually boxed		
Multiples / Pack	05 per outer / 100 per pallet		
Weight	1,3 kg		
Hinge Feature	Bottom Fix		Top Fix
Hinge material	Plastic	Stainless Steel	Stainless Steel
			
Features and benefits	<ul style="list-style-type: none"> <li>• Material: Thermoplastic</li> <li>• Shatterproof and 100% recyclable material</li> <li>• Plastic or stainless steel Hinge material available</li> </ul>		

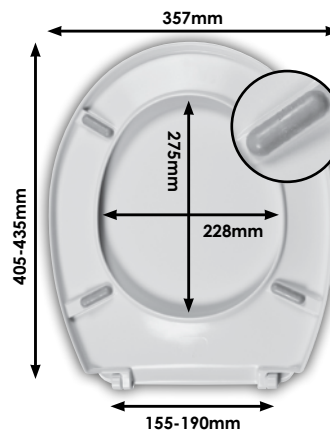


**DIAGRAM - 20120361**  
Full dimensional details per hinge p37



**SEAT MELODY**

Description	WHITE SEAT + COVER		
Reference	20120349	20120350	20120351
EAN code	5017134133035	5017134133042	5017134133059
Packaging	Individually boxed		
Multiples / Pack	05 per outer / 100 per pallet		
Weight	1,3 kg		
Hinge Feature	Bottom Fix		Top Fix
Hinge material	Plastic	Stainless Steel	Stainless Steel
			
Features and benefits	<ul style="list-style-type: none"> <li>• Material: Thermoset</li> <li>• Resistant to scratches, UV and chemicals</li> <li>• Resilient: extremely strong, durable and hard wearing</li> <li>• Hygienic: made of naturally antibacterial material</li> <li>• Ideal for contract purposes for medium traffic areas</li> <li>• Plastic or 304 stainless steel Hinge material available</li> </ul>		



**DIAGRAM - 20120349**  
Full dimensional details per hinge p38



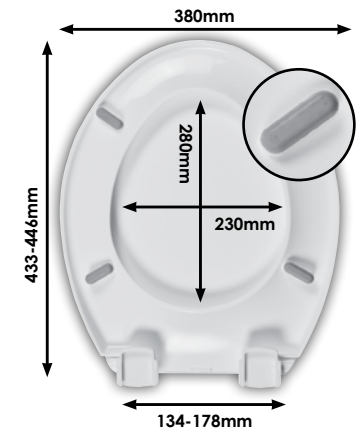


SEAT

SAPPHIRE



Description	WHITE SEAT + COVER	CHAMPAGNE SEAT + COVER
Reference	SSP11WH	SSP11CH
EAN code	5017134106763	5017134106657
Packaging	Individually boxed	
Multiples / Pack	05 per outer / 100 per pallet	
Weight	1,3kg	
Hinge Feature	Bottom Fix	
Hinge material	Pre assembled	
Features and benefits	<ul style="list-style-type: none"> <li>• Material: Thermoplastic</li> <li>• Shatterproof and 100% recyclable material</li> <li>• Supplied pre-assembled with adjustable plastic Hinge material</li> </ul>	



**DIAGRAM - SSP11WH**  
Full dimensional details  
per hinge p37

**MODUFIX  
TOILET SEATS**

**UNIVERSAL SHAPE  
TOILET SEATS**

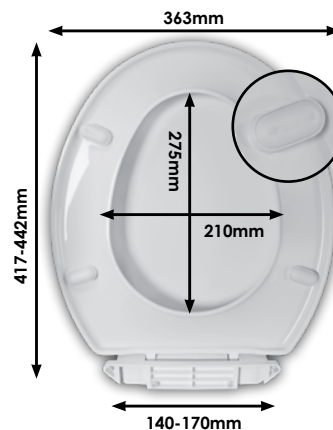
**D- SHAPE  
TOILET SEATS**

**SPECIAL NEEDS  
TOILET SEATS**

**SPARES & ACCESSORIES**

**SEAT FIRST**

Description	<b>WHITE SEAT + COVER</b>
Reference	<b>20718747</b>
EAN code	3375537186945
Packaging	Individually boxed
Multiples / Pack	06 per outer / 108 per pallet
Weight	1,7 kg
Hinge Feature	Bottom Fix, Soft Close
Hinge material	Pre assembled
Features and benefits	<ul style="list-style-type: none"> <li>• Material: Thermoplastic</li> <li>• Shatterproof and 100% recyclable material</li> <li>• Successfully tested to 10,000 opening/closing cycles</li> </ul>

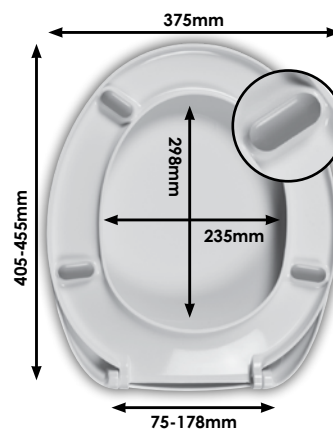


**DIAGRAM - 20718747**  
Full dimensional details per hinge p37

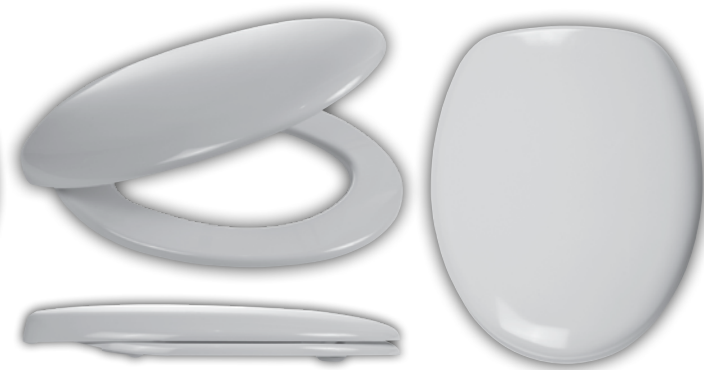


**SEAT FUSION**





Description	<b>WHITE SEAT + COVER</b>
Reference	<b>20120354</b>
EAN code	5017134133080
Packaging	Individually boxed
Multiples / Pack	05 per outer / 100 per pallet
Weight	1,7 kg
Hinge Feature	Top Fix, Soft Close
Hinge material	Stainless Steel
Features and benefits	<ul style="list-style-type: none"> <li>• Material: Thermoset</li> <li>• Resilient: extremely strong, durable and hard wearing</li> <li>• Resistant to scratches, UV and chemicals</li> <li>• Hygienic: made of naturally antibacterial material</li> <li>• Ideal for contract purposes for medium to high traffic areas</li> </ul>



**DIAGRAM - 20120354**  
Full dimensional details per hinge p38



SEAT **EMERALD**

Description	WHITE SEAT + COVER		BLACK SEAT + COVER	
Reference	SEM11WH	SEM18WH	SEM11BL	SEM18BL
EAN code	5017134106527	5017134116212	5017134106428	5017134116236
Packaging	Individually boxed			
Multiples / Pack	05 per outer / 100 per pallet			
Weight	1,8 kg			
Hinge Feature	Bottom Fix	Top Fix	Bottom Fix	Top Fix
Hinge material	WHITE - Pre assembled	CHROME - Pre assembled	Stainless Steel	CHROME - Pre assembled
				
Features and benefits	<ul style="list-style-type: none"> <li>• Material: Thermoplastic</li> <li>• Shatterproof and 100% recyclable material</li> <li>• Set British Standard 1254 Type 2</li> <li>• Ideal for specification</li> </ul>			

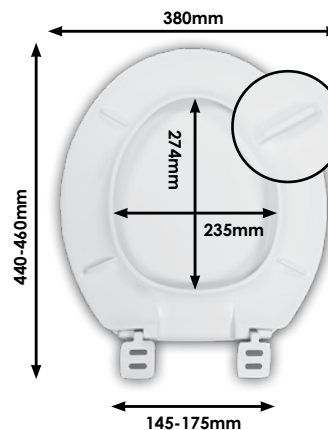


DIAGRAM - SEM11WH  
Full dimensional details  
per hinge p37



SEAT **TANGO**

Description	WHITE SEAT + COVER
Reference	STG11WH
EAN code	5012158689681
Packaging	Individually boxed
Multiples / Pack	06 per outer / 72 per pallet
Weight	1,7 kg
Hinge Feature	Top Fix, Soft Close, Quick Release
Hinge material	Pre assembled
Features and benefits	<ul style="list-style-type: none"> <li>• Material: Thermoplastic</li> <li>• Shatterproof and 100% recyclable material</li> <li>• Easy to remove for easier cleaning</li> <li>• Ideal for blind holes pans</li> <li>• No more noise, no fingers trapped: Soft close</li> </ul>

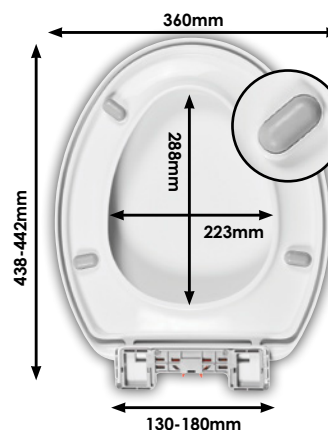


DIAGRAM - STG11WH  
Full dimensional details  
per hinge p37



SEAT **SAXON**

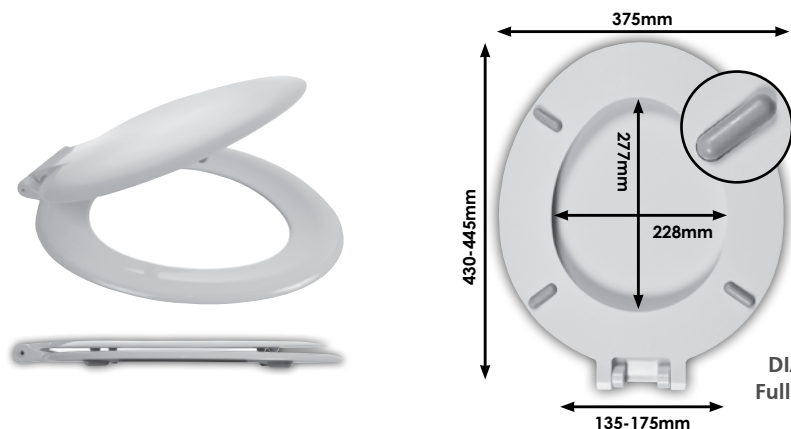


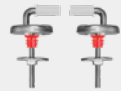

DIAGRAM - SSA11WH  
Full dimensional details  
per hinge p38



Description	WHITE SEAT + COVER			BLACK SEAT + COVER		BLACK SEAT ONLY
Reference	<b>SSA11WH</b>	<b>SSA12WH</b>	<b>SSA21WH</b>	<b>SSA11BL</b>	<b>SSA21BL</b>	<b>SSA61BL</b>
EAN code	5012158653866	5012158669324	5012158030230	5012158655785	5012158030131	5017134130393
Packaging	Individually boxed		Pack of 5	Individually boxed	Pack of 5	Pack of 5
Multiples / Pack	05 per outer / 100 per pallet		05 per box / 150 per pallet	05 per outer / 100 per pallet	05 per box / 150 per pallet	05 per box / 150 per pallet
Weight	1,7 kg					
Hinge Feature	Bottom Fix					
Hinge material	Plastic	Non Cranked Stainless Steel	Plastic	Plastic		Plastic
Features and benefits	<ul style="list-style-type: none"> <li>• Material: Thermoset</li> <li>• Resistant to scratches, UV and chemicals</li> <li>• Resilient: extremely strong, durable and hard wearing</li> <li>• Hygienic: made of naturally antibacterial material</li> <li>• Ideal for contract purposes for medium to high traffic areas</li> <li>• Plastic or 304 stainless steel Hinge material available</li> </ul>					



SEAT MADRIDIO

Description	WHITE SEAT + COVER	
Reference	SMB1TWH	20120262
EAN code	5055294430229	5017134132601
Packaging	Individually boxed	
Multiples / Pack	05 per outer / 100 per pallet	
Weight	2,1 kg	
Hinge Feature	Top Fix	Top Fix, Soft Close
Hinge material	Stainless Steel	
		
Features and benefits	<ul style="list-style-type: none"> <li>• Material: Thermoset</li> <li>• Resilient: extremely strong, durable and hard wearing</li> <li>• Resistant to scratches, UV and chemicals</li> <li>• Hygienic: made of naturally antibacterial material</li> <li>• Plastic or 304 stainless steel Hinge material available</li> </ul>	

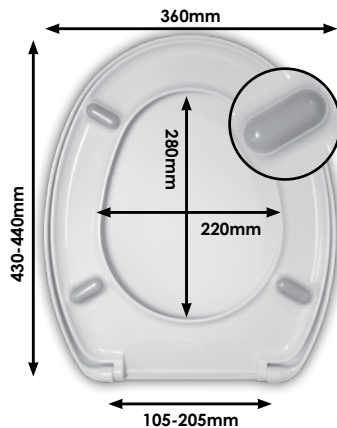
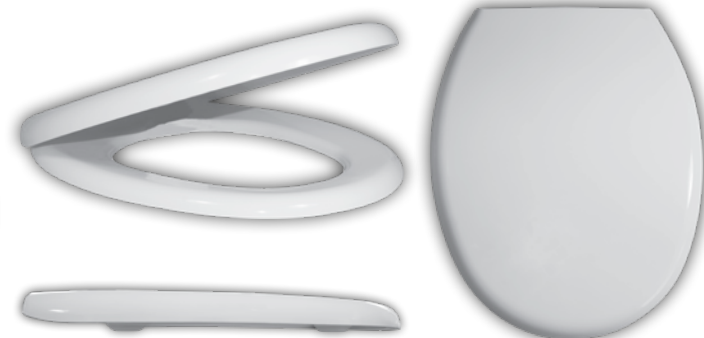




DIAGRAM - SMB1TWH  
Full dimensional details  
per hinge p38



SEAT VIP

Description	WHITE SEAT + COVER	
Reference	20120356	20120357
EAN code	5017134133103	5017134133110
Packaging	Individually boxed	
Multiples / Pack	05 per outer / 100 per pallet	
Weight	2,3 kg	
Hinge Feature	Top Fix	Top Fix, Soft Close
Hinge material	Stainless Steel	
		
Features and benefits	<ul style="list-style-type: none"> <li>• Material: Thermoset</li> <li>• Resistant to scratches, UV and chemicals</li> <li>• Resilient: extremely strong, durable and hard wearing</li> <li>• Hygienic: made of naturally antibacterial material</li> <li>• Plastic or 304 stainless steel Hinge material available</li> </ul>	

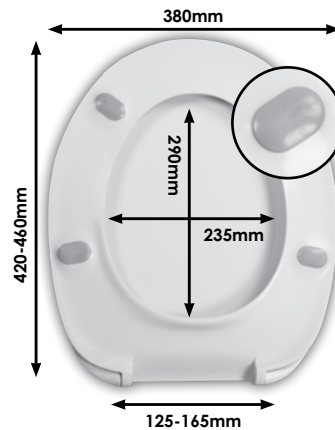


DIAGRAM - 20120356  
Full dimensional details  
per hinge p38



**SEAT SONATA (SEAT + COVER) SET BRITISH STANDARD - BS1254 "TYPE 1"**




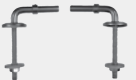





DIAGRAM:  
Plastic Hinge only.  
Full dimensional details  
per hinge p38.

Description	WHITE SEAT + COVER					BLACK SEAT + COVER			
	SSO11WH	SSO12WH	SSO15WH	SSO17WH	SSO21WH	SSO11BL	SSO12BL	SSO15BL	SSO21BL
Reference	SSO11WH	SSO12WH	SSO15WH	SSO17WH	SSO21WH	SSO11BL	SSO12BL	SSO15BL	SSO21BL
EAN code	5012158010232	5012158669409	5012158672119	5012158689353	5024139038968	5012158653484	5012158669362	5017134132212	5012158010133
Packaging	Individually boxed				Pack of 5	Individually boxed			Pack of 5
Multiples / Pack	05 per outer / 100 per pallet				05 per box / 120 per pallet	05 per outer / 100 per pallet			05 per box / 120 per pallet
Weight	2,5 kg								
Hinge Feature	Bottom Fix		Top Fix	Bottom Fix		Bottom Fix		Top Fix	Bottom Fix
Hinge material	Plastic	Non Cranked Stainless Steel	Stainless Steel	Stainless Steel	Plastic	Plastic	Non Cranked Stainless Steel	Stainless Steel	Plastic
Features and benefits	<ul style="list-style-type: none"> <li>• Material: Thermoset</li> <li>• Resilient: extremely strong, durable and hard wearing</li> <li>• Resistant to scratches, UV and chemicals</li> <li>• Hygienic: made of naturally antibacterial material</li> <li>• Ideal for contract purposes for high traffic areas</li> <li>• Plastic or 304 stainless steel Hinge material available</li> </ul>								

SEAT

SONATA (SEAT ONLY) SET BRITISH STANDARD - BSI254 "TYPE 1"



Description	WHITE SEAT ONLY				BLACK SEAT ONLY		
	Reference	SSO53WH	SSO55WH	SSO65WH	SSO51BL	SSO53BL	SSO55BL
EAN code	5012158667122	5012158669416	5012158672119	5024139039088	5012158666828	5012158669379	5012158669379
Packaging	Individually boxed			Box of 6	Individually boxed		
Multiples / Pack	07 per outer / 140 per pallet		07 per outer / 140 per pallet	06 per box / 180 per pallet	07 per outer / 140 per pallet		
Weight	1,5 kg						
Hinge Feature	Bottom Fix		Top Fix	Top Fix	Bottom Fix		Top Fix
Hinge material	Plastic	Non Cranked Stainless Steel	Stainless Steel	Stainless Steel	Plastic	Non Cranked Stainless Steel	Stainless Steel
							
Features and benefits	<ul style="list-style-type: none"> <li>• Material: Thermoset</li> <li>• Resilient: extremely strong, durable and hard wearing</li> <li>• Resistant to scratches, UV and chemicals</li> <li>• Hygienic: made of naturally antibacterial material</li> <li>• Ideal for contract purposes for high traffic areas</li> <li>• Plastic or 304 stainless steel Hinge material available</li> </ul>						

## SEAT CAVALCADE

Description	WHITE SEAT + COVER
Reference	SCL11WH
EAN code	5024139031853
Packaging	Individually boxed
Multiples / Pack	01 / 03 / 60
Weight	3,5 kg
Hinge Feature	Bottom Fix
Hinge material	Pre assembled
Features and benefits	<ul style="list-style-type: none"> <li>• Material: Mouldwood</li> <li>• Longlasting material</li> <li>• Chrome plated bar hinge</li> <li>• Ideal for traditional pans</li> </ul>

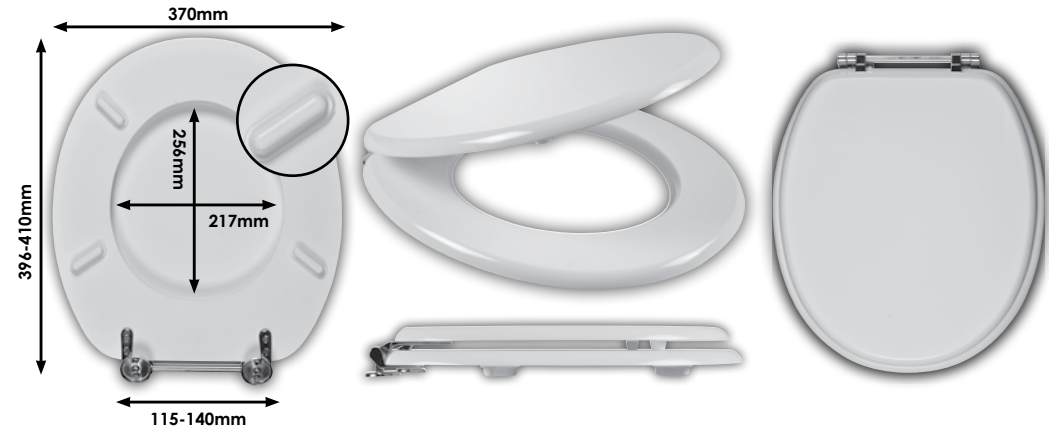
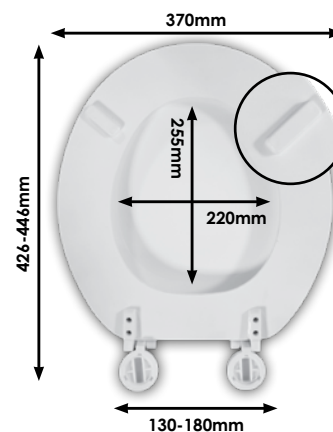


DIAGRAM - SCL11WH  
Full dimensionals details  
per hinge p39



**SEAT** **WOODY PARAMOUNT**

Description	<b>WHITE SEAT + COVER</b>
Reference	<b>21230001</b>
EAN code	3375539049736
Packaging	Individually boxed
Multiples / Pack	01 / 04 / 64
Weight	2,7 kg
Hinge Feature	Bottom Fix
Hinge material	Pre assembled
Features and benefits	<ul style="list-style-type: none"> <li>• Material: Mouldwood</li> <li>• Longlasting material</li> <li>• Successfully tested to 20,000 opening/closing cycles</li> <li>• Matching colour plastic Hinge material</li> </ul>

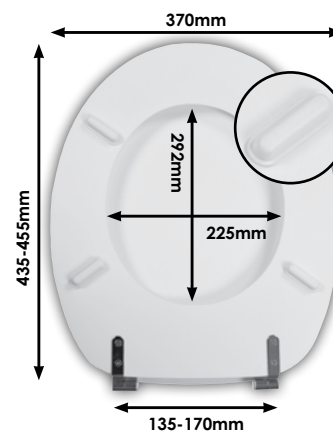


**DIAGRAM - 21230001**  
Full dimensionals details  
per hinge p39



**SEAT** **WOODY**

Description	<b>WHITE SEAT + COVER</b>
Reference	<b>21230004</b>
EAN code	3375537127320
Packaging	Individually boxed
Multiples / Pack	01 / 03 / 60
Weight	2,5 kg
Hinge Feature	Bottom Fix
Hinge material	Pre assembled
Features and benefits	<ul style="list-style-type: none"> <li>• Material: Mouldwood</li> <li>• Longlasting material</li> <li>• Successfully tested to 20,000 opening/closing cycles</li> <li>• 304 stainless steel Hinge material</li> </ul>

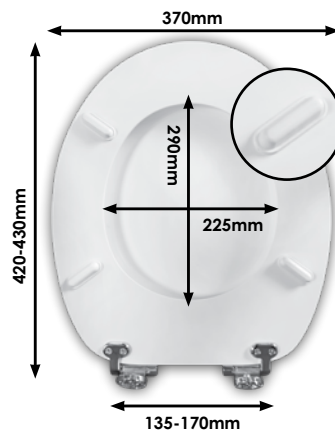


**DIAGRAM - 21230004**  
Full dimensionals details  
per hinge p39



**SEAT** **WOODY LUX**

Description	<b>WHITE SEAT + COVER</b>
Reference	<b>20719569</b>
EAN code	3375537194971
Packaging	Individually boxed
Multiples / Pack	01 / 03 / 60
Weight	3,5 kg
Hinge Feature	Bottom FIX, Soft Close
Hinge material	Pre assembled
Features and benefits	<ul style="list-style-type: none"> <li>• Material: Mouldwood</li> <li>• High strenght compressed wood with a white glossy paint finish</li> <li>• Successfully tested to 20,000 opening/closing cycles</li> <li>• Chrome plated soft close Hinge material</li> </ul>



**DIAGRAM - 20719569**  
Full dimensionals details  
per hinge p39



# D SHAPE

## TOILET SEATS



DESCRIPTION	WEIGHT (KG)	PAGE NUMBER
DISCO	2,1	28
AMIRAL	2,1	28
MAESTRO	2,3	29



› TO MATCH THE INCREASING NUMBER OF FRAMES AND WALL HUNG PANS IN MODERN BATHROOMS



**MODUFIX  
TOILET SEATS**

**UNIVERSAL SHAPE  
TOILET SEATS**

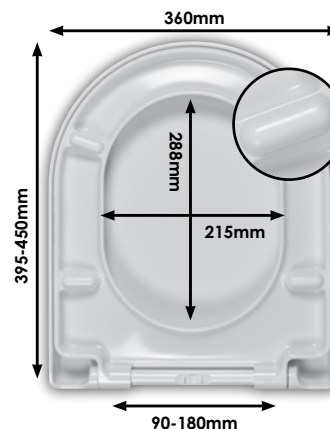
**D SHAPE  
TOILET SEATS**

**SPECIAL NEEDS  
TOILET SEATS**

**SPARES & ACCESSORIES**

**SEAT DISCO**

Description	<b>WHITE SEAT + COVER</b>
Reference	<b>20721512</b>
EAN code	3375537659340
Packaging	Individually boxed
Multiples / Pack	01 / 04 / 96
Weight	2,5 kg
Hinge Feature	Top Fix, Soft Close, Quick Release
Hinge material	Pre assembled
Features and benefits	<ul style="list-style-type: none"> <li>• Material: Thermoset</li> <li>• Resilient: extremely strong, durable and hard wearing</li> <li>• Fully wrap over with square edges D-Shape</li> <li>• Resistant to scratches, UV and chemicals</li> <li>• Hygienic: made of naturally antibacterial material</li> <li>• Ideal for blind hole pans</li> </ul>

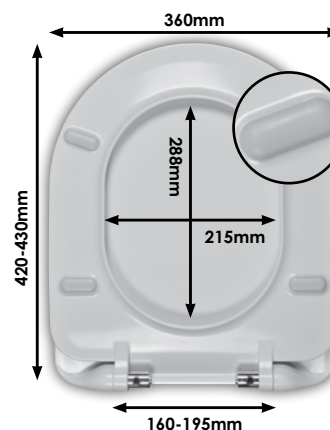


**DIAGRAM - 20721512**  
Full dimensional details per hinge p39



**SEAT AMIRAL**

Description	<b>WHITE SEAT + COVER</b>
Reference	<b>20721280</b>
EAN code	3375537212095
Packaging	Individually boxed
Multiples / Pack	01 / 04 / 96
Weight	2,1 kg
Hinge Feature	Top Fix, Soft Close, Quick Release
Hinge material	Pre assembled
Features and benefits	<ul style="list-style-type: none"> <li>• Material: Thermoset</li> <li>• Slim contemporary Design</li> <li>• Resilient: extremely strong, durable and hard wearing</li> <li>• Resistant to scratches, UV and chemicals</li> <li>• Hygienic: made of naturally antibacterial material</li> <li>• Ideal for blind hole pans</li> </ul>






**DIAGRAM - 20721280**  
Full dimensional details per hinge p39





SEAT **MAESTRO**

Description	WHITE SEAT + COVER		
Reference	20120358	20120359	20120360
EAN code	5017134133127	5017134133134	5017134133141
Packaging	Individually boxed		
Multiples / Pack	05 per outer / 100 per pallet		
Weight	2,3 kg		
Hinge Feature	Bottom Fix	Top Fix	Top Fix, Soft Close, Quick Release
Hinge material	Stainless Steel	Stainless Steel	Stainless Steel
			
Features and benefits	<ul style="list-style-type: none"> <li>• Material: Thermoset</li> <li>• Resilient: extremely strong, durable and hard wearing</li> <li>• Semi Wrap over design</li> <li>• Resistant to scratches, UV and chemicals</li> <li>• Hygienic: made of naturally antibacterial material</li> <li>• Ideal for blind hole pans with the top fix option</li> </ul>		

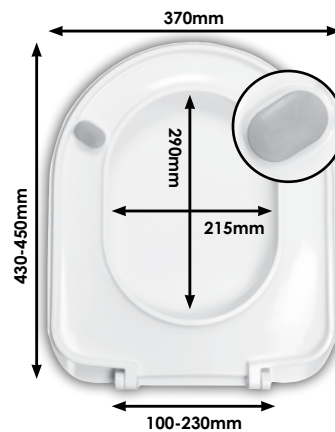
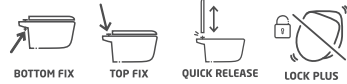


DIAGRAM - 20120358  
Full dimensional details  
per hinge p39



# SPECIAL NEEDS

## TOILET SEATS



DESCRIPTION	WEIGHT (KG)	PAGE NUMBER
CELESTE PRO	2,3	31
CELESTE PLUS	2,3	32
CRESCENT ADULT	2,7	34
CRESCENT JUNIOR	1,0	35

› ASTHETICALLY PLEASING SEATS WITH YOUR NEEDS IN MIND



### Did you know?

› **BLUE** TOILET SEATS HELP TO REMIND PEOPLE WITH COGNITIVE LOSS WHAT THE PURPOSE OF THE TOILET / BATHROOM IS AND ALSO WHERE IT IS LOCATED. THIS CAN HELP TO REDUCE CONFUSION AND DISTRESS WHEN VISITING THE TOILET.



SEAT CELESTE PRO



Description	WHITE SEAT AND COVER WITH C/P TOP FIX HINGE AND RAISED LOCATING BUFFERS	BLUE SEAT AND COVER WITH C/P TOP FIX HINGE AND RAISED LOCATING BUFFERS	WHITE SEAT ONLY WITH C/P TOP FIX HINGE AND RAISED LOCATING BUFFERS	BLUE SEAT ONLY WITH C/P TOP FIX HINGE AND RAISED LOCATING BUFFERS
Reference	SCI11WY	SCI11IB	SCI51WY	SCI51IB
EAN code	5024139038753	5024139038746	5024139038777	5024139038760
Packaging	Individually boxed			
Multiples / Pack	04 per outer / 80 per pallet		05 per outer / 100 per pallet	
Weight	2,2kg			
Hinge Feature	Top Fix			
Hinge material	Solid brass adjustable hinge, Stainless steel fittings			

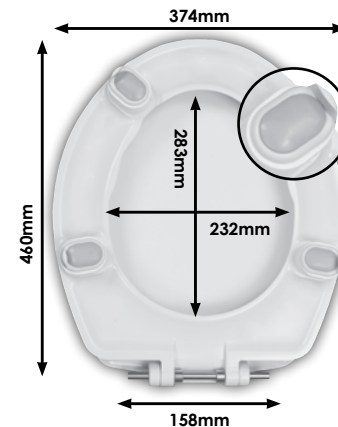


DIAGRAM - SCI11WY  
Full dimensional details  
per hinge p39



Features and benefits

- Material: Thermoset
- Hygienic: made of naturally antibacterial material
- Resistant to scratches, UV and chemicals
- Ergonomical seat for maximum comfort when sitting for a long time
- Adjustable locating buffers ideal for hospitals and care homes



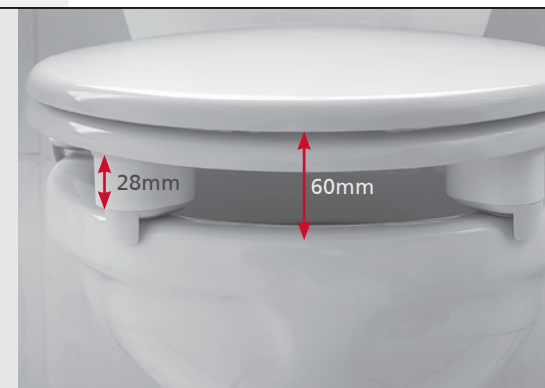
- 4 buffers on the seat including 2 locating buffers for more stability
- 2 buffers on the cover
- Increased height (28mm)



SMART

FOR ELDERLEY

- Adjustable and increased height of (28mm) on additional buffers makes this seat ideal for elderly without having to change the existing pan.
- Ideal for hospitals, care homes and the elderly.



SEAT CELESTE PLUS

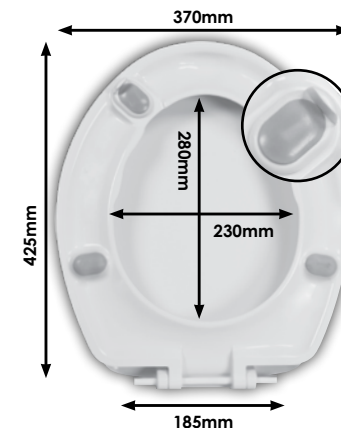
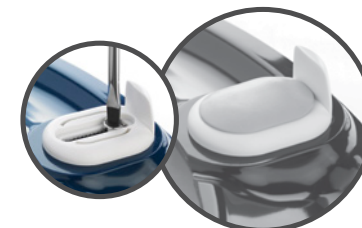
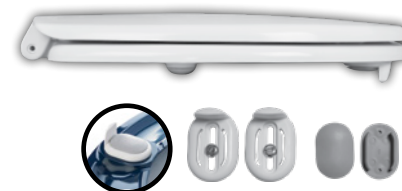



DIAGRAM - SCK11WY  
Full dimensional details  
per hinge p39

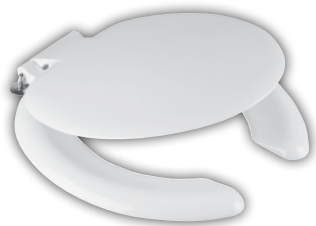


- 4 buffers on the seat including 2 locating buffers for more stability
- 2 buffers on the cover

Description	WHITE SEAT AND COVER WITH C/P TOP FIX HINGE AND LOCATING BUFFERS	BLUE SEAT AND COVER WITH C/P TOP FIX HINGE AND LOCATING BUFFERS	WHITE SEAT ONLY WITH C/P TOP FIX HINGE AND LOCATING BUFFERS	BLUE SEAT ONLY WITH C/P TOP FIX HINGE AND LOCATING BUFFERS
Reference	SCK11WY	SCK11IB	SCK51WY	SCK51IB
EAN code	5024139036834	5024139037152	5024139037398	5024139039309
Packaging	Individually boxed			
Multiples / Pack	04 per outer / 80 per pallet		05 per outer / 100 per pallet	
Weight	2,2kg			
Hinge Feature	Top Fix			
Hinge material	Solid brass adjustable hinge, Stainless steel fittings			
				
Features and benefits	<ul style="list-style-type: none"> <li>• Naturally antibacterial thermoset material</li> <li>• Resilient: adjustable locating buffers to hold the seat on the pan when sliding from the wheelchair onto the pan</li> <li>• Resistant to scratches, uv and chemicals</li> <li>• Ergonomical seat for maximum comfort when sitting for a long time</li> <li>• Non corrosive 304 stainless steel hinge material</li> <li>• Top fix fitting : ideal for blind holes pans</li> </ul>			



SEAT CRESCENT ADULT



Description	WHITE SEAT AND COVER	WHITE SEAT ONLY		BLACK SEAT ONLY	
Reference	SCR12WH	SCR51WH	SCR53WH	SCR51BL	SCR53BL
EAN code	5012158669034	5012158650988	5012158669041	5012158655846	5012158669003
Packaging	Individually boxed				
Multiples / Pack	05 per outer / 100 per pallet	07 per outer / 140 per pallet			
Weight	2,6 kg				
Hinge Feature	Bottom Fix				
Hinge material	Non Cranked Stainless Steel	Plastic	Non Cranked Stainless Steel	Plastic	Non Cranked Stainless Steel
Features and benefits	<ul style="list-style-type: none"> <li>• Material: Thermoset</li> <li>• Hygienic: made of naturally antibacterial material</li> <li>• Resistant to scratches, UV and chemicals</li> <li>• Gap front seat to reduce contact with bacteria &gt; Ideal for hospitals and care homes</li> </ul>				

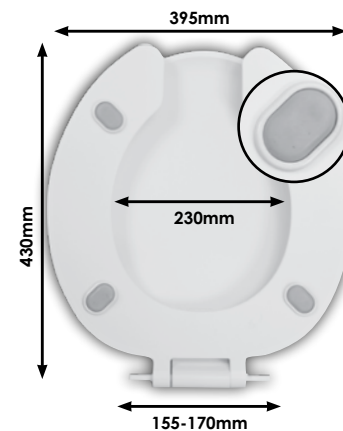





DIAGRAM - SCR12WH  
Full dimensional details  
per hinge p39



SEAT CRESCENT JUNIOR



Description	WHITE SEAT ONLY		BLACK SEAT ONLY	
	Reference	SCJ51WH	SCJ53WH	SCJ51BL
EAN code	5012158691820	5012158669102	5012158661922	5012158669089
Packaging	Individually boxed			
Multiples / Pack	07 per outer / 140 per pallet			
Weight	1,1 kg			
Hinge Feature	Bottom FIX			
Hinge material	Plastic	Non Cranked Stainless Steel	Plastic	Non Cranked Stainless Steel
				
Features and benefits	<ul style="list-style-type: none"> <li>• Material: Thermoset</li> <li>• Hygienic: made of naturally antibacterial material</li> <li>• Designed to fit 12" school pans</li> <li>• Resistant to scratches, UV and chemicals</li> <li>• Gap front seat to reduce contact with bacteria &gt;Ideal for schools</li> <li>• Made in the UK</li> </ul>			

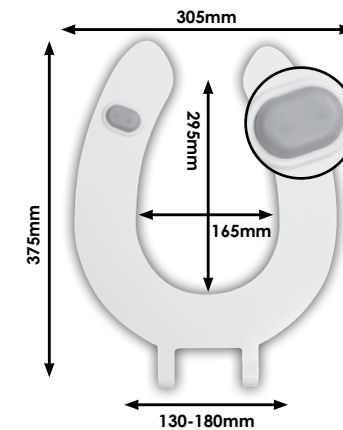
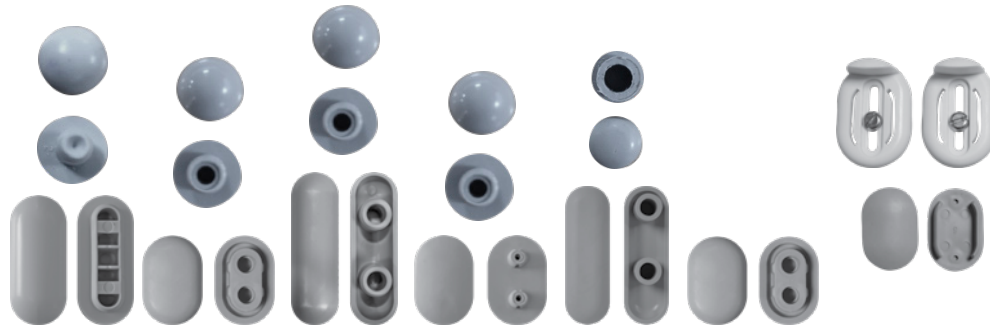


DIAGRAM - SCJ53WH  
Full dimensional details  
per hinge p39








**BUFFERS**







Description	BUFFER KIT PACK 1	BUFFER KIT PACK 2	BUFFER KIT PACK 3	BUFFER KIT PACK 4	BUFFER KIT PACK 5	SONATA SEAT BUFFER	LOCATING BUFFERS KIT
	20 cover + 20 seat buffers					40 seat buffers	Kit for 1 seat
Reference	<b>20120542</b>	<b>20120543</b>	<b>20120544</b>	<b>20120545</b>	<b>20120546</b>	<b>20120586</b>	<b>20120624</b>
EAN code	5017134147360	5017134147377	5017134147384	5017134147391	5017134147407	5017134147803	5017134148183
Packaging	Bag	Bag	Bag	Bag	Bag	Bag	Bag
Multiples / Pack	01/25	01/25	01/25	01/25	01/25	01/25	01/25
Material	Plastic	Plastic	Plastic	Plastic	Plastic	Plastic	Plastic
Seat names/ references	Madridio, Fusion, Magnum, Nadix	Crescent Adult, Crescent Junior and Sonata	Aria, Calypso, Lyric, MDTs1, Melody, Mercury, Neptune, Saxon, Tamar	Concerto, Maestro, Evermoor, Regent, Rondo VIP	Flamenco, Sapphire	Sonata Seat only	Celeste +
Suitable for	Up to 5 seats	Up to 5 seats	Up to 5 seats	Up to 5 seats	Up to 5 seats	Up to 10 seats	1 seat

**HINGES - PLASTIC**



Description	EXCENTRIC WHITE PLASTIC HINGE	DDP WHITE PLASTIC HINGE	DDP BLACK PLASTIC HINGE	TOP FIX WHITE PLASTIC HINGE + WHITE ROD
Reference	<b>FDR11WH</b>	<b>20120563</b>	<b>20120564</b>	<b>20120615</b>
EAN code	5012158674588	5017134147575	5017134147582	5017134148091
Packaging	Bag	Bag	Bag	Bag
Multiples / Pack	01/50	01/50	01/50	01/50
Fixation type	B/F	B/F	B/F	T/F
Material	Plastic	Plastic	Plastic	Plastic
Seat names/ references	HDS1, MDTs1, MDPP1, Neon, International, Flamenco, Melody, VIP	Sonata, Saxon, Calypso, Tamar, Concerto, Neptune, Lyric	Sonata, Saxon, Calypso,	Sonata, Calypso, Concerto, Neptune & Lyric
Lock +	 8mm Lock+ Included	 8mm Lock+ Included	 8mm Lock+ Included	Not compatible

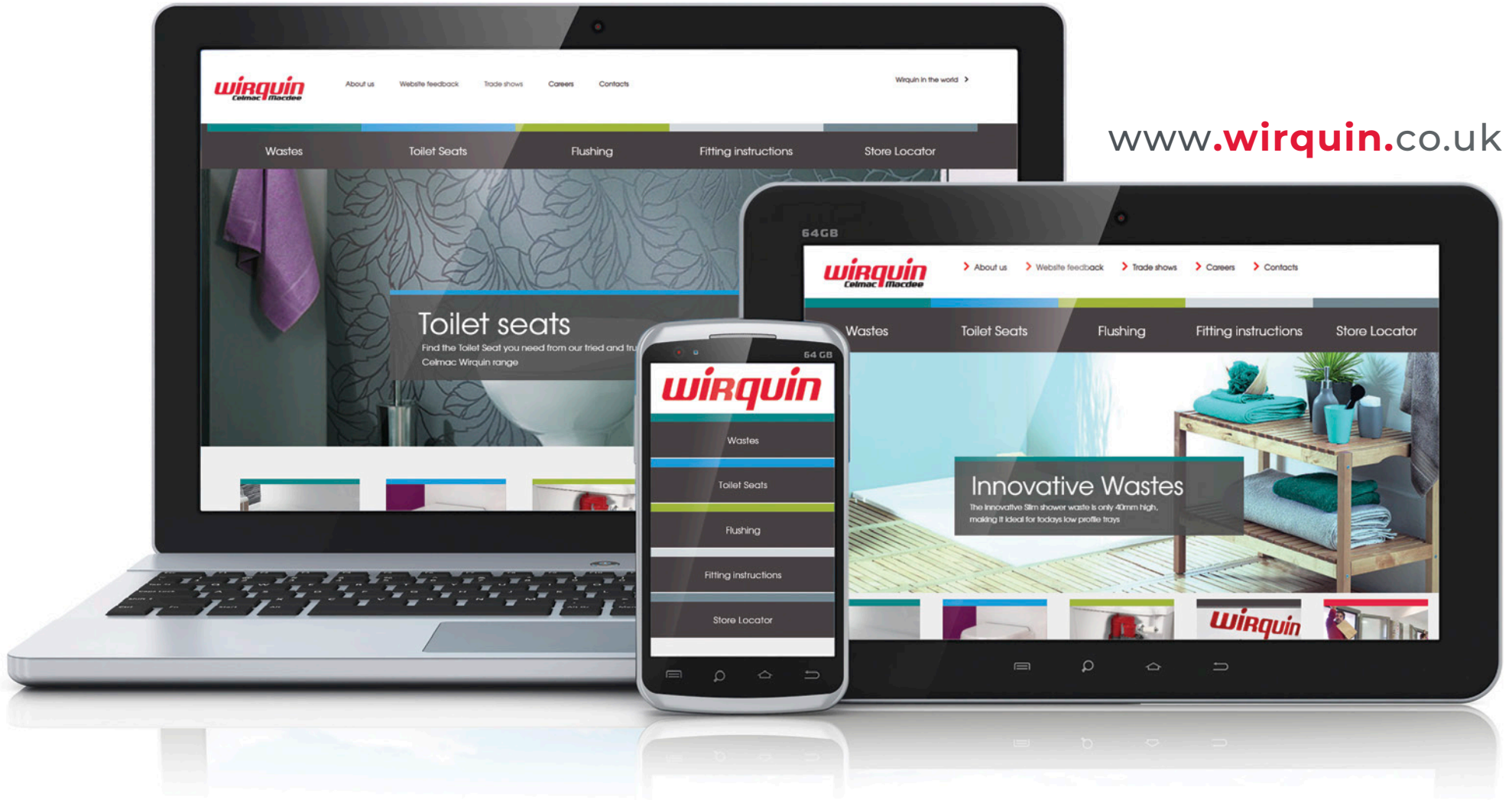
**MODUFIX  
TOILET SEATS**
**UNIVERSAL SHAPE  
TOILET SEATS**
**D- SHAPE  
TOILET SEATS**
**SPECIAL NEEDS  
TOILET SEATS**
**SPARES & ACCESSORIES**
**HINGES**


Description	NON CRANKED STAINLESS STEEL FITTINGS	BOTTOM FIX EXCENTRIC STAINLESS STEEL HINGE	TOP FIX EXCENTRIC STAINLESS STEEL HINGE	TOP FIX ROD HINGE	CHROME PLATED ROD HINGE	CRANKED STAINLESS STEEL FITTING	SOFT CLOSE QUICK RELEASE AND TOP FIX C/P BODY HINGE AND SS FITTINGS	SOFT CLOSE QUICK RELEASE AND TOP FIX PLASTIC BODY HINGE AND SS FITTINGS	FD211SS HINGE KIT – SPARES
Reference	<b>20120547</b>	<b>20120345</b>	<b>20120344</b>	<b>20120566</b>	<b>20120567</b>	<b>20120548</b>	<b>20120342</b>	<b>20120343</b>	<b>20120625</b>
EAN code	5017134147414	5017134133431	5017134133424	5017134147605	5017134147612	5017134147421	5017134133400	5017134133417	5017134148190
Packaging	Bag	Box	Box	Bag	Bag	Bag	Box	Box	Bag
Multiples / Pack	01/35	01/48	01/48	01/60	01/60	01/35	01/48	01/48	01/60
Fixation type	B/F	B/F	T/F	T/F	B/F	B/F	SC/QR/TF	SC/QR/TF	B/F
Material	Stainless steel	Stainless steel	Stainless steel	Stainless steel	Stainless steel	Stainless steel	Stainless steel	Stainless steel	Stainless steel
Seat names/ references	Saxon, Crescent Junior	HDTS1, MDTS1, MDPP1, Flamenco, Melody, VIP, Madridio	HDTS1, MDTS1, MDPP1, Flamenco, Melody, VIP, Madridio	Sonata, Celeste Plus	Sonata	Saxon, Celeste, mini P72, Tamar	HDTS1, MDTS1, MDPP1, Flamenco, Melody, VIP	HDTS1, MDTS1, MDPP1, Flamenco, Melody, VIP	Sonata
Lock +	Compatible with 8 mm Lock + (20120455)	 Included	 Included	Compatible with 6 mm Lock + (20120454)	Compatible with 6 mm Lock + (20120454)	Compatible with 8 mm Lock + (20120455)	 Included	 Included	Compatible with 8 mm Lock + (20120455)

		THERMOPLASTIC UNIVERSAL SHAPE										
		Neon	International	"Flamenco Plastic hinge"	"Flamenco B/F Metal hinge"	"Flamenco T/F Metal hinge"	Flamenco T/F Metal Hinge S/C, QR	Sapphire	First	Emerald plastic hinge	Emerald metal hinge	Tango
Hinge type	Plastic	●	●	●				●	●	●		●
	Stainless steel				●	●	●					
	CP brass										●	
Hinge features	Bottom Fix	●	●	●	●			●	●	●		
	Top Fix					●	●				●	●
	Soft Close						●	●				●
	Quick Release						●	●				●
	Lock +	●	●	●	●	●	●					
Hinge fittings	Plastic	●	●	●				●	●	●		
	Metal										●	●
	Stainless steel				●	●	●					
Lock+		20120455	20120455	20120455	20120454	20120454		n/a	n/a	n/a	n/a	n/a
Application	High traffic			●	●	●	●	●	●	●	●	●
	Medium Traffic	●	●	●	●	●	●	●	●	●	●	●
	Domestic	●	●	●	●	●	●	●	●	●	●	●
	Doc M											
	School											
Finish	White	●	●	●	●	●	●	●	●	●	●	●
	Black		●					●		●	●	
	Colours							●				
Buffers	Seat	n/a	4	4	4	4	4	4	4	n/a	n/a	4
	Cover	n/a	2	n/a	n/a	n/a	n/a	2	2	n/a	n/a	n/a
	Buffer Kit No	n/a	n/a	20120546	20120546	20120546	20120546	20120546	n/a	n/a	n/a	n/a
Dimensions	Seat width	375mm	360mm	385mm	385mm	385mm	385mm	380mm	363mm	380mm	380mm	360mm
	Adjustability (Mini to maxi seat projection)	435-460mm	417-451mm	415-425mm	415-425mm	412-427mm	406-458mm	433-446mm	417-422mm	440-460mm	440-460mm	438-442mm
	Hole centres	125-190	138-185	158-220	164-208	164-208	85-183	134-178	140-170	145-175	145-175	130-180
	Inner width	238mm	235mm	235mm	235mm	235mm	235mm	230mm	210mm	235mm	235mm	223mm
	Inner length	290mm	281mm	280mm	280mm	280mm	280mm	280mm	275mm	274mm	274mm	288mm
weight	Light	●	●									
	Medium			●	●	●	●	●	●			●
	Heavy									●	●	
Weight in kg		0,9	1	1,3	1,3	1,3	1,3	1,3	1,7	1,8	1,8	1,7

		THERMOSET UNIVERSAL SHAPE															
		Calyppo	"Melody Plastic hinge"	"Melody B/F or T/F Metal hinge"	Melody Top fix, QR, SC	Fusion	Saxon plastic hinge	Saxon metal hinge	Madridio Top fix	Madridio Soft close	VIP Top fix	VIP Soft close	Sonata Plastic hinge	Sonata B/F metal hinge FSS13SS	Sonata B/F metal hinge FBC11CP	Sonata B/F metal hinge FSS13SS	Sonata T/F metal hinge 218814
Hinge type	Plastic	●	●				●						●				
	Stainless steel			●	●	●		●	●	●	●	●		●	●	●	●
	CP brass																
Hinge features	Bottom Fix	●	●	●		●	●						●	●	●	●	
	Top Fix			●	●	●		●	●	●	●	●					●
	Soft Close				●	●			●			●					
	Quick Release				●												
	Lock +		●	●	●	●		●	●	●	●	●		●	●	●	●
Hinge fittings	Plastic	●	●				●						●				
	Metal																
	Stainless steel			●	●	●		●	●	●	●	●		●	●	●	●
Lock+																	
Application	High traffic							●	●	●	●	●	●	●	●	●	●
	Medium Traffic	●	●	●	●	●	●	●	●	●	●	●	●	●	●	●	●
	Domestic	●	●	●	●	●	●	●	●	●	●	●	●	●	●	●	●
	Doc M																
	School																
Finish	White	●	●	●	●	●	●	●	●	●	●	●	●	●	●	●	●
	Black	●					●	●					●				
	Colours																
Buffers	Seat	4	4	4	4	4	4	4	4	4	4	4	4	4	4	4	4
	Cover	2	2	2	2	2	2	2	2	2	2	2	2	2	2	2	2
	Buffer Kit No	20120544	20120544	20120544	20120544	20120542	20120544	20120544	n/a	n/a	20120545	20120545	20120543	20120543	20120543	20120543	20120543
Dimensions	Seat width	370mm	357mm	357mm	357mm	375mm	375mm	375mm	360mm	360mm	380mm	380mm	385mm	385mm	385mm	385mm	385mm
	Adjustability (Mini to maxi seat projection)	425-440mm	405-435mm	410-430mm	415-460mm	405-455mm	430-445mm	440mm	430-440mm	395-445mm	420-460mm	415-460mm	430-445mm	445mm	445mm	445mm	445mm
	Hole centres	135-175	155-190	123-245	86-170	75-178	135-175	145-155	105-205	105-205	125-165	75-177	130-160	155-170	170	147-170	185
	Inner width	233mm	228mm	228mm	228mm	235mm	228mm	228mm	220mm	220mm	235mm	235mm	235mm	235mm	235mm	235mm	235mm
	Inner length	280mm	275mm	275mm	275mm	298mm	277mm	277mm	280mm	280mm	290mm	290mm	280mm	280mm	280mm	280mm	280mm
weight	Light	●	●	●	●												
	Medium					●	●	●									
	Heavy								●	●	●	●	●	●	●	●	●
Weight in kg		1,3	1,3	1,3	1,7	1,6	1,6	2,1	2,1	2,3	2,3	2,5	2,5	2,5	2,5	2,5	

		MDF - UNIVERSAL SHAPE				THERMOSET D-SHAPE				SPECIAL NEEDS					
		Cavalcade	Woody Paramount	Woody	Woody Lux	Maestro B/F or T/F metal hinge	Maestro Soft Close	Amiral	Disco	Celeste Pro	Celeste Plus	Crescent Adult plastic hinge	Crescent Adult metal hinge	Crescent Junior plastic hinge	Crescent Junior metal hinge
Hinge type	Plastic		●									●		●	
	Stainless steel			●		●	●	●	●		●		●		●
	CP brass	●			●					●					●
Hinge features	Bottom Fix	●	●	●	●	●				●				●	●
	Top Fix						●	●	●						
	Soft Close						●	●	●						
	Quick Release														
Hinge fittings	Lock +					●	●								
	Plastic		●									●		●	
	Metal	●			●					●					●
Application	Stainless steel			●		●	●	●	●				●		●
	Lock+														
	High traffic					●	●	●	●				●		
	Medium Traffic			●	●	●	●	●	●	●	●	●	●	●	●
	Domestic	●	●	●	●	●	●	●	●	●	●	●	●	●	●
Finish	Doc M														
	School													●	●
	White	●				●	●	●	●	●	●	●	●	●	●
Buffers	Black													●	●
	Colours									●	●				
	Seat	4	4	4	4	4	4	4	4	4	4	4	4	2	2
Dimensions	Cover	2	2	2	2	2	2	2	2	2	2	2	2	n/a	n/a
	Buffer Kit No	n/a	n/a	n/a	n/a	20120545	20120545	n/a	n/a	n/a	20120624	20120543	20120543	20120543	20120543
Weight in kg	Seat width	370mm	370mm	370mm	370mm	370mm	370mm	360mm	360mm	374mm	370mm	395mm	395mm	305mm	305mm
	Adjustability (Mini to maxi seat projection)	396-410mm	426-446mm	435-455mm	420-430mm	430-450mm	405-455mm	420-430mm	395-450mm	460mm	425mm	415-442mm	430mm	366-397mm	375mm
	Hole centres	115-140	130-180	135-170	135-170	100-230	100-190	160-195	90-180	158	185	142-185	155-170	142-185	130-180
	Inner width	217mm	220mm	225mm	225mm	215mm	215mm	215mm	215mm	232mm	230mm	230mm	230mm	165mm	165
	Inner length	256mm	255mm	292mm	290mm	290mm	290mm	288mm	288mm	283mm	280mm				
Weight in kg	Light														
	Medium													●	●
	Heavy	●	●	●	●	●	●	●	●	●	●	●	●		
Weight in kg		3,5	2,7	2,5	3,5	2,3	2,3	2,1	2,5	2,2	2,2	2,6	2,6	1,1	1,1



 WirquinLtd  WirquinLtd  WirquinLtd  WirquinLtd UK