

# Air Flow Solutions



**Expert in Air Movement since 1955**



RESIDENTIAL FANS



HEAT RECOVERY



INDUSTRIAL FANS



ACCESSORIES



# Contents

## Airflow

Who we are, what we do

## Residential Fans

Ventilation for the home

## Commercial Fans

Offices, retail, leisure, education

## Hand Dryers

Quiet, hygienic and hands free

## Central Extraction

Ventilation for multiple rooms, MEV and dMEV

## Ventilation with Heat Recovery

From an apartment to a multi storey office block

## Accessories

Ducting, grilles, controllers and much more

## Industrial Fans

Blowers, hot air fans, flue dilution, OEM fans

## Instruments

Air flow and velocity measurement

## Information

Product index, glossary, terms and conditions

# Air Flow Solutions

For the air we breathe

Creating a healthier indoor environment  
whatever your application



# Welcome

## Welcome to the Airflow Ventilation Solutions catalogue.

The quality of the air we breathe directly effects the health of every man, woman and child. Ensuring our indoor environment is fresh and clean contributes to our general well being and as energy resources become scarcer, regulations become tighter and the awareness of environmental issues relentlessly increases, the importance of well specified ventilation has never been so high.

Choosing a ventilation partner who understands that energy efficiency, value for money and outstanding product quality can go hand in hand with stylish design and a determined commitment to supporting our customers at each stage of the process is paramount.

We have a passion for moving air and with over 60 years of innovation, knowledge and practical expertise, Airflow is that partner.

This catalogue, where our diverse range of products can be found in one place, provides a raft of quiet, well designed, reliable ventilation solutions for virtually any Residential, Commercial and Industrial application, from a simple extractor fan to a BMS internet controlled ventilation with heat recovery system.

We look forward to providing you with a quality air movement solution to suit your ventilation requirements.

Regards

Managing Director



# Company Pedigree

## More than 60 years of experience

Airflow has grown since 1955 from one mans knowledge in the fields of fan design and airflow measurement into a thriving international group, renowned for its innovative approach in developing new products and techniques for moving air.

Based in High Wycombe, where our founder started the business, we now span the world with subsidiaries in Germany and the Czech Republic and overseas distributors from Norway to New Zealand.

With knowledgeable and committed staff we are constantly striving to develop new, innovative solutions which raise standards and provide reliable, long term solutions for the stringent demands of our ever changing world.



# Our Story

## Airflow Developments Limited. A rich history of innovation and growth. Our story begins in 1955 with one mans dream.

**1955** Our founder, Alexander Conner Wilson established Airflow Developments in the garage of his home in High Wycombe.

Wilson was a fan engineer by trade and had an idea to develop a measuring instrument to help him in his fan testing work. With his wife Nancy, he started the company and invented the first inclined manometer (a pressure measuring device) to go into commercial production.

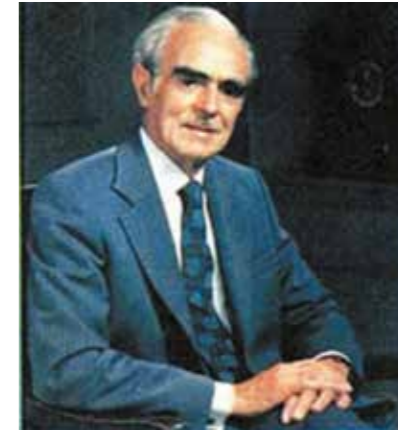

**1960** From the garage in his home, a move to new factory premises less than a mile away on the newly established Cressex Industrial Estate in High Wycombe.

The original wooden device, which measured positive, negative and differential pressure, was the forerunner of a range of air flow measuring instruments for HVAC applications which are still sold around the world today. He also invented the Wilson Flow Grid, an array of pitot static tubes which measure differential pressure. Even today the most sophisticated Formula 1 racing cars rely on this technology to measure their speed and performance.

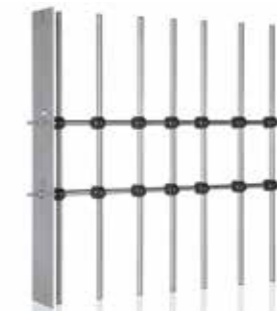

**1965** Industrial centrifugal fans and blowers were introduced into the manufacturing process sold to original equipment manufacturers for ventilation, cooling and warm air distribution purposes.

**1969** The domestic extractor fan, the Aidelle Loovent was launched. With over two million units sold to date it still forms part of the residential ventilation portfolio of extractor fans.



# Our Story

- 1995** Part of the original factory is demolished and new offices, stores and showroom complex added to double the floor space.
- 2004** Introduced in 2004, iCON's unique, patented iris shutter design remains a highly distinctive and individual product.
- 2006** The iCON wins the European Reddot design award.
- 2009** The company has developed its eco-air portfolio in line with U.K government policy towards energy efficient construction products and includes low noise, low energy fans and mechanical ventilation with heat recovery for commercial and residential building to meet new Building Regulations introduced in 2010.
- 2012** The QuietAir fan wins national recognition by achieving Quiet Mark Status following independent testing by the Noise Abatement Society.  
Runner up in the H&V Review Commercial Ventilation Product of the Year
- 2013** DUPLEXVENT is short listed at the H&V News, The H&V Review, the Energy Awards and the Electrical Industry Awards.  
BPEC accredited training centre status.
- 2014** Airflex Pro wins 'Air Movement Product of the Year' at the H&V News Industry Awards.  
Highly commended at H&V Review Awards with Duplexvent Multi.  
LOOVENT eco short listed at the KBB Kitchen and Bathroom Industry Awards.
- 2015** Highly Commended in the H&V News Award with Duplexvent Multi  
The launch of the iCONstant fan - quietest dMEV fan available today for toilet / bathroom / utility room.



# International



## Global reach



**UNITED KINGDOM**  
High Wycombe (Head Office)

Our founder started the business in 1955 just one mile away from our current location. Since 1960 this has been the headquarters for the Airflow Group where our staff oversee all the activities serving our subsidiary companies in Germany and the Czech Republic and international distributors from around the world.

**Airflow Developments Limited** Tel: +44 (0) 1494 525252  
Aidelle House, Lancaster Road Fax: +44 (0) 1494 461073  
Cressex Business Park Email: info@airflow.com  
High Wycombe, Bucks. HP12 3QP Web: airflow.com



**GERMANY**

Established for over 50 years, Airflow has been serving the German and European market with ventilation products and air measuring instruments. With their own customer service, sales and after sales team they operate from modern offices and warehouse facilities near Cologne.

**Airflow Lufttechnik GmbH** Tel: +49 (0) 2226 92050  
Postfach 1208 Fax: +49 (0) 2226 920511  
D-53349 Rheinbach Email: info@airflow.de  
Germany Web: airflow.de



**CZECH REPUBLIC**

Serving Eastern Europe for 20 years, the team at Airflow in Prague are well placed to support the sales and service of Airflow Ventilation products in the Czech Republic and the surrounding countries

**Airflow Lufttechnik - Praha** Tel: +42 (0) 2747 72230  
Hostynska 520 10800 Praha 10 Fax: +42 (0) 2747 72370  
Malešice Email: info@airflow.cz  
Prague Web: airflow.cz  
Czech Republic



**WORLDWIDE**

With worldwide distributors from Norway to New Zealand we have a global network of approved distributors.

For further details of your nearest distributor visit us at [airflow.com](http://airflow.com)



# Working Together

## Airflow is committed to raising ventilation standards

Through our active participation with industry trade associations and Government advisory groups we seek to raise the standards of regulations, product design, performance and on-site installation.

BEAMA (British Electrotechnical and Allied Manufacturers Association) has a specialist ventilation group which promotes best practice and installation, product specification and future Building Regulations.



EVIA (European Ventilation Industry Association) represents the leading ventilation companies in Europe and assists in drafting regulations and promoting best practice.



FMA (Fan Manufacturers Association) focuses on commercial and industrial fans influencing and monitoring regulations both nationally and internationally.



RVA (Residential Ventilation Association) provides a detailed technical oversight of regulations and industry matters effecting residential ventilation and inputs to the industry advisory group for Building Regulations.



The Passivhaus Trust provides leadership in the UK for the adoption of the Passivhaus standard and construction methodology which specifies Mechanical Ventilation with Heat Recovery.



KBSA The Kitchen Bathroom Bedroom Specialists Association is made up of independent, local kitchen, bedroom, bathroom and home office retailers promoting best practice design including ventilation.



BSRIA test, research and consult in construction and building services providing specialist support for design, construction, facilities management, product testing and market intelligence.



BPEC (British Plumbers Employers Council) is a nationally recognised training organisation. Their ventilation installer training course, which we provide at our training centre in High Wycombe, promotes "Best Practice" installation, testing and commissioning to raise standards across the ventilation sector.



BRE (Building Research Establishment) is an independent research and testing organisation dedicated to improving the build environment, supporting the implementation of building regulations.



# Partnering with Industry

## Innovating together

Airflow is working together with other environmentally committed companies to research and develop a holistic approach to improving indoor air quality and energy saving technologies.



The best underfloor heating - guaranteed™

## Warmup Plc

Warmup is a U.K based Plc creating and delivering electric underfloor heating systems and solutions around the world for nearly 20 years to both domestic and commercial markets and occupying a world leading position in their field. They supply homeowners, builders, architects and developers looking for the best underfloor heating solution.

[www.warmup.co.uk](http://www.warmup.co.uk)



## Greencore Construction

A consultancy and project management company dedicated to delivering inspirational, low carbon buildings which contribute to the decarbonisation of the built environment.

[www.greencoreconstruction.co.uk](http://www.greencoreconstruction.co.uk)

## Renewables House



Airflow partner with the Building Research Establishment (BRE) Innovation Park in Watford, investigating the benefits of ventilation with heat recovery in new and refurbished buildings.



## National Self Building and Renovation Centre

NSBRC The National Self Building and Renovation Centre in Swindon is UK's only permanent national exhibition centre for self-build, renovation & home improvement. Visit the Airflow stand for ideas and installation support.

[www.nsbrc.co.uk](http://www.nsbrc.co.uk)



## Mark Group

The Mark Group are the UK's leading energy saving experts, helping take a 'whole home' approach to energy efficiency since 1974.

Airflow are pleased to have been chosen as their ventilation partner supplying a Duplexvent MVHR unit and an Airflex Pro ducting system to the Mark Group EcoHouse, part of the University of Nottingham's Creative Energy Homes Project.

Airflow partner with the Building Research Establishment (BRE) Innovation parks in Watford and Livingstone in Scotland promoting the benefits of ventilation with heat recovery in new and refurbished buildings

[www.markgroup.co.uk](http://www.markgroup.co.uk)



# Is your building toxic?

## The causes

### Airtight Homes



Modern dwellings are designed with increasingly reduced air infiltration rates, higher levels of insulation making them almost completely sealed.

Consequently the air inside can become moist, stale and generally stuffy and unpleasant to breathe. As we spend nearly 70% of our time at home we should be looking after our indoor environment better.

### Unhealthy Atmosphere



The indoor climate can be too warm, too cold, too damp, too dry combined with the activity of everyday living and people living together in close proximity produced odours, cooking smells and numerous unhealthy, volatile organic compounds (VOC).

### Biological Pollutants



Are you sharing your bed with thousands of dust mites? Bedding and carpets are their home and if your dwelling is overly damp or humid they breed all the more. Dust mites contribute to the increase in asthma, chest infections and allergies and if left unchecked represent a very real health hazard.

### Condensation



Dampness is a huge problem in the U.K. Damaging to both humans, and to the fabric of buildings, condensation forms when the temperature of a surface (walls, mirror etc) is below the dew point of the surrounding air. This leads to streaming windows and walls and ultimately to mould.

### Carbon Emissions



Everyone is aware of the need to reduce our carbon footprint. Managing the carbon emissions from dwellings will be the cornerstone of our Building Regulations until we reach a carbon zero dwelling.

From appliances to people, carbon dioxide and carbon monoxide is emitted and needs to be curtailed.

# The Story of Air

### Radon



Radon is a naturally occurring, invisible, odourless gas that comes from deposits of uranium in soil, rock, and water. It is harmlessly dispersed in outdoor air, but when trapped in buildings, can be harmful, especially at elevated levels. Some regions of the U.K are more prone to radon gas than others. Exposure to radon is a leading cause of lung cancer behind smoking. The effects of radon gas in a dwelling can be largely eliminated by continuous mechanical ventilation.

### Noise



Many people do not really stop and consider the constant level of sound we are subjected to on a daily basis, but noise is ever present.

Often it is subliminal but never the less present around us, affecting our nervous system and in extreme cases our well being. Specifying quieter running ventilation products and radial design duct work that does not transmit noise between rooms contributes to a lower noise indoor environment.

### Mould



Unchecked levels of moisture (condensation) and relative humidity combined with a suitable organic breeding place such as wood, carpet, wallpaper etc., will inevitably lead to mould growth. Mildew forms in wall cavities and crevices and microscopic mould spores can be inhaled by humans triggering asthma, allergies and skin disorders.

### Toxic Gases



A variety of noxious and toxic gases can collect within a dwelling if not properly ventilated. All can have a serious effect on health and well being if not considered as part of a ventilation strategy.

## Did you know?

**81%**

of people are at risk from a respiratory or dermatological condition because of poor air quality in their home

**58%**

of people have experienced mould or condensation in their home

**15.3**

million homes in the UK are at risk of 'Toxic Home Syndrome'

**90%**

of our time is spent indoors, where air can be more polluted

**900**

more chemical, particles and biological materials indoors may effect our health

**50%**

more pollutants may be found inside your home than outdoors

# We have the Solution for You!

**Whatever your interest in ventilation we have the answer to your requirements.**

## Specifier

With over 60 years of experience, we provide ventilation solutions for both the social housing sector and the private house builder, so Airflow is well placed to help you specify the most suitable product for your application.

Our portfolio of low energy, high efficiency products are designed to meet, not just today's regulations, but the requirements of future legislation. Complying with the drive towards a carbon zero home we are able to provide solutions for architects and consultants to help them meet, Building Regulations, Decent Homes Standard, SAP Appendix Q, IEE Wiring Regulations, Passive House and BREEAM criteria.



## Installer

We understand that installers do not just want good value, they want a product that they can install quickly and easily in the knowledge that it will provide years of trouble free operation.

From the origins of the Aidelle Loovent back in 1969 it is not unusual to see Airflow extractor fans working quietly away after 15 years or more service in bathrooms and toilets. With well over two million sold they are tried and tested.

Designed with the installer in mind our products comply with IEE wiring regulations for a fast, safe installation.

Technical support is available on-line, on-mobile or phone.



# We have the Solution for You!

## Merchant

We know that our wholesalers, merchants and distributors pride themselves on providing a fast and efficient turnaround for their customers. Holding stock on the shelf is the key to providing the customer with the immediate service that he or she quite rightly demands.

Airflow supports the committed wholesaler by offering its customers a fast, efficient e-commerce solution for placing orders. Our on-line Trade Counter allows the latest prices and stock availability to be checked and orders securely placed on-line. Now our customers can log-on and place an order on their own account saving time and money. Additionally, point of sale displays, branch promotions and retail packaging instantly describing the product and the support of a dedicated area sales manager is provided to ensure the merchant can offer that extra special service to their customers.



## Homeowner

From the million selling Loovent range of fans that for many years have been the byword for fast, effective toilet and bathroom extraction through to the award winning iCON range of silent shutter fans that combine contemporary styling and colour co-ordination to suit existing décor.

Saving energy is on everyone's agenda and Airflow's QuietAir range provides exceptionally low power usage and is independently approved by the Noise Abatement Society. The Duplexvent Ventilation with Heat Recovery range, enables a 'designed-in' solution for new dwellings to recover over 90% of the heat that would otherwise go to waste. From improvers to self builders we have ventilation solutions for every home.





# Our Range

## Residential Fans

Extracting damp, moist air reduces the effects of condensation, mould growth, odours and airborne pollutants that can help create allergies and encourage asthma in adults and especially children. We produce an extensive range of extractor fans that comply with the latest Building Regulations and offer quiet, stylish unobtrusive extraction for toilets, bathrooms, en-suites, utility and kitchens.

## Commercial Fans

Higher performance extraction for larger rooms, toilet clusters and commercial / retail applications. Using a centrally located fan reduces noise and enables ducting to multiple outlets. Consider CIBSE recommendations for air changes per hour in differing applications.

## Heat Recovery

Mechanical Ventilation with Heat Recovery (MVHR) is the process of continuously preheating filtered, incoming fresh air by warming it with outgoing, waste air from a bathroom, utility and kitchen. By recycling the warmth through a heat exchanger warmed, fresh air is supplied to living and working areas. Duplexvent is a range of high thermal efficiency (over 90%) MVHR units which comply with SAP Appendix Q and selected units are Passive House Institute Approved. Available for both residential and commercial applications.

## Industrial Fans

Airflow have been producing high quality centrifugal fans and blowers for nearly sixty years and have been at the forefront of developing new technologies to meet the fan requirements of the market. From custom OEM designs to "off the shelf" products we have an individual fan for cooling, venting, diluting, warming, destratification and almost every air movement application in between.

## Accessories

As good as the product is, installed performance can suffer when poor quality components are selected or as a result of a poor quality installation. Airflow match all accessories with their products to ensure a fully compatible installation allowing optimum performance. In fact, our semi rigid ducting system is "Zero Leakage" and is SAP Appendix Q eligible.



# Which System is Right for Me?

## Selecting the Correct Product

The Building Regulations only recommend four principle methods of residential ventilation. Airflow have been specialising in the most effective methods for many years. The following is an overview of the best options available.

An essential part of reducing carbon emissions is the need to develop and install more efficient appliances for more energy efficient dwellings to meet the relevant SAP ratings and provide lower specific fan power (SFP) ventilation products with longer life cycles.

In line with the latest Building Regulations, Airflow offer a comprehensive range of solutions to ensure good ventilation in our homes and helping to achieve our national objectives under the 2010 Oslo agreement.

## Intermittent Extract Fans

Wall, ceiling or window mounted with a choice of controls in axial and mixed axial/centrifugal and centrifugal impeller variants. Energy efficient, low watt, quieter running. All important elements in specifying and installing products to meet the Building Regulations.

## Central Extract Ventilation (MEV/dMEV)

Continuously running in either centralised (loft, cupboard) or decentralised (room) locations for quieter, constant extraction from wet rooms. Available with multiple speed choices.

## Mechanical Ventilation with Heat Recovery (MVHR)

Continuously running from a centralised location. Extracting moist, stale air from wet rooms in a dwelling, and introducing fresh, filtered air, warmed in an exchanger with the outgoing waste air filtered and recycled to living rooms within the dwelling. Airflow supply a range of SAP Appendix Q eligible and Passive House approved units for exceptional efficiency.

## Hygienic, Zero Leakage Ducting

There is not much point in investing in energy efficient appliances if the benefits are lost from a poorly designed duct system. Choose a radial system to reduce the places where dust and spores can gather. Insist on a hygienic system with a coated, anti-static bore tube that connects each room individually avoiding the spread of noise between rooms.

**AIRFLEX PRO**

iCON® QuietAir™

LOOVENT eco

AiROVENT™

iCONstant™

**DUPLXVENT®**



# Training and Support

## Showroom

Our extensive showroom at our High Wycombe Head Office can accommodate large groups in state of the art facilities. The full range of products are on view and take the visitor on a journey through the "Story of Air" of why we should ventilate while explaining the product range from a stylish extract fan to a fully working MVHR system.

The facility is also available for hire for customer events and industry meetings.



## CPD

With so much knowledge gained over so many years we are pleased to share our experience. We recognise that on-going professional development is part of all our working lives.

We offer a range of CPD approved seminars that can be conducted at your offices or at our training centre in High Wycombe.

To arrange, visit:  
[airflow.com](http://airflow.com)



## Training

With the introduction of the Domestic Ventilation Compliance Guide as part of the Building Regulations 2010 new levels of knowledge are needed by installers who will commission and pass ventilation data to Building Control.

The nationally recognised BPEC Domestic Ventilation Systems installer training is a two day course held in High Wycombe.

The course will train you to:

- Understand, select and install correctly domestic ventilation systems
- Test, commission and report to building control on the system installed

The latest training dates may be viewed at:

[airflow.com/bpectraining](http://airflow.com/bpectraining)



# Training and Support

## Technical Support

We have a fully trained team waiting to provide assistance and application advice on all ventilation matters. From choosing a residential extract fan to specifying a commercial MVHR system.



## System Design and BIM

If you are considering specifying a ventilation system why not send us your drawings. We can advise on the most suitable product complete with compatible accessories to ensure an effective installation.

Send your drawings to:  
[plans@airflow.com](mailto:plans@airflow.com)

We also have product data in industry leading format for those designers using BIM software, so that all information is available in one file.

Visit: [airflow.com/BIM](http://airflow.com/BIM)



## Contact us

### Airflow Developments Limited

Tel: 01494 525252  
Fax: 01494 461073  
e-mail: [info@airflow.com](mailto:info@airflow.com)

### Customer Services

Tel: 01494 560800  
Fax: 01494 560808  
e-mail: [customer\\_services@airflow.com](mailto:customer_services@airflow.com)

### Technical Support

Tel: 01494 560950  
e-mail: [technical\\_sales@airflow.com](mailto:technical_sales@airflow.com)

### Marketing

Tel: 01494 560832  
e-mail: [marketing@airflow.com](mailto:marketing@airflow.com)



# Environmentally Responsible

## Taking care of our environment

We all agree that Carbon Emissions need to be reduced. At Airflow we take these challenges seriously and have taken many steps to manage our environment. By recycling our waste, converting our facility to motion activated lighting, ensuring our field sales staff drive 'eco' standard vehicles we seek to practice what we preach.

Similarly equipment is designed with strict environmental criteria in mind ensuring our customer receives a quality product that can be effectively recycled when the time comes for replacement.



## ISO 9001 Quality Matters!

Airflow Developments Limited was the 152nd company to achieve the ISO 9001 (BS 5750) standard for Quality Management Systems. Today in the U.K there are now tens of thousands of certified organisations.

Our long-standing commitment to rigorous development, design and manufacture of our products to internationally accepted standards has been a feature of the Airflow ethos.

The ISO 9001 kite-mark is positive proof for our customers that their purchase will be tried and tested and provide years of trouble free operation.



## ISO 14001 Environmental Matters!

Currently one of the very few ventilation manufacturers to have achieved the stringent ISO 14001 Environmental Management Systems Standard, Airflow continues to lead the way in ensuring we do our utmost to reduce our environmental impact. By improving efficiency while reducing energy usage, waste and consumption of resources we strive to deliver innovative products while operating our business in an environmentally effective way.

If your supplier does not share these ideals, ask yourself why? Choose Airflow for a sustainable future.



# General Information

## Terms

Airflow Developments Limited reserve the right, in the interests of continuous development, to alter specifications without prior notice. All orders are accepted subject to our latest conditions of sale which are available upon request.

Refer to the Airflow website ([www.airflow.com](http://www.airflow.com)) which is the most up to date source of information.

## Intellectual Property

The information, content, specifications and products offered in this catalogue are subject to patent, trademark, international design and copyright regulations. Airflow Developments Limited will take all necessary steps to protect its brand and pursue any infringements.

## Performance Testing

Airflow Developments Limited has its own air movement laboratory. Fans are performance tested in accordance with BS EN ISO 5801 : 2008 and BS EN 848-1 : 2007.

Approved by	
BS EN 13141 – 4 : 2011	Performance testing of products for residential ventilation.
BS EN 60335 – 1 : 2012 +A1: 2014	Household and similar electrical safety general req.
BS EN 13347 – 3 : 2004 +A1: 2010	Industrial fan sound power levels under standardised lab conditions.
BS 1S0 13347 – 2 : 2004, BS 848 – 2 2 : w2004, BS 1S0 13347 – 4 : 2004, BS 848 – 2 4:2004, BS 1S0 13347 – 1 : 2004 +A1: 2010, BS 848 – 2 1 : 2004, BS 1S0 13347 – 3 : 2004 +A1: 2010, BS 848 – 2 3 : 2004	Fans for general purposes, methods of noise testing.

## Fan Sound Data

The majority of Airflow fans have had full acoustical tests for sound carried out on them, and these are normally for open inlet or open outlet sound power levels.

For each fan shown in the catalogue we have selected a typical performance duty point, or the maximum speed and then quoted the overall 'A' weighted sound pressure level normally given at either 1 or 3 metres from the fan.

Additionally the values shown are based on 'free field', this assumes that the sound is radiated into a large space, and the sound source is in the centre of this space. It is important to note that this is for comparison purposes and that the real sound pressure level experienced will depend on the acoustic characteristics of the area the fan is being used in.

## ErP

Airflow fans are offered in compliance with the latest phase of the ErP directive, unless otherwise stated.

For an explanation on currently compliant and non-compliant products please refer to the ErP section.

## WEEE

Waste Electronic and Electrical Equipment Directive. Airflow Developments Limited are registered under the WEEE scheme.

## IP Ratings

Airflow Developments Limited design fans to meet international Ingress Protection (IP).

Ratings: Two numerical classifications are used ie. IPXX. IPXX is untested.

The first number in the code indicates the level of protection that the enclosure provides against solid objects, from 0 to 6.

IP0 offers no protection while IP6 offers complete protection against dust ingress.

The second number provides the level of protection against the ingress of water.

IPX0 offers no protection, while IPX4 offers protection against splashing water.

IPX5 offers protection against water jets.

The maximum protection is IPX9.

# Useful Conversions

## Comparing Values

We can all get confused by the variety of units of measure in use. Here are a few helpful conversions.

### PRESSURE:

mmH <sub>2</sub> O	N/m <sup>2</sup> (pascals)	Psi	mbar	ins wg
25.4	249.089	0.0361	2.4908	1
1	9.8066	0.0014	0.098	0.0393
0.1019	1	0.0001	0.01	0.004
703.07	6894.76	1	68.9476	27.68
10.197	100	0.0145	1	0.4015

### VOLUME:

l/sec	m <sup>3</sup> /hr	m <sup>3</sup> /min	m <sup>3</sup> /sec	cfm
0.4719	1.699	0.0283	0.0004	1
1	3.6	0.06	0.001	2.1189
0.2777	1	0.0166	0.0002	0.5885
16.6662	60	1	0.0166	35.3145
999.972	3600	60	1	2118.88

### VELOCITY:

m/sec	Km/h	mph	Knots (UK)	ft/min
0.005	0.0182	0.0113	0.0098	1
1	3.6	2.2369	1.9426	196.85
0.2777	1	0.6213	0.5396	54.681
0.447	1.6093	1	0.8684	87.9997
0.5147	1.853	1.1515	1	101.333

\*Note: For guidance only. E&OE

Location	Air changes/Hour	Location	Air changes/Hour	Location	Air changes/Hour	Location	Air changes/Hour
Assembly halls	4-8	Banks/Building Societies	4-8	Glasshouses	25-60	Mushroom houses	6-10
Bakeries	20-30	Bedrooms	2-4	Gymnasiums	6 min	Offices	6-10
Bathrooms	6-10	Billiard rooms *	6-8	Hairdressing salons	10-15	Paint shops (not cellulose)	10-20
Billiard rooms *	6-8	Boiler rooms	15-30	Hospitals - sterilising	15-23	Photo & X-ray darkrooms	10-15
Cafes and coffee bars	10-12	Canteens	8-12	Wards	6-8	Public house bars	12 min
Cellars	3-10	Changing rooms main area	6-12	Kitchens - domestic	15-20	Recording control rooms	15-25
Changing/Shower area	15-20	Churches	1-3	Commercial	30 min	Recording studios	10-12
Cinemas & theatres *	10-15	Club rooms	12 min	Laboratories	6-15	Schoolrooms	5-7
Compressor rooms	10-20	Conference rooms	8-12	Laundrettes	10-15	Shops and supermarkets	8-15
Dairies	8-10	Dance halls	12 min	Laundries	10-30	Squash courts	4 min
Dental surgeries	12-15	Dye works	20-30	Lavatories	6-15	Swimming baths	10-15
Electroplating shops	10-12	Engine rooms	15-30	Lecture theatres	5-8	Toilets	6-10
Entrance halls & corridors	3-5	Factories and workshops	8-10	Libraries	3-5	Utility rooms	15-20
Foundries	15-30	Garages	6-8	Living rooms	3-6	Welding shops	15-30

© CIBSE

# Air Flow Solutions

## iCONstant™

Clean air thinking 24/7 365

...continuous ventilation for a better indoor air quality



- From 10dB(A) the quietest dMEV fan available for toilet, bathroom and utility. Suitable for kitchen too.
- From just over £1.00 per year to run on trickle speed.
- You select 6, 8 or 13 l/sec plus boost with 'fine tune' commissioning adjustment option of running rate for optimum extraction.
- Constant air flow - Guaranteed to deliver installed performance.
- The only dMEV fan IPX5 rated for both wall and ceiling installs.
- Timer and Humidity versions.
- SAP Appendix Q eligible.
- LED self diagnostic set up with no loss of functionality if the power fails.
- Complies with Building regulations
- 3 Year warranty.

For further information see pages 74-77

Visit: [airflow.com](http://airflow.com)



# What Fan and Where?

## Installed performance

It is not sufficient to fit just any fan. It is important that the fan performs efficiently by extracting the minimum flow rate as required by the latest Building Regulations. The number of bends and the length of duct attached to the fan will create resistance to flow that must be overcome to ensure adequate extraction, known as installed performance.

Fans should also be positioned to give an optimum flow of air through the whole room and to avoid pockets of residual air. The location of planned or existing door and window openings must be considered as well as sources of odours, stale air or condensation. Undercutting of doors or grilles may need to be installed to allow air into the room, particularly with internal rooms which have no windows and tightly sealed doors.

Fans should be mounted as high as possible, well away from primary heat sources such as gas water heaters and boilers.

## Domestic Ventilation Compliance Guide

The 2010 Building Regulations introduced a "Good Practice" installation guide for fan installation, inspecting and commissioning new and existing dwellings. Consider this document as part of your specification. Don't forget a fan can only extract air if there is air coming in to replace it.

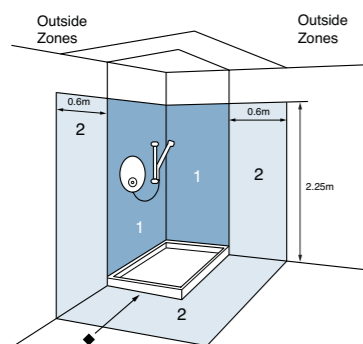
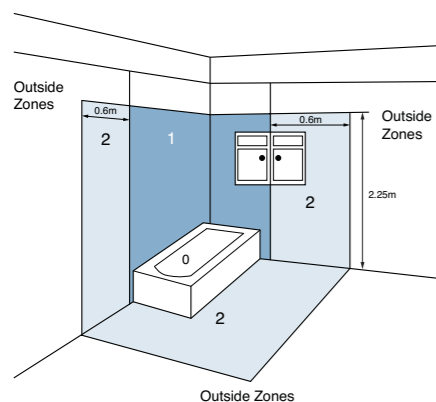

## What Type of Fan

Having considered the application of the ventilation required, it is important to select the correct type of fan to ensure that the requirement is truly met. However you should first consider which type of fan will best suit you to provide quiet efficient ventilation.

**Axial Fans** are ideal for through the wall and window applications. Providing high performance with a slim profile, they are suitable for use with flexible ducting up to a maximum 1.5m length

**Mixed Flow Fans** combine the convenience of a slim axial fan with the performance of a small centrifugal making them ideal for short duct runs

**Centrifugal Fans** are quiet, powerful and suitable for wall and ceiling applications. They also work very efficiently against system resistance making them the perfect choice for ducted installations

## Where to install

IEE regulations specify the installation of fans within bathrooms and showers by identifying a series of zones. IEE regulations must be adhered to for all electrical installations. Fans must be installed in accordance with the latest IEE Wiring Regulations 17th Edition (BS 7671:2008) + A2:2013. Part 7 (Special Locations).

### Zone Information

Zone 0:

The Interior of the bath or a shower tray NO Fan can be fitted.

Zone 1 is limited by:

(i) the finished floor level and the horizontal plane corresponding to the highest fixed shower head or water outlet or the horizontal plane lying 2.25m above the finished floor level, whichever is higher.

(ii) the vertical surface:

- circumscribing the bath tub or shower basin
- at a distance of 1.20m from the centre point of the fixed water outlet on the wall or ceiling for showers without a basin.

The space under the bath tub or shower basin is considered to be zone 1. However, if the space under the bath tub or shower is only accessible with a tool, it is considered to be outside the zones.

Zone 2 is limited by:

(i) the finished floor level and the horizontal plane corresponding to the highest fixed shower head or water outlet or the horizontal plane lying 2.25m above the finished floor level, whichever is higher.

(ii) the vertical surface at the boundary of zone 1 and the parallel vertical surface at a distance of 0.60m from the zone 1 boarder

For showers without a basin, there is no zone 2 but an increased zone 1 is provided by the horizontal dimension of 1.2m mentioned in Regulation 701.32.3(ii) b).

# Building Regulations

## Delivering Improvement

It all started in London when the first "Building Act" came into force forbidding thatched roofs inside the city limits. By the time of the Great Fire of London in 1666, many thatched buildings still remained, spreading the fire. Shortly after the first "inspected" building code was introduced.

Fast forward to the "1984 Building Act" and the first appearance of a dedicated ventilation regulation. In 1991 they became the "Building Regulations" with further revisions in 2000, 2006 and 2010, with amendments in 2013.

Using the Building Regulations as a tool to meet our commitments to the 2005 Kyoto protocol and more recently the Copenhagen climate agreement, the U.K government has planned a path for the construction industry towards a "new build" Carbon Zero home by 2016.

Why? To do this they are using the 2006 regulations as the base line to introduce calculated reduced energy usage and carbon emissions in residential and non-residential dwellings.

2006 Regulations = Starting Point

2010 Regulations = **25% Reduction** on 2006

2013 Regulations = **44% Reduction** on 2006

2016 Regulations = **Carbon Zero New Dwelling**

## Building Regulations England and Wales

References in this catalogue refer to Approved Document F1: Means of Ventilation for England and Wales unless otherwise stated.

Visit: [www.planningportal.gov.uk/buildingregulations](http://www.planningportal.gov.uk/buildingregulations)

Please note that other documents apply specifying ventilation in Scotland, Northern Ireland and the Republic of Ireland.

### Scotland

Refer to the Scottish Building Standards, technical handbook 2015 edition for domestic and non-domestic applications, Standard 3.14

Visit: [www.scotland.gov.uk](http://www.scotland.gov.uk)

### Northern Ireland

Refer to the Building Regulations (Northern Ireland) 2014, Part K.

Visit: [www.dfpni.gov.uk](http://www.dfpni.gov.uk)

### Republic of Ireland

Building Regulations, Technical Guidance Document F:2009 Ventilation.

Visit: [www.environ.ie](http://www.environ.ie)

## Drivers for change

- **Government policy – 25% reduction in carbon emissions by 2020**
- **Legal commitment to reduce carbon emissions by 80% by 2050**
- **Energy Efficiency – Lowering energy usage**
- **Sustainability – The green agenda**
- **A Carbon zero commercial new building by 2019**
- **A Carbon zero new residential dwelling by 2016**
- **Well being, improved indoor air quality – U.K has the highest Increase in asthma in Europe**

## Scale of the challenge

- **Existing buildings account for 42% of U.K green house gas emissions**
- **In 2050, 75% of housing stock will still predate the 2010 level**
- **In homes 82% of emissions are from hot water and heating**

# Building Regulations - System 1

## Background Ventilators and Intermittent Fans

Approved Document F1: 2010 England and Wales (with amendments in 2013)

Room	Intermittent Extract Rate
Kitchen	30 l/sec (adjacent to hob) or 60 l/sec (elsewhere)
Utility Room	30 l/sec
Bathroom	15 l/sec
Sanitary Accommodation	6 l/sec

- Mechanical Intermittent Extract Fans located in the wet rooms to extract pollutants quickly at a high rate.
- Can be controlled either:
  - Manually via integral / remote switch
  - Automatically, typically via humidity, CO<sub>2</sub>, motion or other sensors.
- Normally wall or ceiling mounted and ducted direct to outside air using the most economical route.
- Replacement air enters the building via background ventilators, typically in the form of window vents located in the head of window frames.

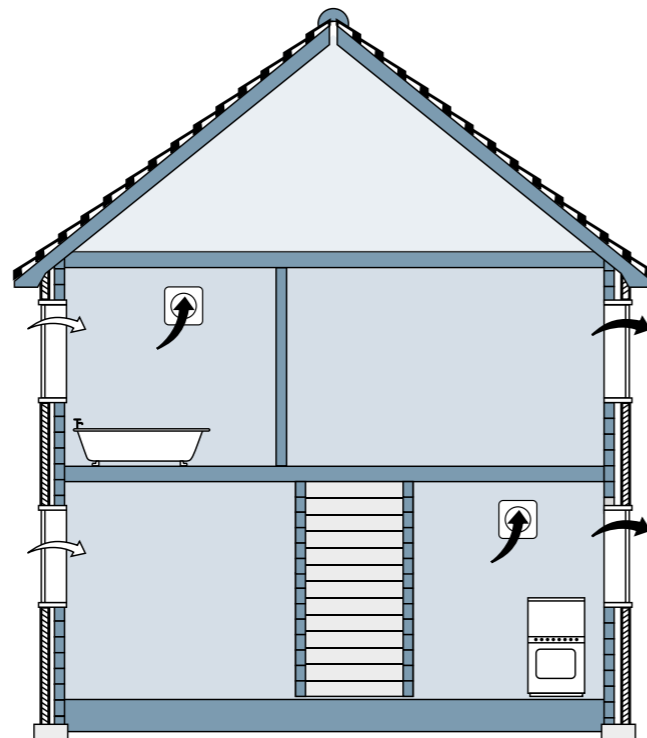

### Domestic Building Services Compliance Guide 2013 edition

Referred to in the 2013 edition of Approved Document L1A and the amended version of L1B, Conservation of Fuel and Power.

Mechanical ventilation systems should be designed to minimise electric fan power. The specific fan power (SFP) should not be worse than:

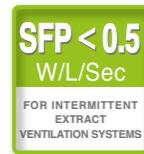

© Crown copyright



# Building Regulations - System 2

## Passive Stack Ventilation

Approved Document F1: 2010 England and Wales (with amendments in 2013)

Room	Internal Duct Diameter (mm)	Internal Cross Sectional Area (mm <sup>2</sup> )
Kitchen	125	12,000
Utility Room	125	12,000
Bathroom	125	12,000
Sanitary Accommodation	125	12,000

A PSV System provides continuous ventilation. The driving force being the “stack effect” and the “wind effect”. (Hot air rises and the wind passing over the outlet helps to draw the air out of the building).

- Only need Background Vents in dry rooms.
- Separate ducts must be taken from each wet room.
- Ducts should ideally use no more than one offset (i.e. no more than two bends).
- Offsets should be no more than 45°.
- Placing the outlet terminal at the ridge of the roof is the preferred option.
- If the outlet is more than 0.5 metre from the roof ridge it must extend to at least ridge height.

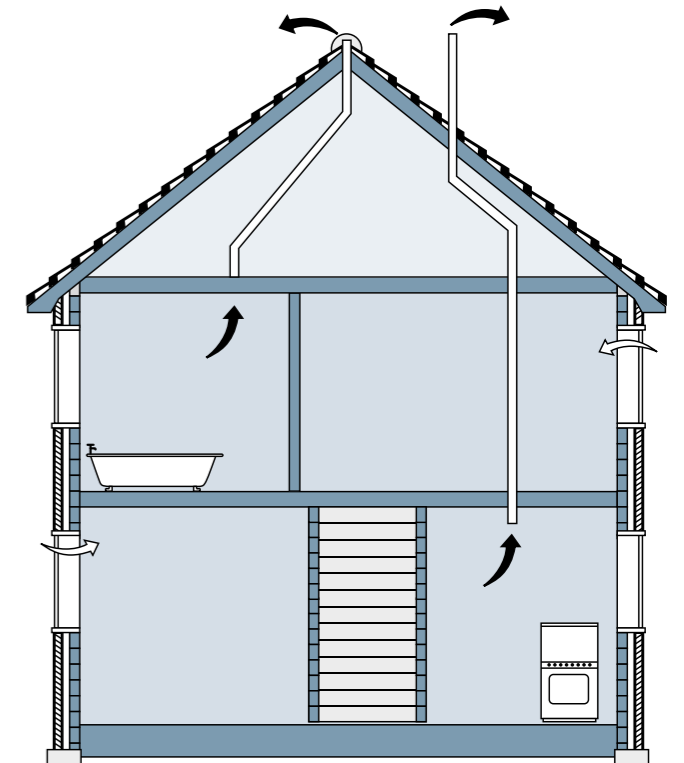

© Crown copyright

# Building Regulations - System 3

## Continuous Mechanical Ventilation

Approved Document F1: 2010 England and Wales (with amendments in 2013)

Room	Continuous Extract Rate
Kitchen	13 l/sec
Utility Room	8 l/sec
Bathroom	8 l/sec
Sanitary Accommodation	6 l/sec

- Background Vents in dry rooms only.
- Extracts continuously at a low rate and incorporates a boost facility to extract pollutants at a higher rate as required.
- Can be controlled either;
  - Manually boosted via multiple switches.
  - Automatically boosted, typically via humidity, CO<sub>2</sub> motion or other sensors.
- Normally sited remotely in a loft space or cupboard and ducted via rigid or semi rigid duct to outside air using the most economical route.
- Replacement air enters the building via background ventilators, typically in the form of window vents located in the head of window frames or walls. These should be fitted in each habitable room except wet rooms from which air is extracted.

### Domestic Building Services Compliance Guide 2013 edition

Referred to in the 2013 edition of Approved Document L1A and the amended version of L1B, Conservation of Fuel and Power.

Mechanical ventilation systems should be designed to minimise electric fan power. The specific fan power (SFP) should not be worse than:

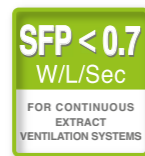

© Crown copyright

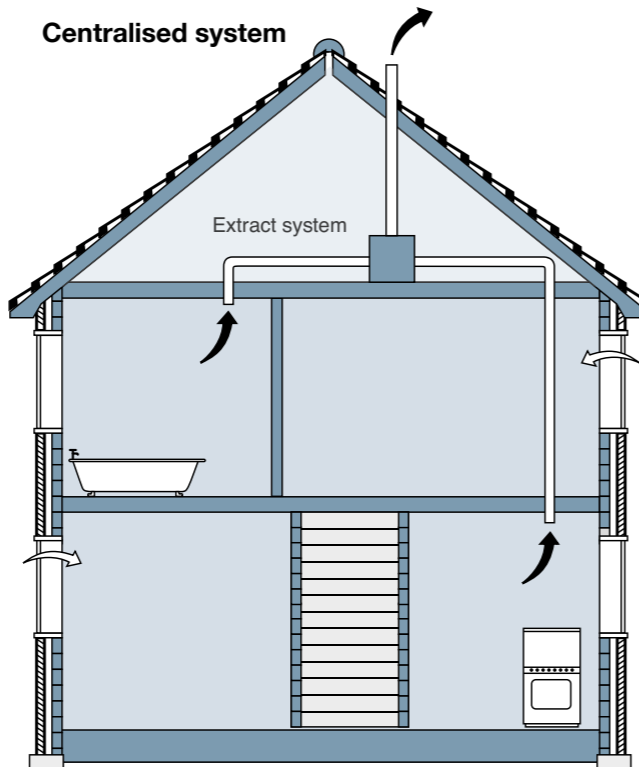

dMEV de-centralised system

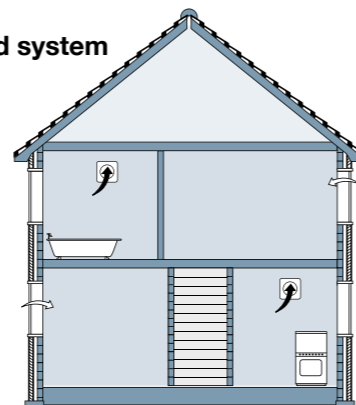

# Building Regulations - System 4

## Continuous Mechanical Supply and Extract with Heat Recovery

Approved Document F1: 2010 England and Wales (with amendments in 2013)

Room	Continuous Extract Rate
Kitchen	13 l/sec
Utility Room	8 l/sec
Bathroom	8 l/sec
Sanitary Accommodation	6 l/sec

- Supplies & extracts air continuously at a low rate and incorporates a boost facility to extract pollutants and supply fresh outdoor air at a higher rate as required.
  - Can be controlled either;
    - Manually boosted via multiple switches.
    - Automatically boosted, typically via humidity, CO<sub>2</sub> motion or other sensors.
- These should be clearly marked and located in an accessible location in or near the wet rooms.
- Normally sited in a cupboard or insulated loft and ducted via rigid duct to outside air.
  - Replacement air is dealt with by balanced supply and extract.

### Domestic Building Services Compliance Guide 2013 edition

Referred to in the 2013 edition of Approved Document L1A and the amended version of L1B, Conservation of Fuel and Power.

Mechanical ventilation systems should be designed to minimise electric fan power. The specific fan power (SFP) should not be worse than:



© Crown copyright

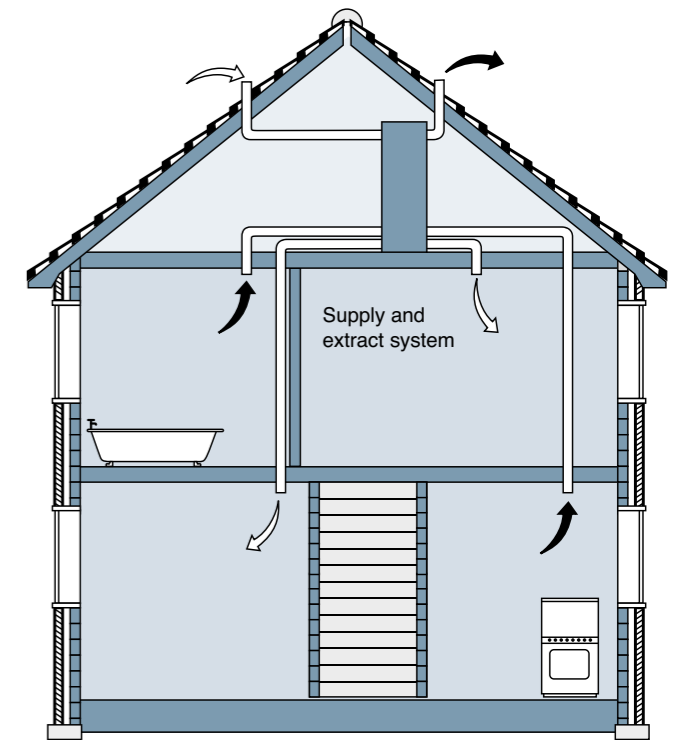

# Selection Software

## Fan Selection Software

Airflow Selectair selection software allows the user to select products from our Domestic, Commercial and Industrial fan ranges and also select from our Heat Recovery range suitable for their application. The software is hosted within the Airflow website.



Visit: [airflow.com/selectair](http://airflow.com/selectair)

## Residential Fans

Selectair software has been designed to ensure that products are selected to fulfil the requirements of your application. By following a logical and easy to use sequence fans are listed which are suitable for the room of your choice, through the wall or ducted installation and the type of ducting you will be using.

By automatically calculating the pressure drop values for your requirement, a choice of products are linked to ensure "installed performance" criteria is met. This gives the specifier the confidence to know that choosing a fan from the products offered will deliver the performance expected to meet the latest building regulations for fast, effective ventilation.

# Selection Software



Home page



## Industrial Fans

By inputting air flow and system pressure values the software searches the fan performance curves of our product range and offers a selection of suitable products to meet the requirement.

Dependant upon the application, a fan of appropriate size, noise level and performance can then be chosen to meet the application required.



Residential Fans selection choice from input data to meet criteria

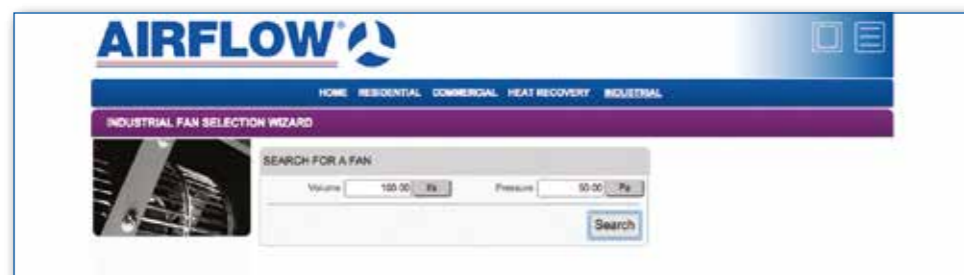



# Residential Fans



## Why Ventilate?

**AIRFLOW fans meet/exceed the requirements of the latest Building Regulations helping to combat the harmful effects of dampness and condensation and by extracting airborne pollutants such as odours, cooking smells,**

**humid and stale air. The potential hazards to health for occupants and possible damage to the fabric of the building can be largely eliminated.**

## Short key Functions



**SWITCHING**

Fan operates by remote switch

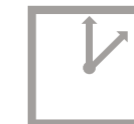

**TIMER**

Adjustable timer overrun



**PULLCORD**

Manual on/off control by integral pull cord



**MOTION SENSOR**

Passive infra red activation



**CONTINUOUS VENTILATION**

Continuous ventilation at trickle speeds



**2 MINS**

Delay start for 2 minutes



**TWO SPEED**

Two speed operation



**SELV**

Safety Extra Low Voltage



**HUMIDITY**

Adjustable humidity setting

# Aura eco 100

Toilet, en-suite and bathroom ventilation



## Key Features

- Axial fan
- Ventilation up to 70 m<sup>3</sup>/hr
- Slim compact styling
- Quick and easy to fit
- Quiet - 26 dB(A)
- Low watt motor - 5.6w
- Low SFP - 0.29 W/l/s
- Compatible with 100mm ducting
- IPX4 rating
- Complies with Building Regulations
- 3 year warranty



## Aura eco 100

Highly reliable, low energy fan in a modular design for ease of installation and maintenance. The Aura eco 100 is designed to provide quiet extraction in a suitable application.

The fan comes in various control options and is recessed into the wall. The Aura range of fans are slim, compact, attractively styled, are easy to wipe clean and are ideal for through the wall installations.



## Models

<b>Basic</b>	Control by Remote Switch
<b>Timer</b>	Timer can be set to run on between 2 and 30 minutes
<b>Humidity Timer</b>	Humidity sensor can be set between 60 - 90% RH
<b>Motion Sensor Timer</b>	PIR sensor activates fan



## Technical Data

Specification	Aura eco 100B	Aura eco 100T	Aura eco 100HT	Aura eco 100MST
Air flow m <sup>3</sup> /hr / l/sec	70 / 19	70 / 19	70 / 19	70 / 19
Fan type	Axial	Axial	Axial	Axial
Controls	Basic	Timer	Humidity Timer	Motion Sensor Timer
Mounting	Wall / Ceiling	Wall / Ceiling	Wall / Ceiling	Wall / Ceiling
Sound pressure dB(A)@3m	26	26	26	26
Power watts	5.6	5.6	5.6	5.6
Amps	0.035	0.035	0.035	0.035
Specific Fan Power (SFP)	0.29	0.29	0.29	0.29
Duct diameter (mm)	100	100	100	100
Voltage	230v / 1ph / 50-60Hz	230v / 1ph / 50-60Hz	230v / 1ph / 50-60Hz	230v / 1ph / 50-60Hz
Rating	IPX4	IPX4	IPX4	IPX4
Material finish	Plastic	Plastic	Plastic	Plastic
Weight (kg)	0.56	0.56	0.56	0.56
Dimensions (H x W x D) mm	150 x 150 x 102	150 x 150 x 102	150 x 150 x 102	150 x 150 x 102
Part No.	9041347	9041348	9041349	9041350

## Dimensions (mm)

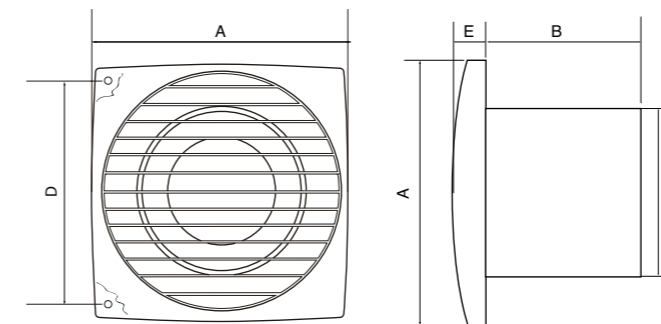

Model	A	B	C	D	E
Aura eco 100	150	102	100	122	17

## Performance

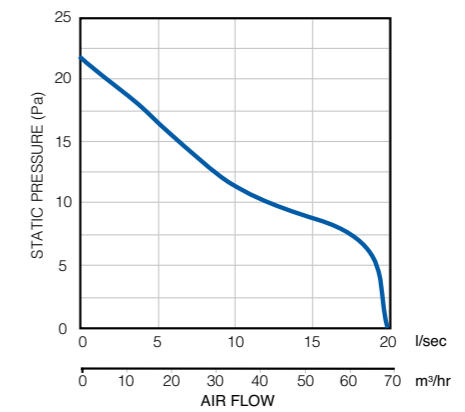

## Controls and Accessories

A range of accessories including flexible and rigid ducting kits, controls, switches and grilles are available.

See accessories section from page 209 for more details.

# Aura eco 125

Toilet, en-suite and bathroom ventilation



## Key Features

- Axial fan
- Ventilation up to 115 m<sup>3</sup>/hr
- Slim compact styling
- Quick and easy to fit
- Quiet - 31 dB(A)
- Low watt motor - 9.3w
- Low SFP - 0.3 W//s
- Compatible with 125mm ducting
- IPX4 rating
- Complies with Building Regulations
- 3 year warranty

## Aura eco 125

Highly reliable, low energy fan in a modular design for ease of installation and maintenance. The Aura eco 125 is designed to provide quiet extraction in a suitable application.

The fan comes in various control options and is recessed into the wall. The Aura range of fans are slim, compact, attractively styled, are easy to wipe clean and are ideal for through the wall installations.



## Models

<b>Basic</b>	Control by Remote Switch
<b>Timer</b>	Timer can be set to run on between 2 and 30 minutes
<b>Humidity Timer</b>	Humidity sensor can be set between 60 - 90% RH
<b>Motion Sensor Timer</b>	PIR sensor activates fan



## Technical Data

Specification	Aura eco 125B	Aura eco 125T	Aura eco 125HT	Aura eco 125MST
Air flow m <sup>3</sup> /hr / l/sec	115 / 31	115 / 31	115 / 31	115 / 31
Fan type	Axial	Axial	Axial	Axial
Controls	Basic	Timer	Humidity Timer	Motion Sensor Timer
Mounting	Wall / Ceiling	Wall / Ceiling	Wall / Ceiling	Wall / Ceiling
Sound pressure dB(A)@3m	31	31	31	31
Power watts	9.3	9.3	9.3	9.3
Amps	0.060	0.060	0.060	0.060
Specific Fan Power (SFP)	0.30	0.30	0.30	0.30
Duct diameter (mm)	125	125	125	125
Voltage	230v / 1ph / 50-60Hz	230v / 1ph / 50-60Hz	230v / 1ph / 50-60Hz	230v / 1ph / 50-60Hz
Rating	IPX4	IPX4	IPX4	IPX4
Material finish	Plastic	Plastic	Plastic	Plastic
Weight (kg)	0.7	0.7	0.7	0.7
Dimensions (H x W x D) mm	176 x 176 x 104	176 x 176 x 104	176 x 176 x 104	176 x 176 x 104
Part No.	90000532	90000533	90000534	90000535

## Dimensions (mm)

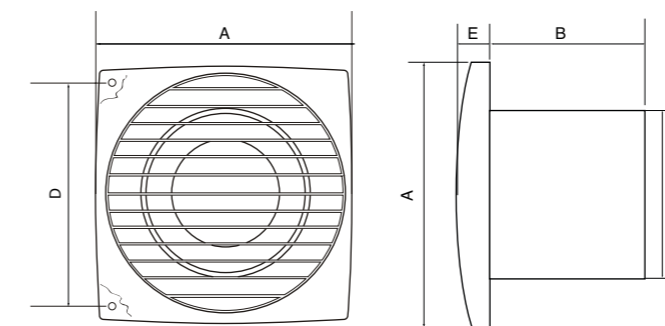

Model	A	B	C	D	E
Aura eco 125	176	87	125	144	19

## Performance

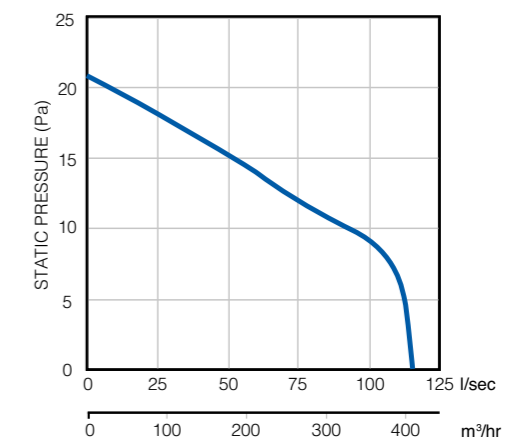

## Controls and Accessories

A range of accessories including flexible and rigid ducting kits, controls, switches and grilles are available.

See accessories section from page 209 for more details.

# Aura eco 150

Larger bathroom, utility room and kitchen ventilation (adjacent to hob)

## Key Features



- Axial fan
- Ventilation up to 235 m<sup>3</sup>/hr
- Slim compact styling
- Quick and easy to fit
- Quiet - 35 dB(A)
- Low watt motor - 20w
- Low SFP - 0.31 W/l/s
- Compatible with 150mm ducting
- IPX4 rating
- Complies with Building Regulations
- 3 year warranty



## Aura eco 150 range

Highly reliable, low energy fan in a modular design for ease of installation and maintenance. The Aura eco 150 is designed to provide quiet extraction in a suitable application.

The fan comes in various control options and is recessed into the wall or ceiling. The Aura range of fans are slim, compact, attractively styled, are easy to wipe clean and can be ducted over short lengths.



## Models

<b>Basic</b>	Control by Remote Switch
<b>Timer</b>	Timer can be set to run on between 2 and 30 minutes
<b>Humidity Timer</b>	Humidity sensor can be set between 60 - 90% RH
<b>Motion Sensor Timer</b>	PIR sensor activates the fan



## Technical Data

Specification	Aura eco 150B	Aura eco 150T	Aura eco 150HT	Aura eco 150MST
Air flow m <sup>3</sup> /hr / l/sec	235 / 65	235 / 65	235 / 65	235 / 65
Fan type	Axial	Axial	Axial	Axial
Controls	Basic	Timer	Humidity Timer	Motion Sensor Timer
Mounting	Wall / Ceiling	Wall / Ceiling	Wall / Ceiling	Wall / Ceiling
Sound pressure dB(A)@3m	35	35	35	35
Power watts	20	20	20	20
Amps	0.14	0.14	0.14	0.14
Specific Fan Power (SFP)	0.31	0.31	0.31	0.31
Duct diameter (mm)	150	150	150	150
Voltage	230v / 1ph / 50-60Hz	230v / 1ph / 50-60Hz	230v / 1ph / 50-60Hz	230v / 1ph / 50-60Hz
Rating	IPX4	IPX4	IPX4	IPX4
Material finish	Plastic	Plastic	Plastic	Plastic
Weight (kg)	0.9	0.9	0.9	0.9
Dimensions (H x W x D) mm	205 x 205 x 124	205 x 205 x 124	205 x 205 x 124	205 x 205 x 124
Part No.	9041351	9041352	9041353	9041354

## Dimensions (mm)

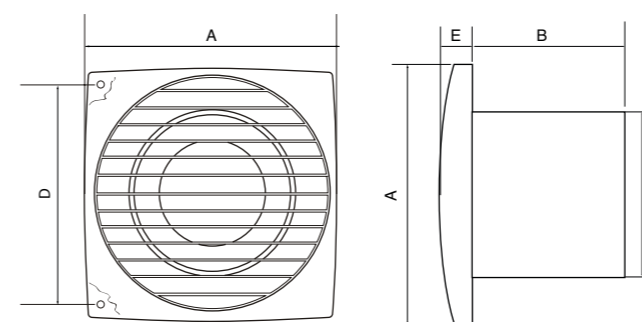

Model	A	B	C	D	E
Aura eco 150	205	124	150	174	19

## Performance

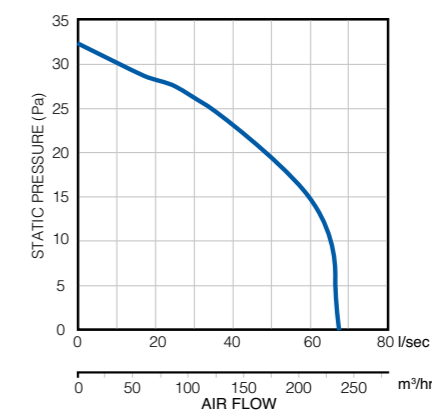

## Controls and Accessories

A range of accessories including flexible and rigid ducting kits, controls, switches and grilles are available.

See accessories section from page 209 for more details.

# Aura In-Line

Toilet, en-suite and bathroom ventilation



## Key Features

- Axial in-line fan
- Ventilation up to 108 m³/hr
- Designed for ventilation of small and medium size rooms
- Use for both supply or extraction
- Compact and quiet in operation
- Mounting bracket included
- Ductable
- IPX4 rating
- 3 year warranty

The Aura in-line fan comes with a fixing bracket and is compact, attractively styled and ductable over short lengths. They are the ideal solution for removing damp moist air, odours and airborne pollutants from toilets and bathrooms.

 ALWAYS PULL FLEXIBLE DUCTING TAUGHT TO ENSURE INSTALLED PERFORMANCE AIR FLOW.

## Aura In-Line range

Highly reliable fan in a modular design for ease of installation and maintenance. Aura In-Line Fans are designed to provide extraction levels that comply with the latest Building Regulations.

The fans are manually operated by a remote switch (switch not supplied). Timer control versions are also available. Install in-line with ducting for a quiet and discreet installation.



## Models

- Basic** Control by Remote Switch
- Timer** Timer can be set to run on between 2 and 30 minutes



## Technical Data

Specification	Aura In-Line 100B	Aura In-Line 100T
Air flow m³/hr* / l/sec*	108 / 30	108 / 30
Fan type	Axial	Axial
Controls	Basic	Timer
Mounting	In-Line	In-Line
Sound pressure dB(A)@3m	39	39
Power watts	16	16
Amps	0.1	0.1
Specific Fan Power (SFP)	0.53	0.53
Duct diameter (mm)	100	100
Voltage	230v / 1ph / 50Hz	230v / 1ph / 50Hz
Rating	IPX4	IPX4
Material finish	ABS	ABS
Weight (kg)	0.41	0.41
Dimensions (H x W x D) mm	110 x 160 x 113	110 x 160 x 113
Part No.	9041355	9041356

\* Air flow at free discharge

## Dimensions (mm)

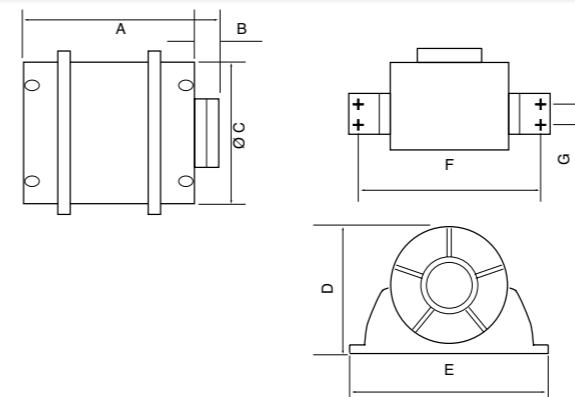

Model	A	B	C	D	E	F	G
Aura in-line 100	85	28	100	110	160	144	29

## Performance

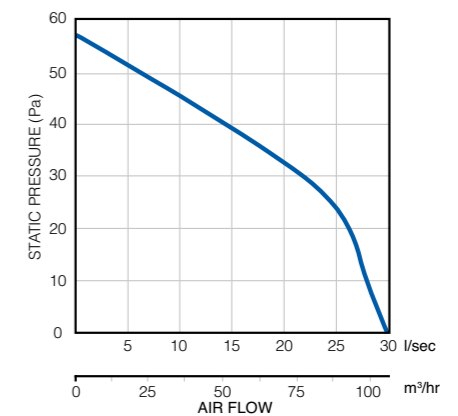

## Controls and Accessories

A range of accessories including flexible and rigid ducting kits, controls, switches and grilles are available.

See accessories section from page 209 for more details.

# Aura Shower Kit

Shower ventilation



## Key Features

- Axial in-line fan
- Ventilation up to 108 m<sup>3</sup>/hr
- Designed for ventilation / lighting above shower cubicles
- Use for both supply or extraction
- Compact and quiet in operation
- Mounting bracket included
- Ductable
- Halogen lamp option
- IPX4 rating
- 3 year warranty

## Aura Shower Kit range

Highly reliable fan in a modular design for ease of installation and maintenance. Aura In-Line Fans are designed to provide extraction levels that comply with the latest Building Regulations.

The fans are manually operated by a remote switch (switch not supplied). Timer control versions are also available. Install in-line with ducting for a quiet and discreet installation.

The Aura in-line fan comes with a fixing bracket and is compact, attractively styled and ideal for short duct runs. They are the ideal solution for removing damp moist air, odours and airborne pollutants from toilets and bathrooms.



ALWAYS PULL FLEXIBLE DUCTING TAUGHT TO ENSURE INSTALLED PERFORMANCE AIR FLOW.



## Models

- Basic** Control by Remote Switch
- Timer** Timer can be set to run on between 2 and 30 minutes

## Contents of Kits

- 9041420** Aura 100B, 3m flex duct, ties, extract valve, external grille
- 9041419** Aura 100T, 3m flex duct, ties, extract valve, external grille
- 9041422** Aura 100B, 3m flex duct, ties, halogen lamp + chrome and white grilles, external grille
- 9041421** Aura 100T, 3m flex duct, ties, halogen lamp + chrome and white grilles, external grille



## Technical Data

Specification	Aura Shower Kit	Aura T Shower Kit	Aura Shower Kit with Hallogen Lamp	Aura T Shower Kit with Hallogen Lamp
Air flow m <sup>3</sup> /hr* / l/sec*	108 / 30	108 / 30	108 / 30	108 / 30
Fan type	Axial	Axial	Axial	Axial
Controls	Basic	Timer (adjustable)	Basic	Timer (adjustable)
Mounting	In-Line	In-Line	In-Line	In-Line
Sound pressure dB(A)@3m	39	39	39	39
Power watts	16	16	16	16
Amps	0.01	0.01	0.01	0.01
Specific Fan Power (SFP)	0.53	0.53	0.53	0.53
Duct diameter (mm)	100	100	100	100
Voltage	230v / 1ph / 50Hz	230v / 1ph / 50Hz	230v / 1ph / 50Hz	230v / 1ph / 50Hz
Rating	IPX4	IPX4	IPX4	IPX4
Material finish	ABS	ABS	ABS	ABS
Weight (kg)	0.41	0.41	0.41	0.41
Dimensions (H x W x D) mm	110 x 160 x 113	110 x 160 x 113	110 x 160 x 113	110 x 160 x 113
Part No.	<b>9041420</b>	<b>9041419</b>	<b>9041422</b>	<b>9041421</b>

\* Air flow at free discharge

## Dimensions (mm)

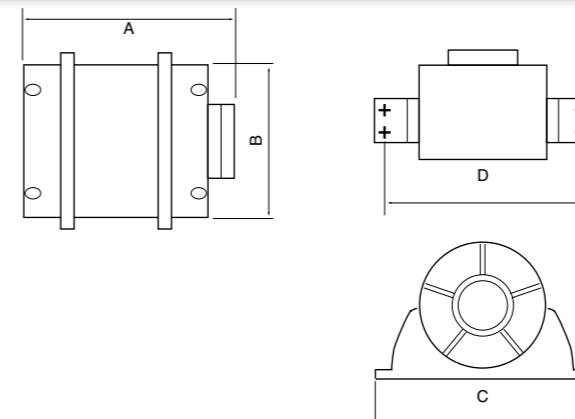

Model	A	B	C	D
Aura shower kit	110	113	160	144

## Performance

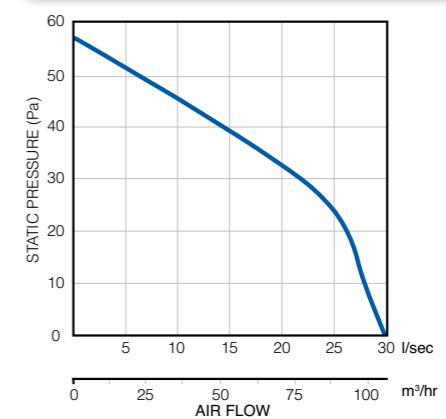

## Controls and Accessories

A range of accessories including flexible and rigid ducting kits, controls, switches and grilles are available.

See accessories section from page 209 for more details.

# Aura Smart

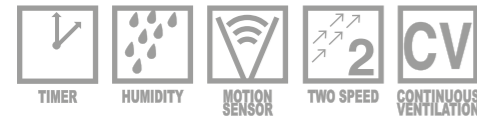

## Key Features

- Two speed axial fan
- Flow rate up to 133 m<sup>3</sup>/hr
- Interchangeable spigots - 100/125mm
- Modern compact styling - optional front covers to match décor
- Quick and easy to fit
- A separate remote controller
- Versatile positioning - portrait or landscape
- Exceptionally quiet - 21 dB(A)
- Energy efficient low watt motor - 3.8W
- Advanced controls for ultimate user comfort
- Universal voltage 100/240v - 50/60Hz
- IP44 rating
- Complies with Building Regulations
- 5 year warranty

## Aura Smart

The Aura Smart is an innovative low energy axial fan with a unique design for ease of installation and maintenance. The fan is extra slim and with optional colour covers available, it will blend perfectly into the décor of any room. The fan is suitable for mounting anywhere outside of Zone 2 of your wetroom.

The fan comes with interchangeable spigots giving the user the option to use 100mm or 125mm ducting and increase the flow rate accordingly.

This smart fan is available with either humidity timer control or motion sensor humidity timer control giving the user the benefit of achieving the perfect micro climate within their home. Aura Smart has a one-touch control panel beneath the cover for control of the fan. A separate remote controller is also included for convenient control of all the functions – it's a Smart Fan!

Interval ventilation occurs automatically every 15 hours for a period of 2 hours - this ensures regular movement of the air and keeps the room fresh.



## Models

**Humidity Timer** Humidity sensor activates fan - if humidity rises by less than 20% within 10 minutes, run on time reverts to 15 minutes instead of the preset rates of 30, 45 or 60 minutes.

**Motion Sensor Humidity Timer** PIR sensor activates fan to switch on - overrun timer kicks in - can be set at 5, 15 or 30 minutes. If humidity sensor activates the fan – run on time, to clear humidity can be set at 30, 45 or 60 minutes. If the humidity rises by less than 20% in 10 minutes the overrun time will revert to 15 minutes.



## Technical Data

Specification	Aura Smart HT		Aura Smart MSHT		Covers		
	100mm	125mm	100mm	125mm	HT	Colour	MSHT
Spigot size	100mm	125mm	100mm	125mm	90000386	Marble	90000416
Air flow m <sup>3</sup> /hr*	72 / 106	83 / 133	72 / 106	83 / 133	90000387	Silver	90000417
Air flow l/sec*	20 / 29	23 / 37	20 / 29	23 / 37	90000388	Champagne	90000418
Fan type	Axial		Axial		90000389	Red	90000419
Controls	Humidity Timer		Motion Sensor Humidity Timer		90000390	Mauve	90000420
Mounting	Wall		Wall		90000391	Graphite	90000421
Sound pressure dB(A)@3m	22 / 31	21 / 32	22 / 31	21 / 32	90000392	Black	90000422
Adjustable delay start (min)	0, 2, 5		0, 2, 5				
Adjustable timer (min)	5, 15, 30		5, 15, 30				
Adjustable timer on humidity activation (min)	30, 45, 60		30, 45, 60				
Interval timer, auto start (hrs)	15		15				
Power watts	Up to 3.8		Up to 3.8				
Specific Fan Power (SFP)	0.13	0.1	0.13	0.1			
Building Regulations ADF	Yes		Yes				
Voltage	100-240V/50-60Hz		100-240V/50-60Hz				
Rating	IP44		IP44				
Weight (Kg)	0.63		0.63				
Dimensions (H x W x D)mm	206x152x86		206x152x86				
Part No.	90000384		90000385				



\* Air flow at free discharge

## Dimensions (mm)

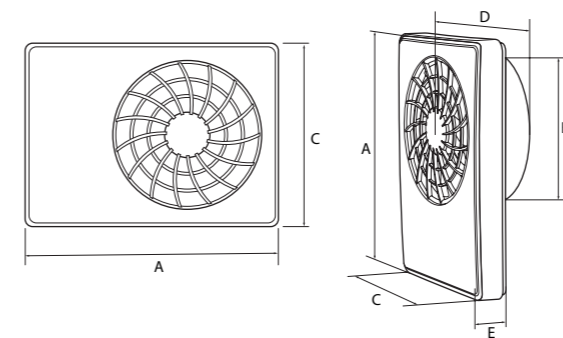

Model	A	B	C	D	E
Aura Smart	206	100/125	152	57	29

## Performance

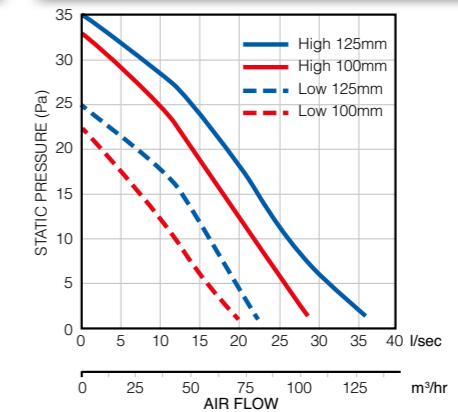

## Controls and Accessories

A range of accessories including flexible and rigid ducting kits, controls, switches and grilles are available.

See accessories section from page 209 for more details.

# QuietAir QT100

Toilet, bathroom and en-suite ventilation



## Key Features

- Axial fan
- Two speed ventilation up to 90 m<sup>3</sup>/hr\*
- Awarded Quiet Mark by Noise Abatement Society
- Extremely quiet, noise levels as low as 25 dB(A)
- Power consumption from only 5w
- Interval timer for routine auto extraction
- Very low SFP of 0.24 W/l/s
- Long life ball-bearing motor 40,000 hours
- Integral flow straightener / backdraught flap
- Powerful extraction for longer ducts
- Suitable for installation anywhere in Zone 1 of bathrooms when installed with an RCD
- IP45 rating
- Complies with Building Regulations
- 3 year warranty



## QT100 range

The whisper quiet QuietAir QT100 is designed to provide powerful extraction levels that exceed the requirements of the latest Building Regulations.

The QuietAir QT100 is the quietest fan available complying with Building Regulations "Installed Performance" requirements when ducted.

QuietAir is a range of elegant, discreet axial fans that are extremely quiet with various control options that activate the fan only when needed – remote switching,

timer, humidity timer and motion sensor with timer. By using exceptionally low energy this helps to reduce carbon emissions and also save on your energy bills. It has a high efficiency impeller for extraction through up to 12m of rigid ducting and still complies with the Building Regulations.

Room refresh (interval timer) enables automatic extraction at pre-set times if required.



## Models

Basic	Control by remote switch
Timer	Timer can be set to run on for 6,10,15 or 21 minutes
Humidity Timer	Humidity sensor can be set between 60 - 90% RH
Motion Sensor Timer	PIR sensor activates fan



## Technical Data

Specification	QuietAir QT100B	QuietAir QT100T	QuietAir QT100HT	QuietAir QT100MST
Air flow m <sup>3</sup> /hr*	75 / 90	75 / 90	75 / 90	75 / 90
Air flow l/sec*	21 / 25	21 / 25	21 / 25	21 / 25
Fan type	Axial	Axial	Axial	Axial
Controls	Basic	Timer	Humidity Timer	Motion Sensor Timer
Mounting	Wall / Ceiling	Wall / Ceiling	Wall / Ceiling	Wall / Ceiling
Sound pressure dB(A)@3m	25/30	25/30	25/30	25/30
Delay start (min)	No	2	2	No
Adjustable timer (min)	No	6,10,15,21	6,10,15,21	15
Adjustable humidity (%RH)			60 - 90	
Interval timer, auto start (hrs)		0,8,12,24		
Power watts	5/9	5/9	5/9	5/9
Amps	0.04/0.06	0.04/0.06	0.04/0.06	0.04/0.06
Specific Fan Power (SFP)	0.24	0.24	0.24	0.24
Building Regulations ADF	Yes	Yes	Yes	Yes
Duct Diameter (mm)	100	100	100	100
Voltage	230v / 1ph / 50-60Hz	230v / 1ph / 50-60Hz	230v / 1ph / 50-60Hz	230v / 1ph / 50-60Hz
Rating	IP45	IP45	IP45	IP45
Max ambient temperature	40°C	40°C	40°C	40°C
Weight (kg)	0.8	0.8	0.8	0.8
Dimensions (H x W x D) mm	147 x 147 x 131	147 x 147 x 131	147 x 147 x 131	147 x 147 x 131
Part No.	9041259	9041260	9041261	9041262

\* 2nd Speed activated by remote switch

## Dimensions (mm)

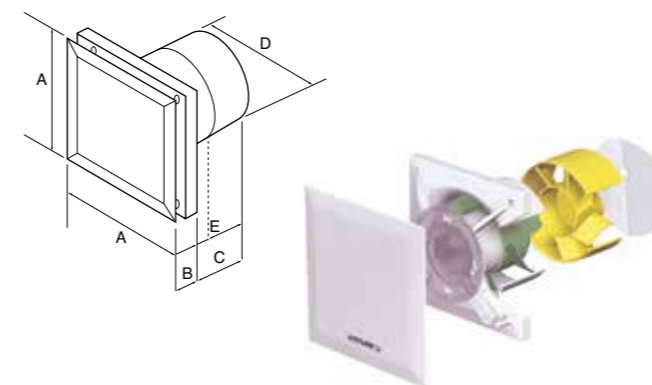

Model	A	B	C	D	E
QuietAir QT100	147	35	96	98	52

## Performance

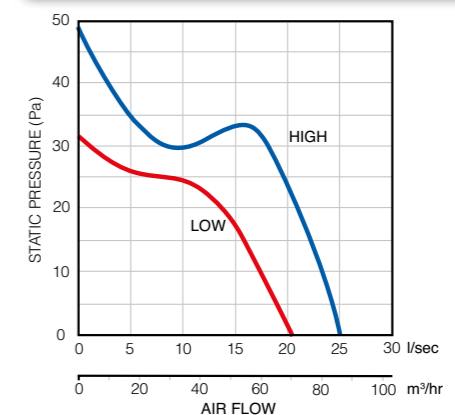

## Controls and Accessories

A range of accessories including flexible and rigid ducting kits, controls, switches and grilles are available.

See accessories section from page 209 for more details.



# QuietAir QT120

Toilet, bathroom, utility room and kitchen (adjacent to hob)

## Key Features

- Axial fan
- Two speed ventilation up to 170 m<sup>3</sup>/hr\*
- Awarded Quiet Mark by Noise Abatement Society
- Quiet, noise level as low as 32 dB(A)
- Power consumption from only 10w
- Very low SFP of 0.24 W/l/s, IP45 rating
- Interval timer for routine auto extraction
- Long life ball-bearing motor 40,000 hours
- Integral flow straightener / backdraught flap
- Powerful extraction for longer ducts
- Suitable for installation anywhere in Zone 1 of bathrooms when installed with an RCD
- Install in a kitchen adjacent to the hob
- Complies with Building Regulations
- 3 year warranty



## QT120 range

The powerful performance QuietAir 120 is designed to provide extraction levels that exceed the requirements of the latest Building Regulations.

QuietAir, is a range of elegant, discreet axial fans that are supremely quiet. By using exceptionally low energy they help to reduce carbon emissions but also save on your electricity bill.

Operated by a range of control options including basic switching, timer, humidity and motion sensor control.

Room refresh (interval timer) enables automatic extraction at pre-set times if required.



## Models

<b>Basic</b>	Control by remote switch
<b>Timer</b>	Timer can be set to run on for 6,10,15 or 21 minutes
<b>Humidity Timer</b>	Humidity sensor can be set between 60 - 90% RH
<b>Motion Sensor Timer</b>	PIR sensor activates fan



## Technical Data

Specification	QuietAir QT120B	QuietAir QT120T	QuietAir QT120HT	QuietAir QT120MST
Air flow m <sup>3</sup> /hr*	150 / 170	150 / 170	150 / 170	150 / 170
Air flow l/sec*	42 / 47	42 / 47	42 / 47	42 / 47
Fan type	Axial	Axial	Axial	Axial
Controls	Basic	Timer	Humidity Timer	Motion Sensor Timer
Mounting	Wall / Ceiling	Wall / Ceiling	Wall / Ceiling	Wall / Ceiling
Sound pressure dB(A)@3m	32/36	32/36	32/36	32/36
Delay start (min)	No	2	2	No
Adjustable timer (min)	No	6,10,15,21	6,10,15,21	15
Adjustable humidity (%RH)	-	-	60 - 90	-
Interval timer, auto start (hrs)	-	0,8,12,24	-	-
Power watts	10/13	10/13	10/13	10/13
Amps	0.08/0.09	0.08/0.09	0.08/0.09	0.08/0.09
Specific Fan Power (SFP)	0.24	0.24	0.24	0.24
Building Regulations ADF	Yes	Yes	Yes	Yes
Duct Diameter (mm)	125	125	125	125
Voltage	230v / 1ph / 50-60Hz	230v / 1ph / 50-60Hz	230v / 1ph / 50-60Hz	230v / 1ph / 50-60Hz
Rating	IP45	IP45	IP45	IP45
Max ambient temperature	40°C	40°C	40°C	40°C
Weight (kg)	1.05	1.05	1.05	1.05
Dimensions (H x W x D) mm	176 x 176 x 155	176 x 176 x 155	176 x 176 x 155	176 x 176 x 155
Part No.	9041497	9041498	9041499	9041500*

\* 2nd Speed activated by remote switch

## Dimensions (mm)

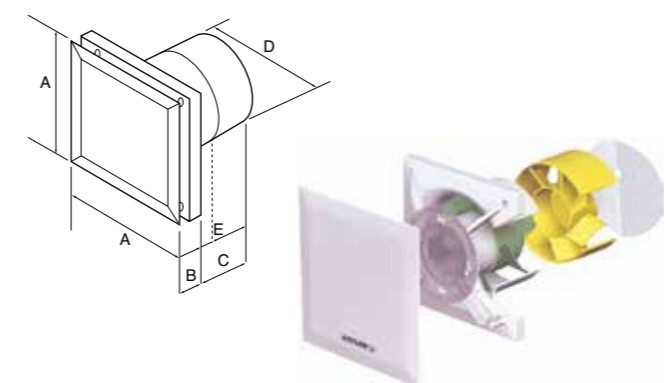

Model	A	B	C	D	E
QuietAir QT120	176	39	116	118	70

## Performance

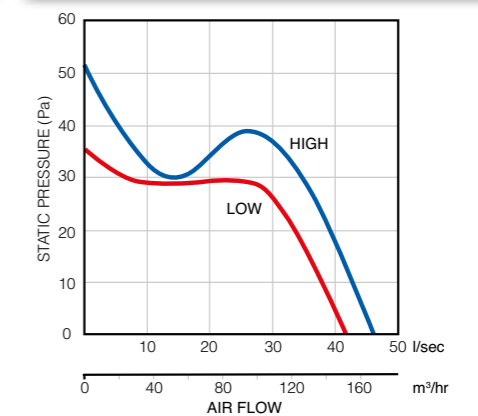

## Controls and Accessories

A range of accessories including flexible and rigid ducting kits, controls, switches and grilles are available.

See accessories section from page 209 for more details.



# QuietAir QT150

Kitchen



## Key Features

- Axial fan
- Two speed ventilation up to 260 m<sup>3</sup>/hr
- Quiet, noise level as low as 35 dB(A)
- Power consumption from only 6w
- Very low SFP of 0.09 W/l/s, IP45 rating
- Interval timer for routine auto extraction
- Long life ball-bearing motor 40,000 hours
- Integral flow straightener / backdraught flap
- Powerful extraction for longer ducts
- Variable speed control version
- Install in a kitchen / light commercial
- Complies with Building Regulations
- 3 year warranty



## QT150 range

The powerful performance QuietAir 150 is designed to provide extraction levels that exceed the requirements of the latest Building Regulations. Ideal for kitchens and larger rooms.

QuietAir, is a range of elegant, discreet axial fans that are supremely quiet. By using exceptionally low energy they help to reduce carbon emissions but also save on your electricity bill.

Operated by a range of control options including basic switching, timer, humidity and variable speed control.

Room refresh (interval timer) enables automatic extraction at pre-set times if required.



## Models

<b>Basic</b>	Control by remote switch
<b>Timer</b>	Timer can be set to run on for 6,10,15 or 21 minutes
<b>Humidity Timer</b>	Humidity sensor can be set between 60 - 90% RH
<b>Variable speed</b>	Controlled by remote switch



## Technical Data

Specification	QuietAir QT150B	QuietAir QT150T	QuietAir QT150HT	QuietAir QT150VS
Air flow m <sup>3</sup> /hr*	220 / 260	220 / 260	220 / 260	50 - 260
Air flow l/sec*	61 / 72	61 / 72	61 / 72	13 - 72
Fan type	Axial	Axial	Axial	Axial
Controls	Basic	Timer	Humidity Timer	Variable Speed
Mounting	Wall / Ceiling	Wall / Ceiling	Wall / Ceiling	Wall / Ceiling
Sound pressure dB(A)@3m	35/39	35/39	35/39	35/39
Delay start (sec's)	No	0,45,90,120	0,45,90,120	No
Adjustable timer (mins)	No	6,10,15,21	6,10,15,21	No
Adjustable humidity (%RH)	-	-	60 - 90	-
Interval timer, auto start (hrs)	-	0,8,12,24	-	-
Power watts	6/10	6/10	6/10	6/10
Amps	0.07/0.12	0.07/0.12	0.07/0.12	0.07/0.12
Specific Fan Power (SFP)	0.09/0.13	0.09/0.13	0.09/0.13	0.09/0.13
Building Regulations ADF	Yes	Yes	Yes	Yes
Duct Diameter (mm)	145	145	145	145
Voltage	230v / 1ph / 50Hz	230v / 1ph / 50Hz	230v / 1ph / 50Hz	230v / 1ph / 50Hz
Rating	IP45	IP45	IP45	IP45
Max ambient temperature	40°C	40°C	40°C	40°C
Weight (kg)	1.2	1.2	1.2	1.2
Dimensions (H x W x D) mm	210 x 210 x 190	210 x 210 x 190	210 x 210 x 190	210 x 210 x 190
Part No.	90000454	90000455	90000456	90000458
Variable speed controller				90000514*

\* refer to accessories section.

## Dimensions (mm)

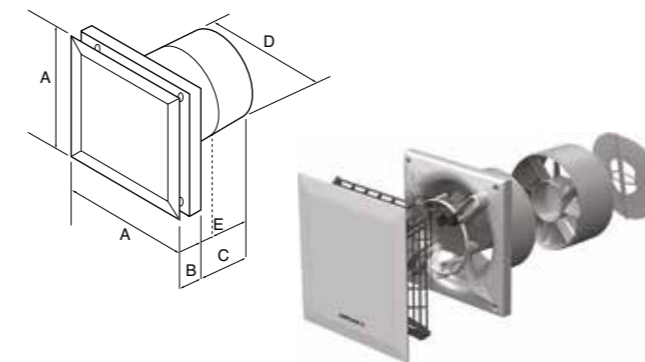

Model	A	B	C	D	E
QuietAir QT150	210	48	142	145	76

## Performance

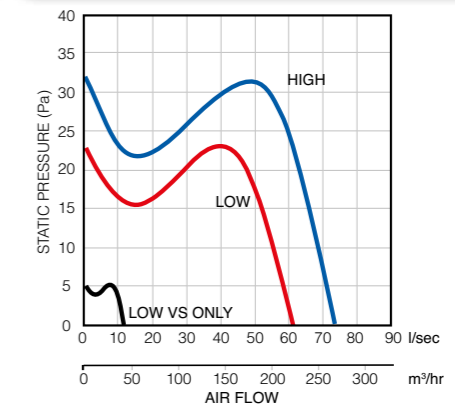

## Controls and Accessories

A range of accessories including flexible and rigid ducting kits, controls, switches and grilles are available.

See accessories section from page 209 for more details.



# Maxivent eco

Larger bathroom, utility room and kitchen



## Key Features

- Axial fan
- High performance fan up to 260 m<sup>3</sup>/hr
- Easy to fit and clean
- Can be mounted in the wall or ceiling
- Interchangeable fixing holes to easily replace most other 150mm fans
- Variable speed controller available
- Thermally protected motor
- Low watt motor 28w
- Low SFP - 0.38 W/l/s
- Silent automatic shutter
- IP45 rating
- Complies with Building Regulations
- 3 year warranty



## Maxivent eco range

Highly reliable and powerful axial fan in a modular design for ease of installation and maintenance. Maxivent is designed to provide extraction levels that comply with the latest Building Regulations.

Maxivent fans offer quiet powerful performance in units equipped with auto shutters. These stylish, modern 150mm axial fans will blend comfortably with existing décor and are quick and easy to install. They are the ideal solution for removing damp moist air, odours and airborne pollutants from kitchens and utility rooms.



## Models

<b>Pull Cord</b>	Activated by pull cord
<b>Timer</b>	Timer can be set to run on between 1 and 30 minutes
<b>Humidity Pull Cord</b>	Humidity sensor can be set between 40 - 95% RH, override with pull cord



## Technical Data

Specification	Maxivent eco P	Maxivent eco T	Maxivent eco H
Air flow m <sup>3</sup> /hr	260	260	158 / 260
Air flow l/sec	72	72	44 / 72
Fan type	Axial	Axial	Axial
Controls	Pull Cord	Timer	Humidity / Pull Cord
Mounting	Wall / Ceiling	Wall / Ceiling	Wall / Ceiling
Sound pressure dB(A)@3m	57	57	46/57
Power watts	28	28	28
Amps	2	2	2
SFP@72 l/sec	0.38	0.38	0.38
Building Regulations ADF	Yes	Yes	Yes
Duct diameter (mm)	150	150	150
Voltage	230v / 1ph / 50-60Hz	230v / 1ph / 50-60Hz	230v / 1ph / 50-60Hz
Rating	IP45	IP45	IP45
Weight (kg)	2.45	2.45	2.45
Dimensions (H x W x D) mm	225 x 225 x 105	225 x 225 x 105	225 x 225 x 105
Part No.	72678201	72678301	72678401
Variable speed controller		9041033*	

\* refer to accessories section.

## Dimensions (mm)

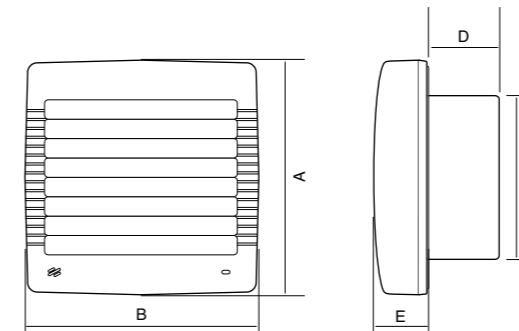

Model	A	B	C	D	E
Maxivent eco	225	225	150	60	45

## Performance

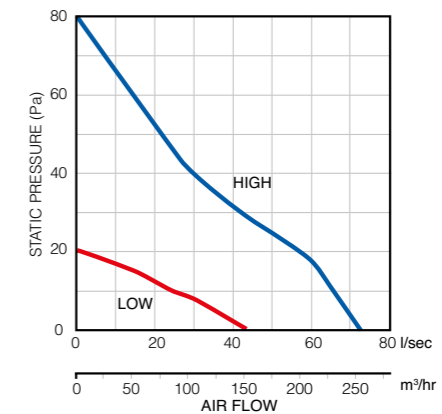

## Controls and Accessories

A range of accessories including flexible and rigid ducting kits, controls, switches and grilles are available.

See accessories section from page 209 for more details.



Unique, elegant, efficient



"A revolution in fan design. You have never seen a fan like it or installed a fan like it either"



In 2004 Airflow introduced iCON. A radical new design which brought style, colour and a new level of functionality to the bland world of boxy extractor fans.

The changes were not just cosmetic, but the results of a complete rethink of the way in which fans are designed, specified, sold and installed.

Today, as we introduce the next generation of energy saving iCON, these award winning fans remain the market leader for simplicity and style with its unique, interchangeable module concept continuing to save time and money for distributors and installers alike.

### iCON 15

iCON 15 is ideal for toilets, en-suite, shower rooms and bathrooms. Recessed into the wall or ceiling, it is stylish and unobtrusive, even in the smallest space.

### iCON 30

iCON 30 is quiet, powerful and designed for recessed or surface mounting in walls or ceilings in larger toilets, bathrooms and utility rooms.

### iCON 60

iCON 60 is the largest fan in the range, suitable for recessed or surface mounting in walls or ceilings and is highly efficient in domestic kitchens, changing areas and residents' lounges.



Chrome



Anthracite



Silver



Sandstone



Its looks aren't everything

### Installation

iCON has been designed with simplicity in mind. A quick, core drilled hole enables immediate fixing of iCON. The twist on/off cover requires only a single side entry fixing screw.

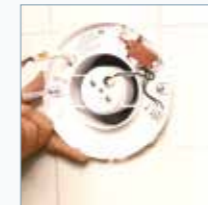

Cantilever fixing lugs enable recessed installation on uneven surfaces. iCON 30 and iCON 60 are also supplied with a narrow contour skirt for surface mounting if preferred.

The 'snap-in' module is quick to fit and wire, giving the installer a choice of controls on-site.

Modular versatility and simplicity. Select the fan, iCON 15, iCON 30, iCON 60 and add the module. Any module fits any fan.\*

\*subject to voltage

- Simple twist on/off cover mechanism
- Cantilever lugs to facilitate uneven surfaces
- 'Snap-in' interchangeable module, quick to fit and wire
- Fit the control module required for the particular job

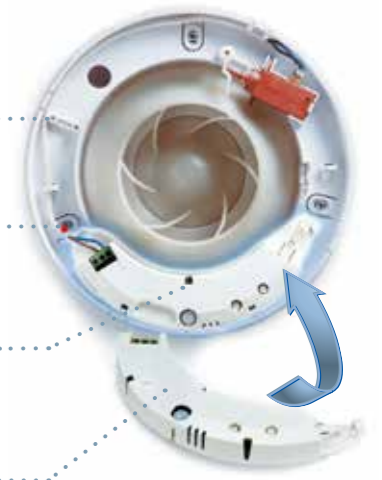

### Wholesalers and Installers save too!

Designed with the busy contractor in mind with modular design and maximum fan choice, you save time and make more money. Just carry three basic fans and a range of inexpensive fan control modules to install fans quickly and move faster from site to site.

- Go from site to site
- Just carry three basic fans and a choice of control modules
- All modules fit all fans.\*
- Reduce trips to the wholesaler for site-specific fans.

\*subject to Voltage



### Minimal stock and maximum choice equals more profit

Wholesalers only need to stock three basic fans and offer a range of control modules to...

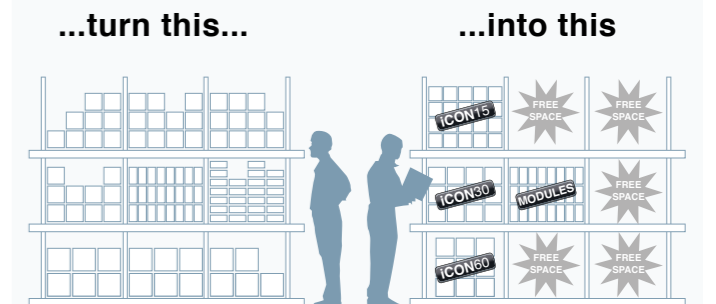

**STOP** using up valuable shelving space with boxes for every type of fan.

**SAVE** up to half your valuable shelving space by stocking three basic fans and a range of popular control modules.



# iCON 15

Stylish toilet and bathroom ventilation



## Key Features

- Axial fan
- Flow rate up to 68 m<sup>3</sup>/hr
- Stylish, slim and unobtrusive in walls or ceilings
- Low SFP 0.49 W/l/s
- Different colour covers available
- Unique iris shutter, prevents backdraughts, operates silently
- Interchangeable control modules match fan to installation requirements
- IPX4 rating
- Complies with Building Regulations
- 3 year warranty



## iCON 15

iCON 15 is ideal for toilets, en-suites, shower rooms and bathrooms. Recessed into the wall or ceiling, it is stylish and unobtrusive, even in the smallest of spaces. The circular design means no squaring up is required, adding to the already simple installation procedure.

iCON 15 is designed to provide ventilation levels that comply with the latest Building Regulations. The iCON fan is an efficient, stylish and unique ventilation solution for

the modern home. The shutter design makes switching on and off almost silent and helps reduce external noise ingress.

The slim profile and iris shutter of the iCON make it a fan which will blend discreetly into any setting. Two iCON 15 shower kits including (Timer / Humidity Timer) module and ducting installation kits are available.



## Modules

See page 72 for module functionality

72573602	Pull Cord
72612601	Timer
72687103	Humidity, Pull Cord with Timer overrun
72687104	Motion Sensor with Timer overrun
72687102	Motion Sensor Humidity Timer
72675701	Continuous Ventilation at 8/13 l/sec
72675702	Delayed Timer with Pull Cord
72675703	2 Speed Humidity Pull Cord boost



## Technical Data

Specification	iCON 15
Air flow m <sup>3</sup> /hr / l/sec	68 / 19
Fan type	Axial
Mounting	Wall / Ceiling
Sound pressure dB(A)@3m	30.3
Power watts	8.8
Specific Fan Power (SFP)	0.49
Building Regulations ADF	Yes
Duct diameter (mm)	100
Voltage	230/1/50Hz
Rating	IPX4
Max ambient temperature	40°C
Weight (kg)	0.74
Dimensions (H x W x D) mm	197 x 197 x 40
Part No.	72683501

## Covers

52634504	Silver
52634505	Sandstone
52634502	Chrome
52634503	Anthracite

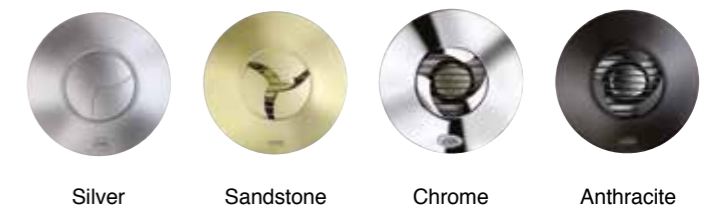

## Dimensions (mm)

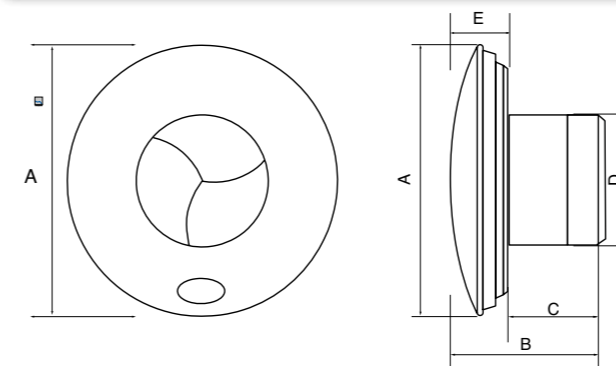

Model	A	B	C	D	E
iCON 15	197	108.5	67.5	100	40

## Shower Kit

90000434	iCON 15, Timer module, flexible ducting
90000433	iCON 15, Humidity / Timer module, flexible ducting

## Performance

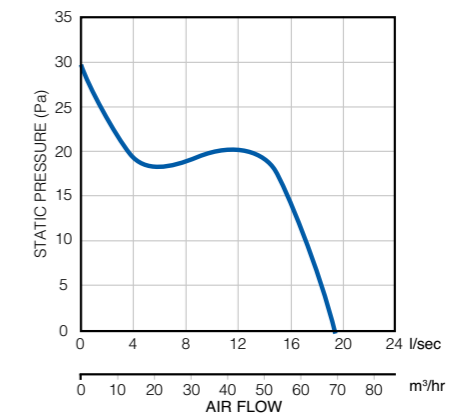

## Controls and Accessories

A range of accessories including flexible and rigid ducting kits, controls, switches and grilles are available.

See accessories section from page 209 for more details.

# iCON 30

Stylish toilet, bathroom and utility room ventilation



## Key Features

- Mixed flow fan
- Flow rate up to 118 m<sup>3</sup>/hr
- Recess or surface mounting
- Different colour covers available
- Perfect for longer duct runs
- Unique iris shutter, prevents backdraughts, operates silently
- Interchangeable control modules match fan to installation requirements
- Circular design, no squaring up
- IPX4 rating
- Complies with Building Regulations
- 3 year warranty



## iCON 30

iCON 30 is quiet, powerful and designed for recessed or surface mounting in walls or ceilings in larger toilets, bathrooms and utility rooms.

iCON 30 is designed to provide ventilation levels that comply with the latest Building Regulations.

The iCON fan is an efficient, stylish and unique ventilation solution for the modern home. The shutter design makes switching on and off almost silent and helps reduce external noise ingress.

The slim profile and iris shutter of the iCON make it a fan which will blend discreetly into any setting.



## Modules

See page 72 for module functionality

72573602	Pull Cord
72612601	Timer
72687103	Humidity, Pull Cord with Timer overrun
72687104	Motion Sensor with Timer overrun
72687102	Motion Sensor Humidity Timer
72675701	Continuous Ventilation at 8/13 l/sec
72675702	Delayed Timer with Pull Cord
72675703	2 Speed Humidity Pull Cord boost

## Technical data

Specification	iCON 30
Air flow m <sup>3</sup> /hr / l/sec	118 / 32
Fan type	Mixed Centrifugal / Axial
Mounting	Wall / Ceiling
Sound pressure dB(A)@3m	33.6
Power watts	18
Building Regulations ADF	Yes
Duct diameter (mm)	100
Voltage	230v / 1ph / 50Hz
Rating	IPX4
Max ambient temperature	40°C
Weight (kg)	1.11
Dimensions (H x W x D) mm	225 x 225 x 141
Part No.	72591601



## Covers

52634507	Silver
52634508	Sandstone
52634506	Anthracite



Silver Sandstone Anthracite

## Dimensions (mm)

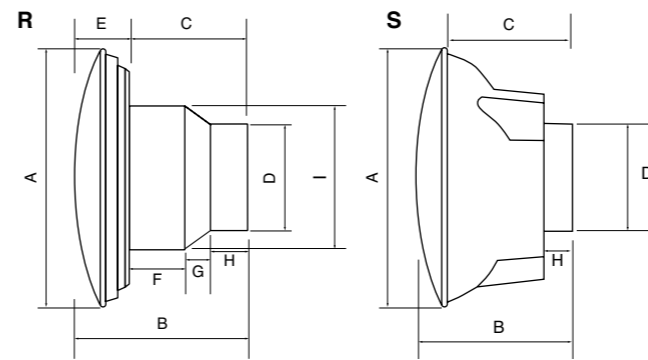

R = Recessed without skirt S = Surface mounted with skirt

Model	A	B	C	D	E	F	G	H	I
iCON 30 (R)	225	144	101	97	43	51	20	30	148
iCON 30 (S)	225	144	92	97	-	-	-	29	-

## Performance

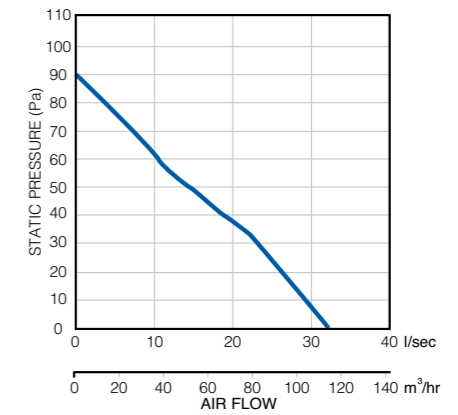

## Controls and Accessories

A range of accessories including flexible and rigid ducting kits, controls, switches and grilles are available.

See accessories section from page 209 for more details.



# iCON 60

Stylish large bathroom, utility room and kitchen ventilation

## Key Features

- Mixed flow fan
- Flow rate up to 260 m<sup>3</sup>/hr
- Recess or surface mounting
- Different colour covers available
- Perfect for longer duct runs
- Unique iris shutter, prevents backdraughts, operates silently
- Interchangeable control modules match fan to installation requirements
- Circular design, no squaring up
- IPX4 rating
- Complies with Building Regulations - ADF
- 3 year warranty



## iCON 60

iCON 60 is the largest, most powerful fan in the range. It is suitable for recessed or surface mounting in walls or ceilings and is highly efficient in domestic kitchens, large bathrooms and utility rooms.

iCON 60 is designed to provide ventilation levels that comply with the latest Building Regulations.

The iCON fan is an efficient, stylish and unique ventilation solution for the modern home. The shutter design makes switching on and off almost silent and helps reduce external noise ingress. The slim profile and iris shutter of the iCON make it a fan which will blend discreetly into any setting.



## Modules

See page 72 for module functionality

72573602	Pull Cord
72612601	Timer
72687103	Humidity, Pull Cord with Timer overrun
72687104	Motion Sensor with Timer overrun
72687102	Motion Sensor Humidity Timer
72675701	Continuous Ventilation at 8/13 l/sec
72675702	Delayed Timer with Pull Cord
72675703	2 Speed Humidity Pull Cord boost

## Technical data

Specification	iCON 60
Air flow m <sup>3</sup> /hr / l/sec	270 / 75
Fan type	Mixed Centrifugal / Axial
Mounting	Wall / Ceiling
Sound pressure dB(A)@3m	42
Power Watts	63.1
Building Regulations ADF	Yes
Duct diameter (mm)	150
Voltage	230v / 1ph / 50Hz
Rating	IPX4
Max ambient temperature	40°C
Weight (kg)	1.97
Dimensions (H x W x D) mm	280 x 280 x 165
Part No.	72591701

## Dimensions (mm)

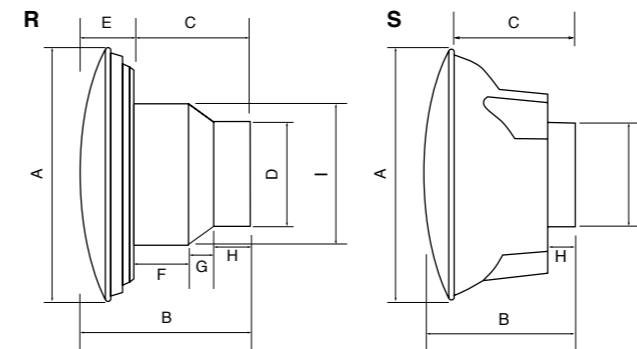

R = Recessed without skirt      S = Surface mounted with skirt

Model	A	B	C	D	E	F	G	H	I
iCON 60 R	280	165	110	148	55	38	20	52	177
iCON 60 S	280	165	80	148	-	-	-	46	-



## Covers

52634510	Silver
52634511	Sandstone
52634509	Anthracite



## Performance

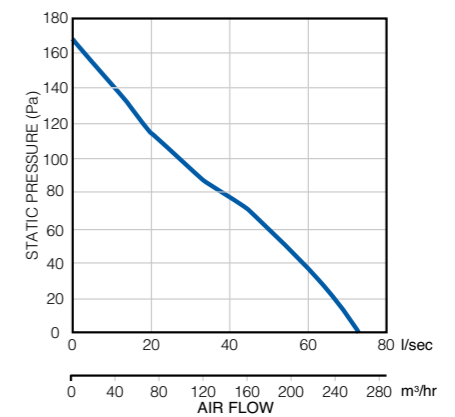

## Controls and Accessories

A range of accessories including flexible and rigid ducting kits, controls, switches and grilles are available.

See accessories section from page 209 for more details.

# iCON 15S eco

Stylish toilet and bathroom ventilation



## Key Features

- Low energy axial fan
- Flow rate up to 79 m<sup>3</sup>/hr
- Stylish, slim and unobtrusive in walls or ceilings
- Different colour covers available
- Unique iris shutter, prevents backdraughts, operates silently
- Interchangeable control modules match fan to installation requirements
- Low watt motor - 7.5w
- SFP 0.34 W/l/s
- Universal voltage 100/240v - 50/60Hz
- IPX4 rating
- Complies with Building Regulations
- 3 year warranty

## iCON 15S eco

iCON 15S eco 12 volt low energy fans with brushless DC motors offer significantly reduced energy consumption compared with standard AC motors. Fitted with ball-bearing motors for extra long life, each model is supplied with a remote mounting 100/240v AC to 12vDC transformer. Stylish, slim and unobtrusive in walls or ceilings. The circular design means no squaring up is required, adding to the already simple installation procedure.

iCON 15S eco is designed to provide ventilation levels that comply with the latest Building Regulations.

The iCON fan is an efficient, stylish and unique ventilation solution for the modern home. The shutter design makes switching on and off almost silent and helps reduce external noise ingress. The slim profile and iris shutter of the iCON make it a fan which will blend discreetly into any setting.



## Modules

See page 72 for module functionality

72573603	Pull Cord
72574204	Pull Cord with adjustable Timer
72574202	Humidity, Pull Cord with Timer overrun
72574203	Motion Sensor with Timer overrun
72574201	Motion Sensor / Humidity / Timer
72682307	Delay Start Timer with Pull Cord



## Technical Data

Specification	iCON 15S eco
Air flow m <sup>3</sup> /hr / l/sec	79 / 22
Fan type	Axial
Mounting	Wall / Ceiling
Sound pressure dB(A)@3m	30.3
Power watts	5.6
Specific Fan Power (SFP)	0.34
Building Regulations ADF	Yes
Duct diameter (mm)	100
Voltage	100/240v-50/60Hz
Rating	IPX4
Max ambient temperature	40°C
Weight (kg)	0.74
Dimensions (H x W x D) mm	197 x 197 x 40
Part No.	72683701

## Covers

52634504	Silver
52634505	Sandstone
52634502	Chrome
52634503	Anthracite

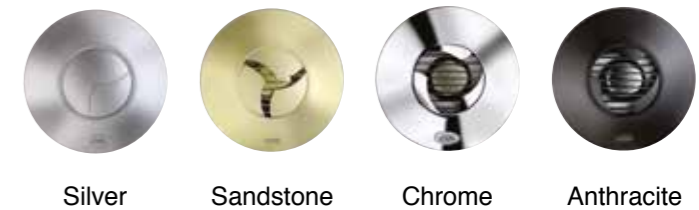

## Dimensions (mm)

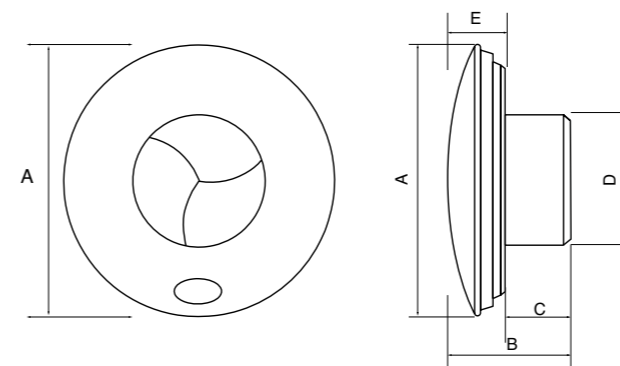

Model	A	B	C	D	E
iCON 15S eco	197	85	67.5	100	40

## Performance

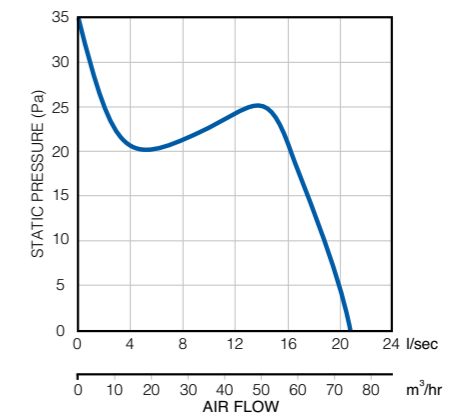

## Controls and Accessories

A range of accessories including flexible and rigid ducting kits, controls, switches and grilles are available.

See accessories section from page 209 for more details.



# iCON 30S eco

Stylish toilet, bathroom and utility ventilation



## Key Features

- Low energy mixed flow fan
- Flow rate up to 123 m<sup>3</sup>/hr
- Stylish, slim and unobtrusive in walls or ceilings
- Recessed or surface mounting
- Different colour covers available
- Unique iris shutter, prevents backdraughts, operates silently
- Interchangeable control modules match fan to installation requirements
- Low watt motor - 13w
- SFP 0.38 W/l/s
- Universal voltage 100/240v - 50/60Hz
- IPX4 rating
- Complies with Building Regulations
- 3 year warranty

## iCON 30S eco

iCON 30S eco 12 volt low energy fans with brushless DC motors offer significantly reduced energy consumption compared with standard AC motors. Fitted with ball-bearing motors for extra long life, each model is supplied with a remote mounting 100/240v AC to 12v DC transformer. Stylish, slim and unobtrusive in walls or ceilings.

The iCON fan is an efficient, stylish and unique ventilation solution for the modern home. The shutter design makes switching on and off almost silent and helps reduce external noise ingress. The slim profile and iris shutter of the iCON make it a fan which will blend discreetly into any setting.

iCON 30S eco is designed to provide ventilation levels that comply with the latest Building Regulations.



## Modules

See page 72 for module functionality

72573603	Pull Cord
72574204	Pull Cord with adjustable Timer
72574202	Humidity, Pull Cord with Timer overrun
72574203	Motion Sensor with Timer overrun
72574201	Motion Sensor / Humidity / Timer
72682307	Delay Start Timer with Pull Cord



## Technical Data

Specification	iCON 30S eco
Air flow m <sup>3</sup> /hr / l/sec	123 / 34
Fan type	Mixed Centrifugal / Axial
Mounting	Wall / Ceiling
Sound pressure dB(A)@3m	33.6
Power watts	7.7
Specific Fan Power (SFP)	0.38
Building Regulations ADF	Yes
Duct diameter (mm)	100
Voltage	100/240v-50/60Hz
Rating	IPX4
Max ambient temperature	40°C
Weight (kg)	1.1
Dimensions (H x W x D) mm	225 x 225 x 141
Part No.	72683801

## Covers

52634507	Silver
52634508	Sandstone
52634506	Anthracite

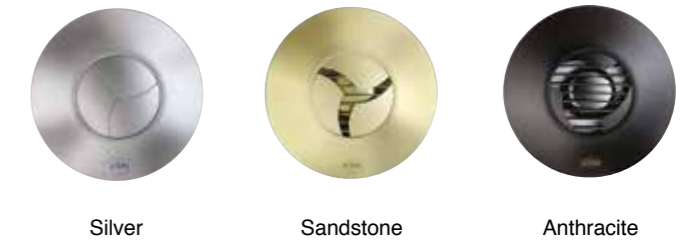

## Dimensions (mm)

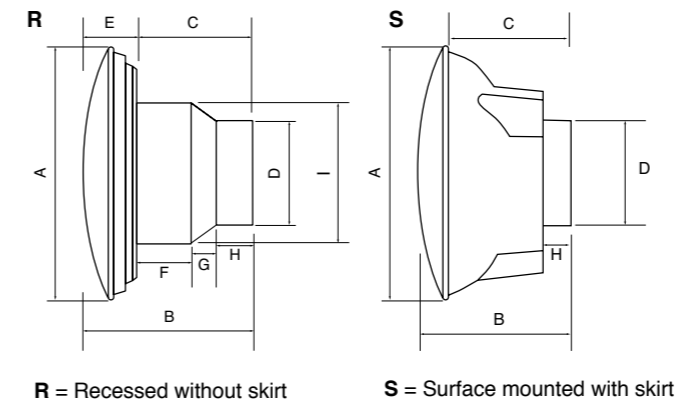

Model	A	B	C	D	E	F	G	H	I
iCON 30S eco (R)	225	144	101	97	43	51	20	30	148
iCON 30S eco (S)	225	144	92	97	-	-	-	29	-

## Performance

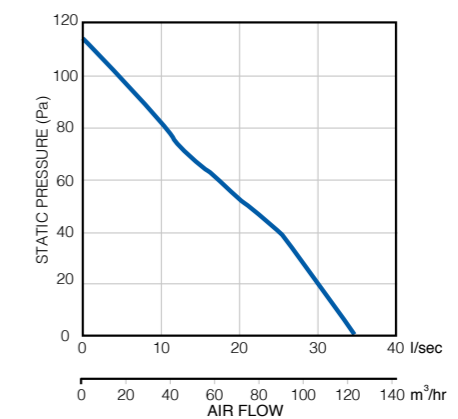

## Controls and Accessories

A range of accessories including flexible and rigid ducting kits, controls, switches and grilles are available.

See accessories section from page 209 for more details.

# iCON 15 eco

Stylish toilet and bathroom ventilation

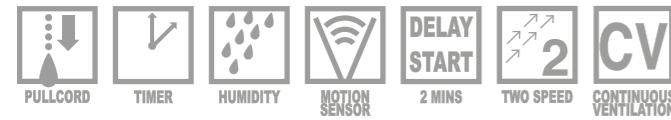

## Key Features

- Super low energy axial fan
- Flow rate 79 m<sup>3</sup>/hr
- Switch Mode Power Supply (SMPS) located in the module
- Stylish, slim and unobtrusive in walls or ceilings
- Different colour covers available
- Unique iris shutter, prevents backdraughts, operates silently
- Quiet operation 35 dB(A)
- Interchangeable control modules match fan to installation requirements
- Low watt motor – 7.5W
- SFP 0.34 W/l/s
- Voltage supply 100/240v-50/60Hz
- IPX4 rating
- Complies with Building Regulations
- 3 year warranty

## iCON 15 eco

iCON 15 eco with the brand new SMPS technology located in the module converts 100/240v AC power into 12v DC power. The advantage of this quicker and easier installation is a neater and more compact method of powering a low energy fan than a bulky transformer.

iCON 15 eco is designed to provide ventilation levels that comply with the latest Building Regulations. The Specific Fan Power is also well within the parameters of the energy requirements of the Building Regulations

The iCON fan is an efficient, stylish and unique ventilation solution for the modern home. The shutter design makes switching on and off almost silent and helps reduce external noise ingress. The slim profile and iris shutter of the iCON make it a fan which will blend discreetly into any setting.



## Modules

See page 73 for module functionality

72687127	Pull Cord
72687128	Timer
72687129	Humidity Pull Cord with Timer overrun
72687130	Motion Sensor with Timer overrun
72687131	Motion Sensor Humidity Timer
72687132	Continuous Ventilation at 8/13 l/sec
72687133	Delayed Timer
72687134	2 Speed Humidity Pull Cord boost

Note: This fan requires a module to operate



## Technical Data

Specification	iCON 15 eco
Air flow m <sup>3</sup> /hr / l/sec	79 / 22
Fan type	Axial
Mounting	Wall / Ceiling
Sound pressure dB(A)@3m	30.3
Power watts	7.5
Specific Fan Power (SFP)	0.34
Building Regulations ADF	Yes
Duct diameter (mm)	100
Voltage	100/240v-50/60Hz
Rating	IPX4
Max ambient temperature	40°C
Weight (kg)	0.74
Dimensions (H x W x D) mm	197 x 197 x 40
Part No.	72687121

## Covers

52634504	Silver
52634505	Sandstone
52634503	Anthracite
52634502	Chrome

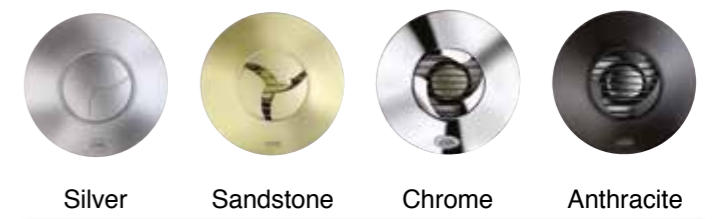

## Dimensions (mm)

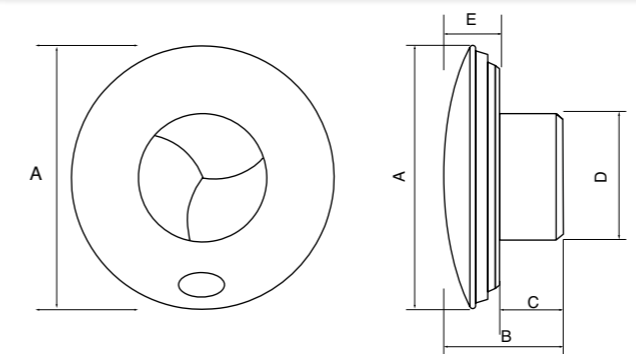

Model	A	B	C	D	E
iCON 15 eco	197	85	45	100	140

## Performance

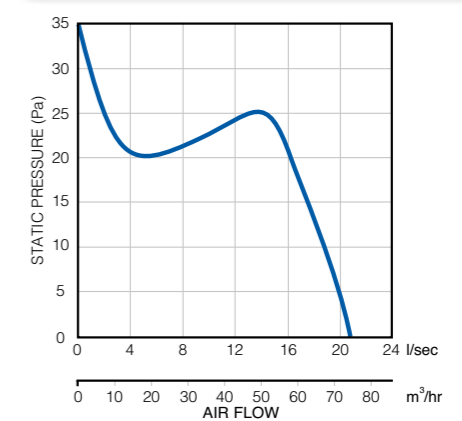

## Controls and Accessories

A range of accessories including flexible and rigid ducting kits, controls, switches and grilles are available.

See accessories section from page 209 for more details.

# iCON 30 eco

Stylish toilet, bathroom and utility ventilation

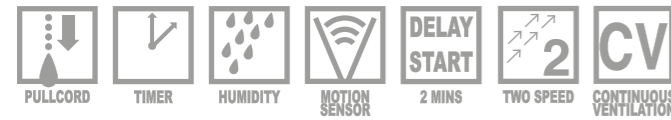

## Key Features

- Super low energy mixed flow fan
- Flow rate up to 112 m<sup>3</sup>/hr
- Switch Mode Power Supply (SMPS) located in the module
- Stylish, slim and unobtrusive in walls or ceilings
- Recessed or surface mounting
- Different colour covers available
- Unique iris shutter, prevents backdraughts, operates silently
- Quiet operation from 34dB(A)
- Interchangeable control modules match fan to installation requirements
- Low watt motor – 14W
- SFP 0.45 W/l/s
- Voltage supply 100/240v-50/60Hz
- IPX4 rating
- Complies with Building Regulations
- 3 year warranty

## iCON 30 eco

iCON 30 eco with the brand new SMPS technology located in the module converts 100/240v AC power into 12v DC power. The advantage of this quicker and easier installation is a neater and more compact method of powering a low energy fan than a bulky transformer.

iCON 30 eco is designed to provide ventilation levels that comply with the latest Building Regulations. The Specific Fan Power is also well within the parameters of the energy requirements of the Building Regulations

The iCON fan is an efficient, stylish and unique ventilation solution for the modern home. The shutter design makes switching on and off almost silent and helps reduce external noise ingress. The slim profile and iris shutter of the iCON make it a fan which will blend discreetly into any setting.



## Modules

See page 73 for module functionality

72687127	Pull Cord
72687128	Timer
72687129	Humidity Pull Cord with Timer overrun
72687130	Motion Sensor with Timer overrun
72687131	Motion Sensor Humidity Timer
72687132	Continuous Ventilation at 8/13 l/sec
72687133	Delayed Timer
72687134	2 Speed Humidity Pull Cord boost

Note: This fan requires a module to operate

## Technical Data

Specification	iCON 30 eco
Air flow m <sup>3</sup> /hr / l/sec	112 / 31
Fan type	Mixed Centrifugal / Axial
Mounting	Wall / Ceiling
Sound pressure dB(A)@3m	33.6
Power watts	14
Specific Fan Power (SFP)	0.45
Building Regulations ADF	Yes
Duct diameter (mm)	100
Voltage	100/240v-50/60Hz
Rating	IPX4
Max Ambient Temperature	40°C
Weight (kg)	1.11
Dimensions (H x W x D) mm	225 x 225 x 141
Part No.	72687122

## Dimensions (mm)

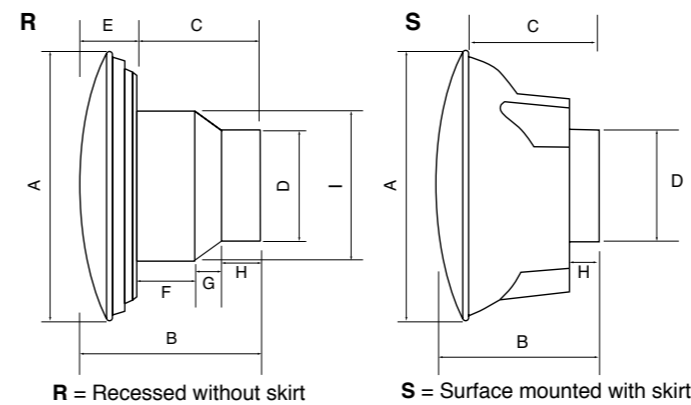

Model	A	B	C	D	E	F	G	H	I
iCON 30 eco (R)	225	144	101	97	43	51	20	30	148
iCON 30 eco (S)	225	144	92	97	-	-	-	29	-



## Covers

52634507	Silver
52634508	Sandstone
52634506	Anthracite

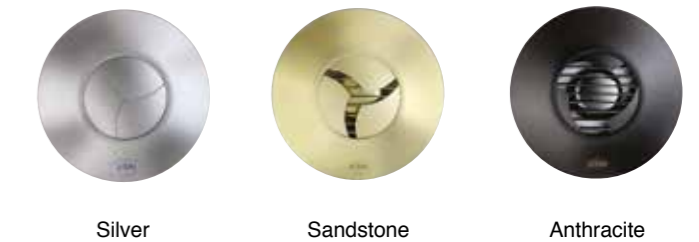

## Performance

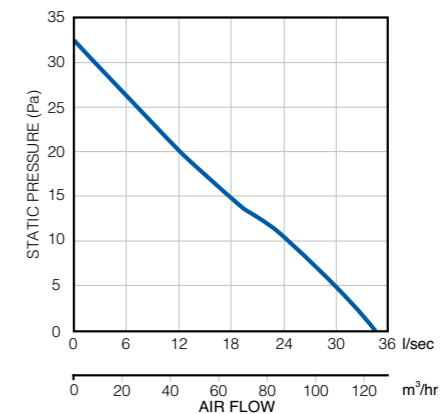

## Controls and Accessories

A range of accessories including flexible and rigid ducting kits, controls, switches and grilles are available.

See accessories section from page 209 for more details.



# iCON 60 eco

Stylish large bathroom, utility room and kitchen ventilation - coming soon

## Key Features

- Super low energy mixed flow fan
- Switch Mode Power Supply (SMPS) located in the module
- Stylish, slim and unobtrusive in walls or ceilings
- Recessed or surface mounting
- Different colour covers available
- Unique iris shutter, prevents backdraughts, operates silently
- Quiet operation
- Interchangeable control modules match fan to installation requirements
- Low watt motor
- Voltage supply 100/240v-50/60Hz
- IPX4 rating
- Complies with Building Regulations
- 3 year warranty



## iCON 60 eco

iCON 60 eco with the brand new SMPS technology located in the module converts 100/240v AC power into 12v DC power. The advantage of this quicker and easier installation is a neater and more compact method of powering a low energy fan than a bulky transformer.

iCON 60 eco is designed to provide ventilation levels that comply with the latest Building Regulations. The Specific Fan Power is also well within the parameters of the energy requirements of the Building Regulations

The iCON fan is an efficient, stylish and unique ventilation solution for the modern home. The shutter design makes switching on and off almost silent and helps reduce external noise ingress. The slim profile and iris shutter of the iCON make it a fan which will blend discreetly into any setting.



## Modules

See page 73 for module functionality

72687127	Pull Cord
72687128	Timer
72687129	Humidity, Pull Cord with Timer overrun
72687130	Motion Sensor with Timer overrun
72687131	Motion Sensor Humidity Timer
72687132	Continuous Ventilation at 8/13 l/sec
72687133	Delayed Timer
72687134	2 Speed Humidity Pull Cord boost

Note: This fan requires a module to operate



## Technical Data

Specification	iCON 60 eco
Air flow m <sup>3</sup> /hr / l/sec	tba / tba
Fan type	Mixed Centrifugal / Axial
Mounting	Wall / Ceiling
Sound pressure dB(A)@3m	tba
Power watts	tba
Building Regulations ADF	Yes
Duct diameter (mm)	150
Voltage	100/240v-50/60Hz
Rating	IPX4
Max ambient temperature	40°C
Weight (kg)	1.97
Dimensions (H x W x D) mm	280 x 280 x 165
Part No.	72687123

## Covers

52634510	Silver
52634511	Sandstone
52634509	Anthracite



Silver Sandstone Anthracite

## Dimensions (mm)

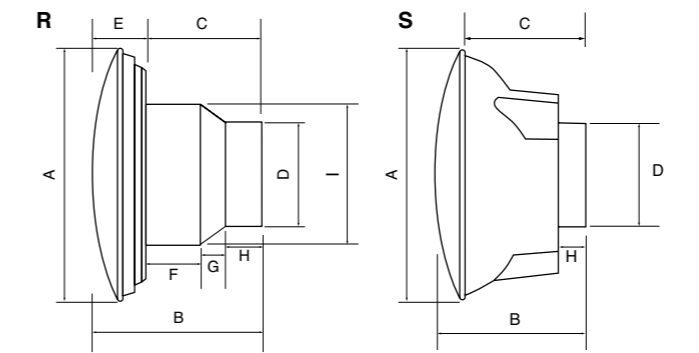

R = Recessed without skirt S = Surface mounted with skirt

Model	A	B	C	D	E	F	G	H	I
iCON 60 eco R	280	165	110	148	55	38	20	52	177
iCON 60 eco S	280	165	80	148	-	-	-	46	-

## Performance

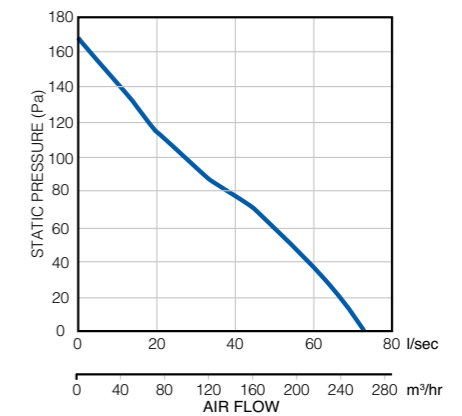

## Controls and Accessories

A range of accessories including flexible and rigid ducting kits, controls, switches and grilles are available.

See accessories section from page 209 for more details.





Choose the function  
Select the module  
It's iCON simple



The module concept which is unique to iCON, gives one the option of determining how you wish to control your fan and based on your requirement select the appropriate module. Airflow has invested extensively in the research and development of our modules to bring our customers the most versatile controllability available in the extractor fan market. Our extensive range of control functions has helped the iCON product range become the leading brand it is today.

The same module is compatible with all three size iCON's – 15, 30 and 60. However, it should be noted that there are specific 240V modules and different low voltage SELV modules (please refer to the table below for details and part numbers of the various modules).

Replacing a module is also a lot simpler and cheaper than replacing the entire fan.

**Modules for use in 240V iCON Fans**      iCON 15 - 72683501      iCON 30 - 72591601      iCON 60 - 72591701

Part No.	Control	Function
72573602	PCM	Manual on/off control by pull cord switch
72612601	TM	Adjustable timer between 1 - 30 minutes, remote or light switch operation
72687103	HTM	Adjustable humidity setting between 40 - 90% RH, adjustable timer and momentary pull cord to activate timer
72687104	PRTM	Motion sensor activation with adjustable timer
72687102	PRHTM	Motion sensor activation with adjustable humidity setting and adjustable timer
72675701	CV2	Continuous Ventilation at 8 or 13 l/sec. Boost to a maximum flow rate of the fan by remote switching or pull cord
72675702	DTM	Delayed start for 2 minutes after light switch operation (ideal for quick visits) then adjustable timer between 2 - 45 minutes (DTM only). Momentary pull cord to activate timer
72675703	2SHM	Remote light switch operation activates low speed. Boost speed activated by automatic humidity sensor (adjustable 40 - 90% RH) or manually by momentary cord

**Modules for use in 12V iCON SELV Fans with remote transformer**      iCON 15S eco - 72683701      iCON 30S eco - 72683801

72573603	PCS	Manual on/off control by pull cord switch
72574204	PCTS	Adjustable timer between 1 - 30 minutes, pull cord/ remote or light switch operation
72574202	HTS	Adjustable humidity setting 40 - 90% RH, adjustable timer and momentary pull cord to activate timer
72574203	PRTS	Motion sensor activation with adjustable timer
72574201	PRHTS	Motion sensor activation with adjustable humidity setting and adjustable timer
72682307	DTS	Delayed start for 2 minutes after light switch operation (ideal for quick visits) pull cord then adjustable timer between 2 - 45 minutes (DTS only). Momentary pull cord to activate timer

**Modules with integral transformer for use in 12V iCON fans**      iCON 15 eco - 72687121      iCON 30 eco - 72687122      iCON 60 eco - 72687123

Part No.	Control	Function
72687127	PCE	Manual on/off control by pull cord switch
72687128	TE	Adjustable timer between 1 - 30 minutes, pull cord / remote or light switch operation
72687129	HTE	Adjustable humidity setting between 40 - 90% RH, adjustable timer and momentary pull cord to activate timer
72687130	MSTE	Motion sensor activation with adjustable timer
72687131	MSHTE	Motion sensor activation with adjustable humidity setting and adjustable timer
72687132	CVE	Continuous Ventilation at 8 or 13 l/sec. Boost to a maximum flow rate of the fan by remote switching or pull cord
72687133	DTE	Delayed start for 2 minutes after light switch operation (ideal for quick visits) then adjustable timer between 2 - 45 minutes (DTE only). Pull cord to activate timer
72687134	2SHE	Remote light switch operation activates low speed. Boost speed activated by automatic humidity sensor (adjustable 40 - 90% RH) or manually by momentary pull cord

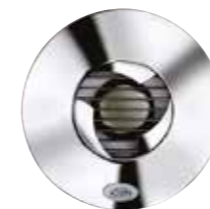

Chrome



Anthracite



Silver



Sandstone

Adding colour and style to your home with a coloured iCON cover

Colour Covers	iCON 15	iCON 30	iCON 60
Anthracite	52634503	52634506	52634509
Silver	52634504	52634507	52634510
Sandstone	52634505	52634508	52634511
Chrome	52634502	N/A	N/A

To complement the décor of your home, we also offer the flexibility to upgrade the white cover to Anthracite, Sandstone, Silver or Chrome (iCON 15 only). This is perfect for customers looking for a fan that blends seamlessly into the surroundings adding colour and co-ordination to any toilet, en-suite, bathroom, utility room or kitchen at a surprisingly low cost.

The covers are simple to fit and can be easily cleaned by simply wiping off with a damp cloth.

We are convinced that our exclusive design and product configuration possibilities, have contributed to iCON fans, modules and covers becoming one of the most successful brand names in the extractor fan business.

# iCONstant

Continuous Ventilation - suitable for any room



## Key Features

- From 10dB(A) the quietest dMEV fan available
- Selectable trickle flow rates 22/29/47 m<sup>3</sup>/hr. Boost up to 72 m<sup>3</sup>/hr
- Just over £1.00 per year to run on trickle speed
- Constant volume - Guaranteed to deliver installed performance
- The only IPX5 dMEV fan rated for both wall and ceiling installs
- Timer and Humidity versions. Two minute delay start (boost) option
- Memory retained in event of a power cut
- LED self diagnostics and 'fine tune' commissioning option of flow rate
- Complies with Building Regulations
- SAP Appendix Q eligible
- 3 year warranty

## iCONstant.

Based on our very successful iCON brand, we have developed the quietest dMEV fan available for toilet/bathroom and utility room installation bringing incredibly low sound levels to this market sector. The fan is perfect in the kitchen too. Utilizing the very latest motor technology and incorporating advanced features we have been able to produce an energy efficient fan that will help eliminate the problems of condensation by continuously extracting the damp air that is the source of the problem.

The iCONstant boasts features that reduce human intervention and ensure the fan is always operating at the optimum level whatever the circumstances of the installation. This is perfect for the social housing sector where specifiers, landlords and tenants all seek a ventilation solution that is energy efficient, economical to run and quiet to operate.

iCONstant, the virtually silent, low energy dMEV fan from Airflow – packed with features – results guaranteed.



## Models

<b>Timer</b>	On boost timer can be set to run on for 2, 15, 30 or 40 minutes
<b>Humidity Timer</b>	Intelligent humidity sensor adjustable between 60% and 90%. On boost, timer can be set to run on for 2, 15, 30 or 40 minutes



Cover removed showing LED self diagnostics and 'fine tuning' commissioning functionality

## Technical Data

Specification	iCONstant		
Air flow m <sup>3</sup> /hr (trickle/boost)	22 / 29	29 / 47	47 / 72
Air flow l/sec (trickle/boost)	6 / 8	8 / 13	13 / 20
Fan type	Axial		
Controls	Timer/ Humidity Timer		
Sound pressure dB(A)@3m	10 / 15	15 / 28	28 / 38
Power watts	1.07 / 1.21	1.21 / 1.68	1.68 / 2.90
Amps	3		
Calculated Specific Fan Power (SFP)	0.18 / 0.15	0.15 / 0.13	0.13 / 0.14
Building Regulations ADF	Yes		
Duct diameter (mm)	100		
Voltage	100/240V-50/60Hz		
Rating (wall and ceiling)	IPX5		
Weight (kg)	0.55		
Dimensions (H x W x D) mm	197 x 197 x 120		
Part No.	72687117 (T)	72687118 (HT)	

## Dimensions (mm)

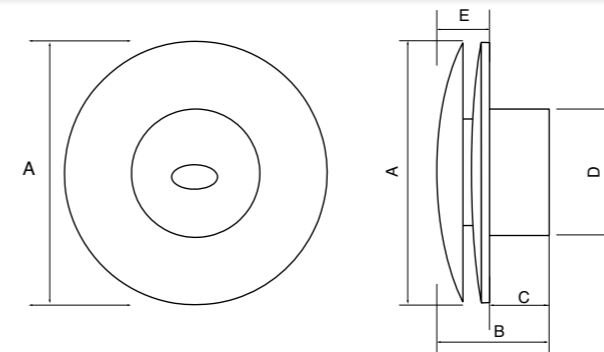

Model	A	B	C	D	E
iCONstant	197	120	70	100	50

## Performance

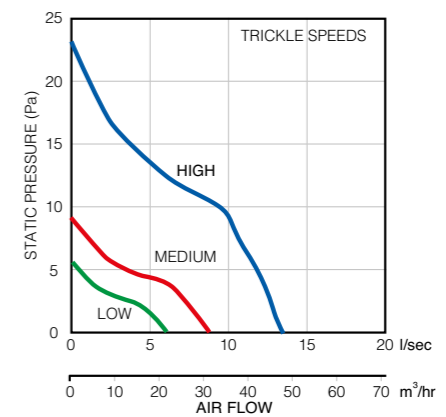

## SAP Appendix Q Performance

Unit configuration	Location	Fan speed setting	Specific fan power (W/l/s)
In room (rigid duct)	Kitchen	13 l/s	0.18
	Wet room	8 l/s	0.19
In room (flexible duct)	Kitchen	13 l/s	0.20
	Wet room	8 l/s	0.19
Through wall (rigid duct)	Kitchen	13 l/s	0.15
	Wet room	8 l/s	0.16

source: BRE

## Controls and Accessories

A range of accessories including flexible and rigid ducting kits, controls, switches and grilles are available.

See accessories section from page 209 for more details.



# iCONstant

Continuous Ventilation - suitable for any room

## Why dMEV?

In the Building Regulations dMEV is often referred to as decentralised Mechanical Extract Ventilation. The Airflow iCONstant dMEV continuous ventilation fan will provide the perfect solution for both new build and retrofitting into any domestic home, particularly where there has been

an increased level of insulation making it more airtight or the homeowner/tenant has a particular problem with condensation or mould. The iCONstant with Timer or Humidity Timer functionality are also SAP Appendix Q eligible.

## Economical to Operate – less than a light bulb

iCONstant has been developed to consume minimal energy using a highly efficient 24v DC motor. The motor draws a mere 1.07w on the lowest trickle speed of 6 l/sec. The boost speed on the humidity version is intelligently controlled so as to minimise the period of the boost flow and not significantly ramp up running costs. The yearly

running cost of the iCONstant is just over one Pound - operating at 6 l/sec. This is less than a low energy light bulb if left on 24/7 - a small price to pay to ensure the well-being of the occupier and help preserve the fabric of the building.

## Versatile Applications – one fan for all rooms

iCONstant dMEV fans can be used in any of the wet rooms. The required trickle rate is selected by the installer when the fan is fitted – this is dependent on the application - for toilets select 6 l/sec, en-suites, bathrooms and utility rooms select 8 l/sec and for kitchens it is 13 l/sec. The boost speed will be the next

speed level up with a maximum speed of 20 l/sec. The boost to the higher speed is activated by one of the following methods; integral momentary pull cord, remote switch (optional) or intelligent humidity sensor. Should there be a power interruption in the property, the settings will be maintained.

## Simple Controllability – optimizing your ventilation

On the timer version, the boost speed can be set to run on for between 2 and 40 minutes. With the Humidity Timer version, the intelligent humidity sensor will activate the boost speed when the set point is reached – this can

be adjusted anywhere between 60% and 90%. When the humidity level falls below the set-point again, the fan will revert to the trickle speed. Boost speed is activated by the integral pull cord or by a remote switch (optional).



## Packed with useful features with the user in mind

Airflow's intelligent humidity sensor offers the additional feature of being able to recognize a rapid increase in humidity and activates the boost speed before the pre-set value is reached so that preventive ventilation commences. Should this occur, the fan reverts to the trickle speed when the humidity level is within 10% of the set-point. The benefits of this are that energy consumption is kept to a minimum and noise levels are reduced whilst ensuring optimum ventilation is achieved, before excessive condensation occurs.

Another feature is the ability to delay the start of the boost function by two minutes. This is particularly advantageous for those quick visits during the middle of the night. The boost activation by the pull cord and humidity sensor is instant.

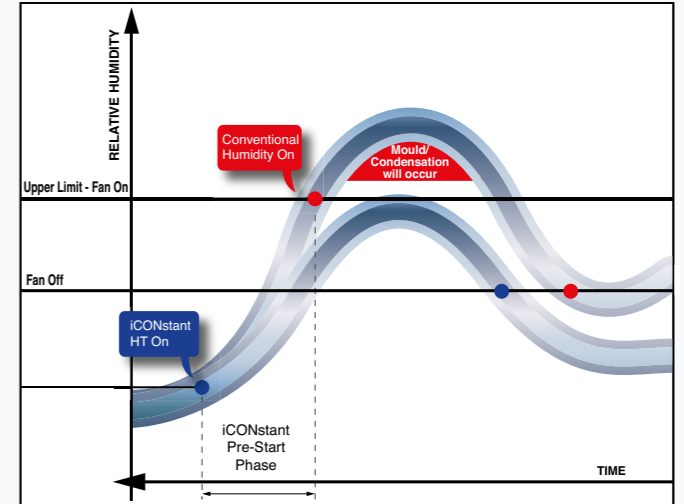

## Cutting Edge LED Setup

The iCONstant is fitted with a unique setup diagnostic LED light. This self proving technology facilitates the set-up process and the storage of settings. Flow settings

are made by the simple adjustment of the DIP switches. Installers will find it easy to setup saving time and money.

## Constant Volume Guaranteed

The iCONstant is fitted with a flow sensor to continually monitor flow. Should conditions change, such as on a windy day, the fan will automatically adjust the flow rate

to the original settings thus ensuring constant extraction is maintained. All this with no human intervention – exactly what specifiers and landlords are looking for.

## Ensuring Installed Performance

The everyday running rate can be adjusted if required, up to the maximum speed of the fan by simply pressing the +/- buttons. This 'fine tuning' is very useful during

commissioning to overcome system back pressure and ensure the installed performance for the installation is maintained.

## User safety is our priority

As we have achieved IPX5 ingress protection rating on this product, you will be able to fit the iCONstant anywhere within Zones 1 and 2\* of your bathroom/ en-suite. This makes our product incredibly safe to operate which is another reason for housing associations and

landlords to specify iCONstant, also it is easy for the installer to position the fan. Airflow is the only supplier to offer a dMEV product for both wall and ceiling installation with this IP rating.

\* Wired in accordance with IEEE wiring regulations 17th edition

## Another stylish design from Airflow

iCONstant's circular design is based on our very successful iCON brand of extractor fans. Customers like our circular design as this enhances the style and appearance of the

room plus a round fan is simple and quicker to install. The iCONstant is designed to be recessed into the wall / ceiling.



# LOOVENT eco

A fan for every room

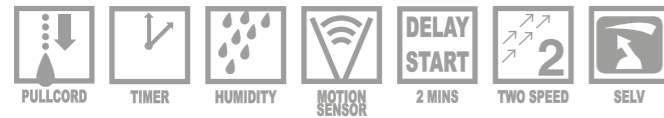

## Key Features

- Two speed centrifugal fan
- Flow rate up to 110 m<sup>3</sup>/hr
- Compact design - smallest 30 l/sec fan in class
- For toilets, bathrooms, en-suites, utility rooms and kitchens (adjacent to hob)
- Well proven, centrifugal, filterless technology
- Surface or recessed, portrait or landscape
- Simple replacement of existing Loovent - same mounting and spigot position
- Economical to operate - from 3.6w
- Timer, humidity timer and motion sensor Timer versions
- SELV versions - low voltage
- Voltage supply 100/240v-50/60Hz
- IPX5 rating
- Complies with Building Regulations
- 5 year warranty

## The next generation...

From an excellent pedigree of fans for over 40 years comes the next generation of fans – LOOVENT eco. A powerful, discreetly styled fan in a modular design for ease of installation and maintenance to ensure effective ventilation with minimal noise level and energy efficiency in mind.

It is exceptionally quiet with various “on-demand” control options that only activate the fan when needed - timer, humidity timer and motion sensor with timer. The low

energy motor helps reduce carbon emissions and saves on energy bills.

The LOOVENT eco is truly versatile in that it can be surface or recessed mounted into the wall or ceiling and fitted in either the portrait or landscape position.

LOOVENT eco is ideal for replacing the old Loovent 01C or existing Loovent 01 as the spigot position is identical and the back plates are the same size keeping reworking to a minimum.



## Models

<b>Timer / SELV T</b>	Timer can be set to run on between 2 and 45 minutes
<b>Humidity Timer / SELV HT</b>	Humidity sensor can be set between 40 - 90% RH
<b>Motion Sensor Timer</b>	PIR sensor activates fan to switch on, timer overrun



## Technical Data

Specification	LOOVENT eco T	LOOVENT eco HT	LOOVENT eco MST
Air flow m <sup>3</sup> /hr (low / boost)	62 / 110	62 / 110	62 / 110
Air flow l/sec (low / boost)	17 / 31	17 / 31	17 / 31
Fan type	Centrifugal	Centrifugal	Centrifugal
Controls	Timer	Humidity Timer	Motion Sensor Timer
Sound pressure dB(A)@3m	29 / 47	29 / 47	29/47
Power watts	3.6 / 12	3.6 / 12	3.6 / 12
Amps	3	3	3
Specific Fan Power (SFP)	0.21 / 0.40	0.21 / 0.40	0.21/0.40
Building Regulations ADF	Yes	Yes	Yes
Duct diameter (mm)	100	100	100
Voltage	100/240v-50/60Hz	100/240v-50/60Hz	100/240v-50/60Hz
Rating	IPX5	IPX5	IPX5
Weight (kg)	1,0	1,0	1,0
Dimensions (H x W x D) mm	167 x 187 x 138	167 x 187 x 138	167 x 187 x 138
Part No.	72684305	72684306	72684307
	72684309 (SELV)	72684310 (SELV)	N/A

## Dimensions (mm)

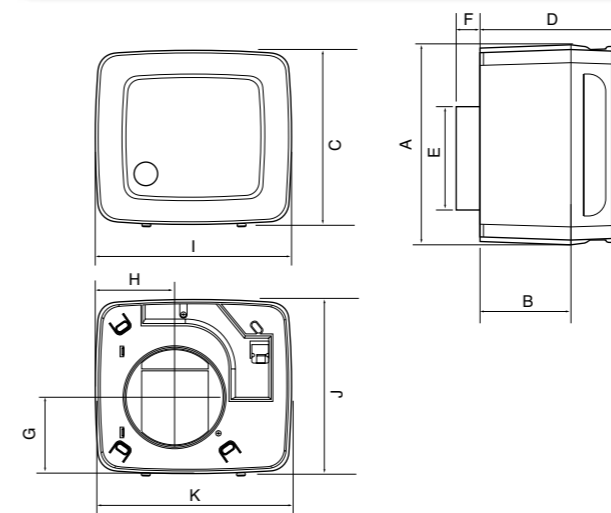

Model	A	B	C	D	E	F	G	H	I	J	K
LOOVENT eco	167	85.5	167	138.5	99	22	74.5	75	187	162.6	182.6

## Performance

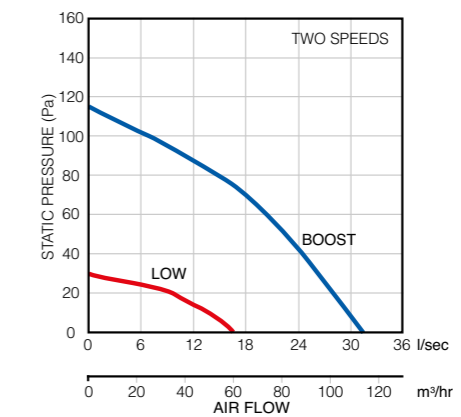

## Controls and Accessories

A range of accessories including flexible and rigid ducting kits, controls, switches and grilles are available.

See accessories section from page 209 for more details.





# LOOVENT eco dMEV

Continuous ventilation



## Key Features

- Continuous running centrifugal fan
- Trickle flow rate from 25 m<sup>3</sup>/hr
- Boost flow rate up to 110 m<sup>3</sup>/hr
- Compact design - smallest footprint in class
- Ideal for New Build and Refurbishments in toilets, bathrooms, en-suites, utility rooms and kitchens (adjacent to hob)
- Surface or recessed, portrait or landscape
- Simple replacement of existing Loovent - same mounting and spigot position
- Economical to operate - from 2.8w
- Timer and humidity timer versions
- SELV versions - low voltage
- Voltage supply 100/240v-50/60Hz
- IPX5 rating
- Complies with Building Regulations
- SAP Appendix Q eligible
- 5 year warranty

## The next generation...

The dMEV continuous ventilation versions are the ideal solution for maintaining the perfect air quality in the domestic home. The LOOVENT eco dMEV versions with timer and humidity timer functionality are SAP Appendix Q eligible, making them perfect for the new build market.

The trickle rate should be selected on installation depending on the application - 7 l/sec for toilets, 9 l/sec for bathrooms / en-suites / utility rooms and 16 l/sec for kitchens. Boost speed is activated by the pull cord,

humidity sensor or a remote switch (light / door switch). Boost speeds are 15, 15 and 31 l/sec respectively. The pre-set run on timer period will apply and revert back to the trickle speed after this time.

LOOVENT eco is ideal for replacing the old Loovent 01C or existing Loovent 01 as the spigot position is identical and the back plates are the same size keeping reworking to a minimum.

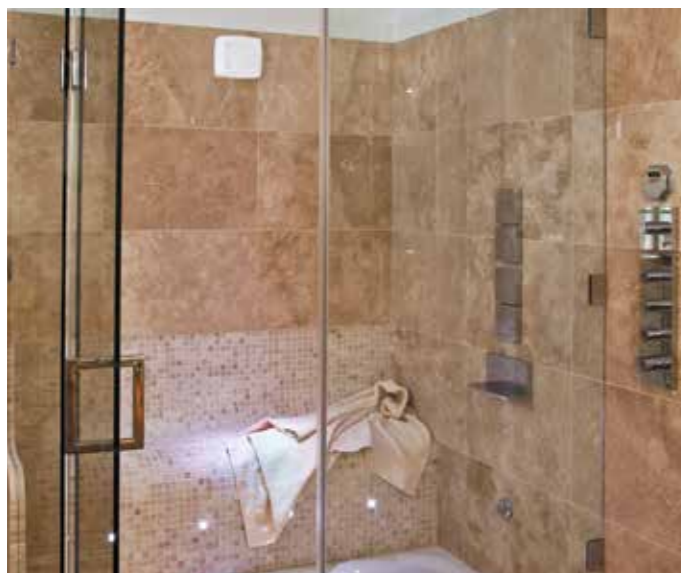

## Models

- **Timer / SELV T** Timer can be set to run on between 2 and 45 minutes
- **Humidity Timer / SELV HT** Humidity sensor can be set between 40 - 90% RH

## Technical Data

Specification	LOOVENT eco dMEV		
Air flow m <sup>3</sup> /hr (trickle / boost)	25 / 55	33 / 55	59 / 110
Air flow l/sec (trickle / boost)	7 / 15	9 / 15	16 / 31
Fan type	Centrifugal		
Controls	Timer / Humidity Timer		
Sound Pressure dB(A)@3m	25 / 46	25 / 46	28 / 46
Power watts	2.8 / 8.9	3 / 8.9	2.8 / 12
Amps	3		
Specific Fan Power (SFP)	0.40 / 0.59	0.32 / 0.59	0.17 / 0.40
Building Regulations ADF	Yes		
Duct diameter (mm)	100		
Voltage	100/240v-50/60Hz		
Rating	IPX5		
Weight (kg)	1,0		
Dimensions (H x W x D) mm	167 x 187 x 138		
Part No.	72684308 (T)	72684311 (HT)	
	72684312 (SELV)	72684313 (SELV)	



## Dimensions (mm)

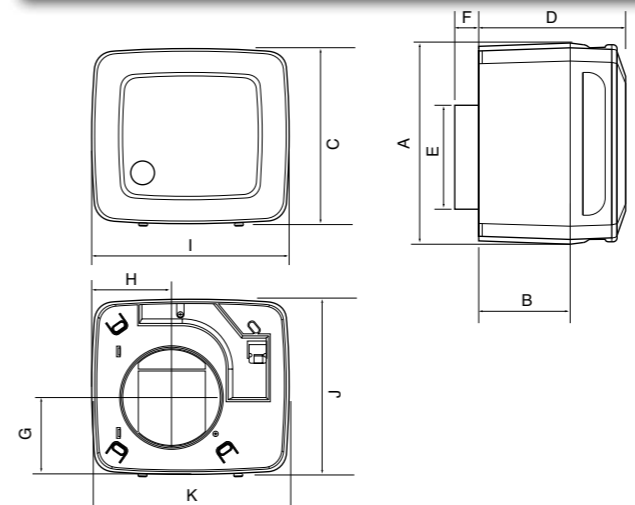

Model	A	B	C	D	E	F	G	H	I	J	K
LOOVENT eco	167	85.5	167	138.5	99	22	74.5	75	187	162.6	182.6



## Performance

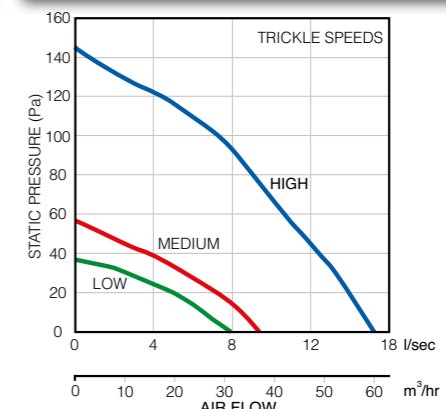

## SAP Appendix Q Performance

Unit configuration	Location	Flow rate	Specification fan power (W/l/s)
In room	Kitchen	13.3 l/sec	0.18
	Wet room	7 or 9.3 l/sec	0.31
Through wall	Kitchen	16.9 l/sec	0.19
	Wet room	10.0 l/sec	0.33

## Controls and Accessories

A range of accessories including flexible and rigid ducting kits, controls, switches and grilles are available.

See accessories section from page 209 for more details.

# Loovent

Toilet and bathroom ventilation



## Key Features

- Proven centrifugal fan
- Flow Rate up to 111 m<sup>3</sup>/hr
- Surface or recessed mounted
- Compact design - smallest 30 l/sec fan in class
- Well proven, centrifugal, filterless technology
- Integral magnetic anti-backdraught flap
- Thermally protected motor
- IPX4 rating
- TÜV approved
- Complies with Building Regulations
- 3 year warranty



TIMER

## Loovent

Highly reliable and powerful fan in a modular design for ease of installation and maintenance.

Loovent centrifugal fans are perfect where longer duct runs are required as they are powerful enough to overcome pressure loss. All Loovents are designed to provide extraction levels that comply with the latest Building Regulations.

The Loovent fan offers an adjustable timer overrun control, ensuring efficient ventilation, which can be used with 100mm ducting. It provide the ideal solution for removing damp moist air, odours and airborne pollutants from en-suites, bathrooms and utility rooms.

The new LOOVENT eco range offers a full range of functionality including SAP Appendix Q approved dMEV versions.



## Models

Timer	Remote switch with run on timer adjustable between 5 and 45 minutes
-------	---

## Technical Data

Specification	Loovent TM 01
Air flow m <sup>3</sup> /hr	111
Air flow l/sec	31
Fan type	Centrifugal
Controls	Timer
Mounting	Surface / Recess
	Wall / Ceiling
Sound Pressure dB(A)@3m	58
Power watts	30
Amps	2
Building Regulations ADF	Yes
Duct diameter (mm)	100
Voltage	230v / 1ph / 50Hz
Rating	IPX4
Material finish	ABS
Weight (kg)	1.5
Dimensions (H x W x D) mm	162 x 181 x 112
Part No.	71766401



## Dimensions (mm)

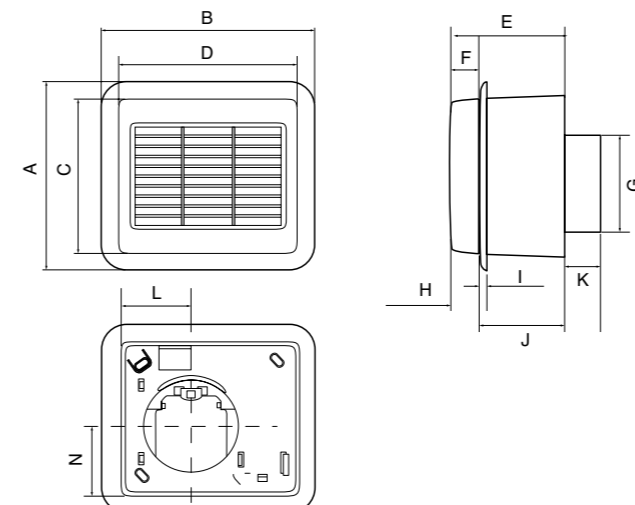

Model	A	B	C	D	E	F	G	H	I	J	K	L	N
Loovent	199	217	162	181	112	26	97	31-33	4-8	85	35	72	72

## Performance

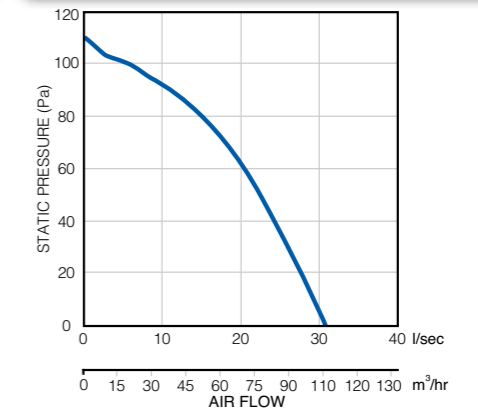

## Controls and Accessories

A range of accessories including flexible and rigid ducting kits, controls, switches and grilles are available.

See accessories section from page 209 for more details.

# Roomvent

Bathroom and utility room ventilation



## Key Features

- Powerful centrifugal fan
- Flow rate up to 173 m<sup>3</sup>/hr
- Easy to fit airbrick size case
- Fixing pack supplied including bezel
- Recess or surface mounted to a wall or ceiling (bezel supplied)
- Integral magnetic backdraught flap
- Thermally protected motor
- IPX4 rating
- Complies with Building Regulations
- 3 year warranty



TIMER

## Roomvent

Highly reliable and powerful centrifugal fan in a modular design for ease of installation and maintenance. The Roomvent is designed to provide extraction levels that comply with the latest Building Regulations.

Operated by adjustable timer, via a light or optional door switch. The Roomvent range comprises a selection of high performance fans for higher performance ventilation.

They are the ideal solution for removing damp moist air, odours and airborne pollutants from larger rooms. The motor, fan and plug-in timer are on a separate chassis for easy installation.



## Models

**Timer** Remote Switch with timer which can be set to run on between 3 and 50 minutes

**Wall Fan Timer** Fan with timer to run on between 3 and 50 minutes



## Technical Data

Specification	Roomvent T (07)	Roomvent WFT
Air flow m <sup>3</sup> /hr / l/sec	97 / 27	173 / 48
Fan type	Centrifugal	Centrifugal
Controls	Timer	Timer
Mounting	Wall / Ceiling	Wall / Ceiling
Sound pressure dB(A)@3m	50	60
Power watts	50	50
Amps	2	2
Building Regulations ADF	Yes	Yes
Duct diameter (mm)	100	100
Voltage	230v / 1ph / 50Hz	230v / 1ph / 50Hz
Rating	IPX4	IPX4
Material finish	ABS	ABS
Weight (kg)	2.15	3.10
Dimensions (H x W x D) mm	156 x 228 x 252	156 x 228 x 252
Part No.	71616301	71616501

## Dimensions (mm)

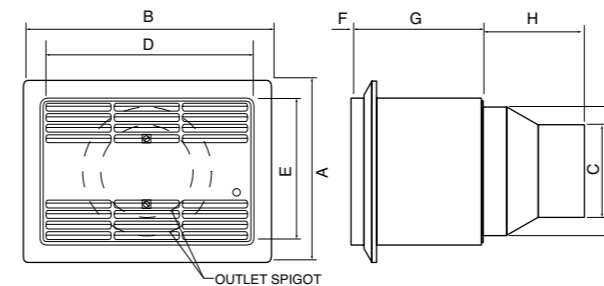

Model	A	B	C	D	E	F	G	H	I
Roomvent	196	270	100	228	156	27	115	110	140

## Performance

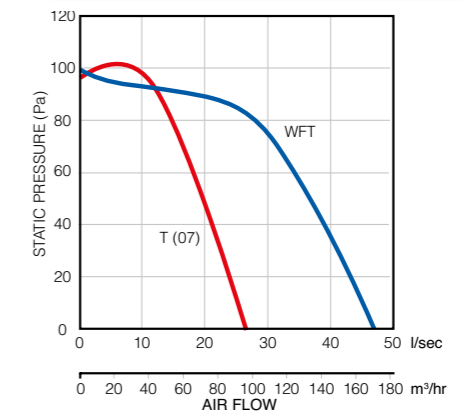

## Controls and Accessories

A range of accessories including flexible and rigid ducting kits, controls, switches and grilles are available.

See accessories section from page 209 for more details.

# Supervent

Kitchen ventilation

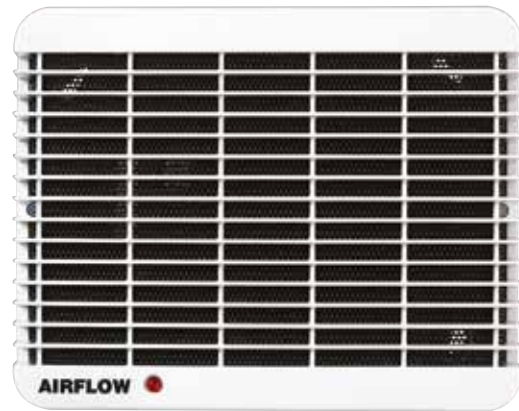

## Key Features

- Powerful centrifugal fan
- Flow rate up to 260 m<sup>3</sup>/hr
- Two speed versions available
- Recess or surface mounted into a wall or ceiling (bezel supplied)
- Window fitting with optional window kit
- Easy to clean, integral, re-usable grease filter
- Thermally protected motor
- Easy to fit with 100mm outlet
- Demco approved
- Integral magnetic backdraught flap
- IPX4 rating
- Complies with Building Regulations
- 3 year warranty

## Supervent range

Highly reliable and powerful centrifugal fan in a modular design for ease of installation and maintenance. The Supervent is designed to provide extraction levels that comply with the latest Building Regulations.

Supervent fans are small in size but big in performance. This range of powerful fans provides compact units that are ideal for almost any kitchen application. A

centrifugal fan that is simple to install and exceptionally versatile, delivering 150mm fan performance levels through 100mm ducting. These are the ideal solution for removing damp moist air, odours and airborne pollutants from kitchens.

The washable, built-in grease filter protects the motor in kitchen applications.



## Models

<b>2 Speed Basic</b>	Manual control by remote switch
<b>Timer</b>	Timer can be set to run on between 5 and 30 minutes Speed adjustment possible on the unit
<b>Humidity Pull Cord</b>	Humidity sensor adjustable between 40 and 90% RH with pull cord override



## Technical Data

Specification	Supervent SV6	Supervent SV6T	Supervent SV6HP
Air flow m <sup>3</sup> /hr	68 / 245*	260	68 / 245 <sup>104</sup>
Air flow l/sec	19 / 68	72	19 / 68
Fan type	Centrifugal	Centrifugal	Centrifugal
Controls	2 Speed / Basic	Timer	Humidity / Pull Cord
Mounting	Wall / Ceiling / Two Room	Wall / Ceiling / Two Room	Wall / Ceiling / Two Room
Sound Pressure dB(A)@3m	38 / 59	59	38 / 59
Power watts	20 / 90	20 / 90	20 / 90
Amps	2	2	2
Building Regulations ADF	Yes	Yes	Yes
Duct diameter (mm)	100	100	100
Voltage	230v / 1ph / 50Hz	230v / 1ph / 50Hz	230v / 1ph / 50Hz
Rating	IPX4	IPX4	IPX4
Material finish	ABS	ABS	ABS
Weight (kg)	2.90	2.90	2.90
Dimensions (H x W x D) mm	200 x 250 x 143	200 x 250 x 143	200 x 250 x 143
Part No.	71908801	72357001	71939302

\* Single speed selectable +Two speed

## Dimensions (mm)

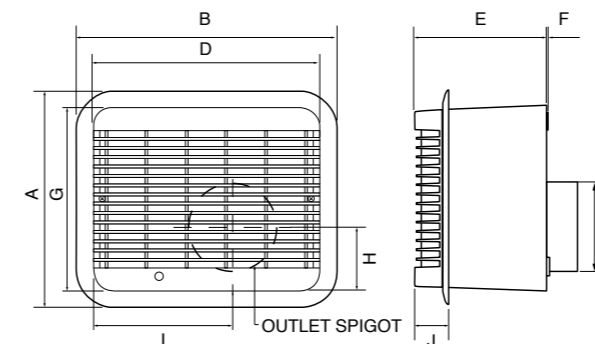

Model	A	B	C	D	E	F	G	H	I	J
Supervent	236	286	97	250	143	2	200	69	153	37

## Performance

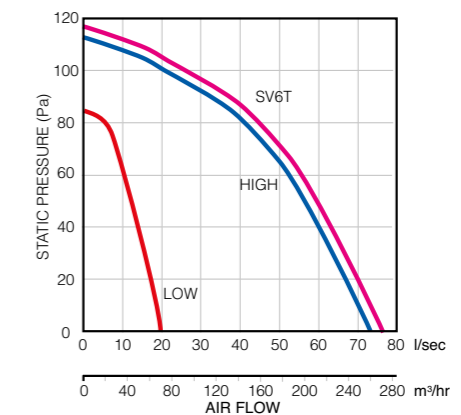

## Controls and Accessories

A range of accessories including flexible and rigid ducting kits, controls, switches and grilles are available.

See accessories section from page 209 for more details.

# Aventa In-Line

Bathroom, en-suite, utility room and kitchen ventilation

## Key Features

- In-line mixed flow fans
- Flow rate up to 280 m<sup>3</sup>/hr
- Designed for ducted installations
- High pressure, low noise
- Compact and quiet in operation
- Two speed (normal and boost)
- Adjustable overrun timer version
- Access to monitor and impeller without dismantling ductwork
- Low watt motor from 21w
- IPX4 rating
- Complies with Building Regulations
- 3 year warranty



## Aventa In-Line range

The Aventa range provides compact, quiet and powerful remote mounted ventilation for ducted installations. Available in high performance, two speed versions they are less bulky than larger in-line centrifugal fans and can be installed in loft spaces or service shafts for remote extraction.

With high flow / high pressure development characteristics they can be used with flexible ducting and flat duct systems to ensure compliance with Building

Regulations guidance ensuring installed performance and extraction conditions are met.

Combining two Aventa fans allows for even more powerful operation. Mounting in parallel (left hand image on facing page) doubles the air flow, whilst two fans in series (right hand image on facing page) leads to a doubling of the air pressure for longer duct runs.



## Applications

- Basic** Basic remote switching
- Timer** Timer can be set to run on between 2 and 30 minutes



## Technical Data

Specification	Aventa 100B	Aventa 100T	Aventa 125B	Aventa 125T
Air flow m <sup>3</sup> /hr*	145 / 187	145 / 187	220 / 280	220 / 280
Air flow l/sec*	40 / 52	40 / 52	66 / 88	66 / 88
Fan type	Mixed Flow	Mixed Flow	Mixed Flow	Mixed Flow
Controls	Basic	Timer	Basic	Timer
Mounting	In-Line	In-Line	In-Line	In-Line
Sound Pressure dB(A)@3m	27 / 36	27 / 36	28 / 37	28/37
Power watts	21 / 33	21 / 33	23 / 37	23/37
Amps	0.11 / 0.21	0.11 / 0.21	0.18 / 0.27	0.18 / 0.27
Building Regulations ADF	Yes	Yes	Yes	Yes
Duct diameter (mm)	100	100	125	125
Voltage	230v / 1ph / 50Hz	230v / 1ph / 50Hz	230v / 1ph / 50Hz	230v / 1ph / 50Hz
Rating	IPX4	IPX4	IPX4	IPX4
Material finish	ABS	ABS	ABS	ABS
Weight (kg)	1.5	1.5	1.5	1.5
Dimensions (H x W x D) mm	190 x 246 x 126	190 x 246 x 126	190 x 246 x 136	190 x 246 x 136
Part No.	9041085	9041086	9041087	9041088

\* Air flow at free discharge

## Dimensions (mm)

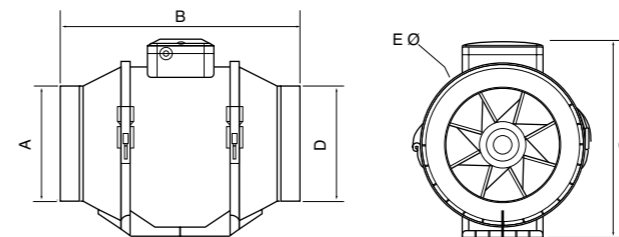

Model	A	B	C	D	E
AV100	96	246	190	126	167
AV125	123	246	190	136	167

Double the flow - mount in parallel



Double the pressure - mount in series



## Performance

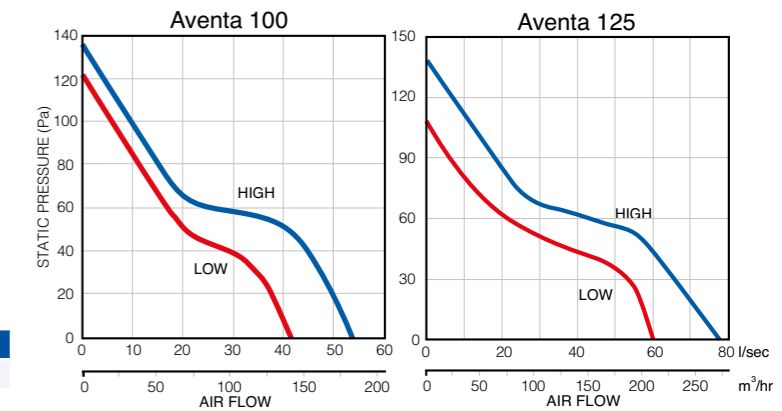

## Controls and Accessories

A range of accessories including flexible and rigid ducting kits, controls, switches and grilles are available.

See accessories section from page 209 for more details.



# Aventa Shower Kit

Shower ventilation

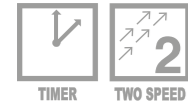

## Key Features

- In-line mixed flow fan
- Flow rate up to 280 m<sup>3</sup>/hr
- Designed for ducted installations
- High pressure, low noise
- Compact and quiet in operation
- Two speed (normal and boost)
- Adjustable overrun timer version
- Access to motor and impeller without dismantling ductwork
- Low watt motor from 25w
- IPX4 rating
- Complies with Building Regulations
- 3 year warranty

## Aventa Shower Kit

The Aventa range provides compact, quiet and powerful remote mounted ventilation for ducted installations.

Available in high performance, two speed versions they are less bulky than larger in-line centrifugal fans and can be installed in loft spaces or service shafts for remote extraction.

With high flow/high pressure development characteristics they are ideal for the longer duct runs. The kit comes with 6m flexible ducting which can be cut to go either side of the fan. This kit meets latest building regulations.



ALWAYS PULL FLEXIBLE DUCTING TAUGHT TO ENSURE INSTALLED PERFORMANCE AIR FLOW.



## Applications

**Timer** Timer can be set to run on between 2 and 30 minutes

## Contents of Kit

- 9041407 AVT 100T, 6m flex duct, ties, extract valve, external grille
- 9041408 AVT 100T, 6m flex duct, ties, halogen light, chrome and white grilles and external grille
- 9041406 AVT 125T, 6m flex duct, ties, extract valve, external grille



## Technical Data

Specification	Aventa 100T Shower Kit	Aventa 100T Shower Kit with Light	Aventa 125T Shower Kit
Air flow m <sup>3</sup> /hr*	145 / 187	145 / 187	220 / 280
Air flow l/sec*	40 / 52	40 / 52	66 / 88
Fan type	Mixed Flow	Mixed Flow	Mixed Flow
Controls	Timer	Timer	Timer
Mounting	In-Line	In-Line	In-Line
Sound pressure dB(A)@3m	27 / 36	27 / 36	28 / 37
Power watts	21 / 33	21 / 33	23 / 37
Amps	0.11 / 0.21	0.11 / 0.21	0.18 / 0.27
Building Regulations ADF	Yes	Yes	Yes
Duct diameter (mm)	100	100	125
Voltage	230v / 1ph / 50Hz	230v / 1ph / 50Hz	230v / 1ph / 50Hz
Rating	IPX4	IPX4	IPX4
Material finish	ABS	ABS	ABS
Weight (kg)	1.5	1.5	1.5
Dimensions (H x W x D) mm	190 x 246 x 126	190 x 246 x 126	190 x 246 x 136
Part No.	9041407	9041408	9041406

\* Air flow at free discharge

## Dimensions (mm)

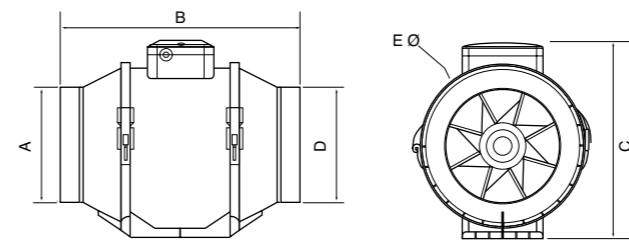

Model	A	B	C	D	E
AV100	96	246	190	96	167
AV125	123	246	190	123	167

## Performance

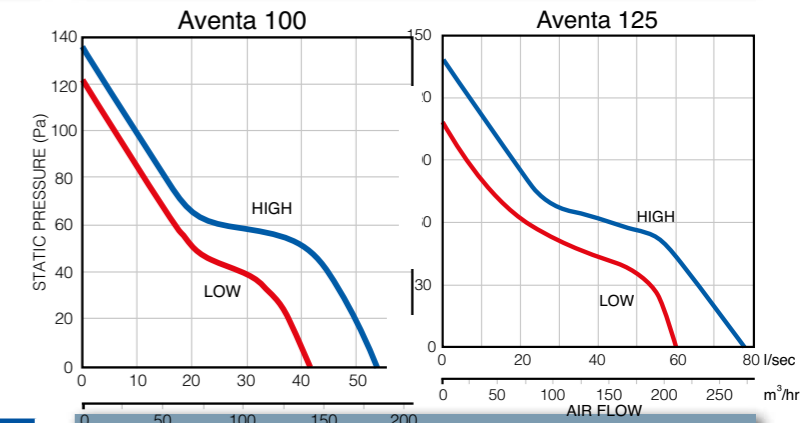

## Controls and Accessories

A range of accessories including flexible and rigid ducting kits, controls, switches and grilles are available.

See accessories section from page 209 for more details.



# Commercial Fans

## Why Ventilate?

AIRFLOW'S extensive range of extract fans are not just for domestic dwellings. Their outstanding performance, ease of installation and aesthetic appeal ensures that they can efficiently complement virtually any installation and help comply with the Building Regulations for non-domestic installations.

Refer to the CIBSE guidelines for recommended air changes per hour in non-domestic installations - see page 22.

### Aventa Silent

In-Line fans can be used in the ceiling void to ventilate areas that require a ducted application.

The perfect choice for ventilation where a ducted solution is required. As the fan is mounted in the ceiling void, noise levels are kept to a minimum in the room.

### Aventa Turbo

In-Line fans which use centrifugal fan technology offering increased pressure performance for larger spaces and commercial applications. The noise level is not an issue as the fan is located in the ceiling void above the area being ventilated.

## KEEP UP TO DATE



For the latest ventilation news, information, product data and application advice

CLICK CALL VISIT

[airflow.com](http://airflow.com)



# Aventa In-Line

Light commercial ventilation



## Key Features

- In-Line mixed flow fan
- Flow rate up to 520 m<sup>3</sup>/hr
- Designed for ducted installations
- High pressure, low noise
- Compact and quiet in operation
- Two speed (normal and boost)
- Adjustable overrun timer version
- Access to motor and impeller without dismantling ductwork
- Low watt motor 30w
- IPX4 rating
- Complies with Building Regulations
- 3 year warranty

## Aventa In-Line range

The Aventa range of in-line fans provides a quiet, powerful and compact remote duct mounted ventilation solution. Units are available in high performance two speed versions. Less bulky than larger in-line centrifugal fans means flexibility of installation. Remote loft space or service shaft location etc is easily achieved.

With high flow/high pressure development characteristics they can be used with flexible ducting and flat duct

systems to ensure compliance with Building Regulations guidance ensuring installed performance and extraction conditions are met.

Combining two Aventa fans allows for even more powerful operation. Mounting in parallel (left hand image on facing page) doubles the air flow, whilst two fans in series (right hand image on facing page) leads to a doubling of the air pressure for longer duct runs.



## Models

- Basic** Basic remote switching
- Timer** Timer can be set to run on between 2 and 30 minutes



## Technical Data

Specification	Aventa 150B	Aventa 150T
Air flow m <sup>3</sup> /hr	405 / 520	405 / 520
Air flow l/sec	112 / 144	112 / 144
Fan type	Mixed Flow	Mixed Flow
Controls	Basic	Timer
Mounting	In-Line	In-Line
Sound Pressure dB(A)@3m	33 / 44	33 / 44
Power watts	30 / 60	30 / 60
Amps	0.17 / 0.27	0.17 / 0.27
Building Regulations ADF	Yes	Yes
Duct diameter (mm)	150	150
Voltage	230v / 1ph / 50Hz	230v / 1ph / 50Hz
Rating	IPX4	IPX4
Material finish	ABS	ABS
Weight (kg)	2.65	2.65
Dimensions (H x W x D) mm	250 x 295 x 185	251 x 295 x 185
Part No.	9041089	9041090

## Dimensions (mm)

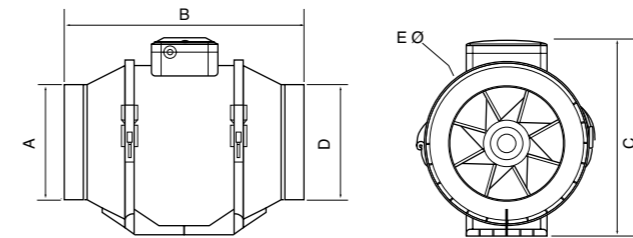

Model	A	B	C	D	E
AV150	146	295	250	146	223



Double the flow - mount in parallel



Double the pressure - mount in series

## Performance

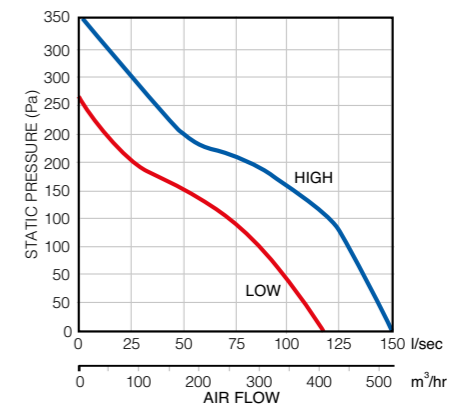

## Controls and Accessories

A range of accessories including flexible and rigid ducting kits, controls, switches and grilles are available.

See accessories section from page 209 for more details.



# Aventa Silent

Domestic and light commercial facilities



## Key Features

- In-Line mixed flow fan
- High performance characteristics - powerful air flow (up to 1020 m<sup>3</sup>/hr) and high pressure
- Sound insulated casing - ensures quiet operation
- Compatible with ducting 100 - 200mm dia
- Energy efficient 2 speed motors
- IPX4 rating
- Complies with Building Regulations
- 2 year warranty

## Aventa Silent

The durable external casing is made of polymer coated steel. The inner casing perforation let's sound waves pass through the holes and fall at a specific angle to the sound absorbing layer. The casing is internally heat and sound insulated with a 50mm mineral layer and the conic impeller with special blade profiling increases air flow speed and provides higher pressure.

The diffuser, specially profiled impeller and directing vanes at the outlet from the fan casing distribute air flow in such a way as to attain the best combination of performance and pressure at low noise levels.

The fans can be mounted at any place or angle within the ductwork. Several fans can be installed in parallel in the same system to achieve a higher air capacity or in series to achieve higher pressure.

Recommended as a component of an air handling systems for commercial and industrial premises where noise levels need to be kept to a minimum, for example, libraries, conference rooms, educational institutions and crèches.

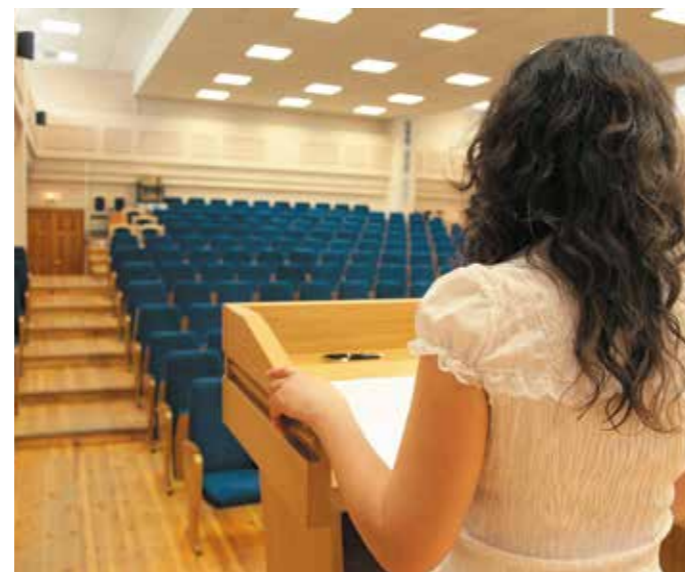

## Models

Basic Control by optional switch (switch not included)



## Technical Data

Specification	Aventa Silent AVS100	Aventa Silent AVS125	Aventa Silent AVS150	Aventa Silent AVS200
Air flow m <sup>3</sup> /hr	170 / 240	230 / 340	405 / 555	810 / 1020
Air flow l/sec	47 / 67	64 / 94	112 / 154	225 / 283
Fan type	Mixed Flow	Mixed Flow	Mixed Flow	Mixed Flow
Controls	Basic	Basic	Basic	Basic
Mounting	In-Line	In-Line	In-Line	In-Line
Sound Pressure dB(A)@3m	24 / 29	23 / 28	26 / 33	31 / 36
Power watts	24 / 26	25 / 30	45 / 52	78 / 110
Amps	0.10 / 0.11	0.11 / 0.13	0.20 / 0.23	0.35 / 0.49
Building Regulations ADF	Yes	Yes	Yes	Yes
Duct diameter (mm)	100	125	150	200
Voltage	230v / 1ph / 50Hz	230v / 1ph / 50Hz	230v / 1ph / 50Hz	230v / 1ph / 50Hz
Rating	IPX4	IPX4	IPX4	IPX4
Material finish	Polymer Coated Steel	Polymer Coated Steel	Polymer Coated Steel	Polymer Coated Steel
Weight (kg)	4.6	4.6	6.1	8
Dimensions (H x W x D) mm	237 x 505 x 243	237 x 474 x 243	260 x 580 x 274	295 x 550 x 386
Part No.	90000358	90000359	90000360	90000361

## Performance

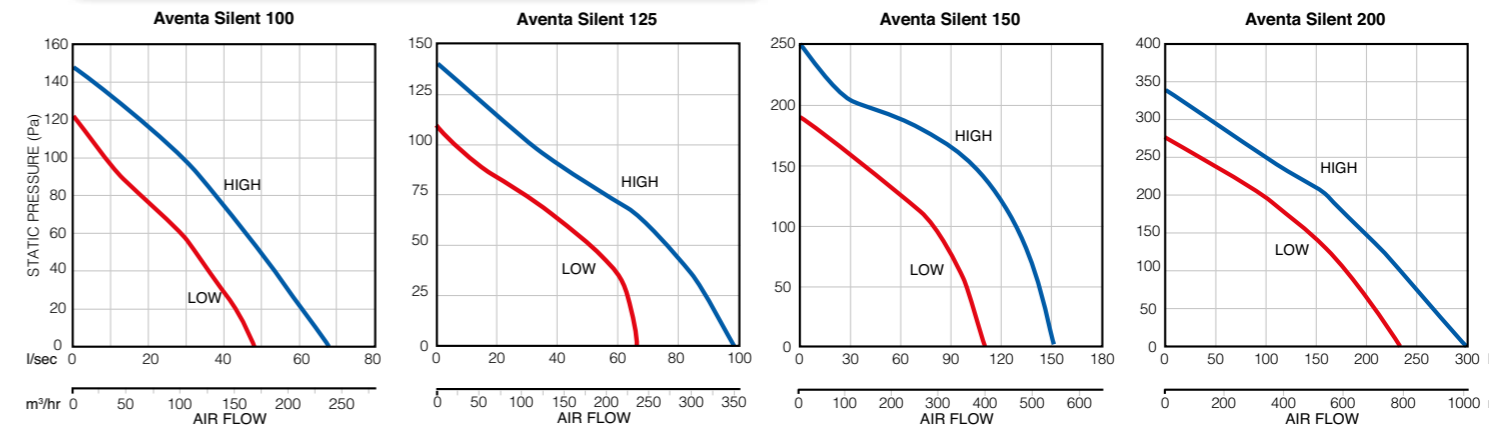

## Dimensions (mm)

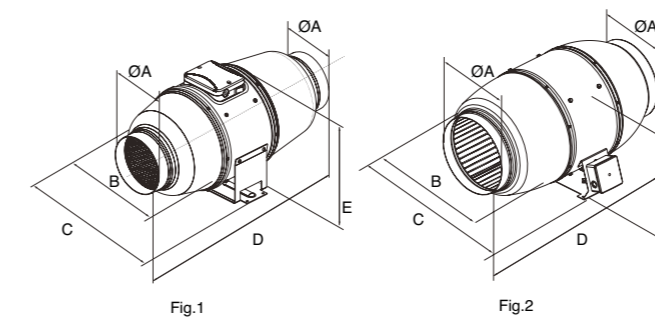

Model	ØA	B	C	D	E	Figure no
AVS100	98	215	243	505	237	1
AVS125	123	215	243	474	237	1
AVS150	147	247	274	580	260	1
AVS200	198	293	386	550	295	2

## Controls and Accessories

A range of accessories including flexible and rigid ducting kits, controls, switches and grilles are available.

See accessories section from page 209 for more details.

# Aventa Turbo

Domestic and light commercial facilities



## Key Features

- In-Line centrifugal fan
- Flow rates up to 1325 m<sup>3</sup>/hr
- Designed for ventilation of medium and large size facilities
- Horizontal or vertical mounting
- Supply or extract air
- High strength plastic body
- Higher pressure capability for longer ducts
- External rotor motor with ball-bearings with thermal protection
- Complete with mounting bracket
- Balanced impeller
- IPX4 rating
- Complies with Building Regulations
- 3 year warranty

## Aventa Turbo

Highly reliable and powerful fan in a modular design for ease of installation and maintenance. The Aventa Turbo series are designed to provide ventilation levels that comply with the latest Building Regulations. Works particularly well against higher system pressure.

Operated by basic switching (switch not supplied), these fans can be installed in loft spaces or service shafts for remote extraction with minimal room noise.

The extensive range of Aventa Turbo fans provide compact, quiet and powerful remote mounted ventilation for ducted installations. Fans can be mounted vertically, horizontally or at an inclined angle for versatility of installation.



## Model

Basic Control by basic switching (switch not included)



## Technical Data

Specification	Aventa Turbo 100B	Aventa Turbo 125B	Aventa Turbo 150B	Aventa Turbo 200B	Aventa Turbo 250B	Aventa Turbo 315B
Air flow m <sup>3</sup> /hr / l/sec	250 / 69	355 / 98	460 / 127	780 / 216	1080 / 300	1340 / 372
Fan type	Centrifugal	Centrifugal	Centrifugal	Centrifugal	Centrifugal	Centrifugal
Controls	Basic	Basic	Basic	Basic	Basic	Basic
Mounting	In-Line	In-Line	In-Line	In-Line	In-Line	In-Line
Sound Pressure dB(A)@3m	46	46	46	48	50	50
Power watts	80	79	80	107	173	200
Amps	0.34	0.34	0.35	0.47	0.76	0.88
Building Regulations ADF	Yes	Yes	Yes	Yes	Yes	Yes
Duct diameter (mm)	100	125	150	200	250	315
Voltage	230v / 1ph / 50Hz	230v / 1ph / 50Hz	230v / 1ph / 50Hz	230v / 1ph / 50Hz	230v / 1ph / 50Hz	230v / 1ph / 50Hz
Rating	IPX4	IPX4	IPX4	IPX4	IPX4	IPX4
Material finish	Plastic	Plastic	Plastic	Plastic	Plastic	Plastic
Weight (kg)	2.15	2.2	2.4	3.0	4.3	4.8
Dimensions (H x W x D) mm	250 x 270 x 230	250 x 270 x 220	300 x 310 x 286	340 x 354 x 276	340 x 354 x 265	400 x 414 x 276
Part No.	9041360	9041361	9041362	9041363	9041364	9041365

## Performance

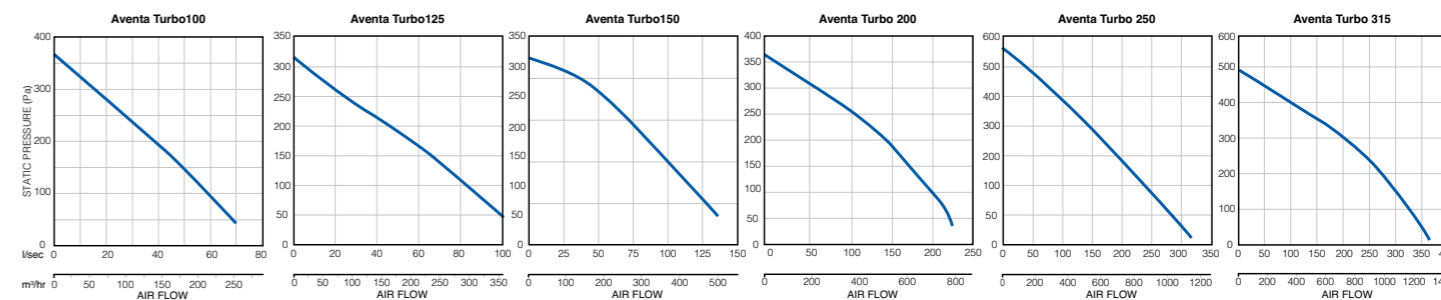

## Dimensions (mm)

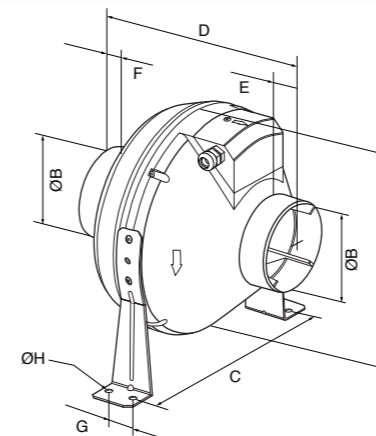

Model	A	B	C	D	E	F	G	H	Dimensions
AVT 100B	100	250	270	230	30	27	30	6	250x270x230
AVT 125B	125	250	270	220	30	27	30	6	250x270x230
AVT 150B	150	300	310	286	30	30	30	6	300x310x286
AVT 200B	200	340	354	276	30	30	40	6	340x354x276
AVT 250B	250	340	354	265	30	30	40	6	340x354x265
AVT 315B	315	400	414	276	40	55	40	6	400x414x276

## Controls and Accessories

A range of accessories including flexible and rigid ducting kits, controls, switches and grilles are available.

See accessories section from page 209 for more details.





# Hand Dryers

## Why ecoDRY?

Airflow Developments Limited have recently re-entered the Hygiene Products market segment with a range of “eco – friendly” hand dryers. The ecoDRY series are very efficient, only using a mere 2.3w per drying cycle. They are exceptionally hygienic with various protection technologies incorporated into the manufacturing process to ensure the product achieves the highest level of protection possible.

Boasting a contemporary design the ecoDRY product will blend into any washroom whilst delivering the performance you would expect of any product from the Airflow stable of products.

### ecoDRY mini

ecoDRY mini hand dryers are available in white or Satin Chrome ABS plastic finishes. Being one of the smallest hand dryers on the market, they are ideal for smaller washrooms and where space is limited. They offer customers an ideal entry level product that excels in the performance/ energy consumption/ cost parameters.

### ecoDRY

ecoDRY 550 hand dryers are available in white ABS plastic and Satin Die Cast Aluminium finishes making them ideal for any washroom. The exceptionally low energy consumption will keep electricity costs at a minimum and help reduce carbon emissions when comparisons are made to other forms of drying your hands.

The new ecoDRY 1100 has a heating element for those who prefer the conventional warm air drying system.

## KEEP UP TO DATE



For the latest ventilation news, information, product data and application advice

CLICK CALL VISIT

[airflow.com](http://airflow.com)



# ecoDRY mini

For use in washrooms



## Key Features

- ABS Plastic – White or Satin Chrome
- Automatic Sensor Operated
- Air speed 200 Km/h
- Air flow 110 m<sup>3</sup>/hr/ 31 l/min
- 28,000 rpm
- 400 watt motor/ 500 watt heating element
- 20 second drying time
- Low noise level 70dB(A) at 2m
- Flow airflow outlet – stream of air
- Smallest hand dryer in class – less than 10cm in depth
- Optimum performance/ energy consumption/ cost ratio
- Optional HEPA filter
- CE, IP23 rating and double insulated
- Electricity Supply 220/240V – 50/60Hz
- 3 Year Warranty

## Hand Dryer

Airflow are pleased to introduce one of the world's smallest hand dryers – the ecoDRY mini. The ecoDRY mini is ideal for washrooms where space is limited as it only protrudes less than 10cm from the wall when fitted. Taking a mere 20 seconds to dry one's hands, it consumes minimal energy and boasts an excellent performance/ energy consumption/ cost ratio making it the ideal choice for customers looking for an entry level hand dryer.

An optional HEPA filter protecting users from 99.997% of air bacteria is available – ensuring clean air on your hands at all times.

ecoDRY mini is another inspiring design Airflow is proud to have in their ecoDRY portfolio of hand dryers.



## Models

White ABS plastic

Chrome ABS plastic



## Technical Data

Specification	ecoDRY mini White	ecoDRY mini Satin
Function	Automatic Sensor	Automatic Sensor
Material	ABS	ABS
Colour	White	Satin Chrome
Absorbion Heating Element	500w	500w
Absorbion Motor	400w	400w
Total Power	900w	900w
Air Speed	200km/h	200km/h
Fan speed	28000 r.p.m.	28000 r.p.m.
Air Flow Performance	110m <sup>3</sup> /hr / 31l/sec	110m <sup>3</sup> /hr / 31l/sec
Drying Time	20 sec	20 sec
Noise Level (at 2m)	70dB(A)	70dB(A)
Protection Rating	IP23	IP23
Electrical Insulation	Class II	Class II
Certification	CE	CE
Weight (Kg)	1.2	1.2
Dimensions (H x W x D)mm	238 x 156 x 99.5	238 x 156 x 99.5
Product Codes	90000520	90000521

## Dimensions

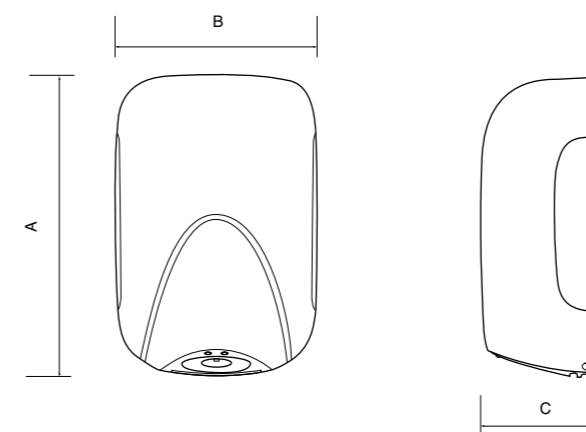

Model	A	B	C
ecoDRY mini	238	156	99.5

## Flow Mechanism



## Consumables / Spare Parts

The HEPA filter and replacement carbon brushes are available on request from your ecoDRY mini stockist or visit: [airflow.com](http://airflow.com)



### Key Features

- White ABS plastic / satin die cast aluminium
- Air flow 126 m<sup>3</sup>/hr / 3500 l/min
- Automatic sensor operated
- LED "Blu" down-lighter when in use
- Air speed from 250 Km/h
- ecoDRY 550 Cool air, only 2.3w per drying cycle
- ecoDRY 1100 Warm air
- Very quick 10 -14 second drying time
- Low noise level from 68 dB(A) at 2m
- Flow air flow outlet - blade / air curtain
- Compact - smallest high speed hand dryer in it's category
- Revolutionary double level anti-bacteria protection system
- Agion® Silver Antimicrobial treated and HEPA filter
- IP23 rating
- 3 year warranty

### 550w - 1100w Hand Dryers

Airflow are proud to present an Eco-Hygienic Drying System – the ecoDRY has double antibacterial protection as the internal plastic parts are treated with Agion® Silver Antimicrobial reducing bacteria by up to 99.9% on the dryer's surfaces. The ecoDRY is also fitted with an advanced HEPA filter protecting users from 99.997% of air bacteria – ensuring clean air on your hands at all times.

ecoDRY offers superior performance in drying time at a very quick 10 – 14 seconds.

ecoDRY 550 cool air unit only consumes 2.3w per drying cycle hence qualifying for Airflow's ecoair accreditation.

ecoDRY 1100 models have heating elements for those who prefer a conventional warm air drying system.

The product boasts a contemporary design with ergonomic features making it stand out from the competition – a drying system to aspire to for your wash room.



### Models

- White ABS plastic
- Satin Die cast aluminium



### Technical Data

Specification	ecoDRY 550 ABS	ecoDRY 550 Satin	ecoDRY 1100 ABS	ecoDRY 1100 Satin
Function	Automatic Sensor	Automatic Sensor	Automatic Sensor	Automatic Sensor
Material	ABS	Die Cast Aluminium	ABS	Die Cast Aluminium
Colour	White	Satin Metal	White	Satin Metal
Absorbtion Heating Element	N/A	N/A	550w	550w
Absorbtion Motor	550w/ 2.3w per drying cycle	550w/ 2.3w per drying cycle	550w	550w
Total Power	550w	550w	1100w	1100w
Air Speed	250km/h	250km/h	325km/h	325km/h
Fan speed	26000 r.p.m.	26000 r.p.m.	30000 r.p.m.	30000 r.p.m.
Air Flow Performance	126m <sup>3</sup> /hr / 35l/sec	126m <sup>3</sup> /hr / 35l/sec	187m <sup>3</sup> /hr / 52l/sec	187m <sup>3</sup> /hr / 52l/sec
Drying Time	10 - 15 sec	10 - 15 sec	10 - 15 sec	10 - 15 sec
Noise Level (at 2m)	68dB(A)	68dB(A)	75dB(A)	75dB(A)
Protection Rating	IP23	IP23	IP23	IP23
Electrical Insulation	Class II	Class II	Class II	Class II
Certification	CE	CE	CE	CE
Weight (Kg)	3,0	5,0	3,0	5,0
Dimensions (H x W x D)mm	285 x 221 x 157	285 x 221 x 157	285 x 221 x 157	285 x 221 x 157
Product Codes	90000242	90000243	90000518	90000519

### Dimensions

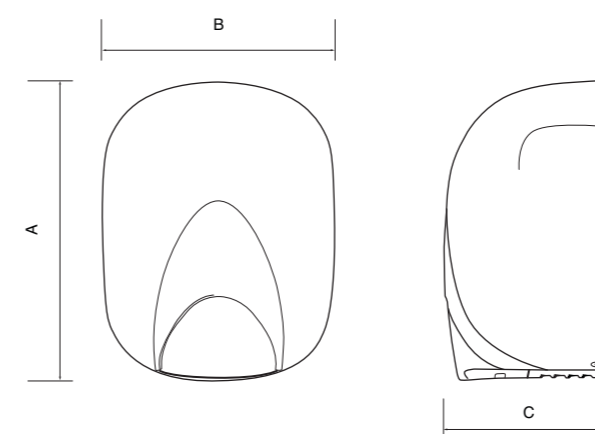

Model	A	B	C
ecoDRY	285	221	157

### Flow Mechanism



### Consumables / Spare Parts

The HEPA filter and replacement carbon brushes are available on request from your ecoDRY stockist or visit: [airflow.com](http://airflow.com)

# Central Extraction

## Why Ventilate?

Airovent mechanical extract ventilation (MEV) provides a choice of continuous, low cost extraction in new and refurbished dwellings. Conveniently centrally located in lofts and cupboards it will provide excellent, low noise extraction from a combination of the bathroom, en-suites, utility room and kitchen through easy to fit ducting.

Alternatively, consider a de-centralised solution (dMEV).

### Airovent

MEV continuously extracts stale, moist air creating a generally healthier environment helping alleviate the problems of dampness and condensation benefitting both the fabric of the building and also occupant health.

### dMEV

An alternative solution for continuous extraction from individual wet rooms is a decentralised mechanical ventilation (dMEV) method. Refer to iCON, iCONstant and LOOVENT eco dMEV products for further details.

## KEEP UP TO DATE



For the latest ventilation news, information, product data and application advice

CLICK CALL VISIT

[airflow.com](http://airflow.com)



# Airovent

Central Extraction



## Key Features

- Continuous operation centrifugal fan
- Flow up to 375 m<sup>3</sup>/hr
- Helps reduce condensation and mould problems
- Low noise, long life EC motors
- Complies with Building Regulations
- Standard units have 3 x 125mm diameter extract connections
- Airflex Pro units have 6 x 75mm diameter extract connections
- All units have 1 x 125mm diameter connection on exhaust
- Low specific fan power
- SAP Appendix Q Eligible

### WHV8, WHV8R, WHV8/6, WHV8R/6

Airovent WHV8 / WHV8R is designed to provide extraction levels that comply with the latest Building Regulations 2010 and is SAP Appendix Q Eligible. With three speed settings for low, medium and high speed extraction WHV8 / WHV8R provide quiet and continuous ventilation. Model WHV8R comes equipped with a remote control and built-in humidity sensor for full remote automation.

### HVS10, HVS10R, HVS10/6, HVS10R/6

Airovent HVS10 is designed to provide extraction levels that comply with the latest Building Regulations 2010 and is Appendix Q Eligible. The HVS10 is an exceptionally quiet and energy efficient whole house ventilation system. It has 18 easily adjustable speed settings for comprehensive air flow control to suit the individual requirements of the dwelling. Model HVS10R comes with a remote control and built-in humidity sensor for full automation and 14 speed settings. Model HVS10/6 comes with a kit included to connect the Airflow's Airflex Pro Zero Leakage Ducting Solution.



## Applications

- Wholehouse mechanical extract ventilation
- New residential properties and refurbishments
- Extracts from multiple rooms simultaneously
- Connects directly to 125mm diameter pipe and now AirflexPro 75mm diameter "Zero Leakage" SAP Appendix Q eligible ducting

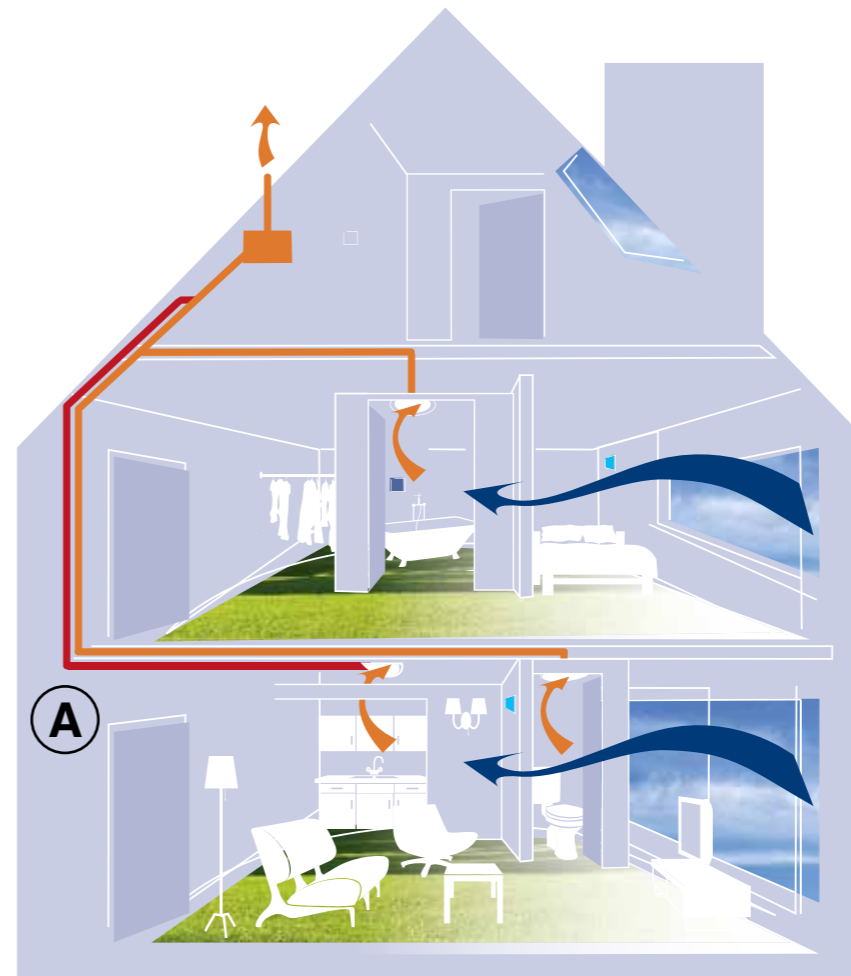
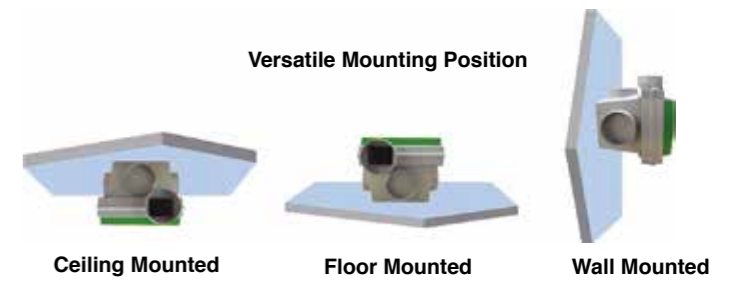

Central Extract Ventilation or "System 3" in the Building Regulations (ADF) is a centrally located, continuously running mechanical extract unit with ducts running to moisture producing areas or "wet rooms", such as kitchens, utility rooms, toilets and bathrooms. Natural ventilation through background ventilators replaces extracted stale moist air within the home, ensuring good indoor air quality.

As technology in fan ventilation has developed further there are now alternatives that can be offered for a System 3 solution.

## dMEV

Continuously running localised fans or dMEV (decentralised mechanical extract ventilation) fans as they are known, may be utilised in place of a centrally running mechanical extract unit ducted to extract areas.

Airflow's tried and tested iCON, LOOVENT eco dMEV and the new iCONstant dMEV fulfil these applications perfectly.

**Fig A** - Illustrates a typical "System 3" or central extract duct layout, focusing on the 'Best Practice' that the toilet extract is separate to, or positioned in line between the kitchen extract and the extract unit.



iConstant dMEV



Refer to pages 74-77

iCON dMEV



Refer to pages 56-61

LOOVENT eco dMEV



Refer to pages 80-81

## Technical Data

Part No.	Model	Low air flow (m³/hr)	Mid air flow (m³/hr)	High air flow (m³/hr)	Power watts	Supply
72649401	WHV8	120	205	335	13/40/73	230 / V / 1Ph / 50Hz
72649501	WHV8R	120	205	335	13/40/73	230 / V / 1Ph / 50Hz
90000362	WHV8/6	120	205	335	13/40/73	230 / V / 1Ph / 50Hz
90000363	WHV8R/6	120	205	335	13/40/73	230 / V / 1Ph / 50Hz
72649601	HVS10	85	248	375	06/26/81	230 / V / 1Ph / 50Hz
72649701	HVS10R	110	200	375	06/12/20	230 / V / 1Ph / 50Hz
90000343	HVS10/6	85	248	375	06/26/81	230 / V / 1Ph / 50Hz
90000364	HVS10R/6	110	200	375	06/12/20	230 / V / 1Ph / 50Hz

## Dimensions (mm)

### Airovent WHV8, WHV8R, HVS10, HVS10R

Figure 1

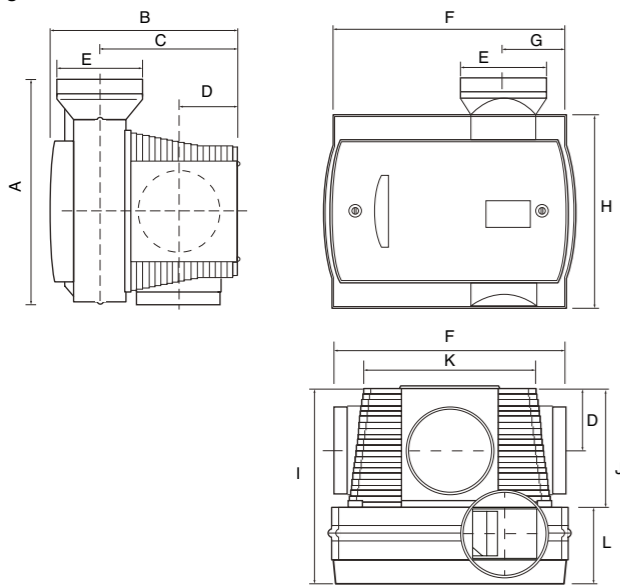

Figure 1	A	B	C	D	E	F	G	H	I	J	K	L
	330	275	205	88	124	340	82	280	275	166	252	112

### Airovent WHV8/6, WHV8R/6, HVS10/6, HVS10R/6

Figure 2

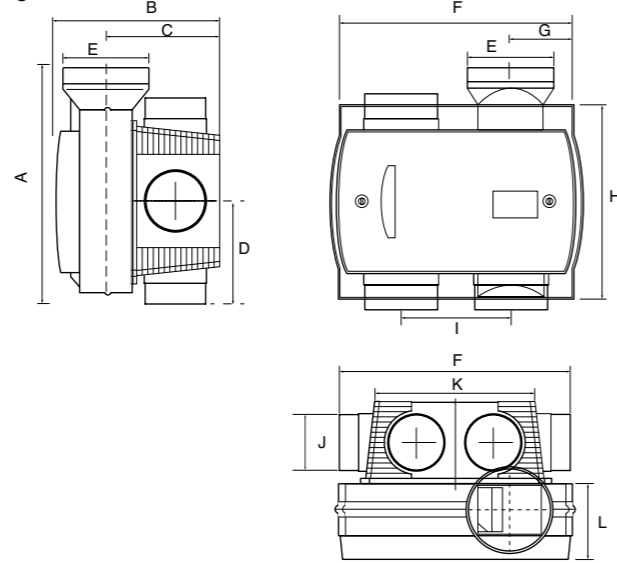
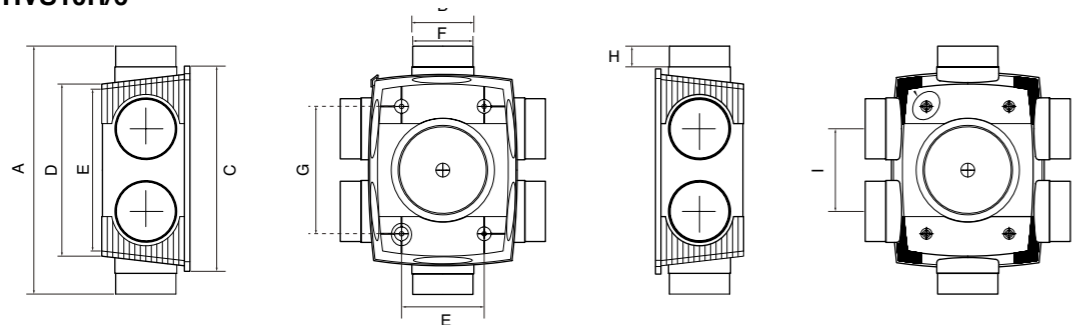

Figure 2	A	B	C	D	E	F	G	H	I	J	K	L
	330	245	136	148	124	340	82	280	120	150	252	112

### Rear box dimensions for WHV8/6, WHV8R/6, HVS10/6, HVS10R/6



Rear box	A	B	C	D	E	F	G	H	I
	360	90	298	250	120	87.5	185	30	120

## Performance

### WHV8, WHV8R, WHV8/6, WHV8R/6

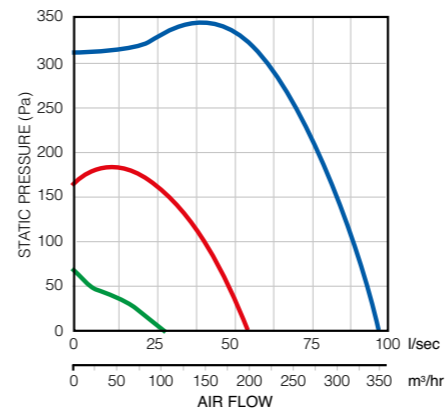

### HVS10, HVS10/6

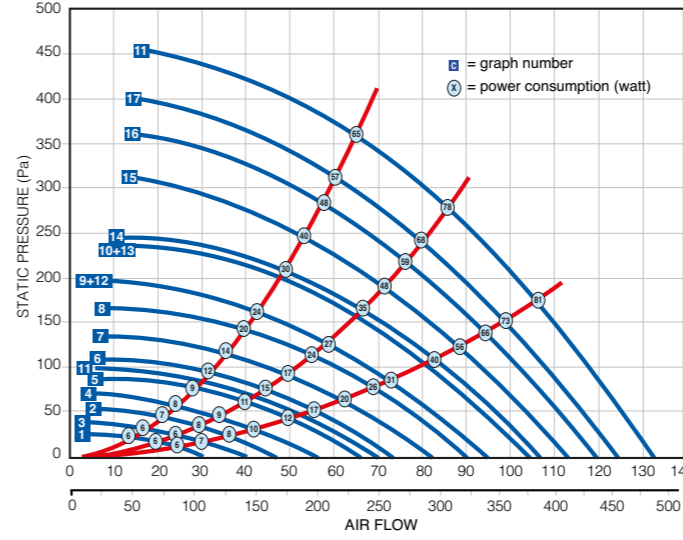

### HVS10, HVS10/6

Position	Airflow (m³/h)	(PA)
1. Low	85	10
2. Low	127	21
3. Middle	95	12
4. Middle	142	25
5. Middle	170	45
6. Middle	200	50
7. Middle	225	65
8. Middle	248	75
9. Middle	255	85
10. Middle	270	92
11. High	195	48
12. High	255	85
13. High	270	92
14. High	290	110
15. High	320	130
16. High	335	140
17. High	350	150
18. High	375	175

### HVS10R, HVS10R/6

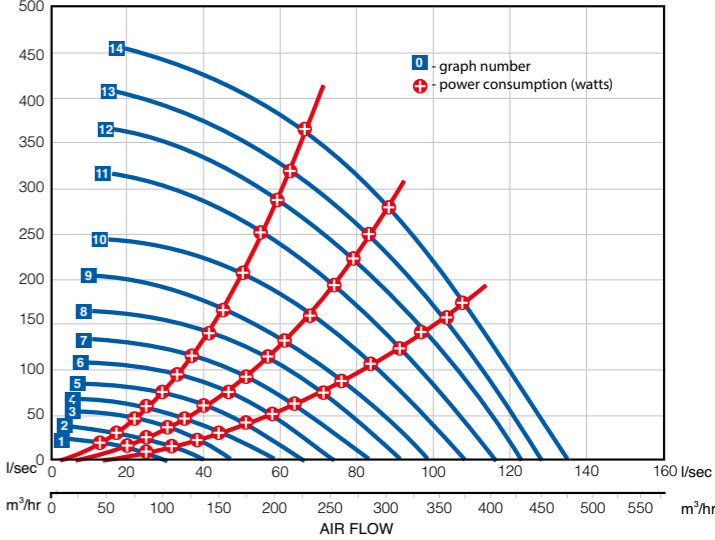

### HVS10R, HVS10R/6

Position	Airflow (m³/h)	(PA)
*1. Low	85	10
2. Low	110	15
3. Middle	127	21
*4. Middle	150	34
5. Middle	170	45
6. Middle	200	50
*7. High	225	65
8. High	248	75
9. High	270	85
10. High	290	110
11. High	320	130
12. High	335	140
13. High	350	150
14. High	375	175

## Controls and Accessories

A range of accessories including flexible and rigid ducting kits, controls, switches and grilles are available.

See accessories section from page 209 for more details.



# Ventilation with Heat Recovery

A human being usually consumes about one kilogram of food and two litres of water each day - but at least 15,000 litres of air. Of this, up to 90% may consist of indoor air.

An effective ventilation system within a dwelling will protect the building fabric and occupants against potentially harmful condensation, mould growth and other airborne pollutants that are present in today's dwellings.

## Duplexvent Residential

- Duplexvent ventilation units with heat recovery for single room and wholehouse applications.
- Providing solutions for top or side entry, cooker-hood and false ceiling installations the units deliver an excellent thermal efficiency and incorporate a range of control options such as manual, digital and touch-screen panel.
- Available with 100% bypass, triple filter and built-in frost and / or post-heater.
- Internet connectivity options.

## Duplexvent Commercial

- Duplexvent ventilation units with heat recovery for light commercial and industrial applications.
- Used for comfort ventilation, warm-air heating and cooling of dwellings the units achieve the highest thermal efficiency (**up to 95%**) and were the first **Passive House Institute certified** Commercial MVHR units in the UK.

Extra benefits include low energy, low noise EC fans, internet connection with smart phone application, BMS connection (ModBus, KNX, BACnet), automatic frost protection, built-in heating/cooling coils, air circulation and automatic 100% bypass.

## KEEP UP TO DATE



For the latest ventilation news, information, product data and application advice

CLICK CALL VISIT

[airflow.com](http://airflow.com)



# Why Heat Recovery Ventilation?

## Increased air permeability

With ever increasing energy costs the need to conserve heat and power is leading to higher levels of insulation and air tightness in residential dwellings and commercial buildings.

The resulting poor indoor climate can lead to health problems for occupants and long term damaging effects to the fabric of a building.

A condition now known as Toxic Home Syndrome.

## Fresh, filtered air is the answer

In a healthy home thousands of litres of fresh air is needed everyday to compensate for the moisture generated by each individual person, and also through cooking, washing and bathing.

Duplexvent provides continuous mechanical ventilation with heat recovery for the supply of controlled, fresh, filtered air while extracting potentially harmful, unwanted moisture and airborne pollutants.

The lack of effective ventilation within a well sealed environment increases the prevalence of airborne contaminants, odours and smells which together with high levels of humidity and condensation all add to an unhealthy environment.

If left unchecked the development of dampness leads to mould growth and the spread of mites which can increase the likelihood of headaches, allergies and the development of asthma in children.

It helps to save energy too by re-claiming waste heat from extracted air that would otherwise be lost and returning it via the incoming fresh air into the dwelling.

By adding back warmed, fresh air the traditional heating system will run for shorter periods of time, this will give tangible benefits in reducing energy consumption.



# Creating a Healthier Environment

## What is Heat Recovery?

**Heat recovery is a process of continuously preheating incoming cool supply air by warming it with the outgoing exhaust air.**

Warm air is not simply exhausted but transfers most of its heat to supply air in a highly efficient heat recovery exchanger. At no time do the airstreams mix as the heat radiates through the plates of the exchanger.

## What is Heat Recovery Efficiency?

**Heat recovery efficiency is the utilising of waste heat to warm fresh incoming air.**

Generally speaking efficiency above 80% is considered excellent.

The heat recovery efficiency for DUPLEXVENT units can be over 90% (the efficiency depends on the air velocity, the size of the heat exchanger and the indoor humidity level).

The heat recovery exchanger is fitted directly in the ventilation unit. This allows use of heat recovery in all building types such as flats, apartments, family houses and residential accommodation.

Larger units can be installed in commercial buildings, swimming pools, retail and industrial buildings.

Duplexvent units also incorporate a "By-Pass" mechanism so that in summer supply air is not warmed unnecessarily.

Heat recovery exchangers can be used even in air-conditioned buildings where during the summer season it serves as cold recovery. Incoming warm air is cooled by air-conditioned exhaust air.

## Fresh Air for a Healthy Environment

**For the maintenance of the building fabric and for a healthy indoor climate, controlled mechanical ventilation is essential.**

Energy savings are achieved by improved insulating measures and by the use of heat recovery. Carbon emissions in the dwelling are also reduced with the contribution of heat recovery. Just as important is that there is a healthy and comfortable climate in highly insulated buildings. Research proves that people living, working or studying in inadequately ventilated buildings suffer from more ailments such as headaches and allergies.

On average, humans spend 90% of their lives in closed buildings. Therefore, it is of prime importance to provide healthier indoor air, free from odours, high humidity and airborne pollutants.

## Extract Air

**Stale air is contaminated with humidity, toxins and smells extracted from the kitchen, bathroom and toilet.**

Extract valves in toilets and wet room areas, such as the bathroom, en-suite, utility and kitchen allow a constant or demand oriented air flow volume to be extracted, matched to the users' individual needs or room demands. Much of the heat of the extracted air is retained by the exchanger and transferred to the incoming fresh outdoor air.

## Supply Air

**Fresh air is fed directly from outside into the ventilation system through a filter.**

The heat taken from the extracted air is used to warm the fresh filtered air in the exchanger and then flows through ducting to termination points such as air valves or air inlets into the living rooms and bedrooms. By undercutting doors and fitting transfer grilles fresh air circulation is ensured throughout the dwelling.

## Duplexvent

- Meets Building Regulations, Approved Document F, System 4
- Saves energy by reducing heating costs
- Extracts airborne pollutants that can cause allergies and asthma
- Supplies warmed, filtered air to living spaces
- Removes condensation and humidity from wet rooms
- Reduces carbon dioxide levels that can cause headaches and drowsiness
- Clears odours, tobacco smoke and cooking smells
- Eliminates dampness and mould growth
- Helps reduce the dwellings carbon footprint (DER)
- SAP-APPENDIX Q eligible and Passive House approved models

# Duplexvent Professional

Heat Recovery Ventilation

## Key Components

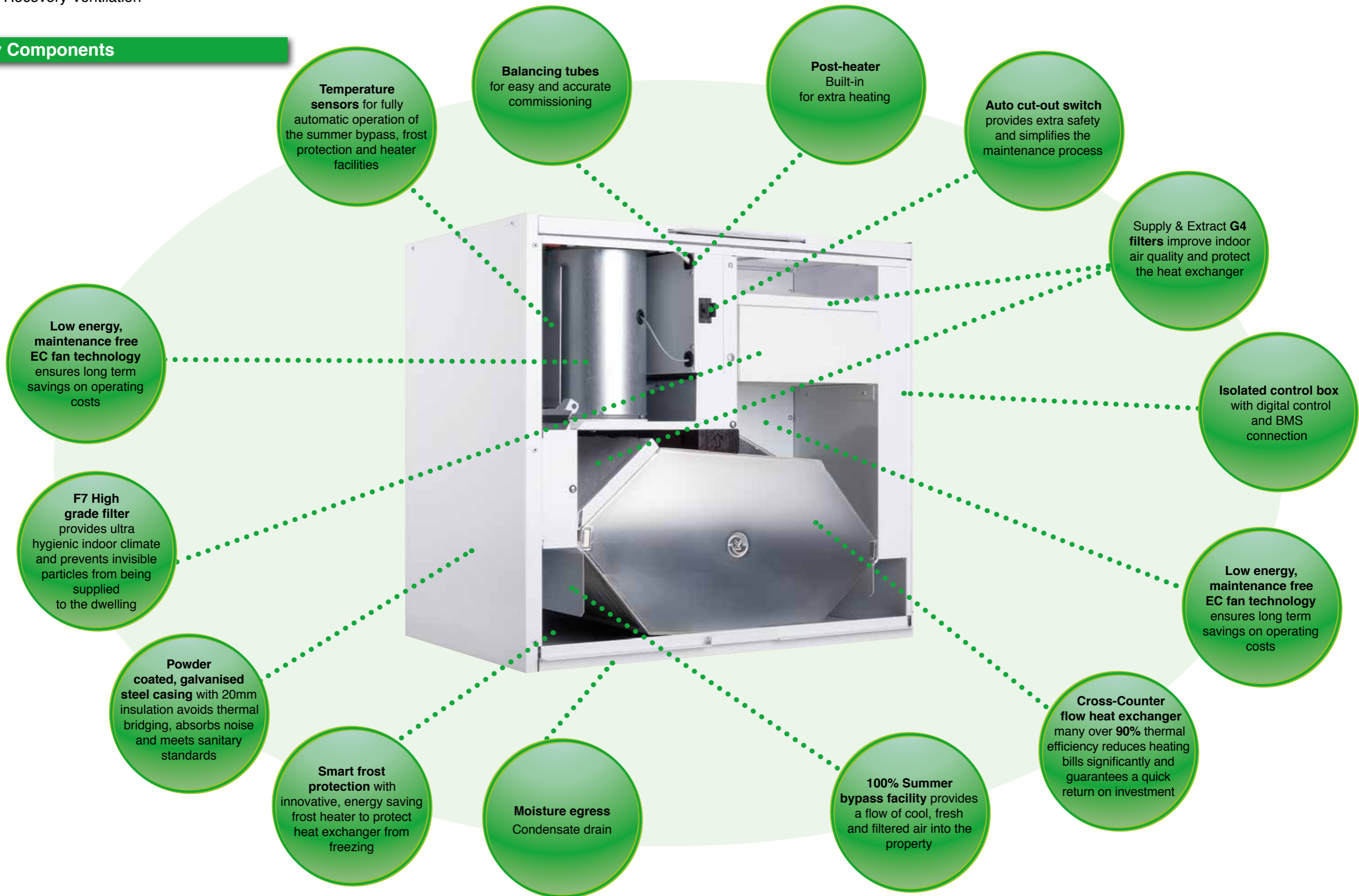

# Ventilation with Heat Recovery

## Residential

The indoor climate is of the utmost importance as most of us spend the greater part of our lives indoors. To ensure comfort and a sense of well-being, the air we breathe should be clean, and also be at the right temperature and humidity level.

Whatever the situation, Duplexvent Mechanical Ventilation with Heat Recovery solutions can play a significant role as they help create a healthier living environment whilst saving valuable energy.

### Duplexvent Basic Line

A range of compact, entry level mechanical ventilation units with heat recovery designed for social housing, private sector apartment blocks and terraced houses. The units provide high efficiency, low power consumption and low noise balanced ventilation solutions which help meet current Building Regulations.

### Duplexvent Professional Line

A range of Passive House Institute certified heat recovery units designed for private and social family houses which combine high performance with premium quality. Available with unique triple filter and digital control, these units ensure air comfort with advanced control functions such as automatic summer bypass and the heater assisted smart frost protection.

### Duplexvent Interactive Line

A range of internet enabled, mechanical ventilation units with heat recovery for remote monitoring and control in residential applications. They are designed for comfortable and healthy ventilation in both private and social dwellings such as low energy and passive family houses, flats and high rise apartments.

# Duplexvent UNO DV40

Single Room Unit – Up to 150 m<sup>3</sup>/hr air volume



## Key Features

- For use in single rooms up to 60 m<sup>2</sup> \*
- Fully balanced ventilation with simultaneous supply and extract air
- Easy to install through the wall (no central ducting)
- Over 90% thermal efficiency
- Silent operation – 30-38 dB(A)
- Built-in electric post-heater
- Automatic frost protection
- Three speed digital / wireless control
- Boost with timer function
- Built-in G4 filters with maintenance indicator
- 3 year warranty\*

## Duplexvent UNO DV40

The Duplexvent UNO DV40 is a single room heat recovery unit designed to provide balanced ventilation for social and commercial premises plus residential properties. It is ideal for retro-fitting into existing buildings as the unit can be installed easily through the wall that does not involve any central ducting saving on installation time and system cost.

Unlike all the other single room heat recovery units on the market, the Duplexvent UNO DV40 is equipped with two fans and a plastic counter-flow heat exchanger which deliver balanced supply and extract air ventilation at all times with a heat recovery efficiency exceeding 90%.

The unit has a metal polymer coated casing finished in a mirror polished stainless steel. The 10mm synthetic rubber insulation provides sound insulation and avoids thermal bridging.

The automatic frost protection prevents condensate freezing in cold periods whereas two G4 filters clean the indoor air and protect the internal components of the unit. In addition, the built-in post-heater warms the supply air to a comfortable level if needed.

Having the low energy EC fans the unit consumes as little as 9 watts and comply with the ErP 2015 standards.

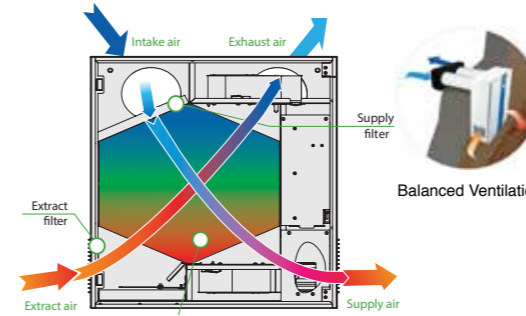

## Technical Data

Specification	Duplexvent UNO DV40
Max. Air Flow m <sup>3</sup> /hr / l/sec @ 0 Pa	150 / 42
Thermal efficiency	Over 90%
Heat exchanger	Counterflow (Plastic)
Fans	EC
Frost protection	Reducing supply air
Controls	3-Speed (digital/wireless)
Mounting	Wall
Sound level @ 3m (dB(A))	30 - 38
Duct diameter (mm)	2 x 125
Electrical supply	230v / 1ph / 50Hz
Max. power consumption	40w
Filter class	2 x G4
Electric post-heater	350w
Protection class	IP22
Casing insulation (mm)	10
Weight (kg)	20
Dimensions (L x D x H) mm	500 x 200 x 580
Part No.	90000400

## Controls

The Duplexvent UNO DV40 is equipped with a digital display which is located on the front cover plus a wireless controller allowing adjustments from anywhere within the room. Speeds 1, 2 and 3 produce an air capacity of 60, 105 and 150 m<sup>3</sup>/hr respectively. Additional functions on the control panel include:

- Extra heating of supply air
- Separate fan control
- Boost activation timer adjustable between 20 and 60 minutes
- Weekly ventilation programming
- Filter replacement and condensation drain pan level indicator



\* Guidance only. Dependant upon system pressure.

## Dimensions

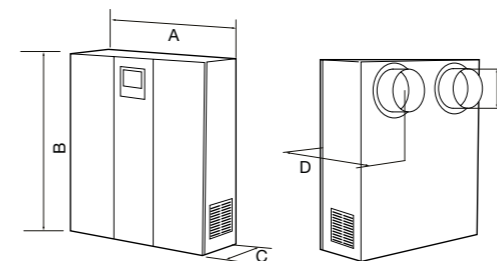

+ excludes motors

Model	A	B	C	D	E
UNO DV40	500	580	200	260	ø125

## Quick Installation



# Duplexvent DV72

Basic Line Top Entry - Up to 280 m<sup>3</sup>/hr air volume



## Key Features

- For use in small and medium sized dwellings up to 125 m<sup>2</sup>\*
- Extracts up to 235 m<sup>3</sup>/hr at 100 Pa
- Over 90% thermal efficiency
- Thermal summer by-pass
- Energy efficient EC fans ensure low SFP
- Fits inside a 600mm kitchen cupboard
- In-built frost protection
- Ceiling suspended version available (DV72CS)
- Independantly adjustable fans
- SAP-Appendix Q eligible
- Complies with Building Regulations
- 1 year warranty

## Duplexvent DV72

Duplexvent DV72 is a high performance heat recovery unit which provides a cost-effective solution for residential dwellings.

This MVHR unit is equipped with an easily removable polypropylene, ultra-high efficiency heat exchanger which transfers more than 90% of the warmth from the outgoing waste airstream into the incoming fresh air.

A thermal by-pass helps to avoid dwelling overheating in summer.

Thanks to its extremely compact size the Duplexvent DV72 can be mounted in a standard kitchen cupboard or on the wall vertically which provides a space-saving solution especially for small and medium size dwellings.

Our SAP Appendix Q eligible DV72 and AIRFLEX PRO ducting system create a perfect solution with highly efficient heat recovery and Zero Leakage air transfer which provide ventilation levels that meet the latest Building Regulations 2010 (Approved Document F).

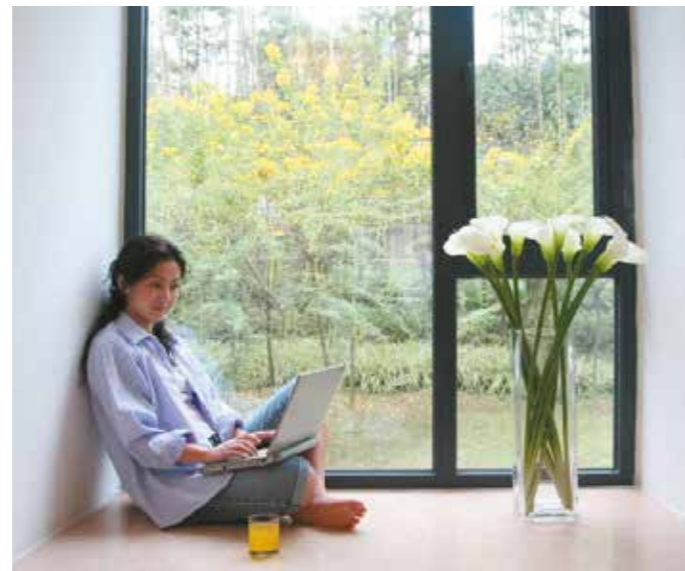

## SAP Appendix Q

Tested by the BRE (Building Research Establishment) and eligible for the SAP Appendix Q

DV72	SFP	Efficiency
K+1 Wet room	0.60 W/l/s	91%
K+2 Wet rooms	0.68 W/l/s	90%
K+3 Wet rooms	0.84 W/l/s	89%
K+4 Wet rooms	0.99 W/l/s	88%

## Technical Data

Specification	Duplexvent DV72 R	Duplexvent DV72CS L
Max. air flow m <sup>3</sup> /hr / l/sec @ 0 Pa	280 / 78	280 / 78
Air flow m <sup>3</sup> /hr / l/sec @ 100 Pa	235 / 65	235 / 65
Thermal efficiency	Over 90%	Over 90%
Heat exchanger	Counterflow (Plastic)	Counterflow (Plastic)
Fans	EC	EC
Controls (normal and boost)	2-Speed	2-Speed
Mounting	Wall	Wall
Sound level @ 3m (dB(A))	28 - 45	28 - 45
Duct diameter (mm)	4 x 125	4 x 125
Condensate discharge (mm)	22	2 x 22
Electrical supply	230v / 1ph / 50Hz	230v / 1ph / 50Hz
Max. power consumption	150w	150w
Filter class	2 x G3	2 x G3
Thermal by-pass	Yes	Yes
Electric post-heater	1200w (optional)	1200w (optional)
Electric frost protection	Yes	Yes
Protection class	IPX2	IPX2
Weight (kg)	14	14
Dimensions (L x H x D) mm	560 x 635 x 260	560 x 635 x 260
Part No.	90000556	90000557

## Dimensions

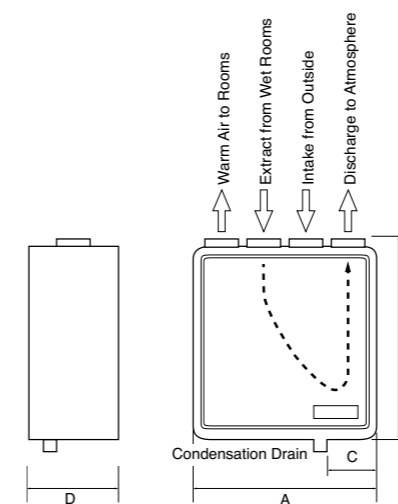

Model	A	B	C	D = DEPTH
DV72	560	635	173.5	260



DV72 installed in a kitchen cupboard

## Controls

A separately mounting commissioning switch is supplied with the unit. Two, 100% user adjustable speed levels can be set on installation. In addition both fans can be independently adjusted to ensure a balanced system upon commissioning. Also accepts boost function switches (not supplied). An automatic thermal summer by-pass will activate when the supply air temperature reaches 25°C to prevent dwelling overheating via heat exchanger.



## Performance

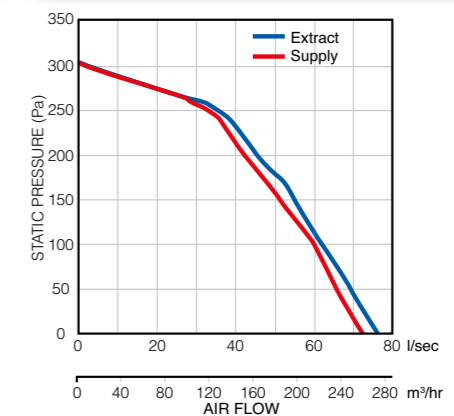

\* Guidance only. Dependant upon system pressure.

## Accessories

See switches/accessories pages 209-239 for more details.

# Duplexvent BV400

Basic Line Top Entry - Up to 475 m<sup>3</sup>/hr air volume



## Key Features

- For use in medium and large sized dwellings up to 230 m<sup>2</sup>\*
- Air volume up to 425 m<sup>3</sup>/hr @ 100 Pa
- Low energy EC fans with 0.45 W/l/s SFP
- Over 90% thermal efficiency
- Automatic summer bypass and frost protection
- Filter monitoring via pressure sensors
- Easy installation via interchangeable spigots
- Tamperproof operation for extra safety
- Data logging capability
- SAP Appendix Q eligible
- Complies with Building Regulations
- 3 year warranty\*

## Duplexvent BV400

Duplexvent BV400 is one of the latest additions to Airflow's Duplexvent Basic Line which provide balanced ventilation with high efficiency heat recovery, low power consumption and quiet operation to modern residential dwellings.

Designed for price-sensitive large-scale projects to help meet current Building Regulations this MVHR unit also complies with the Energy Saving Trust Best Practice.

Equipped with the new generation Radical Range fans, the unit achieves very low SFP levels thus providing house builders and developers with reduction in Dwelling Emission Rates (DER).



## SAP Appendix Q

Tested by the BRE (Building Research Establishment) and eligible for the SAP Appendix Q

BV400	SFP	Efficiency
K+1 Wet room	0.49 W/l/s	93%
K+2 Wet rooms	0.45 W/l/s	92%
K+3 Wet rooms	0.48 W/l/s	92%
K+4 Wet rooms	0.53 W/l/s	92%
K+5 Wet rooms	0.59 W/l/s	91%
K+6 Wet rooms	0.69 W/l/s	90%
K+7 Wet rooms	0.83 W/l/s	90%

## Technical Data

Specification	Duplexvent BV400
Max. air flow m <sup>3</sup> /hr / l/sec @ 0 Pa	475 / 132
Air flow m <sup>3</sup> /hr / l/sec @ 100 Pa	425 / 118
Thermal efficiency	Over 90%
Heat exchanger	Counterflow (Plastic)
Fans	EC
Summer bypass damper	Automatic
Frost protection	Reducing supply air
Controls	3-Speed + Boost
Mounting	Floor / Wall
Sound Level @ 3m (dB(A))	23 - 41
Duct diameter (mm)	4 x 160
Condensate discharge	22mm
Electrical supply	230v / 1ph / 50Hz
Max. power consumption	180w
Filter class	2 x G4 (F7 optional)
Electric frost heater	1000w (optional)
Electric post-heater	1000w (optional)
Protection class	IP43
Weight (kg)	41
Dimensions (L x H x D) mm	710 x 725 x 630
Part No.	90000312

## Dimensions

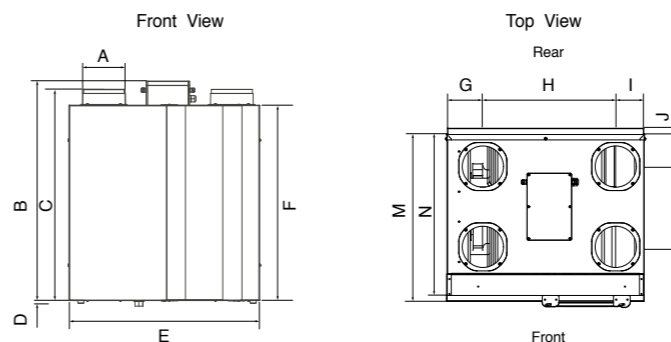

+ excludes motors

Model	A	B	C	D	E	F	G	H	I	J	K	L	M	N
BV400	160	797	731	10	710	725	130	475	103	23	116	287	630	610

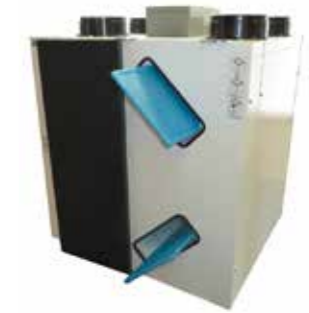

Easy maintenance through the filter access door

## Sound Curve

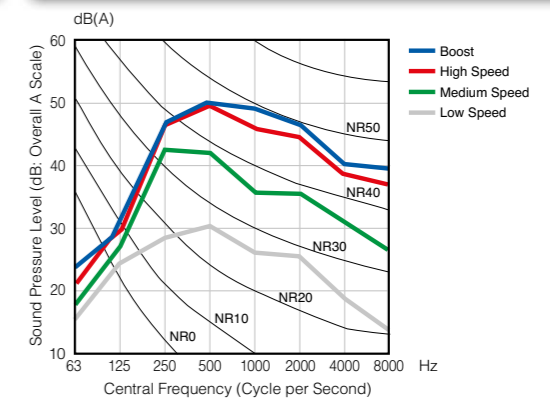

## Performance

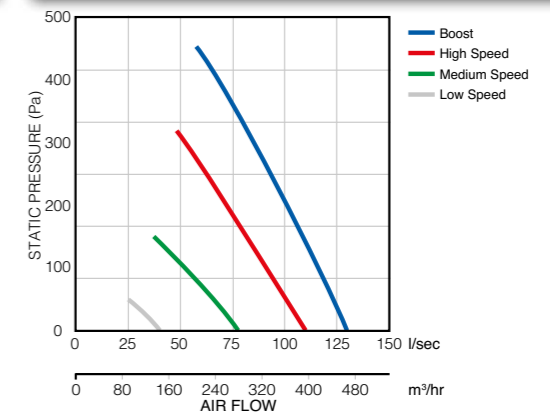

\* Guidance only. Dependant upon system pressure.

## Accessories

See switches/accessories pages 209-239 for more details.



# Duplexvent BV400

Basic Line Top Entry - Up to 475 m<sup>3</sup>/hr air volume

## Versatile Unit Configuration

The unit is supplied as a right handed version as standard. Thanks to the universal condensate drain the unit can easily be changed to the left hand configuration by swapping the front and rear covers.

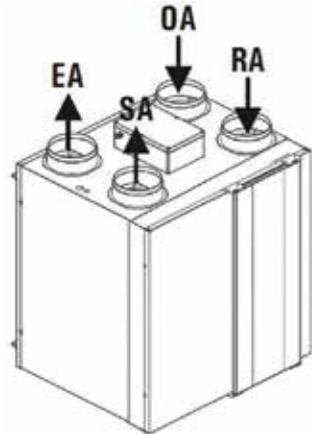

Duplexvent BV400  
(right handed - standard delivery)

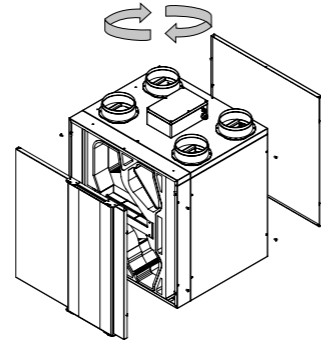

Removing the front and rear covers

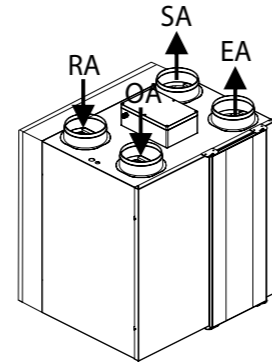

Duplexvent BV400  
(left handed)

## Simple Control

Simple control incorporates the following features:

- 3 speed control, low and high speeds are 100% adjustable via potentiometers, medium speed is calculated automatically.
- Boost function increases air flow when needed. Manual boost with run-on timer / automatic boost with delay timer.
- Childproof protection locks / unlocks the buttons providing extra safety.
- Filter maintenance reminder via counter clock (standard) / via pressure sensor (optional).
- Heater control for frost heater and post-heater.
- Connection to BMS via Modbus RTU (RS485).
- Self Diagnostic.
- On-demand control via humidity and PIR sensors.



## Digital Control

Advanced digital control also provides:

- Optional separate fan control for ease of commissioning.
- Weekly ventilation programming allows users to pre-set the ventilation levels scheduled for different days.
- Data logging capability keeps record of unit's operation.
- Optional humidity or air quality sensors enable automatic boost control.
- Indoor temperature control based on room, extract or supply air temperature.



## BV400 Simple vs Digital Control

Functions	Simple Control	Digital Control
Three speed control (Low - Medium - High)	✓	✓
Automatic bypass	✓	✓
Boost with timer	✓	✓
Frost protection	✓	✓
Frost heater control	✓	✓
Post-heater control	✓	✓
Indoor temp setting via extract / supply / room temp		✓
Separate fan control		✓
Weekly ventilation programming		✓
Data logging		✓
Filter maintenance indicator via counter clock	✓	✓
Filter maintenance indicator via pressure sensor	✓	✓
Demand control via humidity/CO <sub>2</sub> /PIR sensors	✓	✓
Emergency shut-off (in case of fire etc.)	✓	✓
Self diagnostic	✓	✓
BMS connection (MODBUS RS485)	✓	✓
Built-in humidity/air quality sensor		✓
Set temperature adjustments		✓
Set timer adjustments		✓
Constant flow function		✓

## Spigot Relocation

The Duplexvent BV400 has a number of options regarding the position of the four entry/exit spigots. This enables more flexibility when positioning the heat recovery unit and ducting. It is possible to configure the unit for bottom entry connection should space consideration for connecting duct runs necessitate it.

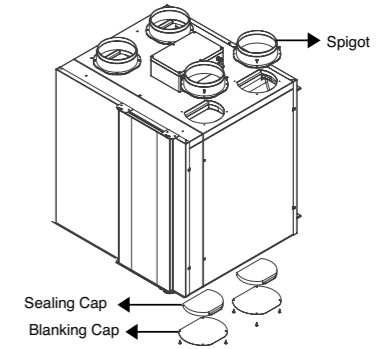

Duplexvent BV400 spigot relocation

## Filter Maintenance Indication

On the standard BV400 a counter clock is available to alert the user for maintenance at the pre-set time period.

Alternatively, an additional pressure sensor is used to monitor the real-time filter status. This provides more accurate and cost-efficient maintenance.

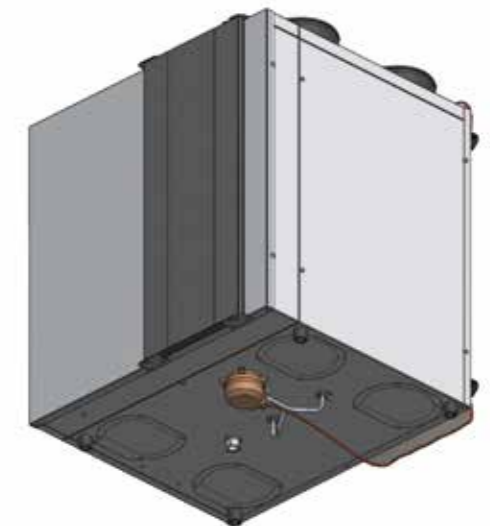

Filter pressure sensor connected at the bottom of the unit



# Duplexvent DV250/300/400

Basic Line Side Entry - Up to 425 m<sup>3</sup>/hr air volume



## Key Features

- For use in small, medium and large sized dwellings up to 220 m<sup>2</sup>\*
- 3 models (side entry) up to 400 m<sup>3</sup>/hr at 100 Pa
- Compact size (280mm height) provides space saving solutions
- Over 90% thermal efficiency and low noise
- Automatic, 100% summer bypass
- Can be installed on the wall, under the ceiling or on the floor
- Light weight enables one man installation
- Simple manual switch as standard. Optional touch screen panel with advanced controls
- Compliant to ErP 2015 standards
- Complies with Building Regulations
- 2 year warranty\*

## Duplexvent DV250/300/400

The Duplexvent Basic Line DV250, DV300 and DV400 are highly efficient, side entry mechanical supply and extract ventilation units with heat recovery for an air capacity of up to 425 m<sup>3</sup>/hr.

The unit casing is made of high density EPP material which provides significant insulation, eliminates any thermal bridging.

The units include an easily removable, plastic heat exchanger which transfers warmth from the outgoing waste airstream into the incoming fresh air where its thermal efficiency exceeds 90%. At no point do the airstreams mix.

Having the latest, low energy EC fan technology, the DV250, DV300 and DV400 comply with the ErP 2015 standards and are tested by TUV laboratories.



## 100% Automatic Bypass

The units are equipped with an automatic, 100% bypass which totally isolates the heat exchanger so that no air passes through it. This provides effective cooling in the summer season.

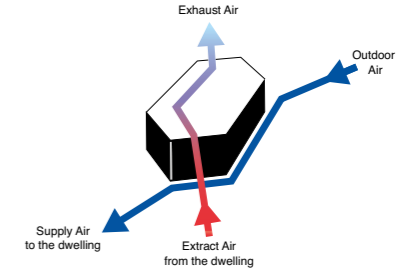

## Technical Data

Speciation	Duplexvent DV250	Duplexvent DV300	Duplexvent DV400
Max. air flow m <sup>3</sup> /hr / l/sec @ 0 Pa	280 / 78	330 / 92	425 / 118
Air flow m <sup>3</sup> /hr / l/sec @ 100 Pa	250 / 69	300 / 83	400 / 111
Thermal efficiency	Over 90%	Over 90%	Over 90%
Heat exchanger	Counterflow (Plastic)	Counterflow (Plastic)	Counterflow (Plastic)
Fans	EC	EC	EC
Summer bypass damper	100% automatic	100% automatic	100% automatic
Frost protection	Reducing supply air	Reducing supply air	Reducing supply air
Controls	Variable Speed Controller Touch screen panel (optional)	Variable Speed Controller Touch screen panel (optional)	Variable Speed Controller Touch screen panel (optional)
Mounting	Wall / Ceiling / Floor	Wall / Ceiling / Floor	Wall / Ceiling / Floor
Sound level @ 3m (dB(A))	28-40	34-42	36-46
Duct diameter (mm)	4 x 160	4 x 160	4 x 160
Condensate discharge	14mm	14mm	14mm
Electrical supply	230v / 1ph / 50Hz	230v / 1ph / 50Hz	230v / 1ph / 50Hz
Max. power consumption	120w	120w	220w
Filter class	2 x G4 (optional F7)	2 x G4 (optional F7)	2 x G4 (optional F7)
Electric frost heater	400w (optional)	700w (optional)	1700w (optional)
Electric post-heater	400w (optional)	700w (optional)	1700w (optional)
Protection class	IP22	IP22	IP22
Weight (kg)	20	21	21
Dimensions (L x D x H) mm	850 x 280 x 660	850 x 280 x 820	850 x 280 x 820
Part No.	90000397	90000398	90000399

## Dimensions

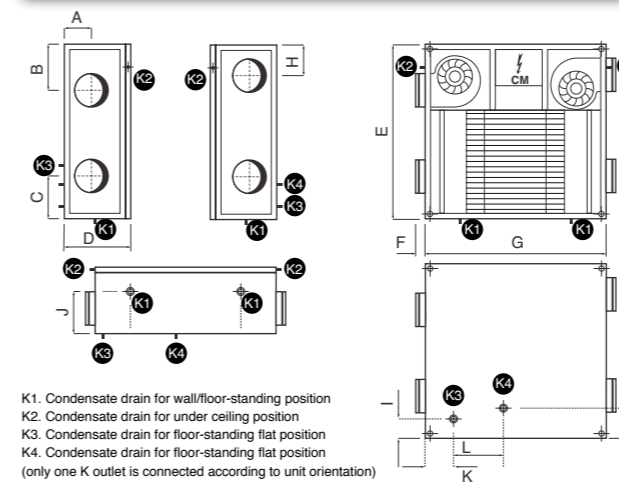

K1. Condensate drain for wall/floor-standing position  
 K2. Condensate drain for under ceiling position  
 K3. Condensate drain for floor-standing flat position  
 K4. Condensate drain for floor-standing flat position  
 (only one K outlet is connected according to unit orientation)

+ excludes motors

Model	A	B	C	D	E	F	G	H	I	J	K	L	M
DV250	100	210	190	280	660	45	850	135	65	198	120	425	90
DV300/400	100	210	190	280	820	45	850	135	65	198	120	435	90

## Performance

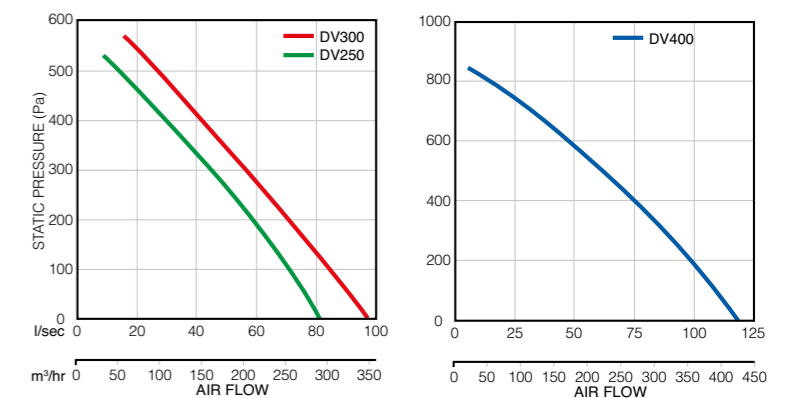

\* Guidance only. Dependant upon system pressure.

## Accessories

See switches/accessories pages 209-239 for more details.

# Duplexvent DV250/300/400

Basic Line Side Entry - Up to 425 m<sup>3</sup>/hr air volume

## Mounting Positions

Unique to these side entry units is the ability to install the same unit at:

- **Wall / Floor - standing position**
- **Ceiling - flat position**  
(with inclination for drainage)
- **Floor - flat position**  
(with inclination for drainage)

This provides exceptional flexibility in product specification, installation and storage.



## Simple Control

Simple control incorporates the following features:

- **Variable speed control** 100% adjustable by the user
- **Automatic boost function** increases air flow when needed (via volt-free contact or 0-10V sensor output)
- **Automatic frost protection** reduces the supply ventilation rate for a certain period to prevent ice build-up within the heat recovery cell depending on the outside air temperature
- **Automatic summer bypass** provides free cooling in the summer season. Its motorised damper is triggered by the temperature sensor automatically
- **Heater control** for frost heater and post-heater



## Touch Screen Control

Additionally, the digital control provides the following features:

- **Stylish Touch Screen** with easy-to-use interface
- **Weekly ventilation programming** allows users to pre-set the ventilation levels scheduled for different days.
- **Party / Holiday mode** to set the air volume for specific time period based on occupancy.
- **Filter Maintenance reminder**
- **Indoor temperature control and display** based on;  
Extract air temperature  
Supply air temperature



## Internet Connection

The Duplexvent Basic Line side entry units can optionally be equipped with a web server that uses Modbus TCP/IP protocol to provide a connection between the ventilation unit and the internet via a standard plug and play ethernet cable.

This allows you to monitor and control the unit from a computer, laptop or smart phone via the internet or a local area network. The unit can also be monitored remotely by technical service which saves time and cost on service processes.



## Heaters

The new generation PTC (Positive Temperature Coefficient) electric heater incorporates a power adjustment facility which automatically increases/decreases the power based on the air volume going through the heater hence shortens the heating response.

Also the heater has two protection thermostats and a perforated metal filter which can easily be maintained via the inspection door. This significantly increases its life span especially when the heater is installed on the incoming air side for frost protection purposes. Alternatively it can be used as post-heater to achieve the required indoor air temperature.



## Metal Housing

To achieve better sound levels the units can optionally be covered with a metal jacket which is made of galvanised metal sheet.

This special accessory also protects the unit from external damage and extends the life span of the unit.



# Duplexvent DV90SCK

Professional Line Top Entry - Up to 330 m<sup>3</sup>/hr air volume

## Key Features

- For use in medium sized dwellings up to 160 m<sup>2</sup>\*
- Extract up to 306 m<sup>3</sup>/hr at 100 Pa
- Galvanised steel, double skin casing
- Cooker-hood provides separate extraction
- Triple filter design with F7 pollen filter
- Over 90% thermal efficiency and low SFP
- Manual 100% summer bypass
- New smart frost protection
- Built-in electric post-heater
- Auto cut-out switch for extra safety
- SAP-Appendix Q eligible
- Complies with Building Regulations
- 5 year warranty\*



## Duplexvent DV90SCK

The Duplexvent DV90SCK is a ventilation unit with state-of-the-art technology, designed to provide both essential ventilation and to save you money through its intelligent, cost effective and eco-friendly heat recovery system.

The unit is delivered with a stylish cooker hood which incorporates an integral fire damper providing fire safety between the hood and the MVHR unit. The unit can be integrated into a fitted kitchen design.

It also includes a grease filter which protects the MVHR unit against particles such as cooking oil extracted through the cooker hood.

Unlike all other MVHR units with cooker hood on the market, the DV90SCK recovers heat even when the separate cooker hood extract is in operation. This important feature prevents cold air draughts especially in winter and keeps your house warm at all times.



## SAP Appendix Q

Tested by the BRE (Building Research Establishment) and eligible for the SAP Appendix Q

DV90	SFP	Efficiency
K+1 Wet room	0.73 W/l/s	81%
K+2 Wet rooms	0.72 W/l/s	82%
K+3 Wet rooms	0.80 W/l/s	82%
K+4 Wet rooms	0.91 W/l/s	83%
K+5 Wet rooms	1.06 W/l/s	82%

## Technical Data

Specification	Duplexvent DV90SCK R	Duplexvent DV90SCK L
Max. air flow m <sup>3</sup> /hr / l/sec @ 0 Pa	330 / 92	330 / 92
Air flow m <sup>3</sup> /hr / l/sec @ 100 Pa	306 / 85	306 / 85
Thermal efficiency	Over 90%	Over 90%
Heat exchanger	Counterflow (Plastic)	Counterflow (Plastic)
Fans	EC	EC
Summer bypass damper	100% automatic	100% automatic
Frost protection	Frost heater	Frost heater
Controls	4-Speed - Manual (on cooker hood)	4-Speed - Manual (on cooker hood)
Mounting	Wall	Wall
Sound Level @ 3m (dB(A))	24 - 45	24 - 45
Duct diameter (mm)	4 x 125	4 x 125
Condensate discharge (mm)	12	12
Electrical supply	230v / 1ph / 50Hz	230v / 1ph / 50Hz
Max. power consumption	182w	182w
Filter class	2 x G4 / 1 x F7	2 x G4 / 1 x F7
Electric frost/post-heater	900w	900w
Protection class	IP34	IP34
Casing Insulation (mm)	12	12
Weight (kg)	52	52
Dimensions (L x D x H) mm	597 x 582 x 798 (incl. cooker hood)	597 x 582 x 798 (incl. cooker hood)
Part No.	9041576	9041577



## Dimensions

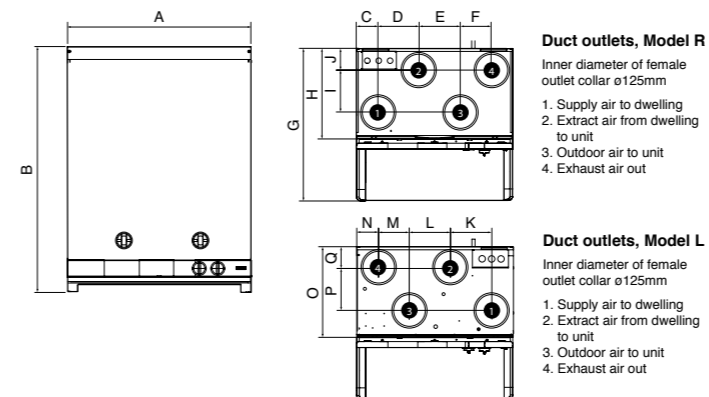

+ excludes motors

Model	A	B	C	D	E	F	G	H
DV90SCK	597	798	83	158	157	117	582	345.5
I	J	K	L	M	N	O	P	Q
160	83	158	157	117	83	345.5	160	83

## Performance

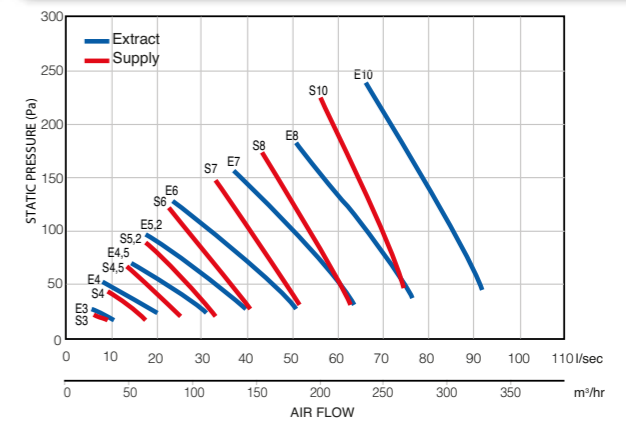

\* Guidance only. Dependant upon system pressure.

## Accessories

See switches/accessories pages 209-239 for more details.



# Duplexvent DV90SCK

Professional Line Top Entry - Up to 330 m<sup>3</sup>/hr air volume

The unit is made of a galvanised steel double-skin casing which is powder coated both internally and externally to meet hygiene requirements. Moreover, the 12mm thick insulation in the casing avoids any thermal bridging and significantly reduces noise levels.

The DV90SCK includes an easily removable, plastic heat exchanger which transfers warmth from the outgoing waste airstream into the incoming fresh air where its thermal efficiency exceeds 90%. At no point do the airstreams mix.

The unit includes the brand new smart frost protection facility which significantly reduces the energy consumed to protect the heat exchanger from freezing (see below for more information). Fitted with an additional electric

post-heater, the unit keeps the indoor air temperature at the required temperature level at all times hence saving energy especially during the winter period.

The DV90SCK unit is designed with a unique triple filter facility including a F7 pollen filter which provides additional protection against invisible, harmful particles and creates an ultra hygienic environment, particularly relevant for those suffering from asthma or other respiratory conditions.

Having the latest, low energy EC fan technology, the DV90SCK complies with the ErP 2015 standards. The unit comes with an outstanding 5 year warranty\* and is SAP Appendix Q eligible.

## New Smart Frost Protection

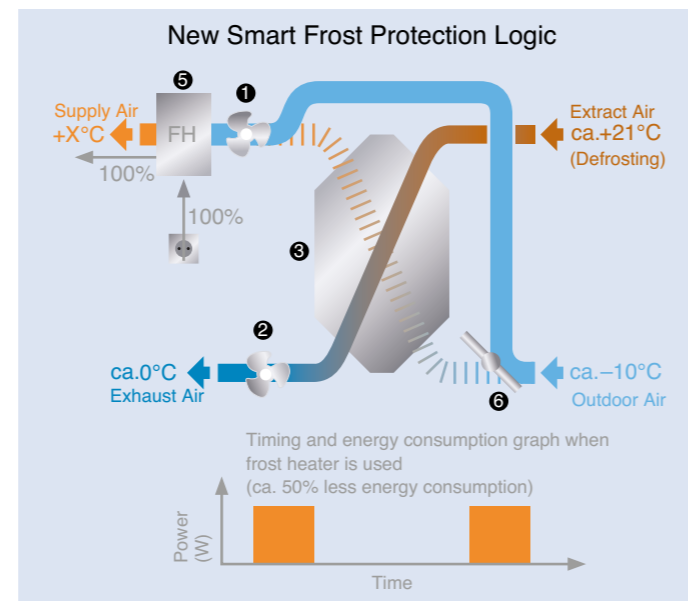
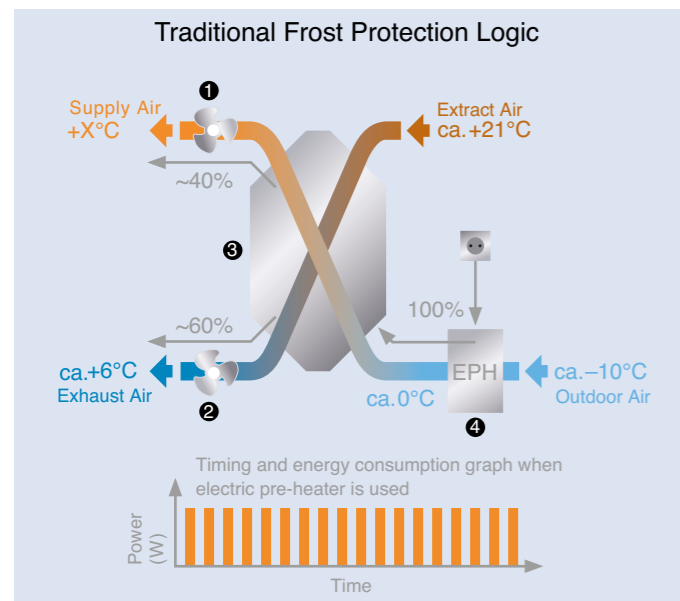

On the traditional frost protection method, the outdoor air is pre-heated before passing through the heat exchanger. This way the unit could still provide balanced ventilation even when the frost protection was on. However, the electric heater kicks in intermittently hence consumes more energy than needed.

The new Smart Frost Protection method works in a more energy efficient manner which constantly monitors the heat exchanger conditions and uses the frost heater only when necessary. This significantly reduces the energy consumption and provides more heat recovery throughout the winter season.

- 1 Supply air fan
- 2 Exhaust air fan
- 3 Heat exchanger
- 4 Electric pre-heater
- 5 Frost heater
- 6 Electric bypass damper

## Triple Filter Design

The majority of the MVHR units in the U.K incorporate G3 or G4 coarse filters on the extract / supply air side. These filters catch only coarse particles such as insects and leaves to protect the heat exchanger.

F7 fine filters on the other hand are highly efficient, catch invisible particles such as pollen, spore, bacterium and dust entering the lungs.

**Duplexvent Professional Line units are the only MVHR units which incorporate triple filter design combining G4 course filters with the F7 fine filter. This significantly improves the indoor air quality and lowers your maintenance costs.**



## 100% Automatic Bypass

The unit is equipped with an automatic, 100% bypass which totally isolates the heat exchanger so that no air passes through it. This provides effective cooling in the summer season.

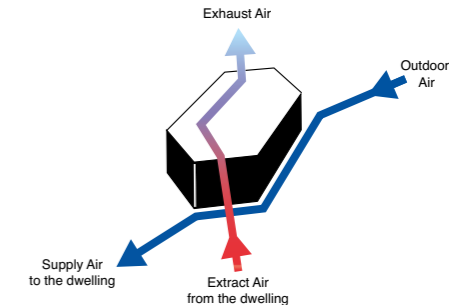

## Controls

### Duplexvent Slim-Line Cooker Hood

**Colour options of white or grey**

Duplexvent Slim-Line cooker hoods are equipped with a handy sliding glass panel which incorporates a fluorescent lamp.

The hoods have detachable grease filters which can be easily maintained.

**Power is adjusted via an integrated four speed switch.**

### Four Speed Switch

An alternative to the cooker hood control is the manually operated 4 speed switch which allows simple unit operation when required.

- Easy to install
- Manual selection of the fan speed
- 100% adjustable speed levels
- User friendly for quick and simple control.



# Duplexvent DV96SE

Professional Line Top Entry - Up to 345 m<sup>3</sup>/hr air volume



## Key Features

- For use in medium sized dwellings up to 175 m<sup>2</sup> \*
- Extract up to 320 m<sup>3</sup>/hr at 100 Pa
- Galvanised steel, double skin casing
- Triple filter design with F7 pollen filter
- Over 90% thermal efficiency and low SFP
- New smart frost protection
- Built-in electric post-heater
- Automatic, 100% summer bypass
- Auto cut-out switch for extra safety
- Eight speed digital control with LCD display and BMS (LON / KNX) connection
- SAP Appendix Q eligible and PASSIVE HOUSE Institute certified
- Complies with Building Regulations
- 5 year warranty\*

## Duplexvent DV96SE

The Duplexvent DV96SE is a highly efficient mechanical supply and extract ventilation unit with heat recovery for an air capacity of up to 345 m<sup>3</sup>/hr. It is a wall mounted unit and is delivered complete with a wall mounting plate and condensate drain.

The unit is made of a galvanised steel double-skin casing which is powder coated both internally and externally to meet hygiene requirements.

Moreover, the 20mm thick insulation in the casing avoids any thermal bridging and significantly reduces noise levels.

The DV96SE includes an easily removable, plastic heat exchanger which transfers warmth from the outgoing waste airstream into the incoming fresh air where its thermal efficiency up to 90%. At no point do the airstreams mix.



## SAP Appendix Q

Tested by the BRE (Building Research Establishment) and eligible for the SAP Appendix Q

DV96SE	SFP	Efficiency
K+1 Wet room	0.99 W//s	87%
K+2 Wet rooms	0.92 W//s	87%
K+3 Wet rooms	0.99 W//s	87%
K+4 Wet rooms	1.12 W//s	86%
K+5 Wet rooms	1.26 W//s	86%

## Technical Data

Specification	Duplexvent DV96SE R	Duplexvent DV96SE L
Air flow m <sup>3</sup> /hr / l/sec @ 100 Pa	324 / 90	324 / 90
Thermal efficiency	Up to 90%	Up to 90%
Heat exchanger	Counterflow (Plastic)	Counterflow (Plastic)
Fans	EC	EC
Summer bypass damper	100% automatic	100% automatic
Frost protection	Frost heater	Frost heater
Controls	8-Speed - Digital	8-Speed - Digital
Connection to BMS	LON / KNX (optional)	LON / KNX (optional)
Mounting	Wall	Wall
Sound level @ 3m (dB(A))	24 - 45	24 - 45
Duct diameter (mm)	4 x 125	4 x 125
Condensate discharge (mm)	12	12
Electrical supply	230v / 1ph / 50Hz	230v / 1ph / 50Hz
Max. power consumption	224w	224w
Filter class	2 x G4 / 1 x F7	2 x G4 / 1 x F7
Electric frost/post-heater	900w	900w
Protection class	IP34	IP34
Casing insulation (mm)	20	20
Weight (kg)	53	53
Dimensions (L x D x H) mm	600 x 430 x 543	600 x 430 x 543
Part No.	90000393	90000394

## Dimensions

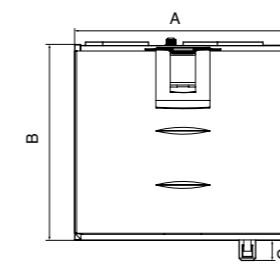

**Duct outlets, model R**  
Inner diameter of female outlet collar ø 125 mm  
1. Supply air to dwelling  
2. Extract air from dwelling to unit  
3. Exhaust air out  
4. Outdoor air to unit

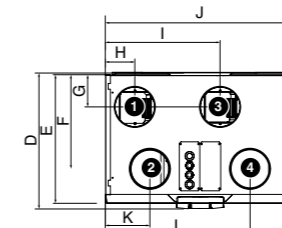

**Duct outlets, model L**  
Inner diameter of female outlet collar ø125mm  
1. Exhaust air out  
2. Outdoor air to unit  
3. Supply air to dwelling  
4. Extract air from dwelling to unit

+ excludes motors

Model	A	B	C	D	E	F	G	H	I	J	K	L
DV96SE	600	545	55	430	407	298	102	93	363	600	141	459



## Passive House Certification

The Duplexvent DV96SE is tested and certified by the Passive House Institute based on the following criteria:

- Thermal comfort
- Effective heat recovery
- Electric power consumption
- Air tightness
- Balancing adjustability
- Sound insulation
- Indoor air quality
- Frost protection



## Performance

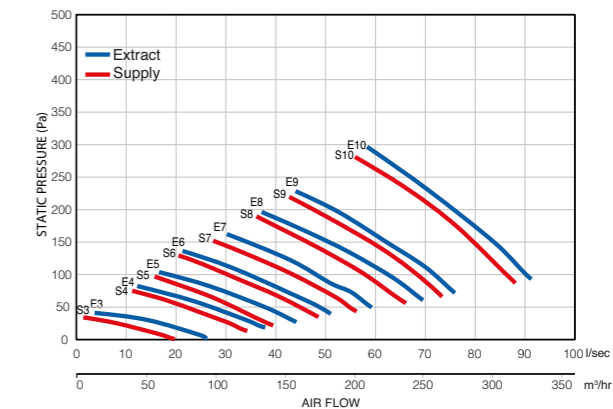

\* Guidance only. Dependant upon system pressure.

## Accessories

See switches/accessories pages 209-239 for more details.

# Duplexvent DV96SE

Professional Line Top Entry - Up to 345 m<sup>3</sup>/hr air volume

Fitted with an additional electric post-heater, the unit keeps the indoor air temperature at the required temperature level at all times hence maintains indoor air comfort whilst saving energy during the winter period.

The DV96SE is designed with a unique triple filter facility including a F7 pollen filter which provides additional protection against invisible, harmful particles and creates an ultra hygienic environment, particularly relevant for those suffering from asthma or other respiratory conditions.

The unit includes a digital controller with LCD display which incorporates 8-speed air flow control, weekly ventilation programming, filter maintenance indicator, separate fan control for easy commissioning and the brand new smart frost protection facility which significantly reduces the

energy consumed to protect the heat exchanger from freezing (see below for more information).

On-demand ventilation can be achieved by using humidity and CO<sub>2</sub> sensors which boost the air volume gradually based on the moisture and occupancy levels in the dwelling. It is also possible to integrate the unit into a Building Management System via the corresponding BUS converter (LON or KNX) to monitor and control unit's functions by a central control system.

Having the latest, low energy EC fan technology, the DV96SE complies with the ErP 2015 standards.

The unit comes with an outstanding 5 year warranty\*, is SAP Appendix Q eligible, tested by TUV laboratories and also certified by the Passive House Institute.

## New Smart Frost Protection

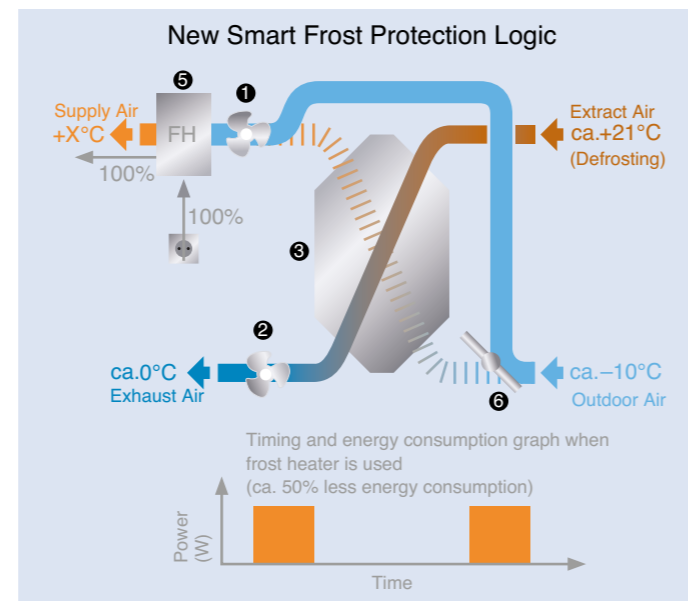
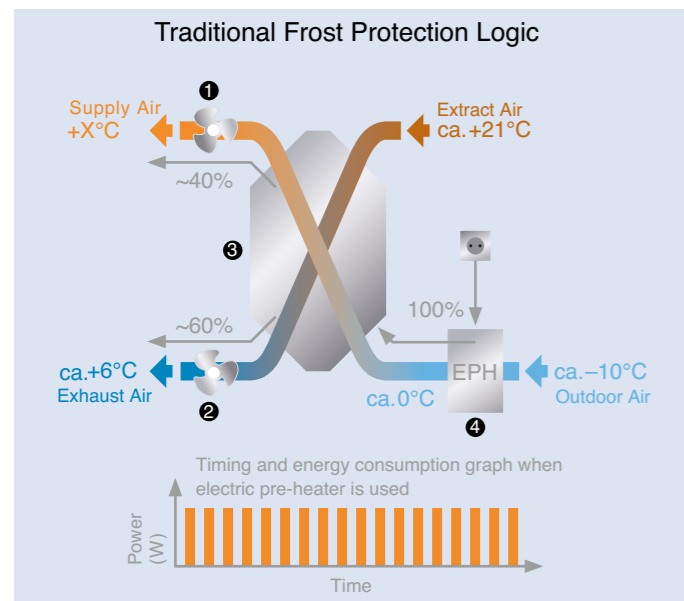

On the traditional frost protection method, the outdoor air is pre-heated before passing through the heat exchanger. This way the unit could still provide balanced ventilation even when the frost protection was on. However, the electric heater kicks in intermittently hence consumes more energy than needed.

The new Smart Frost Protection method works in a more energy efficient manner which constantly monitors the heat exchanger conditions and uses the frost heater only when necessary. This significantly reduces the energy consumption and provides more heat recovery throughout the winter season.

- 1 Supply air fan
- 2 Exhaust air fan
- 3 Heat exchanger
- 4 Electric pre-heater
- 5 Frost heater
- 6 Electric bypass damper

## Triple Filter Design

The majority of the MVHR units in the U.K incorporate G3 or G4 coarse filters on the extract / supply air side. These filters catch only coarse particles such as insects and leaves to protect the heat exchanger.

F7 fine filters on the other hand are highly efficient, catch invisible particles such as pollen, spore, bacterium and dust entering the lungs.

**Duplexvent Professional Line units are the only MVHR units which incorporate triple filter design combining G4 course filters with the F7 fine filter. This significantly improves the indoor air quality and lowers your maintenance costs.**



## 100% Automatic Bypass

The unit is equipped with an automatic, 100% bypass which totally isolates the heat exchanger so that no air passes through it. This provides effective cooling in the summer season.

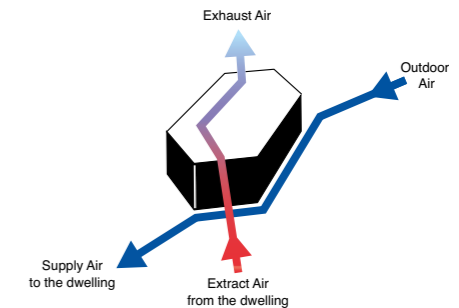

## Controls

**Ideal indoor air quality is achieved by automatically adjusted ventilation**

Duplexvent DV96SE is controlled via a 8 speed digital control providing the following features:

- 8 speed control where all speeds are 100% adjustable
- Automatic boost function with delay timer
- Filter maintenance reminder via counter clock (standard) / via pressure sensor (optional)
- Heater control for post-heater
- Connection to BMS via LON or KNX
- Self diagnostic via fault signal relay
- On-demand control via humidity and CO<sub>2</sub> sensors
- Separate fan control for ease of commissioning
- Weekly ventilation programming allows users to pre-set the ventilation levels scheduled for different days
- Indoor temperature control based on extract air temperature or supply air temperature
- Internet connection available



# Duplexvent DV110SE

Professional Line Top Entry - Up to 415 m<sup>3</sup>/hr air volume



## Key Features

- For use in medium sized dwellings up to 210 m<sup>2</sup>\*
- Extract up to 390 m<sup>3</sup>/hr at 100 Pa
- Galvanised steel, double skin casing
- Triple filter design with F7 pollen filter
- Over 90% thermal efficiency and low SFP
- New smart frost protection heater
- Built-in electric post-heater
- Automatic, 100% summer bypass
- Auto cut-out switch for extra safety
- Eight speed digital control with LCD display and BMS (LON / KNX) connection
- SAP Appendix Q eligible and PASSIVE HOUSE Institute certified
- Complies with Building Regulations
- 5 year warranty\*

## Duplexvent DV110SE

The Duplexvent DV110SE is a highly efficient mechanical supply and extract ventilation unit with heat recovery for an air capacity of up to 415 m<sup>3</sup>/hr. It is a wall mounted unit and is delivered complete with a wall mounting plate and condensate drain.

The unit is made of a galvanised steel double-skin casing which is powder coated both internally and externally to meet hygiene requirements.

Moreover, the 20mm thick insulation in the casing avoids any thermal bridging and significantly reduces noise levels.

The DV110SE includes an easily removable, plastic heat exchanger which transfers warmth from the outgoing waste airstream into the incoming fresh air where its thermal efficiency up to 90%. At no point do the airstreams mix.



## SAP Appendix Q

Tested by the BRE (Building Research Establishment) and eligible for the SAP Appendix Q

DV110SE	SFP	Efficiency
K+1 Wet room	0.89	90%
K+2 Wet rooms	0.79	90%
K+3 Wet rooms	0.79	89%
K+4 Wet rooms	0.83	89%
K+5 Wet rooms	0.91	88%
K+6 Wet rooms	1.02	88%
K+7 Wet rooms	1.15	87%

## Technical Data

Specification	Duplexvent DV110SE R	Duplexvent DV110SE L
Air flow m <sup>3</sup> /hr / l/sec @ 100 Pa	414 / 115	414 / 115
Thermal efficiency	Up to 90%	Up to 90%
Heat exchanger	Counterflow (Plastic)	Counterflow (Plastic)
Fans	EC	EC
Summer bypass damper	100% automatic	100% automatic
Frost protection	Frost heater	Frost heater
Controls	8-Speed - Digital	8-Speed - Digital
Connection to BMS	LON / KNX (optional)	LON / KNX (optional)
Mounting	Wall	Wall
Sound level @ 3m (dB(A))	26 - 47	26 - 47
Duct diameter (mm)	4 x 160	4 x 160
Condensate discharge (mm)	12	12
Electrical supply	230v / 1ph / 50Hz	230v / 1ph / 50Hz
Max. power consumption	238w	238w
Filter class	2 x G4 / 1 x F7	2 x G4 / 1 x F7
Electric frost heater	900w	900w
Electric post-heater	900w	900w
Protection class	IP34	IP34
Casing insulation (mm)	20	20
Weight (kg)	60	60
Dimensions (L x D x H) mm	638 x 472 x 678	638 x 472 x 678
Part No.	90000224	90000225

## Dimensions

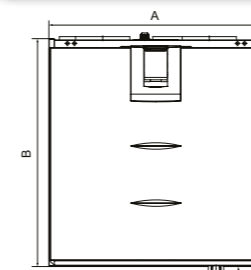

**Duct outlets, model R**  
Inner diameter of female outlet collar ø160mm  
1. Supply air to the dwelling  
2. Extract air from dwelling to unit  
3. Exhaust air out  
4. Outdoor air to unit

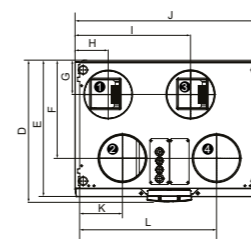

**Duct outlets, model L**  
Inner diameter of female outlet collar ø160mm  
1. Exhaust air out  
2. Outdoor air to unit  
3. Supply air to the dwelling  
4. Extract air from dwelling to unit

+ excludes motors

Model	A	B	C	D	E	F	G	H	I	J	K	L
DV110SE	638	678	42	472	455	325	111	112	390	638	160	478



## Passive House Certification

The Duplexvent DV110SE is tested and certified by the Passive House Institute based on the following criteria:

- Thermal comfort
- Effective heat recovery
- Electric power consumption
- Air tightness
- Balancing adjustability
- Sound insulation
- Indoor air quality
- Frost protection



## Performance

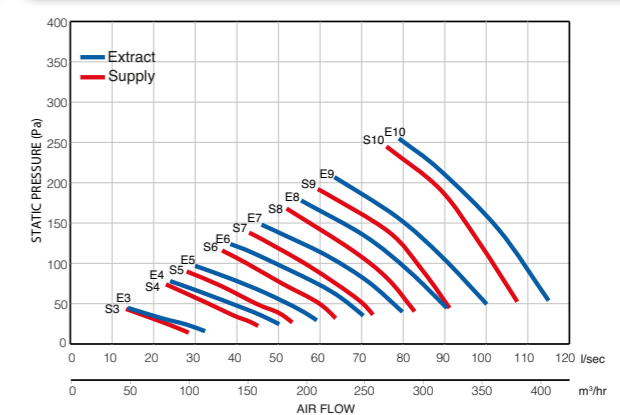

\* Guidance only. Dependant upon system pressure.

## Accessories

See switches/accessories pages 209-239 for more details.

# Duplexvent DV110SE

Professional Line Top Entry - Up to 415 m<sup>3</sup>/hr air volume

Fitted with an additional electric post-heater, the unit keeps the indoor air temperature at the required temperature level at all times hence maintains indoor air comfort whilst saving energy during the winter period.

The DV110SE is designed with a unique triple filter facility including a F7 pollen filter which provides additional protection against invisible, harmful particles and creates an ultra hygienic environment, particularly relevant for those suffering from asthma or other respiratory conditions.

The unit includes a digital controller with LCD display which incorporates 8-speed air flow control, weekly ventilation programming, filter maintenance indicator, separate fan control for easy commissioning and the brand new smart frost protection facility which significantly reduces the

energy consumed to protect the heat exchanger from freezing (see below for more information).

On-demand ventilation can be achieved by using humidity and CO<sub>2</sub> sensors which boost the air volume gradually based on the moisture and occupancy levels in the dwelling. It is also possible to integrate the unit into a Building Management System via the corresponding BUS converter (LON or KNX) to monitor and control unit's functions by a central control system.

Having the latest, low energy EC fan technology, the DV110SE complies with the ErP 2015 standards.

The unit comes with an outstanding 5 year warranty\*, is SAP Appendix Q eligible, tested by TUV laboratories and also certified by the Passive House Institute.

## New Smart Frost Protection

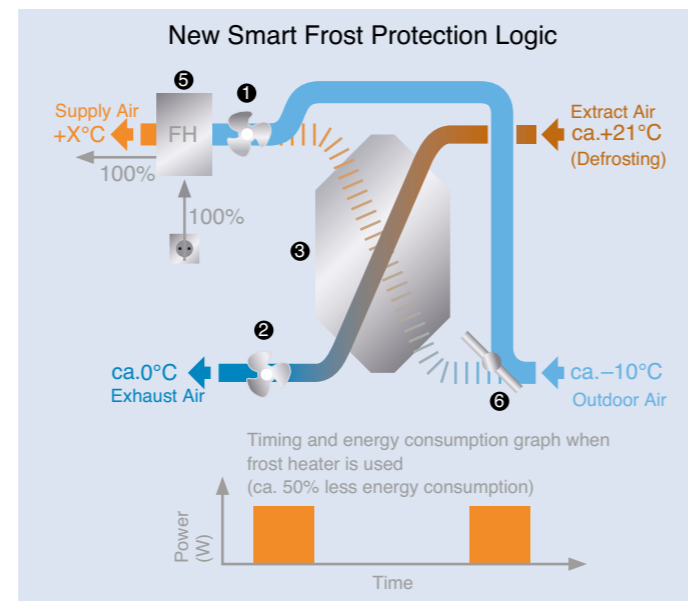
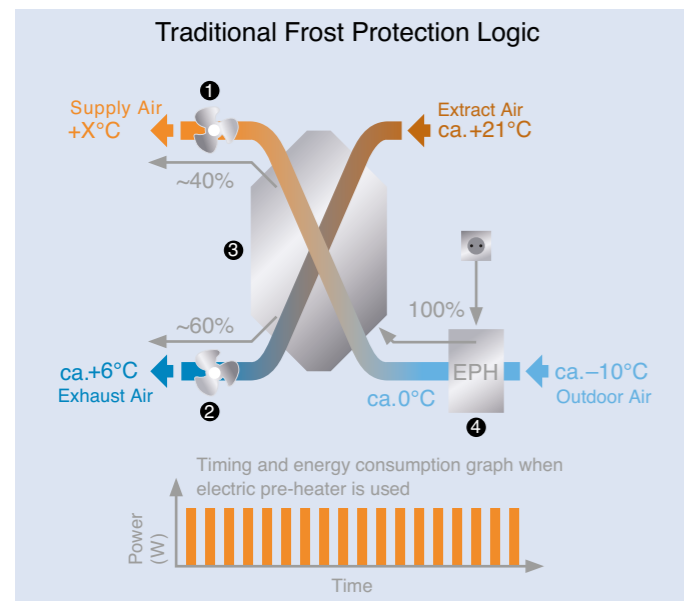

On the traditional frost protection method, the outdoor air is pre-heated before passing through the heat exchanger. This way the unit could still provide balanced ventilation even when the frost protection was on. However, the electric heater kicks in intermittently hence consumes more energy than needed.

The new Smart Frost Protection method works in a more energy efficient manner which constantly monitors the heat exchanger conditions and uses the frost heater only when necessary. This significantly reduces the energy consumption and provides more heat recovery throughout the winter season.

- 1 Supply air fan
- 2 Exhaust air fan
- 3 Heat exchanger
- 4 Electric pre-heater
- 5 Frost heater
- 6 Electric bypass damper

## Triple Filter Design

The majority of the MVHR units in the U.K incorporate G3 or G4 coarse filters on the extract / supply air side. These filters catch only coarse particles such as insects and leaves to protect the heat exchanger.

F7 fine filters on the other hand are highly efficient, catch invisible particles such as pollen, spore, bacterium and dust entering the lungs.

**Duplexvent Professional Line units are the only MVHR units which incorporate triple filter design combining G4 course filters with the F7 fine filter. This significantly improves the indoor air quality and lowers your maintenance costs.**



## 100% Automatic Bypass

The unit is equipped with an automatic, 100% bypass which totally isolates the heat exchanger so that no air passes through it. This provides effective cooling in the summer season.

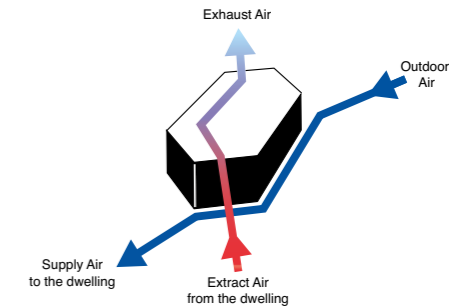

## Controls

**Ideal indoor air quality is achieved by automatically adjusted ventilation**

Duplexvent DV110SE is controlled via a 8 speed digital control providing the following features:

- **8 speed control** where all speeds are 100% adjustable
- **Automatic boost function** with delay timer
- **Filter maintenance reminder** via counter clock (standard) / via pressure sensor (optional)
- **Heater control** for frost heater and post-heater
- **Connection to BMS** via LON or KNX
- **Self diagnostic** via fault signal relay
- **On-demand control** via humidity and CO<sub>2</sub> sensors
- **Separate fan control** for ease of commissioning
- **Weekly ventilation programming** allows users to pre-set the ventilation levels scheduled for different days
- **Indoor temperature control** based on extract air temperature or supply air temperature
- **Internet connection** available





# Duplexvent DV145SE

Professional Line Top Entry - Up to 594 m<sup>3</sup>/hr air volume



## Key Features

- For use in large sized dwellings up to 300 m<sup>2</sup>\*
- Extract up to 570 m<sup>3</sup>/hr at 100 Pa
- Galvanised steel, double skin casing
- Triple filter design with F7 pollen filter
- Over 90% thermal efficiency and low SFP
- New smart frost protection heater
- Built-in electric post-heater
- Automatic, 100% summer bypass
- Auto cut-out switch for extra safety
- Eight speed digital control with LCD display and BMS (LON / KNX) connection
- SAP Appendix Q eligible and PASSIVE HOUSE Institute certified
- Complies with Building Regulations
- 5 year warranty\*

## Duplexvent DV145SE

The Duplexvent DV145SE is a highly efficient mechanical supply and extract ventilation unit with heat recovery for an air capacity of up to 594 m<sup>3</sup>/hr. It is a wall mounted unit and is delivered complete with a wall mounting plate and condensate drain.

The unit is made of a galvanised steel double-skin casing which is powder coated both internally and externally to meet hygiene requirements.

Moreover, the 20mm thick insulation in the casing avoids any thermal bridging and significantly reduces noise levels.

The DV145SE includes an easily removable, aluminium heat exchanger which transfers warmth from the outgoing waste airstream into the incoming fresh air where its thermal efficiency up to 90%. At no point do the airstreams mix.



## SAP Appendix Q

Tested by the BRE (Building Research Establishment) and eligible for the SAP Appendix Q

DV145SE	SFP	Efficiency
K+1 Wet room	1.09	78%
K+2 Wet rooms	0.94	80%
K+3 Wet rooms	0.89	81%
K+4 Wet rooms	0.92	82%
K+5 Wet rooms	0.97	83%
K+6 Wet rooms	1.04	83%
K+7 Wet rooms	1.15	84%

## Technical Data

Specification	Duplexvent DV145SE R	Duplexvent DV145SE L
Air flow m <sup>3</sup> /hr / l/sec @ 100 Pa	568 / 158	568 / 158
Thermal efficiency	Up to 90%	Up to 90%
Heat exchanger	Counterflow (Aluminium)	Counterflow (Aluminium)
Fans	EC	EC
Summer bypass damper	100% automatic	100% automatic
Frost protection	Frost heater	Frost heater
Controls	8-Speed - Digital	8-Speed - Digital
Connection to BMS	LON / KNX (optional)	LON / KNX (optional)
Mounting	Wall / Floor	Wall / Floor
Sound level @ 3m (dB(A))	24 - 47	24 - 47
Duct diameter (mm)	4 x 200	4 x 200
Condensate discharge (mm)	12	12
Electrical supply	230v / 1ph / 50Hz	230v / 1ph / 50Hz
Max. power consumption	350w	350w
Filter class	2 x G4 / 1 x F7	2 x G4 / 1 x F7
Electric frost heater	900w	900w
Electric post-heater	1500w	1500w
Protection class	IP34	IP34
Casing insulation (mm)	20	20
Weight (kg)	88	88
Dimensions (L x D x H) mm	718 x 578 x 748	718 x 578 x 748
Part No.	90000395	90000396

## Dimensions

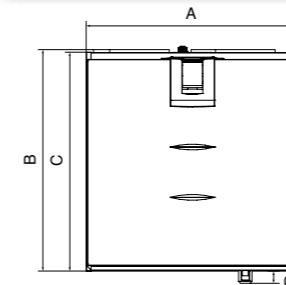

**Duct outlets, model R**  
Inner diameter of female outlet collar ø200 mm

1. Supply air to the dwelling
2. Extract air from dwelling to unit
3. Exhaust air out
4. Outdoor air to unit

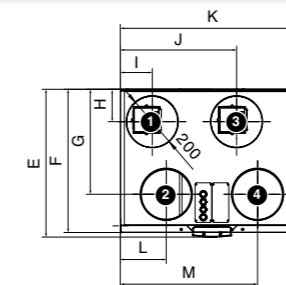

**Duct outlets, model L**  
Inner diameter of female outlet collar ø200 mm

1. Exhaust air out
2. Outdoor air to unit
3. Supply air to the dwelling
4. Extract air from dwelling to unit

+ excludes motors

Model	A	B	C	D	E	F	G	H	I	J	K	L	M
DV145SE	717	748	739	42	578	560	411	127	125	455	717	180	537



## Passive House Certification

The Duplexvent DV145SE is tested and certified by the Passive House Institute based on the following criteria:

- Thermal comfort
- Effective heat recovery
- Electric power consumption
- Air tightness
- Balancing adjustability
- Sound insulation
- Indoor air quality
- Frost protection



## Performance

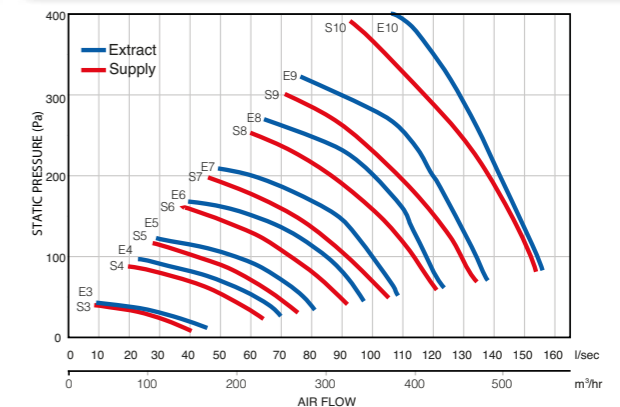

\* Guidance only. Dependant upon system pressure.

## Accessories

See switches/accessories pages 209-239 for more details.

# Duplexvent DV145SE

Professional Line Top Entry - Up to 594 m<sup>3</sup>/hr air volume

Fitted with an additional electric post-heater, the unit keeps the indoor air temperature at the required temperature level at all times hence maintains indoor air comfort whilst saving energy during the winter period.

The DV145SE is designed with a unique triple filter facility including a F7 pollen filter which provides additional protection against invisible, harmful particles and creates an ultra hygienic environment, particularly relevant for those suffering from asthma or other respiratory conditions.

The unit includes a digital controller with LCD display which incorporates 8-speed air flow control, weekly ventilation programming, filter maintenance indicator, separate fan control for easy commissioning and the brand new smart frost protection facility which significantly reduces the

energy consumed to protect the heat exchanger from freezing (see below for more information).

On-demand ventilation can be achieved by using humidity and CO<sub>2</sub> sensors which boost the air volume gradually based on the moisture and occupancy levels in the dwelling. It is also possible to integrate the unit into a Building Management System via the corresponding BUS converter (LON or KNX) to monitor and control unit's functions by a central control system.

Having the latest, low energy EC fan technology, the DV145SE complies with the ErP 2015 standards.

The unit comes with an outstanding 5 year warranty\*, is SAP Appendix Q eligible, tested by TUV laboratories and also certified by the Passive House Institute.

## New Smart Frost Protection

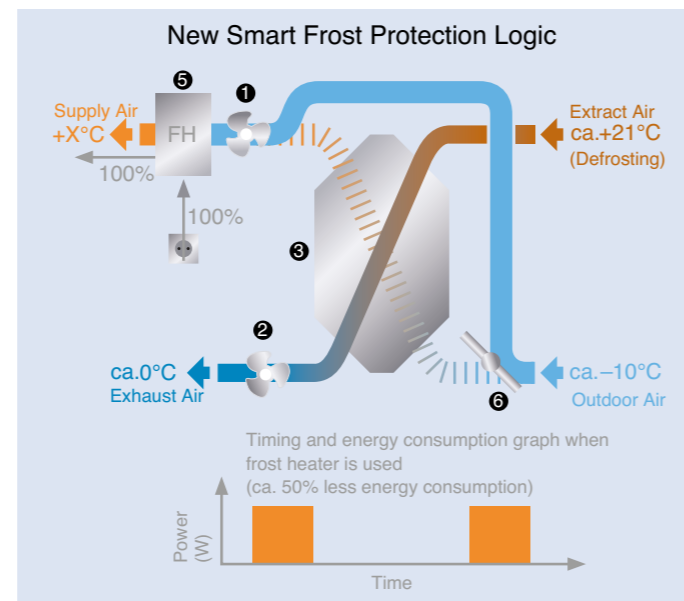
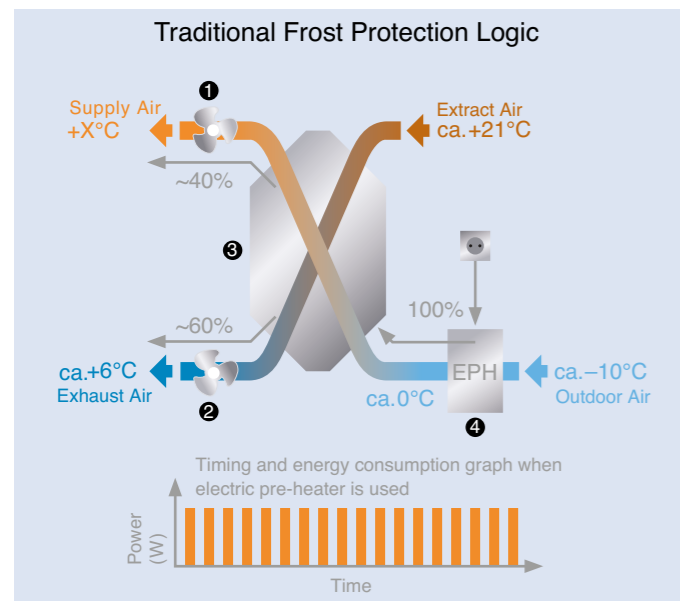

On the traditional frost protection method, the outdoor air is pre-heated before passing through the heat exchanger. This way the unit could still provide balanced ventilation even when the frost protection was on. However, the electric heater kicks in intermittently hence consumes more energy than needed.

The new Smart Frost Protection method works in a more energy efficient manner which constantly monitors the heat exchanger conditions and uses the frost heater only when necessary. This significantly reduces the energy consumption and provides more heat recovery throughout the winter season.

- 1 Supply air fan
- 2 Exhaust air fan
- 3 Heat exchanger
- 4 Electric pre-heater
- 5 Frost heater
- 6 Electric bypass damper

## Triple Filter Design

The majority of the MVHR units in the U.K incorporate G3 or G4 coarse filters on the extract / supply air side. These filters catch only coarse particles such as insects and leaves to protect the heat exchanger.

F7 fine filters on the other hand are highly efficient, catch invisible particles such as pollen, spore, bacterium and dust entering the lungs.

**Duplexvent Professional Line units are the only MVHR units which incorporate triple filter design combining G4 course filters with the F7 fine filter. This significantly improves the indoor air quality and lowers your maintenance costs.**



## 100% Automatic Bypass

The unit is equipped with an automatic, 100% bypass which totally isolates the heat exchanger so that no air passes through it. This provides effective cooling in the summer season.

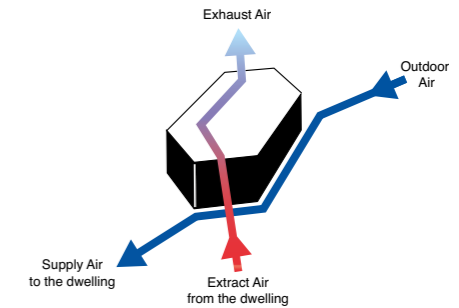

## Controls

**Ideal indoor air quality is achieved by automatically adjusted ventilation**

Duplexvent DV145SE is controlled via a 8 speed digital control providing the following features:

- **8 speed control** where all speeds are 100% adjustable
- **Automatic boost function** with delay timer
- **Filter maintenance reminder** via counter clock (standard) / via pressure sensor (optional)
- **Heater control** for frost heater and post-heater
- **Connection to BMS** via LON or KNX
- **Self diagnostic** via fault signal relay
- **On-demand control** via humidity and CO<sub>2</sub> sensors
- **Separate fan control** for ease of commissioning
- **Weekly ventilation programming** allows users to pre-set the ventilation levels scheduled for different days
- **Indoor temperature control** based on extract air temperature or supply air temperature
- **Internet connection** available



# Duplexvent DV200SE

Professional Line Top Entry - Up to 850 m<sup>3</sup>/hr air volume



## Key Features

- For use in large sized dwellings up to 400 m<sup>2</sup>\*
- Extract up to 790 m<sup>3</sup>/hr at 100 Pa
- Galvanised steel, double skin casing
- Triple filter design with F7 pollen filter
- Up to 90% thermal efficiency and low SFP
- Built-in electric or water post-heater
- Automatic, 100% bypass and frost protection
- Auto cut-out switch for extra safety
- Eight speed digital control with LCD display and BMS (LON / KNX) connection
- Complies with Building Regulations
- 5 year warranty\*

## Duplexvent DV200SE

With its powerful air volume capacity and high thermal efficiency the Duplexvent DV200SE is suitable for large family houses or light commercial applications.

Having the triple filter design with an F7 pollen filter, the DV200SE provides additional protection against invisible, harmful particles and creates an ultra hygienic environment.

The automatic, 100% summer bypass facility isolates the heat recovery function and helps to effectively cool the inside air during the summer months.

The unit includes an easily removable, aluminium heat exchanger and can be equipped with a built-in electric or water post-heater to increase the heat performance of the system.



## Technical Data

Specification	Duplexvent DV200SE R	Duplexvent DV200SE L
Air flow m <sup>3</sup> /hr / l/sec @ 100 Pa	828 / 230	828 / 230
Thermal efficiency	Up to 90%	Up to 90%
Heat exchanger	Counterflow (Aluminium)	Counterflow (Aluminium)
Fans	EC	EC
Summer bypass damper	100% automatic	100% automatic
Frost protection	Frost heater	Frost heater
Controls	8-Speed - Digital	8-Speed - Digital
Connection to BMS	LON / KNX (optional)	LON / KNX (optional)
Mounting	Floor	Floor
Sound level @ 3m (dB(A))	33 - 48	33 - 48
Duct diameter (mm)	4 x 200	4 x 200
Condensate discharge (mm)	12	12
Electrical supply	230v / 1ph / 50Hz	230v / 1ph / 50Hz
Max. power consumption	451w	451w
Filter class	2 x G4 / 1 x F7	2 x G4 / 1 x F7
Electric frost heater	2000w	2000w
Electric post-heater	1000w (optional)	1000w (optional)
Water post-heater	3000w (optional)	3000w (optional)
Protection class	IP34	IP34
Casing insulation (mm)	50	50
Weight (kg)	146	146
Dimensions (L x D x H) mm	900 x 720 x 1130	900 x 720 x 1130
Part No.	90000157	90000158

## Controls

Ideal indoor air quality is achieved by automatically adjusted ventilation

Duplexvent DV200SE is controlled via a 8 speed digital control providing the following features:

- **8 speed control** where both fans are 100% adjustable
- **Automatic boost function** with delay timer
- **Filter maintenance reminder** via counter clock (standard) / via pressure sensor (optional)
- **Heater control** for frost heater and post-heater
- **Connection to BMS** via LON or KNX
- **Self diagnostic** via fault signal relay
- **On-demand control** via humidity and CO<sub>2</sub> sensors
- **Separate fan control** for ease of commissioning
- **Weekly ventilation programming** allows users to pre-set the ventilation levels scheduled for different days
- **Indoor temperature control** based on extract air temperature or supply air temperature
- **Internet** connection available



## Dimensions

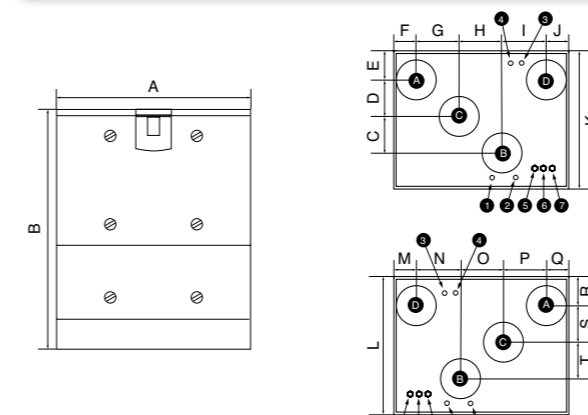

Duct outlets, inner diameter of collar ø200mm

- A Outdoor air to unit
- B Supply air to the dwelling
- C Extract air from the dwelling
- D Exhaust air out

### Pipe connections

1. Supply water to the radiator
2. Return water from the radiator
3. Supply liquid to the water heater
4. Return liquid from the water heater

### Electrical connections

5. Connection cable - Humidity sensor
6. Connection cable - Control panel - CO<sub>2</sub> sensor - LON converter
7. Feed cable - Distribution panel

+ excludes motors

Model	A	B	C	D	E	F	G	H	I	J
DV200SE	900	1130	183	183	160	124	215	215	222	124
	K	L	M	N	O	P	Q	R	S	T
	720	720	124	222	215	215	124	160	183	183

## Performance

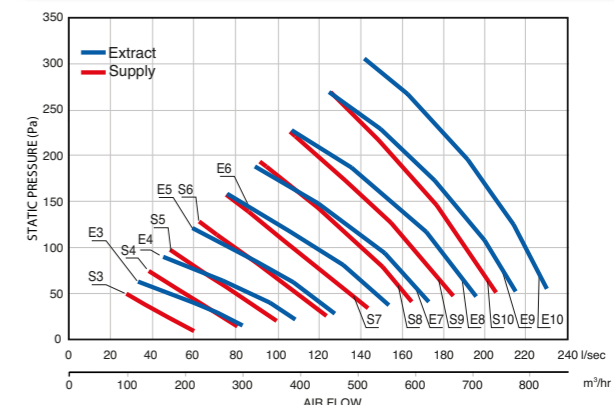

\* Guidance only. Dependant upon system pressure.

## Accessories

See switches/accessories pages 209-239 for more details.

# Duplexvent DV50

Professional Line Side Entry - Up to 230 m<sup>3</sup>/hr air volume



## Key Features

- For use in small sized dwellings up to 100 m<sup>2</sup>\*
- Extract up to 216 m<sup>3</sup>/hr at 100 Pa
- Unique maintenance feature enables external access from outside dwelling
- Triple filter design with F7 pollen filter
- Up to 90% thermal efficiency and low SFP
- New smart frost protection
- Built-in electric post-heater
- Automatic, 100% summer bypass
- Low height (236mm) for suspended ceiling application
- SAP Appendix Q eligible and PASSIVE HOUSE Institute certified
- Complies with Building Regulations
- 5 year warranty\*

## Duplexvent DV50

Duplexvent DV50 brings a new approach to the heat recovery ventilation with a low profile design. It can be integrated into the structure of the dwelling, i.e. above the entry door so routine maintenance can be performed from the outside corridor without disturbing the resident. This ensures quick and easy maintenance and is ideal for apartment blocks.

The unit includes an easy to remove, aluminium heat exchanger which transfers warmth from the outgoing waste airstream into the incoming fresh air where at no point do the airstreams mix.



## SAP Appendix Q

Tested by the BRE (Building Research Establishment) and eligible for the SAP Appendix Q

DV50	SFP	Efficiency
K+1 Wet room	0.91 W//s	79%
K+2 Wet rooms	0.95 W//s	80%
K+3 Wet rooms	1.11 W//s	81%
K+4 Wet rooms	1.29 W//s	81%

## Technical data

Specification	Duplexvent DV50 R	Duplexvent DV50 L
Air flow m <sup>3</sup> /hr / l/sec @ 100 Pa	230 / 64	230 / 64
Thermal efficiency	Up to 90%	Up to 90%
Heat exchanger	Counterflow (Aluminium)	Counterflow (Aluminium)
Fans	EC	EC
Summer bypass damper	100% automatic	100% automatic
Frost protection	Frost heater	Frost heater
Controls	4-Speed - Manual Digital (optional)	4-Speed - Manual Digital (optional)
Mounting	Floor / Ceiling	Floor / Ceiling
Sound level @ 3m (dB(A))	27 - 49	27 - 49
Duct diameter (mm)	8 x 100	8 x 100
Condensate discharge (mm)	12	12
Electrical supply	230v / 1ph / 50Hz	230v / 1ph / 50Hz
Max. power consumption	104w	104w
Filter class	2 x G4 / 1 x F7	2 x G4 / 1 x F7
Electric frost/post-heater	900w	900w
Protection class	IP34	IP34
Casing insulation (mm)	20	20
Weight (kg)	45	45
Dimensions (L x D x H) mm	900 x 547 x 236	900 x 547 x 236
Part No.	90000003	9041558

## Dimensions

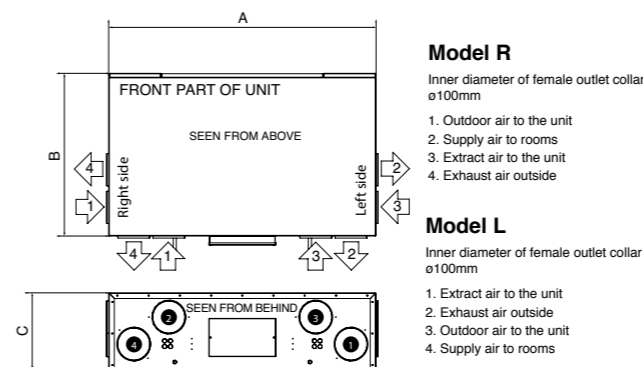

+ excludes motors

Model	A	B	C
DV50	900	547	236

## Passive House Certification

The Duplexvent DV50 is tested and certified by the Passive House Institute based on the following criteria:

- Thermal comfort
- Effective heat recovery
- Electric power consumption
- Air tightness
- Balancing adjustability
- Sound insulation
- Indoor air quality



## Controls

### Four Speed Switch

Duplexvent DV50 is controlled via a 4 speed switch or an optional digital controller which allows 100% variable control at each speed setting.

- Easy to install, simple to use
- Manual/automatic boost with timer
- Maintenance indicator and self diagnostic



Manual control switch



Digital controller

## Performance

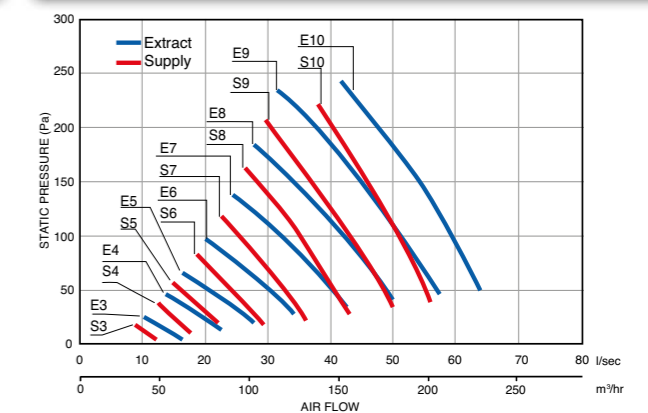

\* Guidance only. Dependant upon system pressure.

## Accessories

See Duplexvent accessories pages 170-173 for more details.



# Duplexvent DV50

Professional Line Side Entry - Up to 230 m<sup>3</sup>/hr air volume

The unit incorporates the brand new smart frost protection facility which significantly reduces the energy consumed to protect the heat exchanger from freezing (see below for more information).

Equipped with a 4-speed simple controller the unit also has an automatic, 100% bypass facility which fully covers the heat exchanger at the pre-defined temperature and helps to effectively cool the indoor air during the summer months.

The DV50 is designed with a unique triple filter facility including a F7 pollen filter which provides additional protection against invisible, harmful particles and creates an ultra hygienic environment, particularly relevant for those suffering from asthma or other respiratory conditions.

The unique multi spigot design gives installers the flexibility to connect the ducting to the unit from different directions which reduces the number of duct connections and saves time on installation.

Fitted with an electric post-heater, the unit keeps the indoor air temperature at the required temperature level at all times hence saves energy especially during the winter period.

Having the latest, low energy EC fan technology, the DV50 complies with the ErP 2015 standards.

The unit comes with an outstanding 5 year warranty\*, is SAP Appendix Q eligible, tested by TUV laboratories and also certified by the Passive House Institute.

## New Smart Frost Protection

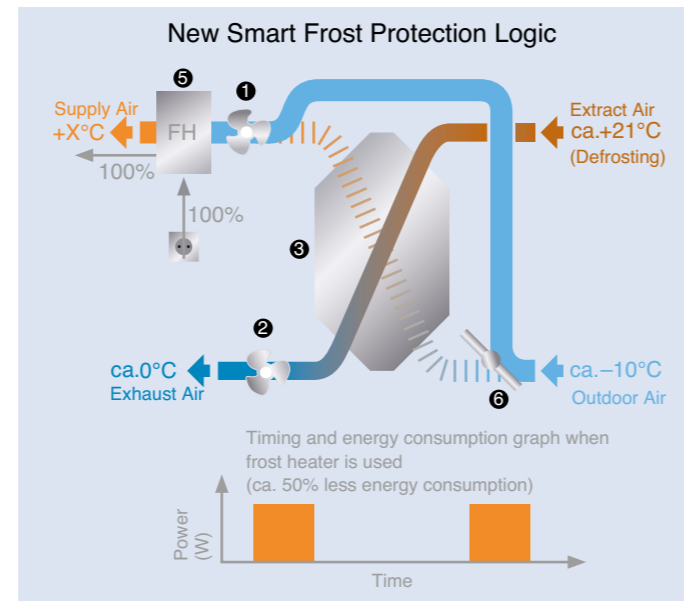
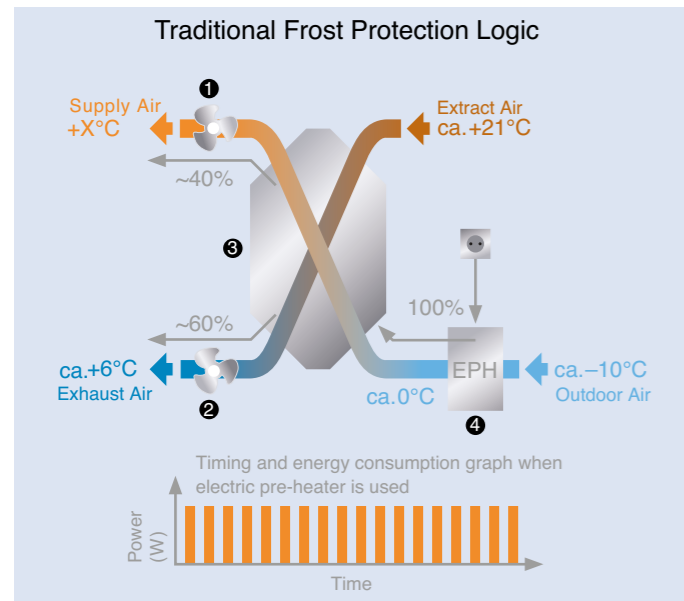

On the traditional frost protection method, the outdoor air is pre-heated before passing through the heat exchanger. This way the unit could still provide balanced ventilation even when the frost protection was on. However, the electric heater kicks in intermittently hence consumes more energy than needed.

The new Smart Frost Protection method works in a more energy efficient manner which constantly monitors the heat exchanger conditions and uses the frost heater only when necessary. This significantly reduces the energy consumption and provides more heat recovery throughout the winter season.

- 1 Supply air fan
- 2 Exhaust air fan
- 3 Heat exchanger
- 4 Electric pre-heater
- 5 Frost heater
- 6 Electric bypass damper

## 100% Automatic Bypass

The unit is equipped with an automatic, 100% bypass which totally isolates the heat exchanger so that no air passes through it. This provides effective cooling in the summer season.

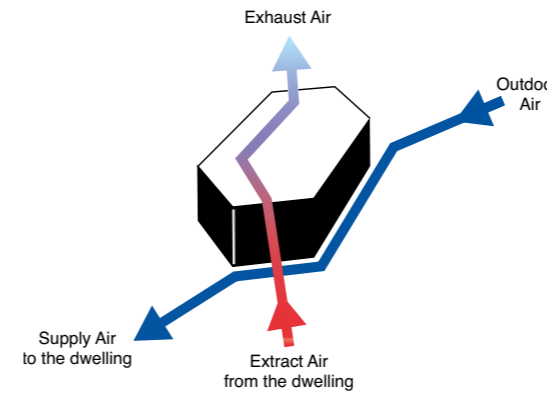

## Multi Spigot Design

The unique multi spigot design gives installers the flexibility to connect the ducting to the unit from different directions which reduces the number of duct connections and saves time on installation.

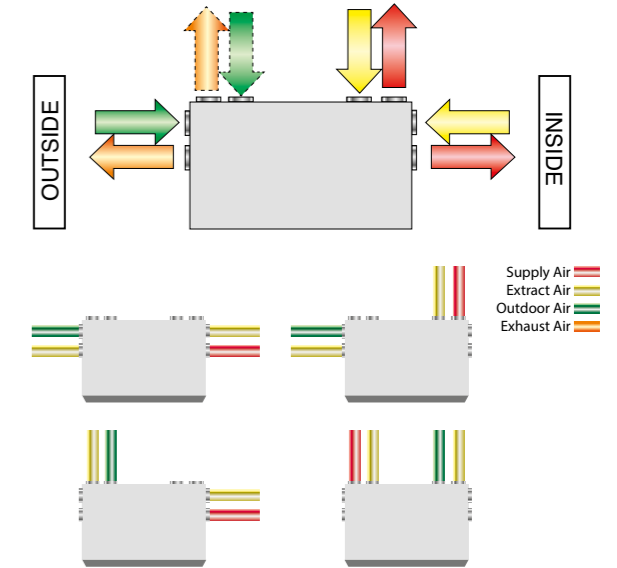

## Accessibility

Landlords can protect their investment by insuring planned maintenance from outside the dwelling to preserve building fabric, ensure occupier wellbeing and save energy **without the need to access the dwelling or disturb the tenant.**

This significantly shortens maintenance time and saves on service cost.



Easy access to replace filters

Heat Recovery

Removable, secure front cover panel for maintenance

Removable Heat Exchanger for quick cleaning

Durable steel double skin casing with 20mm insulation



# Duplexvent DV80

Professional Line Side Entry - Up to 360 m<sup>3</sup>/hr air volume



## Key Features

- For use in medium sized dwellings up to 180 m<sup>2</sup> \*
- Extract up to 342 m<sup>3</sup>/hr at 100 Pa
- Unique maintenance feature enables external access from outside dwelling
- Triple filter design with F7 pollen filter
- Over 90% thermal efficiency and low SFP
- New smart frost protection heater
- Built-in electric post-heater
- Automatic, 100% summer bypass
- Low height (293mm) for suspended ceiling application
- SAP Appendix Q eligible and PASSIVE HOUSE Institute certified
- Complies with Building Regulations
- 5 years warranty\*

## Duplexvent DV80

Duplexvent DV80 brings a new approach to the heat recovery ventilation with a low profile design. It can be integrated into the structure of the dwelling, i.e. above the entry door so routine maintenance can be performed from the outside corridor without disturbing the resident. This ensures quick and easy maintenance for and is ideal for apartment blocks.

The unit includes an easy to remove, plastic heat exchanger which transfers warmth from the outgoing waste airstream into the incoming fresh air where its thermal efficiency up to 90%. At no point do the airstreams mix.



## SAP Appendix Q

Tested by the BRE (Building Research Establishment) and eligible for the SAP Appendix Q

DV80	SFP	Efficiency
K+1 Wet room	0.79 W//s	90%
K+2 Wet rooms	0.79 W//s	91%
K+3 Wet rooms	0.86 W//s	90%
K+4 Wet rooms	1.02 W//s	90%
K+5 Wet rooms	1.16 W//s	89%
K+6 Wet rooms	1.28 W//s	89%

## Technical Data

Specification	Duplexvent DV80 R	Duplexvent DV80 L
Air flow m <sup>3</sup> /hr / l/sec @ 100 Pa	356 / 99	356 / 99
Thermal efficiency	Up to 90%	Up to 90%
Heat exchanger	Counterflow (Plastic)	Counterflow (Plastic)
Fans	EC	EC
Summer bypass damper	100% automatic	100% automatic
Frost protection	Frost heater	Frost heater
Controls	4-Speed - Manual Digital optional	4-Speed - Manual Digital optional
Mounting	Floor / Ceiling	Floor / Ceiling
Sound level @ 3m (dB(A))	28 - 48	28 - 48
Duct diameter (mm)	8 x 125	8 x 125
Condensate discharge (mm)	12	12
Electrical supply	230v / 1ph / 50Hz	230v / 1ph / 50Hz
Max. power consumption	165w	165w
Filter class	2 x G4 / 1 x F7	2 x G4 / 1 x F7
Electric frost heater	900w	900w
Electric post-heater	900w	900w
Protection class	IP34	IP34
Casing insulation (mm)	20	20
Weight (kg)	59	59
Dimensions (L x D x H) mm	1026 x 626 x 293	1026 x 626 x 293
Part No.	90000067	90000066

## Dimensions

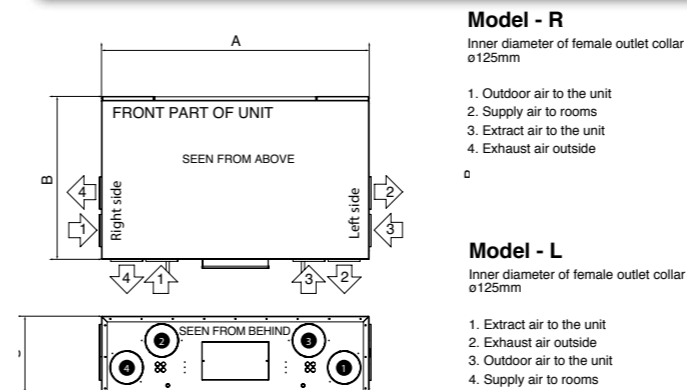

+ excludes motors

Model	A	B	C
DV80	1026	626	293

## Passive House Certification

The Duplexvent DV80 is tested and certified by the Passive House Institute based on the following criteria:

- Thermal comfort
- Effective heat recovery
- Electric power consumption
- Air tightness
- Balancing adjustability
- Sound insulation
- Indoor air quality
- Frost protection



## Controls

### Four Speed Switch

Duplexvent DV80 is controlled via a 4 speed switch or an optional digital controller which allows 100% variable control at each speed setting.

- Easy to install, simple to use
- Manual/automatic boost with timer
- Maintenance indicator and self diagnostic



Manual control switch



Digital controller

## Performance

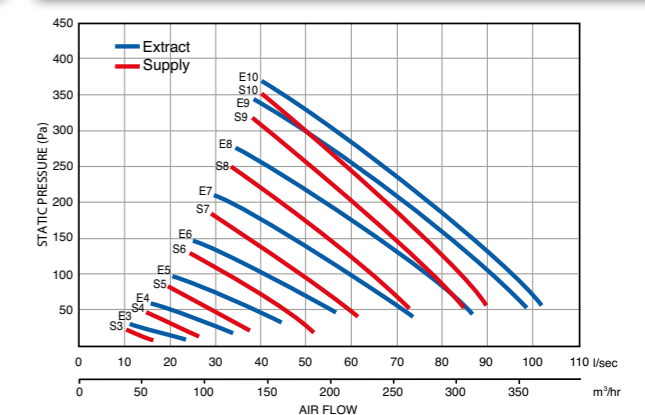

\* Guidance only. Dependant upon system pressure.

## Accessories

See switches/accessories pages 209-239 for more details.

# Duplexvent DV80

Professional Line Side Entry - Up to 360 m<sup>3</sup>/hr air volume

The unit incorporates the brand new smart frost protection facility which significantly reduces the energy consumed to protect the heat exchanger from freezing (see below for more information).

Equipped with a 4-speed simple controller the unit also has an automatic, 100% bypass facility which fully covers the heat exchanger at the pre-defined temperature and helps to effectively cool the indoor air during the summer months.

The DV80 is designed with a unique triple filter facility including a F7 pollen filter which provides additional protection against invisible, harmful particles and creates an ultra hygienic environment, particularly relevant for those suffering from asthma or other respiratory conditions.

The unique multi spigot design gives installers the flexibility to connect the ducting to the unit from different directions which reduces the number of duct connections and saves time on installation.

Fitted with an additional electric post-heater, the unit keeps the indoor air temperature at the required temperature level at all times hence saves energy especially during the winter period.

Having the latest, low energy EC fan technology, the DV80 complies with the ErP 2015 standards.

The unit comes with an outstanding 5 years warranty\*, is SAP Appendix Q eligible, tested by TUV laboratories and also certified by the Passive House Institute.

## New Smart Frost Protection

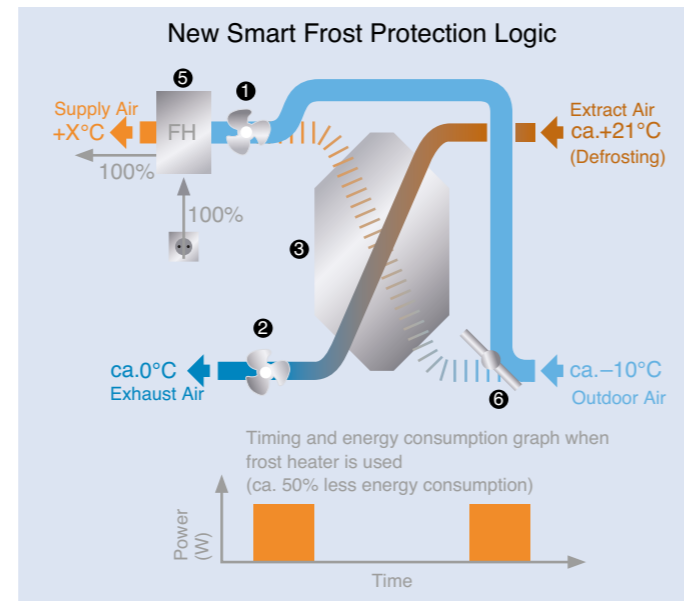
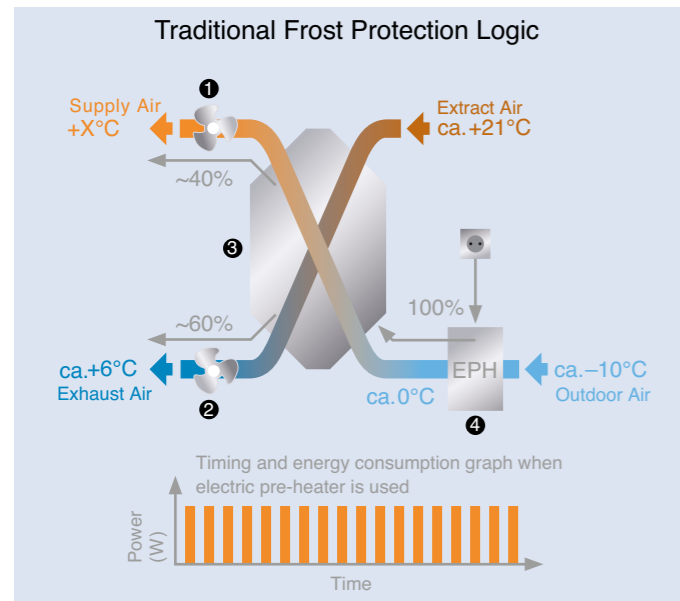

On the traditional frost protection method, the outdoor air is pre-heated before passing through the heat exchanger. This way the unit could still provide balanced ventilation even when the frost protection was on. However, the electric heater kicks in intermittently hence consumes more energy than needed.

The new Smart Frost Protection method works in a more energy efficient manner which constantly monitors the heat exchanger conditions and uses the frost heater only when necessary. This significantly reduces the energy consumption and provides more heat recovery throughout the winter season.

- 1 Supply air fan
- 2 Exhaust air fan
- 3 Heat exchanger
- 4 Electric pre-heater
- 5 Frost heater
- 6 Electric bypass damper

## 100% Automatic Bypass

The unit is equipped with an automatic, 100% bypass which totally isolates the heat exchanger so that no air passes through it. This provides effective cooling in the summer season.

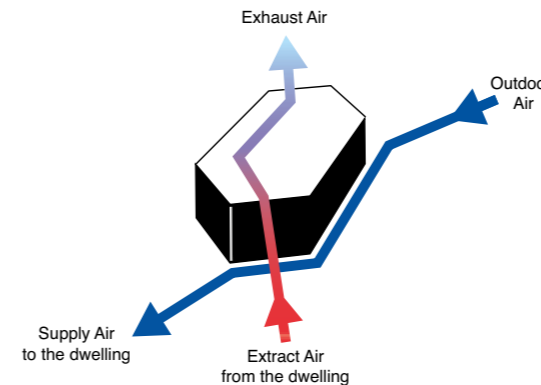

## Multi Spigot Design

The unique multi spigot design gives installers the flexibility to connect the ducting to the unit from different directions which reduces the number of duct connections and saves time on installation.

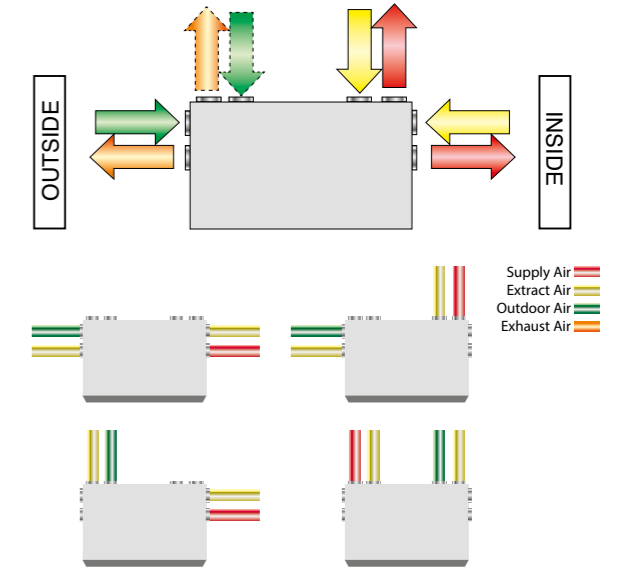

## Accessibility

Landlords can protect their investment by insuring planned maintenance from outside the dwelling to preserve building fabric, ensure occupier wellbeing and save energy **without the need to access the dwelling or disturb the tenant.**

This significantly shortens maintenance time and saves on service cost.



Easy access to replace filters

Heat Recovery

Removable, secure front cover panel for maintenance

Removable Heat Exchanger for quick cleaning

Durable steel double skin casing with 20mm insulation



# Duplexvent DV190/390/520SE

Interactive Line Top Entry - Up to 520 m<sup>3</sup>/hr air volume

## Key Features



- For use in small, medium and large sized dwellings up to 280 m<sup>2</sup> \*
- 3 models (top entry) up to 500 m<sup>3</sup>/hr at 100 Pa
- Galvanised steel, double skin casing
- Over 90% thermal efficiency and low noise
- Automatic, 100% summer bypass
- Remote control via laptop or smart phone
- Internet connection with service interface
- Ten speed digital control with BMS
- Optional constant flow function
- Compliant to PASSIVE HOUSE Institute and ErP 2015 standards
- 5 year warranty\*

## Duplexvent DV190/390/520SE

The Duplexvent Interactive Line DV190SE, DV390SE and DV520SE are highly efficient, top entry mechanical supply and extract ventilation units with heat recovery for an air capacity of up to 520 m<sup>3</sup>/hr. It is a wall/floor mounted unit and is delivered complete with a full condensate drain kit.

The unit is made of galvanised steel and has a double-skin casing which is insulated with 30mm thick polyurethane

(U = 0.65 Wm<sup>-2</sup>K<sup>-1</sup>) to eliminate any thermal bridging and minimise noise levels.

The units include an easily removable, plastic heat exchanger which transfers warmth from the outgoing waste airstream into the incoming fresh air where its thermal efficiency exceeds 90%. At no point do the airstreams mix.



## 100% Automatic Bypass

The unit is equipped with an automatic, 100% bypass which totally isolates the heat exchanger so that no air passes through it. This provides effective cooling in the summer season.

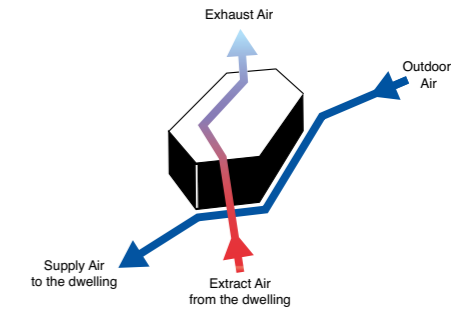

## Technical Data

Specification	Duplexvent DV190SE	Duplexvent DV390SE	Duplexvent DV520SE
Air flow m <sup>3</sup> /hr / l/sec @ 100 Pa	180 / 50	350 / 97	500 / 139
Thermal efficiency	Over 90%	Over 90%	Over 90%
Heat exchanger	Counterflow (Plastic)	Counterflow (Plastic)	Counterflow (Plastic)
Fans	EC	EC	EC
Summer bypass damper	100% automatic	100% automatic	100% automatic
Frost protection	Reducing supply air	Reducing supply air	Reducing supply air
Controls	10-Speed - Digital	10-Speed - Digital	10-Speed - Digital
Connection to BMS	MODBUS (TCP/IP)	MODBUS (TCP/IP)	MODBUS (TCP/IP)
Mounting	Wall / Floor	Wall / Floor	Wall / Floor
Sound level @ 3m (dB(A))	29 - 41	27 - 49	29 - 53
Duct diameter (mm)	4 x 125	4 x 160	4 x 200
Condensate discharge (mm)	16	16	16
Electrical supply	230v / 1ph / 50Hz	230v / 1ph / 50Hz	230v / 1ph / 50Hz
Max. power consumption	100w	200w	360w
Filter class	2 x G4 (optional F7)	2 x G4 (optional F7)	2 x G4 (optional F7)
Electric frost heater	900w (optional)	1500w (optional)	2100w (optional)
Electric post-heater	900w (optional)	1500w (optional)	2100w (optional)
Water post-heater	1000w (optional)	1700w (optional)	2400w (optional)
Casing insulation (mm)	30	30	30
Weight (kg)	26	30	35
Dimensions (L x D x H) mm	560 x 370 x 880	560 x 490 x 950	805 x 510 x 1020
Part No.	90000291	90000292	90000293

## Dimensions

DV190SE

DV390SE

DV520SE

**Duct Connections**

1. Exhaust air outside
2. Outdoor air to the unit
3. Supply air to rooms
4. Extract air to the unit
- K. Condensate drain

+ excludes motors

Model	A	B	C	D
DV190SE	560	370	880	60
DV390SE	560	490	950	60
DV520SE	805	510	1020	60

## Performance

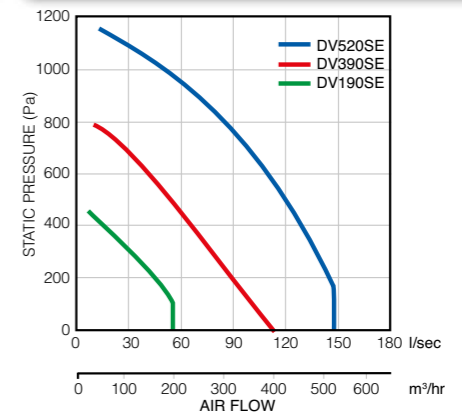

\* Guidance only. Dependant upon system pressure.

## Accessories

See switches/accessories pages 209-239 for more details.



# Duplexvent DV190/390/520SE

Interactive Line Top Entry - Up to 520 m<sup>3</sup>/hr air volume

All the Interactive Line units incorporate an integrated web server with user and service interfaces which enable unit control and monitoring from a remote location.

With this unique feature you can control your unit via a computer, laptop or smart phone in order to maintain the optimum operation at all times. Similarly a service technician can connect to the unit remotely, check the status, diagnose any faults and instruct the user what to do immediately, saving service and down time costs.

The units include a digital controller with LCD display which incorporates 10-speed air flow control, weekly ventilation programming, filter maintenance indicator, automatic frost protection facility and automatic boost function with delay timer.

The units are also continuously checked for any faults by the integrated Failure Diagnostic System which alerts the user as soon as it detects any unusual operation hence providing a real time maintenance update.

On-demand ventilation can be achieved by using humidity, CO<sub>2</sub> and air quality sensors which boost the air volume gradually based on the moisture and occupancy levels in the dwelling. It is also possible to integrate the unit into a Building Management System (MODBUS TCP/IP) to monitor and control the unit's functions by a central control system.

Having the latest, low energy EC fan technology, the DV190SE, DV390SE and DV520SE comply with the ErP 2015 standards, are tested by TUV laboratories and come with an outstanding 5 year warranty\*.

## Controls

The digital control provides the following features:

- 10 speed EC fan control
- Daily / Weekly programme setting
- Automatic boost function with timer delay (via volt-free contact or 0-10V sensor output)
- Automatic frost protection reduces the supply ventilation rate for a certain period to prevent ice build-up within the heat recovery cell depending on the outside air temperature
- Automatic, 100% summer bypass provides free cooling in the summer season. Its motorised damper is triggered by the temperature sensor automatically
- Heater control for frost heater and post-heater
- Filter monitoring and alert via pressure sensors
- BMS connection (Modbus TCP/IP)
- Internet connection with user and service interfaces
- Outputs for electric / water heater
- Zonal ventilation control (winter / summer)
- Constant flow / pressure control
- Indoor temperature control based on extract air / supply air / room temperature via 5 different sensors
- Demand ventilation via CO<sub>2</sub>, humidity and air quality sensors



## Internet Connection

Duplexvent Interactive Line units incorporate an Internet server that uses Modbus TCP/IP protocol to provide a connection between the ventilation unit and the internet via a standard plug and play ethernet cable.

This allows you to monitor and control the unit from a computer, laptop or smartphone via the internet or a local area network. The unit can also be monitored remotely by technical service which saves time and cost on service processes.



## Heaters

The new generation PTC (Positive Temperature Coefficient) electric heater incorporates a power adjustment facility which automatically increases/decreases the power based on the air volume going through the heater hence shortens the heating response.

Also the heater has two protection thermostats and a perforated metal filter which can easily be maintained via the inspection door. This significantly increases its life span especially when the heater is installed on the outdoor air side for frost protection purposes. Alternatively it can be used as post-heater to achieve the required indoor air temperature.



# Duplexvent DV180/370/510SE

Interactive Line Side Entry - Up to 510 m<sup>3</sup>/hr air volume

## Key Features

- For use in small, medium and large sized dwellings up to 280 m<sup>2</sup> \*
- 3 models (side entry) up to 500 m<sup>3</sup>/hr at 100 Pa
- Galvanised steel, double skin casing
- Over 90% thermal efficiency and low noise
- Automatic, 100% summer bypass
- Versatile design (automatic switch between right / left hand configurations)
- Remote control via laptop or smart phone
- Internet connection with service interface
- Ten speed digital control with BMS
- Optional constant flow function
- Compliant to PASSIVE HOUSE Institute and ErP 2015 standards
- 5 year warranty\*



## Duplexvent DV180/370/510SE

The Duplexvent Interactive Line DV180SE, DV370SE and DV510SE are highly efficient, side entry mechanical supply and extract ventilation units with heat recovery for an air capacity of up to 510 m<sup>3</sup>/hr. It is a ceiling mounted unit and is delivered complete with a full condensate drain kit.

The unit is made of galvanised steel and has a double-skin casing which is insulated with 30mm thick polyurethane

(U = 0.65 Wm<sup>-2</sup>K<sup>-1</sup>) to eliminate any thermal bridging and minimise noise levels.

The units include an easily removable, plastic heat exchanger which transfers warmth from the outgoing waste airstream into the incoming fresh air where its thermal efficiency exceeds 90%. At no point do the airstreams mix.



## 100% Automatic Bypass

The unit is equipped with an automatic, 100% bypass which totally isolates the heat exchanger so that no air passes through it. This provides effective cooling in the summer season.

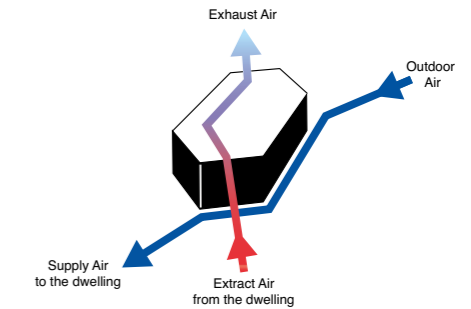

## Technical Data

Specification	Duplexvent DV180SE	Duplexvent DV370SE	Duplexvent DV510SE
Air flow m <sup>3</sup> /hr / l/sec @ 100 Pa	170 / 47	350 / 97	500 / 139
Thermal efficiency	Over 90%	Over 90%	Over 90%
Heat exchanger	Counterflow (Plastic)	Counterflow (Plastic)	Counterflow (Plastic)
Fans	EC	EC	EC
Summer bypass damper	100% automatic	100% automatic	100% automatic
Frost protection	Reducing supply air	Reducing supply air	Reducing supply air
Controls	10-Speed - Digital	10-Speed - Digital	10-Speed - Digital
Connection to BMS	MODBUS (TCP/IP)	MODBUS (TCP/IP)	MODBUS (TCP/IP)
Mounting	Under - Ceiling	Under - Ceiling	Under - Ceiling
Sound level @ 3m (dB(A))	26 - 48	32 - 49	32 - 51
Duct diameter (mm)	4 x 160	4 x 200	4 x 250
Condensate discharge (mm)	16	16	16
Electrical supply	230v / 1ph / 50Hz	230v / 1ph / 50Hz	230v / 1ph / 50Hz
Max. Power consumption	100w	180w	375w
Filter class	2 x G4 (optional F7)	2 x G4 (optional F7)	2 x G4 (optional F7)
Electric frost heater	900w (optional)	1500w (optional)	2100w (optional)
Electric post-heater	900w (optional)	1500w (optional)	2100w (optional)
Water post-heater	1000w (optional)	1700w (optional)	2400w (optional)
Casing insulation (mm)	30	30	30
Weight (kg)	28	32	38
Dimensions (L x D x H) mm	830 x 585 x 280	1120 x 840 x 280	1290 x 860 x 365
Part No.	90000294	90000295	90000296

## Dimensions

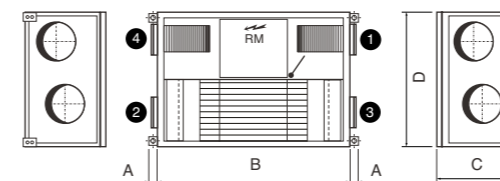

### Right hand connections

1. Supply air to rooms
2. Outdoor air to the unit
3. Extract air to the unit
4. Exhaust air outside

### Left hand connections

1. Exhaust air outside
2. Extract air to the unit
3. Outdoor air to the unit
4. Supply air to rooms

+ excludes motors

Model	A	B	C	D
DV180SE	60	830	280	585
DV370SE	60	1120	280	840
DV510SE	60	1290	365	860

## Performance

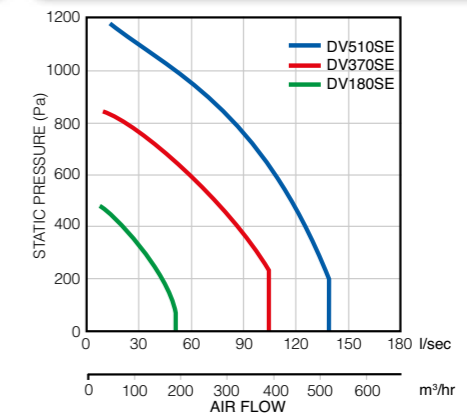

\* Guidance only. Dependant upon system pressure.

## Accessories

See switches/accessories pages 209-239 for more details.

# Duplexvent DV180/370/510SE

Interactive Line Side Entry - Up to 510 m<sup>3</sup>/hr air volume

All the Interactive Line units incorporate an integrated web server with user and service interfaces which enable unit control and monitoring from a remote location.

With this unique feature you can control your unit via a computer, laptop or smart phone in order to maintain the optimum operation at all times. Similarly a service technician can connect to the unit remotely, check the status, diagnose any faults and instruct the user what to do immediately, saving service and down time costs.

The units include a digital controller with LCD display which incorporates 10-speed air flow control, weekly ventilation programming, filter maintenance indicator, automatic frost protection facility and automatic boost function with delay timer.

The units are also continuously checked for any faults by the integrated Failure Diagnostic System which alerts the user as soon as it detects any unusual operation hence providing a real time maintenance update.

On-demand ventilation can be achieved by using humidity, CO<sub>2</sub> and air quality sensors which boost the air volume gradually based on the moisture and occupancy levels in the dwelling. It is also possible to integrate the unit into a Building Management System (MODBUS TCP/IP) to monitor and control the unit's functions by a central control system.

Having the latest, low energy EC fan technology, the DV180SE, DV370SE and DV510SE comply with the ErP 2015 standards, are tested by TUV laboratories and come with an outstanding 5 year warranty\*.

## Controls

The digital control provides the following features:

- 10 speed EC fan control
- Daily / Weekly programme setting
- Automatic boost function with timer delay (via volt-free contact or 0-10V sensor output)
- Automatic frost protection reduces the supply ventilation rate for a certain period to prevent ice build-up within the heat recovery cell depending on the outside air temperature
- Automatic, 100% summer bypass provides free cooling in the summer season. Its motorised damper is triggered by the temperature sensor automatically
- Heater control for frost heater and post-heater
- Filter monitoring and alert via pressure sensors
- BMS connection (Modbus TCP/IP)
- Internet connection with user and service interfaces
- Outputs for electric / water heater
- Zonal ventilation control (winter / summer)
- Constant flow / pressure control
- Indoor temperature control based on extract air / supply air / room temperature via 5 different sensors
- Demand ventilation via CO<sub>2</sub>, humidity and air quality sensors



## Internet Connection

Duplexvent Interactive Line units incorporate an Internet server that uses Modbus TCP/IP protocol to provide a connection between the ventilation unit and the internet via a standard plug and play ethernet cable.

This allows you to monitor and control the unit from a computer, laptop or smartphone via the internet or a local area network. The unit can also be monitored remotely by technical service which saves time and cost on service processes.



## Heaters

The new generation PTC (Positive Temperature Coefficient) electric heater incorporates a power adjustment facility which automatically increases/decreases the power based on the air volume going through the heater hence shortens the heating response.

Also the heater has two protection thermostats and a perforated metal filter which can easily be maintained via the inspection door. This significantly increases its life span especially when the heater is installed on the outdoor air side for frost protection purposes. Alternatively it can be used as post-heater to achieve the required indoor air temperature.









# Duplexvent Range Overview

Residential Heat Recovery

Model	BASIC LINE (TOP ENTRY)		BASIC LINE (SIDE ENTRY)		
	DV72	BV400	DV250	DV300	DV400
					
<b>Air flow m³/hr / l/sec @ 100Pa</b>	235 / 65	425 / 118	250 / 69	300 / 83	400 / 111
<b>Thermal efficiency</b>	Over 90%				
<b>Fans</b>	EC				
<b>Automatic summer bypass</b>	-	Standard	Standard		
<b>100% summer bypass</b>	-	-	Standard		
<b>Frost protection via heater</b>	-	Optional	Optional		
<b>Frost protection via supply air reduction</b>	-	Standard	Standard		
<b>Standard control</b>	3-speed (manual)	3-speed (manual)	100% Variable (manual)		
<b>Alternative control</b>	-	3-speed (digital)	10-speed (digital)		
<b>Boost with delay timer</b>	-	Standard	Optional		
<b>Maintenance indicator</b>	-	Standard	Optional		
<b>Weekly ventilation programming</b>	-	Optional	Optional		
<b>BMS connection</b>	-	Standard	Optional		
<b>Integrated web server</b>	-	-	Optional		
<b>Mounting</b>	Wall / Ceiling	Floor / Wall	Wall / Ceiling / Floor		
<b>Triple filter</b>	-	-	-	-	-
<b>Filter class</b>	2 x G3	2 x G4 (F7 optional)			
<b>Post-heater</b>	Optional				
<b>Warranty</b>	1 year	3 years*	2 years*		
<b>SAP Appendix Q eligible</b>	✓	✓	-	-	-
<b>Passive House Institute certified</b>	-	-	-	-	-

# Duplexvent Range Overview

Residential Heat Recovery

Model	PROFESSIONAL LINE (TOP ENTRY)					PROFESSIONAL LINE (SIDE ENTRY)	
	DV90SCK	DV96SE	DV110SE	DV145SE	DV200SE	DV50	DV80
							
<b>Air flow m³/hr / l/sec @ 100Pa</b>	306 / 85	324 / 90	414 / 115	568 / 158	828 / 230	230 / 64	356 / 99
<b>Thermal efficiency</b>	Up to 90%				Up to 90%		Up to 90%
<b>Fans</b>	EC						
<b>Automatic summer bypass</b>	Standard						
<b>100% summer bypass</b>	Standard						
<b>Frost protection via heater</b>	Standard						
<b>Frost protection via supply air reduction</b>	Standard						
<b>Standard control</b>	4-speed (cookerhood)	8-speed (digital)				4-speed (manual)	
<b>Alternative control</b>	4-speed (manual)	-	-	-	-	4-speed (digital)	
<b>Boost with delay timer</b>	-	Standard	Standard	Standard	Standard	Optional	Optional
<b>Maintenance indicator</b>	-	Standard	Standard	Standard	Standard	Standard	Standard
<b>Weekly ventilation programming</b>	-	Standard	Standard	Standard	Standard	-	-
<b>BMS connection</b>	-	Optional	Optional	Optional	Optional	Optional	Optional
<b>Integrated web server</b>	-	-	-	-	-	-	-
<b>Mounting</b>	Wall				Floor	Floor / Ceiling	
<b>Triple filter</b>	Standard						
<b>Filter class</b>	2 x G4 / 1 x F7						
<b>Post-heater</b>	Standard						
<b>Warranty</b>	5 years*						
<b>SAP Appendix Q eligible</b>	✓	✓	✓	✓	-	✓	✓
<b>Passive House Institute certified</b>	-	✓	✓	✓	-	✓	✓

# Duplexvent Range Overview

Residential Heat Recovery

Model	INTERACTIVE LINE (TOP ENTRY)			INTERACTIVE LINE (SIDE ENTRY)		
	DV190SE	DV390SE	DV520SE	DV180SE	DV370SE	DV510SE
Air flow m³/hr / l/sec @ 100Pa	180 / 50	350 / 97	500 / 139	170 / 47	350 / 97	500 / 139
Thermal efficiency	Over 90%					
Fans	EC					
Automatic summer bypass	Standard					
100% summer bypass	Standard					
Frost protection via heater	Optional					
Frost protection via supply Air reduction	Standard					
Standard Control	10-speed (digital) with internet					
Boost with delay timer	Standard					
Maintenance indicator	Standard					
Weekly ventilation programming	Standard					
BMS connection	Standard					
Integrated web server	Standard					
Mounting	Wall / Floor			Under - Ceiling		
Triple filter	-	-	-	-	-	-
Filter class	2 x G4 (F7 optional)					
Post-heater	Optional					
Warranty	5 years*					
SAP Appendix Q eligible	-	-	-	-	-	-
Passive House Institute certified	-	-	-	-	✓	-

# Air Flow Solutions

## iCON®

The stylish face of ventilation



reddot design award



- Unique, quiet, reliable with modern styling
- A range of fans for toilet, bathroom, utility and kitchen ventilation
- iRIS shutter prevents back draughts and reduces noise ingress
- Choice of Basic, Timer, Humidity, Motion Sensor and SELV models
- Easy fit - a round fan for a round hole
- Complies with Building Regulations



Silver Sandstone Chrome Anthracite



For further information see pages 54-73











Visit: [airflow.com](http://airflow.com)



# Duplexvent Residential Accessories

Part No.	Description	Product Image	DV72	BV400	DV250 DV300 DV400	DV50 DV80	DV96 DV110 DV145 DV200	DV180 DV190 DV370 DV390 DV510 DV520
<b>Controllers - Switches - Sensors</b>								
<b>Manual control switch</b>								
90000082	3 speed, 100% adjustable		⊙	-	-	-	-	-
<b>Boost switch</b>								
90000542	Manual boost (1-way)		⊙	⊙	⊙	⊙	⊙	⊙
<b>Electrical humidistat</b>								
9041570	30-90% rh (volt-free output)		⊙	⊙	⊙	⊙	⊙	⊙
<b>Manual control switch</b>								
90000334	3 speed		-	⊙	-	-	-	-
<b>Digital controller</b>								
90000336	3 speed LCD display with data logger and weekly programming		-	⊙	-	-	-	-
<b>PIR motion sensor</b>								
51969702	With 3-30 min timer (230v output)		-	⊙	-	-	-	-
<b>Manual control switch</b>								
90000408	100% adjustable		-	-	⊙	-	-	-
<b>Digital controller</b>								
90000409	Touch screen panel		-	-	⊙	-	-	-
<b>Manual control switch</b>								
9041219	4 speed, 100% adjustable		-	-	-	⊙	-	-
<b>Digital controller</b>								
90000227	4 speed, 100% adjustable		-	-	-	⊙	-	-
<b>Digital controller</b>								
9041082	8 speed, 100% adjustable		-	-	-	-	⊙	-

# Duplexvent Residential Accessories

Part No.	Description	Product Image	DV72	BV400	DV250 DV300 DV400	DV50 DV80	DV96 DV110 DV145 DV200	DV180 DV190 DV370 DV390 DV510 DV520
<b>Controllers - Switches - Sensors</b>								
<b>Room humidity sensor</b>								
90000320	Room rh (0-10v output)		-	⊙	⊙	-	-	⊙
<b>Duct humidity sensor</b>								
90000313	Duct rh (0-10v output)		-	⊙	⊙	-	-	⊙
<b>Room CO<sub>2</sub> sensor</b>								
90000166	Room CO <sub>2</sub> (0-10v output)		-	⊙	⊙	-	-	⊙
<b>Duct CO<sub>2</sub> sensor</b>								
90000165	Duct CO <sub>2</sub> (0-10v output)		-	⊙	⊙	-	-	⊙
<b>Room air quality sensor</b>								
90000321	Room air quality (0-10v output)		-	⊙	⊙	-	-	⊙
<b>Built-in humidity / air quality sensor</b>								
90000325	Built-in humidity sensor		-	⊙	-	-	-	-
90000344	Built-in air quality sensor		-	⊙	-	-	-	-
<b>Pressure sensor</b>								
90000326	For filter monitoring		-	⊙	-	-	-	-
<b>Digital controller</b>								
90000297	10 speed, incl. internet control		-	-	-	-	-	⊙
<b>Room CO<sub>2</sub> sensor</b>								
9041180	Room CO <sub>2</sub> (LON RS485)		-	-	-	-	⊙	-
<b>Room humidity sensor</b>								
9041181	Room rh (4-20mA output)		-	-	-	-	⊙	-

# Duplexvent Residential Accessories

Part No.	Description	Product Image	DV72	BV400	DV250 DV300 DV400	DV50 DV80	DV96 DV110 DV145 DV200	DV180 DV190 DV370 DV390 DV510 DV520
<b>Filters</b>								
<b>Filter pack</b>								
90000410	2 x G4 filter (DV250)		-	-	⊙	-	-	-
90000411	2 x G4 filter (DV300)		-	-	⊙	-	-	-
90000412	2 x G4 filter (DV400)		-	-	⊙	-	-	-
90000214	2 x G4 / 1 x F7 (DV50)		-	-	-	⊙	-	-
90000213	2 x G4 / 1 x F7 (DV80)		-	-	-	⊙	-	-
9041127	2 x G4 / 1 x F7 (DV90SCK)		-	-	-	⊙	-	-
90000375	2 x G4 / 1 x F7 (DV96SE)		-	-	-	-	⊙	-
90000378	2 x G4 / 1 x F7 (DV110SE)		-	-	-	-	⊙	-
90000376	2 x G4 / 1 x F7 (DV145SE)		-	-	-	-	⊙	-
90000374	2 x G4 / 1 x F7 (DV200SE)		-	-	-	-	⊙	-
9041511	2 x G3 filter		⊙	-	-	-	-	-
90000322	2 x G4 filter		-	⊙	-	-	-	-
90000323	1 x F7 filter		-	⊙	-	-	-	-
90000426	2 x G4 filter (DV190SE)		-	-	-	-	-	⊙
90000427	2 x G4 filter (DV390SE)		-	-	-	-	-	⊙
90000428	2 x G4 filter (DV520SE)		-	-	-	-	-	⊙
90000423	2 x G4 filter (DV180SE)		-	-	-	-	-	⊙
90000424	2 x G4 filter (DV370SE)		-	-	-	-	-	⊙
90000425	2 x G4 filter (DV510SE)		-	-	-	-	-	⊙

# Duplexvent Residential Accessories

Part No.	Description	Product Image	DV72	BV400	DV250 DV300 DV400	DV50 DV80	DV96 DV110 DV145 DV200	DV180 DV190 DV370 DV390 DV510 DV520
<b>Heaters</b>								
<b>Electric duct heater</b>								
90000301	125mm, 1.2kW incl. temp. sensor and control switch		⊙	-	-	-	-	-
<b>Electric duct heater</b>								
90000324	160mm, 1.0kW (BV400)		-	⊙	-	-	-	-
<b>Electric duct heater</b>								
90000413	160mm, 0.4kW (DV250)		-	-	⊙	-	-	-
90000414	160mm, 0.7kW (DV300)		-	-	⊙	-	-	-
90000415	160mm, 1.7kW (DV400)		-	-	⊙	-	-	-
<b>Electric duct heater</b>								
90000162	125mm, 0.9kW (DV190SE)		-	-	-	-	-	⊙
90000163	160mm, 1.5kW (DV180/390SE)		-	-	-	-	-	⊙
90000156	200mm, 2.1kW (DV370/520SE)		-	-	-	-	-	⊙
90000173	250mm, 3.0kW (DV510SE)		-	-	-	-	-	⊙
<b>Water duct heater</b>								
90000429	125mm, 0.7kW (DV190SE)		-	-	-	-	-	⊙
90000430	160mm, 1.2kW (DV180/390SE)		-	-	-	-	-	⊙
90000431	200mm, 1.7kW (DV370/520SE)		-	-	-	-	-	⊙
90000432	250mm, 2.0kW (DV510SE)		-	-	-	-	-	⊙
<b>Other components</b>								
<b>LON-Converter</b>								
9041120	For BMS connection (LON)		-	-	-	-	⊙	-
<b>KNX-Converter</b>								
90000226	For BMS connection (KNX)		-	-	-	-	⊙	-
<b>Horizontal condensate kit</b>								
90000122	For horizontal installation		⊙	-	-	-	-	-
<b>Metal casing</b>								
90000345	Galvanised (DV250)		-	-	⊙	-	-	-
90000347	Galvanised (DV300/400)		-	-	⊙	-	-	-

# Ventilation with Heat Recovery

## Commercial

Duplexvent Commercial Heat Recovery units are designed for saving energy and also improving indoor air quality. These units provide ventilation with heat recovery for commercial and industrial areas by using highly efficient polypropylene exchangers, recovering heat from air to air. The heat is effectively transferred from warm to cold air by the exchangers with high conductivity and performance.

Using these heat recovery units also helps the building to be assessed for the BREEAM (BRE Environmental Assessment Method) standard that is the leading and most widely used environmental assessment method for new buildings. Setting the standard for best practice in sustainable design it has become the de facto measure used to describe a building's environmental performance.

### Duplexvent Flexi Line

Available in four sizes, Duplexvent Flexi Line units meet the ventilation requirements of modern and energy saving buildings as they achieve the highest thermal efficiency (up to 95%) and are the first Passive House Institute certified Commercial MVHR units in the U.K.

Extra benefits include low energy, low noise EC fans, internet connection with smart phone application, BMS connection (ModBus TCP/IP), automatic frost protection and 100% bypass facility.

Unique to the Duplexvent Flexi Line is the ability to install the same unit either on the floor or under the ceiling which provides exceptional flexibility for designers in the specification phase. Similarly HVAC distributors benefit from a range of "off the shelf" air handling units which can be quickly adapted to fit on-site.

### Duplexvent Rotary

Duplexvent Rotary Heat Recovery units use the rotary wheel principle to recover heat that would otherwise be extracted to atmosphere.

The narrow, rotating heat exchanger delivers up to 85% thermal efficiency and using low energy, controllable EC motors is economical to operate.

### Duplexvent Multi / Multi-N Line

Duplexvent Multi and Multi-N Line heat recovery units are used for comfort ventilation, as well as warm-air heating and cooling of small office areas, shops, retail facilities, school buildings, restaurants, sport centres, industrial halls and swimming pools.

**Available in 72 different mounting versions and indoor/outdoor installation options**, all units are fully customised according to the project specification and incorporate a highly efficient counter-cross flow plate heat exchanger achieving a thermal efficiency of 95%.

Extra benefits include low energy, low noise EC fans, internet connection with smart phone application, BMS connection (ModBus, KNX, BACnet), automatic frost protection, built-in heating/cooling coils, air circulation and 100% bypass facility.

Despite the full customisation Multi / Multi-N Line units can be delivered in a period of **4 weeks or earlier** to meet tight project deadlines.

Modular in design the equipment is easily installed in commercial, civic and retail applications.





# Duplexvent Flexi

Heat Recovery Ventilation



## Key Features

- Heat recovery ventilation
- 95% thermal efficiency
- Low energy EC fans
- Versatile unit positioning
- Automatic, 100% bypass
- 10 speed digital control
- Internet connection
- Off the shelf delivery
- Passive House Institute certified
- 2 year warranty +



The indoor climate is of the utmost importance as most of us spend the greater part of our lives indoors. To ensure comfort and a sense of well-being, the air we breathe must be clean, and also be at the right temperature and humidity level. To most people, this is so self-evident that they do not give it a second thought.

Whatever the situation, Mechanical Ventilation with Heat Recovery (MVHR) solutions from Airflow can play a significant role because they help create a healthier living and working environment, while contributing to the reduction of a building's carbon emissions and energy usage.

Unique to the Duplexvent Flexi Line is the ability to position the unit on the floor or in a ceiling suspended position. Also this universal design allows the unit to be installed as either a left or right hand version.

This provides exceptional flexibility for designers in the specification phase and gives contractors the opportunity to locate the unit in the optimum position. Similarly HVAC distributors benefit from a range of "off the shelf" air handling units which can be quickly adapted to fit on-site. No more bespoke orders with long lead times!

+ Excludes motors

## Whole life cost savings

Building Operators and Asset Managers will appreciate the Flexi Line's innovative built-in internet connection with User and Service interface which allows service technicians to connect to the unit from a remote location.

By continuously checking the operating status, diagnosing any faults and instructing the user what to do immediately,

results in saving onsite call outs, preventive service and down-time to both technician and client.

This unique feature minimises the service process as well as creating a secondary control display for the user.



Ceiling Suspended

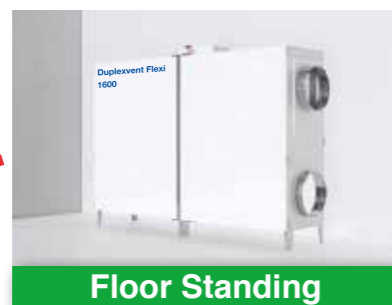

Floor Standing

1 Base Unit  
(FLEXI DV1100 / 1600 / 2600 / 3600)

16 Installation Configurations

+ 3 Upgrade Packs



Optional water / DX heating and cooling coils help maintain optimum indoor conditions



Versatile unit positioning enables right or left hand configuration on the same unit



Interchangeable spigot design allows the spigot connections to be changed on-site (DV1600)

## Upgrade Packs

### 1. Passive House Pack

- Electric pre-heater to warm the incoming air to protect the heat exchangers from freezing

### 2. Constant Pressure Pack

- Differential pressure and flow measurement for energy optimisation

### 3. Hygiene Pack

- Inclined tube manometers to maintain the certified hygiene standard VDI 6022



# Duplexvent Flexi

Heat Recovery Ventilation

## Key Components

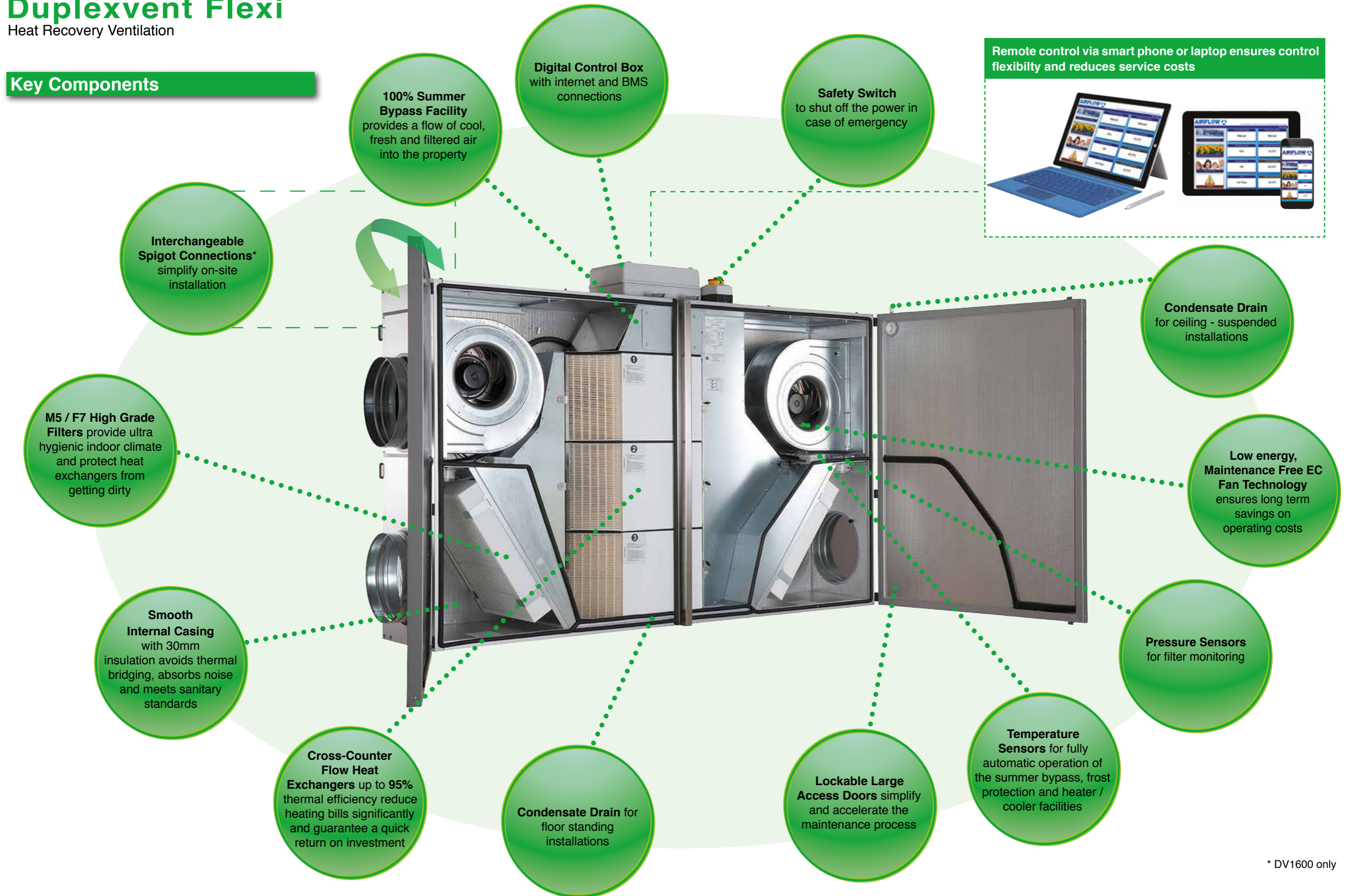

\* DV1600 only



# Duplexvent FLEXI DV1100

Flexi Line Side Entry - Up to 1100 m<sup>3</sup>/hr air volume



## Key Features

- Extract up to 1000 m<sup>3</sup>/hr @ 200 Pa
- Excellent heat recovery efficiency, up to 95%
- Versatile unit positioning with floor and ceiling suspended mounting options
- Low SFP with energy saving EC fans
- Low noise, refer to NR35 and BB93 standards
- 10 speed digital control with Internet and BMS
- Compliant to BREEAM, Passive House and ErP 2015 regulations
- 2 year warranty +

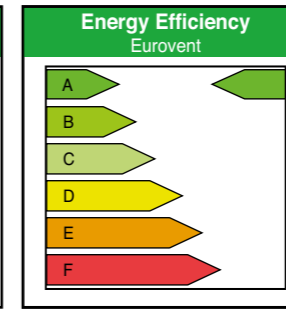
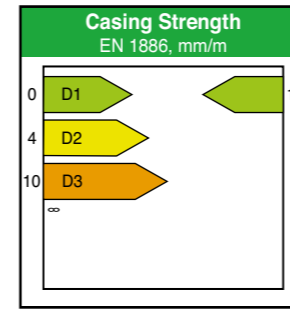

## Performance

Sound Power Level Lw (dB)	dB (A)	63	125	250	500	1 k	2 k	4 k	8 k
Outdoor air e1	47	68	57	47	42	35	28	<25	<25
Supply air e2	66	80	74	69	62	60	55	49	47
Extract air i1	45	67	55	46	40	33	26	<25	<25
Exhaust air i2	65	80	7	68	60	58	53	47	44
Breakout noise	51	70	55	57	44	40	33	27	25
Sound Pressure Level Ld	dB (A)	63	125	250	500	1 k	2 k	4 k	8 k
To the surrounding	21	49	35	37	<25	<25	<25	<25	<25

Sound pressure level is measured at 3m distance

Ventilation	Supply Air	Extract Air
Maximum air volume @ 200 Pa	m <sup>3</sup> /hr / l/sec 1000 / 278	1000 / 278
Air volume @ 150 Pa*	m <sup>3</sup> /hr / l/sec 500 / 139	500 / 139
Nominal voltage	V 230	230
Voltage (at operation point)*	V 230	230
Nominal Power (at operation point)*	W 93	87
Max connection power	W 385	385
Max current	A 2.5	2.5
Filters	F7	M5
Fan Type	EC	EC

\* Note: ● The figures above have been measured at 500 m<sup>3</sup>/hr and 150 Pa. Please use the Duplexvent Selection Software to calculate measurements at other performance levels.

Heat Recovery	Supply Air	Extract Air
Maximum air volume @ 200 Pa	m <sup>3</sup> /hr / l/sec 1000 / 278	1000 / 278
Air volume @ 150 Pa*	m <sup>3</sup> /hr / l/sec 500 / 139	500 / 139
Temperature at inlet*	°C -10	22
Temperature at outlet*	°C 17	2
Humidity at inlet*	%rh 90	40
Humidity at outlet*	%rh 12	100
Thermal efficiency in winter / summer	% 84 / 80	
Performance in winter / summer	kW 4.6 / -0.6	
Condensation	l/h 1.5	
Type of heat exchanger	Counter Flow, Plastic	
Part No.	90000183	

\* Note: ● The figures above have been measured at 500 m<sup>3</sup>/hr and 150 Pa. Please use the Duplexvent Selection Software to calculate measurements at other performance levels.

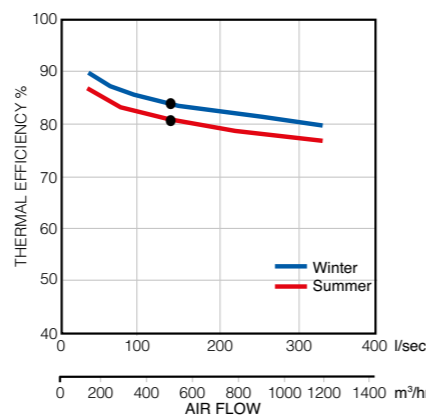
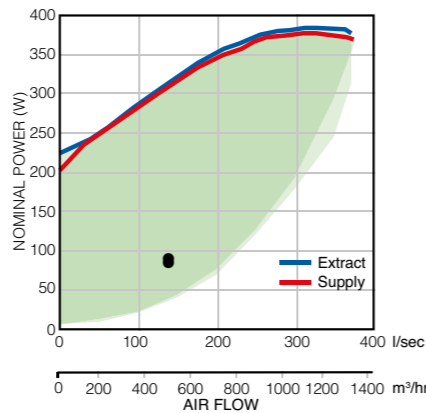
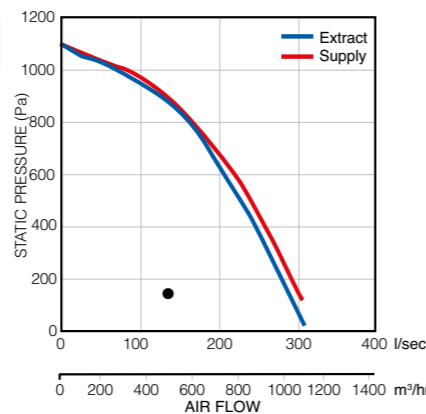

+ Excludes motors

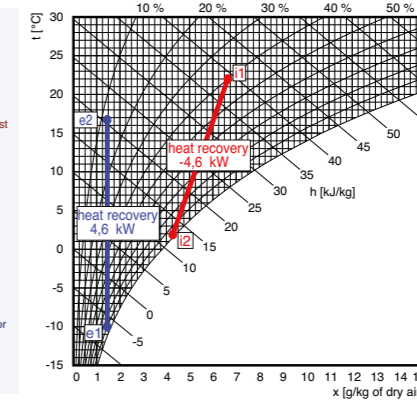
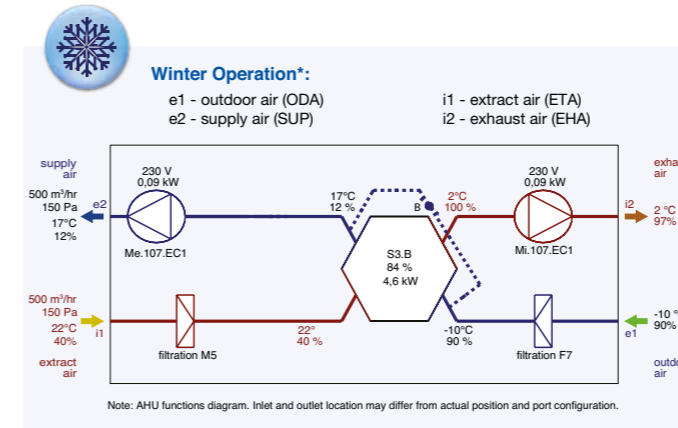

Supply			
Description	t [°C]	rh [%]	
e1 Outdoor Air	-10.0	90	
e2 Supply Air	17.0	12	
Exhaust			
Description	t [°C]	rh [%]	
i1 Extract Air	22.0	40	
i2 Exhaust Air	2.0	100	

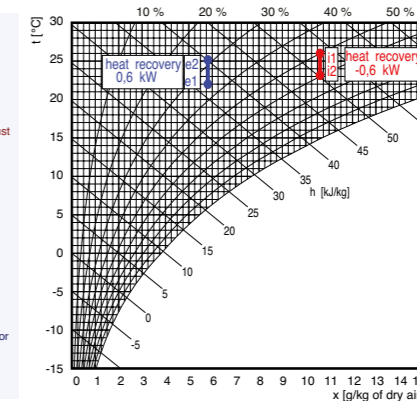
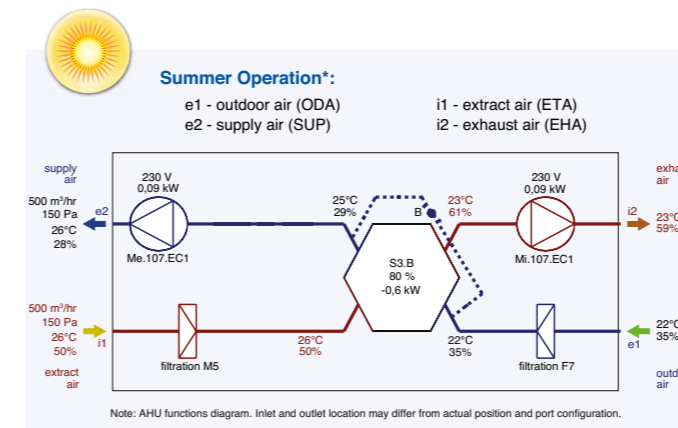

Supply			
Description	t [°C]	rh [%]	
e1 Outdoor Air	22.0	35	
e2 Supply Air	25.0	29	
Exhaust			
Description	t [°C]	rh [%]	
i1 Extract Air	26.0	50	
i2 Exhaust Air	23.0	61	

## Dimensions

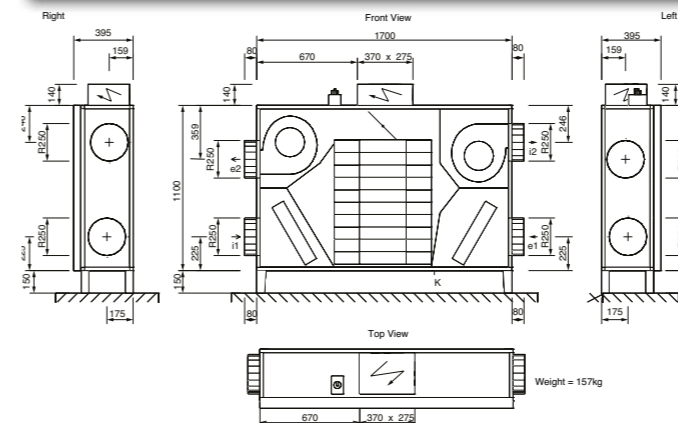

Connections	Type	Diameter	Accessories
e1	Outdoor Air	Ø 250 mm	Shut-off Damper, Flexible Connector
e2	Supply Air	Ø 250 mm	Flexible Connector
i1	Extract Air	Ø 250 mm	Flexible Connector
i2	Exhaust Air	Ø 250 mm	Flexible Connector
K	Condensate Outlet	Ø 21 mm	Condensate Trap

## Accessories

See Duplexvent accessories pages 204-206 for more details.

\* The above figures are example performance measurements. Please use the Duplexvent Selection Software to calculate measurements at other performance levels.



# Duplexvent FLEXI DV1600

Flexi Line Side Entry - Up to 1800 m<sup>3</sup>/hr air volume



## Key Features

- Extract up to 1600 m<sup>3</sup>/hr @ 200 Pa
- Excellent heat recovery efficiency, up to 95%
- Versatile unit positioning with floor and ceiling suspended mounting options
- Low SFP with energy saving EC fans
- Low noise, refer to NR35 and BB93 standards
- 10 speed digital control with internet and BMS
- Interchangeable spigot connections (DV1600 only)
- Compliant to BREEAM, Passive House and ErP 2015 regulations
- 2 year warranty +

## Performance

Sound Power Level L <sub>w</sub> (dB)	dB (A)	63	125	250	500	1 k	2 k	4 k	8 k
Outdoor air e1	46	61	54	49	42	38	31	<25	<25
Supply air e2	68	74	75	70	66	62	58	51	45
Extract air i1	45	61	54	48	42	37	31	<25	<25
Exhaust air i2	68	74	75	70	65	61	58	50	44
Breakout noise	55	59	61	59	51	50	44	32	<25
Sound Pressure Level L <sub>d</sub>	dB (A)	63	125	250	500	1 k	2 k	4 k	8 k
To the surrounding	35	38	41	39	30	29	<25	<25	<25

Sound pressure level is measured at 3m distance

Ventilation		Supply Air	Extract Air
Maximum Air Volume @ 200 Pa	m <sup>3</sup> /hr / l/sec	1600 / 444	1600 / 444
Air volume @ 150 Pa*	m <sup>3</sup> /hr / l/sec	800 / 222	800 / 222
Nominal voltage	V	230	230
Voltage (at operation point)*	V	230	230
Nominal power (at operation point)*	W	114	105
Max connection power	W	490	490
Max current	A	2.9	2.9
Filters		F7	M5
Fan type		EC	EC

\* Note: The figures above have been measured at 800 m<sup>3</sup>/hr and 150 Pa. Please use the Duplexvent Selection Software to calculate measurements at other performance levels.

Heat Recovery		Supply Air	Extract Air
Maximum Air Volume @ 200 Pa	m <sup>3</sup> /hr / l/sec	1600 / 444	1600 / 444
Air volume @ 150 Pa*	m <sup>3</sup> /hr / l/sec	800 / 222	800 / 222
Temperature at inlet*	°C	-10	22
Temperature at outlet*	°C	18	1
Humidity at inlet*	%rh	90	40
Humidity at outlet*	%rh	11	100
Thermal efficiency in winter / summer	%	87 / 84	
Performance in winter / summer	kW	7.7 / -0.9	
Condensation	l/h	2.5	
Type of heat exchanger		Counter Flow, Plastic	
Part No.		90000068	

\* Note: The figures above have been measured at 800 m<sup>3</sup>/hr and 150 Pa. Please use the Duplexvent Selection Software to calculate measurements at other performance levels.

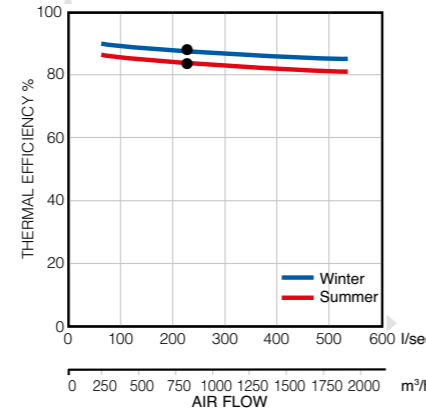
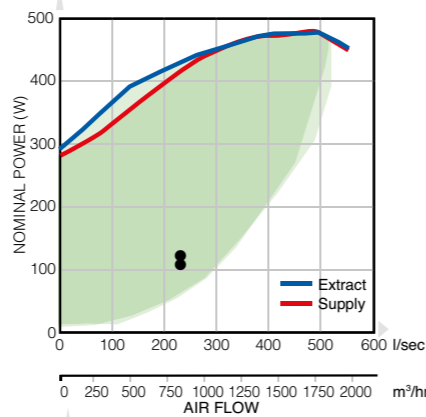
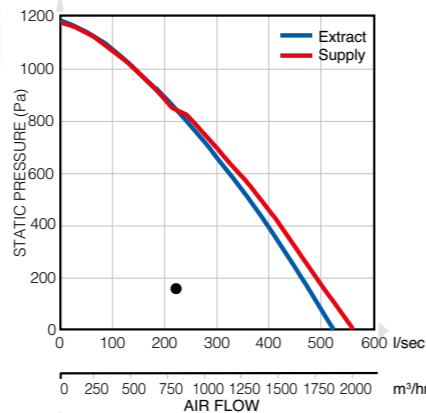

+ Excludes motors

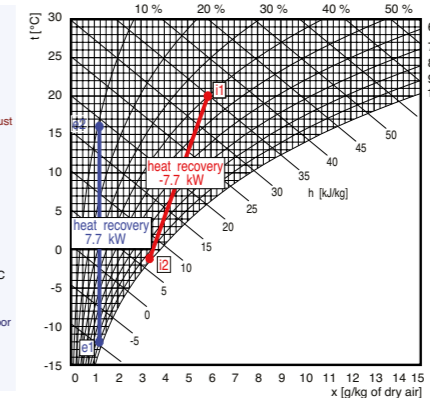
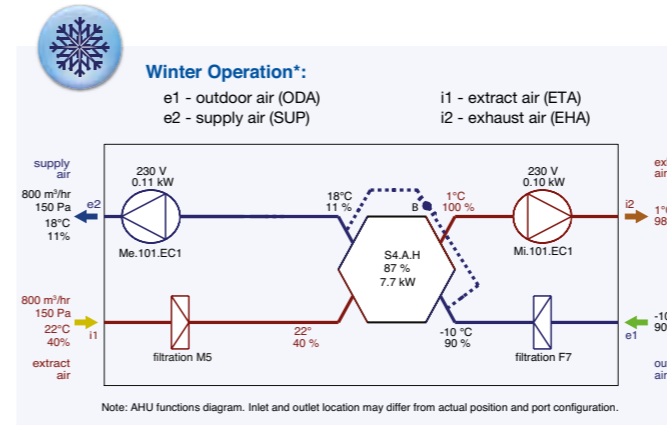
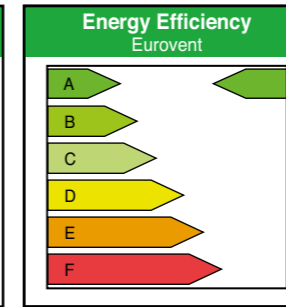
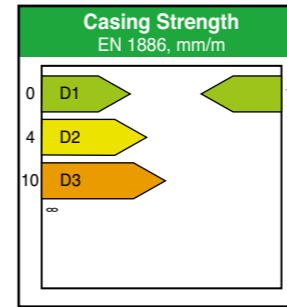

Supply			
Description	t [°C]	rh [%]	
e1	Outdoor Air	-10.0	90
e2	Supply Air	18.0	11
Exhaust			
Description	t [°C]	rh [%]	
i1	Extract Air	22.0	40
i2	Exhaust Air	1.0	100

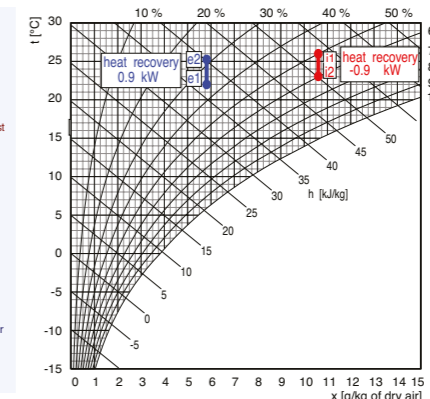
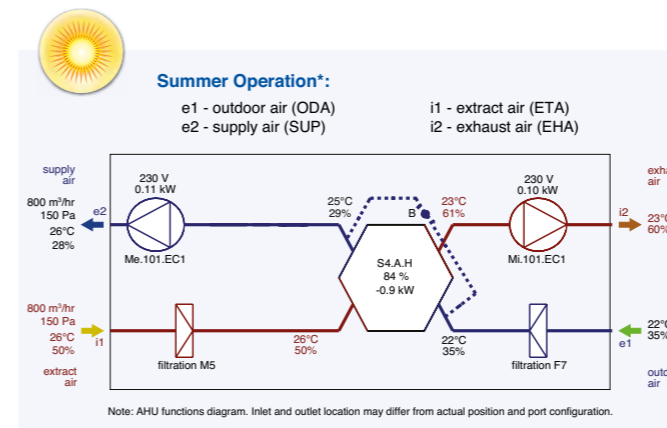

Supply			
Description	t [°C]	rh [%]	
e1	Outdoor Air	22.0	35
e2	Supply Air	25.0	29
Exhaust			
Description	t [°C]	rh [%]	
i1	Extract Air	26.0	50
i2	Exhaust Air	23.0	61

## Dimensions

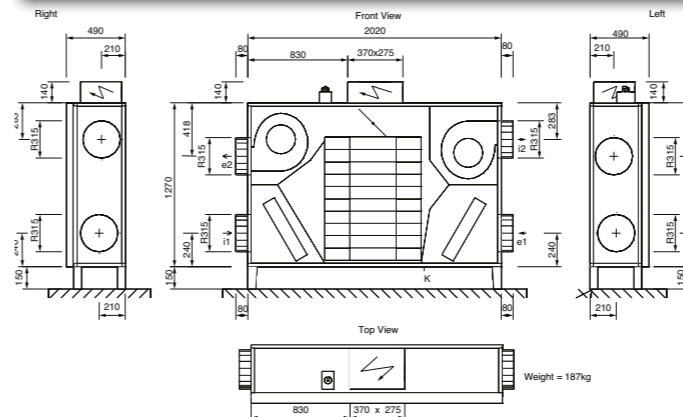

Connections	Type	Diameter	Accessories
e1	Outdoor Air	Ø 315 mm	Shut-off Damper, Flexible Connector
e2	Supply Air	Ø 315 mm	Flexible Connector
i1	Extract Air	Ø 315 mm	Flexible Connector
i2	Exhaust Air	Ø 315 mm	Flexible Connector
K	Condensate Outlet	Ø 21 mm	Condensate Trap

## Accessories

See Duplexvent accessories pages 204-206 for more details.

\* The above figures are example performance measurements. Please use the Duplexvent Selection Software to calculate measurements at other performance levels.





# Duplexvent FLEXI DV3600

Flexi Line Side Entry - Up to 3800 m<sup>3</sup>/hr air volume



## Key Features

- Extract up to 3600 m<sup>3</sup>/hr @ 200 Pa
- Excellent heat recovery efficiency, up to 95%
- Versatile unit positioning with floor and ceiling suspended mounting options
- Low SFP with energy saving EC fans
- Low noise, refer to NR35 and BB93 standards
- 10 speed digital control with internet and BMS
- Compliant to BREEAM, Passive House and ErP 2015 regulations
- 2 year warranty +

## Performance

Sound Power Level L <sub>w</sub> (dB)	dB (A)	63	125	250	500	1 k	2 k	4 k	8 k
Outdoor air e1	50	67	65	46	36	35	28	<25	<25
Supply air e2	70	71	83	72	62	61	54	48	53
Extract air i1	50	66	65	45	38	34	28	<25	<25
Exhaust air i2	69	69	82	71	61	59	53	47	52
Breakout noise	54	56	67	56	49	44	35	<25	<25
Sound Pressure Level L <sub>d</sub>	dB (A)	63	125	250	500	1 k	2 k	4 k	8 k
To the surrounding	33	36	46	36	28	<25	<25	<25	<25

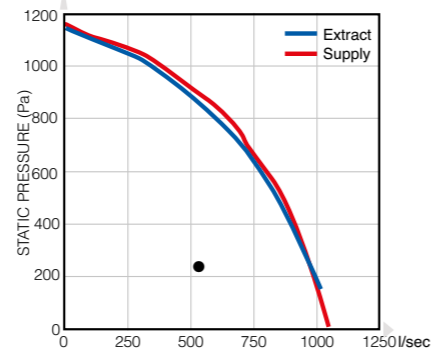

Sound pressure level is measured at 3m distance

Ventilation	Supply Air	Extract Air
Maximum air volume @ 200 Pa	m <sup>3</sup> /hr / l/sec 3600 / 1000	3600 / 1000
Air volume @ 250 Pa*	m <sup>3</sup> /hr / l/sec 2000 / 556	2000 / 556
Nominal voltage	V 400	400
Voltage (at operation point)*	V 400	400
Nominal Power (at operation point)*	W 446	397
Max connection power	W 1480	1480
Max current	A 2.4	2.4
Filters	F7	M5
Fan type	EC	EC

\* Note: ● The figures above have been measured at 2000 m<sup>3</sup>/hr and 250 Pa. Please use the Duplexvent Selection Software to calculate measurements at other performance levels.

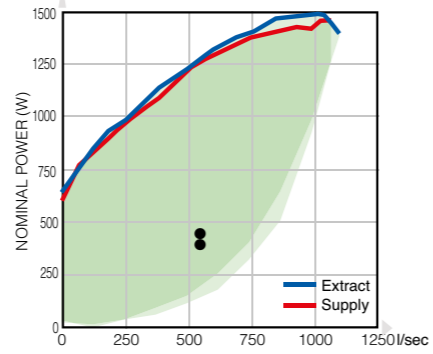

Heat Recovery	Supply Air	Extract Air
Maximum air volume @ 200 Pa	m <sup>3</sup> /hr / l/sec 3600 / 1000	3600 / 1000
Air volume @ 250 Pa*	m <sup>3</sup> /hr / l/sec 2000 / 556	2000 / 556
Temperature at inlet*	°C -10	22
Temperature at outlet*	°C 18	1
Humidity at inlet*	%rh 90	40
Humidity at outlet*	%rh 11	100
Thermal efficiency in winter / summer	% 88 / 84	
Performance in winter / summer	kW 19.4 / -2.3	
Condensation	l/h 6.5	
Type of heat exchanger	Counter Flow, Plastic	
Part No.	90000070	

\* Note: ● The figures above have been measured at 2000 m<sup>3</sup>/hr and 250 Pa. Please use the Duplexvent Selection Software to calculate measurements at other performance levels.

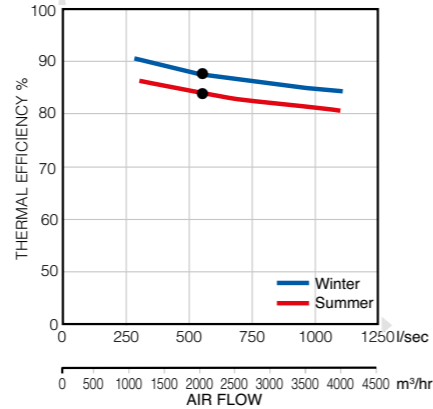

+ Excludes motors

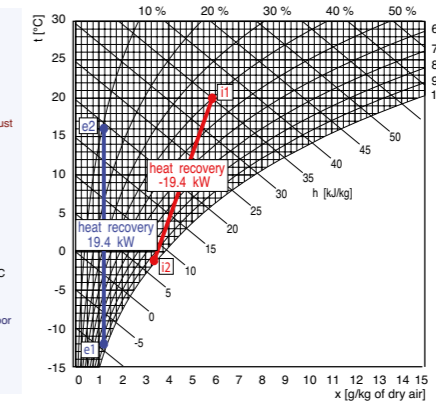
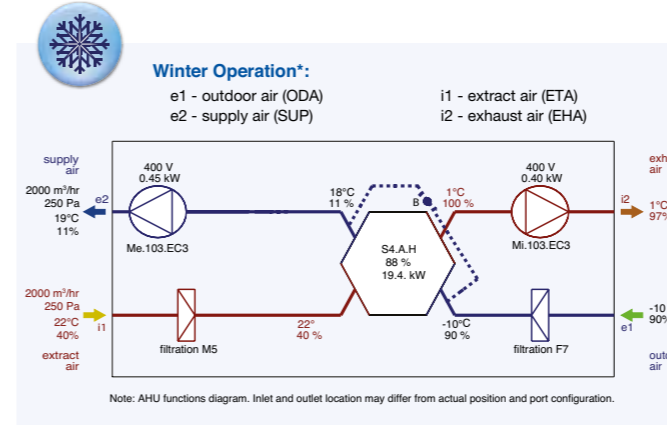
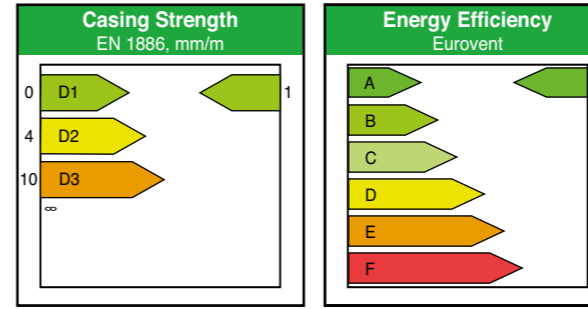

Supply			
Description	t [°C]	rh [%]	
e1	Outdoor Air	-10.0	90
e2	Supply Air	18.0	11
Exhaust			
Description	t [°C]	rh [%]	
i1	Extract Air	22.0	40
i2	Exhaust Air	1.0	100

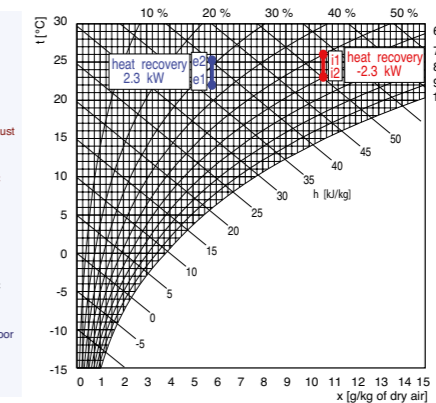
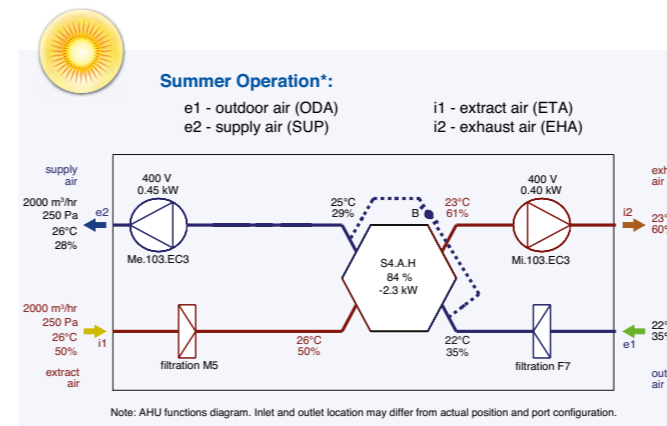

Supply			
Description	t [°C]	rh [%]	
e1	Outdoor Air	22.0	35
e2	Supply Air	25.0	29
Exhaust			
Description	t [°C]	rh [%]	
i1	Extract Air	26.0	50
i2	Exhaust Air	23.0	61

## Dimensions

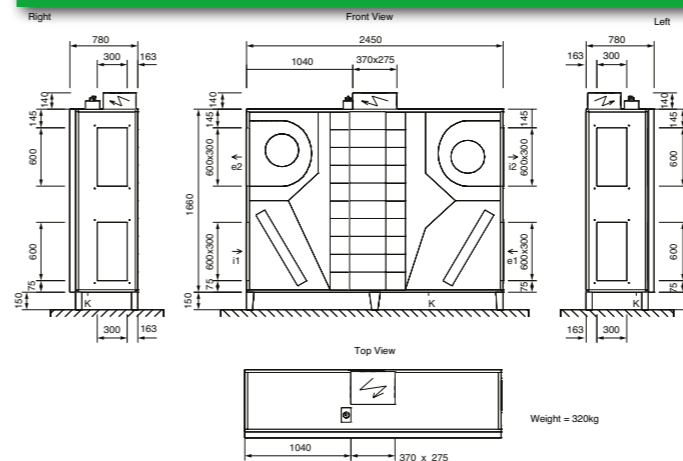

Connections	Type	Diameter	Accessories
e1	Outdoor Air	600 x 300 mm	Shut-off Damper, Flexible Connector
e2	Supply Air	600 x 300 mm	Flexible Connector
i1	Extract Air	600 x 300 mm	Flexible Connector
i2	Exhaust Air	600 x 300 mm	Flexible Connector
K	Condensate Outlet	Ø 21 mm	Condensate Trap

## Accessories

See Duplexvent accessories pages 204-206 for more details.

\* The above figures are example performance measurements. Please use the Duplexvent Selection Software to calculate measurements at other performance levels.



# Duplexvent MULTI

Heat Recovery Ventilation



## Key Features

- Heat recovery ventilation
- 100% customisation
- 95% thermal efficiency
- Low energy EC fans
- Automatic circulation and 100% bypass
- Built-in heating / cooling coils
- 10 speed digital control
- Internet connection with BMS
- Outdoor versions available
- 2 year warranty +



As a ventilation specialist we aim to provide ventilation solutions for commercial applications thanks to our broad range of Commercial Heat Recovery units in excess of 25,000 m<sup>3</sup>/hr air volume with the availability of indoor and outdoor versions.

To accomplish this goal, our Passive House approved, ex-stock Flexi Line units provide the highest thermal efficiency with immediate delivery whilst our customised Multi Line units match your specification in terms of installation flexibility, performance and quality by meeting the high air volume requirements for commercial and large industrial spaces.

+ Excludes motors



## 100% customisation and short delivery time

Multi Line MVHR units follow the business philosophy of multiple variability. Designers can easily modify unit positions, spigot connections, filters, integral heating / cooling coils, bypass and circulation dampers using the selection software which accelerates the specification process and helps meet stringent project requirements.

Despite the full customisation Multi Line units are delivered in a period of 4 weeks or earlier to meet tight project deadlines.

## Multi Line Unit Configurations

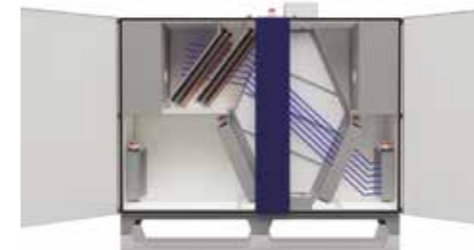
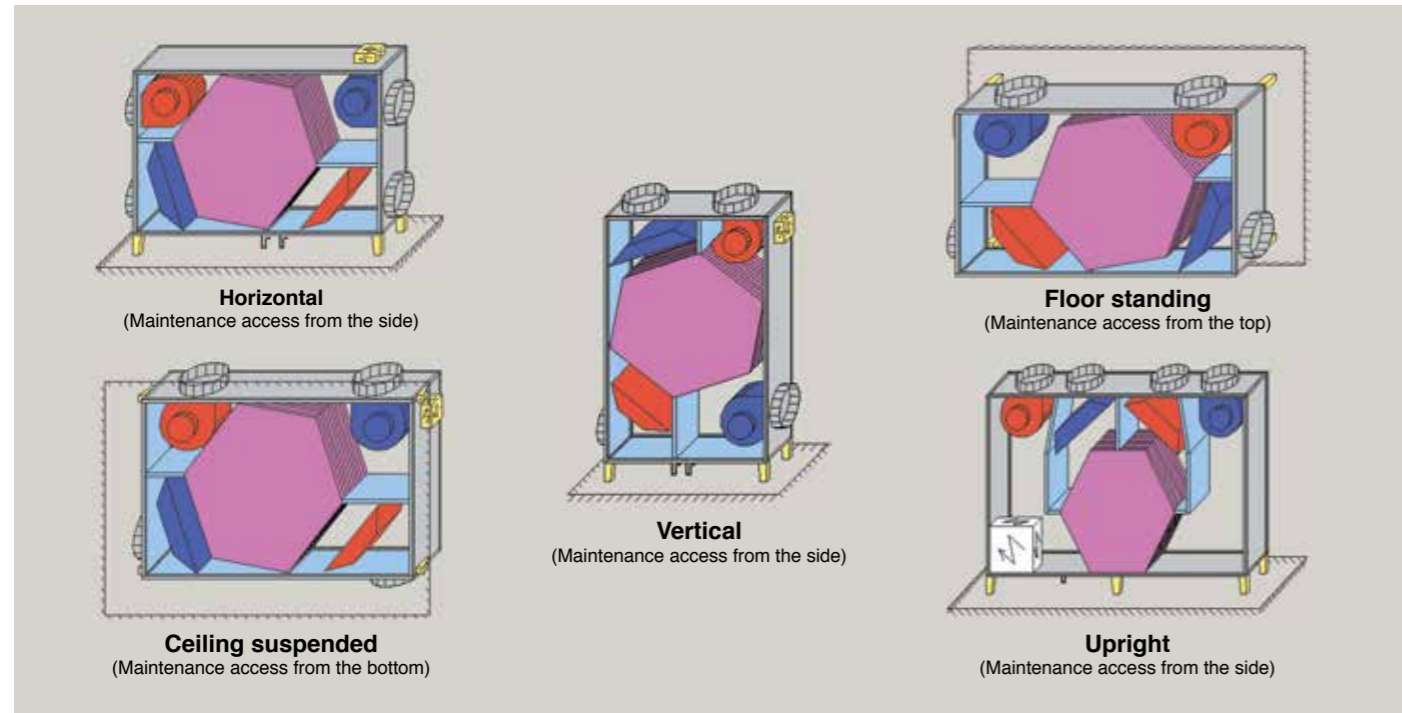

**100% Bypass facility** delivers cool, fresh and filtered air

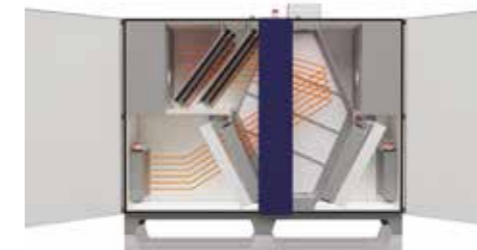

**Circulation damper** helps regulate indoor temperature / humidity conditions

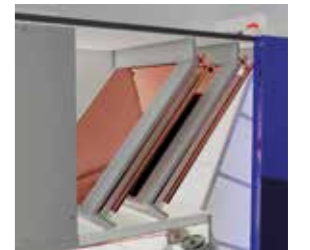

**Built-in water / DX coils** extra heating / cooling

## Duplexvent Multi Size Range

1600 mm	384 mm	1800 mm	384 mm
765 mm	DUPLEXVENT Multi DV500	970 mm	DUPLEXVENT Multi DV1000
1600 mm	455 mm	2300 mm	580 mm
1600 mm	DUPLEXVENT Multi DV1500	1600 mm	DUPLEXVENT Multi DV2500
1600 mm	665 mm	2500 mm	885 mm
1600 mm	DUPLEXVENT Multi DV3500	1600 mm	DUPLEXVENT Multi DV5000
1600 mm	1 065 mm	2500 mm	1290 mm
1600 mm	DUPLEXVENT Multi DV6500	1600 mm	DUPLEXVENT Multi DV8000



# Duplexvent MULTI

Heat Recovery Ventilation

## Key Components



Now its easier to control Duplexvent units using our new smart phone app

**Lockable Large Access Doors** simplify and accelerate the maintenance process

**Digital Control Box** with internet and BMS connections

**Cross-Counter Flow Heat Exchanger** up to 95% thermal efficiency reduce heating bills significantly and guarantee a quick return on investment

**Low Energy, Maintenance Free EC Fan Technology** ensures long term savings on operating costs

**Pressure Sensors** for filter monitoring

**Built-in Heaters / Coolers** provide space saving solution

**G4 / M5 / F7 High Grade Filters** provide ultra hygienic indoor climate and protect heat exchangers from getting dirty

**Temperature Sensors** for fully automatic operation of the summer bypass, frost protection and heater / cooler facilities

**Smooth Internal Casing** with 30mm insulation (class T2) avoids thermal bridging (class TB1), absorbs noise and meets sanitary standards

**Condensate Drain** for floor standing installations

**Circulation Damper** for indoor temperature / humidity control

**100% Summer Bypass Facility** provides a flow of cool, fresh and filtered air into the property





# Duplexvent MULTI

Multi Line Customised Indoor - Up to 9600 m<sup>3</sup>/hr air volume



## Key Features

- Fully customised commercial units in 8 different sizes up to 9000 m<sup>3</sup>/hr at 200 Pa
- Excellent heat recovery efficiency, up to 95%
- Low SFP with energy saving EC fans
- Low noise, refer to NR35 and BB93 standards
- 10 speed digital control with internet and BMS
- Excellent thermal insulation (class T2, TB1)
- Optional circulation and bypass dampers
- BREEAM, EPDB and ErP 2015 compliant
- Meets Building Regulations Part L2A and L2B
- 2 year warranty



## Performance

Duplexvent Multi		DV500	DV1000	DV1500	DV2500	DV3500	DV5000	DV6500	DV8000
Supply air - max. <sup>1</sup>	m <sup>3</sup> /hr	660	1200	2200	3400	4600	5750	7100	9600
Extraction air - max. <sup>1</sup>	m <sup>3</sup> /hr	670	1150	1800	3200	4200	5500	7050	9100
Heat recovery efficiency <sup>2</sup>	%	up to 95%							
Fan type		EC (backward curved impeller)							
Weight <sup>3</sup>	kg	80-110	95-130	200-280	290-370	320-390	370-450	480-560	580-670
Max power input	kW	0.3	0.7	1.2	2.6	4.5	4.6	7.3	9.3
Voltage	V	230	230	230	400	400	400	400	400
Frequency	Hz	50							
RPM - max.	min <sup>-1</sup>	4300	3350	2920	3000	2980	2400	2820	2560
Heating output T - max. <sup>4</sup>	kW	5	14	22	30	42	51	71	88
Cooling output CHW - max. <sup>4</sup>	kW	4	8	16	22	30	42	56	62
Cooling output CHF - max. <sup>4</sup>	kW	3	6	10	13	25	32	41	50
Part No.		9041571	9041572	9041573	9041521	9041522	9041523	9041524	9041525

1. Maximum flow rate at zero external pressure
2. According to air volume
3. Depending on equipment
4. Depending on register type, liquid and flow rates

T - Water heating coil  
CHW - Water cooling coil  
CHF - DX (direct evaporator) coil

+ Excludes motors

## Acoustic power L<sub>w</sub> and Acoustic pressure L<sub>p</sub>

Type	Working point	Acoustic power L <sub>w</sub> [dB(A)]					Acoustic pressure L <sub>p</sub> [dB(A)] at 1 m
		inlet e <sub>1</sub>	inlet i <sub>1</sub>	inlet e <sub>2</sub>	inlet i <sub>2</sub>	unit	
Duplexvent Multi DV500	500m <sup>3</sup> /hr (200Pa)	53	67	80	82	59	48
Duplexvent Multi DV1000	1000m <sup>3</sup> /hr (200Pa)	66	65	86	86	63	52
Duplexvent Multi DV1500	1500m <sup>3</sup> /hr (200Pa)	58	60	83	83	64	53
Duplexvent Multi DV2500	2500m <sup>3</sup> /hr (200Pa)	59	55	80	79	70	59
Duplexvent Multi DV3500	3500m <sup>3</sup> /hr (200Pa)	61	60	92	89	70	59
Duplexvent Multi DV5000	5000m <sup>3</sup> /hr (200Pa)	64	65	88	88	73	62
Duplexvent Multi DV6500	6500m <sup>3</sup> /hr (200Pa)	70	72	96	95	76	65
Duplexvent Multi DV8000	8000m <sup>3</sup> /hr (200Pa)	76	75	99	96	70	59

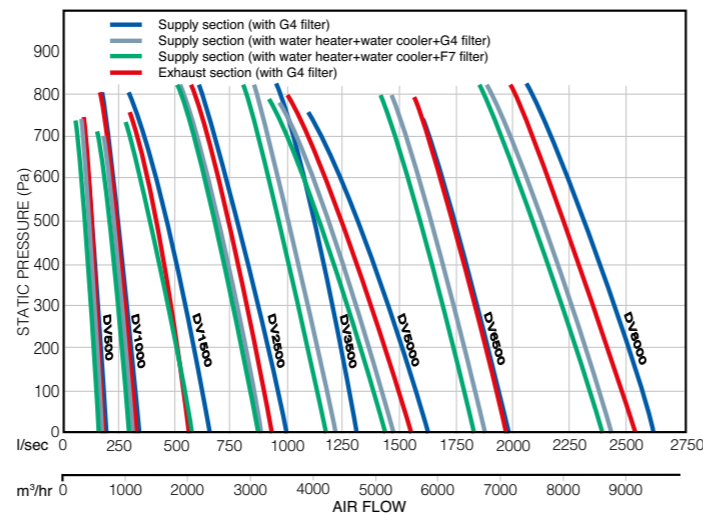

## Performance

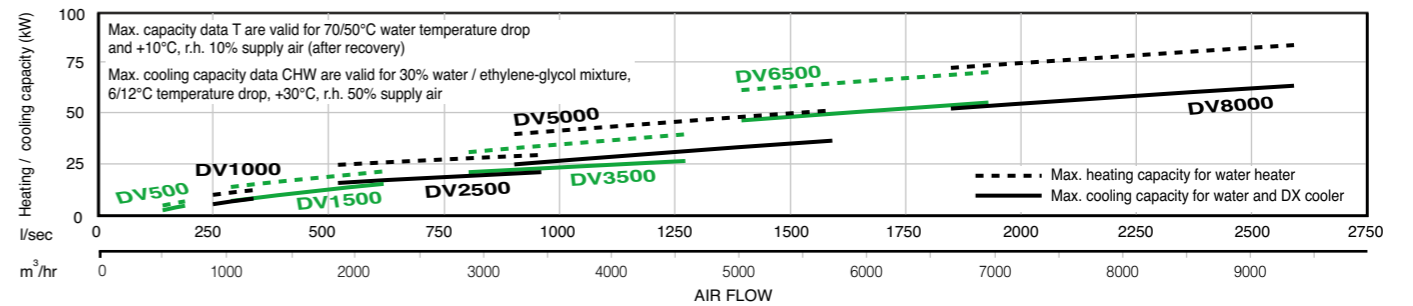
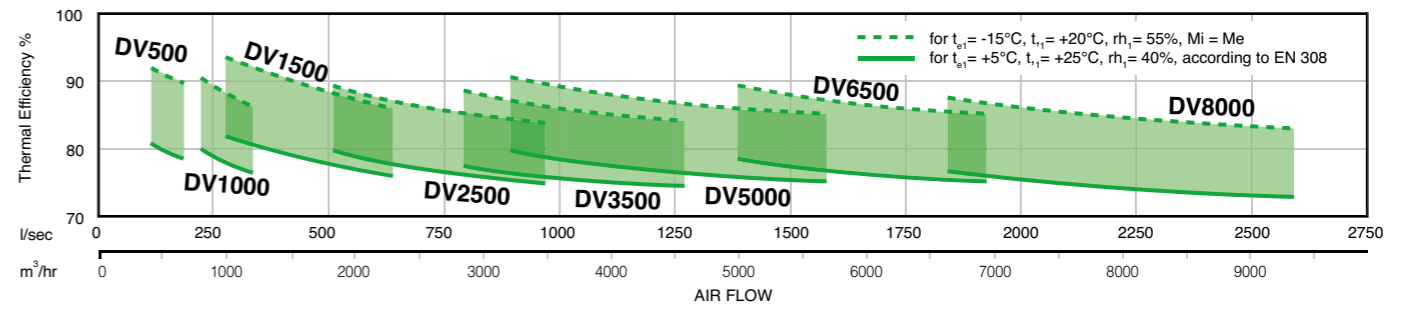

## Dimensions

FLOOR STANDING (front view) Multi DV500 to DV8000

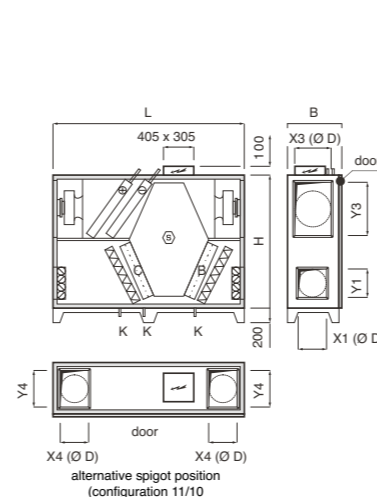

UNDERCEILING (top view) Multi DV500 to DV6500 alternative spigot position (configuration 30/5)

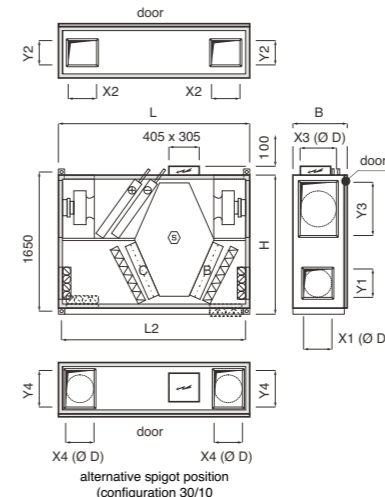

FLOOR STANDING FLAT (top view) Multi DV500 to DV6500 alternative spigot position (configuration 41/5)

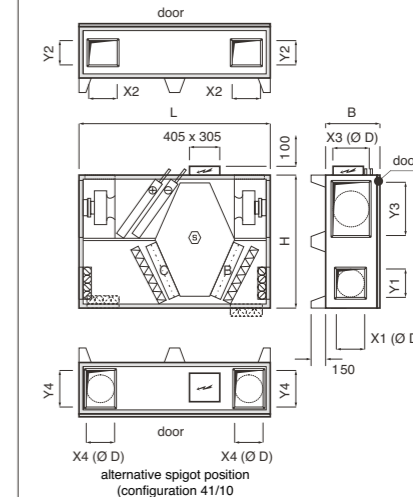

Duplexvent Multi		DV500	DV1000	DV1500	DV2500	DV3500	DV5000	DV6500	DV8000
Dimension H	mm	765	970	1600	1600	1600	1600	1600	1600
Dimension B	mm	384	384	455	580	665	885	1065	1290
Dimension L	mm	1600	1800	2300	2300	2300	2500	2500	2500
Dimension L2	mm	1652	1852	2270	2270	2270	2470	2470	2470
Condensate drain K	mm	ø22				ø32			
<b>Connecting Ports</b>									
Circular diameter D <sup>1</sup>	mm	200	250	315	-	-	-	-	-
Dimension X1 x Y1 (standard e <sub>1</sub> , i <sub>1</sub> )	mm	-	-	-	300 x 400	400 x 400	500 x 500	500 x 500	700 x 500
Dimension X2 x Y2 (atypical e <sub>1</sub> , i <sub>1</sub> )	mm	200 <sup>2</sup>	250 <sup>2</sup>	400 x 200	300 x 400	400 x 400	500 x 500	500 x 500	-
Dimension X3 x Y3 (standard e <sub>2</sub> , i <sub>2</sub> )	mm	-	-	-	450 x 710	500 x 710	710 x 710	900 x 710	900 x 710
Dimension X4 x Y4 (atypical e <sub>2</sub> , i <sub>2</sub> )	mm	-	-	-	250 x 355	250 x 400	355 x 630	355 x 800	355 x 900

1. For Duplexvent Multi DV500, DV1000, DV1500 2. For Duplexvent Multi DV500 and DV1000 only in ceiling - suspended version



# Duplexvent MULTI-N

Heat Recovery Ventilation

## Lift into Place

Ready for crane transport – special suspension points are included as standard for easy connection to a crane.

## Easy Maintenance

Multi-N outdoor units are designed with continuous emphasis on service comfort. The units can be maintained via side access doors, without the need to open the unit doors.



## Duplexvent Multi-N Outdoor Size Range

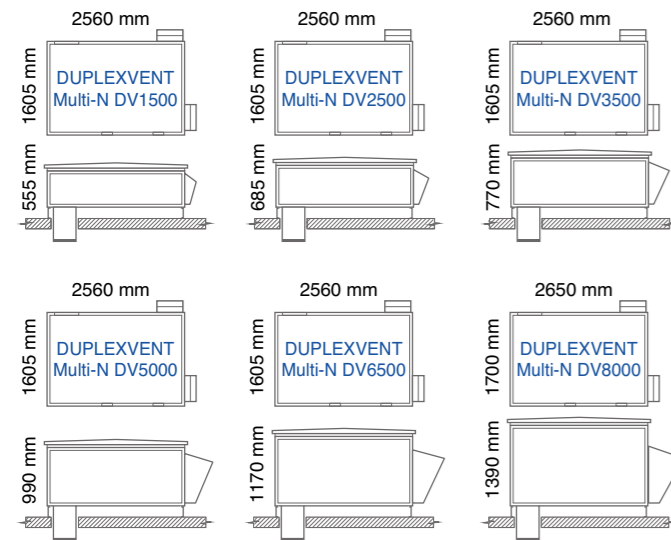

The height dimension is for units only (without the 400mm optional base frame)

## Efficient Installation

Duplexvent MULTI-N outdoor units give the option of being installed directly on to the roof, or on a bespoke low profile, insulated base frame.

Using the stainless steel framed, highly insulated base, allows supply and extract air duct positions within the footprint of the unit. This modular, encapsulated set up reduces duct runs and does away with conventional duct insulation expense while giving a more energy efficient and easily installed unit.

Note: Bespoke insulated base frame is fitted with service access points.



## Compact Size

One of the biggest Duplexvent Multi-N advantages is its compact size. Having an exceptionally low height, all units up to 5000 m<sup>3</sup>/hr are less than 1m high.

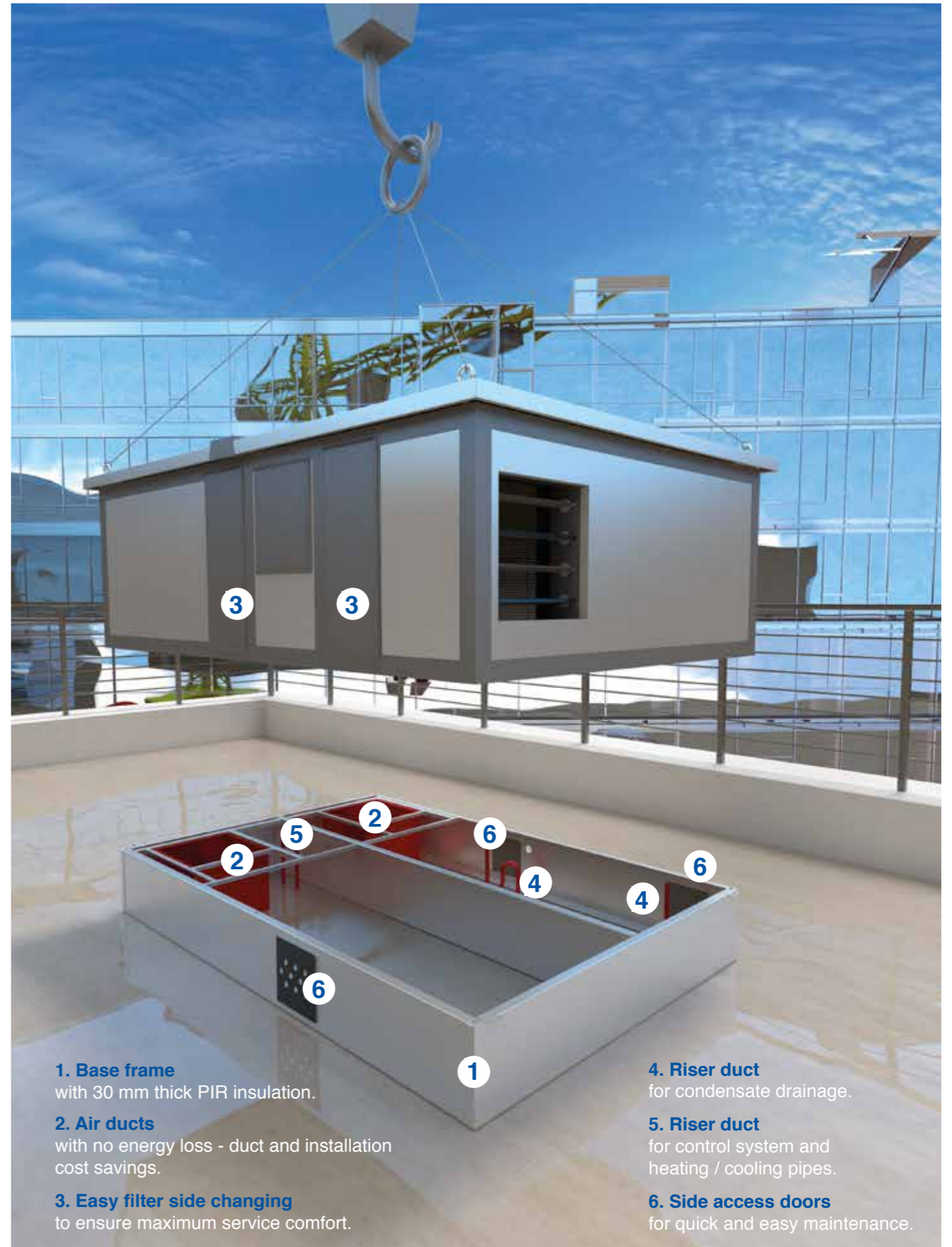

**1. Base frame** with 30 mm thick PIR insulation.

**2. Air ducts** with no energy loss - duct and installation cost savings.

**3. Easy filter side changing** to ensure maximum service comfort.

**4. Riser duct** for condensate drainage.

**5. Riser duct** for control system and heating / cooling pipes.

**6. Side access doors** for quick and easy maintenance.

# Duplexvent MULTI-N

Multi-N Line Customised Outdoor - Up to 8900 m<sup>3</sup>/hr air volume

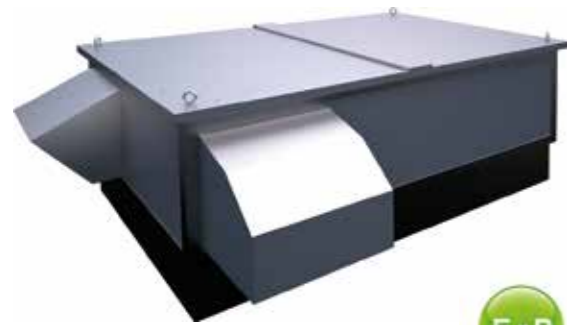

## Key Features

- Fully customised commercial units in 6 different sizes up to 8500 m<sup>3</sup>/hr at 200 Pa
- Excellent heat recovery efficiency, up to 95%
- Low SFP with energy saving EC fans
- Ready for crane support
- Optional insulated base frame reduces heat loss and duct runs
- Side doors for filter change and maintenance
- 10 speed digital control with Internet and BMS
- Optional circulation and bypass dampers
- BREEAM, EPDB and ErP 2015 compliant
- Meets Building Regulations Part L2A and L2B
- 2 year warranty

## Performance

Duplexvent Multi-N		DV1500N	DV2500N	DV3500N	DV5000N	DV6500N	DV8000N
Supply air - max. <sup>1</sup>	m <sup>3</sup> /hr	2500	3600	4700	5500	7200	8800
Extraction air - max. <sup>1</sup>	m <sup>3</sup> /hr	2300	3650	4600	5550	7100	8900
Heat recovery efficiency <sup>2</sup>	%	to 95%					
Fan type		EC (backward curve impeller)					
Weight <sup>3</sup>	kg	290-350	350-480	405-480	460-560	520-630	630-750
Max power input	kW	1,5	2,5	4,4	4,1	6,7	8,9
Voltage	V	230	400	400	400	400	400
Frequency	Hz	50					
RPM - max.	min <sup>-1</sup>	2920	3000	2980	2420	2820	2570
Heating output T - max. <sup>4</sup>	kW	18	27	36	46	67	75
Cooling output CHW - max. <sup>4</sup>	kW	9	12	22	30	39	46
Cooling output CHF - max. <sup>4</sup>	kW	10	13	25	37	41	50
Part No.		9041533	9041534	9041535	9041536	9041520	9041532

1. Maximum flow rate at zero external pressure  
 2. According to air volume  
 3. Depending on equipment  
 4. Depending on register type, liquid and flow rates

T - Water heating coil  
 CHW - Water cooling coil  
 CHF - DX (direct evaporator) coil

+ Excludes motors

## Acoustic power L<sub>w</sub> and Acoustic pressure L<sub>p</sub>D<sub>1</sub>

Type	Working point	Acoustic power L <sub>w</sub> [dB(A)]					Acoustic pressure L <sub>p</sub> [dB(A)] at 1 m
		inlet e <sub>1</sub>	inlet i <sub>1</sub>	inlet e <sub>2</sub>	inlet i <sub>2</sub>	unit	
Duplexvent Multi-N DV1500	1500m <sup>3</sup> /hr (200Pa)	57	57	87	88	61	50
Duplexvent Multi-N DV2500	2500m <sup>3</sup> /hr (200Pa)	58	58	82	82	61	50
Duplexvent Multi-N DV3500	3500m <sup>3</sup> /hr (200Pa)	59	59	87	88	59	48
Duplexvent Multi-N DV5000	5000m <sup>3</sup> /hr (200Pa)	69	69	89	89	63	52
Duplexvent Multi-N DV6500	6500m <sup>3</sup> /hr (200Pa)	73	73	95	95	66	55
Duplexvent Multi-N DV8000	8000m <sup>3</sup> /hr (200Pa)	67	67	80	80	71	60

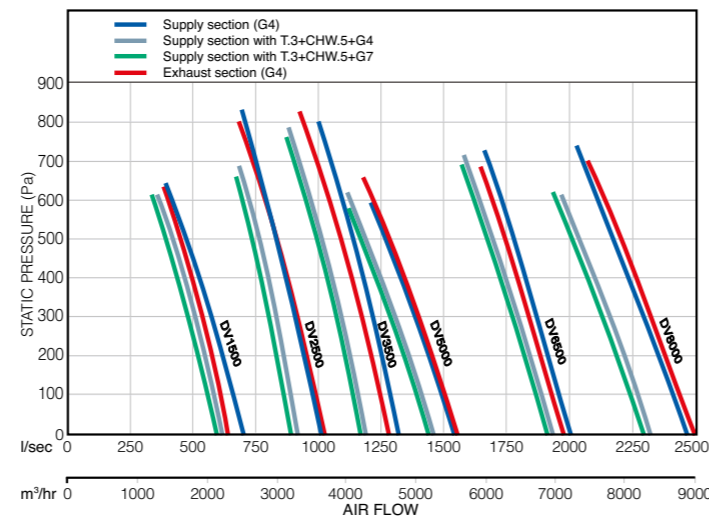

## Performance

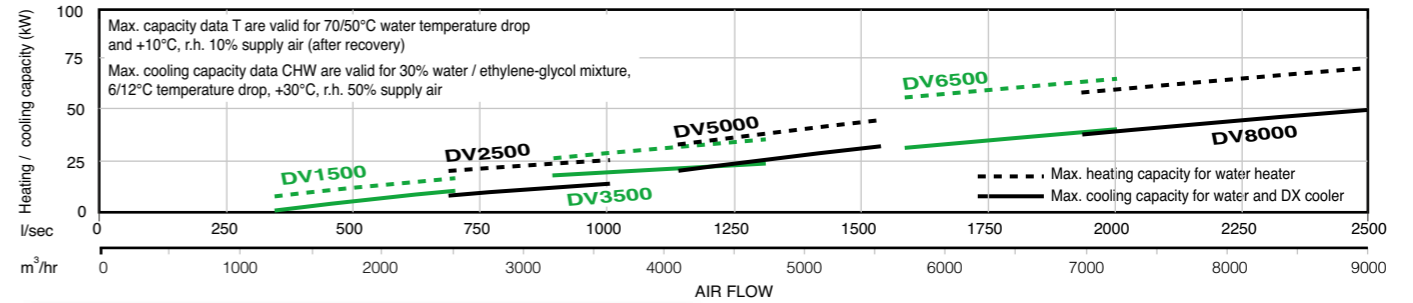
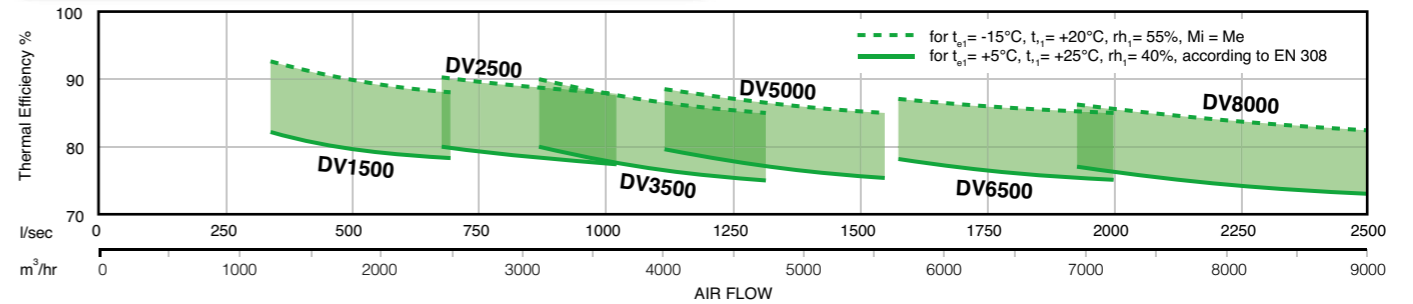

## Dimensions

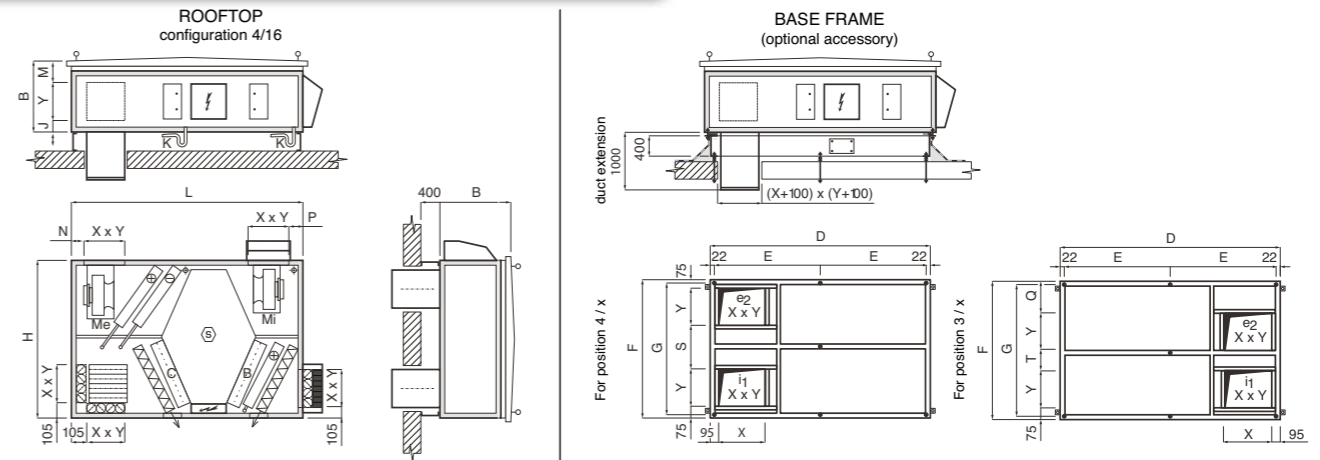

Duplexvent Multi-N		DV1500	DV2500	DV3500	DV5000	DV6500	DV8000
Dimension H	mm	1605	1605	1605	1605	1605	1700
Dimension B	mm	555	685	770	990	1170	1390
Dimension L	mm	2560	2560	2560	2560	2560	2650
Dimension N	mm	130	105	105	105	105	105
Dimension P	mm	135	105	105	105	105	105
Dimension J	mm	100	125	165	225	315	340
Dimension M	mm	155	160	205	265	355	350
Condensate drain	mm	ø32					
<b>Connecting Ports</b>							
Dimension X x Y	mm	300 x 300	400 x 400	400 x 400	500 x 500	500 x 500	700 x 500
<b>Base Frame</b>							
Dimension D	mm	2500	2500	2500	2500	2500	2590
Dimension F	mm	1545	1545	1545	1545	1545	1640
Dimension E	mm	1228	1228	1228	1228	1228	1273
Dimension G (between anchoring holes)	mm	1505	1505	1505	1505	1505	1600
Dimension S	mm	795	595	595	395	395	490
Dimension Q	mm	400	300	300	200	200	278
Dimension T	mm	470	370	370	270	270	287



# Duplexvent ROTARY coming soon!

Rotary Wheel Ventilation with Heat Recovery System – up to 15 000 m<sup>3</sup>/hr air volume



## Key Features

- 3 completely new designed units - air volume from 8000 to 16000 m<sup>3</sup>/hr
- Easy assembly – each unit delivered in 3 parts
- Customised units with a choice of duct orientations
- Indoor or rooftop versions
- Low SFP, high static pressure with significant energy savings from high efficiency EC fans
- All fans comply with ErP 2015
- Excellent heat recovery efficiency, up to 85%
- Thermal rotary wheel heat exchanger
- Double skin construction with 45mm mineral wool insulation to class T2, TB2
- Optional equipment: mixing damper, integrated heating or cooling coils, purge chamber
- BMS protocols: Modbus, TCP, (KNX, BACnet optional)
- VDI 6022, PassivHaus and Eurovent certification pending

The New Duplexvent ROTARY presents a significant advance in the compact construction of a high performance Mechanical Ventilation with Heat Recovery system.

Using the rotary thermal wheel principle, up to 85% heat recovery can be achieved in a range of units delivering up to 16,000m<sup>3</sup>/hr. Installation is simplicity itself as the

unit is delivered in three separate and manageable components. By connecting the three modules together on-site, a choice of equipment locations is possible ensuring convenience and accessibility for routine filter replacement. Quiet in operation and using low energy EC motors the equipment is fully specified with a range of optional components and full BMS and internet connectivity



## Performance

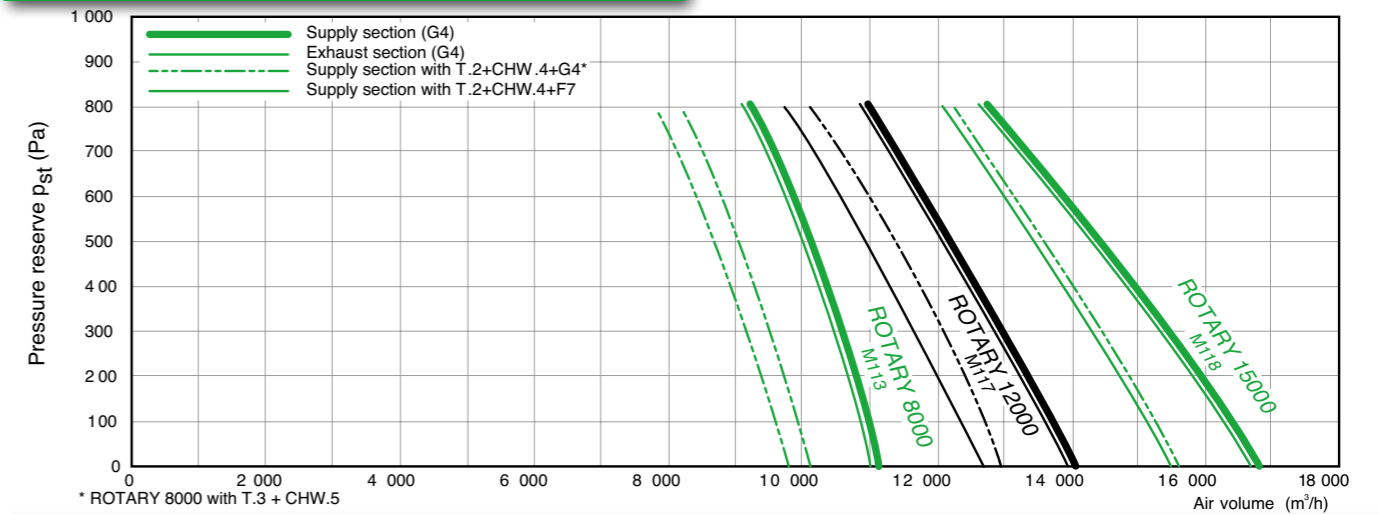

## Duplexvent ROTARY - A New Generation in Mechanical Ventilation with Heat Recovery

Providing outstanding performance from within a compact shape. The modular construction comprises of separate supply and extract backward curve EC fan and filter boxes which abut up to the rotary thermal wheel heat exchanger. Easy to transport and install on site they combine to create an outstanding Mechanical Ventilation with Heat Recovery unit designed for a range of commercial and industrial applications.

The equipment casing is a twin skin construction with high performance 45mm mineral wool core and a heat transfer characteristics of 0.037 W/mk. Thermal bridging is to class T2 with a heat bridge factor of TB2. Access doors are provided for ease of filter maintenance. Utilising Ziehl

Abegg EC motors extremely low SFP values from 0.45W/m<sup>3</sup>/h are achieved (dependant upon flow)

Duplexvent ROTARY range

ROTARY 8000 up to 11000 m<sup>3</sup>/h

ROTARY 12000 up to 14000 m<sup>3</sup>/h

ROTARY 15000 up to 16000 m<sup>3</sup>/h

Multiple choice duct connectivity is a feature of ROTARY. Supply and extract ports may be rotated by 90 degrees to facilitate on-site duct connections in limited access spaces enabling connecting ducting to be configured in accordance with the space and structure of the building.



## System Control

BMS control interface is standard with Modbus TCP, (KNX and BACnet optional) protocols.

Alternatively the Duplexvent RD5 control system with internet connectivity may be specified to control remote equipment from a PC, Tablet or Smart phone



# Duplexvent - Advanced Functionality and Control

## Motion-Blue Control System

Duplexvent Commercial Heat Recovery units are delivered with a choice of control options which enables complete functionality of the Flexi and Multi units.



- Advanced control with digital display
- 10 speed EC fan control
- Automatic 100% bypass control for free cooling
- Daily / Weekly programme setting
- Filter monitoring via pressure sensors
- BMS connection (Modbus, Konnex, BACnet)
- Internet connection with user and service interfaces
- Frost protection facility (heater assisted)
- Outputs for electric / water heater and DX / water cooler
- Zonal ventilation control (winter / summer)
- Constant flow / pressure control
- Temperature control (based on extract or supply air) via 5 built-in temperature sensors
- On-demand ventilation via CO<sub>2</sub>, humidity and air quality sensors

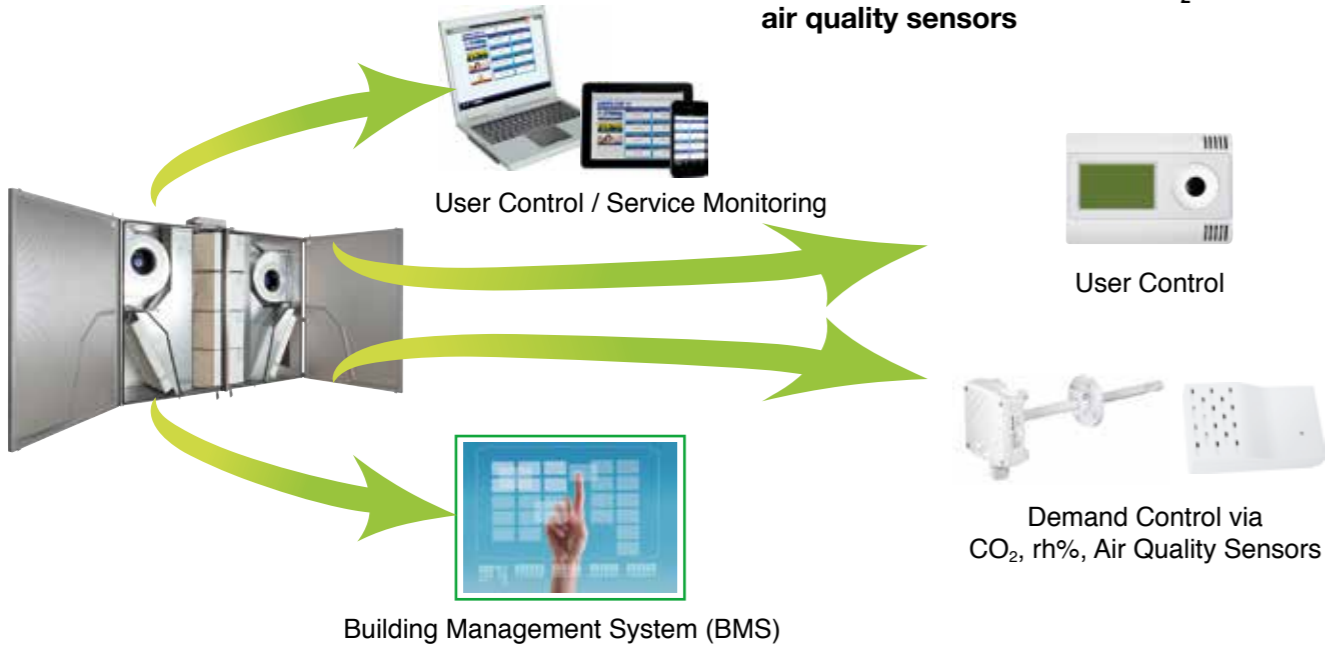

## Internet Connection

Duplexvent commercial units incorporate an Internet server that uses Modbus TCP/IP protocol to provide a connection between the ventilation unit and the internet via a standard plug and play ethernet cable.

This allows you to monitor and control the unit from a laptop via the internet or a local area network. The unit can also be monitored remotely by technical service which saves time and cost on service processes.



# Duplexvent - Selection Software



## AHUs Selection Software



Visit: [airflow.com/selecionsoftware](http://airflow.com/selecionsoftware)

Our advanced and user friendly Duplexvent Selection Software makes it possible to select the most suitable product in just a few simple steps.

This freely available online software\* gives a quick survey of the right choice of product and easy access to relevant technical information.

After having chosen the unit and accessories you can select exactly what specification is needed for your project.

Technical specifications, air flow performance graphs, energy calculations, sound data and dimension drawings are all produced using the software.

## Quick and Easy Selection

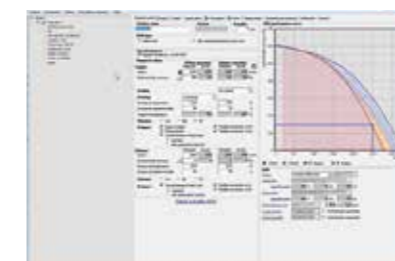

### Operation:

- Input of technical parameters such as air volume, static pressure, temperature etc.
- Input of unit functions such as heating, cooling, air circulation, bypass etc.
- Automatic selection of the suitable ventilation unit



### Software Outputs:

- Complete technical documentation including air path and HX diagrams
- Specification of the selected units and components with part numbers and prices

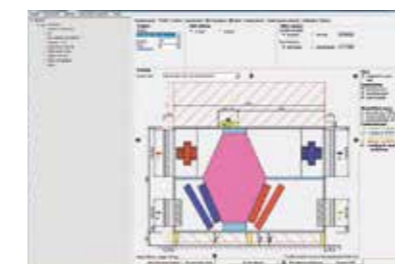

### Unit Construction:

- Selection of unit configuration and spigot positions for the specified installation
- Detailed dimensions of the ventilation unit including the spigot size and maintenance space



- Electrical wiring diagram with detailed information about supply voltage, rated current of the fans, fuses, cable connections etc.
- Data can be exported as doc, pdf or dxf (Autocad) format
- Product catalogue pages

\*The updated version of the selection software, which is updated every 6 months, can be found on our website [airflow.com](http://airflow.com)

# Duplexvent - Versatile Solutions

## Typical Applications

Nursery



Offices



Large Residential Properties



Restaurants



Schools and Colleges



Retail



Industrial Plants



Public Areas



# Duplexvent - Versatile Solutions

## Typical Installations

MULTI DV1500



FLEXI DV2600



MULTI-N DV1500



FLEXI DV3600



MULTI-N DV5000



MULTI-N DV3500



MULTI-N DV6500



MULTI DV8000









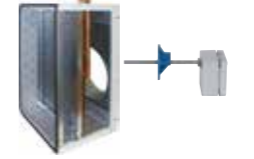

# Duplexvent Commercial Accessories

## Flexi Line Accessories











Part No.	Description	Product Image	DV1100	DV1600	DV2600	DV3600
<b>Extract air filter</b>						
90000174	M5 filter		⊙	-	-	-
90000083	M5 filter		-	⊙	-	-
90000085	M5 filter		-	-	⊙	-
90000139	M5 filter		-	-	-	⊙
<b>Supply air filter</b>						
90000175	F7 filter		⊙	-	-	-
90000084	F7 filter		-	⊙	-	-
90000086	F7 filter		-	-	⊙	-
90000140	F7 filter		-	-	-	⊙
<b>Flexible connector</b>						
90000169	250mm connection		⊙	-	-	-
90000095	315mm connection		-	⊙	-	-
90000096	500 x 250mm connection		-	-	⊙	-
90000134	600 x 300mm connection		-	-	-	⊙
<b>Shut-off damper with spring return</b>						
90000172	250mm connection		⊙	-	-	-
90000098	315mm connection		-	⊙	-	-
90000100	500 x 250mm connection		-	-	⊙	-
90000137	600 x 300mm connection		-	-	-	⊙
<b>Shut-off damper without spring return</b>						
90000181	250mm connection		⊙	-	-	-
90000097	315mm connection		-	⊙	-	-
90000099	500 x 250mm connection		-	-	⊙	-
90000182	600 x 300mm connection		-	-	-	⊙
<b>Electric duct heater</b>						
90000173	3.0kW, 250mm connection		⊙	-	-	-
90000091	6.0kW, 315mm connection		-	⊙	-	-
90000092	10.5kW, 500 x 250mm connection		-	-	⊙	-
90000138	13.5kW, 600 x 300mm connection		-	-	-	⊙
<b>Water heating coil + duct temp. sensor (floor standing position)</b>						
90000200	5.4kW at 60/40°C		⊙	-	-	-
90000202	7.8kW at 60/40°C		-	⊙	-	-
90000204	12.0kW at 60/40°C		-	-	⊙	-
90000206	16.0kW at 60/40°C		-	-	-	⊙

# Duplexvent Commercial Accessories

Part No.	Description	Product Image	DV1100	DV1600	DV2600	DV3600
<b>Water heating coil + duct temp. sensor (ceiling suspended position)</b>						
90000201	5.4kW at 60/40°C		⊙	-	-	-
90000203	7.8kW at 60/40°C		-	⊙	-	-
90000205	12.0kW at 60/40°C		-	-	⊙	-
90000207	16.0kW at 60/40°C		-	-	-	⊙
<b>Hydraulic kit (water heater) including 4-way valve with mixing pump and actuator</b>						
90000105	Hydraulic kit for water heater		⊙	⊙	⊙	⊙
<b>Water cooling coil + duct temp. sensor + RD-IO circuit board + free chamber (floor standing position)</b>						
90000192	3.4kW at 6/12°C		⊙	-	-	-
90000194	4.8kW at 6/12°C		-	⊙	-	-
90000196	7.5kW at 6/12°C		-	-	⊙	-
90000198	11.0kW at 6/12°C		-	-	-	⊙
<b>Water cooling coil + duct temp. sensor + RD-IO circuit board + free chamber (ceiling suspended position)</b>						
90000193	3.4kW at 6/12°C		⊙	-	-	-
90000195	4.8kW at 6/12°C		-	⊙	-	-
90000197	7.5kW at 6/12°C		-	-	⊙	-
90000199	11.0kW at 6/12°C		-	-	-	⊙
<b>Hydraulic kit (water cooler) including 3-way valve and actuator</b>						
90000161	Hydraulic kit for water cooler		⊙	⊙	⊙	⊙
<b>Water heating/cooling coils + duct temp. sensor + RD-IO circuit board (floor standing position)</b>						
90000184	5.4kW at 60/40°C, 3.4kW at 6/12°C		⊙	-	-	-
90000186	7.8kW at 60/40°C, 4.8kW at 6/12°C		-	⊙	-	-
90000188	12.0kW at 60/40°C, 7.5kW at 6/12°C		-	-	⊙	-
90000190	16.0kW at 60/40°C, 11.0kW at 6/12°C		-	-	-	⊙
<b>Water heating/cooling coils + duct temp. sensor + RD-IO circuit board (ceiling suspended position)</b>						
90000185	5.4kW at 60/40°C, 3.4kW at 6/12°C		⊙	-	-	-
90000187	7.8kW at 60/40°C, 4.8kW at 6/12°C		-	⊙	-	-
90000189	12.0kW at 60/40°C, 7.5kW at 6/12°C		-	-	⊙	-
90000191	16.0kW at 60/40°C, 11.0kW at 6/12°C		-	-	-	⊙
<b>RD-IO circuit board</b>						
90000094	Additional PCB (all units)		⊙	⊙	⊙	⊙
<b>DX coil (floor standing position)</b>						
90000178	DX (direct expansion) coil		⊙	-	-	-
90000147	DX (direct expansion) coil		-	⊙	-	-
90000149	DX (direct expansion) coil		-	-	⊙	-
90000151	DX (direct expansion) coil		-	-	-	⊙

# Duplexvent Commercial Accessories

## Flexi Line Accessories

Part No.	Description	Product Image	DV1100	DV1600	DV2600	DV3600
<b>DX coil (ceiling suspended position)</b>						
90000179	DX (direct expansion) coil		⊙	-	-	-
90000148	DX (direct expansion) coil		-	⊙	-	-
90000150	DX (direct expansion) coil		-	-	⊙	-
90000152	DX (direct expansion) coil		-	-	-	⊙
<b>Free chamber for water / DX cooling coils</b>						
90000180	Free chamber		⊙	-	-	-
90000153	Free chamber		-	⊙	-	-
90000154	Free chamber		-	-	⊙	-
90000155	Free chamber		-	-	-	⊙
<b>Constant flow kit (including two pressure sensors)</b>						
90000093	Constant flow kit		⊙	⊙	⊙	-
90000167	Constant flow kit		-	-	-	⊙
<b>Constant pressure box</b>						
90000208	Constant pressure box		⊙	⊙	⊙	⊙
<b>VDI 6022 hygiene pack with inclined tube manometers</b>						
90000090	VDI 6022 hygiene pack		⊙	⊙	⊙	⊙
<b>Duct temperature sensor</b>						
90000089	Duct temp. (0-24v output)		⊙	⊙	⊙	⊙
<b>Room humidity sensor</b>						
90000320	Room rh (0-10v output)		⊙	⊙	⊙	⊙
<b>Duct humidity sensor</b>						
90000313	Duct rh (0-10v output)		⊙	⊙	⊙	⊙
<b>Room CO<sub>2</sub> sensor</b>						
90000166	Room CO <sub>2</sub> (0-10v output)		⊙	⊙	⊙	⊙
<b>Duct CO<sub>2</sub> sensor</b>						
90000165	Duct CO <sub>2</sub> (0-10v output)		⊙	⊙	⊙	⊙
<b>Room air quality sensor</b>						
90000321	Room air quality (0-10v output)		⊙	⊙	⊙	⊙

# Air Flow Solutions

## DUPLEXVENT®

### Ventilation with Heat Recovery

Helping create a fresher, healthier, indoor environment and saving energy too!



ALL PASSIVE HOUSE CERTIFIED



- Over 90% Heat Recovery
- Low energy EC fans
- TRIPLE filter design
- 100% bypass
- 8 speed digital control
- 5 year warranty\*
- Off the shelf delivery
- Complies with Building Regulations



\*Excluding motors

For further information see pages 136 - 157

Visit: [airflow.com](http://airflow.com)





# Accessories

A varied and comprehensive range of accessories for all your ventilation needs

<b>AirflexPro Ducting</b>	Zero leakage semi rigid ducting
<b>Airflex Retro Ducting</b>	Discreet coving ducting
<b>Airflex Ducting</b>	Versatile range of flexible ducting
<b>Airflat Ducting</b>	204mm x 60mm low profile channel ducting
<b>Air Round Ducting</b>	Round rigid ducting
<b>Airflex ISO Ducting</b>	Pre-insulated ducting
<b>Grilles and Valves</b>	A range of terminal grilles and valves
<b>Roof Cowls, Slates and Traps</b>	A range of roof terminal solutions
<b>Venting Kits</b>	A range of kits for connection from fan to terminal
<b>Fire Stops</b>	A range of fire stopping products to prevent smoke or fire passing through duct systems
<b>Remote Switches, Controls &amp; Sensors</b>	A range of remote switches, controllers and sensors to control your Airflow fan
<b>Commercial Fan Speed Controllers</b>	A range of speed controllers to 100% control commercial/ industrial fans
<b>Acoustic Accessories</b>	A range of Acoustic accessories

# Accessories

## AirflexPro

Semi rigid ducting



### Key Features

- Zero leakage ensures highest performance
- 70% time saving on installation
- Interchangeable ducting system (75mm round / 51mm x 114mm oval) without any hydraulic pressure loss
- Compact, suits narrow joists and low ceiling voids
- Durable with high crushability (13 kN/m<sup>2</sup>)
- Smooth bore with antistatic and antibacterial lining
- Easy to clean when installed
- SAP Appendix Q eligible ducting (non-jointed)

### Mix and Match, "Oval or Round" = No loss of Performance

A quick and easy to fit system of semi-rigid ducting that can result in up to 70% time saving during the on-site installation process, compared to rigid or spiral duct methods.

This innovative system uses low resistance and antibacterial smooth round and oval tubes which connect each room to the heat recovery or ventilation unit via an air distribution box.

The AirflexPro Oval ducting is designed to equal the hydraulic Performance of Airflex Pro Round so both types can be used within the same system without a loss of performance.

Semi rigid ducting without joints. Performance data is now recognised by the U.K Government as an input for Standard Assessment Procedure (SAP) calculations via Appendix Q.

### AirflexPro Duct Pressure Loss (75mm Round / 51mm Oval)

Air Velocity M/s	Air Volume M <sup>3</sup> /h	Resistance Pa/Mtr
0.5	6	0
1	11	0.5
1.5	17	0.8
2	22	1.5
2.5	28	2.2
2.7	30	3
3	33	4
3.5	39	5
4	45	6

**AirflexPro Oval Ducting**

Part No.	Description
90000255	20m coil (oval)

Dimensions 51mm x 114mm

**AirflexPro Round Ducting**

Part No.	Description
9041130	50m coil (round)

Dimensions 75mm O/D

# Accessories

## AirflexPro Clips

Round and oval ducting clips



### Key Features

- Securely fixes both Airflex Pro Round and AirflexPro Oval Duct
- Compact height allows duct fixing within narrow joist areas and low ceiling voids
- To NHBC MVHR Guidance 3.2
- Single person installation
- Keeps Airflex Pro Round / Oval taut and neat on installation
- SAP Appendix Q eligible zero leakage ducting
- Keeps ducting off building fabric to reduce noise transmittal

### AirflexPro Round and Oval Ducting Clips

Flexible, innovative, meeting industry best practice standards for installation. AirflexPro Round and Oval clips are the only professional solution for fitting SAP Appendix Q eligible, AirflexPro Round and Airflex Oval Zero Leakage duct systems.

These compact ducting clips have been specifically designed to securely fix both AirflexPro Round and Oval Ducting systems. In narrow or confined areas, while keeping ducting off the building fabric to reduce noise transmission, they should be spaced at 750mm intervals to keep AirflexPro / Airflex Oval neat and tidy on installation in accordance with NHBC guidance 3.2.

### Dimensions (mm)

AirflexPro Round

AirflexPro Oval

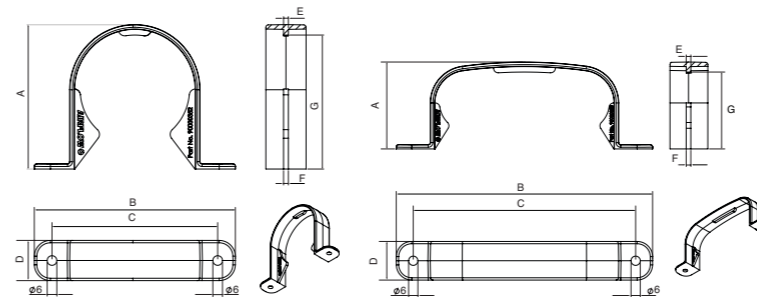

AirflexPro Round

AirflexPro Oval



Model	A	B	C	D	E	F	G
Airflex Pro Round	89.9	125	103	25	3	3	83.3
Airflex Pro Oval	56.3	166	144	25	3	3	49.8

Part No.	Product	Amount
90000352	AirflexPro Round Duct Clip	Sold in packs of 10
90000353	AirflexPro Oval Duct Clip	Sold in packs of 10

# Accessories

## Typical System 4 (MVHR)



Typical AirflexPro installation showing the transition between oval and round without increasing the system pressure



Distribution box with oval pipes going through the floor, input from the bottom

## Typical Components System 4

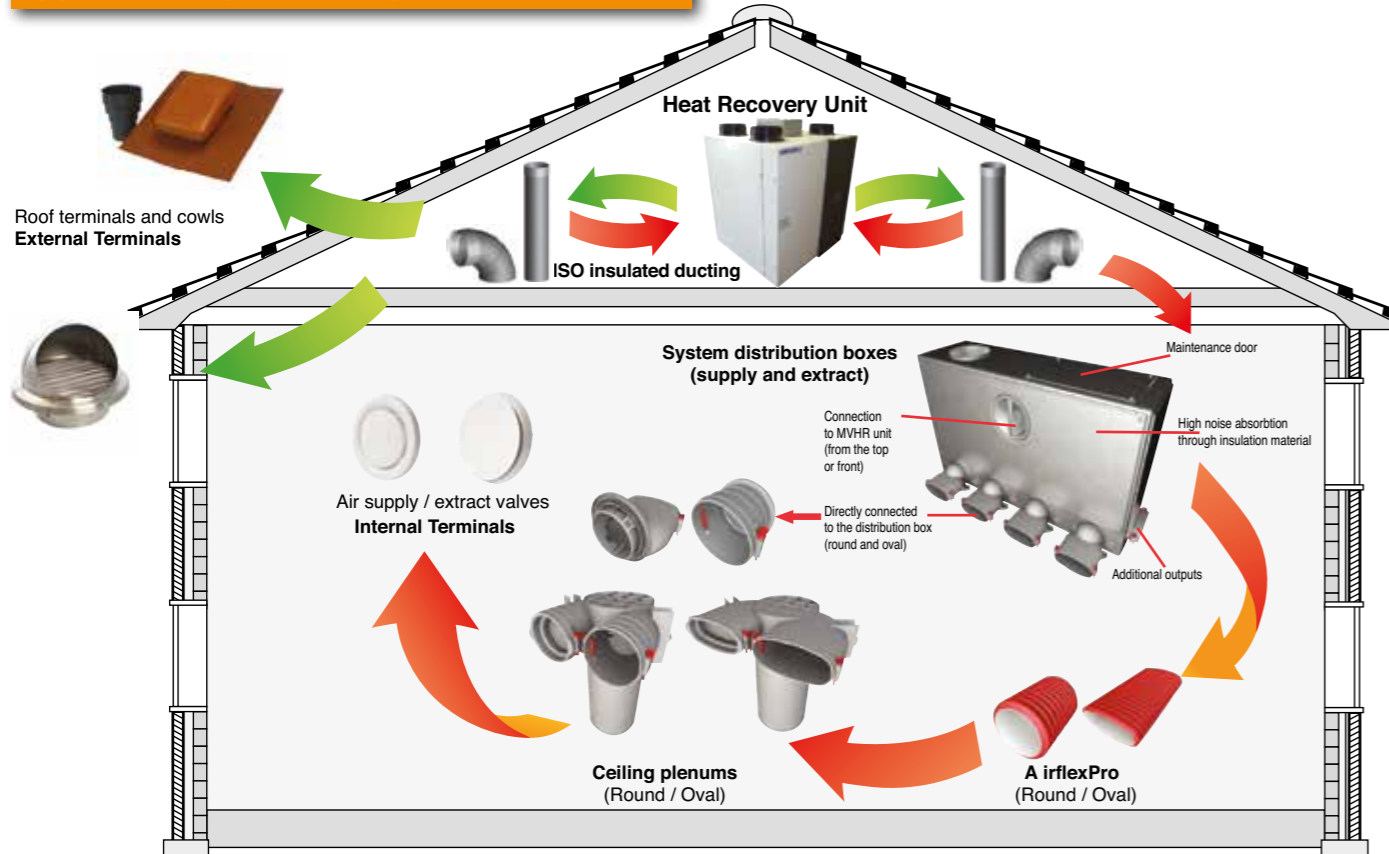

# Accessories

## AirflexPro Accessories

This range of AirflexPro accessories enable connection to the ventilating unit and also transformation from AirflexPro Round to val Duct to suit all ventilation applications.

### Hygienic Caps

Part No.	Dimensions
9041131	Hygienic cap for Airflex Pro round (pack of 10)



### Straight Connection

Part No.	Dimensions
9041132	Connects Airflex Pro round to Airflex Pro round



### 90° Compact Elbow

Part No.	Dimensions
9041139	75mm dia allows very small bend radius of duct



### Straight Ceiling Outlet

Part No.	Dimensions
9041141	2 spigots for 75mm piping and one spigot (125mm) for extract or supply valve

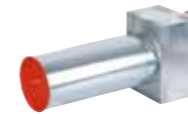

### 90° Floor Outlet

Part No.	Dimensions
9041142	2 spigots for 75mm piping and one spigot (140mm) for floor grille (9041174)



### 90° Wall Outlet

Part No.	Dimensions
9041144	2 spigots for 75mm piping and 200mm x 50mm opening for wall grille (9041175)

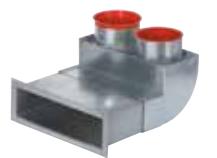

### Straight Wall Outlet

Part No.	Dimensions
9041143	2 spigots for 75mm piping and 200mm x 50mm opening for wall grille (9041175)

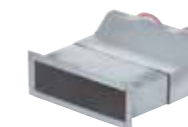

### Brushed Stainless Steel Floor Grille

Part No.	Dimensions
90000440	300 x 100mm Suitable for outlets 90000441 and 90000525



### 90° Floor Outlet – Round

Part No.	Dimensions
90000441	2 Spigots for 75mm piping suitable for stainless steel floor grille 90000440



### 90° Wall/Floor/Ceiling Outlet-Oval

Part No.	Dimensions
90000525	2 Spigots for 54 x 114mm Oval piping suitable for grilles 90000440/9000052 690000527/90000528 90000529/90000530 & 90000531



### White Powder Coated Grilles

Part No.	Dimensions
90000526	Slotted
90000527	Squared
90000528	Wavy All suitable for 90000525



Slotted

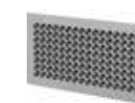

Squared



Wavy

### Brushed stainless steel grilles

Part No.	Dimensions
90000529	Slotted
90000530	Squared
90000531	Wavy All suitable for 90000525

# Accessories

## AirflexPro Accessories

- This range of AirflexPro accessories enable connection to the ventilating unit and also transformation from AirflexPro Round to Oval Duct to suit all ventilation applications.

### Sealing Rings Oval

Part No.	Dimensions
90000254	54 x 117mm dia Airflex Pro Oval Sealing Ring (pack of 10)



### Sealing Rings Round

Part No.	Dimensions
9041133	75mm dia. Airflex Pro Round Sealing Ring (pack of 10)



### Spare Holding Clips

Part No.	Dimensions
90000261	(pack of 10)

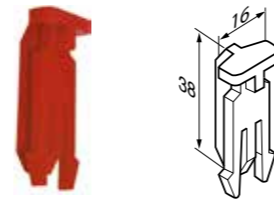

### Sealing Cap Round

Part No.	Dimensions
90000256	78mm Sealing Cap for Airflex Pro Round Ceiling / Wall Plenum

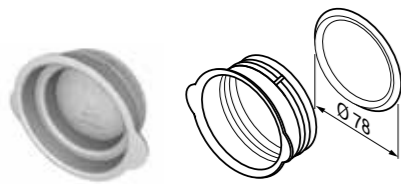

### Sealing Cap Oval

Part No.	Dimensions
90000257	54 x 117mm Sealing Cap for Airflex Pro Oval Ceiling / Wall Plenum

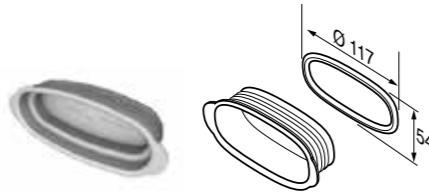

### Sealing Cap for Distribution Box

Part No.	Dimensions
90000267	125mm Inlet Seal for Distribution Boxes

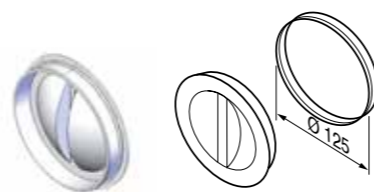

### Oval Spigot Connection

Part No.	Dimensions
90000259	Oval Spigots for Distribution Boxes

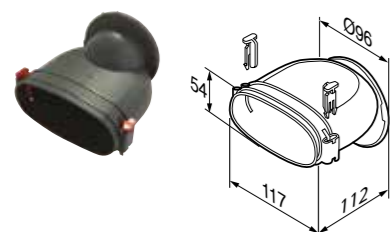

### Round Spigot Connection

Part No.	Dimensions
90000260	Round Spigots for Distribution Boxes

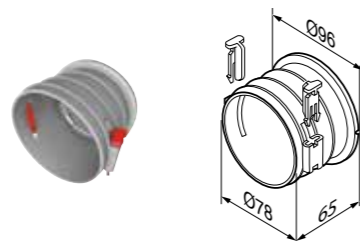

### Bayonet Cap - Distribution Box

Part No.	Dimensions
90000258	96mm Sealing Cap for Spigot Holes in Distribution Boxes

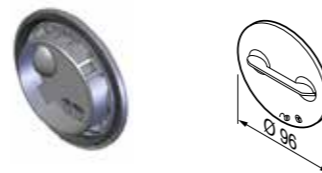

# Accessories

## AirflexPro Accessories

### Straight Connection Piece

Part No.	Dimensions
90000253	54 x 117mm Straight Connector (oval-oval)

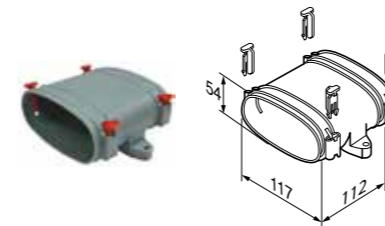

### 90° Vertical Transition Piece

Part No.	Dimensions
90000251	90° Vertical Transition Piece (round-oval)

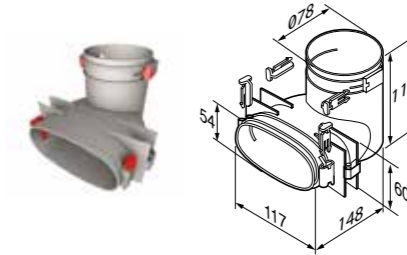

### Straight Transition Piece

Part No.	Dimensions
90000252	Straight Transition Piece (round-oval)

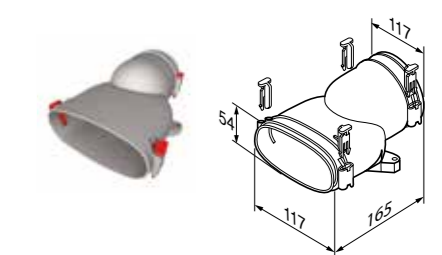

### 90° Vertical Elbow

Part No.	Dimensions
90000247	54 x 117mm vertical elbow (oval-oval)

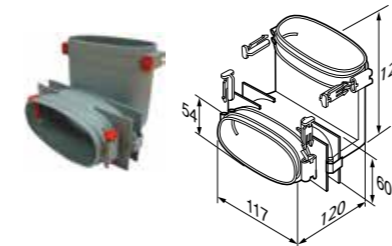

### 90° Horizontal Elbow

Part No.	Dimensions
90000248	54 x 117mm horizontal elbow (oval-oval)

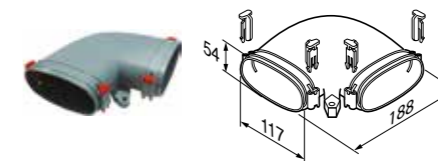

### AirflexPro Round

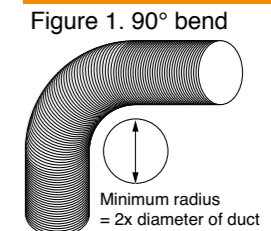

### AirflexPro Oval

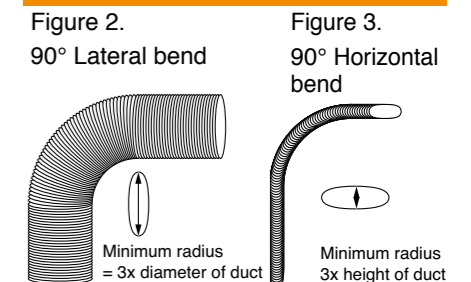

### Ceiling or Wall Plenum Oval

Part No.	Dimensions
90000249	54 x 117mm 90° Ceiling / Wall Plenum



### Ceiling or Wall Plenum Round

Part No.	Dimensions
90000250	78mm 90° Ceiling / Wall Plenum

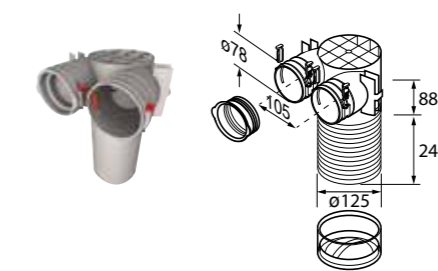

- Connects AirflexPro Round or Oval through the ceiling to the extract / supply valve. Can be cut down for varying height of void.

- AirflexPro Round and Oval semi rigid ducting performance data is recognised by the U.K Government as an input for the Standard Assessment Procedure (SAP) calculation via Appendix O, Fig 1-2 and 3 show how in this configuration without joints AirflexPro round and oval semi rigid ducting achieves the mechanical properties requirements set out in SAP Appendix Q. specifications.

# Accessories

## AirflexPro Distribution Boxes

- Provides primary distribution point for AirflexPro Round and Oval Ducting from the Heat Recovery / or Ventilation unit from 5 to 15 ports with various dimensions and discharge positions.

### 5-Port Distribution Box (oval)

Part No. Dimensions

90000262

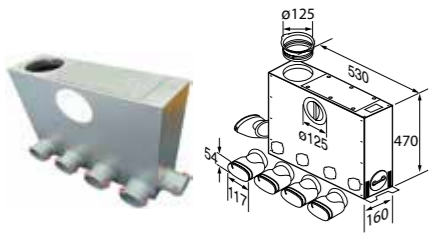

### 5-Port Distribution Box (round)

Part No. Dimensions

90000263

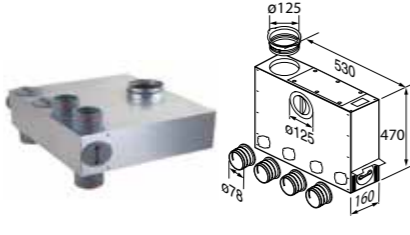

### 6-Port In-Line Distribution Box (round) Narrow

Part No. Dimensions

90000265

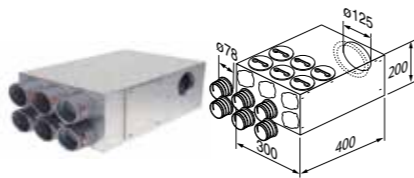

### 6-Port In-Line Distribution Box (round)

Part No. Dimensions

90000264

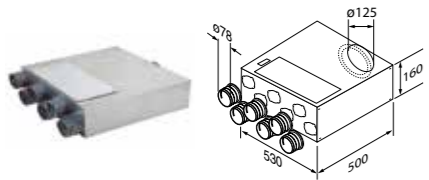

### 10-Port Distribution Box (oval)

Part No. Dimensions

90000270

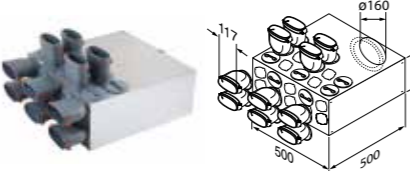

### 10-Port Distribution Box (round)

Part No. Dimensions

90000266

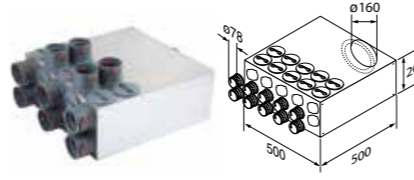

### 15-Port Distribution Box (round)

Part No. Dimensions

90000269

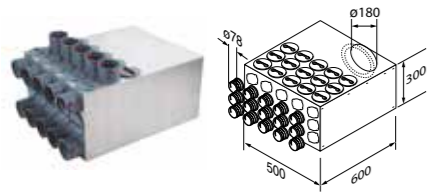

### Combi Distribution Box (L/H)

Part No. Dimensions

90000443

Enables supply and extract simultaneously connects to Airflex Pro round 75mm (up to 6 spigots) inlet 125mm handed inlet

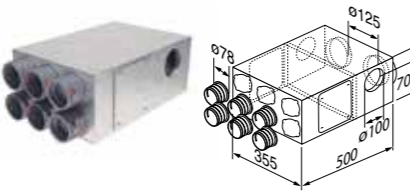

### Combi Distribution Box (R/H)

Part No. Dimensions

90000444

Enables supply and extract simultaneously connects to Airflex Pro round 75mm (up to 6 spigots) inlet 125mm handed inlet

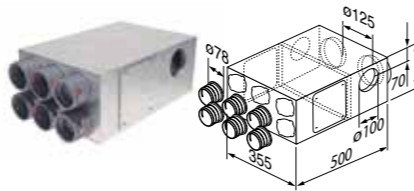

# Typical Installations

## Testimonials

“ As a contractor working throughout the UK installing residential HVAC equipment in new and refurbishment houses I have no hesitation in recommending AirflexPro for the ventilation ducting systems.

The quality of material is second to none and the flexibility of ducting made it possible to install very quickly even in narrow spaces. ”

**Director of Cotswold Efficient Energy Centre**

- Voted 2010 National Renewable Project of the Year H & V Awards
- Voted 2010 National Renewable Energy Company of the Year B.R.E. Award



“ I am very pleased with your semi-rigid ducting which I've begun using immediately. I am particularly impressed with its ability to quickly fit to each component, and also its leak-proof design thanks to the easy-to-fit sealing rings. The Airflex Pro ducting has already paid for itself in time saved! ”

**Design Architect at Persimmon Homes**

“ Specification of AirflexPro has added value and raised the standard of the ventilation system throughout the dwelling, while contributing to a lower carbon environment for the homeowner. ”

**Project Manager at Millgate Homes**



“ The installation went according to plan and the whole system is working very well... Thanks for your excellent service! ”

**Quantity Surveyor at Miller Homes**



# Accessories

## Airflex Retro

Discreet coving ducting



### Key Features

- Designed for both new build and renovation projects
- Easy installation in 3 steps
- 40% saving on installation time over conventional ducting systems
- COANDA effect supply valves enable a better range of circulating ventilation
- Imminently suitable for standard footprint building design
- Can be painted to suit inside décor of dwelling
- Negates the need for suspended ceiling to hide the ducting system
- Fire retardent to EU-B2 rating DIN 4102

## Retro Ducting System

This versatile and innovative ducting is designed around a coving system that can be incorporated within the visible part of the house or flat and is ideally suited to a standard footprint building design where there is a common entrance hallway with all the rooms branching off the hallway.

Retro ducting is lightweight, versatile and easy to fit making it the perfect choice for a discreet coving ducting application. This system can be used for System 4 (Mechanical Ventilation with Heat Recovery) in a supply and extract function and also System 3 (Mechanical Extract Ventilation) as an extract only duct system.

### Combination Distribution Box Supply Air Right

Part No.	Description
90000275	125 / 100 / 100mm dia



### Combination Distribution Box Supply Air Left

Part No.	Description
90000276	125 / 100 / 100mm dia



### Duct with Stucco Profile

Part No.	Description
90000277	1m length (box of 4)



### Long Connector Set

Part No.	Description
90000278	100mm (with clamp)



### T-Piece with Stucco Profile

Part No.	Description
90000279	100 / 100 / 100mm dia (box of 4)



### Short Connector

Part No.	Description
90000280	100mm dia



# Accessories

### Inner Angle with Stucco Profile

Part No.	Description
90000281	100 / 100mm dia (box of 2)



### Distribution Box Sealing Cap

Part No.	Description
90000282	100mm dia



### Outer Angle with Stucco Profile

Part No.	Description
90000283	100 / 100mm dia (box of 2)



### Wall Connecting Pipe

Part No.	Description
90000284	100mm dia PVC



### Coanda Valve for Supply

Part No.	Description
90000285	100mm dia



### Retro System Supply/Extract Valve

Part No.	Description
90000315	C/W filter (9000317) 100ø



### Retro System Supply/Extract Valve

Part No.	Description
90000439	C/W filter (9000317) 100ø



### Duct with Square Profile

Part No.	Description
90000445	1m length (box of 4)



### T Piece with Square Profile

Part No.	Description
90000446	100 / 100 / 100mm dia (box of 4)



### Inner Angle with Square Profile

Part No.	Description
90000447	100 / 100mm dia (box of 2)



### Outer Angle with Square Profile

Part No.	Description
90000448	100 / 100mm dia (box of 2)

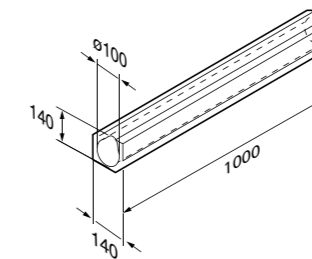

# Accessories

## How Retro Ducting Works (System 4 - MVHR)

1. Linked to an Airflow Duplexvent Domestic Heat Recovery unit that saves heat from indoors and transfers it to incoming fresh air providing an excellent indoor air quality.
2. Unique Retro Duct combination distribution box collects extracted "stale, moist" air from kitchen and bathroom whilst distributing fresh air to bedrooms and living rooms. It also absorbs some of the sound from different rooms that can be transmitted through the ventilation system.
3. Retro Ducting made from compressed EPS, looks part of the inside décor of the house as it carries the building ventilation air to and from its destination. The fixing clamps and circle system make installation a simple 3 step process.
4. Stylish 'COANDA' effect Retro air valves for supply and extract. The aerodynamic phenomenon known as the COANDA effect in conjunction with strategic placement of these air valves causes the supply air from the valve to 'stick' longer to the surface of the ceiling allowing it to be thrown further across the room before it drops at the same velocity that it would if the valve was in free air. This enables a better range of circulating ventilation in the supplied rooms ensuring a high level of good indoor air quality.
5. Supply / extract to Heat Recovery unit achieved through Airflow ISO - pre insulated piping (page 223).
6. Supply / extract to outside air.



- = Supply Air
- = Intake Air
- = Extracted Air
- = Exhaust Air

### How to Fit Retro Ducting



Step 1      Step 2      Step 3

# Accessories

## How Retro Ducting Works (System 3 - MEV)

1. Linked to an Airflow - Mechanical Extract Ventilation (MEV) unit that extracts from moisture producing or wet rooms allowing fresh air in via natural ventilation.
2. Retro Ducting made from compressed EPS, looks part of the inside décor of the house as it carries the building ventilation from its source. The fixing clamps and circle system make installation a simple 3 step process.
3. Extract valves combine a low profile stylish front for extraction of air from required areas. This enables a good range of circulating ventilation as extracted air is replaced through natural ventilation.
4. Natural ventilation replaces extracted stale / moist air through window sills, trickle vents and doors.
5. Extract to outside air.

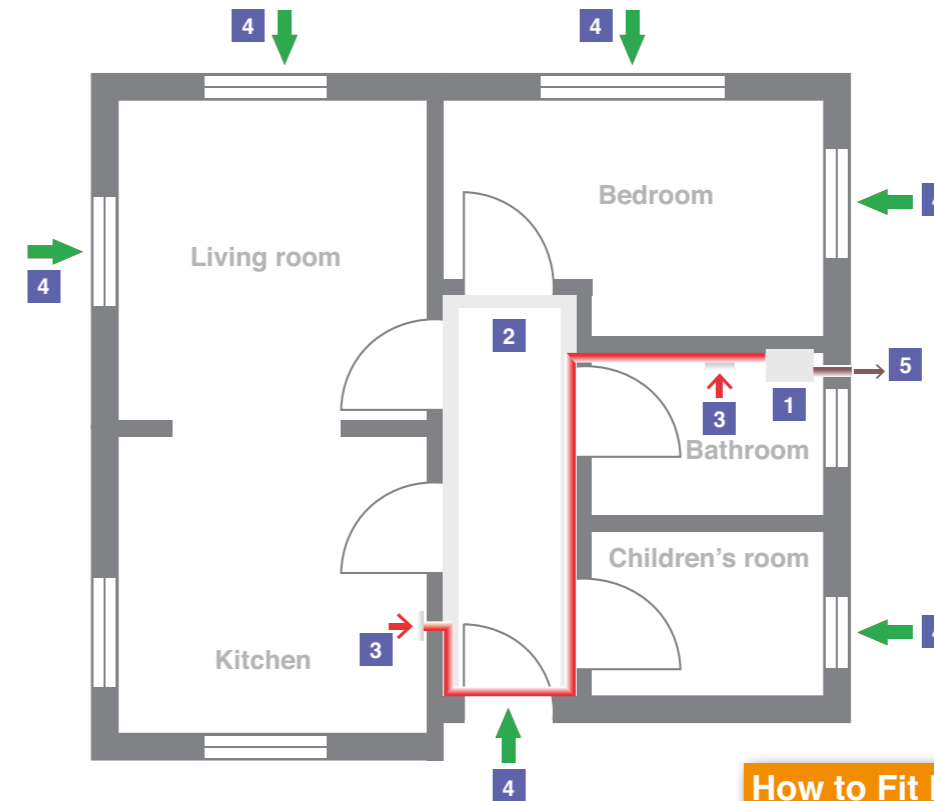

- = Extracted Air
- = Exhaust Air
- = Extracted Air
- = Natural Ventilation

### How to Fit Retro Ducting



Step 1      Step 2      Step 3

# Accessories

## Airflex Ducting

### Airflex Flexible Round PVC Hose

Part No.	Dimensions	Part No.	Dimensions
52641005	ø100mm x 1m	52641009	ø125mm x 3m
52641001	ø100mm x 3m	9041557	ø125mm x 6m
52641002	ø100mm x 6m	9041555	ø150mm x 1m
52641006	ø100mm x 15m	52641003	ø150mm x 3m
52641007	ø100mm x 45m	52641004	ø150mm x 6m
52641008	ø125mm x 1m		

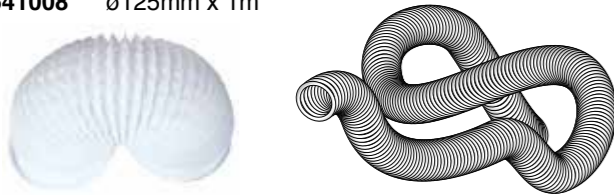

- Flexible PVC ducting for general ventilation connection applications. Highly versatile, non degrading, operating temp of +6° – +50° fire resistance tested to BS 476. To overcome awkward installation where rigid duct is unable to be installed. Can be used with fans for kitchens, bathrooms, toilets, cooker hoods etc. For optimum performance duct should be as straight and taut as possible to ensure "best practice" installation.

### Airflex Combi Flexible Ducting

Part No.	Dimensions	Part No.	Dimensions
9021285	ø100mm x 3m	9021287	ø152mm x 6m
9021292	ø100mm x 5m	9021290	ø152mm x 10m
9021289	ø100mm x 10m	9021295	ø200mm x 5m
9021286	ø152mm x 3m	9021288	ø200mm x 6m
9021294	ø152mm x 5m	9021291	ø200mm x 10m

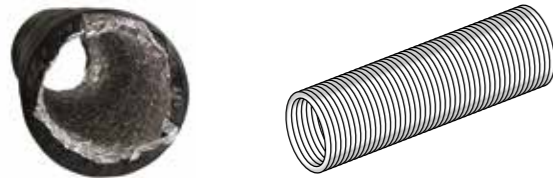

- PVC coated aluminium ducting for general ventilation connection applications, with a degree of outer protection. Highly versatile, non degrading fire resistance tested to BS 476. Operating temp +6° – +50° coated in PVC to add extra protection from corrosion and tear damage. Can be used with fans for kitchens, bathrooms, toilets, cooker hoods etc. For optimum performance duct should be as straight and taut as possible to ensure "best practice" installation.

- To use: Look across for your air volume, look up to the dimension of flexible ducting, look left for the resistance per meter.

### Airflex Flexible Ducting Resistance at Flowrate

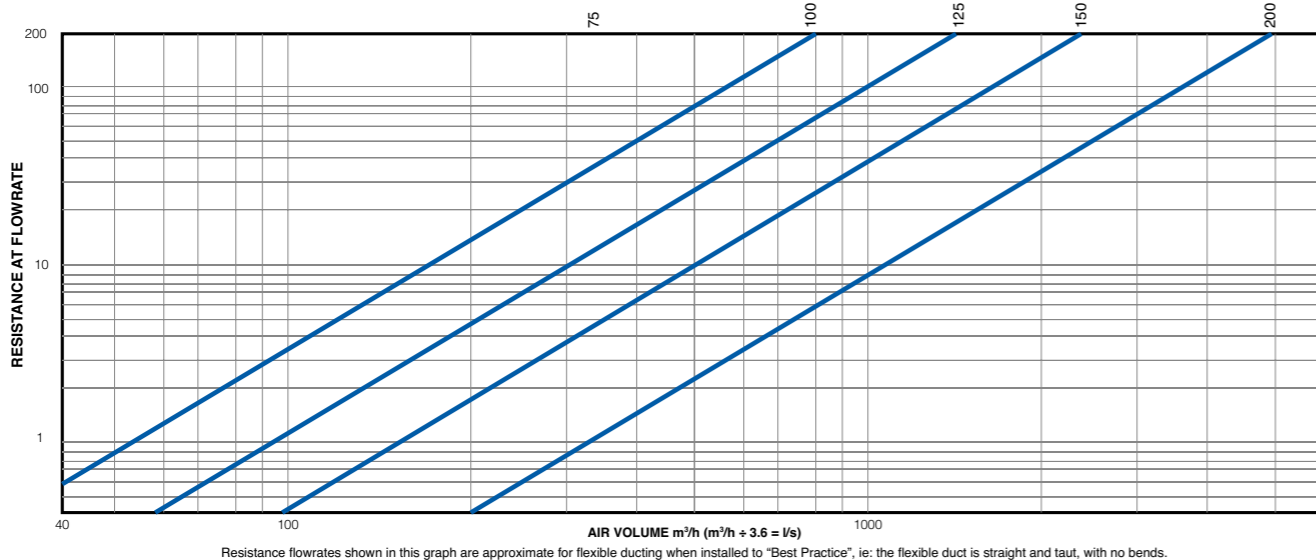

# Accessories

## Airflex Re-enforced Aluminium Flexible Ducting

Part No.	Dimensions
9021311	ø100mm x 3m
9021315	ø100mm x 5m
9021318	ø100mm x 10m
9021312	ø150mm x 3m
9021316	ø150mm x 5m
9021320	ø150mm x 10m
9021313	ø200mm x 3m
9021317	ø200mm x 5m
9021321	ø200mm x 10m
9021314	ø300mm x 5m

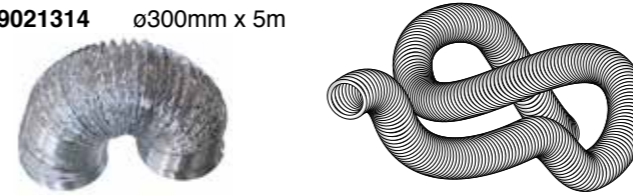

- Aluminium re-enforced ducting for general connection applications, with a good degree of outer protection. Highly versatile, non degrading, fire resistant tested to BS 476. Re-enforced with a tough wire spiral to maintain bore and reduce collapse. To overcome awkward situations where rigid duct cannot be installed. Can be used with fans for kitchens, bathrooms, toilets, cooker hoods and also Mechanical Extract Ventilation and Heat Recovery ventilation installations.

For optimum performance duct should be as straight and taut as possible to ensure "best practice" installation.

## Airflex Re-enforced Aluminium Insulated Flexible Ducting

Part No.	Dimensions
52662701	ø102mm x 10m
52662702	ø127mm x 10m
52662703	ø152mm x 10m
90000503	ø160mm x 10m
90000504	ø180mm x 10m

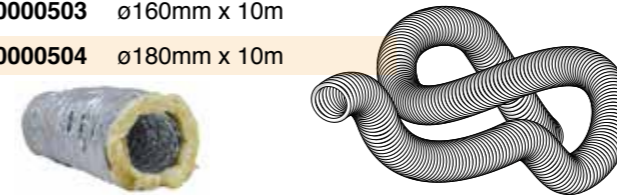

- Insulated and re-enforced aluminium ducting for general connection applications, where thermal conductivity and resistance are important. (outside the insulated envelope of a house for example). Duct can be used to connect fans in kitchens, bathrooms, toilets etc and also Mechanical Extract Ventilation and Heat Recovery Ventilation.

For optimum performance duct should be as straight and taut as possible to ensure "best practice" installation.

Airflex re-enforced aluminium insulated flexible ducting is made up with 25mm microfibre and has a thermal conductivity  $\lambda$  in W/m.K at 10°C of 0,036 which is less than 0.04W/(mK) which is the maximum allowed within the requirements of Domestic Ventilation Compliance Guide 2010, and is therefore compliant. It is suitable for temperatures of -30°C to +120°C and can be used up to a maximum 2000 Pa positive.

It has been tested to Fire rating BS 476 Part 6 Fire Propagation Test (passed) Part 7 Surface Spread of Flame (class I rating) Part 20 Fire Resistance (60 minutes).

## Best Practice Flexible Ducting Installation

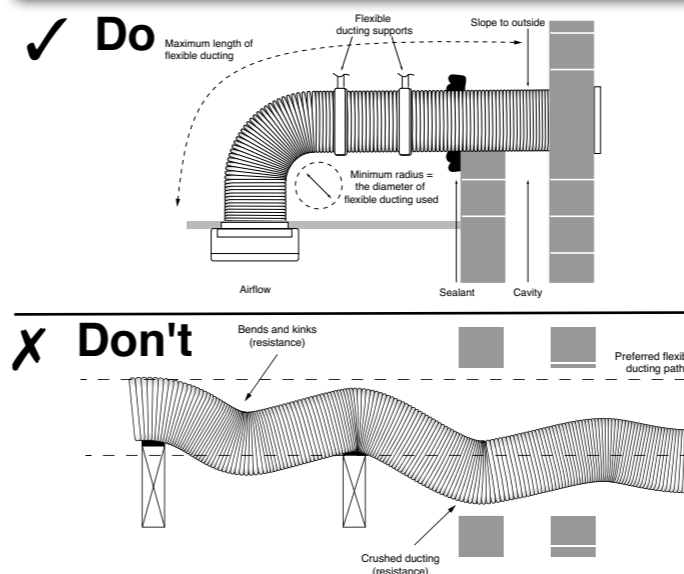



# Accessories

## Airflat Ducting 204mm x 60mm

- Thin, discreet white channel ducting system for use when space is an issue, or for use in the visible area of the house.

### Flat Channel Ducting

Part No.	Dimensions
52641201	204mm x 60mm x 1m
52641202	204mm x 60mm x 1.5m

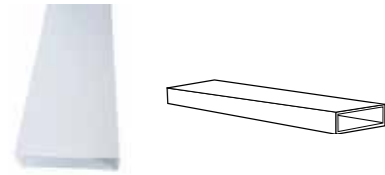

Resistance (Pa) at flow rate					
Part No.	10 l/s	20 l/s	30 l/s	40 l/s	60 l/s
52641201	<1	1.1	2.3	4.1	7.7
52641202	<1	1	1.5	3	5.2

### Elbow / Plenum

Part No.	Dimensions
52641301	204mm x 60mm x 100mm $\phi$
9041200	204mm x 60mm x 125mm $\phi$
52641302	204mm x 60mm x 150mm $\phi$



Resistance (Pa) at flow rate					
Part No.	10 l/s	20 l/s	30 l/s	40 l/s	60 l/s
52641301	3.5	15	29	66	117
9041200	3.4	12	24	64	110
52641302	3	11.4	20	41	65

### Horizontal Bend

Part No.	Dimensions
52641401	204mm x 60mm - 90°



Resistance (Pa) at flow rate					
Part No.	10 l/s	20 l/s	30 l/s	40 l/s	60 l/s
52641401	0.8	4	8.3	17	33

### Flexible Joining Piece

Part No.	Dimensions
52641501	204mm x 60mm x 600mm max

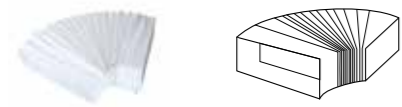

Resistance (Pa) at flow rate					
Part No.	10 l/s	20 l/s	30 l/s	40 l/s	60 l/s
52641501	0.3	1.4	2.5	5.8	11.2

### Vertical Bend

Part No.	Dimensions
52641601	204mm x 60mm - 90°



Resistance (Pa) at flow rate					
Part No.	10 l/s	20 l/s	30 l/s	40 l/s	60 l/s
52641601	1.2	5.1	9.7	22	44

### Horizontal Adapter (round / rectangle)

Part No.	Dimensions
51980001	204mm x 60mm x 125mm $\phi$

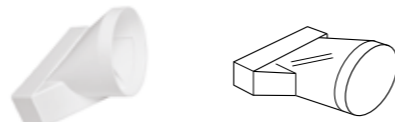

Resistance (Pa) at flow rate					
Part No.	10 l/s	20 l/s	30 l/s	40 l/s	60 l/s
51980001	<1	1.4	2.7	6.5	11.4

### Horizontal T

Part No.	Dimensions
52641801	204mm x 60mm



Resistance (Pa) at flow rate					
Part No.	10 l/s	20 l/s	30 l/s	40 l/s	60 l/s
52641801	vary on installation				

### Straight Connector

Part No.	Dimensions
52641701	204mm x 60mm



Resistance (Pa) at flow rate					
Part No.	10 l/s	20 l/s	30 l/s	40 l/s	60 l/s
52641701	<1	<1	<1	<1	1.3

### Flat Channel Clip

Part No.	Dimensions
52641901	204mm x 60mm

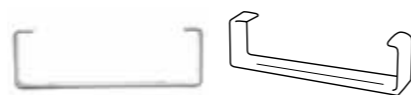

# Accessories

## Air Round Rigid Ducting

- White plastic round rigid ducting can be used as ducting as part of a larger system or as a component cut down. Where possible to ensure "best practice" and "installed performance" of the fan or ventilation unit it is advisable to use a rigid or semi rigid duct system to minimise bends and duct resistance. Fire tested to UL94 v2 / BS 476 these PVC rigid ducts are available in a versatile and wide range of sizes.

### Round Pipe

Part No.	Dimensions	Part no.	Dimensions
9021378	$\phi$ 100mm x 350mm	9041543	$\phi$ 125mm x 1.5m
90000048	$\phi$ 100mm x 1m	9041546	$\phi$ 125mm x 2m
90000051	$\phi$ 100mm x 2m	9001903	$\phi$ 150mm x 350mm
9041220	$\phi$ 125mm x 350mm	90000049	$\phi$ 150mm x 1m
9041547	$\phi$ 125mm x 1m	90000052	$\phi$ 150mm x 2m



Resistance (Pa) at flow rate					
Part No.	10 l/s	20 l/s	30 l/s	40 l/s	60 l/s
9021378	<1	<1	<1	<1	1.1
9000048	<1	<1	1.4	2.2	3.1
9000051	<1	1.6	2.8	4.4	6.2
9041220	<1	<1	<1	<1	<1
9041547	<1	<1	<1	<1	1.38
9041543	<1	<1	<1	1.7	2.76
9041546	<1	<1	1.2	2.3	3.6
9001903	<1	<1	<1	<1	<1
9000049	<1	<1	<1	<1	1.2
9000052	<1	<1	<1	1.1	2.4

### Equal T Piece

Part No.	Dimensions
9041461	100 x 100 x 100mm $\phi$ M
9041201	125 x 125 x 125mm $\phi$ M
9041545	150 x 150 x 150mm $\phi$ M



Resistance (Pa) at flow rate					
Part No.	10 l/s	20 l/s	30 l/s	40 l/s	60 l/s
9041201	vary on installation				
9041461	vary on installation				
9041545	vary on installation				

### 90° Round Elbow

Part No.	Dimensions
90000054	$\phi$ 100mm M
9041542	$\phi$ 125mm M
90000055	$\phi$ 150mm M



Resistance (Pa) at flow rate					
Part No.	10 l/s	20 l/s	30 l/s	40 l/s	60 l/s
90000054	2.9	5.4	21	43	78
9041542	<1	4	7.9	16	34
90000055	<1	2.1	4	9.4	17

### Grey Acrylic Duct Sealant

Part No.	Dimensions
90000356	380ml Grey acrylic duct sealant - non hardening.



### Y Piece

Part No.	Dimensions
9041556	$\phi$ 125mm M

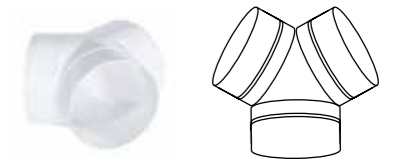

### 45° Bend

Part No.	Dimensions
9041544	$\phi$ 125mm M



Resistance (Pa) at flow rate					
Part No.	10 l/s	20 l/s	30 l/s	40 l/s	60 l/s
9041544	<1	1.7	2.8	6.5	12

M = Male connection

# Accessories

## Air Round Rigid Ducting

- Plastic rigid ducting connections enables design of complex duct systems or for use as components in larger systems

### Straight Reducer

Part No.	Dimensions
51979601	ø125mm to 100mm M
90000060	ø150mm to 125mm M
90000061	ø200mm to 150mm M

### Offset Reducer

Part No.	Dimensions
52644101	ø125mm to 100mm M (fits inside pipe 125mm - male and accepts an offset 100mm pipe - female)

### Round Pipe Connector

Part No.	Dimensions
90000019	ø100mm M
52644001	ø125mm M
90000058	ø150mm M
90000059	ø200mm M

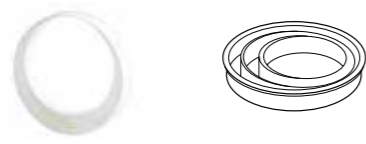

M = Male connection

## Duct Insulation

- Insulation wrap provides insulation for all Airflow's duct systems where a degree of thermal conductivity / resistance is an issue (outside the thermal envelope of the house for example).

Airflow duct insulation wrap has been Fire Tested in accordance with BS 476, part 6, 7 and 20. Its thermal conductivity is 0.005 W/mK for 4mm thickness and therefore complies to the requirements of Domestic Ventilation Compliance Guide 2010.

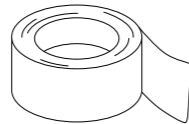

### Tape

Part No.	Dimensions
90000016	50m tape

Adhesive aluminium tape for the fitting and installation of aluminium insulation wrap. Non hardening adhesive.

### Insulation Wrap

Part No.	Dimensions
90000010	Round/oval Airflex Pro - 295mm x 25m
90000011	100mm Airound - 345mm x 12.5m
90000012	125mm Airound - 422mm x 12.5m
90000013	150mm Airound - 503mm x 12.5m
90000014	204mm x 60mm Airflat - 531mm x 12.5m



# Accessories

## Airflex ISO - Insulated Rigid Ducting

- ISO pipe ducting, pre-insulated.
- Tough, durable, anti-static EPP construction.
- Fire retardant to EU-B2 - DIN 4102.
- Choice of components to suit any layout.
- Typically connects to MVHR units and distribution boxes and to outside for venting.
- Pre insulated duct for when the ventilation unit is outside the warm envelope of the house. This helps to reduce condensation.

### Airflex ISO Pipe

Part No.	Dimensions
9041147	ø125mm x 2000mm
90000505	ø160mm x 950 mm
90000465	ø160mm x 2000mm
9041250	ø180mm x 1000mm
90000475	ø180mm x 2000mm



## Airflex ISO Bends and connectors

### 90° Elbow

Part No.	Dimensions
9041152	ø125mm 90° ISO bend with collar
90000467	ø160mm 90° ISO bend with male/male connector
90000477	ø180mm 90° ISO bend with male/male connector



### 45° Elbow

Part No.	Dimensions
9041154	ø125mm 45° ISO bend with collar
90000466	ø160mm 45° ISO bend with male/male connector
90000476	ø180mm 45° ISO bend with male/male connector



### ISO Connector

Part No.	Dimensions
9041149	ø125mm ISO pipe female /female Connector (plastic)
90000468	ø160mm ISO pipe male / male Connector (plastic)
90000478	ø180mm ISO pipe male / male connector (plastic)

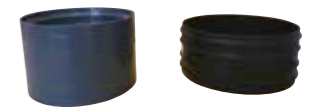

## Airflex ISO Connections

### ISO Reducing Connector

Part No.	Dimensions
90000470	ø160mm ISO Pipe male with seal to ø125mm
90000471	ø160mm ISO Pipe male with seal to ø180mm
90000480	ø180mm to 160mm pipe male / male with seals
90000497	ø200mm female to ø160mm male with seal
90000500	ø200mm female to ø180mm male with seal



### ISO Coupling

Part No.	Dimensions
9041191	ø125mm male / male coupling with seals
90000469	ø160mm male / male coupling with seals
9041232	ø200mm male / male coupling with seals



# Accessories

## Square External Grilles

- Plastic external grilles in a spread of colours and sizes. Various colours and various sizes. F/S denotes it comes with a flyscreen.
- These grilles comply with the requirements of the Domestic Ventilation Compliance guide 2010 that states terminal opening is a minimum of 90% of the free area of the ducting being used.

Brown		White		Grey	
Part No.	Dimensions	Part No.	Dimensions	Part No.	Dimensions
52641104	140 x140 x ø100mm	52641101	140 x140 x ø100mm	52641102	140 x140 x ø100mm
9021012	140 x140 x ø100mm - F/S	9021172	150 x150 x ø100mm - F/S	52641107	180 x180 x ø150mm
9041222	160 x160 x ø125mm	9041221	160 x160 x ø125mm		
52641109	180 x180 x ø150mm	52641106	180 x180 x ø150mm		

Terracotta		Beige		Gravity Flap - White	
Part No.	Dimensions	Part No.	Dimensions	Part No.	Dimensions
52641103	140 x140 x ø100mm	52641105	140 x140 x ø100mm	51791101	140 x140 x ø100mm
9021082	140 x140 x ø100mm - F/S	52641110	180 x180 x ø150mm	9041468	160 x160 x ø125mm
9041223	160 x160 x ø125mm			71984001	180 x180 x ø150mm
52641108	180 x180 x ø150mm				

## iCON Round External Grilles

- For use ideally with our range of iCON fans, multiple sizes and colours available.
- For Use With Round Rigid Duct Only.
- These grilles comply with the requirements of the Domestic Ventilation Compliance guide 2010 that states terminal opening is a minimum of 90% of the free area of the ducting being used.

Terracotta		White	
Part No.	Dimensions	Part No.	Dimensions
72596201	ø100mm A = ø180mm	72596202	ø100mm A = ø180mm
72593101	ø150mm B = ø240mm	72593102	ø150mm B = ø240mm

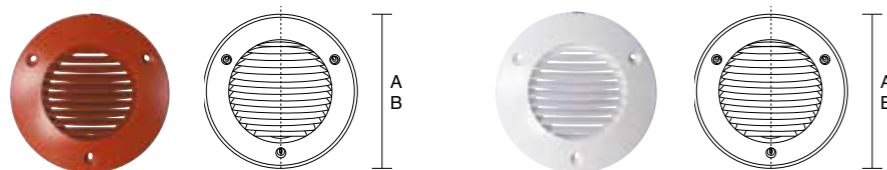

# Accessories

## Airbricks

- Airbricks fit in neatly in a standard brick size for discreet supply or extract applications where a standard grill may not be suitable.
- These Airbrick grilles comply with the requirements of the Domestic Ventilation Compliance guide 2010 that states terminal opening is a minimum of 90% of the free area of the ducting being used.

Terracotta		Beige		Brown	
Part No.	Dimensions	Part No.	Dimensions	Part No.	Dimensions
52642010	204mm x 60mm	52642002	204mm x 60mm	51849605	204mm x 60mm

## With Internal Damper - Terracotta

Part No.	Dimensions
51978702	204mm x 60mm

## With Internal Damper - White

Part No.	Dimensions
51978701	204mm x 60mm

## Double Airbrick - C/W Adaptor

Part No.	Dimensions
90000077	204mm x 120mm Terracotta
90000076	204mm x 120mm White
90000132	204mm x 120mm Stone

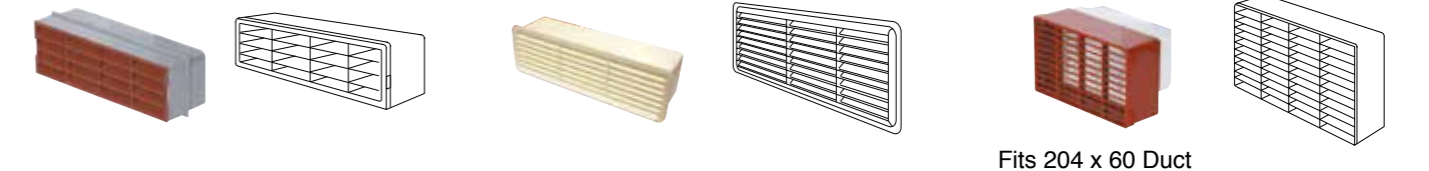

Fits 204 x 60 Duct

## Stainless Steel External Grilles

- Outside stainless steel grilles for greater weather protection suitable where a greater aesthetic appeal is necessary
- These grilles comply with the requirements of the Domestic Ventilation Compliance guide 2010 that states terminal opening is a minimum of 90% of the free area of the ducting being used.

## Round Cowl with Louvers

Part No.	Dimensions
52644501	ø100mm
9041226	ø125mm
52644601	ø150mm
9041227	ø180mm

## Round Cowl with Mesh

Part No.	Dimensions
52644701	ø100mm
9041228	ø125mm
52644801	ø150mm
90000506	ø160mm
9041229	ø180mm

## Cowl with Gravity Flap

Part No.	Dimensions
9041230	ø125mm
9041231	ø150mm



# Accessories

## Regal Cowls

### Regal Side Entry Cowl

Part No.	Dimensions
90000449	To suit ø125mm ISO duct
90000498	To suit ø160mm ISO duct
90000501	To suit ø180mm ISO duct



### Regal Front Entry Cowl

Part No.	Dimensions
90000450	To suit ø125mm ISO duct
90000499	To suit ø160mm ISO duct
90000502	To suit ø180mm ISO duct



## External Wall Grilles (Dual)

### External Wall Grilles

Part No.	Dimensions
9041164	ø160mm Dual external grille - white for pipe connection 160mm for exhaust and fresh air - fresh air connection L/H side.



### External Wall Grilles

Part No.	Dimensions
9041165	ø160mm Dual external grille - white for pipe connection 160mm for exhaust and fresh air - fresh air connection R/H side.



# Accessories

## Acoustic Accessories

### Acoustic Humidity Air Vent

Part No.	Dimensions
9041306	425mm x 45mm x 64mm



### Acoustic Wall Vent

Part No.	Dimensions
9041323	SC130 R 30m <sup>3</sup> /h



### Acoustic Wall Vent

Part No.	Dimensions
9041324	SC125 R 22m <sup>3</sup> /h

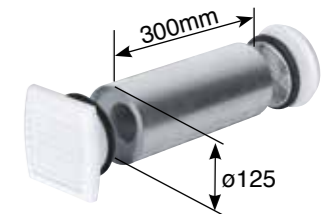

### Circular Attenuators

Part No.	Dimensions
90000115	125mm x 600mm
9541176	125mm x 900mm
9541177	125mm x 1250mm

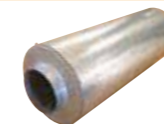

Part No.	Attenuation in dB at Hz				
	250	500	1000	2000	4000
90000115	12	20	31	33	21
9541176	14	26	44	46	35
9541177	16	33	47	53	46

## Airflow Air Valves Extract (E) & Supply (S)

A range of plastic and metal supply and extract air valves. Multiple sizes for all ventilation applications.

### Plastic Adjustable Air Valve (S)

Part No.	Dimensions
90000339	ø125mm Directional supply

Direct the airflow from this valve to the area of your choice in the room



### Metal Adjustable Air Valve (S)

Part No.	Dimensions
9041168	ø125mm

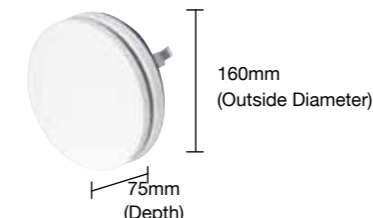

### Plastic Adjustable Air Valve (E)

Part No.	Dimensions
9020152	ø100mm (A-140 x B-60mm)
90000340	ø125mm (A-165 x B-65mm)
9020153	ø150mm (A-185 x B-55mm)
9020154	ø200mm (A-245 x B-80mm)

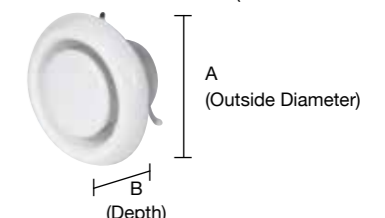

### Metal Adjustable Air Valve (E)

Part No.	Dimensions
9041172	ø125mm



### Fire protection extract valve

Part No.	Dimensions
90000126	ø125mm

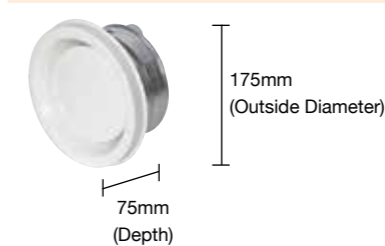

Fusible link release closes the valve when temperature reaches 72°C sealing the duct from fire and smoke ingress. Fusible link release sits inside duct behind the valve approx 35mm.

# Accessories

## Speciality Air Valves

- A range of special air valves designed for when a greater degree of aesthetics is required.

### Coanda Supply Air Valve - White

Part No.	Dimensions
9041166	ø125mm



COANDA effect valve for supply enables a better range of circulating ventilation ensuring a high level of indoor air quality. Can be used for extract without coanda effect.

### Aluminium Wall Grille

Part No.	Dimensions
9041175	Grille for wall mounting from aluminium 200 x 50mm (inner), 250 x 110mm (outer) Air volume adjustable via horizontal and vertical fins fits with straight wall outlet (9041143) and 90° Wall outlet (9041144) also fits to 204mm x 60mm ducting



### Stylish Supply/Extract Valve

Part No.	Dimensions
90000315	100mm ø c/w internal filter
90000316	125mm ø c/w internal filter
90000317	100mm filter
90000318	125mm filter



### Supply Air Valve - White

Part No.	Dimensions
9041169	ø125mm wall/ceiling



### Extract Air Valve - White

Part No.	Dimensions
9041173	ø125mm wall/ceiling



### Floor Grille - Satin S/steel

Part No.	Dimensions
9041174	Floor grille from satin stainless steel air volume adjustable via setting disc fits with floor outlet (9041142)



### Stylish Supply/Extract Valve

Part No.	Dimensions
90000439	100mm ø c/w internal filter
90000317	100mm filter



# Accessories

## Airflow Airese Adjustable Air Valves

- Airese air valves are designed to provide a complete demand controlled ventilation solution. The valves automatically respond to conditions within specific rooms such as kitchens and bathrooms and then operate accordingly to meet the ventilation required for that type of room.
  - Models include constant flow, pull cord activator, humidity activation, boost-electric, boost battery and humidity with timer.
- Intelligent self adjustable valves for the complete demand control solution specifically for use with MVHR and other ducted ventilation systems.

### White

Part No.	Dimensions
9041234	15m³/hr Constant air flow
9041235	30m³/hr Constant air flow
9041236	15m³/hr Constant air flow, Pull Cord Boost to 30m³/hr
9041237	20m³/hr Constant air flow, Pull Cord Boost to 75m³/hr
9041238	5m³/hr Constant air flow, Humidity Boost to 45m³/hr
9041239	10m³/hr Constant air flow, Humidity Boost to 45m³/hr
9041240	12m³/hr/ 45m³/hr/ 105m³/hr Air flow Boost Humidity Electric with Timer
9041241	5m³/hr/ 40m³/hr/ 100m³/hr Air flow Boost Humidity Electric with 125mm Connector
9041242	6m³/hr/ 40m³/hr/ 90m³/hr Air flow Boost Humidity Pull Cord
9041243	5m³/hr Air flow Boost Electric to 30m³/hr
9041244	5m³/hr Air flow Boost PIR Batt to 30m³/hr

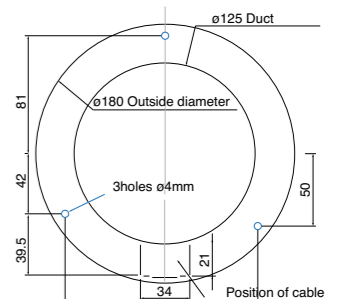

## Airflow Airese Adjustable Air Valve Accessories

### White

Part No.	Dimensions
9041246	ø125mm Straight connector
9041247	ø150mm Straight connector
9041248	ø125mm Straight ceiling connector



### White

Part No.	Dimensions
9041245	ø125mm Reducer to 100mm



# Accessories

## Metal Worm Drive Clips

### 8mm Wide

Part No.	Dimensions
51849402	ø100mm/ 4" adjustable 50mm - 110mm
51849403	ø125mm/ 5" adjustable 60mm - 165mm
51849404	ø150mm/ 6" adjustable 60mm - 325mm



## Backdraught Flap

- Backdraught flaps to reduce the ingress of air from the outside and reduce wind and outside noise disturbance.

### Backdraught Flap

Part no.	Dimensions
51990601	ø100mm
52365001	ø150mm

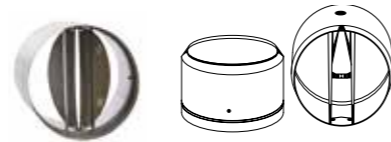

## Roof Cowls, Slates and Traps

- A selection of roof terminal solutions allowing supply or extract through the roof of a dwelling. Both universal for multiple sizes and size specific products are available for pitched and flat roof applications.

### Grey Roof Cowl

Part No.	Dimensions
9004554	Roof cowl A.B.S ø100mm

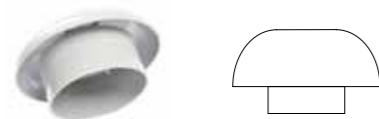

### Roof Slate

Part No.	Dimensions
9004597	450mm Pitched roof
9004598	600mm Pitched roof

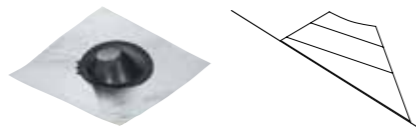

### Condensation Trap

Part No.	Dimensions
51978301	ø100mm
52364801	ø150mm



### Universal Roof Terminal & Adaptor

Part No.	Dimensions
90000349	ø100mm / 110 / 125 / 150 / 160mm - Anthracite

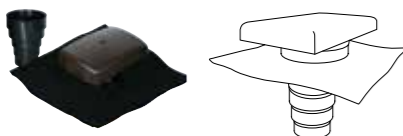

### Universal Roof Terminal & Adaptor

Part No.	Dimensions
90000351	ø100mm / 110 / 125 / 150 / 160mm - Sepia

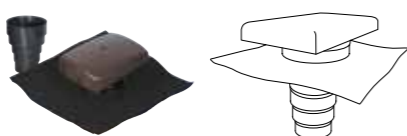

### Universal Roof Terminal & Adaptor

Part No.	Dimensions
90000350	ø100 / 110 / 125 / 150 / 160mm - Terracotta

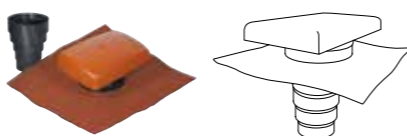

Duct size (mm)	Vent free area (mm²)	Pressure / Airflow Resistance Readings (Pa) (vent system pressure)			
		100m³/h	200m³/h	400m³/h	400m³/h
100	7,850	3.0	12.0	48.0	192.0
110	8,850	4.5	18.0	72.0	288.0
125	12,250	5.3	21.2	84.8	339.2
150	17,775	6.5	26	104	416
160	18,750	6.5	26	104	416

Duct size (mm)	Vent free area (mm²)	Pressure / Airflow Resistance Readings (Pa) (vent system pressure)			
		100m³/h	200m³/h	400m³/h	400m³/h
100	7,850	3.0	12.0	48.0	192.0
110	8,850	4.5	18.0	72.0	288.0
125	12,250	5.3	21.2	84.8	339.2
150	17,775	6.5	26	104	416
160	18,750	6.5	26	104	416

Duct size (mm)	Vent free area (mm²)	Pressure / Airflow Resistance Readings (Pa) (vent system pressure)			
		100m³/h	200m³/h	400m³/h	400m³/h
100	7,850	3.0	12.0	48.0	192.0
110	8,850	4.5	18.0	72.0	288.0
125	12,250	5.3	21.2	84.8	339.2
150	17,775	6.5	26	104	416
160	18,750	6.5	26	104	416

# Accessories

## Venting Kits

- A range of connecting ducts and grilles to connect your Airflow fan to the outside, already with a grill provided. Various sizes and colours available. Will also connect to new Airflow fans, check the diameter required.
- These venting kit grilles comply with the requirements of the Domestic Ventilation Compliance Guide 2010 that states terminal opening is a minimum of 90% of the free area of the ducting being used.

### Cavity Wall Kit - Terracotta

Part No.	Dimensions
72643201	ø100mm x 350 Rigid duct
72643203	ø150mm x 350 Rigid duct



### Cavity Wall Kit - White

Part No.	Dimensions
72643202	ø100mm x 350 Rigid duct
72643204	ø150mm x 350 Rigid duct



### High Rise Cavity Wall Kit - Cowl / Rubber Seal

Part No.	Dimensions
9021451	ø100mm Rigid duct



### Flexible Wall Kit - Terracotta

Part No.	Dimensions
72643601	ø100mm 3m Ducting
90000437	ø125mm 3m Ducting
72643603	ø150mm 3m Ducting



### Flexible Wall Kit - White

Part No.	Dimensions
72643602	ø100mm 3m Ducting
90000438	ø125mm 3m Ducting
72643604	ø150mm 3m Ducting



- This high rise cavity wall kit enables installation via insertion from the inside of the dwelling, so no access to the outside of the property is required.

### In-Line Flexible Ducting Kit

Part No.	Dimensions
9041183	ø100mm x 6m



### In-Line Flexible Ducting Kit

Part No.	Dimensions
9041184	ø125mm x 6m



### In-Line Flexible Ducting Kit

Part No.	Dimensions
9041185	ø150mm x 6m



- For use with Aventa 100 and Aventa 100T. Comes with exhaust valve, duct, outside gravity flap and fitting circlips
- For use with Aventa 125 and Aventa 125T. Comes with exhaust valve, duct, outside gravity flap and fitting circlips
- For use with Aventa 150 and Aventa 150T. Comes with exhaust valve, duct, outside gravity flap and fitting circlips

# Accessories

## Intumescent Fire Collars

Round		Rectangular	
Part No.	Dimensions	Part No.	Dimensions
90000108	75 - 82mm dia	90000107	205mm x 60mm
90000109	100 - 110mm dia		
90000110	125 - 130mm dia		
90000111	150 - 160mm dia		



**Fire Collar** - prevents spread of fire, smoke and hot gasses where fire compartment wall / floor is penetrated by plastic pipes.

- Contain intumescent material which reacts under the influence of heat on the duct pipe to form an insulation plug preventing smoke and fire passing through to the adjoining rooms. Suitable for any type of building where a fire compartment wall or floor is penetrated by plastic duct pipes. Fixed by mounting lugs these collars can be used without the need for encapsulation in walls or brickwork.

## Flame Stopper Safety Sleeve

Safety Sleeve	
Part No.	Dimensions
9041311	80mm dia
52662301	125mm dia
52662401	150mm dia



**Flame Stopper Safety Sleeve** - fits onto fans or air valves to prevent spread of fire in HVAC systems.

- The safety sleeve is constructed from intumescent material. This reacts under the influence of heat and forms an insulation plug preventing smoke or fire passing through the adjoining rooms. These sleeves need to be encapsulated in walls or brickwork to be able to operate correctly.

## Remote Switches, Controllers & Sensors

Air Quality Sensor	
Part No.	Dimensions
9041575	W125 x H75mm x D30mm



**Air Quality Sensor**  
Single phase AC current -max 1.0 amp

- Air quality sensor suitable for domestic and commercial ventilation systems. This will switch fans on if condensation rates rise quickly or the set valve exceeded. An adjustable timer over run is engaged after the condensation rates are below sensor settings.
- The integrated sensor reacts to oxidizable gases and pollutants such as: carbon monoxide, alcohol, formaldehydes, benzene, solvent, methane, tobacco etc

# Accessories

**Isolation switch**

**Part No.**  
90000537 Single Ph-two pole



**Isolation switch with neon**

**Part No.**  
90000538 Single Ph-two pole



**Isolation switch with neon and fuse**

**Part No.**  
90000539 Single Ph-two pole



**On/off switch**

**Part No.**  
90000540 Single pole



**Low and High speed and off switch**

**Part No.**  
90000541 Three pole



**Momentary boost switch**

**Part No.**  
90000542 Single pole



**On/off switch with neon**

**Part No.**  
90000543 Single pole



**Two position switch**

**Part No.**  
90000544 Single pole



**Two position switch with neon for second speed**

**Part No.**  
90000545 Single pole



**Supervent SV6 switch**

**Part No.**  
90000546 Double and single pole



**Supervent SV6 switch with neon**

**Part No.**  
90000548 Double and single pole

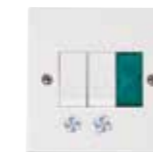

**On/off with lockable isolator switches**

**Part No.**  
90000547 Double and tripple pole



**Three position with neon speed indicator switch**

**Part No.**  
90000549 Three position



**On/off lockable and neon switch**

**Part No.**  
90000550 Single and tripple pole



**On/off - 2 speed with 2x neon switch**

**Part No.**  
90000551 Single and double pole



# Accessories

## Variable Speed Fan Controller

**Part No.**  
**9041033** Maxivent / Supervent  
 iCON 60



## 1 Amp Reversible Speed Controller

**Part No.**  
**9041566** Reversible fans



## 1 Amp Stepless Speed controller

**Part No.**  
**9041565** Single phase fans



## 3 Amp Stepless Speed Controller

**Part No.**  
**9041569** Single phase fans



## QuietAir 150 VS controller

**Part No.**  
**90000514** QTI50VS



## PIR Motion Sensor Timer

**Part No.**  
**51969702** c/w timer 3 - 30 mins



## Electrical Humidistat On / Off

**Part No.**  
**9041570** Humidistat 30% - 90%



## Single gang back box

**Part No.**  
**90000552** 35mm deep



## Double gang back box

**Part No.**  
**90000553** 35mm deep



## Commercial Fan Speed Controllers

### Speed Controller 1 AMP

**Part No.**  
**9021055** 100% speed controller for  
 linear control of fans



### Speed Controller 3 AMP

**Part No.**  
**9021056** 100% speed controller for  
 linear control of fans



### Speed Controller 6 AMP

**Part No.**  
**9021057** 100% speed controller for  
 linear control of fans



### Speed Controller 10 AMP

**Part No.**  
**9021058** 100% speed controller for  
 linear control of fans



- New high voltage protection adjustment on 3-Amp and 6-Amp controllers.
- Low voltage "No Stall" adjustment on 3-Amp and 6-Amp controllers.

# Accessories

## Switch Selection Chart

MODELS												
Switch No	iCONstant	QuietAir	iCON	LOOVENT eco	LOOVENT eco SELV	LOOVENT Classic	Aura eco	Aura Fan/ Shower Kit	Aura In-Line	Aventa In-Line	Aventa Turbo	Aventa Silent
90000540	ALL	ALL	ALL	ALL	ALL	ALL	ALL (except MST)	ALL	ALL	ALL	ALL	ALL
90000547	-	-	ALL	-	-	-	-	-	-	-	-	-
90000550	-	-	ALL	-	-	-	-	-	-	-	-	-
90000543	-	QT100B QT120B QT150B	ALL	LVECOD LVECOMST LVECOT	ALL	ALL	ALL (except MST)	ALL	ALL	ALL	ALL	ALL
90000541	-	QT100B QT120B QT150B	-	-	-	-	-	-	-	AV150 AV125 AV100	-	-
90000549	-	-	-	-	-	-	-	-	-	AV150 AV125 AV100	-	-
90000458	-	QT150VS	-	-	-	-	-	-	-	-	-	-
Switch Selection				DUPLEXVENT				Industrial Fans				
	Maxivent	Supervent	Roomvent	Airovent	Basic	Professional	Interactive	(Single Phase Models)				
90000540	MV150HP MV150T	SV6/SV6T	ALL	-	ALL	DV50, DV80, DV90	ALL	ALL				
90000547	-	-	-	-	-	-	-	-				
90000550	-	-	-	-	-	-	-	-				
90000543	MV150T	SV6/SV6T	ALL	-	BV400	BV400	-	ALL				
90000541	-	-	-	ALL	-	-	-	-				
90000549	-	-	-	-	-	-	-	-				
90000545	-	SV6	-	-	-	-	-	-				
90000546	-	SV6	-	-	-	-	-	-				
90000548	-	SV6	-	-	-	-	-	-				
90000551	-	SV6	-	-	-	-	-	-				
90000542	-	-	-	-	-	DV96, DV110, DV145 DV200	-	-				

Key: ALL = Switch which is suitable for all models in that range



# Industrial Fans

## Why industrial fans?

Airflow Developments are continuously monitoring changes with regulation requirements for Industrial Fans: Regulation EU327/2011 or ErP for short.

We offer an extensive range of stock fans Ex-stock / Off the shelf.

We can also offer OEM specials to order. All of which incorporate and comply to regulations.

### Stock and Standard

A range of single inlet, double inlet AC and EC, compact and duplex fans and blowers for a wide range of air movement applications.

### OEM

A range of bespoke, custom designed fans and blowers to suit specific customer requirements. Competitively priced and available in quantity batches.

### Flue Gas Dilution

Mild or stainless steel fans for safe dispersal of CO<sub>2</sub>.

### Hot Fans

High temperature centrifugal fans for hot air applications.

## KEEP UP TO DATE



For the latest ventilation news, information, product data and application advice

CLICK CALL VISIT

[airflow.com](http://airflow.com)



# Industrial Fans Introduction

## Introduction

Airflow have been producing high quality air moving equipment and industrial fans for nearly 60 years. During the whole of this period Airflow has been in the forefront developing new techniques and advanced designs. Today the results of this sustained effort can be clearly seen in the variety and quality of products available for all types of industrial air handling requirements.

Most of these industrial fans are available ex-stock direct from Airflow, or through our nationwide dealer network. Variants on the standard range can be made to meet specific needs for customers ordering larger quantities. Please contact Airflow to discuss your requirements.

## Performance Testing

Airflow Developments Limited has its own air movement laboratory. Fans are performance tested in accordance with BS EN ISO 5801: 2008 and BS EN 848-1: 2007.

BS EN 13141 - 4 : 2004	-Performance testing of products for residential ventilation
BS EN 60335 – 1: 2012	-Household and similar electrical safety / general requirements
BS EN 13347 – 3 : 2004 +A1: 2010, BS 848-2.3:2004	-Industrial fan sound power levels under standardised lab conditions
BS 848 – Part 2 : 1985	-Fans for general purposes, methods of noise testing

## Single inlet fans



This range of fans has been developed to provide reasonable volumes of air against resistances to flow greater than can be achieved from small tube axial fans. As the name denotes these

fans feature a single inlet to the fan scroll which enables them to achieve this greater volume performance.

Compact overall dimensions have been achieved using forward curved, centrifugal impellers and two-pole (typically 2800 rev/min.) motors.

The range has fans covering flow rates from 2.8 l/sec to 130 l/sec and static pressures up to 500 Pa for the largest unit.



## Double inlet fans

A range of fan units developed from the demands of the Domestic Warm Air Market where large volumes of air at low outlet velocities are required from very compact units.

All the fans feature two large inlets and a generous outlet, which, combined with low impeller speeds ensure that aerodynamic noise is kept to a minimum. Motor noise and mechanical vibration is reduced considerably by using a patented three-point resilient motor mounting.

All the fans in this range can be speed controlled to give a variety of duties, by voltage variation.

## EC Single and EC Double inlet fans



A range of High Efficiency EC Motor Driven Single and Double inlet fans that can achieve from 93 l/sec to over 1200 l/sec and are fully compliant to the minimum efficiency regulation rates of ErP 327/2011 – 2013 and 2015. The fans incorporate integrated EC type motors with forward curved impellers dynamically balanced to grade 6.3 Din ISO 1940.



Fan cases are constructed from galvanised mild steel which is then powder coated blue. Impellers are manufactured from galvanised mild steel.

Each fan casing is fitted with an outlet flange incorporating fixing holes for ease of installation.

With a standard 230V electrical supply and controlled via 0-10V input, varying duty points can be selected for each fan by the user.

## Duplex fans



The duplex or twin scroll fan unit is basically two fans driven from a common motor which has a double shaft.

The purpose of the design is to provide air across a broad front, for example a water to air heat exchanger. They have an inherent advantage over the crossflow (or tangential) fan in that the forward curved centrifugal impellers have a better pressure development characteristic.

## Compact fans



A range of compact single inlet direct drive fans that can achieve from 83 l/sec to 146 l/sec where space is at a premium. The fans incorporate external rotor motors with integral tab lock constructed forward curved impellers dynamically balanced to grade 6.3 din ISO 1940.

## Hot fans



Specifically designed direct drive fans to handle hot air or the products of combustion from gas burning appliances up to temps of 250°C.

There is an intermediate cooling impeller (an Airflow pioneering design) which eliminates the problem of short motor/bearing life which is commonplace when operating at these temperatures. The range covers from 62 l/sec to 120 l/sec.

## Flue Gas Dilution fans



With the main advantage of avoiding the use of unsightly or expensive flues

The Institute of Gas Engineers UP 10/part 1 (issue 3) regulations require that if the products of combustion are dispensed at low level then the CO<sub>2</sub> content must be 1% or less. Airflows flue dilution range achieves this by introducing fresh air into the boilers discharge flue duct and diluting these flue gases. In two ranges GBDF and SSDF with 5 sizes in each range allow selection for

industrial and commercial boilers rated up to 650 Kw (2,200,000 Btu) singly and can be selected in parallel for boiler sizes exceeding this.

## Technical general information

Airflow centrifugal fans are ideal general purpose units for ventilation, cooling and air moving applications where ambient temperatures do not exceed 40°C. The exceptions are Hot fans & Flue Dilution fans

A degree of speed control is possible with these ranges of fans, again excepting the Flue Dilution fans and Hot fan range.

Although more than adequately sealed and protected for general applications, these fans are unsuitable for handling explosive, inflammable, or highly corrosive gases or gas/air mixtures.

## Construction

Apart from the three smallest fans in the Single Inlet range the fan casings (scrolls) are manufactured from zinc coated sheet steel components spot-welded together to provide a very rigid construction. They are painted blue using modern powder spraying techniques which give a tough durable finish. The impellers are created from a continuous strip of formed blades which are "roll seamed" and locked into a back plate and inlet ring to provide a rigid, concentric impeller wheel.

## Maintenance

The fans are generally designed for use in "normal" air movement conditions. Filters should be used where contaminants and dust burdens. It is an important periodic examination and if necessary, cleaning of the impeller is undertaken. This will avoid dust or dirt build-up on the blades which, if not removed, will impair the capabilities of the fan to move its designed air volume.

# A Fan for all Applications

## Is your application here?

Our fans have been successfully used in many diverse applications. The following is offered as a typical guide to our industrial fans and their applications. However, we are happy to advise on selecting the correct fan for your application.

### HVAC

(Heating, Ventilating & Air Conditioning)



- **Air cleaners and fan/filter units**  
Moving air through electrostatic, carbon, HEPA and other filter media  
Single inlet and fans 40BTFL to 83F2WL double inlet



- **Air conditioning units**  
Distribution of conditioned air  
Generally double inlet types
- **Boiler combustion air fans (gas fired)**  
Providing air or a gas/air mix to burners  
40BTFL
- **Boiler/heater flue fans (gas fired) and gas fired overhead radiant tube heaters**  
Assistance for exhausting the products of combustion to atmosphere  
45BTFR-HT, 52BTX-HT, 71BTX-HT

- **Dehumidifiers (domestic & commercial)**  
Distribution of dehumidified air in homes, timber warehouses etc  
Typically impellers or fan parts sizes 27 to 71

- **Door curtains**  
Warm air "curtain" at doorways, retail and industrial premises  
Double Inlet fans, Duplex fans

- **Fan coil units**  
Passing air over heat exchangers for heating, typically offices  
Duplex fans

- **Flue dilution fans**  
Dilutes combustion products from gas fired boilers to low level discharge  
The flue dilution GBDF and SSDF ranges



- **General air handling units (AHU'S)**  
"Central" plant for distributing air into a ventilation system, heated, filtered etc  
Generally the ranges of double inlet fans
- **General ventilation**  
Simple distribution of air through combination of ducts, grilles etc  
Generally the ranges of double inlet fans

- **Heat recovery units**  
Fans used for supply and extract. Supply fan collects heat from exhaust air  
90G2WL (4 and 6-pole) 102H2WL14
- **Industrial warm air heating**  
Distribution of warm air lphw, steam and gas fired heat exchangers  
Double inlet fans eg. 102H2WL
- **Oil burners**  
Provides combustion air for oil fired boilers  
Generally impellers only typically 45 and 52 sizes
- **VAV (variable air volume) units**  
Mixing of conditioned and re circulated air and distribution into offices  
Double Inlet fans 71E2TIXR, 83F2WL, 90G2WL, 102H2WL

### Production/process equipment



- **Air conveying**  
The transportation of lightweight product along ducts or channels  
71 size impellers, ACF 160x62, 57DTLG90



- **Laminar Flow cabinets**  
Provide uniform, clean air flow across work stations, electronics mfg. etc.  
90G2WL, Duplex etc.



- **Packaging machinery**  
Various functions inc. cooling shrink wrap and polythene bag inflation  
33BTFL, 40BTFL

- **Plastic bottle manufacturing**  
Cooling mass produced plastic bottles used in the soft drinks industry  
45CTL, 52B7XL

- **Plastic extrusion machines**  
Cooling extrusion barrels  
45CTL, 52BTXL

- **Printed circuit board manufacture**  
Cooling, testing and solder fume extract  
52BXL

- **Tank heaters**  
Blowing hot combustion product down tubes for indirect heating of liquids  
52BTXL

- **Tunnel ovens**  
Heating, cooling and mass produced products  
57BXL

- **Vacuum forming machines**  
Cooking large plastic components to speed up production cycle time  
52BTXL



### Electrical, electronics & optical

- **Electronic component cooling, general**  
To dissipate heat build up generated by components, within enclosures  
21ATXL, 40BT Duplex and larger. Could be any fan size/type



- **Cooling of large motors & transformers**  
Forced ventilation through machines to keep temperatures within limits  
52BTXL, 52DS, 57DT



- **Photocopiers**  
Lamp cooling  
33BT or similar



- **Photographic processing equipment**  
Drying film, litho plates etc.  
45CTL, 52BTXL, 102H2WL

- **Projection equipment, theatre & disco lighting equipment**  
Condenser lens cooling for conventional and laser light  
ACF 120X62, 45BTFL

- **Telecommunications; mobile phone transmitter cabins**  
Ventilation of cabins containing transmitter electronics  
90G2WL/6, 90G2WL/4, 102H2WL



### Laboratory & medical equipment

- **Environmental chambers**  
Circulation of conditioned air  
90G2WL, various impeller sizes
- **Laboratory ovens**  
Hot air circulation  
Radial oven impellers 45BFR hot fans
- **Medical isolation beds**  
Supply of sterile air to highly contagious patients  
40 Duplex - Single Inlet fans



### Leisure

- **Bouncy castles**  
Inflation and maintenance of pressure  
Impellers for robust and portable fans, typically 52, 57 and 71 sizes - Single Inlet fans
- **Film & theatre special effects**  
Smoke effect, flying effects etc.  
90G2WL often used Double Inlet fans

- **Swimming pool domes**  
Inflates and maintains plastic dome over outside swimming pools  
90G2WL Double Inlet fans

### Domestic equipment/appliances



- **Cooker fans**  
Circulation of hot air around oven cavity
- **Commercial catering ovens**  
Circulation of air warming and cooking ovens  
26BTC, 52BTXL (hot)
- **Gas fire flue boosters**  
Extract combustion products from "open" fires without a flue  
40BTFL HT
- **Microwave ovens (commercial)**  
Cooling of the microwave magnetron  
26BTC, 40BTFL, 45CTL
- **Shower/steam cubicles**  
Circulates warm air into shower  
21ATXL Single Inlet fans



### Miscellaneous

- **Air tables for the clothing manufacturing industry**  
Provides an air cushion to allow multiple layers of cloth to be moved for cutting  
64ES Stool fan / Double Inlet fans
- **Commercial catering ovens**  
Circulation of air warming and cooking ovens  
26BTC, 52BTXL (hot)
- **Commercial vehicle ventilation**  
Part of the heating and ventilation system in truck cabs, coaches and vans  
40B2T Duplex (less motor) 45 impellers  
Single Inlet fans
- **Grain conditioning**  
Permanent trickle ventilation in grain silos and "spot cooling" with a tube spear  
Double Inlet fans and 52BTXL for the spot cooling



- **Hydraulic oil coolers**  
Driving air through oil cooling heat exchangers on transport vehicles  
Impellers only 52 to 76



- **Laundry equipment**  
Ventilation of industry ironing boards  
52BTXL fans, 71D impellers



- **Military**  
Electronic cooling in sonar, radar equipment etc.  
40B2T Duplex, 90G2W Double Inlet

- **Vehicle washers**  
Cooling pump motors  
57B impellers and cases - Single Inlet fans

# Single Inlet

Small centrifugal fans



## Key Features

- Ecodesign ErP 2015 compliant
- Smaller sized direct drive fans
- Excellent air flow / pressure capability for size
- High velocity at discharge from larger models for localised 'spot cooling'
- Easy installation
- Very low maintenance
- Quiet operation

## Single Inlet fans

A comprehensive range of small single inlet fans primarily developed for the electronics market and manufacturing process. Suitable for handling ambient temperature to 40°C. Constructed in die cast metal, ABS plastic, or mild steel depending on model, the range can achieve

from 5.1 l/sec up to 128 l/sec. The majority of fans are ex-stock. Variance for OEM applications are available on request against a minimum order normally 100 off. Please apply to customer services for non standard designs.



## Applications

- Filter units
- Electronic internal component cooling
- IC testing
- Cooling large motors and transformers
- Photocopiers
- Photographic processing equipment
- Packaging machinery
- Plastic extrusion
- PCB manufacture
- Solder extraction fumes
- Microwave ovens
- Leisure applications, bouncy castle etc
- Car washers

\* Note - Fans are not suitable for EEXE, EEXD, ATEX or corrosive atmospheres

## Specifications

Driven by either open frame shaded pole, ventilated voltage shaded pole or permanent capacitor type motors, very low maintenance is achieved by incorporating 'sealed

for life' bearings typically offering bearing life L10. 25,000 hours in ideal conditions. Test data in accordance with BS 848 Part1/ ISO 5801-2007.

\* A degree of speed control is available on models 33BTFL, 40BTFL, 45CTL by voltage variation

## Technical Data

Fan Model	Supply voltage	Frequency	Capacitor value	Max running current	Start current (approx)	Max input watts	Max air flow	Min static pressure	Noise level	Speed at max air flow	Weight	Max ambient temp
	Volts											
21ATXL	230	50	N/a	0.12	0.155	15	5.1	0	34	2720	0.7	40*
26BTML	230	50	N/a	0.12	0.155	15.5	18.2	0	40	2230	0.7	40*
26BTCL	230	50	N/a	0.12	0.155	15	16.2	0	34	2180	0.9	40*
33BTFL	230	50	N/a	0.20	0.27	29.5	29.3	0	41	2380	1.3	40*
40BTFL	115 / 230	50	N/a	0.75 / 0.375	1.08 / 0.54	57	49	0	50.5	2500	1.5	40*
45CTL	115 / 230	50	N/a	1.8 / 0.9	2.4 / 1.2	130	86.5	0	56.5	2330	2.4	40*
52BTXL	230	50	4	0.63	2.35	144	118.5	0	59	2835	3.5	40*
57BXL	230	50	4	0.81	155	187	128	0	63.5	2730	4.4	40*

\*at 1 metre •Impedance Protection •Thermal Protection

## Dimensions

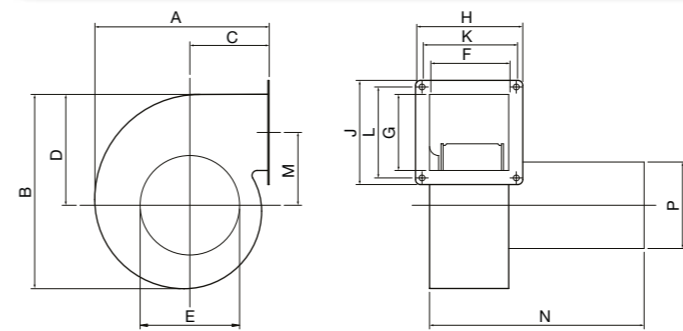

Fan Model	A	B	C	D	OE INLET	F INSIDE	G INSIDE	H	J	K CRS	L CRS	M	N	OP
21ATXL	85	88	43	49	42	28	34	-	-	47	-	30	90	-
26BTML	102	116	46	66	57	52.4	41.3	-	-	-	50.8	-	114	-
26BTCL	102	116	45	73	57	51	41	-	-	-	51	-	112	-
33BTFL	130	135	62	76.5	67	57	46.4	83	72	70	60	53.3	125	-
40BTFL	141	156	64	90	83	57	64	84	90.5	69.8	76.2	58	157	83
48CTL	172	189	79	107	95.5	76	73	103	100	90.5	87.3	70	206	83
52BTXL	195	216	89	124	111	64	89	117.5	117.5	88.9	73	78.5	175	100
57BXL	214	232	98	131	133	64	89	117.5	117.5	88.9	73	85.7	175	100

Dimensions are for guidance only - certified drawings available

## Performance

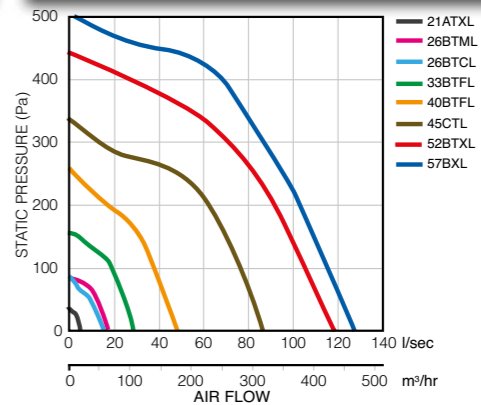

## Controls and Accessories



See page 238 for the range of Commercial Speed Controllers

# Double Inlet

Higher volume centrifugal fans



## Key Features

- Ecodesign ErP 2015 compliant - depending on model
- Large range of standard fans to suit all applications ex-stock
- Designed for low noise requirements
- Speed controllable
- Greater pressure capability available on some models for higher resistances
- Solution to space critical applications
- In-built thermal protection
- Vertical and horizontal discharge mounting

## Double Inlet fans

This range of fans are designed specifically for applications where low noise levels and/or space is an issue. Both models offer a good range of motor speed via voltage variation. Suitable for ambient temperatures of 40°C with inbuilt thermal protection. Dynamically

balanced to DIN ISO 1940 G. 6.3. OEM Variants are available on request. Please apply to customer services for non-standard design (Minimum order quantities will apply)



## Applications

- Filter units
- VAV boxes
- Smaller AHUs
- Domestic heat recovery
- General ventilation
- Industrial warm air movement
- Telecommunications / phone transmitter cabins
- Environmental chambers
- Special effects for the film industry
- Swimming pool / tennis court domes
- Clean air flow across workstations

## Specifications

Models in this range feature forward curved impellers constructed from aluminium with fan cases fabricated from mild steel. For ease of installation units have fitted outlet flanges which have pre drilled mounting holes. Units can be mounted vertically or horizontally. For ease of electrical connection units are supplied with flying leads or pre

wired capacitor with terminal block. Low maintenance is achieved by using "Sealed for life" type bearings allowing a typical bearing life L10-25,000 hours in ideal conditions. Impellers are balanced at manufacture. Test Data in Accordance with BS 848 part 1/ISO 5801-2007.

## Technical Data

Fan Model	Supply voltage	Frequency	Capacitor value	Max running current	Start current (approx)	Max input watts	Max air flow	Min static pressure	Noise level	Speed at max air flow	Weight	Max ambient temp
	Volts	Hz	µF	Amperes	Amperes	Watts	Litres/s	Pascal	dB(A)*	Rev/m	kg	°C
57FTQR/4	230	50	N/a	0.53	0.75	92	125	0	48.5	1150	3.2	40●
71E2TIXR/6	230	50	2	0.5	0.81	105	235	0	45.5	850	6.7	40●

\*at 1 metre ●Thermal Protection

## Dimensions

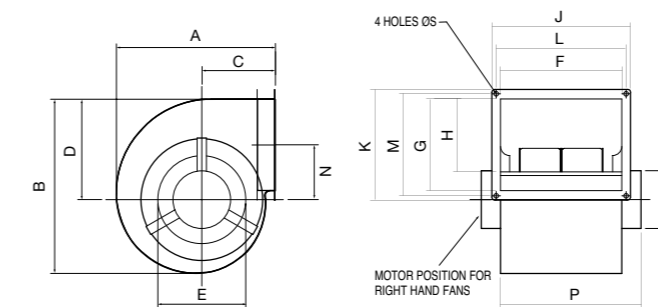

Fan Model	A	B	C	D	ØE INLET	F INSIDE	G INSIDE	H	J	K CRS	L CRS	M	N	P	ØR	ØS
57FTQR	224	248	102	142	127	127	95	-	166	136	149	119	94.5	140	-	5.6
71E2TIXR	278	305	129	175	140	210	127	-	250	167	232	149	110	255	105	9.6

Double width double inlet fans

## Performance

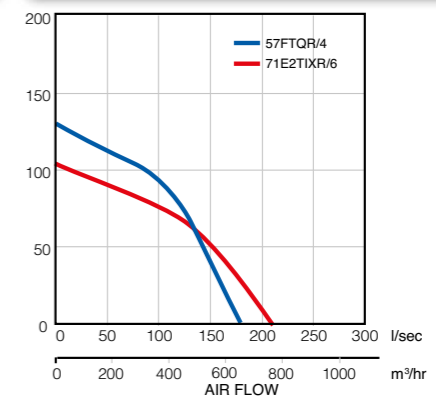

## Controls and Accessories



See page 238 for the range of Commercial Speed Controllers

# Compact Fans

Narrow, high performance centrifugal fans



## Key Features

- Ecodesign ErP 2015 compliant - depending on fan size
- 'Compact' Direct drive fans
- External rotor motor
- Engineered for significant benefits in performance and pressure development
- Designed for handling air within 'space critical' equipment
- Temperature up to 65°C

## ACF Compact fan

Airflow Development's compact direct drive fan can achieve 83 l/sec. This fan is specifically suited where space is at a premium. The fan incorporates an external rotor motor with integral tab lock constructed forward curved impeller. Impellers are dynamically balanced to grade 6.3 DIN ISO 1940. Fan casings are manufactured

from mild steel which is coated with a robust paint finish. Casings incorporate an output flange with integral fixing holes for ease of installation. OEM variants are available on request. Please apply to customer services for non-standard design (Minimum order quantities will apply).



## Applications

- Compact cooling in electronics / server cabinets
- Lighting and cinema equipment
- Smaller air conveying systems
- Fume cupboards
- Museum interactive displays
- Plastic manufacturing
- Any application demanding 'space critical' air movement
- Car washers

\* Note - Fans not suitable for EEXE, EEXD, ATEX or corrosive atmospheres

## Specifications

This fan is eminently suitable for speed control via voltage variation due to the use of an external rotor motor. For ease of electrical connection the unit is supplied with flying leads. Very low maintenance is achieved by the use of

sealed for life bearings, typically offering a bearing life L10-25,000 hours in ideal conditions. Fans are suitable for any plane mounting. Test data in accordance with BS 848 Part 1/ISO 5801-2007

## Technical Data

Fan Model	Supply voltage	Frequency	Capacitor value	Max running current	Start current (approx)	Max input watts	Max air flow	Min static pressure	Noise level	Speed at max air flow	Weight	Max ambient temp
	Volts	Hz	µF	Amperes	Amperes	Watts	Litres/s	Pascal	dBA*	Rev/m	kg	°C
ACF120X62 L2	230	50	2	0.38	0.6	90	83	0	58	2020	1.95	65

\*at 1 metre •Thermal Protection

## Dimensions

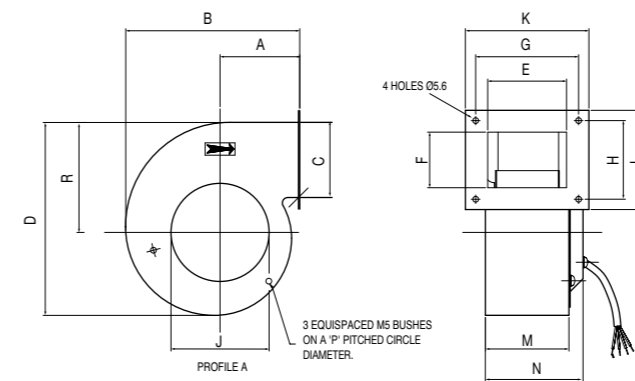

Fan Model	Stock No.	A	B	C	D	E	F	G	H	I	K	L	M	N	P	R
120x62 L2	72371701	77	170	74	189	77	70	100	92	95	120	112	83	97	134	106

Dimensions are for guidance only - certified drawings available

## Performance

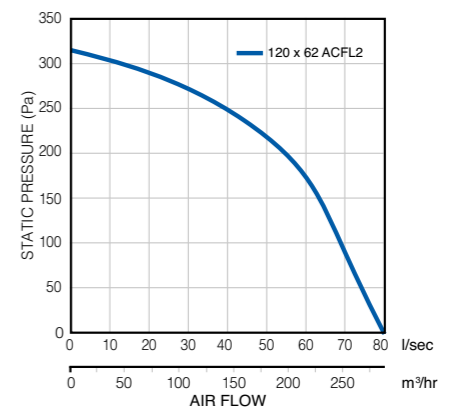

## Controls and Accessories



See page 238 for the range of Commercial Speed Controllers

# Duplex Blower

Wider discharge centrifugal fan

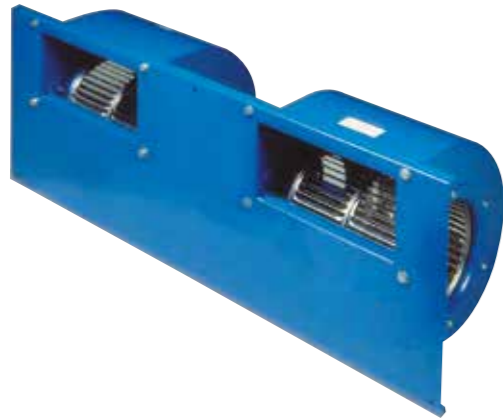

## Key Features

- Ecodesign ErP 2015 compliant
- Twin scroll duplex arrangement
- Designed to deliver a volume where a wider discharge footprint is required
- Higher volumes achieved with quiet sound level from 41 dB(A)
- Low fan profile
- Excellent air velocity for process and electrical cooling

## Duplex fans

The duplex or twin scroll fan is driven by a common motor with two drive shafts. This fan is designed to provide air across a wider discharge footprint at a much larger volume but with a smaller physical profile, for example across each surface of a heat exchanger. Variance for OEM applications is available on request

against a minimum order normally 100 off. Please apply to customer services for non standard designs.

The duplex fan covers up to 160 l/sec giving a definitive profile / volume advantage. Suitable for ambient air temperatures to 40°C.

## Applications

- Air curtains
- Laminar flow / clean air cabinets
- Fan coil units / heat exchangers
- Air convection systems
- Filtration systems
- Military applications
- Medical applications
- Clean room environment
- Fabric conditioning / drying

\* Note - Fans not suitable for EEXE, EEXD, ATEX or corrosive atmospheres

## Specifications

Driven by 2 pole dual voltage, motor, with impeller constructed from aluminium within mild steel casing. Electrical connection is via flying lead on terminal block for ease of installation, normally via the pre-drilled outlet

flanges, very low maintenance achieved by use of sealed for life bearings allowing a typical bearing life L10 – 25,000 hours in ideal conditions. Test data in accordance with BS 848 Part1/ ISO 5801-2007.

## Technical Data

Fan Model	Supply voltage	Frequency	Capacitor value	Max running current	Start current (approx)	Max input watts	Max air flow	Min static pressure	Noise level	Speed at max air flow	Weight	Max ambient temp
	Volts	Hz	µF	Amperes	Amperes	Watts	Litres/s	Pascal	dBA*	Rev/m	kg	°C
40B2TX/2DUP	230	50	N/a	1.12	1.6	154	151	0	55.5	2200	3.2	40

\*at 1 metre •Thermal Protection

## Dimensions

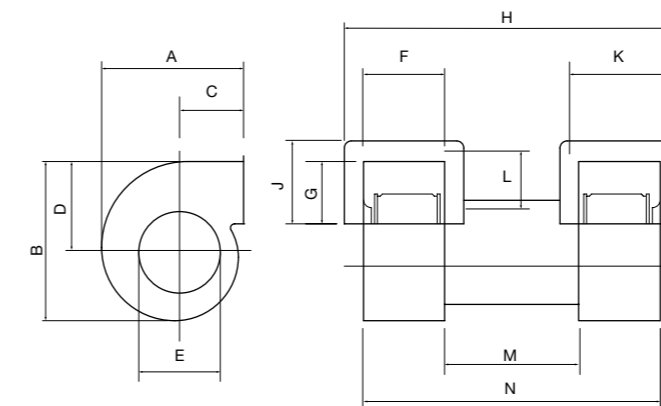

Fan Model	A	B	C	D	ØE INLET	F INSIDE	G INSIDE	H	J	K	L	M	N
40B2X/2DUP	129	157	57	90	83	105	64	336	78	118	57	98	310

Dimensions are for guidance only - certified drawings available

## Performance

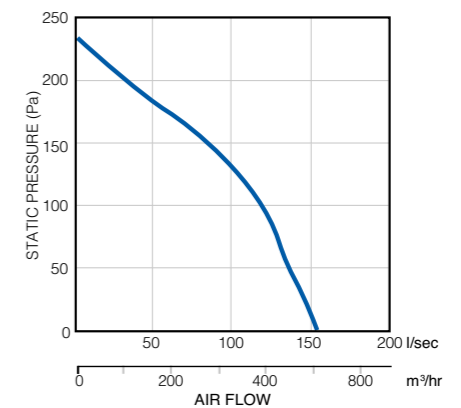

## Controls and Accessories



See page 238 for the range of Commercial Speed Controllers



# A Fan for all Applications



## Why Buy EC Fans?

ErP "Ecodesign" Directive EU 327 / 2011 - A few questions and choices explained

The European Union has adopted the Kyoto agreement and through the Regulation of Energy Related Products (ErP) and environmentally friendly design (Ecodesign) aims to reduce CO<sub>2</sub> emissions from their 1990 level by 20% by 2020.

### What does the Regulation cover?

Minimum efficiency levels for commercial fans with an input power of between 125 Watts and 500 Kilowatts in the EU marketplace.

### What is Efficiency

If you imagine you have to blow some air into a room with a standard AC fan (current technology), you have to use a certain amount of energy to do it. This is how to explain how efficient the fan is. With an EC fan (new technology) **you use a lot less energy to do the same job** and are therefore MORE efficient!

### Which types of Commercial fans are affected?

Fans and motors of all types (axial, centrifugal with forward or backward curved impellers, and mixed flow fans) with an input power between 125W and 500Kw are affected.

### When does the regulation come into force?

#### It's already here

1st Tier started in January 2013 with a set level of efficiency requirements.

2nd started January 2015 with a higher level of efficiency required.

### What are AC and (DC) EC motors?

Electric motors can be divided into two types: **alternating current (AC) electric motors** and **direct current (DC) electric motors**. A DC electric motor will not run when supplied with AC current, nor will an AC motor run with DC current. However if you Electrically Commutate (EC) a DC motor will operate, hence the term EC motor.

#### AC type fans – use AC or Alternating Current motors.

Of these types, brush electric motors are by far the most common. They are easy to build and very cost effective. Their major drawback is that they use carbon brushes to physically transfer electrical current to the rotating parts. In this transfer typical AC motors have losses in terms of power consumption (copper + iron losses), slippage and frictional losses (mechanical power). They are fairly in-efficient because they have to use more power to overcome these losses to maintain their performance.

#### EC type fans – use Electrically Commutated motors.

EC stands for Electronically Commutated and it combines AC and DC voltages, bringing the best of both technologies. A permanent-magnet brushless DC motor within the rotor is driven by electronic switches (which replace the carbon brushes), controlled by a microcontroller, and as such are electrically commutated. EC motors have no slippage thereby reducing losses and increasing efficiency to a high level.

MOTOR EFFICIENCY COMPARED AC / EC

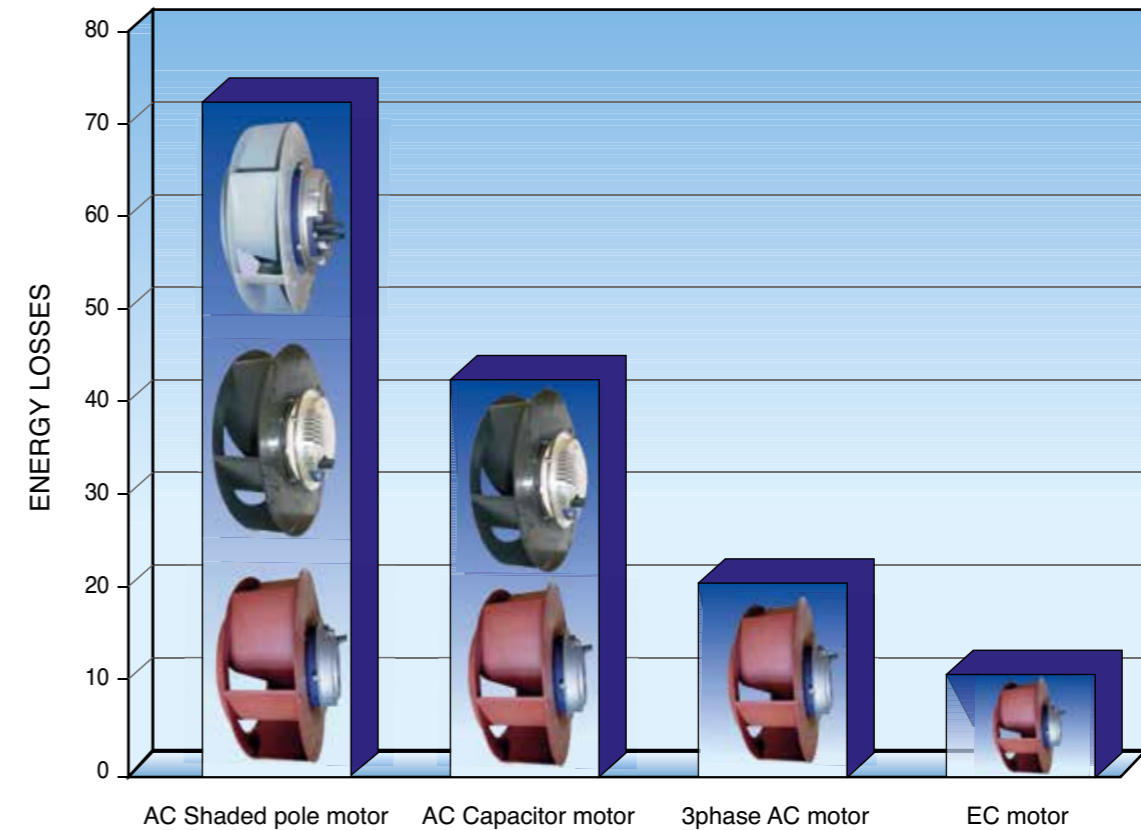

### Airflows EC fans

Our new EC range of single and double inlet fans are fully compliant with the regulation and use up to 80% less energy than standard AC fans for the same job.

So you can now replace your existing single or double Inlet AC fan easily, with one of the range of NEW Airflow EC fans, or you can simply choose an EC fan for your new application.

Whichever way you choose to use our EC fans as you would expect from Airflow, thanks to the union of high efficiency EC motors and impeller design you can be assured of finding the correct Industrial ErP compliant fan for your application from our range, making Airflow the "natural" choice.



# EC Single Inlet Fans

Small voltage controlled EC centrifugal fans



## Key Features

- Ecodesign ErP 2015 compliant
- Compact size direct drive fans
- EC high efficiency motor
- Engineered for significant benefits in performance and pressure development
- Designed for handling air within 'space critical' equipment
- Tachometer output 0-10V
- Temperature up to 40°C
- EC motor variable speed control via voltage 0-10V Input
- Range of EC single fans - ex-stock

## EC Single Inlet fans

A range of compact high efficiency driven EC fans that achieve from 83 l/s to 115 l/s and fully comply to the minimum efficiency regulation rates of ErP 327/2011 – 2013 and 2015. The fans incorporate integrated EC type motors with tablock constructed forward curved impellers dynamically balanced to grade 2.5 DIN ISO 1940. Constructed from mild steel with a robust paint finish, each fan casing is fitted with an outlet flange

incorporating fixing holes for ease of installation. Simply choose a compliant EC fan for your new high efficiency application.

OEM variants are available on request. Please apply to customer services for non-standard design (minimum order quantities will apply).



## Applications

- Compact cooling in electronics / server cabinets
- Lighting and cinema equipment
- Smaller air conveying systems
- Fume cupboards
- Museum interactive displays
- Plastic manufacturing extrusions
- Any application demanding 'space critical' air movement

\* Note - Fans are not suitable for EEXE, EEXD, ATEX or corrosive atmospheres

## Specifications

The fans in this range are eminently suitable for speed control via voltage variation 0-10V input and come supplied with direct flying lead 230V and 0-10V connection to the motor. Very low maintenance achieved by use of sealed

for life bearings in the EC motors, typically offering bearing life L10. 25,000 hours in ideal conditions and can be universally mounted via flange. Test data in accordance with BS 848 Part1/ ISO 5801-2007.

## Technical Data

Fan Model	Supply voltage	Frequency	Control voltage	Speed at Max input watts	Max input watts	Noise level	Min static pressure	Max air flow	Weight	Max ambient temp	IP	ErP 2013/2015
	Volts	Hz	Volts	Rpm	W	dBA*	Pascal	L/S	kg	°C		
SIEC 120x x 62	230	50 / 60	0-10v	2800	55	58	0	78	2.1	40	IP 24	✓
SIEC 133x x 46	230	50 / 60	0-10v	2200	75	54	0	90	2.2	40	IP 24	✓
SIEC 160x x 62	230	50 / 60	0-10v	1310	80	58	0	115	3.2	40	IP 24	✓

## Dimensions

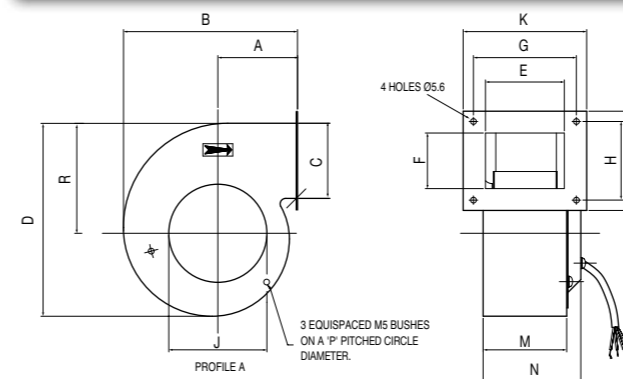

Fan Model	Stock No.	A	B	C	D	E	F	G	H	J	K	L	M	N	P	R
120 x 62 L2	9000365	78	174	75	192	82	75	100	92	94	120	112	85	127	134	107
133 x 46 L2	9000366	81	197	92	230	73	92	85	110	108	105	130	75	115	146	119
160 x 62 L2	9000367	104	231	97	268	83	97	100	112	138	120	132	86	127	162	142

Dimensions are for guidance only - certified drawings available

## Performance

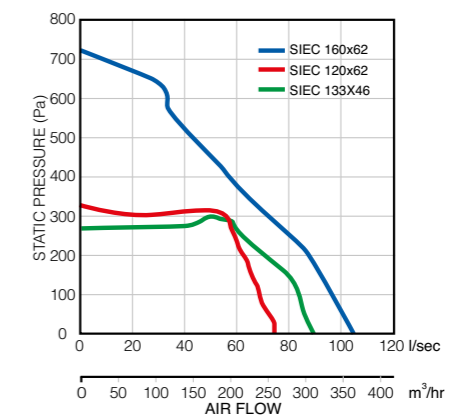

# EC Double Inlet Fans

Higher volume voltage controlled EC centrifugal fans



## Key Features

- Ecodesign ErP 2015 compliant
- Large range of standard fans to suit many applications - ex-stock
- EC high efficiency motor
- Designed for low noise requirements
- Speed controllable 0-10V input
- Excellent pressure capability throughout the range
- Solution to space critical applications
- Tachometer output 0-10V
- Vertical and horizontal discharge mounting

## EC Double Inlet Fans

A large range of high efficiency EC fans designed specifically for applications where low noise levels and/or space criticality are an issue. All models offer a good range of volume control via 0-10V input, due to the high efficiency EC motor. Exceeding minimum regulation efficiency requirements for EU 327/2011 - 2013 and 2015. These fans allow you to choose a high efficiency

EC fan for your new application or replace a less efficient model in your existing application. See technical data table for replacement comparison.

OEM variants are available on request. Please apply to customer services for non-standard design (minimum order quantities will apply)



## Applications

- VAV boxes
- Waste recycling
- General ventilation
- Industrial warm air movement
- Telecommunications / phone transmitter cabins
- Environmental chambers
- Special effects for the film industry
- Swimming pool / tennis court domes
- Clean air flow across workstations

## Specifications

These fans feature EC driven forward curved impellers constructed from mild steel with cases fabricated from mild steel. For ease of installation all units have fitted outlet flanges, and can be mounted vertically or horizontally. Supplied with connection to terminal box from electrical

supply. Low maintenance achieved by 'sealed for life' type bearings allowing a typical bearing life L10 – 25,000 hours at ideal conditions. Impellers balanced to ISO DIN 1940 Grade 2.5. Test data in accordance with BS 848 Part1/ ISO 5801-2007.

## Technical Data

Fan Model	Supply voltage	Frequency	Control voltage	Speed at Max input watts	Max input watts	Noise level	Min static pressure	Max air flow	Weight	Max ambient temp	IP	ErP 2013/2015	Replaces Airflow Fan
	Volts	Hz	Volts	Rpm	Watts	DBA	Pascals	l/sec	Kg	°C			
DIEC-178	230	50/60	0-10	1600	55	47	0	165	6.8	45	IP 24	✓	64E2SR 71E2TIXR
DIEC-215	230	50/60	0-10	1050	200	50	0	465	9	50	IP 20	✓	83F2WL/6
DIEC-222	230	50/60	0-10	1550	550	60	0	1020	14	40	IP 20	✓	90G2WL/6 90G2WL/4
DIEC-270	230	50/60	0-10	1550	1100	65	0	1200	22	40	IP 20	✓	102H2WL/6 102H2WL/4
DIEC-178/2	230	50/60	0-10	1550	550	57	0	668	7	40	IP 20	✓	76E2WL/4
DIEC-215/2	230	50/60	0-10	1550	550	65	0	750	7	40	IP 20	✓	83F2WL/4

## Dimensions

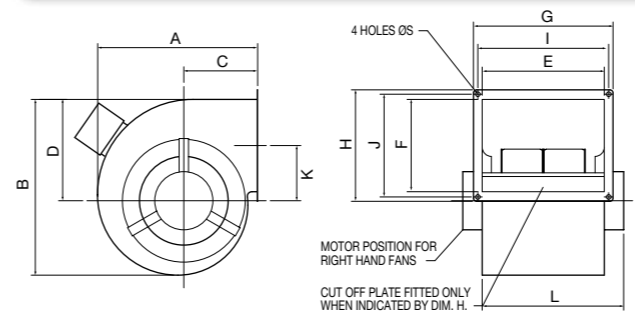

Fan Model	A	B	C	D	E	F	G	H	I	J	K	L
DIEC 178	277	302	138	176	204	103	250	164	232	146	83	265
DIEC 215	332	366	149	207	249	256	300	276	270	212	138	324
DIEC 222	364	392	167	219	284	255	347	286	319	257	142	357
DIEC 270	422	442	202	246	329	281	409	346	384	270	173	409
DIEC 178/2	309	322	147	182	228	217	296	265	272	241	132	320
DIEC 215/2	332	366	149	207	245	252	300	276	270	212	138	353

## Performance

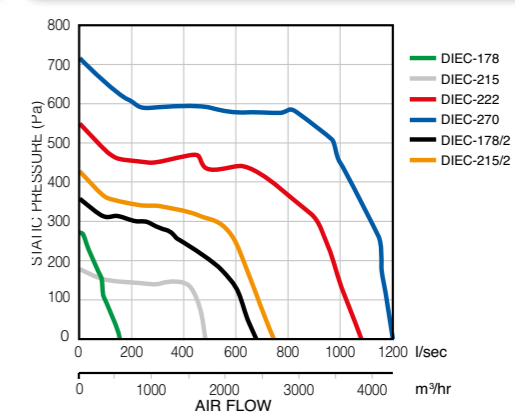

# Flue Gas Dilution

CO<sub>2</sub> safe dispersal ventilation



## Key Features

- Multi size flue dilution fans
- Ecodesign ErP 2015 compliant
- Easy electrical installation
- Safe operation - internal differential pressure switch for boiler shut off
- Avoid unsightly or expensive discharge flues
- Quiet and efficient
- 1% CO<sub>2</sub> content at outlet
- High levels of corrosion resistance allow use with condensation boilers
- Ecodesign EuP compliant IE2
- Dynamically balanced to DIN ISO 1940 - Grade 6.3

## Flue Dilution GBDF & SSDF fans

Their main advantage is avoiding the use of unsightly and expensive flues as shown below. The 1993 Clean Air Act and Institute of Gas Engineers UPE 10/Part 1 (issue 3) Regulations requires that if the products of combustion are dispensed at low level then the CO<sub>2</sub> content must be 1% or less. Airflows' flue dilution range achieves this by introducing fresh air into the boilers discharge flue duct and diluting these flue gases. All fans dynamically balanced to ISO DIN 1940 – Grade 6.3.

## Safety

A differential pressure safety switch ensures boiler shutdown in the event of fan failure on blocked flue, the switch consists of a relay circuit which will fall safe and prevent operation of the gas burner under the following conditions.

- Loss of fan air supply (blocked intake / fan motor inlet)
- Stalled fan motor
- Interrupted power supply



## Applications

- Flue dilution
- Condensate air handling

The range of dilution fans come in two variations, GBDF for standard atmospheric installations and SSDF for enhanced corrosion resistance especially in use with high condensate content and or condensation boilers. 5 sizes in each range allow selection for industrial and commercial boilers rated up to 650 Kw (2,200,000 Btu).

When the specification of regulations call for stainless steel ducting and when higher efficiency condensate boilers on modular burners are more likely to produce condensation the SSDF range should be selected due to its Aisi 316 stainless steel case construction. Test data in accordance with BS 848 Part 1/ ISO 5801-2007.

## Choosing the Correct Size and Type of Fan

Where possible there should be at least 2 metres of flue ducting from the fan to the outlet. To ensure a maximum of 1% CO<sub>2</sub> content at the outlet, the volume flow rate of diluted flue gases necessary for a given boiler can be calculated as follows:

Flow rate in l/sec = 2.69 x rated input of boiler in kW.

Where 2 metres of discharge ducting is not possible then the calculation is:

Flow rate in l/sec = 4.44 x rated input of boiler in kW.

The volume flow rate provided by the fan will depend on the static pressure imposed by the size and length of flue ducting and the number of bends, louvres etc. comprising the installation. The performance table below enables selection of the correct dilution fan based on the flow rate requirement and the fans ability to overcome duct system resistance.

(Note: if LPG or Butane are being used then the factors above should be increased to 3.23 and 5.33 respectively. These flue dilution fans must not be used for any other fuels).

## Performance Table at 20°C

Fan size	Static Pressure (Pascals)	Free Air	10	20	30	40	50	60	70	80	90	100	110	120	130	140	160	180	200	225	250	275	300	325	350	375					
GBDF 2 SSDF 2	Volume Litre/s	300	290	280	260	250	240	230	220	190	140	80	40	0																	
GBDF 3 SSDF 3	Volume Litre/s	600	580	570	560	540	520	510	500	480	460	440	410	380	320	280	120	40	0												
GBDF 4 SSDF 4	Volume Litre/s	1000	985	970	950	935	920	900	880	860	840	815	780	760	740	710	640	520	340	200	80	0									
GBDF 5 SSDF 5	Volume Litre/s	← NOT SUITABLE DO NOT USE →												1400	1370	1350	1325	1300	1260	1200	1150	1075	975	850	450	200	80	0			
GBDF 6 SSDF 6	Volume Litre/s	← NOT SUITABLE DO NOT USE →																	1750	1675	1570	1420	1280	1085	850	625	460				

Dimensions are for guidance only - certified drawings available

Fan size	Units	GBDF 2 SSDF 2	GBDF 3 SSDF 3	GBDF 4 SSDF 4	GBDF 5 SSDF 5	GBDF 6 SSDF 6
Maximum boiler input rating	kw	80	160	270	425	650
Minimum inlet duct diameter	mm	254	305	305	457	457
Minimum inlet louvre size	mm	300x300	400x400	400x400	600x600	600x600
Maximum discharge duct diameter	mm	225	275	345	370	457
Minimum discharge grille size	mm	300x300	400x400	450x450	500x500	600x600
Diluted flue gas volume	l/s	215	430	730	1145	1750
Total static pressure loss in system	Pa	70	93	130	160	180
Maximum flue velocity	m/s	5.5	7.3	7.9	10.7	10.7

Fan size	Min. Duct resistance	Max. Line current
GBDF 5 SSDF 5	90 Pa	2.6 Amps
GBDF 6 SSDF 6	180 Pa	2.9 Amps

Minimum duct resistance required on model size 5 and 6 to avoid overloading motors.



## Electrical Installation

In all classes of installation, it is essential that the pressure safety switch is connected into the supply circuit of the appliance gas valve so that the gas valve is shut off in the event of a fan failure or flue system blockage. After the fan has been installed and electrically connected, a check should be made to ensure that the pressure safety switch causes the boiler to be switched off when failure or blockage is simulated.

## Flue Assistance

The GBDF range can also be used for flue assistance rather than flue dilution (ie: the fan handles all the products of combustion). It is important that the air into the motor side of the fan is ducted from outside the building. The maximum temperature allowed at the inlet of the non drive side of the fan is 110°C ( 230°F ) to maintain acceptable motor bearing and winding temperature. Experience has shown that if a fan is chosen to give a maximum CO<sub>2</sub> concentration of 2% that this maximum temperature will not be exceeded.

Should you wish to use any of our fans purely as an induction fan WITHOUT dilution then the volume rate needed will be :  
Flow rate ( induction only ) in l/sec = 1.35 x rated input of boiler in Kw.

## Safety and Ease of Use



Pressure Safety Switch



Easier electrical connections

- Differential pressure safety switch which will activate if the fan stops operating or if the duct system becomes blocked, thus shutting down the boiler.
- 6 or 10 pole plug and socket for easy wiring and installation.

## The Range

The Airflow range of Ecodesign ErP 2013/2015 Compliant flue dilution fans is available in 5 sizes to satisfy the dilution needs of industrial and commercial boilers rated up to 650 kW (2,200,000 Btu) input.

Each size is available in standard form (GBDF series) for atmospheric boilers and water heaters of circa 75% efficiency. If excessive corrosion causing the failure of a GBDF series unit is due to the presence of residual condensate, then this will not be covered by our warranty.

Enhanced corrosion resistance versions (SSDF series) with stainless steel fan cases are also available for installation where regulations or the specification calls for stainless steel ducting, and when higher efficiency boilers such as modular designs are likely to produce condensation. SSDF's are therefore recommended for installations where condensation will occur.



## Typical Installations

Important when designing and installing a dilution system incorporating Airflow flue dilution fans, attention should be paid to the latest edition of the following standards and guides.

- BS 6644: 2005 Installation of gas fired hot water boilers of rated input between 60 kW and 2 MW.
- The institute of Gas Engineers and Managers Utilization procedure IGE/UP/10-Edition 3. Installation of Gas Appliances in Industrial & Commercial premises.

The boiler is connected by a vertical flue to a header which is open to the "outside" air at both ends. One end of the header acts as the primary air intake for the dilution air and the other as the discharge. The fan is located on the discharge side of the header duct.

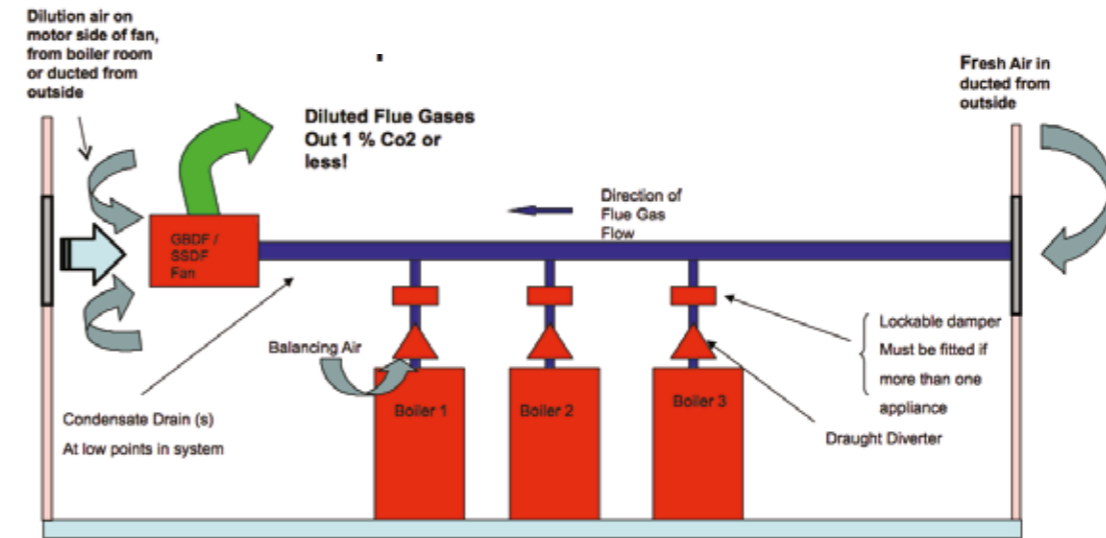

Figure 1.  
GBDF/SSDF  
Flue Dilution Fan  
Multiple Boiler  
Installation

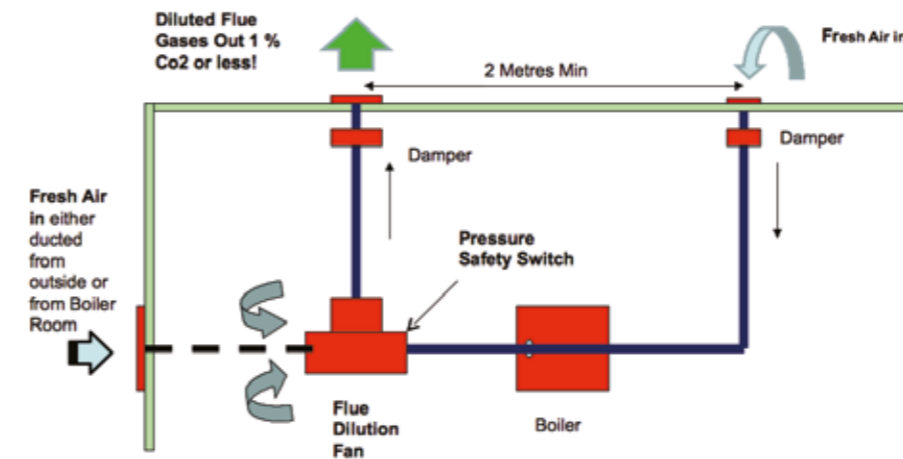
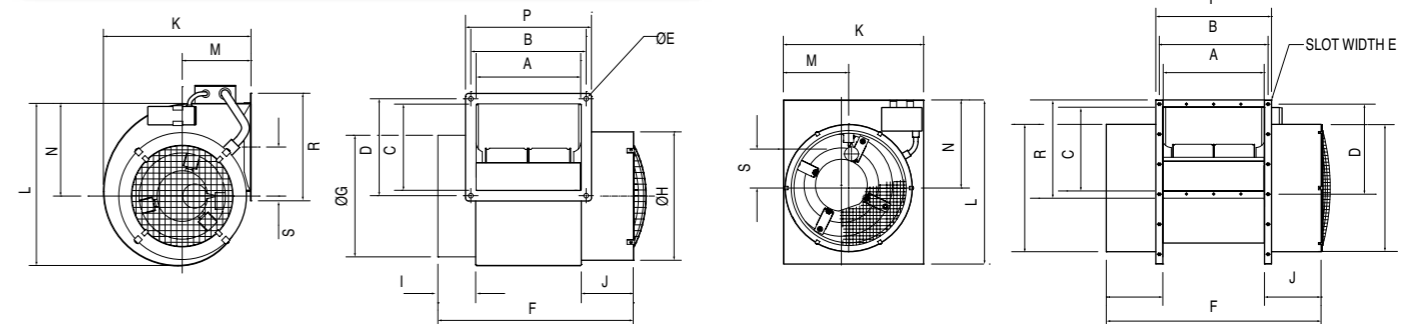

Figure 2.  
GBDF/SSDF Flue  
Dilution Fan  
Single Boiler  
Installation

## Dimensions



Fan size	Weight Kg	Electrical supply V/Ph/Hz	Start current Amps	Full load running current Amps	Motor power Watts	Normal Imp. speed RPM	Max ambient Temp.	Fan size	Minimum clearance mm	in.
GBDF 2	9.1	230/1/50	1.2	0.64	75	900	40°C	GBDF 2	250	10
SSDF 2	8.8	230/1/50	1.2	0.64	75	900	40°C	GBDF 3	300	12
GBDF 3	12.1	230/1/50	2.5	1.45	120	860	40°C	GBDF 4	460	18
SSDF 3	12.0	230/1/50	2.5	1.45	120	860	40°C	GBDF 5	500	20
GBDF 4	22.5	230/1/50	8.4	2.8	335	930	40°C	GBDF 6	630	25
SSDF 4	23.4	230/1/50	8.4	2.8	335	930	40°C			
GBDF 5	42.8	415/3/50	12.0*	2.8*	900	940	40°C			
SSDF 5	44.0	415/3/50	12.0*	2.8*	900	940	40°C			
GBDF 6	46.7	415/3/50	12.0*	2.9*	900	900	40°C			
SSDF 6	47.5	415/3/50	12.0*	2.9*	900	900	40°C			

Fan size	A	B	C	D	E	F	G	H	I	J	K	L	M	N	P	R	S
2	218	238	179	200	9.5	402	251	265	78	106	304	335	140	191	260	222	101
3	250	270	236	257	9.5	440	302	302	78	109	359	394	175	222	294	281	109
4	352	384	263	295	9.5	578	302	340	78	141	408	445	194	256	409	321	121
5	360	386	298	321	7	761	454	454	200	200	500	585	233	314	411	350	145
6	490	517	332	355	7	892	454	454	200	200	500	585	232	336	542	348	145

\*Line current  
Minimum clearance for servicing motor and impeller (between motor side inlet and any obstruction)

# HT Fans

High temperature centrifugal fans



## Key Features

- Can move air at temperature up to 250°C
- Ecodesign ErP 2015 compliant
- Wide range of installation positions
- Intermediate cooling impeller minimises heat to motor and bearings ensuring long life
- Polyester high temperature paint
- Gas 'Tight' casing option available

## High Temperature fans

Specifically designed direct drive fans to handle hot air or the products of combustion from gas burning appliances up to temperature of 250°C. The intermediate cooling impeller, an Airflow pioneering design, eliminates the problem of short motor/bearing life. The range covers

from 62 l/sec to 120 l/sec. Variant OEM Applications – are available on a made to order basis, (depending on quantities required) please apply to customer services for non standard designs.



## Applications

- Overhead radiant tube heating
- Domestic and commercial ovens
- Boiler / heater flue fans
- Gas fire flue boosters

- Hot air extraction
- UV lamp cooling for printing
- Tunnel curing

\* Note - Fans not suitable for EEXE, EEXD, ATEX or corrosive atmospheres

## Specifications

Aluminium or mild steel impellers, housed in Zintec mild steel casing, finished in black polyester high temperature paint. Totally enclosed motors with integrated cooling impeller ensuring extended trouble free motor life, fitted with motor guard arrangement as standard. Able to be mounted from outlet flange or threaded inserts incorporated

into the inlet face of the fan casing. Motors either shaded pole or permanent capacitor type using low maintenance sealed for life bearings ensuring a typical bearing life L10 – 25,000 in ideal conditions. Electrical connection is via 3 core cable for ease of installation. Test data in accordance with BS 848 Part 1/ ISO 5801-2007.

## Technical Data

Fan Model	Supply voltage	Frequency	Capacitor value	Max running current	Start current (approx)	Max input watts	Max air flow	Min static pressure	Noise level	Speed at max air flow	Weight	Max ambient temp
	Volts	Hz	µF	Amperes	Amperes	Watts	Litres/s	Pascal	dB(A)*	Rev/m	kg	°C
45BTFRHT	230	50	N/a	0.55	0.75	85	60	25	53	2330	2.4	40●
52BTXRHT	230	50	2	0.53	1.03	125	102	54	58	2600	3.3	40●

\*at 1 metre ●Thermal Protection

## Dimensions

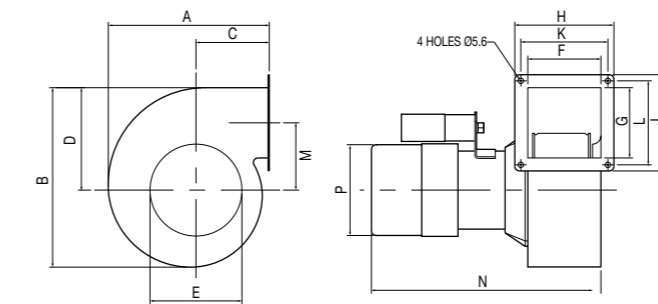

Fan Model	A	B	C	D	ØE INLET	F INSIDE	G INSIDE	H	J	K CRS	L CRS	M	N	ØP
45BTFRHT	172	189	79	107	95.5	60	70	103	113	87	97	70	198	100
52BTXRHT	195	216	89	124	111	64	89	117.5	117.5	88.9	73	78.5	216	100

Dimensions are for guidance only - certified drawings available

## Performance

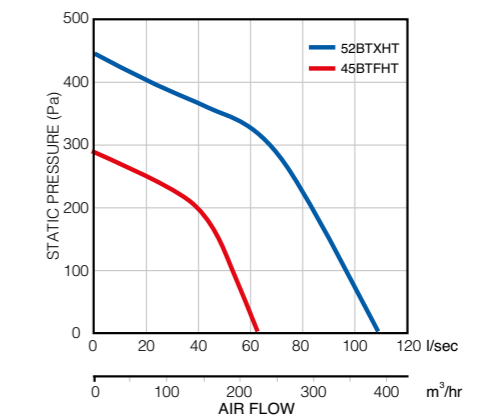

# Instrument

## Why measure airflow?

The Domestic Ventilation Compliance Guide 2010 requires measurement of fans and ventilation systems to a regulatory standard of installed performance. The Airflow vane anemometer provides this function.



### KEEP UP TO DATE



For the latest ventilation news, information, product data and application advice

CLICK CALL VISIT

[airflow.com](http://airflow.com)



# Instrument Solutions

LCA301 anemometer kit



## Key Features

- UKAS certificate of calibration
- Compliant to testing requirements of Domestic Ventilation Compliance Guide 2010
- Aerodynamic design
- Volume flow in m<sup>3</sup>/hr or l/sec
- Velocity in m/sec
- Self sealing hood 285 x 235mm
- Tough ABS to take on-site knocks
- 2 year warranty

### LCA301

The LCA301 Vane Anemometer kits enables on-site measurement to be taken and air volumes calculated for balancing and commissioning ventilation systems, compliant to the testing requirements of the Domestic Ventilation Compliance Guide 2010.

Simple one handed operation and a large clear LCD ensures that velocity or volume flow reading of air measurement is quick, reliable and accurate.

Supplied with the LCA301 is a 285 x 235 Aircone to attach to the vane sensor.

The LCA301 has a single push button control in the hand grip. When the button is pushed and held down the instrument averages the air velocity every 3 seconds up to 12 minutes duration with the average reading shown on the LCD.

Function	Parameter
Velocity range	0.25 to 30 m/s (50 to 6.000 ft/min)
Velocity accuracy	±1.0% of reading ±0.02 m/s (±4 ft/min)
Duct size	0.00399 - 90 m <sup>2</sup> (0.043 - 173.6 ft <sup>2</sup> )
Volumetric flow rate	Actual range is a function of velocity and duct area
Temperature range	0 to 60°C (32 to 140°F)
Accuracy	±1.0°C (±2.0°F)
Resolution	0.1°C (0.1°F)
Instrument temperature range operating	0 to 60°C (32 to 140°F)

Part No.	Product Description
90000017	LCA301 Vane Anemometer Kit



# LOG32 TH DATA LOGGER

## Key Features

- Temperature and Humidity Logger
- Up to 32,000 value storage
- Analytical software supplied (Windows)
- Variable time sampling – 2 seconds to 24 hours
- Wall mounting bracket supplied
- LED mode indicators/buzzer alarm
- 1 year warranty



### LOG32 TH

The Airflow LOG32 TH is a portable battery operated Data Logger. Designed for diagnostic analysis of environmental conditions in commercial, production, laboratories, agriculture or any temperature and humidity critical application.

Powered by a long life Lithium battery it is suitable for recording, alarm tracking and display of air temperature, humidity and dew point. An integral USB port enables direct connection to any compatible device where the Windows software (supplied) can be uploaded.

A flashing green LED indicates data recording, while a red LED indicates an adjustable user set point has been exceeded. The logger also has an internal buzzer to support user set alarm conditions.

Function	Parameter
Memory storage (total)	32,000 values
Temperature	16,000 values
Humidity	16,000 values
Measuring range – temperature	-35° to 70°
Accuracy	±1°C (-10o to 40°C) ±2°C (41o to 70°C)
Measuring range – humidity	0 to 100%RH
Accuracy	±3% RH (40% to 60%) ±3.5% RH (20% to 40%) ±3.5% RH (60% to 80%)
Interface	USB (integrated)
Housing	ABS
Dimensions	98 x 25 x 20mm
Weight	70g
Battery	1 x 3.6v Lithium AA battery

Part No.	Product Description
90000536	LOG32 TH Data Logger



## QuietAir

The quietest bathroom fans\*



reddot design award



- 100mm, 120mm and 150mm high performance fans for toilet, bathroom, utility and kitchen ventilation
- Eco Start (delay start)
- Whisper quiet
- Ultra low energy
- Ball bearing motor
- Room refresh, programmable routine ventilation
- Two speed with a choice of controls
- Suitable for long duct runs
- IP45
- Complies Building Regulations and domestic compliance guide



\*On both speeds, the QuietAir 100 meets the installed performance requirements when ducted as per the Domestic Ventilation Compliance Guide of the current Building Regulations Approved Document F. Sound level of 25 dB(A) on low speed.

For further information see pages 46 - 51

Visit: [airflow.com](http://airflow.com)



## A guide to words and phrases commonly used

### Air

A gas comprising the following constituents (when dry):  
78.09% nitrogen  
20.95% oxygen  
0.93% argon  
0.03% carbon dioxide

### Air density

The ratio of the mass of a given amount of air to the volume which this amount occupies (ie lb/ft<sup>3</sup> or kg/m<sup>3</sup>).

### Secondary air

Room air entrained and set in motion by air discharge from a grille

### Air Changes

A method of calculating the number of times air can be exchanged in a room or space by calculating its volume and dividing this value by the air volumetric performance of the fan in order to establish its suitability for the application. In commercial premises CIBSE guidelines should be followed to determine air change rates.

### Anemometer

An instrument used for the measurement of air velocity and air volume.

### Hot wire anemometer

This has a probe consisting of a very fine short length of wire (or small thermistor bead) attached to the end of a supporting tube. The wire is heated electrically, and measurements are made of the heat dissipated by the wire. The rate of heat dissipation is directly related to the velocity of the air passing the wire.

### Rotating vane anemometer

This consists of a disc of angled vanes attached to a rotating spindle and is usually mounted within a protective ring and supporting bracket. The speed at which the vane assembly rotates is a measure of the air velocity acting upon it. This speed may be sensed electronically or by a counter mechanism.

### Attenuators

Devices for reducing the amplitude of a source of energy. Often used in a noise control device to reduce unwanted sounds.

### BCO

A Building Control Officer or Building Inspector who ensures that Building Regulations are followed during construction and signs off the project.

### Bernoulli's theorem

This says that the total energy per unit mass along any one stream line in a moving fluid is constant, and that the states in which that energy exists (pressure, kinetic or potential) are related and convertible.

### BIM

Building Information Modelling. By 2016 all U.K Government buildings will have to be designed with BIM 3D software as the core design tool. The software enables complete data sets to be attached to components and structures.

### By- Pass

A device within a Mechanical Ventilation with Heat Recovery (MVHR) unit to by-pass the heat exchanger during the Summer months enabling the recirculation of ambient air. A 100% by-pass is most efficient.

### BRE

Building Research Establishment. A private research establishment that carries out testing and consultancy for the build environment. The organisation responsible for operating SAP Appendix Q testing.

### Coanda effect

The tendency for an airstream under some circumstances to attach itself to and follow the shape of a surface. This can occur even for extremely convex curvatures.

### CPD

Continuing Professional Development. The on-going learning process whereby professionals maintain, update and increase the knowledge and skills in their chosen career.

### Competent Person

An individual who has completed a nationally recognised training scheme allowing them to "self certify" that their work complies with the Building Regulations.

### Damper

A device used to control the volume of air passing through a confined cross section by varying the cross-sectional area.

### Diffuser

An outlet device discharging supply air in a direction radially to the axis of entry.

### dMEV

Decentralised Mechanical extract Ventilation. A method of continuous ventilation of a dwelling using extractor fans in wet rooms. An allowable solution under system 3 of Approved Document F.

### Dynamic loss

The energy lost when an airstream travelling at a known velocity is forced to make a sudden change in direction or velocity.

### EC Motor

An electronically commutated motor running on DC voltage from an AC input. Avoiding the use of a transformer the motor incorporates voltage change resulting in a less bulky and more energy efficient performance.

### Energy

#### Potential energy

The energy of a fluid or body due to its position (or height).

#### Kinetic energy

This energy which a fluid or body possesses by virtue of its motion.

### Fan

#### Axial

A rotating propeller type device where the air is moved in the same direction as the inlet and outlet of the fan. Providing high air flow in a slim profile they are ideal for through the wall installation. Suitable for short lengths of ducting only.

#### Mixed Flow

A hybrid combination of an axial and centrifugal fan impeller where the air is moved in the same direction as the inlet and outlet of the fan. Provides higher pressure development than an axial fan so suitable for short to medium lengths of ducting.

#### Centrifugal

Quiet and powerful and suitable for wall, ceiling and ducted installations. Similar in design to a hamster wheel they work efficiently against system resistance making them perfect for longer duct runs.

### Fan Curve

The fundamental performance of a fan or blower with the X axis expressed in pressure and the Y axis expressed in volume flow.



# Air Flow Solutions

## DUPLEXVENT® FLEXI

### Ventilation with Heat Recovery

Improve indoor climate with cleaner, fresher air.  
Saves money too by recovering lost heat!



ALL PASSIVE HOUSE CERTIFIED

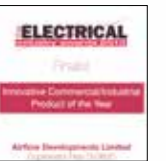

- 1,100 m<sup>3</sup>/hr to 3,600 m<sup>3</sup>/hr
- Off the shelf delivery
- Counter flow exchanger with up to 95% heat recovery
- Designed for schools, offices, retail and leisure facilities
- Ceiling or floor mounted
- Internet connection and BMS
- Low energy, EC fans
- Incorporate into BREEAM assessments



For further information see pages 176 - 187

Visit: [airflow.com](http://airflow.com)

#### Frost Protection

Used in MVHR equipment to prevent moisture freezing in the heat exchanger and allied parts.

#### Grille

A system of fixed or adjustable vanes covering an opening through which air is discharged.

#### Return grille

A grille covering an opening through which air is withdrawn from the conditioned space.

#### Heat Exchanger

A device designed to efficiently transfer heat from one air stream to another, as in MVHR. At no time does the warm and colder air mix but a Metal or Polypropylene core may be used to transfer heat at different temperatures.

#### IEEE

Institute of Electrical and Electronic Engineers

#### Inlet device

A shaped air intake with pressure tappings that can be calibrated and used to measure air flow rate (e.g. bellmouthed or conical inlets).

#### IP Rating

The degree of protection afforded by a casing against the ingress of solid objects and liquids. Designated by IPXX

The first figure is for solid objects rated from 0 (no protection) to 6 (total protection).

The second figure is for Liquid from 0 (no protection) to 9 (protection against long periods of immersion under pressure).

#### MEV

Mechanical extract ventilation. A description usually applied to a central extract system as defined in System 3 of Approved Document F.

#### MVHR

Mechanical Ventilation with Heat Recovery. Equipment to regain warmth from otherwise waste extract air and supply to living spaces providing warm, filtered fresh air.

#### Notifiable Work

Activities which require compliance with the Building Regulations, approval by Building Control.

#### Passive House

A term referring to a very high standard of energy efficiency in a buildings design and construction. Typically a dwelling would have an air tightness level better than 1.5 m<sup>3</sup>/hr/m<sup>2</sup>

#### Pressure

##### Air pressure

The force per unit area imposed on the surface of a solid body by gaseous air.

##### Absolute pressure

Pressure relative to a perfect vacuum.

##### Barometric pressure

The local ambient air pressure.

##### Differential pressure

The difference between pressures measured at two points or levels in a system.

##### Static pressure

The difference between the absolute pressure at a point in an air stream or a pressurised chamber and the absolute pressure at ambient temperature. This is positive when the pressure at that point is above ambient pressure, and negative when below. It acts equally in all directions and is independent of velocity.

##### Velocity pressure

The increase in pressure produced by bringing a moving airstream to rest (as measured by a pitot static tube). It is equal to the product of air density and the

square of the velocity divided by 2, and is sometimes known as the velocity head or dynamic pressure.

#### RCD

A residual current device is a life saving component designed to disconnect an electrical circuit when it detects the electrical current is un-balanced. An unbalanced circuit can cause a short circuit to occur causing possible harm and electricution to an individual.

#### Relative humidity

The relative humidity of an air/water vapour mixture is the ratio of the vapour pressure existing to the saturated vapour pressure for the same dry-bulb temperature. Expressed as a percentage.

#### SAP

Standard Assessment Procedure. An assessment of the energy efficiency and carbon index of a new dwelling. SAP energy ratings are part of the Building Regulations.

#### SBEM

Simplified Building Energy Model. A tool used to calculate the energy performance of non-domestic buildings to assist compliance with Approved Document L of the Building Regulations.

#### SELV

Safety Extra Low Voltage fans use a 12 or 24volt electrical supply which means that they can be safely installed within a zone 1 area specified by the IEE Wiring Regulations.

#### Specific Fan Power (SFP)

The efficiency of a fan may be described by a numerical value calculated by dividing the operating watts (w) by the air flow rate in L/sec at that power. The value is not fixed and will vary with the fluctuating duty/air flow of the fan. ie: A fan operating at 10 watts with an air flow rate of 25 l/sec would have an SFP 0.4 w/L/sec.

#### Standard conditions (STP)

The standard temperature and pressure used to define STANDARD AIR, which has a density of 1.2 kg/m<sup>3</sup> (16°C and 1000 mbar at 55% RH).

#### TER/DER

Predictions of Carbon Dioxide emissions in a new dwelling are calculated as a target value. (TER). A dwellings actual, as built, emission rate (DER) is based on all the elements included, i.e: 'U' Values, heating, lighting, overheating and fabric construction. DER should not exceed TER or the building will fail under SAP.

#### Terminal

One outlet of a ductwork system. Generally the entrance from which air is supplied to a room and the point at which a grille is fixed.

#### 'U' Value

A measure of the thermal performance of a building envelope. The higher the value the worse the thermal efficiency.

#### Velocity

The speed and direction at which an airstream passes a reference point. Usually the direction is implicit, e.g. velocity in a duct or out of a jet. Otherwise the direction should be stated, e.g. 5 knots NNW.

#### Venturi

A venturi is used as a means of metering fluid flow, and consists of a combination of converging and diverging tapers, connected by a short straight pipe known as the throat. The flow rate is related to the pressure difference between tappings at the throat and in the upstream pipe.

#### WEEE

Waste Electrical and Electronic Equipment directive.

#### Yaw

The horizontal angle an instrument makes to the axis of flow.

\*Note: For guidance only. E&OE



# Index

## Residential Fans

Ventilation for the home

Category D and V

Part No.	Ref	Description	Page	Part No.	Ref	Description	Page
<b>AURA ECO</b>				<b>AURA IN-LINE</b>			
9041347	AUE100B	100mm Basic	34-35	9041355	AUINL100B	100mm In-line Fan with Bracket	40-41
9041348	AUE100T	100mm Timer	34-35	9041356	AUINL100T	100mm In-line Fan with Bracket & Timer	40-41
9041349	AUE100HT	100mm Humidity/Timer	34-35	<b>AURA FAN WITH SHOWER KIT</b>			
9041350	AUE100MST	100mm Motion Sensor/Timer	34-35	9041420	AUSHWKT	100mm In-line Shower Fan Kit Basic	42-43
90000532	AUE125B	125mm Basic	36-37	9041419	AUSHWTKT	100mm In-line Shower Fan Kit Timer	42-43
90000533	AUE125T	125mm Timer	36-37	9041422	AUSHWLTKT	100mm In-line Shower Fan Kit Basic with Light	42-43
90000534	AUE125HT	125mm Humidity/Timer	36-37	9041421	AUSHWTLTKT	100mm In-Line Shower Fan Kit Timer with Light	42-43
90000535	AUE125MST	125mm Motion Sensor/Timer	36-37	<b>AURA SMART</b>			
9041351	AUE150B	150mm Basic	38-39	90000384	AUSH	100/125mm Humidity/Timer	44-45
9041352	AUE150T	150mm Timer	38-39	90000385	AUSMSHT	100/125mm Motion Sensor Humidity/Timer	44-45
9041353	AUE150HT	150mm Humidity/Timer	38-39	90000386	ACVMB	Marble Cover - HT	44-45
9041354	AUE150MST	150mm Motion Sensor/Timer	38-39	90000387	ACVSV	Silver Cover - HT	44-45
<b>MAXIVENT-ECO</b>				90000388	ACVCH	Champagne Cover -HT	44-45
9041497	QT120B	120mm Basic fan (no delay) choice of 2 speeds	48-49	90000389	ACVRD	Red Cover - HT	44-45
9041498	QT120T	120mm Eco start after 2 minutes, choice of two speeds, adjustable timer	48-49	90000390	ACVMV	Mauve Cover - HT	44-45
9041499	QT120HT	120mm Eco start after 2 minutes, two speed, adjustable humidity and timer	48-49	90000391	ACVGR	Graphite Cover - HT	44-45
9041500	QT120MST	120mm Two speed, motion sensor, adjustable timer	48-49	90000392	ACVBK	Black Cover - HT	44-45
90000454	QT150B	150mm Basic Fan (no delay) choice of two speeds	50-51	90000416	ACNMMB	Marble Cover - MSHT	44-45
90000455	QT150T	150mm Eco start after 2 minutes, choice of 2 speed, adjustable timer	50-51	90000417	ACVMSV	Silver Cover - MSHT	44-45
90000456	QT150HT	150mm Eco start after 2 minutes,choice of 2 speed, adjustable humidity and timer	50-51	90000418	ACVMCH	Champagne Cover - MSHT	44-45
90000458	QT150VS	150mm Variable speed from 50 – 260m3/h by remote switch	50-51	90000419	ACVMRD	Red Cover - MSHT	44-45
<b>ICON</b>				90000420	ACVMMV	Mauve Cover - MSHT	44-45
72678201	MV150 eco P	150mm Eco motor - Wall/ceiling auto shutter and pull cord	52-53	90000421	ACVMGR	Graphite Cover - MSHT	44-45
72678301	MV150 eco T	150mm Eco motor - Wall/ceiling auto shutter with timer	52-53	90000422	ACVMBK	Black Cover - MSHT	44-45
72678401	MV150 eco H	150mm Eco motor - Wall/ceiling auto shutter integral h/stat/pull cord	52-53	<b>QUIETAIR</b>			
<b>ICON S eco</b>				72683501	iC15	100mm iCON15	56-57
72683701	iC eco 15S	100mm iCON eco15,dc low energy fan with Compact transformer	62-63	72591601	iC30	100mm iCON30	58-59
72683801	iC eco 30S	100mm iCON eco30,dc low energy fan with Compact transformer	64-65	72591701	iC60	150mm iCON60	60-61
<b>iCON Low Energy - NEW</b>				<b>ICON S 240V MODULES</b>			
72687121	iC 15 eco	100mm iCON eco15,dc low energy fan	66-67	72573602	PCM	Pull Cord Module	72
72687122	iC 30 eco	100mm iCON eco30,dc low energy fan	68-69	72612601	TM	Adjustable Timer Module	72
72687123	iC 60 eco	150mm iCON eco60,dc low energy fan	70-71	72687103	HTM	Humidity, Pull Cord with Timer overrun Module	72
<b>ICON 240V MODULES</b>				72687104	PRTM	Passive Infra Red with Timer overrun Module	72
72573602	PCM	Pull Cord Module	72	72687102	PRHTM	Passive Infra Red/Humidity/Timer Module	72
72612601	TM	Adjustable Timer Module	72	72675701	CV2	iCON Continuous Ventilation Module at 8 l/sec or 13 l/sec	72
72687103	HTM	Humidity, Pull Cord with Timer overrun Module	72	72675702	DTM	iCON Module - Delayed Timer start AC	72
72687104	PRTM	Passive Infra Red with Timer overrun Module	72	72675703	2SHM	iCON Module 2 speed, Humidity, Pull Cord boost AC	72
72687102	PRHTM	Passive Infra Red/Humidity/Timer Module	72	<b>ICON SELV MODULES</b>			
72675701	CV2	iCON Continuous Ventilation Module at 8 l/sec or 13 l/sec	72	72573603	PCS	Pull Cord Module	72
72675702	DTM	iCON Module - Delayed Timer start AC	72	72574204	PCTS	Pull Cord with adjustable Timer Module	72
72675703	2SHM	iCON Module 2 speed, Humidity, Pull Cord boost AC	72	72574202	HTS	Humidity, Pull Cord with Timer overrun Module	72
<b>LOOVENT eco</b>				72574203	PRTS	Passive Infra Red with Timer overrun Module	72
72684305	LVECOT	Loovent ecoTimer	78-79	72574201	PRHTS	Passive Infra Red/Humidity/Timer Module	72
72684306	LVECOHT	Loovent eco Humidity/Timer	78-79	72682307	DTS	Self Delay Start/Timer	72
72684307	LVECOMST	Loovent eco Motion Sensor/Timer	78-79	<b>ICON LOW ENERGY MODULES</b>			
<b>AVENTA IN-LINE COMMERCIAL</b>				72687127	PCE	Pull Cord Module	73
9041089	AV150B	150mm Mixed flow in-line fan 2 speed	94-95	72687128	TE	Adjustable Timer Module	73
9041090	AV150T	150mm Mixed flow in-line fan 2 speed with timer	94-95	72687129	HTE	Humidity, Pull Cord with Timer overrun Module	73
<b>AVENTA SILENT</b>				72687130	MSTE	Motion sensor with Timer overrun Module	73
90000358	AVS100	100mm Mixed flow in-line fan 2 speed	96-97	72687131	MSHTE	Motion sensor/Humidity/Timer Module	73
90000359	AVS125	125mm Mixed flow in-line fan 2 speed	96-97	72687132	CV2E	iCON Continuous Ventilation Module at 8 l/sec or 13 l/sec	73
90000360	AVS150	150mm Mixed flow in-line fan 2 speed	96-97	72687133	DTE	iCON Module - Delayed Timer start AC	73
90000361	AVS200	200mm Mixed flow in-line fan 2 speed	96-97	72687134	2SHE	iCON Module - 2 speed, Humidity, Pull Cord boost AC	73
<b>AVENTA TURBO</b>				<b>LOOVENTS</b>			
9041360	AVT100B	100mm B Aventa Turbo - 250 m³/hr	98-99	71766401	TM (01)	100mm Adjustable timer-light/door switch operation	82-83
9041361	AVT125B	125mm B Aventa Turbo - 365 m³/hr	98-99	<b>ROOMVENTS</b>			
9041362	AVT150B	150mm B Aventa Turbo - 495 m³/hr	98-99	71616301	T (07)	100mm Integral adjustable timer, two room ventilation, for light or door switch operation	84-85
9041363	AVT200B	200mm B Aventa Turbo - 790 m³/hr	98-99	71616501	WFT	100mm Integral adjustable timer, for light or door switch operation. Two room option	84-85
9041364	AVT250B	250mm B Aventa Turbo - 1150 m³/hr	98-99	<b>SUPERVENT</b>			
9041365	AVT315B	315mm B Aventa Turbo - 1325 m³/hr	98-99	71908801	SV6	100mm Two speed manual control (remote switch)	86-87
<b>AVENTA IN-LINE WITH SHOWER KIT</b>				71939302	SV6HP	100mm Auto 2 speed, inbuilt humidistat, pull cord boost override	86-87
9041407	AVSHWTKT	100mm In-line shower kit with timer	90-91	72357001	SV6T	100mm Adjustable volume/adjustable timer	86-87
9041408	AVSHWLTKT	100mm In-line shower kit with timer and light	90-91	<b>AVENTA IN-LINE</b>			
9041406	AVPSHWTKT	125mm In-line shower kit with timer	90-91	9041085	AV100	100mm Mixed flow in-line fan 2 speed	88-89
<b>LOOVENT eco SELV</b>				9041086	AV100T	100mm Mixed flow in-line fan 2 speed with timer	88-89
72684309	LVECOST	Loovent eco SELV Timer	78-79	9041087	AV125	125mm Mixed flow in-line fan 2 speed	88-89
72684310	LVECOSHT	Loovent eco SELV Humidity/Timer	78-79	9041088	AV125T	125mm Mixed flow in-line fan 2 speed with timer	88-89
72684308	LVECOD	Loovent eco dMEV CV Timer	80-81	<b>AVENTA IN-LINE WITH SHOWER KIT</b>			
72684311	LVECODHT	Loovent eco dMEV Humidity/Timer	80-81	9041407	AVSHWTKT	100mm In-line shower kit with timer	90-91
72684312	LVECODST	Loovent eco dMEV SELV Timer	80-81	9041408	AVSHWLTKT	100mm In-line shower kit with timer and light	90-91
72684313	LVECODSHT	Loovent eco dMEV SELV Humidity/Timer	80-81	9041406	AVPSHWTKT	125mm In-line shower kit with timer	90-91

Part No.	Ref	Description	Page	Part No.	Ref	Description	Page
<b>ICON SELV MODULES</b>				<b>LOOVENT eco SELV</b>			
72573603	PCS	Pull Cord Module	72	72684309	LVECOST	Loovent eco SELV Timer	78-79
72574204	PCTS	Pull Cord with adjustable Timer Module	72	72684310	LVECOSHT	Loovent eco SELV Humidity/Timer	78-79
72574202	HTS	Humidity, Pull Cord with Timer overrun Module	72	72684308	LVECOD	Loovent eco dMEV CV Timer	80-81
72574203	PRTS	Passive Infra Red with Timer overrun Module	72	72684311	LVECODHT	Loovent eco dMEV Humidity/Timer	80-81
72574201	PRHTS	Passive Infra Red/Humidity/Timer Module	72	72684312	LVECODST	Loovent eco dMEV SELV Timer	80-81
72682307	DTS	Self Delay Start/Timer	72	72684313	LVECODSHT	Loovent eco dMEV SELV Humidity/Timer	80-81
<b>ICON LOW ENERGY MODULES</b>				<b>LOOVENTS</b>			
72687127	PCE	Pull Cord Module	73	71766401	TM (01)	100mm Adjustable timer-light/door switch operation	82-83
72687128	TE	Adjustable Timer Module	73	<b>ROOMVENTS</b>			
72687129	HTE	Humidity, Pull Cord with Timer overrun Module	73	71616301	T (07)	100mm Integral adjustable timer, two room ventilation, for light or door switch operation	84-85
72687130	MSTE	Motion sensor with Timer overrun Module	73	71616501	WFT	100mm Integral adjustable timer, for light or door switch operation. Two room option	84-85
72687131	MSHTE	Motion sensor/Humidity/Timer Module	73	<b>SUPERVENT</b>			
72687132	CV2E	iCON Continuous Ventilation Module at 8 l/sec or 13 l/sec	73	71908801	SV6	100mm Two speed manual control (remote switch)	86-87
72687133	DTE	iCON Module - Delayed Timer start AC	73	71939302	SV6HP	100mm Auto 2 speed, inbuilt humidistat, pull cord boost override	86-87
72687134	2SHE	iCON Module - 2 speed, Humidity, Pull Cord boost AC	73	72357001	SV6T	100mm Adjustable volume/adjustable timer	86-87
<b>ICON COVERS</b>				<b>AVENTA IN-LINE</b>			
52634503	iCVA15	iCON15 cover Anthracite	73	9041085	AV100	100mm Mixed flow in-line fan 2 speed	88-89
52634504	iCVSV15	iCON15 cover Silver	73	9041086	AV100T	100mm Mixed flow in-line fan 2 speed with timer	88-89
52634505	iCVS15	iCON15 cover Sandstone	73	9041087	AV125	125mm Mixed flow in-line fan 2 speed	88-89
52634502	iCVC15	iCON15 cover Chrome	73	9041088	AV125T	125mm Mixed flow in-line fan 2 speed with timer	88-89
52634506	iCVA30	iCON30 cover Anthracite	73	<b>AVENTA IN-LINE WITH SHOWER KIT</b>			
52634507	iCVSV30	iCON30 cover Silver	73	9041407	AVSHWTKT	100mm In-line shower kit with timer	90-91
52634508	iCVS30	iCON30 cover Sandstone	73	9041408	AVSHWLTKT	100mm In-line shower kit with timer and light	90-91
52634509	iCVA60	iCON60 cover Anthracite	73	9041406	AVPSHWTKT	125mm In-line shower kit with timer	90-91
52634510	iCVSV60	iCON60 cover Silver	73	<b>LOOVENT eco</b>			
52634511	iCVS60	iCON60 cover Sandstone	73	72684305	LVECOT	Loovent ecoTimer	78-79
<b>iCONstant</b>				72684306	LVECOHT	Loovent eco Humidity/Timer	78-79
72687117	ICSTT	100mm dMEV Timer	74-77	72684307	LVECOMST	Loovent eco Motion Sensor/Timer	78-79
72687118	ICSTHT	100mm dMEV Humidity/Timer	74-77	<b>Commercial Fans</b>			
<b>LOOVENT eco</b>				Offices, retail, leisure, education			
<b>AVENTA IN-LINE COMMERCIAL</b>				<b>AVENTA TURBO</b>			
9041089	AV150B	150mm Mixed flow in-line fan 2 speed	94-95	9041360	AVT100B	100mm B Aventa Turbo - 250 m³/hr	98-99
9041090	AV150T	150mm Mixed flow in-line fan 2 speed with timer	94-95	9041361	AVT125B	125mm B Aventa Turbo - 365 m³/hr	98-99
<b>AVENTA SILENT</b>				9041362	AVT150B	150mm B Aventa Turbo - 495 m³/hr	98-99
90000358	AVS100	100mm Mixed flow in-line fan 2 speed	96-97	9041363	AVT200B	200mm B Aventa Turbo - 790 m³/hr	98-99
90000359	AVS125	125mm Mixed flow in-line fan 2 speed	96-97	9041364	AVT250B	250mm B Aventa Turbo - 1150 m³/hr	98-99
90000360	AVS150	150mm Mixed flow in-line fan 2 speed	96-97	9041365	AVT315B	315mm B Aventa Turbo - 1325 m³/hr	98-99
90000361	AVS200	200mm Mixed flow in-line fan 2 speed	96-97	<b>QUIETAIR</b>			
<b>LOOVENT eco SELV</b>				9041259	QT100B	100mm Basic fan (no delay) choice of 2 speeds	46-47
72684309	LVECOST	Loovent eco SELV Timer	78-79	9041260	QT100T	100mm Eco start after 2 minutes, choice of two speeds, adjustable timer	46-47
72684310	LVECOSHT	Loovent eco SELV Humidity/Timer	78-79	9041261	QT100HT	100mm Eco start after 2 minutes, two speed, adjustable humidity and timer	46-47
72684308	LVECOD	Loovent eco dMEV CV Timer	80-81	9041262	QT100MST	100mm Two speed, motion sensor, adjustable timer	46-47
72684311	LVECODHT	Loovent eco dMEV Humidity/Timer	80-81	<b>ICON 240V MODULES</b>			
72684312	LVECODST	Loovent eco dMEV SELV Timer	80-81	72573602	PCM	Pull Cord Module	72
72684313	LVECODSHT	Loovent eco dMEV SELV Humidity/Timer	80-81	72612601	TM	Adjustable Timer Module	72

## Commercial Fans

Offices, retail, leisure, education

Category D



## Hand Dryers

Quiet, hygienic and hands free

Category R

Part No.	Ref	Description	Page	Part No.	Ref	Description	Page
<b>ecoDRY Mini Hand Dryers</b>				<b>ecoDRY Hand Dryers</b>			
90000520	E400ABS	Automatic sensor, 900 Watts with heater White ABS Cover	102-103	90000242	E550ABS	Automatic sensor, 550 Watts, White ABS Cover	104-105
90000221	E400SAT	Automatic sensor, 900 Watts with heater, Satin Die Cast Aluminium Cover	102-103	90000243	E550SAT	Automatic sensor, 550 Watts, Satin Die Cast Aluminium Cover	104-105
				90000518	E1100ABS	Automatic sensor, 1100 Watts with heater, Satin Die White ABS Cover	104-105
				90000519	E1100SAT	Automatic sensor, 1100 Watts with heater, Satin Die Cast Aluminium Cover	104-105

## Central Extraction

One fan for multiple rooms, MEV and dMEV

Category W

Part No.	Ref	Description	Page	Part No.	Ref	Description	Page
<b>AIROVENT CENTRAL EXTRACT VENTILATION</b>							
72649401	WHV-8	Three speed AC motor operation up to 335 m³/hr SAP Q Eligible	108-111	72649601	HVS-10	Energy efficient EC motor operation up to 375 m³/hr SAP Q Eligible	108-111
72649501	WHV-8 R	With wireless remote controller & induct humidity sensor SAP Q Eligible	108-111	72649701	HVS-10 R	With wireless remote controller & induct humidity sensor SAP Q Eligible	108-111
90000362	WHV-8/6	Three speed AC motor operation up to 335 m³/hr SAP Q Eligible connects directly to Airflex Pro round semi rigid ducting with 6 spigots	108-111	90000343	HVS-10/6	Energy efficient EC motor operation up to 375M³/h SAP Q Eligible connects directly to Airflex Pro round semi rigid ducting with 6 spigots	108-111
90000363	WHV-8 R/6	With wireless remote controller & induct humidity sensor SAP Q Eligible connects directly to Airflex Pro round semi rigid ducting with 6 spigots	108-111	90000364	HVS-10 R/6	With wireless remote controller & induct humidity sensor SAP Q Eligible connects directly to Airflex Pro round semi rigid ducting with 6 spigots	108-111

## Heat Recovery Ventilation

From a flat to a multi storey office block

Residential Category S  
Commercial Category H

Part No.	Ref	Description	Page	Part No.	Ref	Description	Page
<b>DUPLEXVENT SINGLE ROOM</b>				<b>DUPLEXVENT BV400 (TOP ENTRY)</b>			
<b>DUPLEXVENT UNO DV40</b>				<b>DUPLEXVENT DV250/300/400 (SIDE ENTRY)</b>			
90000400	UNO DV40	3 speed levels, through the wall installation, built-in electric heater, up to 150 m³/hr	120-121	90000312	BV400	3 speed levels + manual/automatic boost with timer, automatic bypass, up to 475 m³/hr	124-127
<b>DUPLEXVENT RESIDENTIAL</b>				<b>DUPLEXVENT DV180/370/510SE (SIDE ENTRY)</b>			
<b>DUPLEXVENT BASIC LINE</b>				<b>DUPLEXVENT DV190/390/520SE (TOP ENTRY)</b>			
<b>DUPLEXVENT DV72 (TOP ENTRY)</b>				<b>DUPLEXVENT DV180/370/510SE (SIDE ENTRY)</b>			
9041322	DV72	5 speed levels, (3 basic + 2 on-demand) up to 280 m³/hr	122-123	90000291	DV190SE	Wall/floor installation, 10 speed digital control with internet and BMS connection, up to 190 m³/hr	158-161
90000209	DV72CS	DV72 for ceiling suspended installation	122-123	90000292	DV390SE	Wall/floor installation, 10 speed digital control with internet and BMS connection, up to 390 m³/hr	158-161
<b>DUPLEXVENT PROFESSIONAL LINE</b>				<b>DUPLEXVENT DV180/370/510SE (SIDE ENTRY)</b>			
<b>DUPLEXVENT DV90SCK (TOP ENTRY)</b>				<b>DUPLEXVENT DV180/370/510SE (SIDE ENTRY)</b>			
9041576	DV90SCKR	Right hand connections with cooker hood incl. grease filter and fire damper, up to 330 m³/hr	132-135	90000294	DV180SE	Ceiling installation, 10 speed digital control with internet and BMS connection, up to 180 m³/hr	162-165
9041577	DV90SCKL	Left hand connections with cooker hood incl. grease filter and fire damper, up to 330 m³/hr	132-135	90000295	DV370SE	Ceiling installation, 10 speed digital control with internet and BMS connection, up to 370 m³/hr	162-165
<b>DUPLEXVENT DV510SE (SIDE ENTRY)</b>				<b>DUPLEXVENT DV180/370/510SE (SIDE ENTRY)</b>			
90000296	DV510SE	Ceiling installation, 10 speed digital control with internet and BMS connection, up to 510 m³/hr	162-165	90000296	DV510SE	Ceiling installation, 10 speed digital control with internet and BMS connection, up to 510 m³/hr	162-165

Part No.	Ref	Description	Page	Part No.	Description	Page
<b>DUPLEXVENT DV96/110/145/200SE (TOP ENTRY)</b>						
90000393	DV96SER	Right hand connections with triple filter, automatic 100% bypass, built-in heater, up to 324 m³/hr	136-139	<b>DUPLEXVENT RESIDENTIAL ACCESSORIES</b>		
90000394	DV96SEL	Left hand connections with triple filter, automatic 100% bypass, built-in heater, up to 324 m³/hr	136-139	<b>CONTROLLERS - SWITCHES - SENSORS</b>		
90000224	DV110SER	Right hand connections with triple filter, automatic 100% bypass, built-in heaters, up to 414 m³/hr	140-143	<b>MANUAL CONTROL SWITCH</b>		
90000225	DV110SEL	Left hand connections with triple filter, automatic 100% bypass, built-in heaters, up to 414 m³/hr	140-143	90000082	3 speed, 100% adjustable (DV72)	170
90000395	DV145SER	Right hand connections with triple filter, automatic 100% bypass, built-in heaters, up to 568 m³/hr	144-147	<b>BOOST SWITCH</b>		
90000396	DV145SEL	Left hand connections with triple filter, automatic 100% bypass, built-in heaters, up to 568 m³/hr	144-147	90000542	Manual boost (1-way)	170
90000157	DV200SER	Right hand connections with triple filter, automatic 100% bypass, built-in heater, up to 828 m³/hr	148-149	<b>ELECTRICAL HUMIDISTAT</b>		
90000158	DV200SEL	Left hand connections with triple filter, automatic 100% bypass, built-in heater, up to 828 m³/hr	148-149	9041570	30-90% rh (volt-free output)	170
<b>DUPLEXVENT DV50/80 (SIDE ENTRY)</b>						
90000003	DV50R	Right hand connections with triple filter, automatic 100% bypass, built-in heater, up to 230 m³/hr	150-153	<b>MANUAL CONTROL SWITCH</b>		
9041558	DV50L	Left hand connections with triple filter, automatic 100% bypass, built-in heater, up to 230 m³/hr	150-153	90000334	3 speed (BV400)	170
90000067	DV80R	Right hand connections with triple filter, automatic 100% bypass, built-in heaters, up to 356 m³/hr	154-157	<b>DIGITAL CONTROLLER</b>		
90000066	DV80L	Left hand connections with triple filter, automatic 100% bypass, built-in heaters, up to 356 m³/hr	154-157	90000336	3 speed LCD display with data logger and weekly programming (BV400)	170
<b>DUPLEXVENT INTERACTIVE LINE</b>						
<b>DUPLEXVENT DV190/390/520SE (TOP ENTRY)</b>						
90000291	DV190SE	Wall/floor installation, 10 speed digital control with internet and BMS connection, up to 190 m³/hr	158-161	<b>PIR MOTION SENSOR</b>		
90000292	DV390SE	Wall/floor installation, 10 speed digital control with internet and BMS connection, up to 390 m³/hr	158-161	51969702	With 3-30 min timer (230v output)	170
90000293	DV520SE	Wall/floor installation, 10 speed digital control with internet and BMS connection, up to 520 m³/hr	158-161	<b>MANUAL CONTROL SWITCH</b>		
<b>DUPLEXVENT DV180/370/510SE (SIDE ENTRY)</b>						
90000294	DV180SE	Ceiling installation, 10 speed digital control with internet and BMS connection, up to 180 m³/hr	162-165	90000408	100% adjustable (DV250/300/400)	170
90000295	DV370SE	Ceiling installation, 10 speed digital control with internet and BMS connection, up to 370 m³/hr	162-165	<b>DIGITAL CONTROLLER</b>		
90000296	DV510SE	Ceiling installation, 10 speed digital control with internet and BMS connection, up to 510 m³/hr	162-165	90000409	Touch screen panel (DV250/300/400)	170
<b>DUPLEXVENT DV180/370/510SE (SIDE ENTRY)</b>						
90000294	DV180SE	Ceiling installation, 10 speed digital control with internet and BMS connection, up to 180 m³/hr	162-165	<b>MANUAL CONTROL SWITCH</b>		
90000295	DV370SE	Ceiling installation, 10 speed digital control with internet and BMS connection, up to 370 m³/hr	162-165	9041219	4 speed, 100% adjustable (DV50/80/90SCK)	170
90000296	DV510SE	Ceiling installation, 10 speed digital control with internet and BMS connection, up to 510 m³/hr	162-165	<b>DIGITAL CONTROLLER</b>		
<b>DUPLEXVENT DV180/370/510SE (SIDE ENTRY)</b>						
90000294	DV180SE	Ceiling installation, 10 speed digital control with internet and BMS connection, up to 180 m³/hr	162-165	90000227	4 speed, 100% adjustable (DV50/80/90SCK)	170
90000295	DV370SE	Ceiling installation, 10 speed digital control with internet and BMS connection, up to 370 m³/hr	162-165	<b>DIGITAL CONTROLLER</b>		
90000296	DV510SE	Ceiling installation, 10 speed digital control with internet and BMS connection, up to 510 m³/hr	162-165	9041082	8 speed, 100% adjustable (DV96/110/145/200SE)	170

Part No.	Description	Page
<b>DUPLEXVENT RESIDENTIAL ACCESSORIES</b>		
<b>CONTROLLERS - SWITCHES - SENSORS</b>		
<b>MANUAL CONTROL SWITCH</b>		
90000082	3 speed, 100% adjustable (DV72)	170
<b>BOOST SWITCH</b>		
90000542	Manual boost (1-way)	170
<b>ELECTRICAL HUMIDISTAT</b>		
9041570	30-90% rh (volt-free output)	170
<b>MANUAL CONTROL SWITCH</b>		
90000334	3 speed (BV400)	170
<b>DIGITAL CONTROLLER</b>		
90000336	3 speed LCD display with data logger and weekly programming (BV400)	170
<b>PIR MOTION SENSOR</b>		
51969702	With 3-30 min timer (230v output)	170
<b>MANUAL CONTROL SWITCH</b>		
90000408	100% adjustable (DV250/300/400)	170
<b>DIGITAL CONTROLLER</b>		
90000409	Touch screen panel (DV250/300/400)	170
<b>MANUAL CONTROL SWITCH</b>		
9041219	4 speed, 100% adjustable (DV50/80/90SCK)	170
<b>DIGITAL CONTROLLER</b>		
90000227	4 speed, 100% adjustable (DV50/80/90SCK)	170
<b>DIGITAL CONTROLLER</b>		
9041082	8 speed, 100% adjustable (DV96/110/145/200SE)	170
<b>ROOM HUMIDITY SENSOR</b>		
90000320	Room rh (0-10v output)	171
<b>DUCT HUMIDITY SENSOR</b>		
90000313	Duct rh (0-10v output)	171
<b>ROOM CO<sub>2</sub> SENSOR</b>		
90000166	Room CO <sub>2</sub> (0-10v output)	171
<b>DUCT CO<sub>2</sub> SENSOR</b>		
90000165	Duct CO <sub>2</sub> (0-10v output)	171
<b>ROOM AIR QUALITY SENSOR</b>		
90000321	Room air quality (0-10v output)	171



Part No.	Description	Page
<b>BUILT-IN HUMIDITY / AIR QUALITY SENSOR</b>		
90000325	Built-in humidity sensor (BV400)	171
90000344	Built-in air quality sensor (BV400)	171
<b>PRESSURE SENSOR</b>		
90000326	For filter monitoring (BV400)	171
<b>DIGITAL CONTROLLER</b>		
90000297	10 speed, incl. internet control (Interactive Line)	171
<b>ROOM CO<sub>2</sub> SENSOR</b>		
9041180	Room CO <sub>2</sub> (LON RS485) (DV96/110/145/200SE)	171
<b>ROOM HUMIDITY SENSOR</b>		
9041181	Room rh (4-20mA output) (DV96/110/145/200SE)	171
<b>FILTERS</b>		
<b>FILTER PACK</b>		
90000410	2 x G4 filter (DV250)	172
90000411	2 x G4 filter (DV300)	172
90000412	2 x G4 filter (DV400)	172
90000214	2 x G4 / 1 x F7 (DV50)	172
90000213	2 x G4 / 1 x F7 (DV80)	172
9041127	2 x G4 / 1 x F7 (DV90SCK)	172
90000375	2 x G4 / 1 x F7 (DV96SE)	172
90000378	2 x G4 / 1 x F7 (DV110SE)	172
90000376	2 x G4 / 1 x F7 (DV145SE)	172
90000374	2 x G4 / 1 x F7 (DV200SE)	172
9041511	2 x G3 filter (DV72)	172
90000322	2 x G4 filter (BV400)	172
90000323	2 x F7 filter (BV400)	172
90000426	2 x G4 filter (DV190SE)	172
90000427	2 x G4 filter (DV390SE)	172
90000428	2 x G4 filter (DV520SE)	172
90000423	2 x G4 filter (DV180SE)	172
90000424	2 x G4 filter (DV370SE)	172
90000425	2 x G4 filter (DV510SE)	172
<b>HEATERS</b>		
<b>ELECTRIC DUCT HEATER</b>		
90000301	125mm, 1.2kW incl. temp. sensor and control switch	173
90000324	160mm, 1.0kW (BV400)	173
90000413	160mm, 0.4kW (DV250)	173
90000414	160mm, 0.7kW (DV300)	173
90000415	160mm, 1.7kW (DV400)	173
90000162	125mm, 0.9kW (DV190SE)	173
90000163	160mm, 1.5kW (DV180/390SE)	173
90000156	200mm, 2.1kW (DV370/520SE)	173
90000173	250mm, 3.0kW (DV510SE)	173
<b>WATER DUCT HEATER</b>		
90000429	125mm, 0.7kW (DV190SE)	173
90000430	160mm, 1.2kW (DV180/390SE)	173
90000431	200mm, 1.7kW (DV370/520SE)	173
90000432	250mm, 2.0kW (DV510SE)	173

Part No.	Description	Page
<b>OTHER COMPONENTS</b>		
<b>LON-CONVERTER</b>		
9041120	For BMS connection (LON)	173
<b>KNX-CONVERTER</b>		
90000226	For BMS connection (KNX)	173
<b>HORIZONTAL CONDENSATE KIT</b>		
90000122	For horizontal installation (DV72CS)	173
<b>METAL CASING</b>		
90000345	Galvanised (DV250)	173
90000347	Galvanised (DV300/400)	173
<b>DUPLEXVENT COMMERCIAL</b>		
<b>DUPLEXVENT FLEXI LINE</b>		
<b>DUPLEXVENT DV1100/1600/2600/3600</b>		
90000183	DV1100 95% thermal efficiency, floor/ceiling installation, internet and BMS connection up to 1100 m <sup>3</sup> /hr	180-181
90000068	DV1600 95% thermal efficiency, floor/ceiling installation, internet and BMS connection up to 1800 m <sup>3</sup> /hr	182-183
90000069	DV2600 95% thermal efficiency, floor/ceiling installation, internet and BMS connection up to 3000 m <sup>3</sup> /hr	184-185
90000070	DV3600 95% thermal efficiency, floor/ceiling installation, internet and BMS connection up to 3800 m <sup>3</sup> /hr	186-187
<b>DUPLEXVENT MULTI LINE</b>		
<b>DUPLEXVENT DV500/1000/1500/2500/3500/5000/6500/8000</b>		
9041571	DV500 95% thermal efficiency, 100% customisation, internet and BMS connection up to 660 m <sup>3</sup> /hr	192-195
9041572	DV1000 95% thermal efficiency, 100% customisation, internet and BMS connection up to 1200 m <sup>3</sup> /hr	192-195
9041573	DV1500 95% thermal efficiency, 100% customisation, internet and BMS connection up to 2200 m <sup>3</sup> /hr	192-195
9041521	DV2500 95% thermal efficiency, 100% customisation, internet and BMS connection up to 3400 m <sup>3</sup> /hr	192-195
9041522	DV3500 95% thermal efficiency, 100% customisation, internet and BMS connection up to 4600 m <sup>3</sup> /hr	192-195
9041523	DV5000 95% thermal efficiency, 100% customisation, internet and BMS connection up to 5750 m <sup>3</sup> /hr	192-195
9041524	DV6500 95% thermal efficiency, 100% customisation, internet and BMS connection up to 7100 m <sup>3</sup> /hr	192-195
9041525	DV8000 95% thermal efficiency, 100% customisation, internet and BMS connection up to 9600 m <sup>3</sup> /hr	192-195
<b>DUPLEXVENT MULTI-N LINE</b>		
<b>DUPLEXVENT DV1500/2500/3500/5000/6500/8000N</b>		
9041533	DV1500N 95% thermal efficiency, 100% customisation, internet / BMS connection, insulated base frame with maintenance doors, up to 2500 m <sup>3</sup> /hr	196-197
9041534	DV2500N 95% thermal efficiency, 100% customisation, internet / BMS connection, insulated base frame with maintenance doors, up to 3650 m <sup>3</sup> /hr	196-197
9041535	DV3500N 95% thermal efficiency, 100% customisation, internet / BMS connection, insulated base frame with maintenance doors, up to 4700 m <sup>3</sup> /hr	196-197

Part No.	Description	Page
9041536	DV5000N 95% thermal efficiency, 100% customisation, internet / BMS connection, insulated base frame with maintenance doors, up to 5500 m <sup>3</sup> /hr	196-197
9041520	DV6500N 95% thermal efficiency, 100% customisation, internet / BMS connection, insulated base frame with maintenance doors, up to 7200 m <sup>3</sup> /hr	196-197
9041532	DV8000N 95% thermal efficiency, 100% customisation, internet / BMS connection, insulated base frame with maintenance doors, up to 8800 m <sup>3</sup> /hr	196-197
<b>DUPLEX ROTO coming soon</b>		
A new generation in Mechanical Ventilation with Heat Recovery		198-199
<b>DUPLEXVENT COMMERCIAL ACCESSORIES</b>		
<b>FLEXI LINE ACCESSORIES</b>		
<b>EXTRACT AIR FILTER</b>		
90000174	M5 filter (DV1100)	204
90000083	M5 filter (DV1600)	204
90000085	M5 filter (DV2600)	204
90000139	M5 filter (DV3600)	204
<b>SUPPLY AIR FILTER</b>		
90000175	F7 filter (DV1100)	204
90000084	F7 filter (DV1600)	204
90000086	F7 filter (DV2600)	204
90000140	F7 filter (DV3600)	204
<b>FLEXIBLE CONNECTOR</b>		
90000169	250mm connection (DV1100)	204
90000095	315mm connection (DV1600)	204
90000096	500 x 250mm connection (DV2600)	204
90000134	600 x 300mm connection (DV3600)	204
<b>SHUT-OFF DAMPER WITH SPRING RETURN</b>		
90000172	250mm connection (DV1100)	204
90000098	315mm connection (DV1600)	204
90000100	500 x 250mm connection (DV2600)	204
90000137	600 x 300mm connection (DV3600)	204
<b>SHUT-OFF DAMPER WITHOUT SPRING RETURN</b>		
90000181	250mm connection (DV1100)	204
90000097	315mm connection (DV1600)	204
90000099	500 x 250mm connection (DV2600)	204
90000182	600 x 300mm connection (DV3600)	204
<b>ELECTRIC DUCT HEATER</b>		
90000173	3.0kW, 250mm connection (DV1100)	204
90000091	6.0kW, 315mm connection (DV1600)	204
90000092	10.5kW, 500 x 250mm connection (DV2600)	204
90000138	13.5kW, 600 x 300mm connection (DV3600)	204
<b>WATER HEATING COIL + DUCT TEMP. SENSOR (F/S)</b>		
90000200	5.4kW at 60/40°C (DV1100)	204
90000202	7.8kW at 60/40°C (DV1600)	204
90000204	12.0kW at 60/40°C (DV2600)	204
90000206	16.0kW at 60/40°C (DV3600)	204

Part No.	Description	Page
<b>WATER HEATING COIL + DUCT TEMP. SENSOR (C/S)</b>		
90000201	5.4kW at 60/40°C (DV1100)	205
90000203	7.8kW at 60/40°C (DV1600)	205
90000205	12.0kW at 60/40°C (DV2600)	205
90000207	16.0kW at 60/40°C (DV3600)	205
<b>HYDRAULIC KIT (WATER HEATER) INCLUDING 4-WAY VALVE WITH MIXING PUMP AND ACTUATOR</b>		
90000105	Hydraulic kit for water heater (all units)	205
<b>WATER COOLING COIL + DUCT TEMP. SENSOR + RD-IO CIRCUIT BOARD + FREE CHAMBER (F/S)</b>		
90000192	3.4kW at 6/12°C (DV1100)	205
90000194	4.8kW at 6/12°C (DV1600)	205
90000196	7.5kW at 6/12°C (DV2600)	205
90000198	11.0kW at 6/12°C (DV3600)	205
<b>WATER COOLING COIL + DUCT TEMP. SENSOR + RD-IO CIRCUIT BOARD + FREE CHAMBER (C/S)</b>		
90000193	3.4kW at 6/12°C (DV1100)	205
90000195	4.8kW at 6/12°C (DV1600)	205
90000197	7.5kW at 6/12°C (DV2600)	205
90000199	11.0kW at 6/12°C (DV3600)	205
<b>HYDRAULIC KIT (WATER COOLER) INCLUDING 3-WAY VALVE AND ACTUATOR</b>		
90000161	Hydraulic kit for water cooler (all units)	205
<b>WATER HEATING/COOLING COILS + DUCT TEMP. SENSOR + RD-IO CIRCUIT BOARD (F/S)</b>		
90000184	5.4kW at 60/40°C, 3.4kW at 6/12°C (DV1100)	205
90000186	7.8kW at 60/40°C, 4.8kW at 6/12°C (DV1600)	205
90000188	12.0kW at 60/40°C, 7.5kW at 6/12°C (DV2600)	205
90000190	16.0kW at 60/40°C, 11.0kW at 6/12°C (DV3600)	205
<b>WATER HEATING/COOLING COILS + DUCT TEMP. SENSOR + RD-IO CIRCUIT BOARD (C/S)</b>		
90000185	5.4kW at 60/40°C, 3.4kW at 6/12°C (DV1100)	205
90000187	7.8kW at 60/40°C, 4.8kW at 6/12°C (DV1600)	205
90000189	12.0kW at 60/40°C, 7.5kW at 6/12°C (DV2600)	205
90000191	16.0kW at 60/40°C, 11.0kW at 6/12°C (DV3600)	205
<b>RD-IO CIRCUIT BOARD</b>		
90000094	Additional PCB (all units)	205
<b>DX COIL (F/S)</b>		
90000178	DX (direct expansion) coil (DV1100)	205
90000147	DX (direct expansion) coil (DV1600)	205
90000149	DX (direct expansion) coil (DV2600)	205
90000151	DX (direct expansion) coil (DV3600)	205
<b>DX COIL (C/S)</b>		
90000179	DX (direct expansion) coil (DV1100)	206
90000148	DX (direct expansion) coil (DV1600)	206
90000150	DX (direct expansion) coil (DV2600)	206
90000152	DX (direct expansion) coil (DV3600)	206



Part No.	Ref	Description	Page
<b>FREE CHAMBER FOR WATER / DX COOLING COILS</b>			
90000180		Free chamber (DV1100)	206
90000153		Free chamber (DV1600)	206
90000154		Free chamber (DV2600)	206
90000155		Free chamber (DV3600)	206
<b>CONSTANT FLOW KIT (INCLUDING TWO PRESSURE SENSORS)</b>			
90000093		Constant flow kit (DV1100/1600/2600)	206
90000167		Constant flow kit (DV3600)	206
<b>CONSTANT PRESSURE BOX</b>			
90000208		Constant pressure box (all units)	206
<b>VDI 6022 HYGIENE PACK WITH INCLINED TUBE MANOMETERS</b>			
90000090		VDI 6022 hygiene pack (all units)	206

Part No.	Ref	Description	Page
<b>DUCT TEMPERATURE SENSOR</b>			
90000089		Duct temp. (0-24v output) (all units)	206
<b>ROOM HUMIDITY SENSOR</b>			
90000320		Room rh (0-10v output) (all units)	206
<b>DUCT HUMIDITY SENSOR</b>			
90000313		Duct rh (0-10v output) (all units)	206
<b>ROOM CO<sub>2</sub> SENSOR</b>			
90000166		Room CO <sub>2</sub> (0-10v output) (all units)	206
<b>DUCT CO<sub>2</sub> SENSOR</b>			
90000165		Duct CO <sub>2</sub> (0-10v output) (all units)	206
<b>ROOM AIR QUALITY SENSOR</b>			
90000321		Room air quality (0-10v output) (all units)	206

Part No.	Ref	Description	Page
90000265	APP-6PDBN	6-Port In-line Distribution Box (sound insulated) (Narrow Type)	216
90000264	APP-6PDB	6-Port In-line Distribution Box (sound insulated)	216
90000270	APO-10PDB	10-Port Distribution Box (sound insulated) (incl. 10 oval spigots, 10 bayonet caps, 20 clips, 4 oval sealing caps)	216
90000266	APR-10PDB	10-Port Distribution Box (sound insulated) (incl. 10 round spigots, 10 bayonet caps, 20 clips, 4 round sealing caps)	216
90000269	APR-15PDB	15-Port Distribution Box (sound insulated) (incl. 15 round spigots, 15 bayonet caps, 30 clips, 4 round sealing caps)	216
90000443		Combi Distribution Box (L/H) sound insulated extracts from 100mm connects to AirflexPro round 75mm	216
90000444		Combi Distribution Box (R/H) sound insulated extracts from 100mm connects to AirflexPro round 75mm	216

Part No.	Description	Page
9021290	152mm x 10m length PVC external aluminium internal	222
9021295	200mm x 5m length PVC external aluminium internal	222
9021288	200mm x 6m length PVC external aluminium internal	222
9021291	200mm x 10m length PVC external aluminium internal	222

### AIRFLEX RE-ENFORCED ALUMINIUM FLEXIBLE DUCTING

9021311	100mm x 3m length re-enforced aluminium flexible foil	223
9021315	100mm x 5m length re-enforced aluminium flexible foil	223
9021318	100mm x 10m length re-enforced aluminium flexible foil	223
9021312	150mm x 3m length re-enforced aluminium flexible foil	223
9021316	150mm x 5m length re-enforced aluminium flexible foil	223
9021320	150mm x 10m length re-enforced aluminium flexible foil	223
9021313	200mm x 3m length re-enforced aluminium flexible foil	223
9021317	200mm x 5m length re-enforced aluminium flexible foil	223
9021321	200mm x 10m length re-enforced aluminium flexible foil	223
9021314	300mm x 5m length re-enforced aluminium flexible foil	223

## Accessories

Ducting, grilles, controllers and much more

Category A

Part No.	Ref	Description	Page
<b>AIRFLEXPRO - SEMI RIGID DUCTING SYSTEM</b>			
9041130	VFS7563	75mm OD 63mm ID x 50m coil Airflex Pro	210
90000352		AirflexPro Duct Clip (pack of 10)	211
<b>AIRFLEXPRO OVAL - SEMI RIGID DUCTING SYSTEM</b>			
90000255	APO51x115	54mm x 114mm Airflex Pro Oval Coil (20m)	210
90000353		AirflexPro Oval Duct Clips (pack of 10)	211
<b>AIRFLEXPRO ACCESSORIES</b>			
9041133	VDR7563	75mm sealing rings (pack of 10)	214
9041131	VRK7563	75mm Hygienic cap for AirflexPro pipe	213
90000260	APR-RS75	Round Spigots for Distribution Box (incl. 2 clips)	214
90000256	APR-SC75	78mm Sealing Cap for Ceiling/Wall Plenum	214
<b>AIRFLEXPRO CONNECTION PIECES</b>			
9041132	VSV7563	75mm AirflexPro Connector 9041139	213
	VKB7590	75mm AirflexPro Compact bend 90° - allows very small bending radius of pipe	213
<b>AIRFLEXPRO CEILING, FLOOR &amp; WALL OUTLETS</b>			
9041141	VVA75101	Straight ceiling outlet with 2 spigots for 75mm piping and one spigot (nominal diameter 125) for extract or supply air valve, max. air volume 40-60 m <sup>3</sup> /hr (dependent on valve type), one hygienic cap 75mm included	213
9041142	VAT75-1	90° floor outlet with 2 spigots for 75mm piping and one spigot (nominal diameter 140) for floor grill type BGE 160-1; max. 60 m <sup>3</sup> /hr air flow, one hygienic cap 75mm included	213
9041143	VWD7500	Straight wall-outlet, with 2 spigots for 75mm piping and 200x50mm opening for fin grill type LGA, max. 60 m <sup>3</sup> /hr	213
9041144	VWD7590	90° wall-outlet, with 2 spigots for 75mm piping and 200x50mm opening for fin grill type LGA, max. 60 m <sup>3</sup> /hr	213
90000440		300 x 100mm Stainless Steel Floor Grille	213
90000441		90° Floor Outlet (2 x 75mm)	213

Part No.	Ref	Description	Page
90000250	APR-CP75	78mm 90° Ceiling/Wall Plenum (incl. 4 clips, 1 sealing cap)	215
90000525		90° Wall / Floor / Ceiling Outlet (2 x 54mm x 117mm)	213
90000526		White Powder Coated Grill – Slotted	213
90000527		White Powder Coated Grill – Squared	213
90000528		White Powder Coated Grill – Wavy	213
90000529		Brushed Stainless Steel Grill – Slotted	213
90000530		Brushed Stainless Steel Grill – Squared	213
90000531		Brushed Stainless Steel Grill – Wavy	213
<b>AIRFLEXPRO OVAL ACCESSORIES</b>			
90000254	APO-SR51	54mm x 117mm Sealing Rings (pack of 10)	214
90000259	APO-OS51	Oval Spigots For Distribution Box (incl. 2 clips)	214
90000258	AP-BACAP	96mm Bayonet Cap for Distribution Box	214
90000261	AP-SHC	Spare Holding Clips (pack of 10)	214
90000257	APO-SC51	54mm x 117mm Sealing Cap for Ceiling/Wall Plenum	214
90000249	APO-CP51	54mm x 117mm 90° Ceiling/Wall Plenum (incl. 4 clips, 1 sealing cap)	215
90000267	AP-SC125	125mm Sealing Cap for Distribution Box	214
<b>AIRFLEXPRO OVAL CONNECTION PIECES</b>			
90000247	APO-VE51	54mm x 117mm 90° Vertical Elbow (incl. 4 clips)	215
90000251	AP-90TP	90° Transition Piece (round-oval) (incl. 4 clips)	215
90000252	AP-STP	Straight Transition Piece (round-oval) (incl. 4 clips)	215
90000253	APO-SCN51	54mm x 117mm Straight Connector (incl. 4 clips)	215
90000248	APO-HE51	54mm x 117mm 90° Horizontal Elbow (incl. 4 clips)	215
<b>AIRFLEXPRO DISTRIBUTION BOXES</b>			
90000262	APO-5PDB	5-Port Distribution Box (sound insulated) (incl. 5 oval spigots, 5 bayonet caps, 10 clips, 2 oval sealing caps, 1 (125mm) sealing cap)	216
90000263	APR-5PDB	5-Port Distribution Box (sound insulated) (incl. 5 round spigots, 5 bayonet caps, 10 clips, 2 round sealing caps, 1 (125mm) sealing cap)	216

Part No.	Description	Page
<b>AIRFLOW RETRO DUCTING</b>		
90000275	Combi Distribution Box 125/100/100 Dia (R/H)	218
90000276	Combi Distribution Box 125/100/100 Dia (L/H)	218
90000277	1m Duct with Stucco Profile (box of 4)	218
90000278	Long Connector Set 100mm ø (with clamp)	218
90000279	T Section with Stucco Profile 100/100/100mm (box of 4)	218
90000280	Short Connector 100mm ø	218
90000281	Inner Angle with Stucco Profile 100/100mm (box of 2)	219
90000282	Combi Distribution Box Sealing Cap 100mm ø	219
90000283	Outer Angle with Stucco Profile (box of 2)	219
90000284	Wall Connecting Pipe 100mm ø PVC	219
90000445	1m Duct with Square Profile (box of 4)	219
90000285	Coanda Effect Valve for Sup 100mm ø	219
90000315	Retro Ext/Sup Valve 100mm ø c/w Filter (90000317)	219
90000439	Retro Ext/Sup Valve 100mm ø c/w Filter (90000317)	219
90000446	T Piece with Square Profile 100/100/100mm (box of 4)	219
90000447	Inner Angle with Square Profile 100/100mm (box of 2)	219
90000448	Outer Angle with Square Profile 100/100mm (box of 2)	219
90000449	Retro Wall Outlet (shrouded) Brushed Aluminium for 125mm connection	219

### AIRFLEX RE-ENFORCED ALUMINIUM INSULATED FLEXIBLE DUCTING

52662701	102mm x 10m length re-enforced aluminium insulated flexible foil	223
52662702	127mm x 10m length re-enforced aluminium insulated flexible foil	223
52662703	152mm x 10m length re-enforced aluminium insulated flexible foil	223
90000503	160mm x 10m length re-enforced aluminium insulated flexible foil	223
90000504	180mm x 10m length re-enforced aluminium insulated flexible foil	223

### AIRFLAT DUCTING 204mm x 60mm

52641201	204 x 60 x 1m flat channel ducting	224
52641202	204 x 60 x 1.5m flat channel ducting	224
52641301	204 x 60 x 100mm Elbow/Plenum	224
9041200	204 x 60 x 125mm Elbow/Plenum	224
52641302	204 x 60 x 150mm Elbow/Plenum	224
52641401	204 x 60 90° Horizontal Bend	224
52641501	204 x 60 Flexible Jointing Piece	224
52641601	204 x 60 90° Vertical Bend	224
52641701	204 x 60 Straight Connector	224
52641801	204 x 60 Equal Horizontal T Piece	224
52641901	204 x 60 Flat Channel Clip	224
51980001	204 x 60 x 125mm round to rectangular horizontal adapter	224
90000356	380ml Grey Acrylic Duct Sealant	225

### AIR ROUND RIGID DUCTING

9021378	100mm x 350mm round pipe	225
90000048	100mm x 1m round pipe	225
90000051	100mm x 2m round pipe	225
9041220	125mm x 350mm round pipe	225
9041547	125mm x 1m round pipe	225
9041543	125mm x 1.5m round pipe	225
9041546	125mm x 2m round pipe	225
9001903	150mm x 350mm round pipe	225
9041546	125mm x 2m round pipe	225
9001903	150mm x 350mm round pipe	225
90000049	150mm x 1m round pipe	225
90000052	150mm x 2m round pipe	225
90000019	100mm round pipe connector	226

### AIRFLEX FLEXIBLE ROUND PVC HOSE

52641005	100mm x 1m length PVC flexible hose	222
52641001	100mm x 3m length PVC flexible hose	222
52641002	100mm x 6m length PVC flexible hose	222
52641006	100mm x 15m length PVC flexible hose	222
52641007	100mm x 45m length PVC flexible hose	222
52641008	125mm x 1m length PVC flexible hose	222
52641009	125mm x 3m length PVC flexible hose	222
9041557	125mm x 6m length PVC flexible hose	222
9041555	150mm x 1m length PVC flexible hose	222
52641003	150mm x 3m length PVC flexible hose	222
52641004	150mm x 6m length PVC flexible hose	222

### AIRFLEX COMBI FLEXIBLE DUCTING

9021285	100mm x 3m length PVC external aluminium internal	222
9021292	100mm x 5m length PVC external aluminium internal	222
9021289	100mm x 10m length PVC external aluminium internal	222
9021286	152mm x 3m length PVC external aluminium internal	222
9021294	152mm x 5m length PVC external aluminium internal	222
9021287	152mm x 6m length PVC external aluminium internal	222

Part No.	Description	Page
52644001	125mm round pipe connector	226
90000058	150mm round pipe connector	226
90000059	200mm round pipe connector	226
51979601	125mm to 100mm straight reducer	226
90000060	150mm to 125mm straight reducer	226
90000061	200mm to 150mm straight reducer	226
52644101	125mm to 100mm offset reducer (for rigid pipe)	226
9041201	125mm x 125mm x 125mm equal round rigid T piece	225
9041461	100mm x 100mm x 100mm equal round rigid T piece	225
9041545	150mm x 150mm x 150mm equal round rigid T piece	225
90000054	100mm 90° round elbow	225
9041542	125mm 90° round elbow	225
90000055	150mm 90° round elbow	225
9041544	125mm 45° round bend	225
9041556	125mm Y piece	225

### DUCT INSULATION

90000010	Insulation for 75mm AirflexPro - 295mm x 25mm	226
90000011	Insulation for 100mm Airound - 345mm x 12.5mm	226
90000012	Insulation for 125mm Airound - 422mm x 12.5mm	226
90000013	Insulation for 150mm Airound - 503mm x 12.5mm	226
90000014	Insulation for 204 x 60mm Airflat - 531mm x 12.5mm	226
90000016	50m Tape (non-hardening adhesive)	226

Part No.	Ref	Description	Page
----------	-----	-------------	------

### AIRFLEX ISO PIPE

9041147	VIR2000/DN125	Ø 125mm x 2000mm ISO pipe	227
90000505		Ø 160mm x 950mm ISO pipe	227
90000465		Ø 160mm x 2000mm ISO pipe	227
9041250		Ø 180mm x 1000mm ISO pipe	227
90000475		Ø 180mm x 2000mm ISO pipe	227

### AIRFLEX ISO CONNECTORS

9041191		Ø 125mm male/male coupling with seals	227
90000469		Ø 160mm male/male coupling with seals	227
9041232		Ø 200mm male/male coupling with seals	227
90000470		Ø 160mm ISO pipe male with seal to Ø125mm	227
90000471		Ø 160mm ISO pipe male with seal to Ø180mm	227
90000480		Ø 180mm to Ø 160mm male/male with seals	227
90000497		Ø 200mm female to Ø 160mm male with seal	227
90000500		Ø 200mm female to Ø 180mm male with seal	227
9041149		Ø 125mm ISO pipe female/female connector	227
90000468		Ø 160mm ISO pipe male/male connector	227
90000478		Ø 180mm ISO pipe male/male connector	227

### AIRFLEX ISO BENDS

9041152		Ø 125mm 90° ISO bend with collar	227
90000467		Ø 160mm 90° ISO bend with collar	227
90000477		Ø 180mm 90° ISO bend with collar	227
9041154		Ø 125mm 45° ISO bend with collar	227
90000466		Ø 160mm 45° ISO bend with collar	227
90000476		Ø 180mm 45° ISO bend with collar	227

Part No.	Description	Page
----------	-------------	------

### SQUARE EXTERNAL GRILLES

52641101	140 x 140 x 100mm Ø Fixed Grille (White)	228
52641102	140 x 140 x 100mm Ø Fixed Grille (Grey)	228
52641103	140 x 140 x 100mm Ø Fixed Grille (Terracotta)	228
52641104	140 x 140 x 100mm Ø Fixed Grille (Brown)	228

Part No.	Description	Page
52641105	140 x 140 x 100mm Ø Fixed Grille (Beige)	228
9021012	140 x 140 x 100mm Ø Fixed Grille (Brown) with F/S	228
9021082	140 x 140 x 100mm Ø Fixed Grille (Terracotta) with F/S	228
9021172	150 x 150 x 100mm Ø Fixed Grille (White) with F/S	228
9041223	160 x 160 x 125mm Ø Fixed Grille Terracotta	228
9041222	160 x 160 x 125mm Ø Fixed Grille Brown	228
9041221	160 x 160 x 125mm Ø Fixed Grille White	228
52641106	180 x 180 x 150mm Ø Fixed Grille (White)	228
52641107	180 x 180 x 150mm Ø Fixed Grille (Grey)	228
52641108	180 x 180 x 150mm Ø Fixed Grille (Terracotta)	228
52641109	180 x 180 x 150mm Ø Fixed Grille (Brown)	228
52641110	180 x 180 x 150mm Ø Fixed Grille (Beige)	228
51791101*	140 x 140 x 100mm Ø Gravity Flap (White)	228
9041468	160 x 160 x 125mm Ø Gravity Flap (White)	228
71984001	180 x 180 x 150mm Ø Gravity Flap (White)	228

### ICON ROUND EXTERNAL GRILLES

72596201	100mm dia. (180mm o/d)(Terracotta)	228
72596202	100mm dia. (180mm o/d) (White)	228
72593101	150mm dia. (240mm o/d) (Terracotta)	228
72593102	150mm dia. (240mm o/d) (White)	228

### AIRBRICKS

52642010	204 x 60mm Terracotta	229
51849605	204 x 60mm Brown	229
52642002	204 x 60mm Buff (Beige)	229
51978701	204 x 60mm with internal damper (White)	229
51978702	204 x 60mm with internal damper (Terracotta)	229
90000076	204 x 60mm Double Airbrick duct adaptor (White)	229
90000077	204 x 60mm Double Airbrick duct adaptor (Terracotta)	229
90000132	204 x 60mm Double Airbrick duct adaptor (Cotswold Stone)	229

### STAINLESS STEEL EXTERNAL GRILLES

52644501	100mm Ø round cowl complete with Internal louvers	229
9041226	125mm Ø round cowl complete with internal louvers	229
52644601	150mm Ø round cowl complete with Internal louvers	229
9041227	180mm Ø round cowl complete with internal louvers	229
52644701	100mm Ø round cowl complete with Internal mesh	229
9041228	125mm Ø round cowl complete with internal mesh	229
52644801	150mm Ø round cowl complete with Internal mesh	229
90000506	160mm Ø round cowl complete with Internal mesh	229
9041229	180mm Ø round cowl complete with internal mesh	229
9041230	125mm Ø square cowl complete with gravity flap	229
9041231	150mm Ø square cowl complete with gravity flap	229

### REGAL SIDE ENTRY COWLS

90000449	To suit 125mm Ø ISO duct	230
90000498	To suit 160mm Ø ISO duct	230
90000501	To suit 180mm Ø ISO duct	230

### REGAL FRONT ENTRY COWLS

90000450	To suit 125mm Ø ISO duct	230
90000499	To suit 160mm Ø ISO duct	230
90000502	To suit 180mm Ø ISO duct	230

### External wall grilles

9041164	160mm Ø dual external grille L/H side connection	230
9041165	160mm Ø dual external grille R/H side connection	230

Part No.	Description	Page
----------	-------------	------

### ACOUSTIC ACCESSORIES

9041323	125mm Acoustic wall kit 30m³/hr Acoustic Vent	231
9041324	125mm Acoustic wall kit 22m³/hr Acoustic Vent	231

### HUMIDITY ACOUSTIC ACCESSORIES

9041306	420x45x64mm Regulated Air Vent	231
---------	--------------------------------	-----

### CIRCULAR ATTENUATORS

90000115	125mm 600mm	231
9541176	125mm 900mm	231
9541177	125mm 1250mm	231

### AIRFLOW AIR VALVES EXTRACT & SUPPLY

9020152	100mm Plastic adjustable air valve extraction	231
9020153	150mm Plastic adjustable air valve extraction	231
9020154	200mm Plastic adjustable air valve extraction	231
90000339	125mm Plastic adjustable air valve directional supply	231
90000340	125mm Plastic adjustable air valve extraction	231
9041168	125mm Metal powder coated adjustable supply air valve	231
9041172	125mm Metal powder coated adjustable extract air valve	231

### AIRFLOW FIRE PROTECTION VALVES

90000126	125mm Fire protection valve for extract and supply	231
----------	--	-----

### SPECIALITY AIR VALVES

9041166	125mm elliptical metal wall extract/supply air valve - White producing the Coanda Effect suitable for Passive House applications	232
9041169	125mm round metal wall/ceiling supply air valve - White	232
9041173	125mm round metal adjustable wall/ceiling extract air valve - White	232
9041174	Adjustable stainless steel floor grille to fit on floor outlet (9041142) - Satin	232
9041175	Adjustable aluminium wall grille to fit on wall outlets (9041143/9041144) also fits to 204mm x 60mm ducting	232
90000315	Stylish Supply Extract Valve 100mm Ø c/w filter	232
90000316	Stylish Supply Extract Valve 125mm Ø c/w filter	232
90000317	Stylish Supply Extract Valve 100mm filter	232
90000318	Stylish Supply Extract Valve 125mm filter	232
90000439	Stylish Supply Extract Valve 100mm Ø c/w filter	232

### AIRFLOW AIRESE ADJUSTABLE AIR VALVES

9041234	Airese 15m³/hr Constant Air flow	233
9041235	Airese 30m³/hr Constant Air flow	233
9041236	Airese 15m³/hr Constant Air flow, Pull Cord Boost to 30m³/hr	233
9041237	Airese 20m³/hr Constant Air flow, Pull Cord Boost to 75m³/hr	233
9041238	Airese 5m³/hr Constant Air flow, Humidity Boost to 45m³/hr	233
9041239	Airese 10m³/hr Constant Air flow, Humidity Boost to 45m³/hr	233
9041240	Airese 12m³/hr/45m³/hr/105m³/hr Air flow Boost Humidity Electric with Timer	233
9041241	Airese 5m³/hr/40m³/hr/100m³/hr Air flow Boost Humidity Electric with 125mm Connector	233
9041242	Airese 6m³/hr/40m³/hr/ 90m³/hr Air flow Boost Humidity Pull Cord	233
9041243	Airese 5m³/hr Air flow Boost Electric to 30m³/hr	233
9041244	Airese 5m³/hr Air flow Boost PIR Batt to 30m³/hr	233
9041245	Airese 125mm reducer to 100mm	233
9041246	Airese 125mm Straight Connector fits all Airese Air Valves	233
9041247	Airese 150mm Straight Connector fits all Airese Air Valves	233
9041248	Airese 125mm Straight Ceiling Connector to give extra grip	233

Part No.	Description	Page
----------	-------------	------

### METAL WORM DRIVE CLAMPS 8MM WIDE

51849402	100mm/4" adjustable 50mm - 110mm	234
51849403	125mm/5" adjustable 60mm - 165mm	234
51849404	150mm/6" adjustable 60mm - 325mm	234

### ROOF COWLS, SLATES, PANTILES, TRAPS, VALVES & OUTLETS

90000349	Universal Roof Terminal & Adaptor - Anthracite	234
90000350	Universal Roof Terminal & Adaptor - Sepia	234
90000351	Universal Roof Terminal & Adaptor - Terracotta	234
9004554	Roof Cowl Grey A.B.S.	234
9004597	450mm square aluminium roof slate (pitched roof)	234
9004598	600mm square aluminium roof slate (pitched roof)	234
51978301	100mm condensation trap	234
52364801	150mm condensation trap	234
51990601	100mm backdraught flap	234
52365001	150mm backdraught flap	234

### VENTING KITS

72643201	Cavity wall kit 100mm Ø rigid duct, round grille and screws - Terracotta	235
72643202	Cavity wall kit 100mm Ø rigid duct, round grille and screws - White	235
72643203	Cavity wall kit 150mm Ø rigid duct, round grille and screws - Terracotta	235
72643204	Cavity wall kit 150mm Ø rigid duct, round grille and screws - White	235
9021451	Cavity wall kit 100mm Ø rigid duct with fitted cowl & rubber seal fitted from inside brown	235
72643601	Flexible duct kit 100mm Ø 3m duct, square grille & screws - Terracotta	235
72643602	Flexible duct kit 100mm Ø 3m duct, square grille & screws - White	235
72643603	Flexible duct kit 150mm Ø 3m duct, square grille & screws - Terracotta	235
72643604	Flexible duct kit 150mm Ø 3m duct, square grille & screws - White	235
90000437	Flexible duct kit 125mm Ø 3m duct, square grille & screws - Terracotta	235
90000438	Flexible duct kit 125mm Ø 3m duct, square grille & screws - White	235
9041183	In-line Flexible duct kit 100mm Ø 6m ducting, (for Aventa/Aventa 100T) c/w exhaust valve, 6m duct, outside gravity flap & circlips	235
9041184	In-line Flexible duct kit 125mm Ø 6m ducting, (for Aventa/Aventa 125T) c/w exhaust valve, 6m duct, outside gravity flap & circlips	235
9041185	In-line Flexible duct kit 150mm Ø 6m ducting, (for Aventa/Aventa 150T) c/w exhaust valve, 6m duct, outside gravity flap & circlips	235

Part No.	Ref	Description	Page
----------	-----	-------------	------

### INTUMESCENT FIRE COLLARS

90000108	INC82	Fire collar (Round) with stainless steel casing 75 - 82mm dia.	236
90000109	INC110	Fire collar (Round) with stainless steel casing 100 - 110mm dia.	236
90000110	INC130	Fire collar (Round) with stainless steel casing 125 - 130mm dia.	236
90000111	INC160	Fire collar (Round) with stainless steel casing 150 - 160mm dia.	236
90000107		Fire collar (Rectangular) with stainless steel casing 205 x 60mm.	236

Part No.	Ref	Description	Page
<b>FLAME STOPPER SAFETY SLEEVE</b>			
Safety sleeve to prevent the spread of fire in HVAC systems. Fits on fans or air valves.			
9041311	FS 80 HC 80mm dia		236
52662301	FS125 HC 125mm dia		236
52662401	FS150 HC 150mm dia		236

<b>REMOTE SWITCHES, CONTROLLERS &amp; SENSORS</b>			
9041575	Air Quality Sensor		236
90000546	Supervent SV6 switch		237
90000547	On/Off with lockable isolator		237
90000548	Supervent SV6 switch with neon		237
90000549	Three position switch with 2 x neon		237
90000550	On/Off with neon and lockable pole isolator switch		237
90000551	On/Off – 2 speed with 2 x neon		237
90000537	Isolation switch		237
90000538	Isolation switch with neon		237
90000539	Isolation switch with neon and fuse		237
90000540	On/Off switch		237
90000541	low and high speed and off switch		237

## Industrial Fans

Blowers, hot air fans, flue dilution, OEM fans

Category F

Part No.	Ref	Description	Page
<b>AC SINGLE INLET FANS</b>			
71144606	21ATXL	Centrifugal fan	246-247
71056108	26BTML	Centrifugal fan	246-247
71923201	26BTCL	Centrifugal fan	246-247
71773305	33BTFL	Centrifugal fan	246-247
71056207	40BTFL	Centrifugal fan	246-247
71399904	45CTL	Centrifugal fan	246-247
71674501	52BTXL	Centrifugal fan	246-247
7492006	52BTXL	Centrifugal fan (Oven Fan)	246-247
71655702	52BTXL	Centrifugal fan (Spear Fan)	246-247
71674701	57BXL	Centrifugal fan	246-247

<b>AC DOUBLE INLET FANS</b>			
72518201	57FTQR/4	Centrifugal fan	248-249
71172316	71E2TIXR/6	Centrifugal fan	248-249

<b>COMPACT FANS</b>			
72371701	ACF120X62L2	Centrifugal fan	250-251

<b>DUPLEX BLOWERS</b>			
71988801	40B2TX/2DUP	Centrifugal fan	252-253

<b>EC SINGLE INLET FANS</b>			
90000365	SIEC 120 x 62	EC Single inlet fan	256-257
90000366	SIEC 133 x 46	EC Single inlet fan	256-257

## Instruments

Air flow and velocity measurement

Category I

Part No.	Ref	Description	Page
<b>LCA301 COMPLIANCE TESTING KIT</b>			
90000017	ANOMACK	LCA301 Anemometer kit UKAS Certified with 285 x 235mm Aircone	268

Part No.	Description	Page
90000542	Momentary boost switch	237
90000543	On/Off switch with neon	237
90000544	Two position switch	237
90000545	Two position switch with neon	237
9041033	Variable speed controller (Maxivent, Supervent and iCON 60 fans)	238
9041565	1 amp electronic illuminated stepless speed controller	238
9041566	1 amp electronic illuminated stepless speed controller reversible	238
9041569	3 amp electronic illuminated stepless speed controller	238
90000514	QuietAir QT150VS controller	238
51969702	PIR Motion Sensor Timer	238
9041570	Electrical humidistat 30% to 90%	238
90000552	Single Gang Back Box 35mm deep	238
90000553	Double Gang Back Box 35mm deep	238

<b>SPEED CONTROLLERS COMMERCIAL</b>			
	Rating		
9021055	1A		238
9021056	3A		238
9021057	6A		238
9021058	10A		238

Part No.	Ref	Description	Page
90000367	SIEC 160 x 62	EC Single inlet fan	256-257
<b>EC DOUBLE INLET FANS</b>			
90000368	DIEC 178	EC Double inlet fan	258-259
90000369	DIEC 215	EC Double inlet fan	258-259
90000370	DIEC 222	EC Double inlet fan	258-259
90000371	DIEC 270	EC Double inlet fan	258-259
90000372	DIEC 178/2	EC Double inlet fan	258-259
90000373	DIEC 215/2	EC Double inlet fan	258-259

<b>FLUE DILUTION FANS</b>			
72546201	GBDF2	Zintec steel flue dilution fan	260-263
72546301	GBDF3	Zintec steel flue dilution fan	260-263
72546401	GBDF4	Zintec steel flue dilution fan	260-263
72546501	GBDF5	Zintec steel flue dilution fan	260-263
72546601	GBDF6	Zintec steel flue dilution fan	260-263
72553201	SSDF2	Stainless steel flue dilution fan	260-263
72553301	SSDF3	Stainless steel flue dilution fan	260-263
72553401	SSDF4	Stainless steel flue dilution fan	260-263
72553501	SSDF5	Stainless steel flue dilution fan	260-263
72553601	SSDF6	Stainless steel flue dilution fan	260-263

<b>HT FANS</b>			
72628701	45BTFRHT	Centrifugal hot fan	264-265
72452903	52BTRHT	Centrifugal hot fan	264-265

# Part Number Index

Part no.	Page	Part no.	Page	Part no.	Page
72683701	62-63	9041133	214	9041247	233
72683801	64-65	9041139	213	9041248	233
7492006	246-247	9041141	213	9041250	227
9001903	225	9041142	213	9041259	46-47
9004554	234	9041143	213	9041260	46-47
9004597	234	9041144	213	9041261	46-47
9004598	234	9041147	227	9041262	46-47
9020152	231	9041149	227	9041306	231
9020153	231	9041152	227	9041311	236
9020154	231	9041154	227	9041322	122-123
9021012	228	9041164	230	9041323	231
9021055	238	9041165	230	9041324	231
9021056	238	9041166	232	9041360	98-99
9021057	238	9041168	231	9041361	98-99
9021058	238	9041169	232	9041362	98-99
9021082	228	9041172	231	9041363	98-99
9021172	228	9041173	232	9041364	98-99
9021285	222	9041174	232	9041365	98-99
9021286	222	9041175	232	9041406	90-91
9021287	222	9041180	171	9041407	90-91
9021288	222	9041181	171	9041408	90-91
9021289	222	9041183	235	9041419	42-43
9021290	222	9041184	235	9041420	42-43
9021291	222	9041185	235	9041421	42-43
9021292	222	9041191	227	9041422	42-43
9021294	222	9041200	224	9041461	225
9021295	222	9041201	225	9041468	228
9021311	223	9041219	170	9041497	48-49
9021312	223	9041220	225	9041498	48-49
9021313	223	9041221	228	9041499	48-49
9021314	223	9041222	228	9041500	48-49
9021315	223	9041223	228	9041511	172
9021316	223	9041226	229	9041520	196-197
9021317	223	9041227	229	9041521	192-195
9021318	223	9041228	229	9041522	192-195
9021320	223	9041229	229	9041523	192-195
9021321	223	9041230	229	9041524	192-195
9021378	225	9041231	229	9041525	195-195
9041033	238	9041234	233	9041532	196-197
9041082	170	9041235	233	9041533	196-197
9041085	88-89	9041236	233	9041534	196-197
9041086	88-89	9041237	233	9041535	196-197
9041087	88-89	9041238	233	9041536	196-197
9041088	88-89	9041239	233	9041542	225
9041089	94-95	9041240	233	9041543	225
9041090	94-95	9041241	233	9041544	225
9041120	173	9041242	233	9041545	225
9041127	172	9041243	233	9041546	225
9041130	210	9041244	233	9041547	225
9041131	213	9041245	233	9041555	222
9041132	213	9041246	233	9041556	225



Part no.	Page	Part no.	Page	Part no.	Page	Part no.	Page	Part no.	Page	Part no.	Page
9041557	222	52641201	224	72675703	72	90000082	170	90000178	205	90000264	216
9041558	150-153	52641202	224	72678201	52-53	90000083	204	90000179	206	90000266	216
9041565	238	52641301	224	72678301	52-53	90000084	204	90000180	206	90000267	214
9041566	238	52641302	224	72678401	52-53	90000085	204	90000181	204	90000269	216
9041569	238	52641401	224	72682307	72	90000086	204	90000182	204	90000270	216
9041570	238	52641501	224	72683501	56-57	90000089	206	90000183	180-181	90000275	218
9041571	192-195	52641601	224	72684305	78-79	90000090	206	90000184	205	90000276	218
9041572	192-195	52641701	224	72684306	78-79	90000091	204	90000185	205	90000277	218
9041573	192-195	52641801	224	72684307	78-79	90000092	204	90000186	205	90000278	218
9041575	236	52641901	224	72684308	80-81	90000093	206	90000187	205	90000279	218
9041576	132-135	52642002	229	72684309	78-79	90000094	205	90000188	205	90000280	218
9041577	132-136	52642010	229	72684310	78-79	90000095	204	90000189	205	90000281	219
9541176	231	52644001	226	72684311	80-81	90000096	204	90000190	205	90000282	219
9541177	231	52644101	226	72684312	80-81	90000097	204	90000191	205	90000283	219
51849402	234	52644501	229	72684313	80-81	90000098	204	90000192	205	90000284	219
51849403	234	52644601	229	72687102	72	90000099	204	90000193	205	90000285	219
51849404	234	52644701	229	72687103	72	90000100	204	90000194	205	90000291	158-161
51849605	229	52644801	229	72687104	72	90000105	205	90000195	205	90000292	158-161
51969702	238	52662301	236	72687117	74-77	90000107	236	90000196	205	90000293	158-161
51978301	234	52662401	236	72687118	74-77	90000108	236	90000197	205	90000294	162-165
51978701	229	52662701	223	72687121	66-67	90000109	236	90000198	205	90000295	162-165
51978702	229	52662702	223	72687123	70-71	90000110	236	90000199	205	90000296	162-165
51979601	226	52662703	223	72687127	73	90000111	236	90000200	204	90000297	171
51980001	224	71616301	84-85	72687128	73	90000115	231	90000201	205	90000301	173
51990601	234	71616501	84-85	72687129	73	90000122	173	90000202	204	90000312	124-127
52364801	234	71766401	82-83	72687130	73	90000126	231	90000203	205	90000313	171
52365001	234	71908801	86-87	72687131	73	90000132	229	90000204	204	90000313	206
52634502	73	71984001	228	72687132	73	90000134	204	90000205	205	90000315	219
52634503	73	72357001	86-87	72687133	73	90000137	204	90000206	204	90000315	232
52634504	73	72573602	72	72687134	73	90000138	204	90000207	205	90000316	232
52634505	73	72573603	72	90000003	150-153	90000139	204	90000208	206	90000317	232
52634506	73	72574201	72	90000010	226	90000140	204	90000213	172	90000318	232
52634507	73	72574202	72	90000011	226	90000147	205	90000214	172	90000320	171
52634508	73	72574203	72	90000012	226	90000148	206	90000224	140-143	90000320	206
52634509	73	72574204	72	90000013	226	90000149	205	90000225	140-143	90000321	171
52634510	73	72591601	58-59	90000014	226	90000150	206	90000226	173	90000321	206
52634511	73	72591701	60-61	90000016	226	90000151	205	90000227	170	90000322	172
52641001	222	72593101	228	90000017	268	90000152	206	90000242	104-105	90000323	172
52641002	222	72593102	228	90000019	226	90000153	206	90000243	104-105	90000324	173
52641003	222	72596201	228	90000048	225	90000154	206	90000247	215	90000325	171
52641004	222	72596202	228	90000049	225	90000155	206	90000248	215	90000326	171
52641005	222	72612601	72	90000051	225	90000156	173	90000249	215	90000334	170
52641006	222	72643201	235	90000052	225	90000157	148-149	90000250	215	90000336	170
52641007	222	72643202	235	90000054	225	90000158	148-149	90000251	215	90000339	231
52641008	222	72643203	235	90000055	225	90000161	205	90000252	215	90000340	231
52641009	222	72643204	235	90000058	226	90000162	173	90000253	215	90000343	108-111
52641101	228	72643601	235	90000059	226	90000163	173	90000254	214	90000344	171
52641102	228	72643602	235	90000060	226	90000165	171	90000255	210	90000345	173
52641103	228	72643603	235	90000061	226	90000166	171	90000256	214	90000347	173
52641104	228	72643604	235	90000066	154-157	90000167	206	90000257	214	90000349	234
52641105	228	72649401	108-111	90000067	154-157	90000169	204	90000258	214	90000350	234
52641106	228	72649501	108-111	90000068	182-183	90000172	204	90000259	214	90000351	234
52641107	228	72649601	108-111	90000069	184-185	900YGG 00173	173	90000260	214	90000352	211
52641108	228	72649701	108-111	90000070	186-187	90000173	204	90000261	214	90000353	211
52641109	228	72675701	72	90000076	229	90000174	204	90000262	216	90000356	225
52641110	228	72675702	72	90000077	229	90000175	204	90000263	216	90000358	96-97





Part no.	Page
90000359	96-97
90000360	96-97
90000361	96-97
90000362	108-111
90000363	108-111
90000364	108-111
90000376	72
90000378	72
90000384	44-45
90000385	44-45
90000386	44-45
90000387	44-45
90000388	44-45
90000389	44-45
90000390	44-45
90000391	44-45
90000392	44-45
90000393	136-139
90000394	136-139
90000395	144-147
90000396	144-147
90000397	128-131
90000398	128-131
90000399	128-131
90000400	120-121
90000408	170
90000409	170
90000410	172
90000411	172
90000412	172
90000413	173
90000414	173
90000415	173
90000416	44-45
90000417	44-45
90000418	44-45
90000419	44-45
90000420	44-45
90000421	44-45
90000422	44-45
90000423	172
90000424	172
90000425	172
90000426	172
90000427	172
90000428	172
90000429	173
90000430	173
90000431	173
90000432	173
90000437	235
90000438	235
90000439	219
90000439	232
90000440	213
90000441	213

Part no.	Page
90000443	216
90000444	216
90000445	219
90000446	219
90000447	219
90000448	219
90000449	230
90000450	230
90000454	50-51
90000455	50-51
90000456	50-51
90000458	50-51
90000465	227
90000466	227
90000467	227
90000468	227
90000469	227
90000470	227
90000471	227
90000475	227
90000476	227
90000477	227
90000478	227
90000480	227
90000497	227
90000498	230
90000499	230
90000500	227
90000501	230
90000502	230
90000503	223
90000504	223
90000505	227
90000506	229
90000514	238
90000518	104-105
90000519	104-105
90000520	102-103
90000525	213
90000526	213
90000527	213
90000528	213
90000529	213
90000530	213
90000531	213
90000532	36-37
90000533	36-37
90000534	36-37
90000535	36-37
90000537	237
90000538	237
90000539	237
90000540	237
90000541	237
90000542	170
90000542	237

Part no.	Page
90000543	237
90000544	237
90000545	237
90000546	237
90000547	237
90000548	237
90000549	237
90000550	237
90000551	237
90000552	238
90000553	238
51791101*	228

# Air Flow Solutions

## DUPLEXVENT® MULTI Ventilation with Heat Recovery

Improve indoor climate with cleaner, fresher air.  
Saves money too by recovering lost heat!



- Counter flow exchanger with up to 95% heat recovery
- Low energy EC fans
- Automatic circulation and 100% bypass
- 100% customisation
- 10 speed digital control
- Internet connection and BMS
- Outdoor versions available
- Incorporate into BREEAM assessments



For further information see pages 188 - 193

Visit: [airflow.com](http://airflow.com)



# The Small Print

## Terms and Conditions of Supply for Business-to-Business Contracts

### 1. Definitions

In these Conditions, the following definitions apply:

**Airflow:** Airflow Developments Limited (registered in England and Wales with company number 550374).

**Business Day:** a day (other than a Saturday, Sunday or public holiday) when banks in London are open for business.

**Call Out:** has the meaning given in condition 10(a).

**Conditions:** the terms and conditions set out in this document.

**Contract:** the contract between Airflow and the Customer for the sale and purchase of the Goods and/or Services in accordance with these Conditions.

**Customer:** the person or firm purchasing Goods and/or Services from Airflow.

**Force Majeure Event:** has the meaning given in condition 17.

**Goods:** the goods (or any part of them) set out in an Order and/or the applicable Specification.

**Incoterms:** the international rules for the interpretation of trade terms published by the International Chamber of Commerce in 2010.

**Order:** the Customer's order for Goods and/or Services, as set out in the Customer's purchase order form (or, in the case of a Call Out, a fully completed Service / Warranty Call Out Request Form) or the Customer's written acceptance of Airflow's quotation, as the case may be.

**Site:** the site where the Goods are to be delivered to the Customer and/or the site where the Services are to be provided by Airflow to the Customer.

**Services:** the services to be provided by Airflow to the Customer (whether in connection with a Call Out or otherwise) as detailed in the Order and/or Specification.

**Service Level Agreement:** the service levels, to be agreed in writing by the parties, in accordance with which the Goods and/or Services are to be supplied, or as appropriate, provided where such Goods and/or Services are bespoke to the Customer's own requirements.

**Service/Warranty Call Out Request Form:** the form to be completed by the Customer if requesting a Call Out and available from Airflow's Customer Services Department on 01494 560800 or by email at customer\_services@airflow.com.

**Specification:** the written description or specification for the Goods and/or Services, including any related plans and drawings which are supplied to Airflow by the Customer, or produced by Airflow and agreed in writing by the Customer.

### 2. Basis of Contract

(a) These Conditions apply to the Contract to the exclusion of any other terms that the Customer seeks to impose or incorporate, or which are implied by trade, custom, practice or course of dealing. These Conditions shall be subject to any additional written terms set out and expressly agreed by Airflow in the Contract or the Service Level Agreement to the extent that there is any inconsistency. Incoterms shall apply but where they conflict with these Conditions, these Conditions shall prevail.

(b) The Order constitutes an offer by the Customer to purchase the Goods and/or Services in accordance with these Conditions.

(c) The Order shall only be deemed to be accepted if and when Airflow issues a written acceptance of the Order or when Airflow delivers the Goods and/or provides the Services (whichever is the sooner), at which point the Contract shall come into existence.

(d) The Contract constitutes the entire agreement between the parties. The Customer acknowledges that it has not relied on any statement, promise or representation made or given by or on behalf of Airflow which is not set out in the Contract. Any samples, drawings, descriptive matter, or advertising issued by Airflow and any descriptions or illustrations contained in Airflow's catalogues or brochures are issued or published for the sole purpose of giving an approximate idea of the products described in them. They shall not form part of the Contract or any other contract between Airflow and the Customer for the sale of the Goods and/or the provision of Services.

(e) A quotation for the supply of Goods and/or the provision of Services given by Airflow shall not constitute an offer. A quotation shall only be valid for the period specified on it and if no such period is specified, it can be withdrawn at any time.

### 3. Provision of Services

(a) Airflow shall provide the Services to the Customer in accordance with the Specification and (where applicable) the Service Level Agreement in all material respects.

(b) Airflow shall use all reasonable endeavours to meet any performance dates specified in the Service Level Agreement, but any such dates shall be estimates only and time shall not be of the essence for performance of the Services.

(c) Airflow shall have the right to make any changes to the Services which are necessary to comply with any applicable law or safety requirement, or which do not materially affect the nature or quality of the Services, and Airflow shall notify the Customer in any such event.

(d) Airflow warrants to the Customer that the Services will be provided using reasonable care and skill.

### 4. Customer Obligations

The Customer shall:

(a) ensure that the Order contains the appropriate product codes and prices, as agreed with Airflow, and that the terms of the Order and any information provided in the Specification are complete and accurate. For the avoidance of doubt, where there have been pre-sale discussions between Airflow and the Customer and/or the Customer's end user involving a number of differing options with regard to features or price (quote versions), it shall be the responsibility of the Customer to state in the Order which quote version is required by the end user. Airflow shall accept no responsibility if the quote version is not so confirmed in the Order;

(b) co-operate with Airflow in all matters relating to the supply of the Goods and/or the provision of the Services;

(c) comply with Airflow's oral or written instructions as to the storage, commissioning, installation, use and maintenance of the Goods, including the information in the installation and operating instructions and user manual which may be supplied by Airflow to the Customer, or (if there are no such instructions) good trade practice;

(d) provide Airflow, its employees, agents, consultants and subcontractors, with access to the Site and other facilities as reasonably required by Airflow;

(e) provide Airflow with such information and materials as Airflow may reasonably require in order to supply the Goods and/or provide the Services, and ensure that such information is accurate in all material respects;

(f) prepare the Site for the delivery of the Goods and/or receipt of the Services, ensure adequate labour and suitable equipment is available, and ensure there is a suitable working area for the performance of the Services by Airflow at the Site;

(g) obtain and maintain all necessary licences, permissions and consents which may be required before the date on which the Goods and/or Services are to be supplied or, as applicable, provided. In particular, it is acknowledged that quotations made by Airflow are derived from diagrams and specifications and not from any site survey or local knowledge of building control preferences. In every case it is the Customer's responsibility to check with the appropriate building control body, private inspector and/or local authority before submitting an Order to consider what is necessary in relation to the Goods and/or the Services for the purposes of relevant building regulations;

(h) keep and maintain all materials, equipment, documents and other property of Airflow (Airflow Materials) at the Customer's premises in safe custody at its own risk, maintain Airflow Materials in good condition until returned to Airflow, and not dispose of or use Airflow Materials other than in accordance with Airflow's written instructions or authorisation; and

(i) ensure that any resale of Goods by the Customer to a third party (whether or not an end user) shall not create or imply any contractual right or remedy on the part of that third party against Airflow, even if Airflow participates with the Customer and the third party in any pre-sale discussions. The Customer shall indemnify Airflow in respect of any actions, claims, costs, damages, expenses, losses or other liabilities which Airflow may suffer or incur arising from any contractual claim brought against it by any such third party.

### 5. Customer Default

If performance by Airflow of any of its obligations under the Contract is prevented or delayed by any act or omission by the Customer or failure by the Customer to perform any obligation set out in condition 4 or other relevant obligation (Customer Default):

(a) Airflow shall without limiting its other rights or remedies have the right to suspend performance of the Contract until the Customer remedies the Customer Default, and to rely on the Customer Default to relieve it from the performance of any of its obligations to the extent the Customer Default prevents or delays Airflow's performance of any of those obligations;

(b) Airflow shall not be liable for any costs or losses sustained or incurred by the Customer arising directly or indirectly from the Customer's failure or delay to perform any of its obligations as set out in condition 4; and

(c) The Customer shall reimburse Airflow on written demand for any costs or losses (including any legal costs and expenses in defending claims brought against Airflow by the Customer or by any third party) sustained or incurred by Airflow arising directly or indirectly from the Customer Default.

### 6. Delivery

(a) Airflow shall ensure that: (i) each delivery of Goods is accompanied by a delivery note which shows the date of the Order, all relevant Customer and Airflow reference numbers, the type and quantity of the Goods (including the code number of the Goods, where applicable), special storage instructions (if any) and, if the Order is being delivered by instalments, the outstanding balance of Goods remaining to be delivered; and (ii) if Airflow requires the Customer to return any packaging materials to Airflow, that fact is clearly stated on the delivery note. The Customer shall make any such packaging materials available for collection at such times as Airflow shall reasonably request. Returns of packaging materials shall be at Airflow's expense. Returnable cases or stillages, separately invoiced, shall be credited in full if returned to Airflow at the Customer's expense within 28 calendar days of delivery of the Goods.

(b) Airflow shall:

(i) make the Goods available for collection by the Customer at the Airflow's premises as set out in the Order. The Customer shall collect the Goods within the period specified in the Order; or

(ii) deliver the Goods to the location set out in the Order or to such other location as the parties may agree in writing (Delivery Location) at any time after Airflow notifies the Customer that the Goods are ready for delivery. Airflow reserves the right to levy an additional delivery charge if the Delivery Location is not at the Customer's primary place of business or an express delivery is requested.

(c) Delivery of the Goods shall be complete when the Goods arrive at the Delivery Location or, if the Customer is to collect the Goods, on completion of the loading at Airflow's premises.

(d) It is the Customer's responsibility to ensure that a person duly authorised to sign on its behalf to acknowledge receipt of the Goods is present at the Delivery Location at the time of delivery. Signature upon receipt of the Goods will be proof of delivery. The Customer shall indemnify and keep indemnified Airflow against all liabilities, costs, expenses, damages and losses suffered or incurred by Airflow arising out of or in connection with any breach by the Customer of its obligations under this condition 6(d).

(e) Any dates quoted for delivery are approximate only, and the time of delivery is not of the essence. Airflow shall not be liable for any delay in delivery of the Goods to the extent that such failure is caused by a Force Majeure Event or the Customer's failure to provide Airflow with adequate delivery instructions or any other instructions that are relevant to the delivery of the Goods.

(f) Airflow may deliver the Goods by instalments, which shall be invoiced and paid for separately. Each instalment shall constitute a separate Contract. Any delay in delivery or defect in an instalment shall not of itself entitle the Customer to cancel any other instalment.

### 7. Inspection of Goods

(a) Any claim for non-delivery of Goods shall be communicated to Airflow in writing within 5 Business Days of the date of the relevant invoice that relates to the Goods.

(b) If Airflow fails to deliver the Goods, its liability shall be limited to the costs and expenses incurred by the Customer in obtaining replacement goods of similar description and quality in the cheapest market available, less the price of the Goods.

(c) After receipt of a delivery of the Goods, the Customer shall, within 3 Business Days, visually inspect the Goods to ensure that it is satisfied with the Goods, that the Goods conform with their description and the Specification and that no damage or loss in transit has occurred to the Goods. Any claims for defects of this nature shall be communicated to Airflow in writing during this 3 Business Day period.

(d) Airflow shall consider any request by the Customer to deliver Goods direct to the Customer's end user's site but if Airflow agrees (at its discretion) to do so, any notification of non-conformity, damage or shortages in respect of such Goods must be made to Airflow within 24 hours of delivery to the end user. Airflow will not be responsible to the Customer or the end user in the event of any later notification, nor shall it be responsible if the Goods are subsequently installed at the end user's site by or on behalf of the end user.

(e) Any quantities of Goods that are rejected by the Customer or an end user for a reason contemplated by condition 7(c) or 7(d) shall be returned to Airflow and, subject to Airflow accepting that there is a valid reason for the rejection of those Goods, Airflow will make good any defect by, at its discretion, repairing, replacing or procuring a replacement of the Goods at no expense to the Customer and Airflow will reimburse the Customer the cost of returning the Goods. The obligations of Airflow set out in this condition 7(e) shall be the Customer's sole remedy for rejected Goods and Airflow shall not have any further liability in respect of the Goods whether such liability arises by contract, in tort (including negligence), by statute, common law or otherwise.

(f) Subject to the Customer's right to reject the Goods under this condition 7, the Customer shall be deemed to have accepted the Goods on delivery.

### 8. Failure Caused by Customer to Deliver Goods

If the Customer fails to take delivery of the Goods within 10 Business Days of Airflow notifying the Customer that the Goods are ready for delivery, then, except where such failure or delay is caused by a Force Majeure Event or Airflow's failure to comply with its obligations under the Contract:

(a) Delivery of the Goods shall be deemed to have been completed at 9.00 am on the 10th Business Day following the day on which Airflow notified the Customer that the Goods were ready for delivery; and

(b) Airflow shall store the Goods until delivery takes place, and charge the Customer for all related costs and expenses (including insurance).

### 9. Quality of Goods

(a) Without prejudice to condition 9(g), Airflow warrants that on delivery, and for a period of 12 calendar months from the date of delivery or such other period (if any) agreed in writing between the parties (the warranty period), the Goods shall conform in all material respects with their description and any applicable Specification and be free from material defects in design, material and workmanship.

(b) Subject to condition 9(c), if the Customer gives notice in writing to Airflow during the warranty period of discovery that some or all of the Goods do not comply with the warranty set out in condition 9(a):

(i) the Customer may request a Call Out in accordance with condition 10; or

(ii) the Customer may give Airflow a reasonable opportunity of examining those Goods and the Customer (if asked to do so by Airflow) shall return those Goods to Airflow's place of business by courier or recorded delivery at the Customer's cost. Proof of delivery should be retained by the Customer and should be made available upon request by Airflow.

(c) Subject to Airflow accepting that there is a valid reason for the Customer to reject or return any of such Goods (and, for the avoidance of doubt, that the Goods have not failed as a result of incorrect installation), Airflow shall reimburse any payment made by the Customer in respect of a Call Out and, at Airflow's option, repair or replace defective Goods, or refund the price of defective Goods in full. When a debit note is issued by the Customer or a sales return note (SRN) is issued by Airflow prior to the Goods being returned to Airflow, the Goods must be returned within 10 working days via the Airflow returns process and failure to do so will result in the debit note or SRN (as applicable) being disclaimed or cancelled respectively.

(d) Airflow shall not be liable for Goods' failure to comply with the warranty set out in condition 9(a) if: (i) the Customer or any end user makes any further use of those Goods after giving notice in accordance with conditions 7(c), 7(d) or 9(b) (as applicable); or (ii) the defect arises because the Customer or end user failed to follow Airflow's oral or written instructions as to the storage, installation, commissioning, use and maintenance of the Goods or (if there are none) good trade practice; or (iii) the defect arises as a result of Airflow following any drawing, design, description or specification supplied by the Customer or end user; or (iv) the Customer or end user alters or repairs those Goods without the written consent of Airflow; or (v) the defect arises as a result of fair wear and tear, wilful damage, negligence, or abnormal storage or working conditions; or (vi) the defect arises as a result of incorrect installation and/or failure to comply with good trade practice in relation to the installation of the Goods; or (vii) the defect arises as a result of those Goods being used within an application or for a purpose for which those Goods have not been designed; or (viii) the Customer or end user fails to give notice in writing to Airflow within the time periods specified in conditions 7(a), 7(c), 7(d) or 9(b)(i) (as applicable); or (ix) the Goods differ from the Specification as a result of changes made to ensure they comply with the applicable statutory or regulatory requirements.

(e) For the avoidance of doubt the warranty set out in condition 9(a) will be void if there is a failure to store, install, commission, maintain and use Goods in line with Airflow's written instructions.

(f) Except as provided in this condition 9, Airflow shall have no liability to the Customer in respect of the Goods' failure to comply with the warranty set out in condition 9(a).

(g) Except as set out in these Conditions, all warranties, conditions and other terms implied by statute or common law are, to the fullest extent permitted by law, excluded from the Contract.

(h) These Conditions shall apply to any repaired or replacement Goods supplied by Airflow and the warranty period set out in condition 9(a) shall be deemed to be a period of 12 calendar months from the date of delivery of any such repaired or replacement Goods or such other period (if any) agreed in writing between the parties.

(i) Airflow reserves the right, in the interests of continuous development, to alter specifications without prior notice.

### 10. Call Outs

(a) Subject to condition 10(c), the Customer may request an appointment with an Airflow service engineer to assess and, if Airflow determines appropriate, to repair or replace a Good or other product which has been supplied by Airflow to the Customer or a third party (a Call Out) by contacting Airflow's customer services department by telephone on 01494 560800 or by email to customer\_services@airflow.com. A request by the Customer for a Call Out shall constitute a new Order and these Conditions shall apply accordingly.



(b) A Call Out shall take place on a Business Day at a time and place agreed between the Customer and Airflow taking into account the availability of the service engineers of Airflow. The maximum duration of each Call Out shall not exceed four hours (including travel time) and Airflow shall endeavour to undertake any necessary repairs or replacements during this time, subject to the Customer agreeing the additional cost (if any) of such repairs or replacements. If Airflow is not able to complete a repair or replacement during a Call Out appointment for any reason, the Customer may request additional Call Out appointments and each Call Out shall be charged in accordance with condition 10(d).

(c) Unless otherwise agreed, Call Outs are not available in connection with Goods which have been purchased and/or installed outside of the United Kingdom.

(d) Unless otherwise agreed, the cost to the Customer of each Call Out shall be £250 plus VAT which is payable in advance in full and cleared funds by the Customer prior to the Call Out plus reasonable expenses (including travel, parking and congestion charge costs).

(e) The Customer may cancel any Order for a Call Out not later than 24 hours prior to the agreed date and time of the Call Out without incurring a cancellation fee.

(f) If the Customer cancels an Order for a Call Out not later than 24 hours prior to the agreed date and time of the Call Out and the Customer has made any payment to Airflow in advance for the Call Out, Airflow will refund the amount of the payment to the Customer.

(g) If the Customer cancels an Order for a Call Out less than 24 hours prior to the agreed date and time of the Call Out, no refund will be given by Airflow.

(h) During a Call Out, Airflow shall only assess electrical cables which are directly connected to the Good or product which is the subject of the Call Out and, upon Airflow's request, the Customer shall ensure that any such cables are isolated. Airflow shall not be liable for accidental damage caused by its representatives during a Call Out in connection with trying to access any product which is the subject of the Call Out.

(i) In the event that the Customer is not satisfied with the service provided by an Airflow service engineer during a Call Out, the Customer should immediately contact Airflow's Customer Services Department on 01494 560800 or by email at customer\_services@airflow.com. A new Call Out appointment shall be arranged in accordance with condition 10(a) and the charges set out in condition 10(d) shall apply to each new Call Out. Subject to Airflow accepting that there is a valid reason for the Customer's complaint and that such fault arises from a failure by Airflow to provide the Services using reasonable care and skill and that such fault arose within a 30 day period commencing on the date of the original Call Out, Airflow shall reimburse any payment made by the Customer in respect of the additional Call Out and, at Airflow's option, repair any defect, or refund the price of the original Call Out in full.

#### 11. Title and Risk

(a) The risk in the Goods shall pass to the Customer on completion of delivery.

(b) Title to the Goods shall not pass to the Customer until Airflow has received payment in full (in cash or cleared funds) for: (i) the Goods; and (ii) all other sums which are or which become due to Airflow for sales of Goods and/or Services to the Customer.

(c) Until title to the Goods has passed to the Customer, the Customer shall: (i) hold the Goods on a fiduciary basis as Airflow's bailee; (ii) store the Goods separately from all other goods held by the Customer so that they remain readily identifiable as Airflow's property; (iii) not remove, deface or obscure any identifying mark or packaging on or relating to the Goods; (iv) maintain the Goods in satisfactory condition and keep them insured against all risks for their full price from the date of delivery; (v) notify Airflow immediately if it becomes subject to any of the events listed in condition 13(b); and (vi) give Airflow such information relating to the Goods as Airflow may require from time to time, but the Customer may resell or use the Goods in the ordinary course of its business.

(d) If before title to the Goods passes to the Customer the Customer becomes subject to any of the events listed in condition 13(b), or Airflow reasonably believes that any such event is about to happen and notifies the Customer accordingly, then, provided that the Goods have not been resold, or irrevocably incorporated into another product, and without limiting any other right or remedy Airflow may have, Airflow may at any time require the Customer to deliver up the Goods and, if the Customer fails to do so promptly, enter any premises of the Customer or of any third party where the Goods are stored in order to recover them.

#### 12. Prices and Payment

(a) The price of the Goods and/or Services shall be the price set out in the Order, or, if no price is quoted, the price set out in Airflow's published price list in force as at the date of delivery. Airflow's price list contains a large number of Goods and it is always possible that, despite Airflow's best efforts, some of the Goods listed in its price list may be incorrectly priced. Airflow will normally verify prices as part of its dispatch procedure so that, where a correct price of the Goods is less than the stated price, Airflow will charge the lower amount when dispatching the Goods to the Customer. If a correct price of the Goods is higher than the price stated on Airflow's price list, Airflow will normally, at its discretion, either contact the Customer for instructions before dispatching the Goods, or reject the Order and notify the Customer of such rejection.

(b) Airflow may, by giving notice to the Customer at any time before delivery of the Goods or provision of the Services, increase the price of the Goods and/or Services to reflect any increase in the cost of the Goods and/or Services that

is due to: (i) any factor beyond Airflow's control (including foreign exchange fluctuations, increases in taxes and duties, and increases in labour, materials and other manufacturing costs); (ii) any request by the Customer to change the Specification, Service Level Agreement, delivery or performance date(s), quantities or types of Goods and/or Services ordered; or (iii) any delay caused by any instructions of the Customer or failure of the Customer to give Airflow adequate or accurate information or instructions.

(c) Unless otherwise stated on the Order, the price of the Goods is exclusive of the costs and charges of packaging, insurance and transport of the Goods, which shall be paid by the Customer when it pays for the Goods.

(d) The price of the Goods or Services is exclusive of amounts in respect of value added tax (VAT). The Customer shall, on receipt of a valid VAT invoice from Airflow, pay to Airflow such additional amounts in respect of VAT as are chargeable on the supply of the Goods or provision of the Services.

(e) Airflow may invoice the Customer for the Goods and/or Services on or at any time after the completion of delivery of the Goods or provision of the Services.

(f) The Customer shall pay the invoice in full and in cleared funds within 30 calendar days from the end of the calendar month in which the relevant invoice was raised, with the exception of invoices raised in January which shall become due and payable by the 28th day of February. Time of payment is of the essence.

(g) If the Customer fails to make any payment due to Airflow under the Contract by the due date for payment (due date), then the Customer shall pay interest on the overdue amount at the rate of 2% per annum above HSBC Bank plc's base lending rate from time to time. Such interest shall accrue on a daily basis from the due date until the date of actual payment of the overdue amount, whether before or after judgment. The Customer shall pay the interest together with the overdue amount.

(h) The Customer shall pay all amounts due under the Contract in full without any deduction or withholding except as required by law and the Customer shall not be entitled to assert any credit, set-off or counterclaim against Airflow in order to justify withholding payment of any such amount in whole or in part. Airflow may at any time, without limiting any other rights or remedies it may have, set off any amount owing to it by the Customer against any amount payable by Airflow to the Customer.

#### 13. Customer's Insolvency or Change or Control

(a) If the Customer becomes subject to any of the events listed in condition 13(b), or Airflow reasonably believes that the Customer is about to become subject to any of them and notifies the Customer accordingly, then, without limiting any other right or remedy available to Airflow, Airflow may cancel or suspend all further deliveries of Goods or provision of Services under the Contract or under any other contract between the Customer and Airflow without incurring any liability to the Customer, and all outstanding sums in respect of Goods and/or Services delivered or provided to the Customer shall become immediately due.

(b) For the purposes of condition 13(a), the relevant events are: (i) the Customer suspends, or threatens to suspend, payment of its debts or, in the opinion of Airflow, is unable to pay its debts as they fall due or admits inability to pay its debts or (being a company) is deemed unable to pay its debts within the meaning of section 123 of the Insolvency Act 1986, or (being an individual) is deemed either unable to pay its debts or as having no reasonable prospect of so doing, in either case, within the meaning of section 268 of the Insolvency Act 1986, or (being a partnership) has any partner to whom any of the foregoing apply; or (ii) the Customer commences negotiations with all or any class of its creditors with a view to rescheduling any of its debts, or makes a proposal for or enters into any compromise or arrangement with its creditors; or (iii) any event occurs, or proceeding is taken, with respect to the Customer in any jurisdiction to which it is subject that has an effect equivalent or similar to any of the events mentioned in this condition 13(b); or (iv) a petition is filed, a notice is given, a resolution is passed, or an order is made, for or in connection with the winding up of the Customer; or (v) an application is made to court, or an order is made, for the appointment of an administrator or if a notice of intention to appoint an administrator is given or if an administrator is appointed over the Customer; or (vi) the holder of a qualifying floating charge over the Customer's assets has become entitled to appoint a receiver over the Customer's assets or a receiver is appointed over the Customer's assets, or (vii) a creditor or encumbrancer of the Customer attaches or takes possession of, or a distress, execution, sequestration or other process is levied or enforced on or sued against, the whole or any part of its assets and such attachment or process is not discharged within 14 days, or (viii) in the opinion of Airflow, the Customer suspends, threatens to suspend, ceases or threatens to cease to carry on all or substantially the whole of its business; or (ix) there is a change of control of the Customer (as defined in section 574 of the Capital Allowances Act 2001).

#### 14. Limitation of Liability

(a) Nothing in these Conditions shall limit or exclude Airflow's liability for: (i) death or personal injury caused by its negligence, or the negligence of its employees, agents or subcontractors (as applicable); (ii) fraud or fraudulent misrepresentation; or (iii) breach of the terms implied by section 12 of the Sale of Goods Act 1979; or (iv) defective products under the Consumer Protection Act 1987; or (v) any other matter in respect of which it would be unlawful for Airflow to exclude or restrict liability.

(b) Subject to condition 14(a): (i) Airflow shall not be liable to the Customer, whether in contract, tort (including negligence), breach of statutory duty, or otherwise, for any loss of profit or indirect or consequential loss arising under or in connection

with the Contract; and (ii) Airflow's total liability to the Customer in respect of all other losses arising under or in connection with the Contract, whether in contract, tort (including negligence), breach of statutory duty, or otherwise, shall in no circumstances exceed the cost of the Goods supplied and/or Services provided under the Contract.

(c) Airflow shall not be liable to any person for any loss or damage, whether in contract, tort (including negligence), breach of statutory duty, or otherwise, even if foreseeable, arising under or in connection with use of or reliance on any recommendations, introductions or information provided by Airflow in relation to third party suppliers and/or installers.

#### 15. Intellectual Property Rights, Confidentiality and Data Protection

(a) All intellectual property rights in or arising out of or in connection with the Goods, the Services and/or the Contract shall be owned by Airflow.

(b) The Customer acknowledges that, in respect of any third party intellectual property rights, the Customer's use of any such intellectual property rights is conditional on Airflow obtaining a written licence from the relevant licensor on such terms as will entitle Airflow to license such rights to the Customer.

(c) All Airflow Materials (as defined in condition 4(h)) are the exclusive property of Airflow.

(d) A party (Receiving Party) shall keep in strict confidence all technical or commercial know-how, specifications, inventions, processes or initiatives which are of a confidential nature and have been disclosed to the Receiving Party by the other party (Disclosing Party), its employees, agents or subcontractors, and any other confidential information concerning the Disclosing Party's business or its products or its services which the Receiving Party may obtain. The Receiving Party shall restrict disclosure of such confidential information to such of its employees, agents or subcontractors as need to know it for the purpose of discharging the Receiving Party's obligations under the Contract, and shall ensure that such employees, agents or subcontractors are subject to obligations of confidentiality corresponding to those which bind the Receiving Party. The Receiving Party may also disclose such of the Disclosing Party's confidential information as is required to be disclosed by law, any governmental or regulatory authority or by a court of competent jurisdiction.

(e) The Customer acknowledges and agrees that data which it provides to Airflow will be held on a data base and that personal data will be processed by or on behalf of Airflow for the purposes specified in these Conditions. If the Customer wishes to receive further information about Airflow's privacy policy, please visit Airflow's website at www.airflow.com.

(f) This condition 15 shall survive termination of the Contract.

#### 16. Import and export licences

The Customer is responsible for obtaining, at its own cost, such import licences and other consents in relation to the Goods as are required from time to time and, if required by Airflow, the Customer shall make those licences and consents available to Airflow prior to the relevant shipment. It is the Customer's obligation to acquaint itself and to comply with all applicable requirements and restrictions relating to the possession, use, import, or export of the Goods. It is the Customer's obligation to ensure that no Goods are exported or imported in violation of the laws of any jurisdiction into or through which the Goods are transported during the course of reaching the Delivery Point. Where necessary, the Customer shall inform Airflow at a reasonable time before delivery of any documents which it is necessary for Airflow to provide in order to allow export of the Goods in compliance with the laws of any relevant jurisdiction.

#### 17. Force Majeure

(a) Neither party shall be liable for any failure or delay in performing its obligations under the Contract to the extent that such failure or delay is caused by a Force Majeure Event. A Force Majeure Event means any event beyond a party's reasonable control, which by its nature could not have been foreseen, or, if it could have been foreseen, was unavoidable, including strikes, lock-outs or other industrial disputes (whether involving its own workforce or a third party's), failure of energy sources or transport network, acts of God, war, terrorism, riot, civil commotion, interference by civil or military authorities, national or international calamity, armed conflict, malicious damage, breakdown of plant or machinery, nuclear, chemical or biological contamination, sonic boom, explosions, collapse of building structures, fires, floods, storms, earthquakes, loss at sea, epidemics or similar events, natural disasters or extreme adverse weather conditions, or default of suppliers or subcontractors.

(b) If the Force Majeure Event prevents Airflow from providing any Goods or Services for more than four consecutive weeks Airflow shall without limiting its other rights or remedies have the right to terminate the Contract immediately by giving written notice to the Customer.

#### 18. Assignment and subcontracting

(a) Airflow may at any time assign, transfer, charge, subcontract or deal in any other manner with all or any of its rights or obligations under the Contract.

(b) The Customer may not assign, transfer, charge, subcontract or deal in any other manner with all or any of its rights or obligations under the Contract without the prior written consent of Airflow.

#### 19. Notices

(a) Any notice or other communication given to a party under or in connection with the Contract shall be in writing, addressed to that party at its registered office

(if it is a company) or its principal place of business (in any other case) or such other address as that party may have specified to the other party in writing in accordance with this condition, and shall be delivered personally, sent by pre-paid first-class post, recorded delivery, commercial courier or fax.

(b) A notice or other communication shall be deemed to have been received: if delivered personally, when left at the address referred to in condition 19(a); if sent by pre-paid 1st class post or recorded delivery, at 9.00 am on the 2nd Business Day after posting; if delivered by commercial courier, on the date and at the time that the courier's delivery receipt is signed; or, if sent by fax, one Business Day after transmission.

(c) The provisions of this condition 19 shall not apply to the service of any proceedings or other documents in any legal action.

#### 20. Severance

If any court or competent authority finds that any provision of the Contract (or part of any provision) is invalid, illegal or unenforceable, that provision or part-provision shall, to the extent required, be deemed to be deleted, and the validity and enforceability of the other provisions of the Contract shall not be affected. If any invalid, unenforceable or illegal provision of the Contract would be valid, enforceable and legal if some part of it were deleted, the provision shall apply with the minimum modification necessary to make it legal, valid and enforceable.

#### 21. Waiver

A waiver of any right or remedy under the Contract is only effective if given in writing and shall not be deemed a waiver of any subsequent breach or default. No failure or delay by a party to exercise any right or remedy provided under the Contract or by law shall constitute a waiver of that or any other right or remedy, nor shall it preclude or restrict the further exercise of that or any other right or remedy. No single or partial exercise of such right or remedy shall preclude or restrict the further exercise of that or any other right or remedy.

#### 22. No partnership or agency

Nothing in the Contract is intended to, or shall be deemed to, establish any partnership or joint venture between the parties, nor constitute either party the agent of the other for any purpose. Neither party shall have authority to act as agent for, or to bind the other party in any way.

#### 23. Third party rights

A person who is not a party to the Contract shall not have any rights under or in connection with it.

#### 24. Variation

Any variation to the Contract, including the introduction of any additional terms and conditions, shall only be binding when agreed in writing and signed by Airflow.

#### 25. Governing law and jurisdiction

The Contract, and any dispute or claim arising out of or in connection with it or its subject matter or formation (including non-contractual disputes or claims), shall be governed by, and construed in accordance with, English law, and the parties irrevocably submit to the exclusive jurisdiction of the courts of England and Wales.

## UK Order & Delivery Charges\*

(other territories upon application)

For Product Category A,D,F,I,R,S,V,W (excludes category H, this is upon application)	Method of order placing	
	FAX, Email	WEB, EDI
Minimum order value accepted	£100	£75
Carriage paid order	£250	£200
Small Order Charge <small>(order under £250)</small>	£25	£15
Next Day Delivery	£25	£15
Direct to resellers customer	£25	£15

\*Subject to change. Valid August 2015



# The Last Word

## Let's talk

We hope that you have found our catalogue interesting and informative and that we have products suitable for your application.

From a toilet to a tower block we have a ventilation solution to improve our indoor climate while saving energy and cutting carbon emissions.

Even if we do not have a standard product, with nearly 60 years of innovation and expertise in air movement, we may well have considered your requirements before. We are pleased to share our knowledge and help develop new solutions to improve the air we breath, so contact us for a 'no obligation' discussion about how we can help solve your air flow needs.

We look forward to hearing from you.

Airflow Developments Limited

**KEEP UP TO DATE**



For the latest ventilation news, information, product data and application advice

**CLICK CALL VISIT**

[airflow.com](http://airflow.com)





[airflow.com](http://airflow.com)

# Air Flow Solutions



## Always Innovating

Our constant search for new and better ways to save energy, improve the indoor environment and provide you with high quality, reliable and easy to use products that contribute to a low carbon future continues.

**visit: [airflow.com](http://airflow.com)**

for the latest, products, data sheets, application advice and information

**Customer Services : 01494 560800**

**Technical Support : 01494 560950**

CI/SfB  
(57)



**Call: 01494 525252**

**Visit: [airflow.com](http://airflow.com)**



**Airflow Developments Limited**  
Aidelle House, Lancaster Road,  
Cressex Business Park,  
High Wycombe, Buckinghamshire,  
United Kingdom, HP12 3QP

E-mail: [info@airflow.com](mailto:info@airflow.com)  
Telephone: +44 (0) 1494 525252

[airflow.com](http://airflow.com)

© Airflow Developments Limited. Airflow Developments Limited reserve the right, in the interests of continuous development, to alter specifications without prior notice. All orders are accepted subject to our conditions of sale which are available on request



80000191 - Issue2 07/15