

**How to Access your cistern**

1. Remove fascia panel
2. Remove the blue cover on the cistern

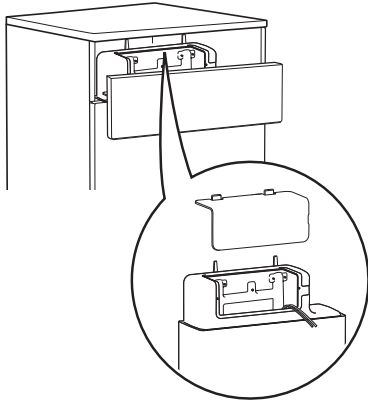

1. Shut off Water Supply
2. Unscrew the nut from the flexible hose
3. Pull out the fill valve

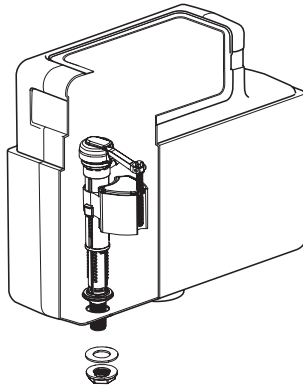

1. Gently twist & remove flush valve (anti-clockwise)

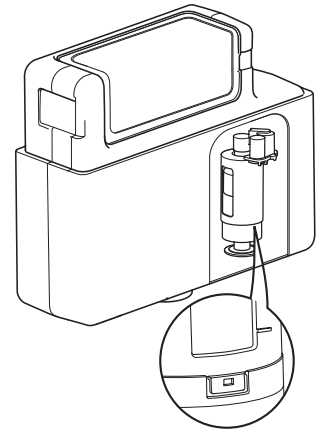

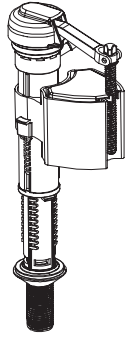
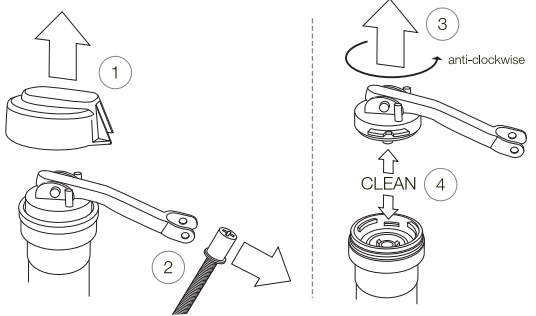
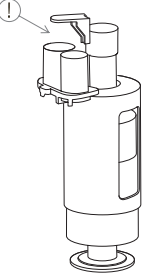
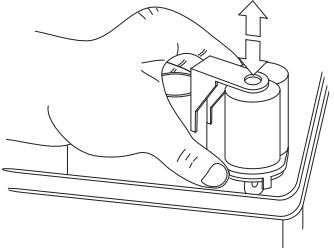
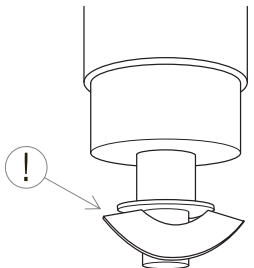
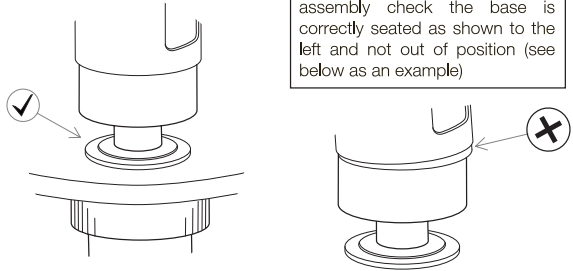
Problem	Potential cause	Suggested action
<p>The Fill Valve does not work or isn't controlling the water supply efficiently.</p>	<p>The flush valve may be blocked.</p> 	<p>Follow the instructions below and clean the water inlet orifice and cap. If unsuccessful, replace the fill valve with a new one.</p> 
<p>Water leaks from the base.</p>	<p>1 The flush valve stem may be obstructed or jammed, preventing it from falling back into position.</p> 	<p>Ensure that there is nothing obstructing the flush valve and the stem can extend up and down.</p> 
	<p>2 The rubber gasket may have fallen off or could be damaged.</p> 	<p>Ensure the rubber gasket is fixed in position. However, If it's damaged a replacement is needed.</p> <p><b>NOTE:</b> Before re-fitting the flush valve assembly check the base is correctly seated as shown to the left and not out of position (see below as an example)</p> 

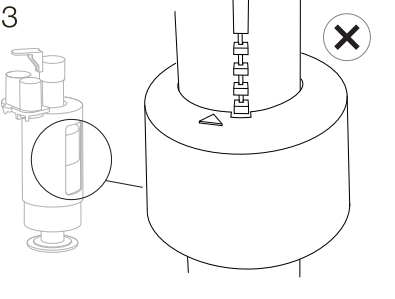
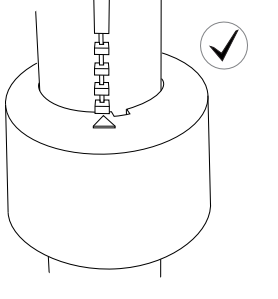
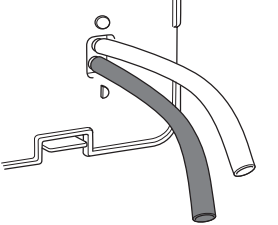
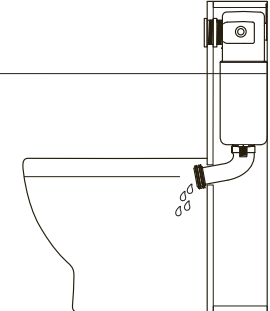
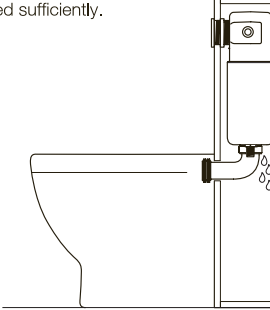
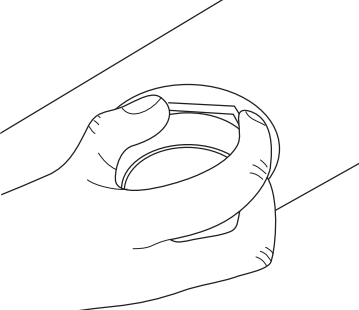
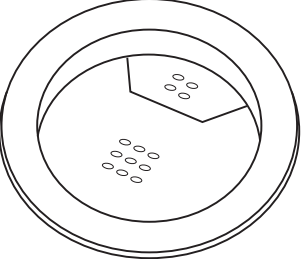
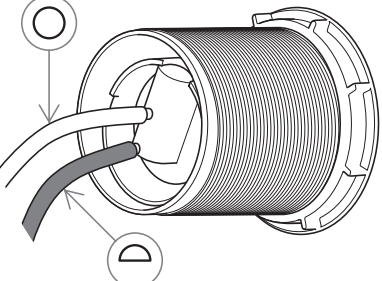
Problem	Potential cause	Suggested action
Water leaks from the base. (Continued)		 <p>Ensure the rotation of the blue float component is in the correct position.</p> <p>If it isn't (as shown left) the blue float component can catch on the adjustment measure</p>
The flush valve does not work properly.	The pneumatic tubes may have been installed incorrectly.	<p>Ensure the following:</p> <p>The blue tube must be connected to the joint marked with a half circle,</p> <p>The transparent tube should be connected with the joint marked with a full circle.</p> 
The pan washer is leaking.	The cistern may have been installed in an incorrect position causing the flush bend to pull out of position. 	<p>Ensure the cistern is in the correct position and ensure the flush bend is fully connected to the pan.</p> <p>Please see the instruction manual provided for fitting instructions.</p> 
Water leaks between the cistern and base	The nut connecting the flush bend with the cistern body may not be tightened sufficiently. 	<p>Ensure the nut is fully tightened</p> 
The pneumatic push button doesn't reposition itself once pressed downwards	It may be a fault with the air compression or the button itself could be broken 	<p>Check the pneumatic tubes are connected efficiently. If the button is faulty then it will have to be replaced with another one.</p> 



1

Check the flush valve mechanism is fitted as shown here and does not touch / interfere with the cistern casing.

2

Remove the flush valve assembly by gripping the body and rotating anti-clockwise.

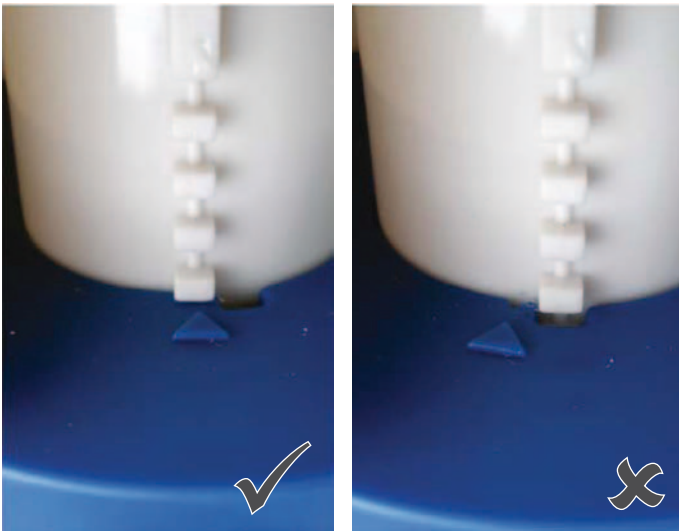

3

Check the rotation of the blue float component. The triangle should point towards the notches, not to the side of them.

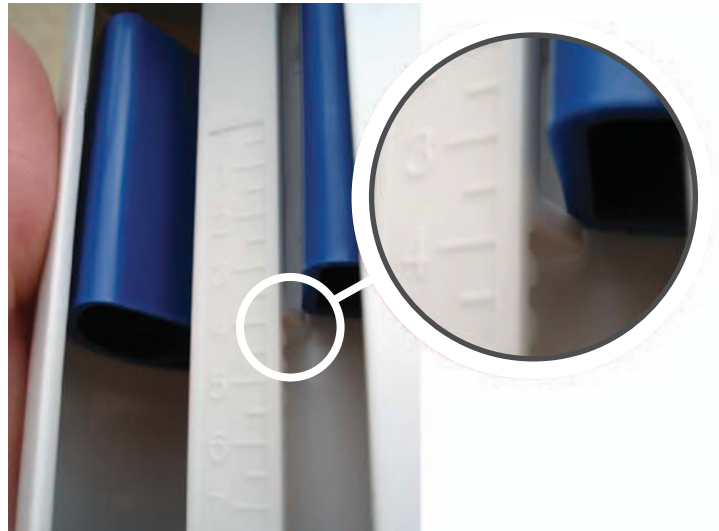

4

If the triangle isn't aligned pointing at the notches the blue float component can catch on the adjustment measure as shown.



5

Before re-fitting the flush valve assembly check the base is correctly seated as shown. Also check there are no damaged (e.g. snapped) components.

6

Once re-fitted lift the flush valve piston and release, it should drop back down without any jamming or friction. If the problem persists contact the Roper Rhodes sales office to obtain a replacement flush valve assembly (spare code: SP12166).

The factory default settings should be as follows for 3/6L flushing:

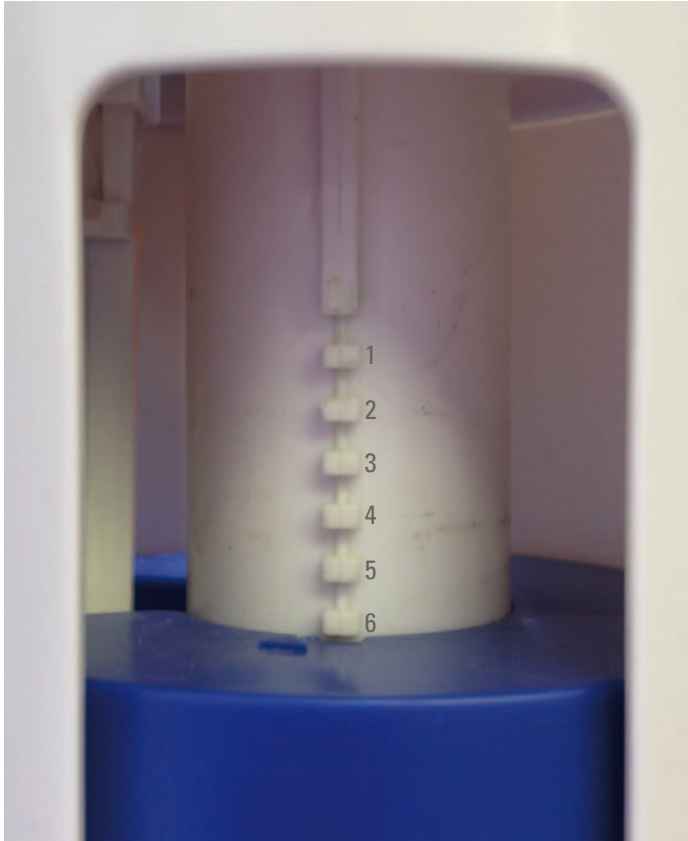

**Small flush volume**

The blue float controls the small flush volume. This should be pre-set '6 buckles' down. Moving it further down increases the small flush volume and up decreases the small flush volume.

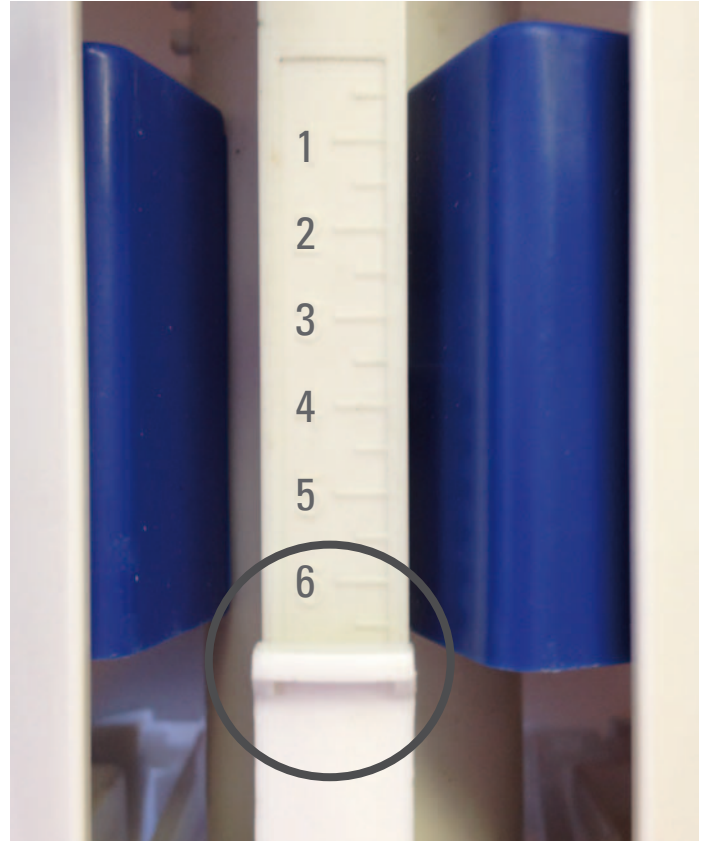

**Large flush volume**

The white plastic slider controls the large flush volume. This should be pre-set to between 6 and 7. Moving it further down increases the large flush volume and up decreases the large flush volume.