

Air to Water Heat Pump

Installation manual

Mono Outdoor Unit AE050RXYDEG

- Thank you for purchasing this Samsung Product.
- Before operating this unit, please read this installation manual carefully and retain it for future reference.



DB68-08368A-06

SAMSUNG

Contents

PREPARATION

Safety precautions	3
Product specifications	5

INSTALLATION

Outdoor unit specification	6
Application examples	7
Main components	9
Functional diagram	11
Installing the unit	12
Piping work	24
Wiring	30
Testing operations	38
Error codes	40
Maintenance	42
Charging refrigerant	45

OTHERS

Troubleshooting	46
Commissioning	49
Recommissioning instructions	49
Reference (KEYMARK Certification)	50



Correct Disposal of This Product (Waste Electrical & Electronic Equipment)

(Applicable in countries with separate collection systems)

This marking on the product, accessories or literature indicates that the product and its electronic accessories (e.g. charger, headset, USB cable) should not be disposed of with other household waste at the end of their working life. To prevent possible harm to the environment or human health from uncontrolled waste disposal, please separate these items from other types of waste and recycle them responsibly to promote the sustainable reuse of material resources. Household users should contact either the retailer where they purchased this product, or their local government office, for details of where and how they can take these items for environmentally safe recycling. Business users should contact their supplier and check the terms and conditions of the purchase contract. This product and its electronic accessories should not be mixed with other commercial wastes for disposal.

For information on Samsung's environmental commitments and product-specific regulatory obligations, e.g. REACH, visit: www.samsung.com/uk/aboutsamsung/sustainability/environment/our-commitment/data/

Safety precautions

Carefully follow the precautions listed as below because they are essential to guarantee the safety of SAMSUNG product.



WARNING

- Always disconnect a power supply of Air-Water Heat Pump before servicing it or accessing components inside the unit.
- Verify that installation and testing operations shall be performed by qualified personnel.
- To prevent serious damage on the system and injuries to users, precautions and other notices shall be observed.

Warning

- ▶ Carefully read the content of this manual before installing the air to water heat pump and store the manual in a safe place in order to be able to use it as reference after installation.
- ▶ For maximum safety, installers should always carefully read the following warnings.
- ▶ Store the provided manual in a safe location with end user after installation, and remember to hand it over to the new owner if the Heat pump unit is sold or transferred.
- ▶ This manual explains how to install Air-Water Heat Pump. The use of other types of units with different control systems may damage the units and invalidate the warranty. The manufacturer shall not be responsible for damages arising from the use of non compliant units.
- ▶ The manufacturer shall not be responsible for damage originating from unauthorized changes or the improper connection of electric and hydraulic lines. Failure to comply with these instructions or to comply with the requirements set forth in the "Operating limits" table, included in the manual, shall immediately invalidate the warranty.
- ▶ Failure to comply with these instructions or to comply with the requirement on the Operating Range (Heat: -25~35°C/ Cool: 10~46°C) set forth in the Product Specification (p.5) shall immediately invalidate the warranty.
- ▶ Do not use the units if you see some damages on the units and recognize something bad such as loud noisy, smell of burning.
- ▶ In order to prevent electric shocks, fires or injuries, always stop the unit, disable the protection switch and contact SAMSUNG's technical support if the unit produces smoke, if the power cable is hot or damaged or if the unit is very noisy.
- ▶ Always remember to inspect the unit, electric connections, refrigerant tubes and protections regularly. These operations shall be performed by qualified personnel only.
- ▶ The unit contains moving parts and electrical parts, which should always be kept out of the reach of children.
- ▶ Do not attempt to repair, move, alter or reinstall the unit by unauthorized personnel, these operations may cause product damage, electric shocks and fires.
- ▶ Do not place containers with liquids or other objects on the unit.
- ▶ All the materials used for the manufacture and packaging of the air to water heat pump are recyclable.
- ▶ The packing material and exhaust batteries of the remote controller(optional) must be disposed of in accordance with local regulations.
- ▶ The air to water heat pump contains a refrigerant that has to be disposed of as special waste. At the end of its life cycle, the heat pump must be disposed of in authorized centers or returned to the retailer so that it can be disposed of correctly and safely.
- ▶ Wear protective equipment (such as safety gloves, goggles, and headgear) during installation and maintenance works. Installation/repair technicians may be injured if protective equipment is not properly equipped.
- ▶ Do not touch the internal parts (water pipes, refrigerant pipes, heat exchangers, etc) while running the units. And if you need to adjust and touch the units, have enough time for the unit can be cooled and be sure to wear protective gloves.
- ▶ In case of refrigerant leakage, try to avoid getting in contact with the refrigerant because this could result in severe wounds.
- ▶ When you install the Air to water heat pump in a small room, you must consider a proper ventilation to prevent a leakage level within the maximum permissible limit.
 - In that case, you may die from suffocation by some possibility.

Safety precautions

- ▶ Make sure to safely dispose of packing materials. Packing materials, such as nails and other metal or wooden pallets may cause children get injured.
- ▶ Inspect the product shipped and check if damaged during transport. If the product has some damages, DO NOT INSTALL and immediately discuss about the damages with the carrier or retailer (if the installer or the authorized technician has collected the material from the retailer.)
- ▶ Our units shall be installed in compliance with the spaces described in the installation manual, to ensure accessibility from both sides and allow repairs or maintenance operations to be carried out. If the units installed without complying with procedures described in manual, additional expenses can be asked because special harnesses, ladders, scaffolding or any other elevation system for repair service will NOT be considered part of the warranty and will be charged to the end customer.
- ▶ Always make sure that the power supply is compliant with local safety standards.
- ▶ Verify that the voltage and frequency of the power supply comply with the specifications and input power is sufficient to ensure the operation of any other domestic appliance connected to the same electric lines. Always verify that the cut-off and protection switches are suitably selected.
- ▶ Always verify that electric connections (cable entry, section of leads, protections . . .) are compliant with the electric specifications and with the instructions provided in the wiring scheme. Always verify that all connections comply with the standards applicable to the installation of air to water heat pumps. Devices disconnected from the power supply should be completely disconnected in the condition of overvoltage category.
- ▶ Do not connect the earth wire to the gas pipe or water pipe, lighting rod, surge absorber, or telephone earth wire. If earthing is not complete, it may cause an electric shock or fire.
- ▶ Be sure to install both an earth leakage detector and circuit breaker with specified capacity in accordance with relevant local and national regulations.
 - If it is not installed properly, it may cause electric shocks and fire.
- ▶ Make sure that the condensed water runs well out of the unit at low ambient temperature. Drain pipe and cond heater frost/ice can not grow. If drain work is not effective for releasing condensed water, it can make the units get damaged by massive ice and system can be stop , covered by ice.
- ▶ Install the power cable and communication cable of the indoor and outdoor unit at least 1m away from the electric appliance.
- ▶ Protect the unit from rats or small animals. If an animal makes a contact with the electric parts, it can cause malfunctions, smoke or fire. Please instruct the customer to keep the area around the unit clean.
- ▶ Do not disassemble and alter the heater at your own discretion.
- ▶ Be sure not to perform power cable modification, extension wiring, and multiple wire connection.
 - It may cause electric shock or fire due to poor connection, poor insulation, or current limit override.
 - When extension wiring is required due to power line damage, refer to “How to connect your extended power cables” in the installation manual.
- ▶ Do not use means to accelerate the defrost operation or to clean, other than those recommended by Samsung.
- ▶ Do not pierce or burn.
- ▶ Be aware that refrigerants may not contain an odour.



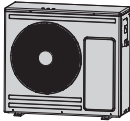
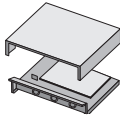

Product specifications

Product line-up

Line-up			Remark
Heat pump units	Chassis		-
	Model name	AE050RXYDEG	
Auxiliary parts	 Control kit	MIM-E03CN	Requisite

Accessories

- ▶ Keep supplied accessories until the installation is finished.
- ▶ Hand the installation manual over to the customer after finishing installation.
- ▶ The quantities are indicated in parentheses.

Installation manual (1)	Manual Instruction (1)	Drain plug (1)	Rubber Leg(4)	Wire for silent model
				

Outdoor unit specification

Type	Unit	AE050RXYDEG
Power source	-	1Φ, 220~240Vac, 50Hz
Refrigerant	g	1,000 (R-32)
Noise (Heat/Cool, Pressure)	dB(A)	45 / 45
Water connection (In/Out)	Inch	1.0
Leaving water temperature	°C	Heating : 15~65 Cooling : 5~25
Operating range (Heat/Cool)	°C	-25~35/10~46
Weight (net/gross)	kg	58.5 / 62.5
Size (WxHxD, net)	mm	880 x 798 x 310

* At the temperature -25 °C ~ -20 °C, operation is available but capacity cannot be guaranteed.

Application examples



WARNING

- The application examples given below are for illustration purposes only.
- When the SAMSUNG Air-to-Water Heat Pump system is used in series with another heat source (e.g. gas boiler), ensure that the return water temperature not exceed 65°C.
- The unit is only to be used in a closed water system. Application in an open water circuit can lead to excessive corrosion of the water piping.
- SAMSUNG can not be put responsible for incorrect or unsafe situations in the water system. Make sure that the boiler, radiators, convectors, solar collectors, UFHs, FCUs, additional pumps, pipings, and controls in the water system are in accordance with relevant local laws and regulations under the installer's responsibility.
- By-pass valve shall be installed for space heating loops. When one of loops or all loops are closed, water flow rate could be low condition. To keep flow rate approximately and prevent flow stop, the by-pass valve shall be installed between supply collector and return collector.
- SAMSUNG shall not be held liable for any damage resulting from not observing this rule.
- SAMSUNG do not provide specific water system components such as Pressure relief valve, Air vent valve, buffer tank and etc. Installers and end-users shall consider how to install the above designated components in overall water system depending on the installation conditions. If the components are not installed in appropriate location, the water system can not be operated as designed.

Application #1

Mono outdoor + Control kit

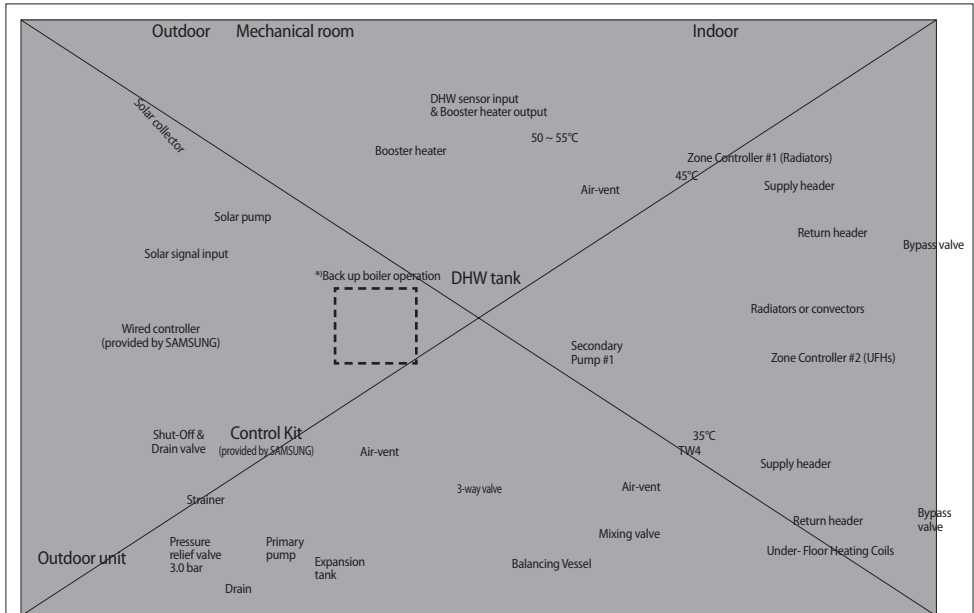

*) We control only the on / off signal of backup boiler according to outdoor temperature.
 backup boiler should be installed with own device according to the field condition.



CAUTION

- Samsung has not responsible for performance and stability of backup boiler.

Application examples

Application #2

Mono outdoor + Tank Integrated Hydro Unit

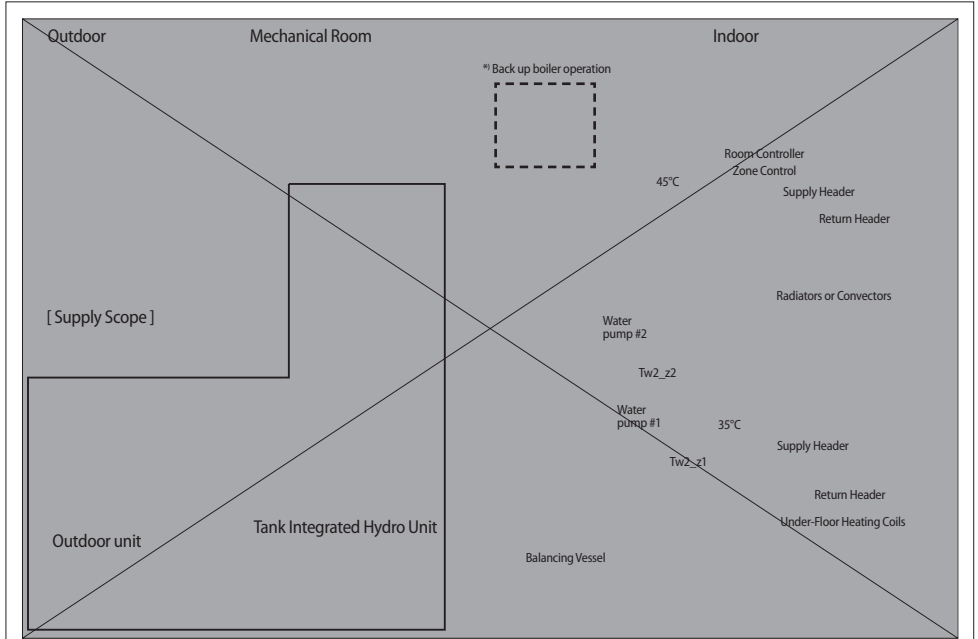

*1) We control only the on / off signal of backup boiler according to outdoor temperature.
Backup boiler should be installed with own device according to the field condition.



• Samsung has not responsible for performance and stability of backup boiler.

Main components

Dimensions(Overall)

Heat pump for R-32.

(Unit : mm)

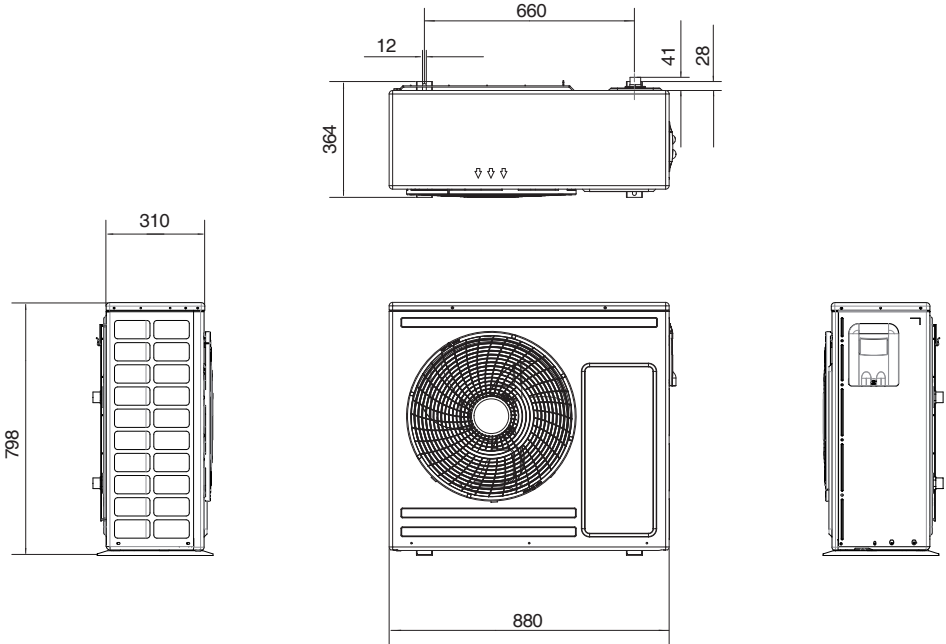

Dimensions (Water pipe)

(Unit : mm)

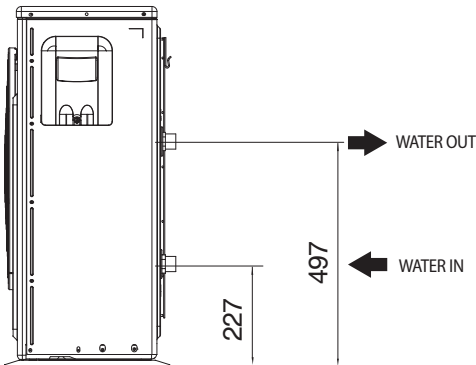

Main components

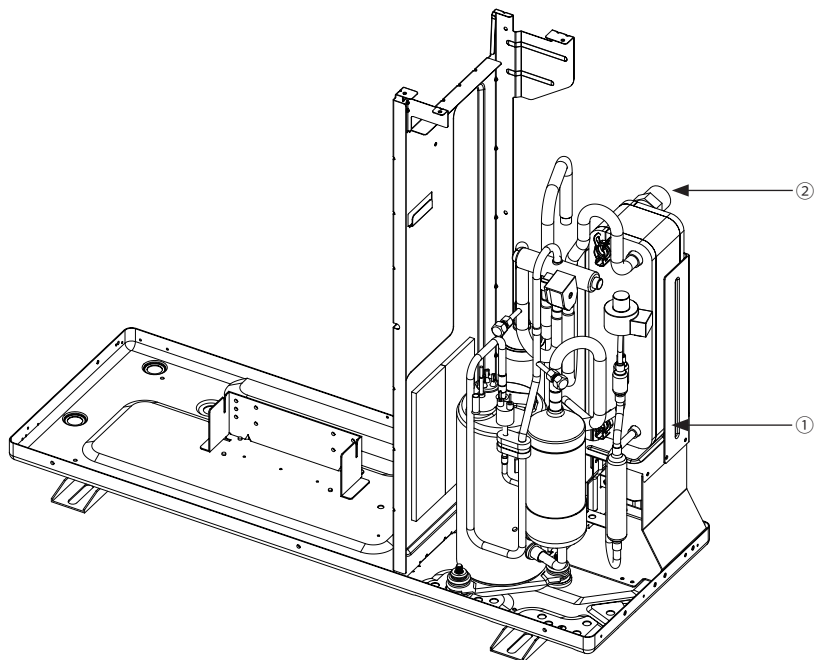

NO.	Name	Note.
①	PHE	Danfoss, H30L series
②	Water fitting	BSP 1" Male

Functional diagram

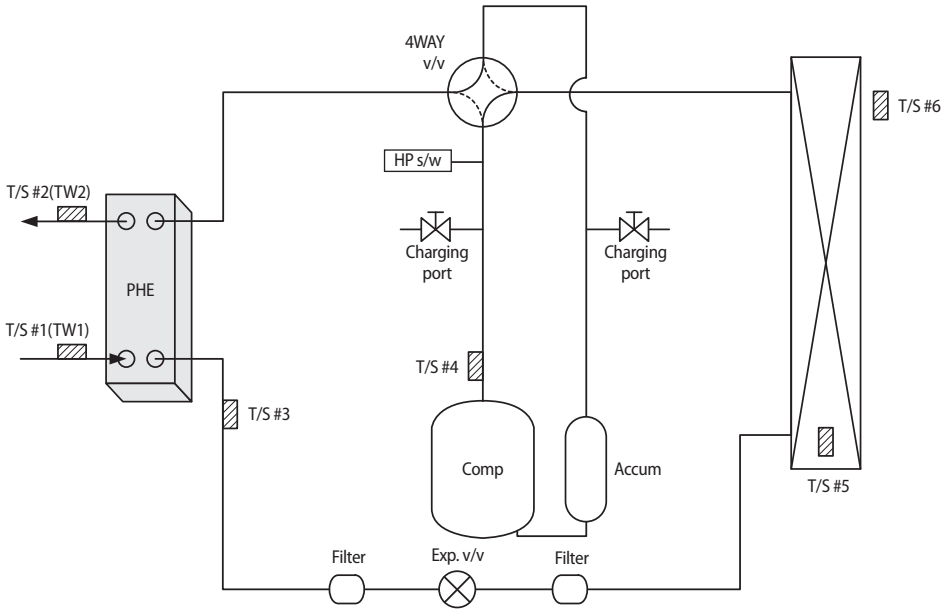

Part	Description
PHE	Plate heat exchanger
T/S #1	For water inlet temp sensor
T/S #2	For water outlet temp sensor
T/S #3	For PHE temp sensor
T/S #4	For discharge temp
T/S #5	For cond temp
T/S #6	For ambient temp sensor
Charging port	For refrigerants
Accum	Accumulator

Installing the unit

Moving the outdoor unit

- ▶ Select the moving route in advance.
- ▶ Be sure that moving route is safe from weight of the outdoor unit.
- ▶ Do not slant the product more than 30° when carrying it. (do not lay the product down sideways)
- ▶ The surface of the heat exchanger is sharp. Be carefule not to be injured while moving and installing.

Moving the outdoor unit by wire rope

- ▶ Fasten the outdoor unit by two 8m or longer wire ropes as shown at the figure. To prevent from damage or scratches, insert a piece of cloth between the outdoor unit and rope, then move the unit.

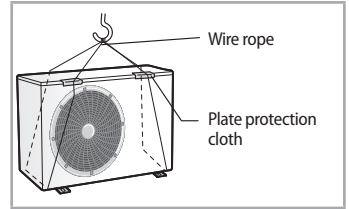

- * The appearance of the unit may be different from the picture depending on the model.

Deciding on where to install the outdoor unit

Decide the installation location regarding the following condition and obtain the user's approval.

- ▶ The outdoor unit must not be placed on its side or upside down, as the compressor lubrication oil will run into the cooling circuit and seriously damage the unit.
- ▶ Choose a location that is dry and sunny, but not exposed to direct sunlight or strong winds.
- ▶ Do not block any passageways or thoroughfares.
- ▶ Choose a location where the noise of the Air to Water Heat Pump when running and the discharged air do not disturb any neighbours.
- ▶ Choose a position that enables the pipes and cables to be easily connected to the other hydraulic system.
- ▶ Install the outdoor unit on a flat, stable surface that can support its weight and does not generate any unnecessary noise and vibration.
- ▶ Position the outdoor unit so that the air flow directly stream towards the open area.
- ▶ Place the outdoor unit where there are no plants and animals because they may cause malfunction of outdoor unit.
- ▶ Maintain sufficient clearance around the outdoor unit, especially from a radio, computer, stereo system, etc.

Installation Guide at the seashore

Make sure to follow below guides when installing at the seashore.

1. Do not install the product in a place where it is directly exposed to sea water and sea breeze.
 - Make sure to install the product behind a structure (such as building) that can block sea breeze.
 - Even when it is inevitable to install the product in seashore, make sure that product is not directly exposed to sea breeze by installing a protection wall.
 2. Consider that the salinity particles clinging to the external panels should be sufficiently washed out.
 3. Because the residual water at the bottom of the outdoor unit significantly promotes corrosion, make sure that the slope does not disturb drainage.
 - Keep the floor level so that rain does not accumulate.
 - Be careful not to block the drain hole due to foreign substance
 4. When product is installed in seashore, periodically clean it with water to remove attached salinity.
 5. Make sure to install the product in a place that provides smooth water drainage. Especially, ensure that the base part has good drainage.
 6. If the product is damaged during the installation or maintenance, make sure to repair it.
 7. Check the condition of the product periodically.
 - Check the installation site every 3 months and perform anti-corrosion treatment such as R-Pro supplied by SAMSUNG (Code : MOK-220SA) or commercial water repellent grease and wax, etc., based on the product condition.
 - When the product is to be shut down for a long period of time, such as off-peak hours, take appropriate measures like covering the product.
 8. If the product installed within 500m of seashore, special anti-corrosion treatment is required.
- * Please contact your local SAMSUNG representative for further details.

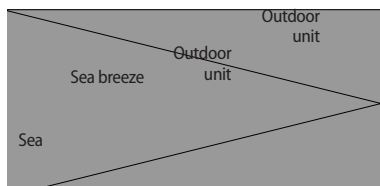

Installing the unit

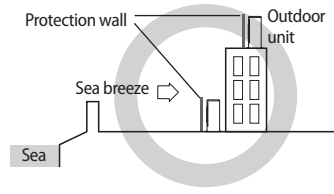
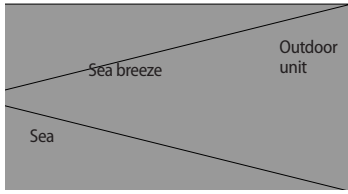

Protection wall should be constructed with a solid material that can block the sea breeze and the height and width of the wall should be 1.5 times larger than the size of the outdoor unit. (You must secure more than 700mm of space between the protection wall and the outdoor unit for air circulation.)



• Depending on the condition of power supply, unstable power or voltage may cause malfunction of the parts or control system. (At the ship or places using power supply from electric generator, etc.)

- ▶ Do not install the Air to Water Heat Pump in following places.
 - The place where there is mineral oil or arsenic acid. There is a chance that parts may get damaged due to burned resin. The capacity of the heat exchanger may reduce or the Air to Water Heat pump may be out of order.
 - The place where corrosive gas such as sulfurous acid gas generates from the vent pipe or air outlet. The copper pipe or connection pipe may corrode and refrigerant may leak.
 - The place where there is a danger of existing combustible gas, carbon fiber or flammable dust. The place where thinner or gasoline is handled.



• This device must be installed according to the national electrical rules.
• With an outdoor unit having net weight upper than 60kg, we suggest do not install it suspended on wall, but considering floor standing one.

- ▶ If the outdoor unit is installed at a height, ensure that its base is firmly fixed in position.
- ▶ Make sure that the water dripping from the drain hose runs away correctly and safely.
- ▶ When you install the outdoor unit at wayside, you should install it above 2m height or make sure that the heat from the outdoor unit shouldn't be in direct contact with passersby. (The ground for application :The revision of regulation for facility in building by the law of the Ministry of Construction and Transportation.
- ▶ While in installation or relocation of the product, do not mix the refrigerant with other gases including air or unspecified refrigerant. Failure to do so may cause pressure increase to result in rupture or injury.
- ▶ Do not cut or burn the refrigerant container or pipings.
- ▶ Use clean parts such as manifold gauge, vacuum pump, and charging hose for the refrigerant.
- ▶ Installation must be carried out by qualified personnel for handling the refrigerant. Additionally, reference the regulations and laws.
- ▶ Be careful not to let foreign substances (lubricating oil, refrigerant other than R-32, water, etc.) enter the pipings.
- ▶ When mechanical ventilation is required, ventilation openings shall be kept clear of obstruction.
- ▶ For disposal of the product, follow the local laws and regulations.
- ▶ Do not work in a confined place.
- ▶ The work area shall be blocked.
- ▶ The refrigerant pipings shall be installed in the position where there are no substances that may result in corrosion.

- ▶ The following checks shall be performed for installation:
 - The ventilation devices and outlets are operating normally and are not obstructed.
 - Markings and signs on the equipment shall be visible and legible.
- ▶ Upon leakage of the refrigerant, ventilate the room. When the leaked refrigerant is exposed to flame, it may cause generation of toxic gases.
- ▶ Make sure that the work area is safe from flammable substances.
- ▶ To purge air in the refrigerant, be sure to use a vacuum pump.
- ▶ Note that the refrigerant has no odour.
- ▶ The units are not explosion proof so they must be installed with no risk of explosion.
- ▶ This product contains fluorinated gases that contribute to global greenhouse effect. Accordingly, do not vent gases into the atmosphere.
- ▶ For installation with handling the refrigerant(R-32), use dedicated tools and piping materials.
- ▶ Servicing and installation shall be performed as recommended by the manufacturer. In case other skilled persons are joined for servicing, it shall be carried out under supervision of the person who is competent in handling flammable refrigerants.
- ▶ For servicing the units containing flammable refrigerants, safety checks are required to minimise the risk of ignition.
- ▶ Servicing shall be performed following the controlled procedure to minimize the risk of flammable refrigerant or gases.
- ▶ Do not install where there is a risk of combustible gas leakage.
- ▶ Do not place heat sources.
- ▶ Be cautious not to generate a spark as follows:
 - Do not remove the fuses with power on.
 - Do not disconnect the power plug from the wall outlet with power on.
 - It is recommended to locate the outlet in a high position. Place the cords so that they are not tangled.
- ▶ If the indoor unit is not R-32 compatible, an error signal appears and the unit will not operate.
- ▶ After installation, check for leakage. Toxic gas may be generated and if it comes into contact with an ignition source such as fan heater, stove, and cooker. cylinders, make sure that only the refrigerant recovery cylinders are used.
- ▶ Never directly touch any accidental leaking refrigerant.
- ▶ This could result in severe wounds caused by frostbite.

Preparation of fire extinguisher

- ▶ If a hot work is to be done, an appropriate fire extinguishing equipment should have been available.
- ▶ A dry powder or CO₂ fire extinguisher shall be equipped near the charging area.

Ignition sources free

- ▶ Make sure to store the units in a place without continuously operating ignition sources (for example, open flames, an operating gas appliance or an operating electric heater).
- ▶ The service engineers shall not use any ignition sources with the risk of fire or explosion.
- ▶ Potential ignition sources shall be kept away from the work area where the flammable refrigerant can possibly be released to the surrounding.
- ▶ The work area should be checked to ensure that there are no flammable hazards or ignition risks. The “No Smoking” sign shall be attached.
- ▶ Under no circumstances shall potential sources of ignition be used while in detection of leakage.
- ▶ Make sure that the seals or sealing materials have not degraded.
- ▶ Safe parts are the ones with which the worker can work in a flammable atmosphere. Other parts may result in ignition due to leakage.
- ▶ Replace components only with parts specified by Samsung. Other parts may result in the ignition of refrigerant in the atmosphere from a leak.

Installing the unit

Area ventilation

- ▶ Make sure that the work area is well ventilated before performing a hot work.
- ▶ Ventilation shall be made even during the work.
- ▶ The ventilation should safely disperse any released gases and preferably expel them into the atmosphere.
- ▶ Ventilation shall be made even during the work.

Leakage detection methods

- ▶ The leakage detector shall be calibrated in a refrigerant-free area.
- ▶ Make sure that the detector is not a potential source of ignition.
- ▶ The leakage detector shall be set to the LFL (lower flammability limit).
- ▶ The use of detergents containing chlorine shall be avoided for cleaning because the chlorine may react with the refrigerant and corrode the pipings.
- ▶ If leakage is suspected, naked flames shall be removed.
- ▶ If a leakage is found while in brazing, the entire refrigerant shall be recovered from the product or isolated (e.g. using shut-off valves). It shall not be directly released to the environment. Oxygen free nitrogen (OFN) shall be used for purging the system before and during the brazing process.
- ▶ The work area shall be checked with an appropriate refrigerant detector before and during work.
- ▶ Ensure that the leakage detector is appropriate for use with flammable refrigerants.

Labelling

- ▶ The parts shall be labelled to ensure that they have been decommissioned and emptied of refrigerant.
- ▶ The labels shall be dated.
- ▶ Make sure that the labels are affixed on the system to notify it contains flammable refrigerant.

Recovery

- ▶ When removing refrigerant from the system for servicing or decommissioning, it is recommended to remove the entire refrigerant.
- ▶ When transferring refrigerant into cylinders, make sure that only the refrigerant recovery cylinders are used.
- ▶ All cylinders used for the recovered refrigerant shall be labelled.
- ▶ Cylinders shall be equipped with pressure relief valves and shut-off valves in a proper order.
- ▶ The recovery system shall operate normally according to the specified instructions and shall be suitable for refrigerant recovery.
- ▶ In addition, the calibration scales shall operate normally.
- ▶ Hoses shall be equipped with leak-free disconnect couplings.
- ▶ Before starting the recovery, check for the status of the recovery system and sealing state. Consult with the manufacturer if suspected.
- ▶ The recovered refrigerant shall be returned to the supplier in the correct recovery cylinders with the Waste Transfer Note attached.
- ▶ Do not mix refrigerants in the recovery units or cylinders.
- ▶ If compressors or compressor oils are to be removed, make sure that they have been evacuated to the acceptable level to ensure that flammable refrigerant does not remain in the lubricant.
- ▶ The evacuation process shall be performed before sending the compressor to the suppliers.
- ▶ Only the electrical heating to the compressor body is allowed to accelerate the process.
- ▶ Oil shall be drained safely from the system.
- ▶ Never install a motor-driven equipment to prevent ignition.
- ▶ Empty recovery cylinders shall be evacuated and cooled before recovery.

Installation location requirements

- ▶ The outdoor unit shall be installed in an open space that is always ventilated.
- ▶ The local gas regulations shall be observed.
- ▶ For installation inside a building (this applies either to indoor or outdoor units installed inside) a minimum room floor area of space conditioned is mandatory according to IEC 60335-2-40:2018 (see the reference table into either the indoor or outdoor unit installation manual).
- ▶ To handle, purge, and dispose the refrigerant, or break into the refrigerant circuit, the worker should have a certificate from an industry-accredited authority.
- ▶ Do not install the indoor unit if it has any drainage problem.

Installing the unit

Space requirements for outdoor unit

When installing 1 outdoor unit

(Unit : mm)

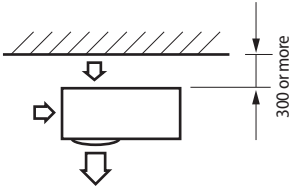

- * When the air outlet is opposite the wall

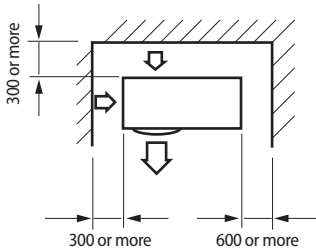

- * When 3 sides of the outdoor unit are blocked by the wall

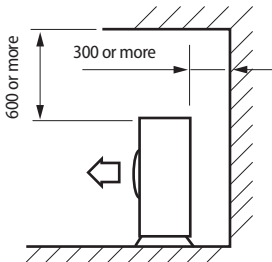

- * The upper part of the outdoor unit and the air outlet is opposite the wall

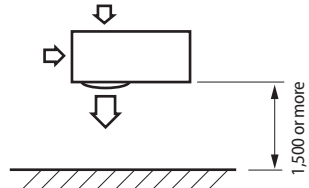

- * When the air outlet is towards the wall

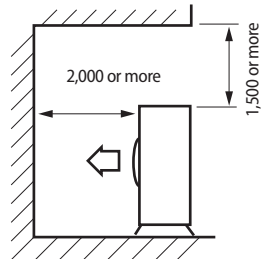

- * The upper part of the outdoor unit and the air outlet is towards the wall

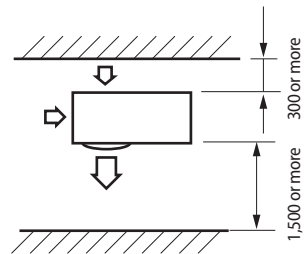

- * When front and rear side of the outdoor unit is towards the wall

When installing more than 1 outdoor unit

(Unit : mm)

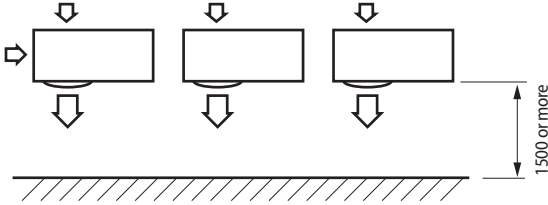

* When the air outlet is towards the wall

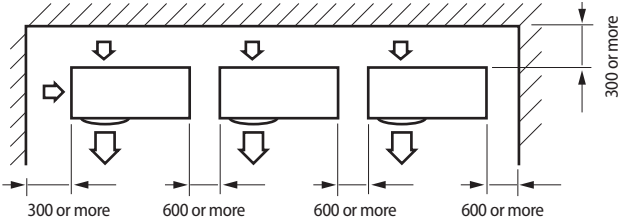

* When 3 sides of the outdoor unit are blocked by the wall

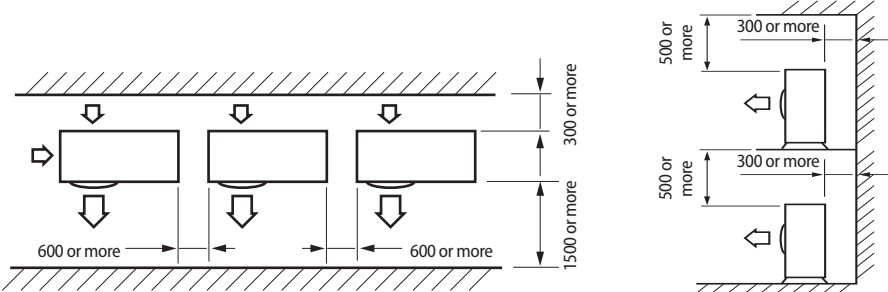

* When front and rear side of the outdoor unit is towards the wall

* The upper part of the outdoor unit and the air outlet is opposite the wall

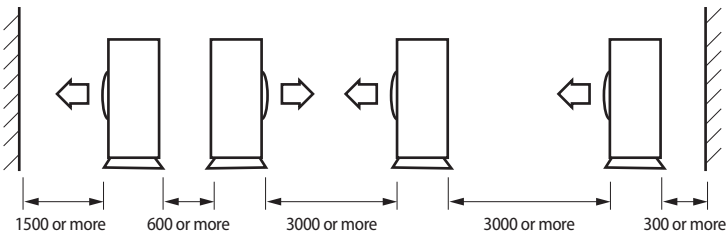

* When front and rear side of the outdoor unit is towards the wall



The units must be installed according to distances declared, in order to permit accessibility from each side, either to guarantee correct operation of maintenance or repairing products. The unit's parts must be reachable and removable completely under safety condition (for people or things).

Installing the unit

Outdoor unit installation

The outdoor unit must be installed on a rigid and stable base to avoid any increase in the noise level and vibration, particularly if the outdoor unit is to be installed in a location exposed to strong winds or at a height, the unit must be fixed to an appropriate support (wall or ground).

- ▶ Fix the outdoor unit with anchor bolts.



- The anchor bolt must be 20mm or higher from the base surface.



- When tightening the anchor bolt, tighten the rubber washer to prevent the outdoor unit bolt connection part from corroding.
- Make a drain outlet around the base for outdoor unit drainage.
- If the outdoor unit is installed on the roof, you have to check the ceiling strength and waterproof the unit.

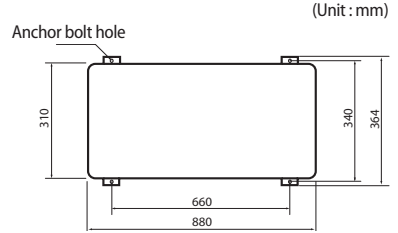

Outdoor unit support

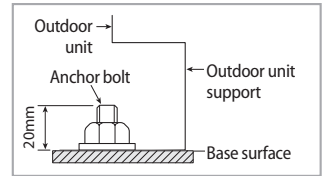
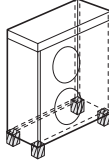
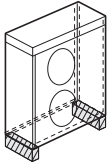

OUTDOOR UNIT INSTALLED ON THE WALL BY RACK

- ▶ Ensure the wall will be able to suspend the weight of rack and outdoor unit ;
- ▶ Install the rack close to the column as much as possible ;
- ▶ Install proper grommet in order to reduce noise and residual vibration transferred by outdoor unit towards wall.



When installing air guide duct

- Check and make sure that screws do not damage the copper pipe.
- Secure air guide duct on guard fan.

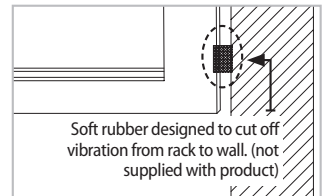
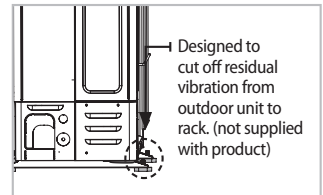

Drain work

• General area

While Air-Water Heat Pump is running in heating mode, Ice can begin accumulate on the surface of condenser. To prevent Ice from growing, system go into De-frost mode and then Ice on the surface changes to water.

Dropped water from condenser shall be eliminated through running drain holes to prevent Ice growing at low temperature.

- ▶ In case there is not enough space for drainage out of the unit, additional drain works are required. Follow the description as below
 - Make space more than 100mm between the bottom of the outdoor unit and the ground for installation of the drain hose.
 - Insert the drain plug into the hole on the bottom of the outdoor unit.
 - Connect the drain hose to the drain plug.
 - Make sure dusts or small branches should not go into the drain hose.

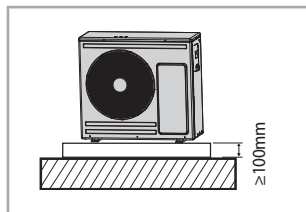

WARNING

- If drain work is not enough, it can lead to system performance degradation and system damages.

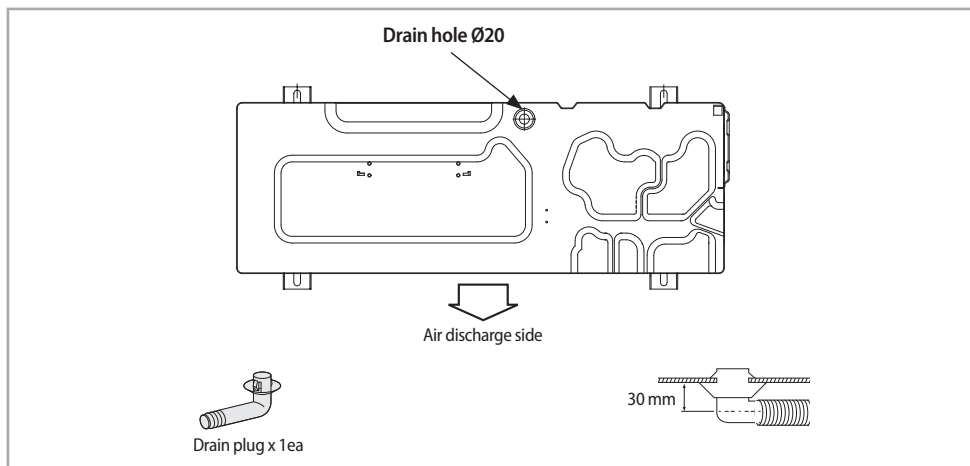

1. Prepare a water drainage channel around the foundation, to drain waste water from around the unit.
2. If the water drainage of the unit is not easy, please build up the unit on a foundation of concrete blocks, etc. (the height of the foundation should be maximum 150 mm).
3. If you install the unit on a frame, please install a waterproof plate within 150 mm of the underside of the unit in order to prevent the invasion of water from the lower direction.
4. When installing the unit in a place frequently exposed to snow, pay special attention to elevate the foundation as high as possible.
5. If you install the unit on a building frame, please install a waterproof plate (field supply) (within 150mm of the underside of the unit) in order to avoid the drain water dripping. (See figure)

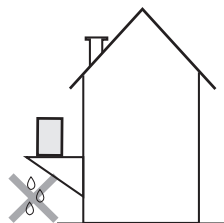

Installing the unit

• Heavy snow fall area (Natural drainage)

- ▶ When using the air conditioner in the heating mode, ice may accumulate. During de-icing (defrost operation), the condensed water must be drained off safely. For the air conditioner operates well, you must follow the instructions below.
 - Make space more than 80mm between the bottom of the outdoor unit and the ground for installation.

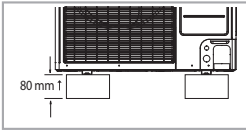

- If the product is installed in a region of heavy snow, allow enough separation distance between the product and the ground.
- When installing the product, make sure that the rack is not placed under the drain hole.
- Ensure that the drained water runs off correctly and safely.



CAUTION

- In areas with heavy snow fall, piled snow could block the air intake. To avoid this incident, install a frame that is higher than estimated snow fall. In addition, install a snow-proof hood to avoid snow from piling on the outdoor unit.
- If ice accumulates on the base, it may cause critical damage to the product. (e.g., a lakeside in a cold area, the seashore, an alpine region, etc.)
- In a heavy snowfall area, do not install the drain plug and drain cap into the outdoor unit. And, it may cause frozen ground. Therefore, take appropriate measures to prevent it.

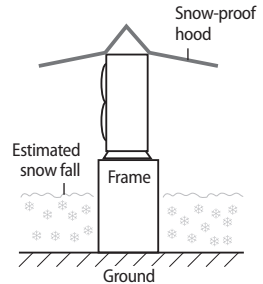

Selecting a location in cold climates



• When operating the unit in a low outdoor ambient temperature, be sure to follow the instructions described below.

- ▶ To prevent exposure to wind, install the unit with its suction side facing the wall.
- ▶ Never install the unit at a site where the suction side may be exposed directly to wind.
- ▶ To prevent exposure to wind, install a baffle plate on the air discharge side of the unit.
- ▶ In heavy snowfall areas it is very important to select an installation site where the snow will not affect the unit. If lateral snowfall is possible, make sure that the heat exchanger coil is not affected by the snow (If necessary construct a lateral canopy)

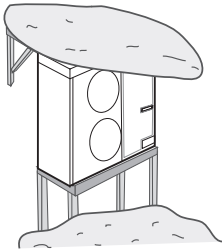

1. Construct a large canopy.
2. Construct a pedestal.
 - Install the unit high enough off the ground to prevent it being buried under snow.

- ▶ The outdoor unit should be installed with consideration of the direction of strong winds. These can make the unit turn over, so the side of the unit should be set to face the wind, not the front of the unit.

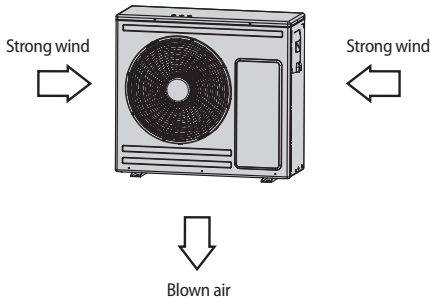

Piping work

Water connections must be made in accordance with the outlook diagram delivered with the unit, respecting the water in- and outlet. If air, moisture or dust gets in the water circuit, problems may occur. Therefore, always take into account the following when connecting the water circuit:

- ▶ Use clean pipes only.
- ▶ Hold the pipe end downwards when removing burrs.
- ▶ Cover the pipe end when inserting it through a wall so that no dust and dirt enter.
- ▶ Use a good thread sealant for the sealing of the connections.
The sealing must be able to withstand the pressures and temperatures of the system.
- ▶ When using non-brass metallic piping, make sure to insulate both materials from each other to prevent galvanic corrosion.
- ▶ Because brass is a soft material, use appropriate tooling for connecting the water circuit. Inappropriate tooling will cause damage to the pipes.

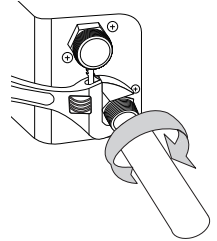

- Be careful not to deform the unit piping by using excessive force when connecting the piping. Deformation of the piping can cause the unit to malfunction.
- Always use two wrenches (spanners) for tightening or loosening the water connections, and tighten connections with a torque wrench as specified in below table. If not, connections and parts can be damaged and leaks.
- The unit is only to be used in a closed water system. If applications are in open water circuit, it will generate Heat exchangers fouling, Corrosion, Leak.

	Name	Tightening torque	
1	BSPP1	350~380 kgf·cm	34 ~ 37 N·m

Flushing and air-purging

When filling water, the following start-up procedure should be followed.

1. All system components and pipes must be tested for the presence of leaks.
2. Preparation of a make-up water assembly or flushing unit is recommended for installation and service.
3. Before connecting pipes to the Outdoor Unit, flush water pipes clean to remove contaminants during hours using a flushing unit or tap water pressure if it is adequate (at 2 to 3 bar)
4. Fill water into the Outdoor Unit by opening shut-off & drain valve.
5. Purge the air. (Fill with a flushing unit with sufficient capacity: avoid aerating the water)
6. Circulate for long enough to ensure that all air has been bled from the complete water piping system.



- After installations, commissioning should be performed by qualified representatives. Unless flushing and air-purging works are performed adequately, it might result in malfunctions.



Flushing unit
(or purging cart)



CAUTION

• **Before installing/commissioning the unit, make sure to check the following points :**

- The maximum water pressure of the unit is 2.9 bar static pressure.
- The operating range of leaving water temperature is 15~65°C at heating conditions and 5~25°C at cooling conditions.
- The minimum required water flow for operation is 16 liters/min. At all times the required water flow-rates should remain. Otherwise, the unit can stop due to a lack of water.
- Water quality must be according to EN directive 98/83 EC.
- If the unit and the pipes are exposed to freezing temperature, it can cause damage to the hydraulic system. Special care must be taken to prevent freezing of the total water system.
- The unit is designed to be used in a closed-loop system. Do not use any other components which are designed only for an open-loop system.
- Never use Zn-coated parts in the water circuit.
- All hydraulic parts including field piping must be insulated to reduce heat loss and condensation.
- It is recommended to install the make-up water assembly to feed small quantities of water to the system automatically, replacing the minor water losses and maintaining the system pressure.
- Drain taps must be provided at all low points of the system to permit complete drainage of the circuit for maintenance use.
- Make sure that the check valves are correctly installed in the system (field supply).
- Flush pipes out with clean water to remove contaminants in pipes during installation.
- The strainer(water filter) must be cleaned after flushing the pipes, and it should be cleaned periodically. Replace strainer when necessary.
- Charging : Charge the water until a pressure of 1.5~2.0bar by using make-up water assembly(Field supply). (The water pressure indicated on the manometer will vary depending on the water temperature)
The nominal water pressure in the system should remain about 1.0 bar at all times to avoid air entering the water system.
- Air purging; Make sure that air should be vented from the system at start-up or after installing/ servicing. The air vent valve must be opened during charging the water (at least 2 turns) in order to remove all air in the circuit, and a make-up water assembly allows water into the system continuously.
- In case that the water piping would be located in a higher position than the air vent of the unit, it is necessary to add an additional one in the highest position of water circuit. The air vent should be located both where water temperatures are the highest and where the height of pipes are the highest.
- Always use materials which are compatible with water used in the system and with the materials used on the indoor unit.
- Select piping diameter in relation to required water flow and available ESP of the pump.
- Use chemical cleaning agents(Begin with acid , finish with alkali).
- Do not operate the system with closed valves because it results in damaging the heat pump.

Piping work

Primary water circuit freeze protection

If the ambient temperature is below freezing conditions, freezing of water in the primary circuit (outdoor unit and pipework) may occur during power failure or temporary loss of power by SmartGrid activation. To prevent damaging of the product (outdoor unit and pipework) due to freezing, we advise to add antifreeze according to below stated table.

Freeze protection solutions must use propylene glycol with a toxicity rating of Class 1 as listed in Clinical Toxicology of Commercial Products, 5th Edition.



- Ethylene glycol is toxic and must not be used in the primary water circuit in case of any cross-contamination of the potable circuit.

Freezing Points of Propylene Glycol - Water Mixtures		
Percent Propylene Glycol [wt. %]	Freezing Point [°F]	Freezing Point [°C]
0	32	0
10	26	-3
20	20	-7
30	10	-12
36	0	-18
40	-5	-20
43	-10	-23
48	-20	-29

Setting capacity and pre-pressure of the expansion vessel

When it is required to change the default pre-pressure of the expansion vessel(1 bar), keep in mind the following guidelines:

- Use only dry nitrogen to set the expansion vessel pre-pressure.
- Inappropriate setting of the expansion vessel pre-pressure will lead to malfunction of the system. Therefore, the pre-pressure should only be adjusted by a licensed installer.

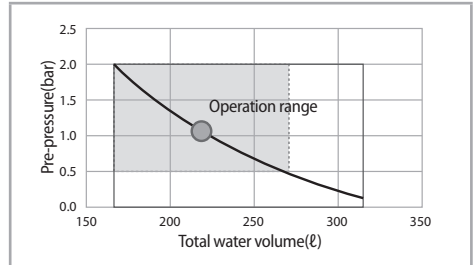

Installation height difference(a)	Water volume	
	< 220 Litres	> 220 Litres
<7m	No pre-pressure adjustment required.	Actions required: <ul style="list-style-type: none"> Pre-pressure must be decreased, calculate according to "Calculating the pre-pressure of the expansion vessel". Check if the water volume is lower than maximum allowed water volume.
>7m	Actions required: <ul style="list-style-type: none"> Pre-pressure must be increased, calculate the appropriate value following by "Calculating the pre-pressure of the expansion vessel". Check if the water volume is lower than maximum allowed water volume. 	Expansion vessel of the unit too small for the installation.

(a) Installation height difference: height difference(m) between the highest point of the water circuit and the indoor unit. If the unit is located at the highest point of the installation, the installation height is considered 0m.

- When Expansion vessel has a capacity 8 liters and 1bar pre-charged.
Water volume of total system for reliable performance is minimum 30 liters.

Calculating the pre-pressure of the expansion vessel

- ▶ The pre-pressure(P_g) to be set depends on the maximum installation height difference(H) and is calculated as below :

$$P_g = (H/10 + 0.3) \text{ bar}$$

Unit resistance and PHE resistance by glycol concentrate

The unit is composed of water pipes and PHE basically.

To ensure correct operation and predict the expected performance, Flow and Resistance table can be used and Flow and Resistance characteristic is dependent on Glycol concentration.

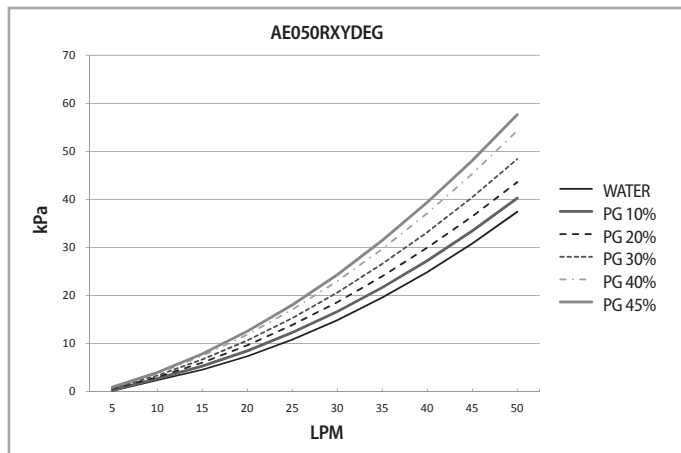

Changing Glycol concentration can cause the pressure drop of the system and it can lead to make flow rate rather slow. Just in case performance degradation, installer shall be careful of flow rate changes.

Piping work

Flow sensor

Flow sensor is not integrated part in MONO Unit. But the installation is essential to operate MONO Unit. Flow sensor is provided by Samsung control kit as a sub component.



- Flow sensor shall be installed described by installation manual of Mono unit or Control kit.
- All electric wiring works shall be implemented by manuals which Samsung provided.
- Before completing the installation works, make sure to check if the flow sensor is installed in horizontal or vertical like as below figure.
- If flow direction is in parallel with pipe direction. Straight length of In pipe of flow sensor shall have 10 times length in diameter and Straight length of Out pipe of flow sensor shall have 5 times length in diameter.
- When mechanical vibrations are delivered from the pump or compressor, measurement errors may occur. Select the installation location so that no vibrations are delivered to the sensor.

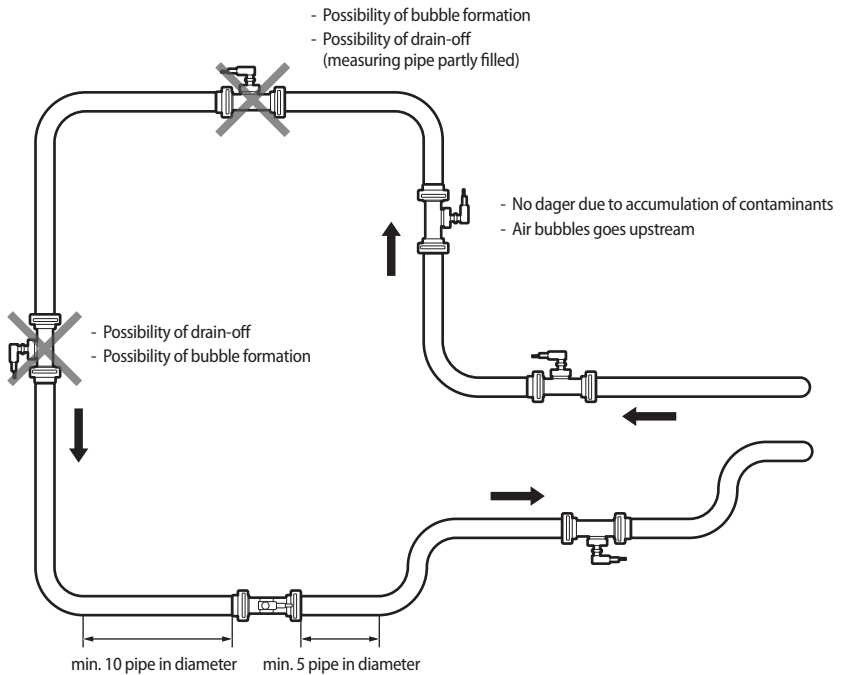

Charging water

After installation is completed, the following procedures shall be used to charge water into the Outdoor Unit.

- ▶ Connect water lines to water connections of Air-Water Heat Pump.
- ▶ Air vent valve shall be open at least 2turns so that air can be eliminated in the system.
- ▶ Open the shut-off & drain valve in the water supply connection.
- ▶ Water pressure of supply line shall be over 2.0 bar for good charging work.
- ▶ Stop water supply when the pressure indicates around 2.0 bar.

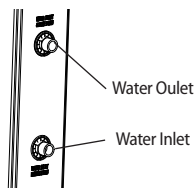

CAUTION

- There shall be enough space for Service works.
- Water pipe and connections shall be cleaned by using water or cleaner before operating the unit at first time.
- Considering E.S.P and water pump performance, select water plumbing specification and under floor loofs.
- Make sure to calculate the total resistance of piping system and determine the size of pipes before selecting the required head of pumps. If the pressure loss of total water system is over than designed pressure, an external water pump shall be installed on piping system in series.
- Do not connect power supply while water is charging.
- When initial installation or re-installation is required, remove air by air vent valve in water plumbings which are installed by local installers to prevent air trap in the system while charging water.
- Make sure that back flow preventer (check valves) shall be installed on main supply line to prevent from contaminating the city water.
 - It is recommended to install the make-up water assembly to prevent from contaminating the city water.
 - Check valves in the make-up water assembly can prevent running water inside Outdoor Unit from contaminating water supplies during installation or maintenance works.

Pressure relief valve

MONO Unit does not have a pressure relief valve. The valve shall prevents abnomal water pressure from damaging the the system by opening at 3.0 bar.



CAUTION

- Make certain that the discharged water out of drain pan does not affect other elements.

Filter / Strainer

Installation of Filter / Strainer is mandatory for water system. The Filter or Strainer shall be located in front of inlet pipe of PHE.

While operating the system, some dust and foreign materials can circulate the system and can make the whole system not work well due to blockage of heat exchangers and corrosion in some components.

Filter mesh : #50

Piping insulation

The complete water circuit, inclusive all piping, must be insulated to prevent condensation during cooling operation and reduction of the heating and cooling capacity as well as prevention of freezing of the outside water piping during winter time. The thickness of the sealing materials must be at least 9 mm with (0.035 W/mK) in order to prevent freezing on the outside water piping.

If the temperature is higher than 30°C and the humidity is higher than RH 80%, then the thickness of the sealing materials should be at least 20 mm in order to avoid condensation on the surface of the sealing.

Wiring

Two electronic cables must be connected to the outdoor unit.

- ▶ The connection cord between indoor unit and outdoor unit.
- ▶ The power cable between outdoor unit and auxiliary circuit breaker.
- ▶ Specially for Russian and European market, before installation, the supply authority should be consulted to determine the supply system impedance to ensure compliance.



- During the unit installation make first refrigerant connections and then electrical connections. If unit is uninstalled first disconnect electrical cables, then refrigerant connections.
- Connect the Air to water heat pump to grounding system before performing the electrical connection.
- When installing the unit, you shouldn't use inter connection wire.

Example of EHS system

When using ELB/ELCB for 1 phase (220-240Vac~)

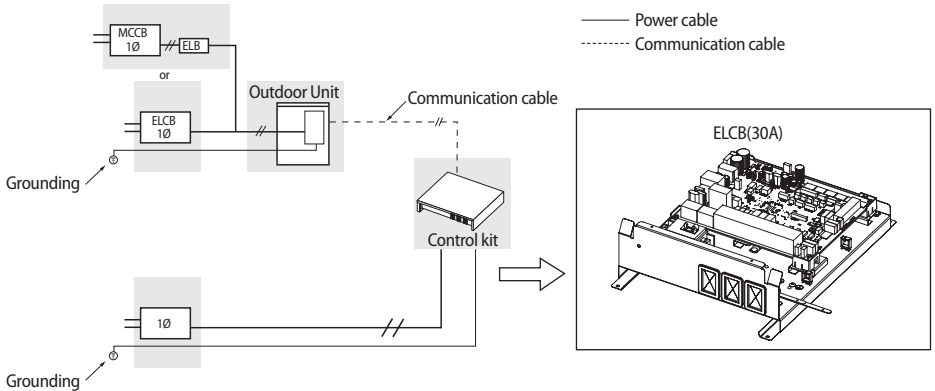

- * If an outdoor unit is installed in a place in danger of an electric leak or submergence, you must install the ELB/ELCB.
- * Installation of control kit must be followed its Installation manual.

Power Cable Specifications

1 phase

Outdoor unit	Rated		Voltage Range		MCA	MFA
	Hz	Volts	Min	Max	Min. Circuit Amps.	Max. Fuse Amps.
AE050RXYDEG	50	220-240	198	264	16.0 A	20.0 A

- ▶ The power cable is not supplied with Air to water heat pump.
- ▶ Supply cords of parts of appliances for outdoor use shall not be lighter than polychloroprene sheathed flexible cord (Code designation IEC:60245 IEC 57 / CENELEC:H05RN-F)
- ▶ This Equipment complies with IEC 61000-3-12.

Indoor Unit	Load	Power supply	Power cable	MAX. length	Type GL 
			mm ² ,wires	m	A
MIM-E03CN	No Heater (Water Pump, Valve, Wired RMC)	1Ø, 220-240Vac, 50Hz	1.5 / 3	<10m	10
			2.5 / 3	10m<L<20m	10
	Booster Heater (3kw)		4.0 / 3	<10m	20
			6.0 / 3	10m<L<20m	20
	Booster Heater (~3kw) + Backup Heater (~3kw)		6.0 / 3	<10m	40
			8.0 / 3	10m<L<20m	40

- ▶ The Power cable is not supplied with the heat pump.
- ▶ For power cable, use the grade H05RN-F materials in 1Ø system.
- ▶ If you connect Backup Heater at separated power cable, you can reduce wire size. (Please refer to control kit installation manual)

Wiring

Between indoor unit and outdoor unit connection cable specifications(Common in use)

Communication cable	Home server
0.75mm ² , 2wires	0.75mm ² , 2wires

- ▶ For the power Cable, use the grade H07RN-F or H05RN-F materials.

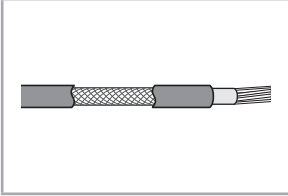

- ▶ Power supply cords of parts of appliances for outdoor use shall not be lighter than polychloroprene sheathed flexible cord. (Code designation IEC:60245 IEC 57 / CENELEC: H05RN-F or IEC:60245 IEC 66 / CENELEC: H07RN-F)
- ▶ When installing the outdoor unit in a computer room or net work room, server room or in the presence of risk of disturbance to the communication cable, use the double shielded (tape aluminium / polyester braid + copper) cable of FROHH2R type.

1-phase terminal block spec

AC power : M4 screw

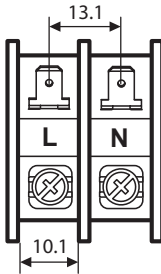

Communication : M4 screw

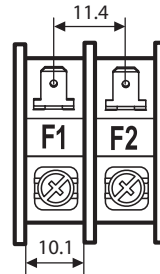

Wiring diagram of power cable

When using ELB/MCCB for 1 phase

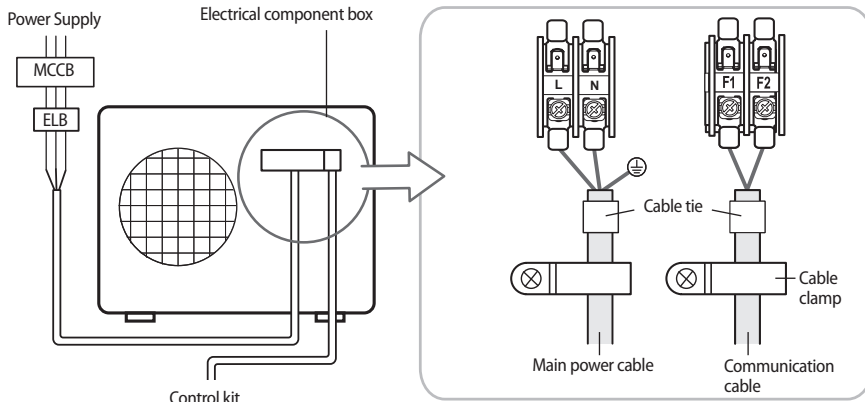

* The appearance of the unit may be different from the picture depending on the model.



CAUTION

- You should connect the power cable into the power cable terminal and fasten it with a clamp.
- The unbalanced power must be maintained within 2% of supply rating.
 - If the power is unbalanced greatly, it may shorten the life of the condenser. If the unbalanced power is exceeded over 4% of supply rating, the control kit is protected, stopped and the error mode indicates.
- To protect the product from water and possible shock, you should keep the power cable and the connection cord of the control kit and outdoor units within ducts. (with appropriate IP rating and material selection for your application)
- Ensure that main supply connection is made through a switch that disconnects all poles, with contact gap of at least 3 mm.
- Devices disconnected from the power supply should be completely disconnected in the condition of overvoltage category.
- Keep distances of 50mm or more between power cable and communication cable.

Wiring

Wiring diagram of connection cord

1 phase

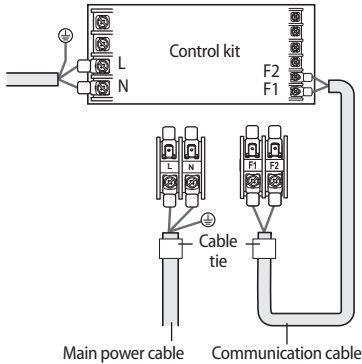

- Lay the electrical wiring so that the front cover does not rise up when doing wiring work and attach the front cover securely.
- Ground wire for the indoor unit and outdoor unit connection cable must be clamped to a soft copper tin-plated eyelet terminal with screw hole (NOT SUPPLIED WITH UNIT ACCESSORIES).

Connecting the power terminal

- ▶ Connect the cables to the terminal board using the compressed ring terminal.
- ▶ Cover a solderless ring terminal and a connector part of the power cable and then connect it.

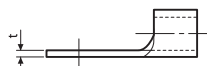
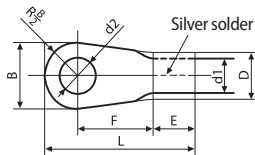

Nominal dimensions for cable [mm ² (inch)]		4/6 (0.006/0.009)		10 (0.01)	16 (0.02)	25 (0.03)		35 (0.05)		50 (0.07)	70 (0.10)
Nominal dimensions for screw [mm(inch)]		4 (3/8)	8 (3/16)	8 (3/16)	8 (3/16)	8 (3/16)		8 (3/16)		8 (3/16)	8 (3/16)
B	Standard dimension [mm(inch)]	9.5 (3/8)	15 (9/16)	15 (9/16)	16 (10/16)	12 (1/2)	16.5 (10/16)	16 (10/16)	22 (7/8)	22 (7/8)	24 (1)
	Allowance [mm(inch)]	±0.2 (±0.007)		±0.2 (±0.007)	±0.2 (±0.007)	±0.3 (±0.011)		±0.3 (±0.011)		±0.3 (±0.011)	±0.4 (±0.011)
D	Standard dimension [mm(inch)]	5.6 (1/4)		7.1 (1/4)	9 (3/8)	11.5 (7/16)		13.3 (1/2)		13.5 (1/2)	17.5 (11/16)
	Allowance [mm(inch)]	+0.3 (+0.011) -0.2 (-0.007)		+0.3 (+0.011) -0.2 (-0.007)	+0.3 (+0.011) -0.2 (-0.007)	+0.5 (+0.019) -0.2 (-0.007)		+0.5 (+0.019) -0.2 (-0.007)		+0.5 (+0.019) -0.2 (-0.007)	+0.5 (+0.019) -0.4 (-0.015)
d1	Standard dimension [mm(inch)]	3.4 (1/8)		4.5 (3/16)	5.8 (1/4)	7.7 (5/16)		9.4 (3/8)		11.4 (7/16)	13.3 (1/2)
	Allowance [mm(inch)]	±0.2 (±0.007)		±0.2 (±0.007)	±0.2 (±0.007)	±0.2 (±0.007)		±0.2 (±0.007)		+0.3 (+0.011) -0.2 (-0.007)	±0.4 (±0.015)
E	Min. [mm(inch)]	6 (1/4)		7.9 (5/16)	9.5 (5/16)	11 (3/8)		12.5 (1/2)		17.5 (11/16)	18.5 (3/4)
F	Min. [mm(inch)]	5 (3/16)	9 (3/8)	9 (3/8)	13 (1/2)	15 (5/8)	13 (1/2)	13 (1/2)		14 (9/16)	20 (3/4)
L	Max. [mm(inch)]	20 (3/4)	28.5 (1-1/8)	30 (1-3/16)	33 (1-5/16)	34 (1-3/8)		38 (1-1/2)	43 (1-11/16)	50 (2)	51 (2)
d2	Standard dimension [mm(inch)]	4.3 (3/16)	8.4 (1-3/16)	8.4 (1-3/16)	8.4 (1-3/16)	8.4 (1-3/16)		8.4 (1-3/16)		8.4 (1-3/16)	8.4 (1-3/16)
	Allowance [mm(inch)]	+0.2 (+0.007) 0(0)	+0.4 (+0.015) 0(0)	+0.4 (+0.015) 0(0)	+0.4 (+0.015) 0(0)	+0.4 (+0.015) 0(0)		+0.4 (+0.015) 0(0)		+0.4 (+0.015) 0(0)	+0.4 (+0.015) 0(0)
t	Min. [mm(inch)]	0.9 (0.03)		1.15 (0.04)	1.45 (0.05)	1.7 (0.06)		1.8 (0.07)		1.8 (0.07)	2.0 (0.078)

- ▶ Connect the rated cables only.
- ▶ Connect using a driver which is able to apply the rated torque to the screws.
- ▶ If the terminal is loose, fire may occur caused by arc. If the terminal is connected too firmly, the terminal may be damaged.

Tightening Torque (kgf • cm)		
M4		12~18
		Communication : F1, F2 3phase AC power : L1(R), L2(S), L3(T), N
M5		20~30 1phase AC power : L, N







- When connecting cables, you can connect the cables to the electrical part or connect them through the holes below depending on the spot.
- Run transmission wiring between the indoor and outdoor units through a conduit to protect against external forces, and feed the conduit through the wall together with refrigerant piping.
- Remove all burrs at the edge of the knock-out hole and secure the cable to the outdoor knock-out using lining and bushing with an electrical insulation such as rubber and so on.
- Must keep the cable in a protection tube.
- Keep distances of 50mm or more between power cable and communication cable.
- When the cables are connected through the hole, remove the Plate bottom.

Wiring

How to connect your extended power cables

1. Prepare the following tools.

Tools	Spec	Shape
Crimping pliers	MH-14	
Connection sleeve (mm)	20xØ6.5 (HxOD)	
Insulation tape	Width 19 mm	
Contraction tube (mm)	70xØ8.0 (LxOD)	

2. As shown in the figure, peel off the shields from the rubber and wire of the power cable.

- Peel off 20 mm of cable shields from the pre-installed tube.



- For information about the power cable specifications for indoor and outdoor units, refer to the installation manual.
- After peeling off cable wires from the pre-installed tube, insert a contraction tube.
- If cable wires are connected without using connecting sleeves, their contact area becomes reduced, or corrosion develops on the outer surfaces of the wires (copper wires) over a long time. This may cause an increase of resistance (reduction of passing current) and consequently may result in a fire.

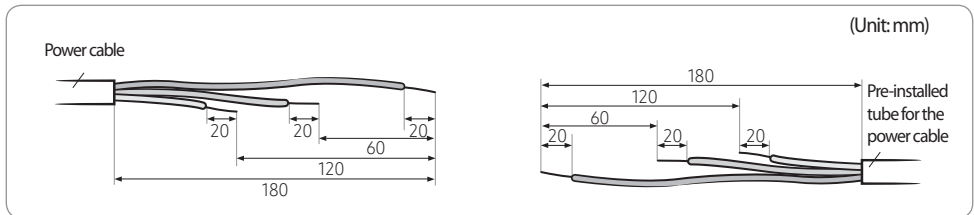

3. Insert both sides of core wire of the power cable into the connection sleeve.

- Method 1: Push the core wire into the sleeve from both sides.
- Method 2: Twist the wire cores together and push it into the sleeve.

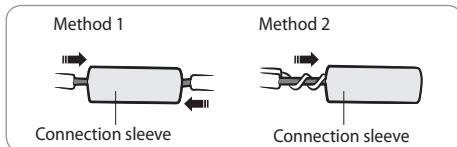

4. Using a crimping tool, compress the two points and flip it over and compress another two points in the same location.

- The compression dimension should be 8.0.

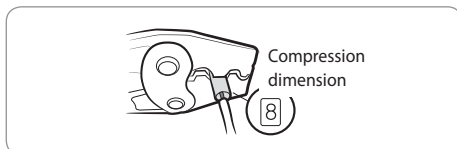

- After compressing it, pull both sides of the wire to make sure it is firmly pressed.

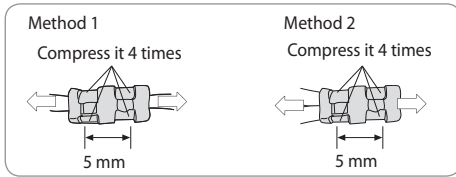

5. Apply heat to the contraction tube to contract it.

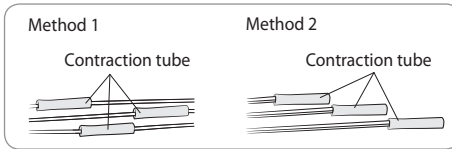

6. Wrap it with the insulation tape twice or more and position your contraction tube in the middle of the insulation tape.

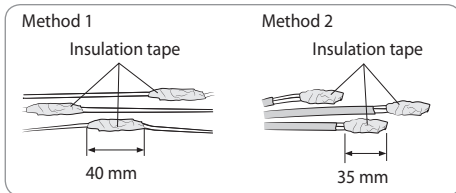

7. After tube contraction work is completed, wrap it with the insulation tape to finish.
Three or more layers of insulation are required.

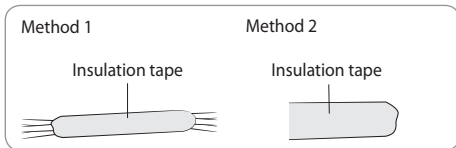

CAUTION

- Make sure that the connection parts are not exposed to outside.
- Be sure to use insulation tape and a contraction tube made of approved reinforced insulating materials that have the same level of withstand voltage with the power cable. (Comply with the local regulations on extensions.)



WARNING

- In case of extending the electric wire, please DO NOT use a round-shaped Pressing socket.
 - Incomplete wire connections can cause electric shock or a fire.

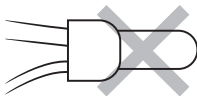

Testing operations

1. Check the power supply between the outdoor unit and the auxiliary circuit breaker.
 - 1 phase power supply : L, N
 - 3 phases power supply : R,S,T,N
2. Check the CONTROL KIT
 - 1) Check that you have connected the power and communication cables correctly. (If the power cable and communication cables one mixed up or connected incorrectly, the PCB will be damaged.)
 - 2) Check the temp. sensor, drain pump/hose, and display are connected correctly.
3. Press K1 or K2 on the outdoor unit PCB to run the test mode and stop.

KEY	KEY operation	7-segment display
K1	Press once : Heating test run	" \overline{L} " " \overline{I} " "BLANK" "BLANK"
	Press twice : Defrost test run	" \overline{L} " " $\overline{3}$ " "BLANK" "BLANK"
	Press 3times : Finishing test mode	-
K2	Press once : Cooling test run (Heating Only : skip)	" \overline{L} " " $\overline{2}$ " "BLANK" "BLANK"
	Press twice : Output signal test run	" \overline{L} " " $\overline{4}$ " "BLANK" "BLANK"
	Press 3 times : Finishing test mode	-
K3	Reset	-
K4	View mode	Refer to View mode display

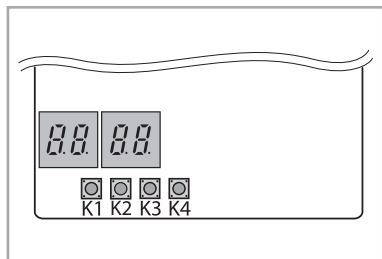
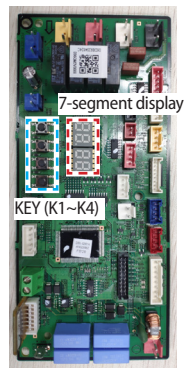

4. View Mode : When the K4 switch is pressed, you can see information about our system state as below.

Number of press	Display contents	Display				Units
		Segment 1	Segment 2	Segment 3	Segment 4	
0	Communication State	10s digit of Tx	1s digit of Tx	10s digit of Rx	1s digit of Rx	-
1	Order frequency	1	100s digit	10s digit	1s digit	Hz
2	Current frequency	2	100s digit	10s digit	1s digit	Hz
3	Pump output	3	100s digit	10s digit	1s digit	%
4	Outdoor air sensor	4	+/-	10s digit	1s digit	°C
5	Discharge sensor	5	100s digit	10s digit	1s digit	°C
6	Eva in sensor	6	+/-	10s digit	1s digit	°C
7	Inlet water sensor	7	+/-	10s digit	1s digit	°C
8	Outlet water sensor	8	+/-	10s digit	1s digit	°C
9	Cond sensor	9	+/-	10s digit	1s digit	°C
10	Current	A	10s digit	1s digit	First decimal	A

Number of press	Display contents	Display				Units
		Segment 1	Segment 2	Segment 3	Segment 4	
11	Fan RPM	B	1000s digit	100s digit	10s digit	rpm
12	Target discharge temperature	C	100s digit	10s digit	1s digit	°C
13	EEV	D	1000s digit	100s digit	10s digit	step
14	Protective control	E	0: Cooling 1: Heating	Protective control 0: No protective control 1: Freezing 2: Defrosting 3: Over-load 4: Discharge 5: Total current	Frequency status 0: Normal 1: Hold 2: Down 3: Up_limit 4: Down_limit	-
15	IPM temp.	F	+/-	10s digit	1s digit	°C
long-1	Main Micom version	Year(Dec)	Month(Hex)	Day(two digit)	Day(One digit)	-
long-1 and 1	Inverter Micom version	Year(Dec)	Month(Hex)	Day(two digit)	Day(One digit)	-
long-1 and 2	EEPROM version	Year(Dec)	Month(Hex)	Day(two digit)	Day(One digit)	-

5. Key Option

Option	Input unit	SEG1	SEG2	SEG3	SEG4	Function of the option
Channel address	Main	0	0	A 0	U 0	Automatic address setting (default) Manual address setting (0 to 15)
Base heater	Main	0	1	0 0	0 1	Enabled (default) Disabled
Operation mode	Main	0	2	0 0	0 1	Heat Pump (default) Heating Only
Snow accumulation prevention control	Main	0	3	0 0	0 1	Disabled (default) Enabled
Silent mode	Main	0	4	0 0 0 0	0 1 2 3 4	Manual Silent mode (-3 dB) Manual Silent mode * 0.9 (-5 dB) Manual Silent mode * 0.75 (-7 dB) Manual Silent mode (-3 dB) Low-noise Silent mode (default)
Energy saving mode	Main	0	5	0 0	0 1	Disabled (default) Enabled
Defrost Entry Temperature Offset	Main	0	6	0 0 0 0	0 1 2 3	Defrost entering temperature = Default Defrost entering temperature = Default+1°C Defrost entering temperature = Default+2°C Defrost entering temperature = Default+3°C



WARNING

- Incorrect handling of thermostat, safety valve or other valves may lead to tank rupture. When servicing the unit follow instructions carefully:
 - Always turn off main power supply when water supply is being shut off.
 - Test the free operation of the safety valve regularly by opening the valve ensuring the water flows freely.
 - Electrical connection and all servicing of the electrical components should only be carried out by an authorized electrician.
 - Fitting and all servicing of plumbing fixtures should only be carried out by an authorized installer.
 - When replacing the thermostat, safety valve or any other valve or part supplied with this unit, use only approved parts of the same specification.

Error codes

If the unit has some problems and does not work normally, error code is shown on the OUTDOOR UNIT main PBA or LCD of the wired remote controller.

Display	Explanation	Error Source
101	CONTROL KIT / OUTDOOR UNIT wire connection error	CONTROL KIT, OUTDOOR UNIT
120	Short- or open-circuit error of the room temperature sensor of the Zone 2 indoor unit (detected only when the room thermostat is used)	CONTROL KIT
121	Short- or open-circuit error of the room temperature sensor of the Zone 1 indoor unit (detected only when the room thermostat is used)	CONTROL KIT
162	EEPROM Error	CONTROL KIT
198	Error of Terminal Block's Thermal Fuse(Open)	CONTROL KIT
201	CONTROL KIT/OUTDOOR UNIT communication error (Matching error)	CONTROL KIT, OUTDOOR UNIT
202	CONTROL KIT/OUTDOOR UNIT communication error (3 min)	CONTROL KIT, OUTDOOR UNIT
203	Communication error between INVERTER and MAIN MICOM (6 min)	OUTDOOR UNIT
221	OUTDOOR UNIT temperature sensor error	OUTDOOR UNIT
231	Condenser temperature sensor error	OUTDOOR UNIT
251	Discharge temperature sensor error	OUTDOOR UNIT
320	OLP sensor error	OUTDOOR UNIT
403	Detection of OUTDOOR UNIT compressor freezing (During cooling operation)	OUTDOOR UNIT
404	Protection of OUTDOOR UNIT when it is overload (during Safety Start, Normal operation state)	OUTDOOR UNIT
407	Comp down due to high pressure	OUTDOOR UNIT
416	Discharge of a compressor is overheated	OUTDOOR UNIT
425	Power source line missing error (only for 3-phase model)	OUTDOOR UNIT
440	Heating operation blocked (outdoor temperature over 35°C)	OUTDOOR UNIT
441	Cooling operation blocked (outdoor temperature under 9°C)	OUTDOOR UNIT
458	OUTDOOR UNIT fan1 error	OUTDOOR UNIT
461	[Inverter] Compressor startup error	OUTDOOR UNIT
462	[Inverter] Total current error/PFC over current error	OUTDOOR UNIT
463	OLP is overheated	OUTDOOR UNIT
464	[Inverter] IPM over current error	OUTDOOR UNIT
465	Compressor V limit error	OUTDOOR UNIT
466	DC LINK over/low voltage error	OUTDOOR UNIT
467	[Inverter] Compressor rotation error	OUTDOOR UNIT
468	[Inverter] Current sensor error	OUTDOOR UNIT
469	[Inverter] DC LINK voltage sensor error	OUTDOOR UNIT
470	Outdoor unit EEPROM Read/Write Error	OUTDOOR UNIT

Display	Explanation	Error Source
471	Outdoor unit EEPROM Read/Write Error(OTP error)	OUTDOOR UNIT
474	IPM(IGBT Module) or PFCM temperature sensor Error	OUTDOOR UNIT
475	OUTDOOR UNIT fan2 error	OUTDOOR UNIT
484	PFC Overload Error	OUTDOOR UNIT
485	Input current sensor error	OUTDOOR UNIT
500	IPM is overheated	OUTDOOR UNIT
554	Gas leak error	OUTDOOR UNIT
601	Communication error between the CONTROL KIT and wired remote controller	Wired Remote Controller
602	Wired remote controller Master/Slave setting error	Wired Remote Controller
604	Communication tracking error between the CONTROL KIT and wired remote controller	CONTROL KIT, Wired Remote Controller
607	Communication error between the Master and Slave wired remote controllers	Wired Remote Controller
899	Short- or open-circuit error of the Zone 1 water-out temperature sensor	CONTROL KIT
900	Short- or open-circuit error of the Zone 2 water-out temperature sensor	CONTROL KIT
901	Water inlet (PHE) temperature sensor error(open/short)	OUTDOOR UNIT
902	Water outlet (PHE) temperature sensor error(open/short)	OUTDOOR UNIT
903	Water outlet (backup heater) temperature sensor error.	CONTROL KIT
904	DHW tank temperature sensor error	CONTROL KIT
906	Refrigerant gas inlet (PHE) temperature sensor (open/short)	OUTDOOR UNIT
911	Low flow rate error • in case of low flow rate in 30 sec during water pump signals is ON(Starting) • in case of low flow rate in 15 sec during water pump signals is ON(After starting)	CONTROL KIT
912	Normal flow rate error • in case of normal flow rate in 10min during water pump signal is OFF	CONTROL KIT
916	Mixing valve sensor error	CONTROL KIT
919	Error that the set temperature for disinfection operation is not reached, or, after reaching, the temperature fails to continue for the requested time	CONTROL KIT

Maintenance

Listed checks and inspections shall be implemented regularly so that the unit can operate as design intention in production site.

Always switch off the unit and remove power cable from the electric source before carrying out any maintenance or repair works.

Mentioned actions shall be carried out at least once a year by qualified personnel.

1. Water pressure
 - Check if the water pressure is above 0.3 bar. If necessary, fill a supplement water.
2. Water filter
 - Use water filter which is available for cleaning and clean it regularly.
3. Water pressure relief valve
 - Check for correct operation of the pressure relief valve.
 - The valve will work over the designated pressure.
 - If there is leakage of water or water splashed in normal condition, please contact your local installer.
4. Glycol
 - Record and check the glycol concentration and the pH-value in the system at least once a year.
 - A Ph-value below 8.0 indicates that a significant portion of the inhibitor has been depleted and that more inhibitor needs to be added.
 - When the Ph-value is below 7.0 then oxidation of the glycol occurred, the system should be drained and flushed thoroughly before severe damage occurs.
 - Make sure that the disposal of the glycol solution is done in accordance with relevant local and national regulation.

Adding refrigerant

The Heat Pump unit is provided to users with basic amounts of refrigerants as initial setting values. While using the unit or doing refrigerant piping works, there can be some loss of refrigerants compared to initial amounts. To run the units properly, keep the amount of refrigerant which SAMSUNG designated.

Procedures as below is describing how to adding the amount of refrigerant.



WARNING

- R-32 Shall be added as liquid phase.
- Adding and recharging works shall be by Charging Ports.

1. Connect the manifold gauge and purge the manifold gauge.
2. Open the manifold gauge valve of the liquid side Charging Ports and add the liquid refrigerant.
3. If you cannot fully recharge the additional refrigerant while the outdoor unit is stopped, use the key on PCB in the Heat Pump to run for recharging the remaining refrigerant.

Adding refrigerants in running condition

1. Press the function key for adding refrigerant.
2. After 30 minutes of operation, open the Charging Ports on low pressure side in Heat Pump.
3. Open the valve for low pressure side in the manifold gauge to recharge the remaining refrigerant.
4. After completing, close the valves in manifold gauge and eliminate the hoses from Charging Ports.

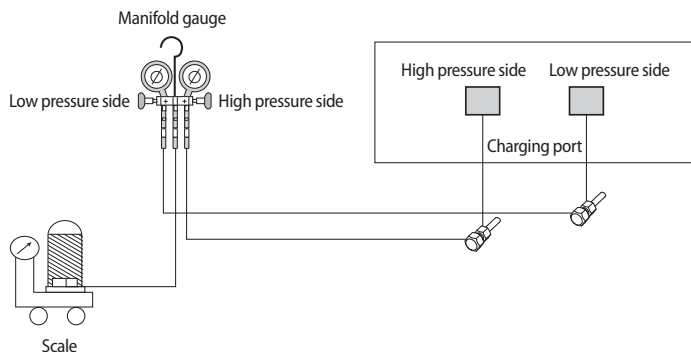

Important information regulation regarding the refrigerant used



- Inform user if system contains 3 kg or more of fluorinated greenhouse gases. In this case, it has to be checked for leakage at least once every 12 months, according to regulation n°842/2006. This activity has to be covered by qualified personnel only. In case situation above (3 kg or more of R-32), installer (or recognised person which has responsibility for final check) has to provide a maintenance book, with all the information recorded according to REGULATION(EC) N° 842/2006 OF THE EUROPEAN PARLIAMENT AND OF THE COUNCIL of 17 May 2006 on certain fluorinated greenhouse gases.



- For the product that uses the R-32 refrigerant, be cautious not to generate a spark by keeping the following requirements:
 - Do not remove the fuses with power on.
 - Do not disconnect the power plug from the wall outlet with power on.
 - It is recommended to locate the outlet in a high position. Place the cords so that they are not tangled.

Precautions on adding the R-32 refrigerant

In addition to the conventional charging procedure, the following requirements shall be kept.

- ▶ Make sure that contamination by other refrigerants does not occur for charging.
- ▶ To minimize the amount of refrigerant, keep the hoses and lines as short as possible.
- ▶ The cylinders shall be kept upright.
- ▶ Make sure that the refrigeration system is earthed before charging.
- ▶ Label the system after charging, if necessary.
- ▶ Extreme care is required not to overcharge the system.
- ▶ Before recharging, the pressure shall be checked with nitrogen blowing.
- ▶ After charging, check for leakage before commissioning.
- ▶ Be sure to check for leakage before leaving the work area.

Maintenance

It is recommended that annually a competent person

- a Inspects and cleans the line strainer.
- b Checks the operation of the expansion relief valve and temperature & pressure relief valve.
- c Recommissions the cylinder in accordance with the instructions.

Tundish

Install the Tundish in a vertical position within a maximum of 600mm from the temperature and Pressure Relief Valve drain connection. Ensure the expansion relief pipework discharges through the tundish. Tundish pipework must be 22mm with a minimum vertical length of 300mm below tundish.

Maximum permitted length of 22mm pipework is 9m. Each bend or elbow is equivalent to 0.8m of pipework.

All pipework must have continuous fall and discharge in a safe, visible position. If any doubt, refer to Building Regulation G3.

Charging refrigerant

- ▶ Measure the quantity of the refrigerant according to the length of the liquid side pipe. Add quantity of the refrigerant using a scale.

Important information: regulation regarding the refrigerant used

This product contains fluorinated greenhouse gases. Do not vent gases into the atmosphere.



- Inform user if the system contains 5 tCO₂e or more of fluorinated greenhouse gases. In this case, it must be checked for leakage at least once every 12 months, according to regulation No. 517/2014. This activity must be covered by qualified personnel only. In the case of the situation above, the installer (or authorized person with responsibility for final check) must provide a maintenance book, with all the information recorded, according to REGULATION (EU) No. 517/2014 OF THE EUROPEAN PARLIAMENT AND OF THE COUNCIL of 16 April 2014 on fluorinated greenhouse gases.

Please fill in the following with indelible ink on the refrigerant charge label supplied with this product and on this manual.

- ▶ ① the factory refrigerant charge of the product.
- ▶ ② the additional refrigerant amount charged in the field.

Unit	kg	tCO ₂ e
①, a		
②, b	DO NOT CHARGE	

Refrigerant type	GWP value
R-32	675

- GWP: Global Warming Potential
- Calculating tCO₂e: kg x GWP/1000



- a Factory refrigerant charge of the product: see unit name plate.
- b Additional refrigerant amount charged in the field. (Refer to the above information for the quantity of refrigerant replenishment.)



- The filled-out label must be adhered in the proximity of the product charging port. (ex. onto the inside of the stop valve cover.)

Troubleshooting

FAULT	POSSIBLE CAUSE	REMEDY
No water flow from hot taps.	<ol style="list-style-type: none"> 1. Mains supply off. 2. Strainer blocked. 3. Cold water inlet Pressure Reducing Valve incorrectly fitted. 	<ol style="list-style-type: none"> 1. Check and open stopcock. 2. Turn off water supply. Remove strainer and clean. (See Pressure Reducing Valve page 6 Installation Manual) 3. Check and refit as required (see item 3 page 5 of installation manual).
Water from hot taps is cold.	<ol style="list-style-type: none"> 1. Immersion heaters not switched on. 2. Immersion heater thermal cut-out has operated. 3. Programmer set to central heating or not switched on. 4. Boiler not working 5. Motorised valve not operating correctly. 	<ol style="list-style-type: none"> 1. Check and switch on.. 2. Check and reset button. (See thermostat diagram page 9 and safety cut-out on page 4 of installation manual). 3. Check and set to hot water. 4. Check boiler operation. If fault suspected, consult installer or boiler manufacturer. 5. Check wiring and/or plumbing connections to motorized valve.
Intermittent water discharge	<ol style="list-style-type: none"> 1. Reduced internal expansion. 2. Thermal control failure. (Note Water will be hot). 	<ol style="list-style-type: none"> 1. Repressurize expansion vessel. Follow cold water discharge instructions on page 4. 2. Switch off power to immersion heater(s) and boiler supply to the unit. When discharge has stopped, check thermal controls, replace it faulty. Contact a competent person.
Continuous water discharge	<ol style="list-style-type: none"> 1. Cold water inlet Pressure Reducing Valve not working 2. Temperature and pressure relief valve faulty. 3. Expansion relief valve not working correctly. 	<ol style="list-style-type: none"> 1. Check pressure from valve if greater than 2.1 bar replace. (See page 6 of installation manual). 2. As No2 of above. 3. Check and replace if faulty. (See page 6 of installation manual).
Room thermostat does not switch on or not work properly	Wireless room thermostat batteries not Working	Replace new batteries for wireless room thermostat



NOTE

- Disconnect electrical supply before removing any electrical equipment covers.

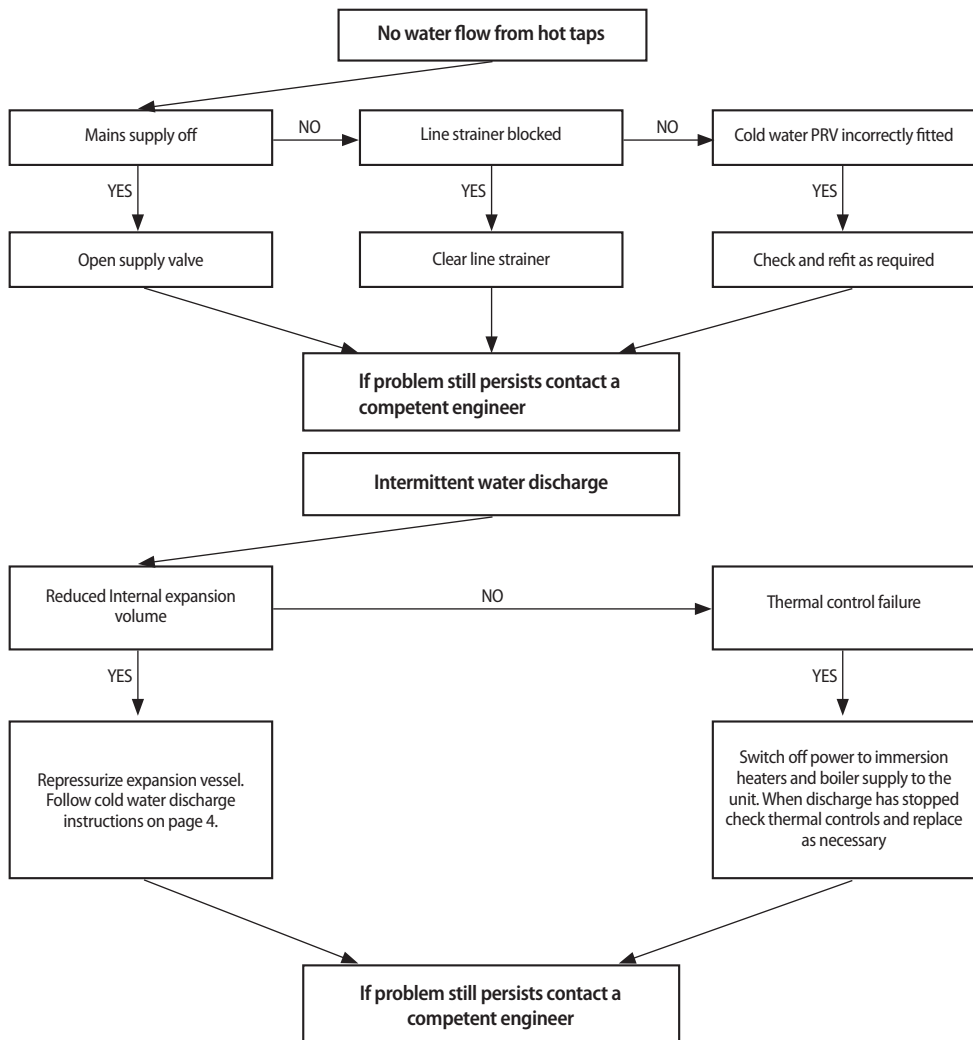

Troubleshooting

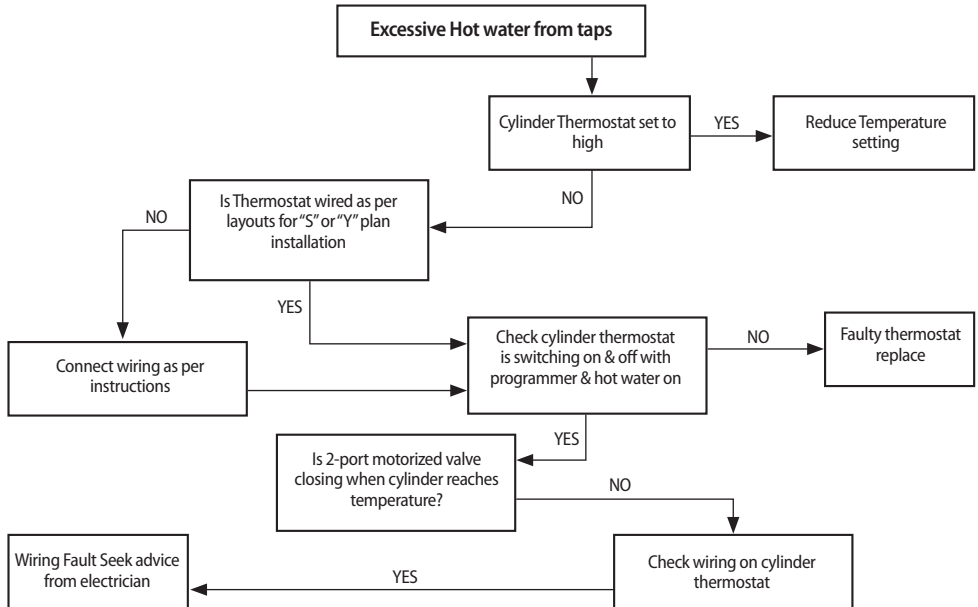
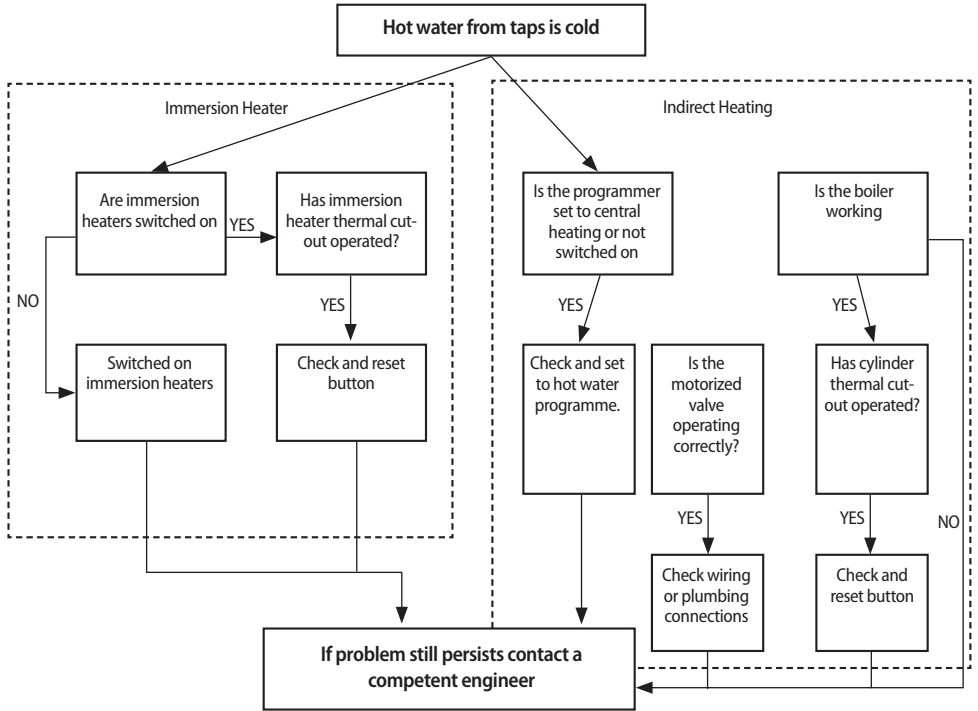

If in doubt at any stage you must consult a qualified technician

Commissioning

Filling up

1. Open a hot tap.
2. Open the cold water supply valve.
3. When water flows from hot tap, close the tap.
4. Allow the system to stabilize for 5 minutes.
5. Open each hot water tap in turn to expel air from the system pipe work.
6. Check for leaks.
7. Manually operate Temperature and Pressure Relief Valve to ensure free water flow through discharge pipe. (Turn knob to left.)

Draining/flushing

1. Turn off mains supply.
2. Connect hose pipe to drain cock at base of cylinder.
3. Open hot tap. Open drain valve and open temperature & pressure relief valve.
4. Allow to drain. Follow commissioning instructions (above) to refill.

Recommissioning instructions

Cold or tepid water discharge from tundish - The tundish should be installed away from electrical devices.

1. Close cold water supply valve.
2. Open a hot tap.
3. Repressurise the expansion vessel air charge to its set level.
4. Close hot tap.
5. Open the cold water supply valve.

Hot water discharge from tundish

This indicates a malfunction of a thermal cut-out, operating thermostat or the combined temperature and pressure relief valve. Turn off the electrical supply to the immersion heater and also isolate an indirect unit from the boiler. Contact the installer or competent engineer.

Reference (KEYMARK Certification)

Model code Outdoor	Model code Indoor	Registration number	Accessory* Mono Control Kit
AE050RXYDEG/EU	AE200RNWMEG/EU	011-1W0448	
AE050RXYDEG/EU	(space heating only)		MIM-E03CN
AE080RXYDEG/EU	AE200RNWMEG/EU	011-1W0449	
AE080RXYDEG/EU	(space heating only)		MIM-E03CN
AE080RXYDEG/EU	AE260RNWMEG/EU	011-1W0450	
AE080RXYDGG/EU	AE260RNWMGG/EU		
AE080RXYDGG/EU	(space heating only)		MIM-E03CN
AE120RXYDEG/EU	AE200RNWMEG/EU	011-1W0446	
AE120RXYDEG/EU	(space heating only)		MIM-E03CN
AE160RXYDEG/EU	AE200RNWMEG/EU		
AE160RXYDEG/EU	(space heating only)		MIM-E03CN
AE120RXYDEG/EU	AE260RNWMEG/EU	011-1W0447	
AE120RXYDGG/EU	AE260RNWMGG/EU		
AE120RXYDGG/EU	(space heating only)		MIM-E03CN
AE160RXYDEG/EU	AE260RNWMEG/EU		
AE160RXYDGG/EU	AE260RNWMGG/EU		
AE160RXYDGG/EU	(space heating only)		MIM-E03CN

SAMSUNG



This appliance is filled with R-32.