



# LOGIC<sup>2</sup>

FLUE GUIDE



# FLUE ACCESSORIES

Logic Max<sup>2</sup>, Logic+<sup>2</sup> and Logic<sup>2</sup>

## Maximum permissible horizontal concentric flue length

combining both horizontal flue and flue extensions (measured from centreline of the turret to the outside of the wall terminal)

Up to 26 kW appliances	Maximum: 9m - minus any extensions or bends
30 & 32 kW appliances	Maximum: 8m - minus any extensions or bends
35 & 38 kW appliances	Maximum: 6m - minus any extensions or bends

## Maximum permissible vertical flue length



combining both vertical flue terminal and flue extensions

24 - 38 kW appliances	Maximum: 7.5m - minus any extensions or bends
-----------------------	---

### Vertical flue loft air inlet

24 - 38 kW appliances	Up to 4.7m concentric flue and 20m single flue pipe. For additional configurations and details refer to the installation instructions supplied with 203136 Vertical flue loft air inlet
-----------------------	--

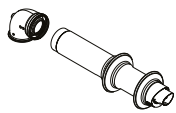
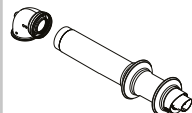
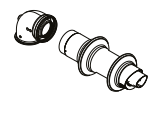
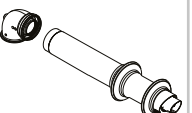
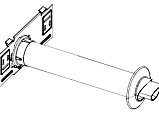
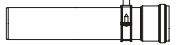
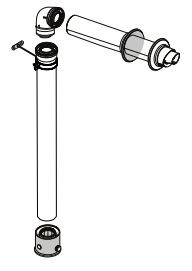
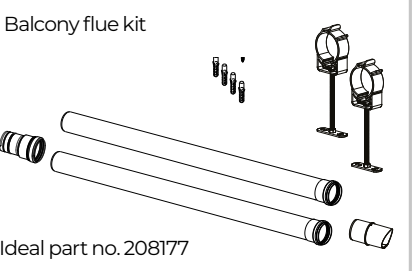
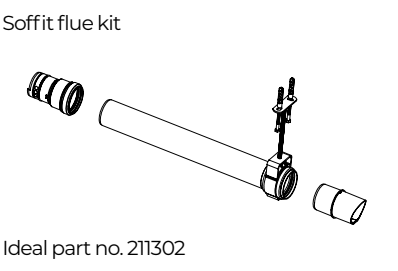
**90° bend Ø60/100** - Equivalent flue length resistance = 1m  
**45° bend Ø60/100** - Equivalent flue length resistance = 0.6m

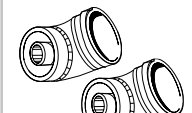
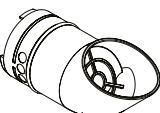
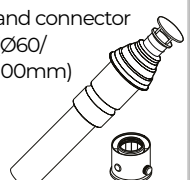
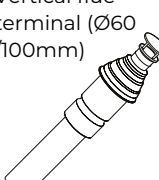
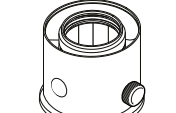
<p>Horizontal flue non-telescopic 0.6m (181-556mm)</p>  <p>Ideal part no. 208171</p>	<p>Horizontal flue non-telescopic 0.8m (601-816mm)</p>  <p>Ideal part no. 217442</p>	<p>Horizontal flue telescopic 0.5m (286-484mm)</p>  <p>Ideal part no. 208169</p>	<p>Horizontal flue telescopic 0.7m (526-741mm)</p>  <p>Ideal part no. 208174</p>	<p>Horizontal flue rear outlet Heat (Ø55/80mm)</p>  <p>Ideal part no. 205990</p>	<p>Flue extension with bracket 0.5m, 1m or 2m</p>  <p>Ideal part no. 0.5m 211037 1m 203129 2m 211038</p>			
<p>Raised horizontal flue kit</p>  <p><b>NOTE:</b> A 1 metre vertical pipe is supplied as standard. Both horizontal and vertical lengths can be extended.</p> <p>Ideal part no. 208290</p>	<p>Balcony flue kit</p>  <p>Ideal part no. 208177</p>	<p>Soffit flue kit</p>  <p>Ideal part no. 211302</p>	<p>Flue bend 90°</p>  <p>Ideal part no. 203130</p>	<p>Flue bend 45° pair</p>  <p>Ideal part no. 203131</p>	<p>Flue deflector (Ø 60mm)</p>  <p>Ideal part no. 208176</p>	<p>Vertical flue terminal and connector (Ø60/100mm)</p>  <p>Ideal part no. 211039</p>	<p>Vertical flue terminal (Ø60/100mm)</p>  <p>Ideal part no. 203132</p>	<p>Vertical flue connector (Ø60/100mm)</p>  <p>Ideal part no. 208175</p>

Vertical flue terminal extension (Ø60/100mm)



Ideal part no. 210803

Vertical flue loft air inlet (Ø80mm outlet)



Ideal part no. 203136

Flue extension 1m pair (Ø80mm)

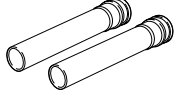

Ideal part no. 203142

Vertical flue terminal (Ø80mm connection)

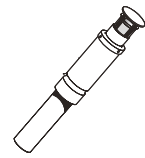

Ideal part no. 203134

Weather collar pitched roof

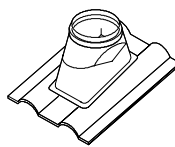

Ideal part no. 152258

Weather collar flat roof

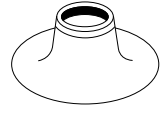

Ideal part no. 152259

High level flue outlet kit (Ø60mm)



Ideal part no. 208178

Flue extension 1m for high level flue outlet (Ø60mm)



Ideal part no. 203228

High level flue bend 90° (Ø60mm)



Ideal part no. 90° 203229  
45° 203230

High level flue outlet kit for Heat rear outlet



Ideal part no. 205989

Adjustable flue bracket



Ideal part no. Ø100 205247  
Ø80 205028

Flue finishing kit (Ø100/80mm)

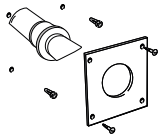

Ideal part no. Ø100 155988  
Ø80 206151

RS terminal replacement wall plate

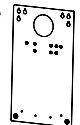

Ideal part no. System 211328  
Combi 206164

Flue securing screws



Ideal part no. 205024

Timber frame wall tube 0.4m



Ideal part no. 229130

Timber frame wall plates

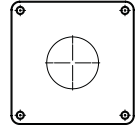

Ideal part no. 229128

# FLUE OPTIONS

## HORIZONTAL CONCENTRIC 100MM DIAMETER

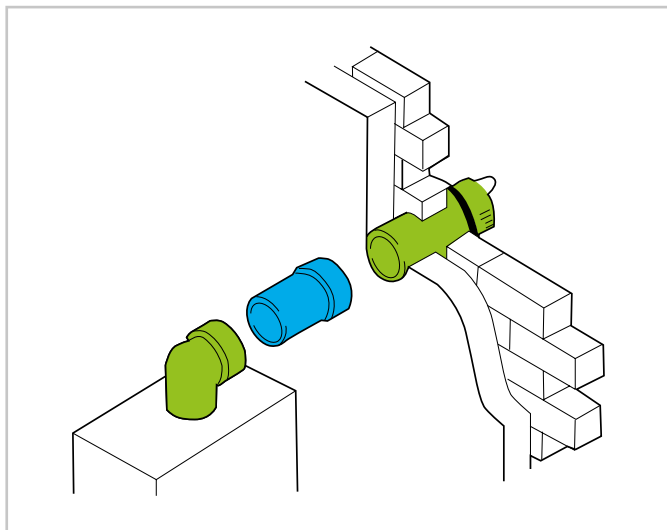

FLUE	PART NO.
Horizontal flue non-telescopic 0.6m	208171
Flue extension 1m with bracket	203129

ALTERNATIVE FLUE TERMINALS	PART NO.
Horizontal flue telescopic 0.5m	208169
Horizontal flue telescopic 0.7m	208174
Horizontal flue non-telescopic 0.8m	217442

## HORIZONTAL FLUE WITH 1 X 90° BEND

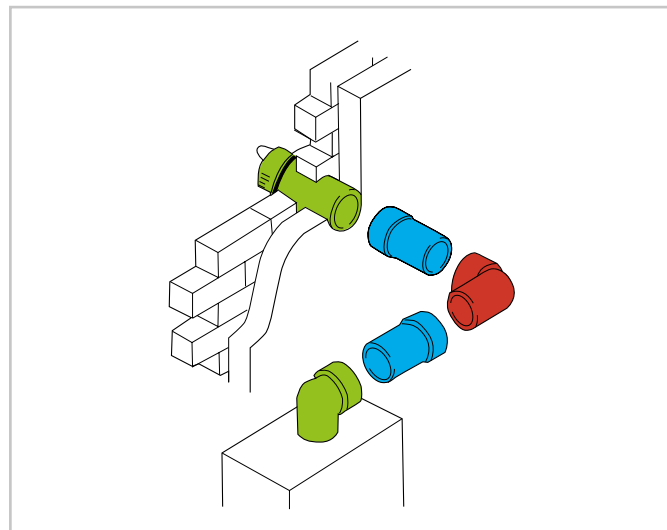

FLUE	PART NO.
Horizontal flue non-telescopic 0.6m	208171
Flue extension 1m with bracket	203129
Flue bend 90°	203130

## HORIZONTAL FLUE WITH 2 X 90° BEND

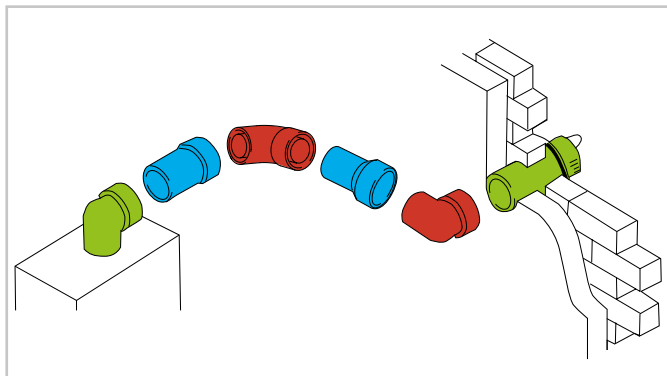

FLUE	PART NO.
Horizontal flue non-telescopic 0.6m	208171
Flue extension 1m with bracket	203129
Flue bend 90°	203130

## HORIZONTAL FLUE WITH 2 X 45° BEND

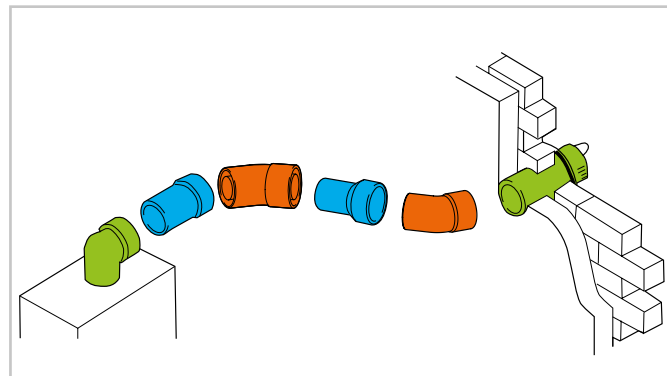

FLUE	PART NO.
Horizontal flue non-telescopic 0.6m	208171
Flue extension 1m with bracket	203129
Flue bend 45° pair	203131



## VERTICAL FLUE SYSTEM

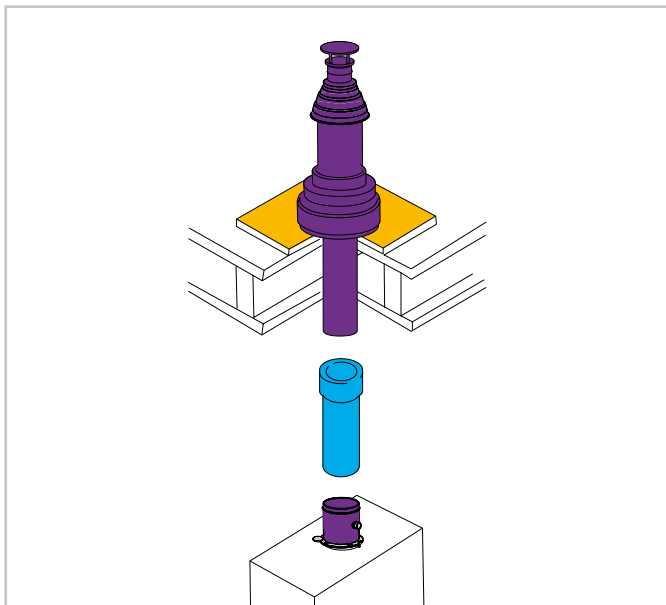

FLUE	PART NO.
Vertical flue terminal and connector	211039
Flue extension 1m with bracket	203129
Flat roof weather collar	152259

## ROOF FLUE SYSTEM WITH 2 X 45° BEND

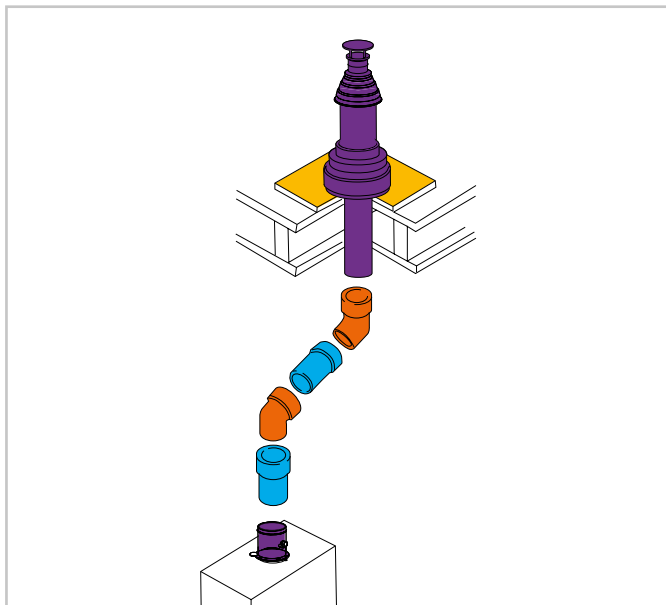

FLUE	PART NO.
Vertical flue terminal and connector	211039
Flue extension 1m with bracket	203129
Flue elbow 45° pair (Ø60/100)	203131
Flat roof weather collar	152259

## VERTICAL FLUE WITH LOFT AIR INLET

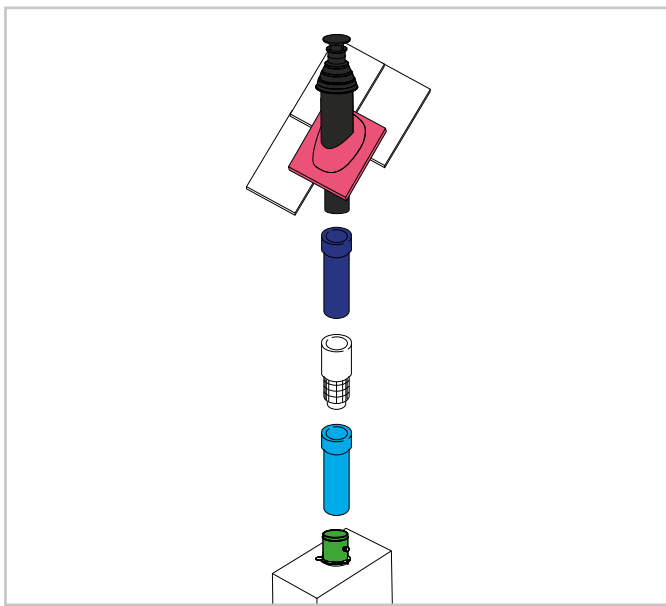

FLUE	PART NO.
Air inlet for vertical flue	203136
Flue vertical connector	208175
Vertical flue terminal	203134
Weather collar pitched roof	152258
Flue extension 1m with bracket	203129
Flue extension 1m pair (Ø80mm)	203142

**NOTE:** Allows the boiler to be sited in a position where no access to an outside wall is available. Permits the concentric flue to run vertically from the top of the boiler and obtain air supply within the roof space, the secondary flue continuing to the external flue terminal. Offset applications are permissible though the maximum length is reduced.

# HIGH LEVEL FLUE OUTLET KIT

These easy to install kits allow the boiler flue outlet to be extended external to the building, upwards to provide a flue exit at high level, overcoming problems associated with plume emission. The kit is simple to retrofit if necessary.

An external 60mm diameter flue leads from the boiler terminal (which includes a 90° bend at the flue exit) to terminate with a 90° bend complete with grille. Push fit 1m extension pipes are used as required, and the fixing clips supplied support the system from the wall. Both 90° and 45° bend are available to provide routing options.

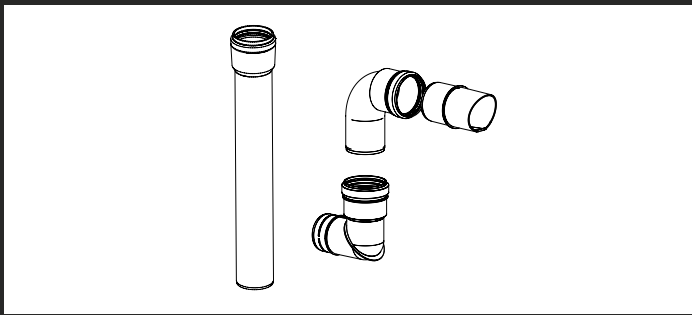

## The kit comprises:

- Flue bend - 1 off
- 60mm flue exit bend - 1 off
- 60mm horizontal flue exit - 1 off
- 60mm x 500mm flue extension pipe - 1 off

This kit is for use with horizontal non-telescopic and telescopic flue kits 208169, 208171, 208174 and 217442.

The standard terminal nose is replaced with the high level terminal.

FLUE	IDEAL PART NO.
Horizontal flue non-telescopic 0.6m	208171
High level flue outlet kit (Ø60mm)	208178
Flue extension 1m for high level flue outlet (Ø60mm)	203228
High level flue bend 90° (Ø60mm)	203229
High level flue bend 45° (Ø60mm)	203230

Diagram representative only

**NOTE:** Please refer to the installation and service manual for assistance in calculating flue lengths. Adequate support must be provided for the flue in accordance with the installation instructions. If additional elbows to those supplied in the High Level Flue Outlet kit are used, deduct the following resistances (metres) from the maximum boiler flue length.

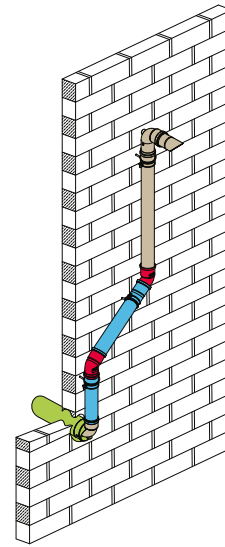

45° LEFT OR RIGHT

**IMPORTANT**  
Flue must always slope at least 1.5° back to the boiler

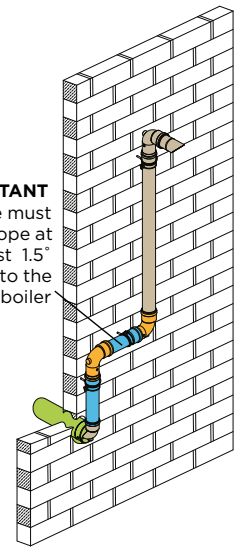

HORIZONTAL LEFT OR RIGHT

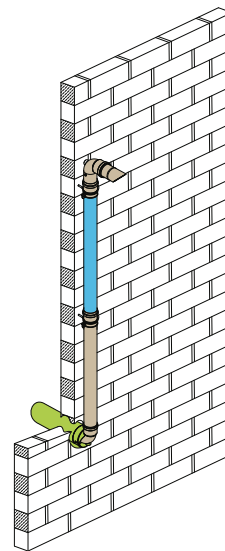

VERTICAL

# FLUE ACCESSORIES FOR HIGH RISE INSTALLATIONS

## Logic Max<sup>2</sup>, Logic+<sup>2</sup> and Logic<sup>2</sup>

The Building Regulations (Amendment) 2018 for England directs that combustible materials must not be used in the external walls of high-rise residential buildings, i.e. those above 18m tall (typically 6 stories). The 'external wall' includes anything located within any space forming part of the wall. This is relevant to the installation of all new gas boilers with horizontal flues in high-rise residential buildings, as the ban now excludes those flues that contain combustible materials such as a polypropylene plastic inner flue duct. Similar regulations also apply in Wales and Northern Ireland, with Scotland having their own regulations.

Ideal Heating have a range of high rise flues and accessories which comply with the revised regulations for high-rise buildings. Introduced from October 2019, they are direct replacements for the standard horizontal flues and accessories. The main difference is that the inner flue duct is aluminium rather than polypropylene plastic. Aluminium is classed as having class A fire resistance according to European Standard prEN1856-1 May 2019 which covers metal chimneys and flues, and by Europe Decision Document 96/603/EC covering construction products.

Externally the high rise flues look similar to the previous generation Ideal Logic flue (pre 2013) and the flue terminal is still black plastic. However, the outer air duct is no longer powder coated white and has a galvanised finish; but only a small length of this will be seen above the boiler. The elbow and wall seals have not changed. As the terminal, elbow and wall seals are not part of the make-up of the external wall their materials are not affected by the revised regulations. The flue terminal design has the air inlet underneath and the aluminium flue duct can be seen through the air inlet.

The high-rise horizontal flue terminals do not have a removable terminal nose so cannot be used with flue accessories 208178 High level flue outlet kit, 211302 Soffit kit, 208177 Balcony flue outlet kit and 208176 Flue deflector. However, new dedicated high-rise accessories are available to cover more installation configurations. These all have aluminium flue ducts to comply with the amended regulations.

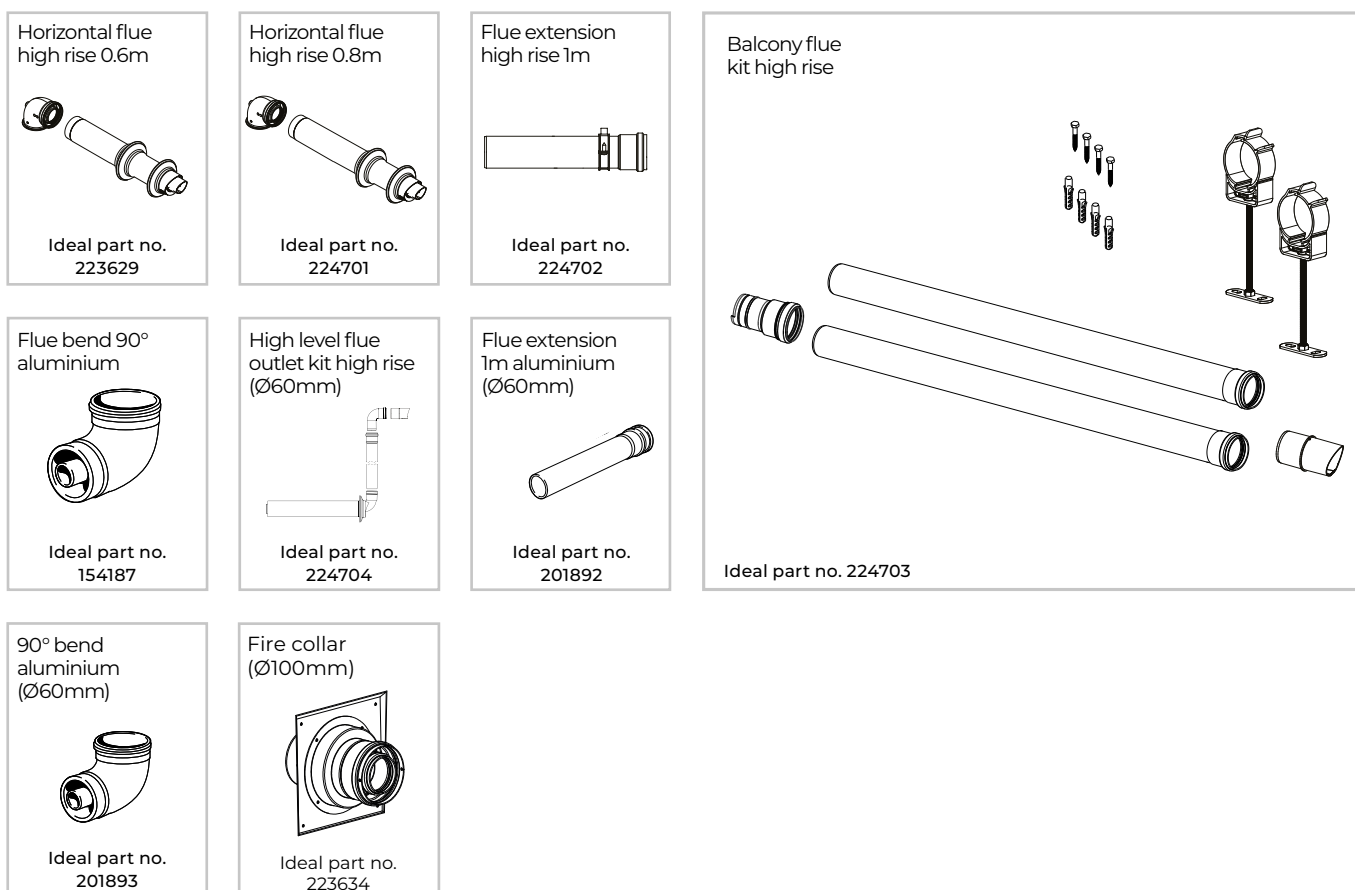

# FLUE SITING

There are a substantial number of flue options available, giving excellent siting flexibility for almost all applications.

The range of options include standard and telescopic flues as well as vertical and raised horizontal options.

To ensure siting issues are kept to a minimum, High Level Flue Outlet kit options and Flue Deflectors are available.

FLUE TERMINAL POSITION	MIN. SPACING
1. Directly below, above or alongside an opening. 300 mm	300mm
2. Below guttering, drain pipes or soil pipes.	75mm 25mm*
3. Below eaves.	200mm 25mm*
4. Below balconies or car port roof.	200mm 25mm*
5. From vertical drain pipes or soil pipes.	150mm 25mm*
6. From an internal or external corner or to a boundary alongside the terminal.	300mm 25mm*
7. Above ground, roof or balcony level.	300mm
8. From a surface or a boundary facing a terminal.	600mm
9. From a terminal facing a terminal.	1200mm
10. From an opening in a car port into dwelling.	1200mm
11. Vertically from a terminal on the same wall.	1500mm
12. Horizontally from a terminal wall.	300mm
13. Horizontally from an adjacent window	600mm
14. Facing an opening into an adjacent building	2000mm
15. At an angle to the boundary	90° 300mm 45° 600mm
16. Parallel to a boundary	300mm
17. Below ground level - open light well	
a) Below ground	<1,000 mm
b) Above floor level	300mm
c) From side	300mm
d) From facing surface	600mm

\*Only one reduction down to 25mm is allowed per installation.

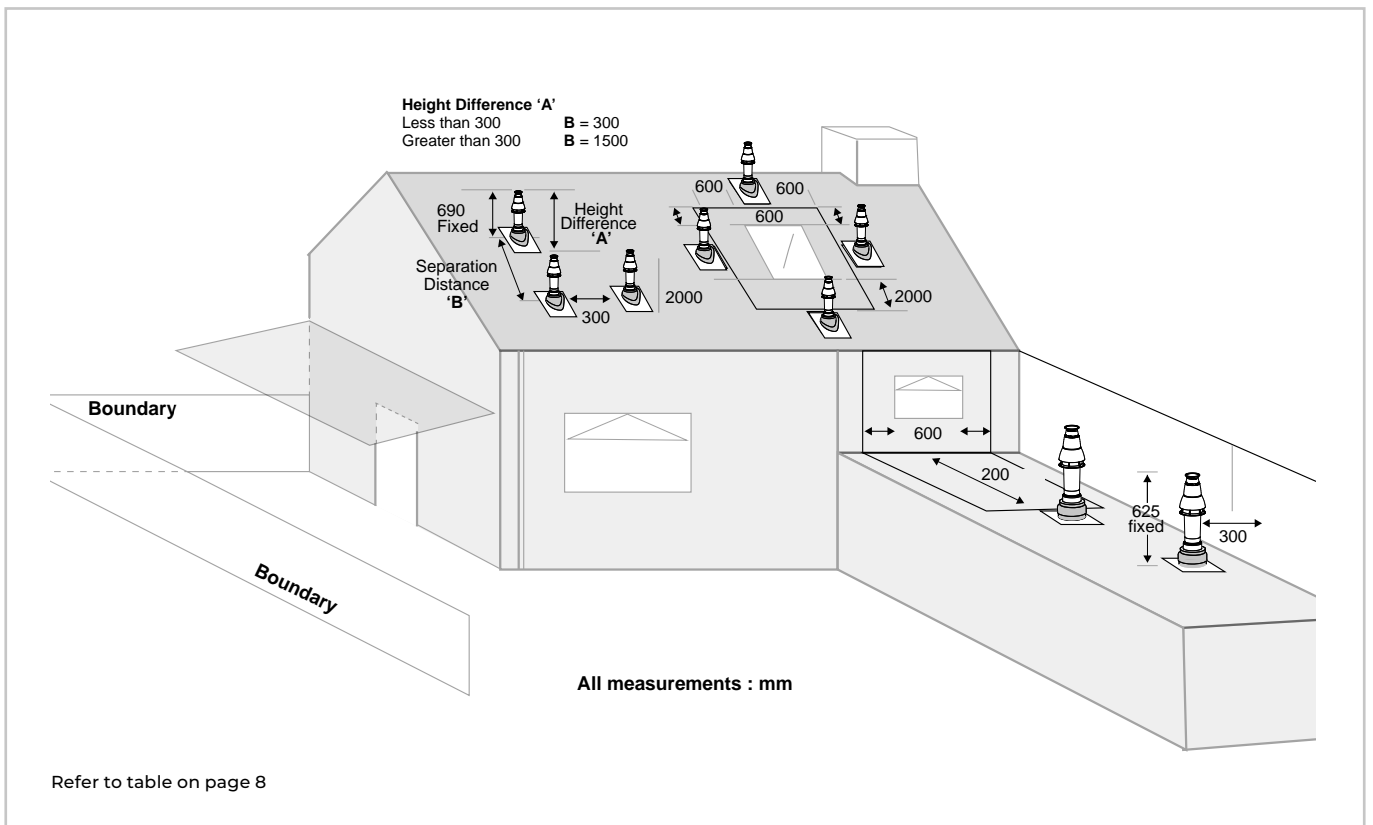
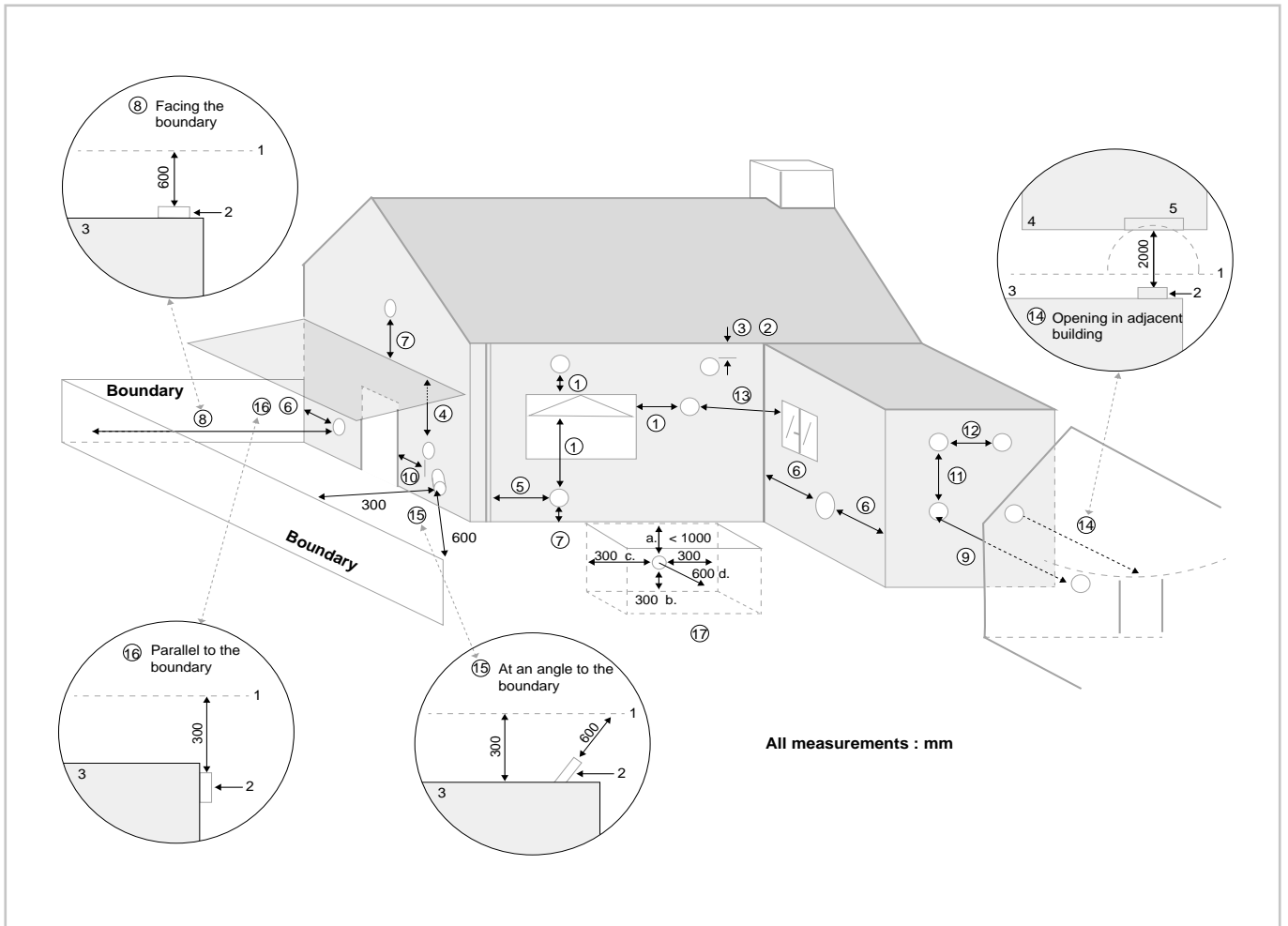







Customer Service:

**01482 498660**

Technical Help:

**01482 498663**

Ideal Heating, PO Box 103, National Avenue,  
Kingston upon Hull, East Yorkshire, HU5 4JN

E: [enquiries@idealheating.com](mailto:enquiries@idealheating.com)



[idealheating.com](http://idealheating.com) |     

**EXPERTS IN  
HEATING**