



DESIGN & INSTALLATION GUIDE

Underground





Marley Underground Drainage Systems

The Marley Plumbing & Drainage range of underground systems include the solid wall range, predominately for round the house drainage and Quantum structured wall range for sewer and highway drainage applications.



Certificate No. 88/1977
94/2985
98/3486
09/H146
11/H172

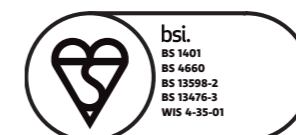

KM 05495
KM 682928
KM 542682
KM 56157



FM 30637 EMS 96207

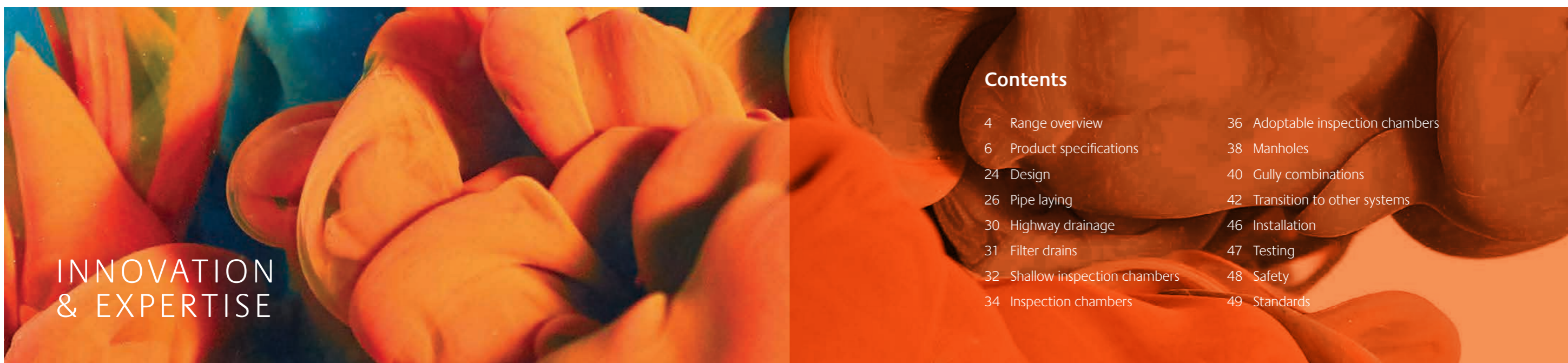

INNOVATION
& EXPERTISE

Contents

4	Range overview	36	Adoptable inspection chambers
6	Product specifications	38	Manholes
24	Design	40	Gully combinations
26	Pipe laying	42	Transition to other systems
30	Highway drainage	46	Installation
31	Filter drains	47	Testing
32	Shallow inspection chambers	48	Safety
34	Inspection chambers	49	Standards

Solid wall systems

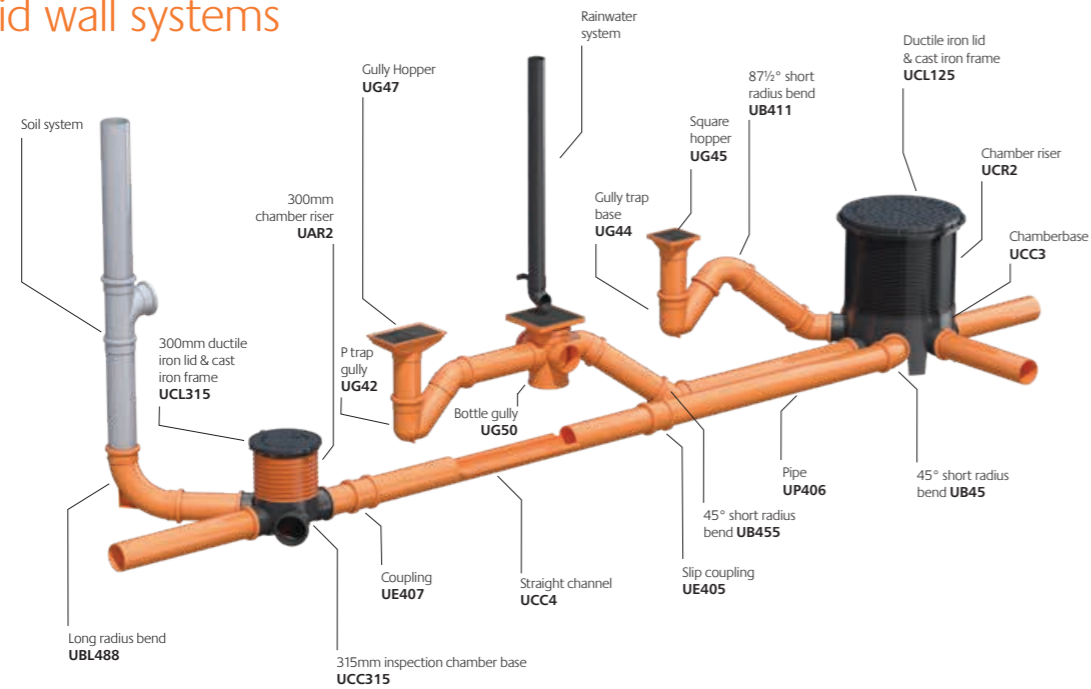

Diagram for illustrative purposes only

Key features of the Marley solid wall system

- 110mm & 160mm diameters
- Suitable for adoptable foul and surface water sewers
- Private foul and surface water applications.
- Plain ended and socketed pipe
- Adaptors to other materials
- Access fittings
- 250mm, 315mm and 450mm inspection chambers
- Adjustable and variable bends
- A wide range of gullies
- Manufactured to BS EN 1401
- BBA 88/1977 certification
- A number of solid wall fittings are also suitable for use with 150mm quantum and highway pipes.

Structured wall systems

Quantum Sewer – PVCu

- 150mm, 225mm & 300mm diameters

Quantum Highway – PVCu

- 150mm, 225mm and 300mm, diameters
- Highway surface water carrier and filter drains
- Private surface water applications.



Quantum is manufactured in two grades, sewer and highway, and offers the following benefits over traditional materials

- The flexibility to tolerate ground movement without damage, whilst withstanding the combined effects of backfill and loading
- Fewer joints to reduce the likelihood of leaks and blockages
- A high level of chemical resistance to the wide range of substances found in both effluent and contaminated soils
- A smooth bore gives good hydraulic performance
- A red stripe, printed down the length of the pipe, aids identification of sewer pipe
- BBA 94/2985 certification on Quantum Sewer for private foul and surface water applications
- BBA 09/H146 & BBA 98/3486 certification on Quantum Highway
- WIS 4-35-01 certification on Quantum Sewer for adoptable foul and surface water sewers.

Adoptable inspection chamber systems

Marley have introduced a new adoptable inspection chamber range compliant with Sewers for Adoption and Building Regulations. Compatible systems for pipe & fitting connections:

110mm and 160mm solid wall drainage, and 150mm Quantum sewer structured wall drainage.

All products in the Sewers for Adoption range are suitable for both adoptable and non-adoptable applications.

Key features

- Compliant with Building Regulations & Sewers for Adoption
- Kitemarked / BBA approved
- Chambers available in three sizes
- High quality, rigid for all below ground drainage requirements
- Full range of compatible pipe and fittings in sizes 110, 150 & 160mm

250mm Chamber base

Suitable for up to 2m in depth



UCC250 250MM INSPECTION CHAMBER

Adoptable pipe & fittings
110mm solid wall drainage

450mm Inspection Chamber

Suitable for up to 3m in depth



UCL125 450MM LID & FRAME

UCLRR2 350MM REDUCED ACCESS RING
For use with UCL125, used to reduce 450mm chamber to 350mm to prevent man entry.

UCR3 450MM DEEP INSPECTION RISER
480mm long

UCC5 450MM INSPECTION CHAMBER
110 & 160mm connections

UCC450 450MM INSPECTION CHAMBER
110mm connections

Adoptable pipe & fittings
110mm & 160mm solid wall drainage
150mm Quantum sewer structured wall drainage

315mm Inspection Chamber

Suitable for up to 2m in depth



UCL315 300MM LID & FRAME

UAR2 300MM RISER
500mm long
or
UAR3 300MM RISER
1000mm long

UCC315 315MM INSPECTION CHAMBER

Adoptable pipe & fittings
110mm solid wall drainage

All products marked **A** are fully compliant with Sewers for Adoption and Building Regulations

Adoptable chambers are easy to identify on site due to their blue snap caps



Solid wall drainage systems

PIPE

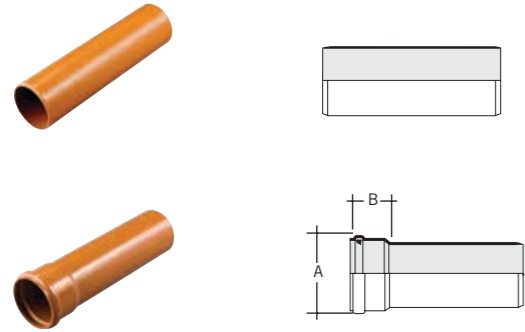

Size mm	Code	Length	A	B	C	D	Colour	Qty
110	UL403	3m					ⓐ ○	1
110	UL406	6m					ⓐ ○	1
160	UL606	6m					ⓐ ○	1

Double spigot with chamfer each end

110	UP403	3m	128	70			ⓐ ○	1
160	UP603	3m	182	107			ⓐ ○	1
110	UP406	6m	128	70			ⓐ ○	1
160	UP606	6m	182	107			ⓐ ○	1

Push fit socket

SLOTTED PIPE

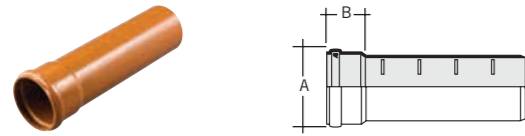

110	UPP406	6m	128	70			ⓐ ○	1
-----	---------------	----	-----	----	--	--	-----	---

Push fit socket

STRAIGHT COUPLINGS

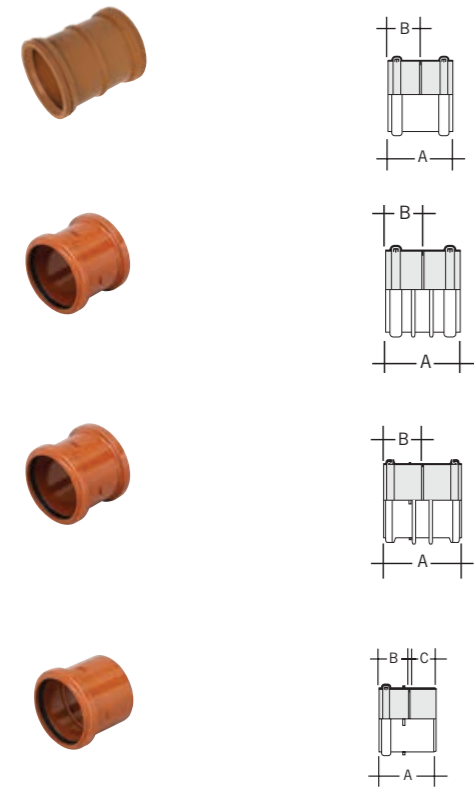

Push fit polypropylene coupling

110	UE407		102	50			○	20
-----	--------------	--	-----	----	--	--	---	----

(Supplied in U.V. resistant polythene bags)

Push fit coupling

110	UE406		128	61			ⓐ ○	8
160	UME15C		170	83			ⓐ ○	4

Push fit slip coupling

110	UE405		128				ⓐ ○	8
160	UME16C		170				ⓐ ○	4

Loose pipe socket

110	UE400	109m	61	48			ⓐ ○	8
160	UE600	190m	107	77			ⓐ ○	4

SHORT RADIUS BENDS

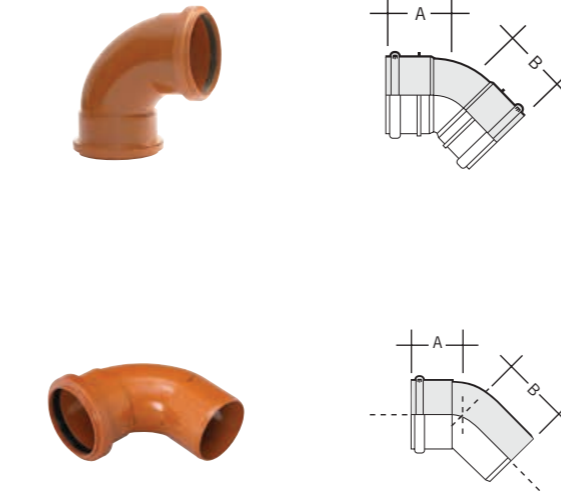

Size mm	Code	Angle	A	B	C	D	Colour	Qty
110	UB41	87½°	175	182			ⓐ ○	4
160	UFB61	87½°	236	232			ⓐ ○	1
110	UB45	45°	145	125			ⓐ ○	4
160	UFB65	45°	130	118			ⓐ ○	1
110	UB430	30°	89	82			ⓐ ○	4
160	UB69	30°	160	150			ⓐ ○	1
110	UB410	10°	98	75			ⓐ ○	1
110	UB420	20°	102	81			ⓐ ○	1
160	UB68	15°	150	110			ⓐ ○	1

Push-fit socket/spigot

110	UB411	87½°	158	158			ⓐ ○	4
160	UMB19C	87½°	200	200			ⓐ ○	1
110	UB455	45°	95	95			ⓐ ○	4
160	UMB14C	45°	115	115			ⓐ ○	1
110	UB4300	30°	80	80			ⓐ ○	4
160	UMB13C	30°	105	105			ⓐ ○	1
110	UB4100	10°	98	76			ⓐ ○	1
110	UB4200	20°	102	81			ⓐ ○	1
160	UMB11C	15°	95	95			ⓐ ○	1

Double push-fit socket

ADJUSTABLE BENDS



110	UB47	21 – 90°	210	205			ⓐ ○	4
160	UB67	15 – 90°	285	275			ⓐ ○	2

Socket should be solvent welded

MULTIFLEX BENDS



110	USB110	0 – 90°	205	205			○	1
-----	---------------	---------	-----	-----	--	--	---	---

Single socket

110	UDSB110	0 – 90°	205	205			○	1
-----	----------------	---------	-----	-----	--	--	---	---

Double socket

MECHANICAL BEND



110	UB47M	5 – 30°	200	177			○	1
-----	--------------	---------	-----	-----	--	--	---	---

Solid wall drainage systems

LONG RADIUS BEND

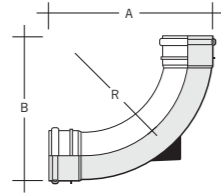

Size mm	Code	Angle	A	B	C	D	Colour	Qty
110	UBL488	87½°	295	295	200		ⓐ ○	4

Socket/socket

EQUAL BRANCHES

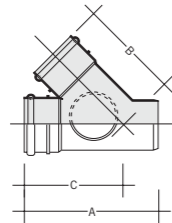

110	UY401	87½°	300	150			ⓐ ○	4
160	UY601	87½°	400	200			○	2
110	UY46	45°	320	205	205		ⓐ ○	4
160	UY63	45°	400	280	280		ⓐ ○	2

Socket/spigot

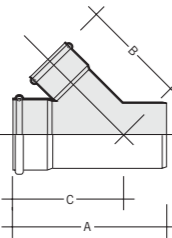

110	UY400	87½°	300	150			ⓐ ○	4
160	UMY13C	87½°	400	200			ⓐ ○	2
110	UY466	45°	325	215	200		ⓐ ○	4
160	UMY11C	45°	400	280	280		ⓐ ○	2

All socket

UNEQUAL BRANCHES

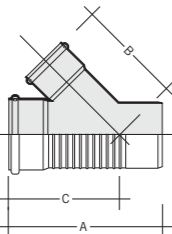

160 x 110	UY64	87½°	340	180	126		○	2
160 x 110	UY66	45°	357	245	254		ⓐ ○	2

Socket/spigot

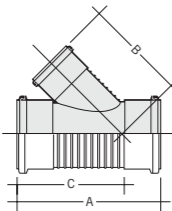

160 x 110	UMY12C	87½°	340	180	252		ⓐ ○	2
160 x 110	UMY10C	45°	316	232	236		ⓐ ○	2

All socket

ACCESS BEND

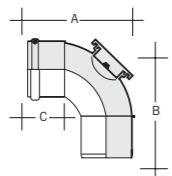

110	UB42	87½°	172	174	80		ⓐ ○	4
-----	-------------	------	-----	-----	----	--	-----	---

With rear access, socket/spigot
Fitted with a twist and lock access cap which can be secured with a No. 8 screw

RODDING POINT

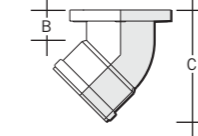
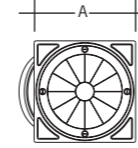

Size mm	Code	Angle	A	B	C	D	Colour	Qty
110	URP1	45°	164	68	70		ⓐ ○	10

A15 loading. Black cover with four screw fixings and seal

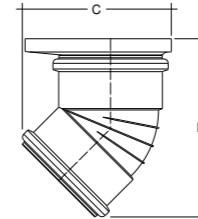

160	URP2C	45°	237	289	241		○	4
-----	--------------	-----	-----	-----	-----	--	---	---

15 loading. Aluminium cover with two screw fixings

SQUARE RODDING POINT COVER (SPARE)

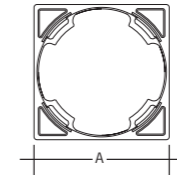
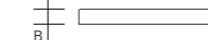

110	URPFSQ		163	18			B	10
-----	---------------	--	-----	----	--	--	---	----

For use with URP1

ACCESS CAP

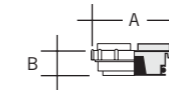

110	UE42		130	30			ⓐ ○	50
160	UE62		195	40			○	15

Solvent socket

PRESSURE PLUG

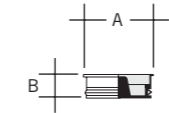

110	UE43		110	30			○	135
160	UE64		160	30			○	30

Push fits into plain end of pipe

250mm adoptable inspection chamber Suitable for up to 2m in depth

INSPECTION CHAMBER BASE	Size mm	Code	A	B	C	D	Colour	Qty
	250	UCC250	182	394	425	A	B	1

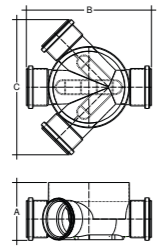

Supplied with 2 blanking plugs. Max invert depth 2m (when used with UAR1riser). All 110mm connections

CHAMBER RISER

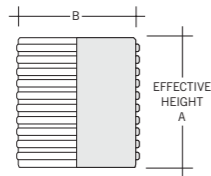

250	UAR1	375	250	A	O	📏	📏	
For use with UCC250								

315mm adoptable inspection chamber Suitable for up to 2m in depth

INSPECTION CHAMBER BASE	Size mm	Code	A	B	C	D	Colour	Qty
	315	UCC315	285	462	462	50	A	B

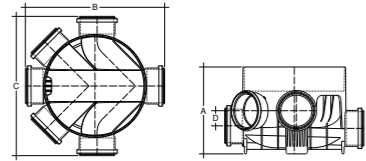

Supplied with 4 blanking plugs. Max invert depth 2m (when used with UAR2/3 riser). All 110mm connections

CHAMBER RISER

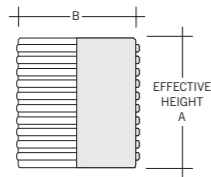

300	UAR2	504	300	A	O	📏	📏	
500mm tall. Includes 300mm seal								

300	UAR3	1008	300	A	O	📏	📏	
1m tall. Includes 300mm seal								

DUCTILE IRON LID AND CAST IRON FRAME

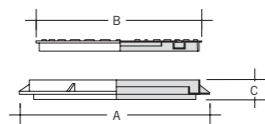

300	UCL315	341	288	55	A	B		
Solvent socket to boss upstand								

450mm adoptable inspection chamber Suitable for up to 3m in depth

450MM INSPECTION CHAMBER BASES	Size mm	Code	A	B	C	D	Colour	Qty
	110/160	UCC5	400	650	490	192	A	B
	110	UCC450	246	610	610	50	A	B

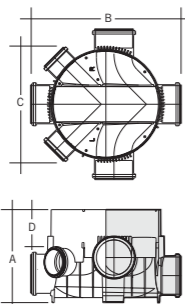

The A and B dimensions relate to the height of side branches above invert level of main channel.

All socket connections.

For further information see table on page 35.

DEEP INSPECTION CHAMBER RISER	Size mm	Code	A	B	C	D	Colour	Qty
	450	UCR3	410	488		A	B	1

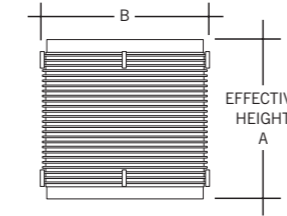

For use with UCC450 or UCC5 when invert depth is greater than 1.2m. 480mm high. Includes one 450mm seal

DUCTILE IRON LID AND CAST IRON FRAME

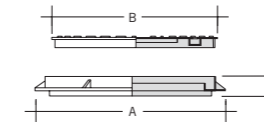

450	UCL125	547	492	48	A	B		
12.5 tonnes								

REDUCED ACCESS RING

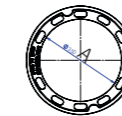

450	UCLRR2	350	17	A	B			
Reduces UCL125 access to 350mm. Required for chambers over 1m in depth								

DEEP INSPECTION CHAMBER RISER CLIP

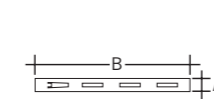

	UCC10D	19	204	A				
For use with UCR3 riser. Zintec coated, supplied in packet of 10. Used to connect chamber to riser and riser to riser.								

INSPECTION CHAMBER INSERTS

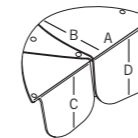

Left hand	UCB1	425	159	171	167	A	B	
Right hand	UCB2	425	159	167	171	A	B	
For use with the UCC5 inspection chamber								

SPARE BLANKING PLUG

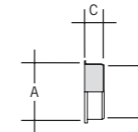

110	UCP1	117	110	40	A	B	70
160	UCP2	165	160	60	A	B	1

SPARE RING SEAL



450	SR450	A	B					
For use with UCR3								

Inspection chamber

450MM INSPECTION CHAMBER BASE

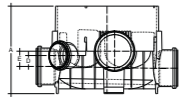
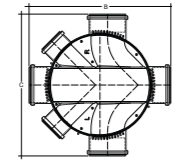

Size mm	Code	A	B	C	D	E	Colour	Qty
110	UCC3	402	651	651	50	70	B	1

Supplied with 4 blanking plugs. Max invert depth 1.2m (when used with UCR2 riser). 245mm high. All 110mm connections.

The 'D' dimension relates to the height of side branches above invert of main channel

CHAMBER RISER

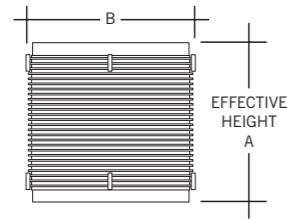

Size mm	Code	Length	A	B	C	D	Colour	Qty
450	UCR2	390	450				B	1

Push fit ring seal joint into chamber base. 430mm high, includes one 450mm seal. For use with UCC3/5 for invert depths up to 1.2m

CHAMBER RISER CLIP

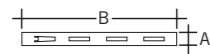

Code	Length	Qty
UCC10	19 200	10

For use with UCR2 riser

Deep inspection chambers

DEEP INSPECTION CHAMBER

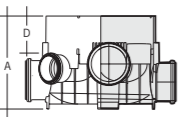
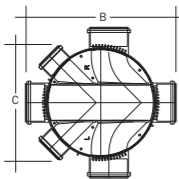

110/160	UCC5	400	650	490	192	A	B	1
110	UCC450	246	610	610	50	A	B	1

The A and B dimensions relate to the height of side branches above invert level of main channel.

All socket connections.

For further information see table on page 35.

DEEP INSPECTION CHAMBER RISER

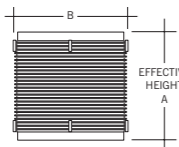

450	UCR3	410	488			A	B	1
-----	-------------	-----	-----	--	--	---	---	---

For use with UCC3D or UCC5 when invert depth is greater than 1.2m.

Max invert depth 4m

480mm high

Includes one 450mm seal

DEEP INSPECTION CHAMBER RISER CLIP

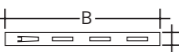

Code	Length	Qty
UCC10D	19 204	10

For use with UCR3 riser.

Zintec coated, supplied in packet of 10.

Used to connect chamber to riser and riser to riser.

Lids and frames for inspection and deep inspection chambers

CAST IRON COVER AND FRAME

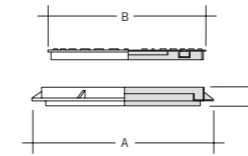
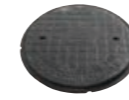

Size mm	Code	A	B	C	D	Colour	Qty
450	UCL35	517	490	40		B	1

3.5 tonnes. Domestic driveway loading

DUCTILE IRON LID AND CAST IRON FRAME

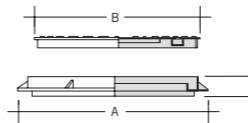

450	UCL125	547	492	48		A	B	1
-----	---------------	-----	-----	----	--	---	---	---

12.5 tonnes

REDUCED ACCESS RING

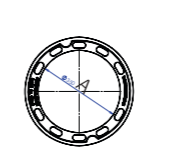

450	UCLRR2	350	17			A	B	1
-----	---------------	-----	----	--	--	---	---	---

Reduces UCL125 access to 350mm

Required for chambers over 1m in depth

POLYPROPYLENE COVER AND FRAME

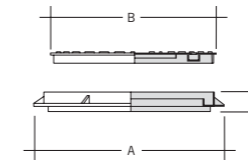

450	UCL35PP	547	494	70		B		1
-----	----------------	-----	-----	----	--	---	--	---

3.5 tonnes. Domestic driveway loading

450	UCL35SQ	547	494	70		B		1
-----	----------------	-----	-----	----	--	---	--	---

3.5 tonnes. Domestic driveway loading

REDUCED ACCESS RING

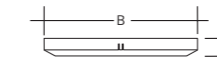

450	UCLRR	60	455			B		1
-----	--------------	----	-----	--	--	---	--	---

Provides 350mm restricted opening. Snap lock connection to the frame of the UCL35PP and UCL35SQ

Shallow inspection chambers

SHALLOW INSPECTION CHAMBER		Size mm	Code	A	B	C	D	Colour	Qty
		250	UCC7	380	420	600		O	1

Maximum invert depth – 600mm
All 110mm socket connections

DOUBLE BRANCH CHAMBER BASE		Size mm	Code	A	B	C	D	Colour	Qty
		250	UAC44	344	275	170		O	1

45° equal connections
Includes two socket plugs and profiled insert
Maximum invert depth – 600mm

BOTTOM OUTLET CHAMBER BODY		Size mm	Code	A	B	C	D	Colour	Qty
		250	UAC02	428	415	120		O	1

Maximum invert depth to side connections – 600mm
90° equal connections
4 x 110mm upstands, 3 open connections

CHAMBER RISER		Size mm	Code	A	B	C	D	Colour	Qty
		250	UAR1	375	250			O	1

For use with UAC44, UAC02 and UCC250

Solid wall drainage systems

LIFTING HANDLE		Size mm	Code	Length	A	B	C	D	Colour	Qty
		40	KP204W	4m	40				W	10

For use with UAC44

INSPECTION CHAMBER LID & FRAME		Size mm	Code	A	B	C	D	Colour	Qty
		250	UCL2	280	50	20		B	1

PVCu (A15 loading)

SPARE RING SEAL		Size mm	Code	A	B	C	D	Colour	Qty
		250	SR250					B	1

Optional for UCL2 PVCu lid

SQUARE LID & FRAME		Size mm	Code	A	B	C	D	Colour	Qty
		250	UCL3	318	20	78		B	1

A15 loading

STRAIGHT DOUBLE SPIGOT OPEN CHANNEL		Size mm	Code	A	B	C	D	Colour	Qty
		110	UCC4	1500	610	445		O	1

Double spigot, keyed for sand/cement benching
1.5m long, with 600mm opening

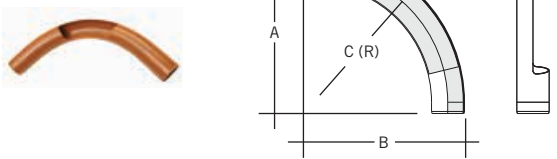
LONG RADIUS OPEN CHANNEL BEND		Size mm	Code	Angle	A	B	C	D	Colour	Qty
		110	UCB48L	87½°	310	360	270		O	1

Double spigot, keyed for sand/cement benching

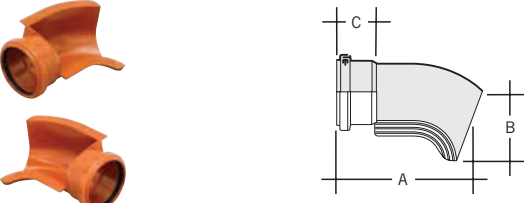
SLIPPER BENDS		Size mm	Code	Angle	A	B	C	D	Colour	Qty
		110	USB41		230	120	65		O	1

Left hand

110	USB41		230	120	65			O	1
-----	--------------	--	-----	-----	----	--	--	---	---

Right hand

110	USB42		230	120	65			O	1
-----	--------------	--	-----	-----	----	--	--	---	---

Push-fit socket, keyed for sand/cement benching.
Bend may be trimmed to adjust the angle of entry to the manhole.

Solid wall drainage systems

LEVEL INVERT REDUCERS

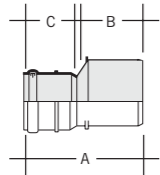

Size mm	Code	A	B	C	D	Colour	Qty
110-82	URM304	135	67	54	A	O	4
160-110	URM604	219	90	82	A	O	4

Spigot/socket

CONCENTRIC REDUCERS

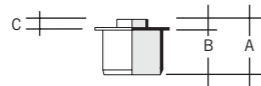

110-50	SE41	103	80	19		B G	1
--------	-------------	-----	----	----	--	-----	---

Spigot to boss upstand

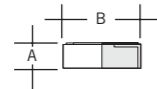

110	UA42	31	104			B	100
-----	-------------	----	-----	--	--	---	-----

110 x 68/65mm

ECCENTRIC REDUCERS



82-50	SRM30	70	48	19		B G	90
-------	--------------	----	----	----	--	-----	----

110-50	SRM402	48	25	19		B G	10
--------	---------------	----	----	----	--	-----	----

Solvent socket to boss upstand

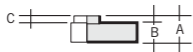

110-68	URM425	40	25	12		O	10
--------	---------------	----	----	----	--	---	----

110	UA43	58	25	34		B	1
-----	-------------	----	----	----	--	---	---

URM425 Solvent socket to 68mm downpipe
UA43 Universal waste to 110mm drain

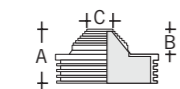
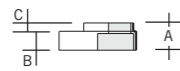

BOTTLE GULLY

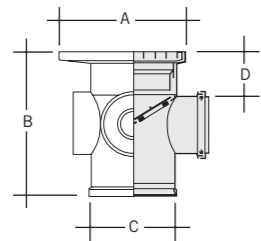

110	UG50	237	277	152	95	A O	1
-----	-------------	-----	-----	-----	----	-----	---

A15 loading
Push fit socket outlet, three 110mm solvent weld inlets with 50mm boss upstands and rodding access

Bottle gully with back inlet plugged

110	UG50D	237	277	152	95	O	1
-----	--------------	-----	-----	-----	----	---	---

A15 loading

BOTTLE GULLY RAISING PIECE

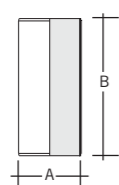

160	UG52	160	352			O	1
-----	-------------	-----	-----	--	--	---	---

For use with bottle gully UG50 to adjust invert level of trap outlet

SPARE BOTTLE GULLY GRID

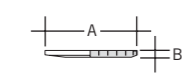
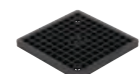

Sealed lid	UG51	228	23			B	1
------------	-------------	-----	----	--	--	---	---

Sealed lid	UG51SA	228	45			B	1
------------	---------------	-----	----	--	--	---	---

For use with UG50 bottle gully

'P' TRAP GULLY

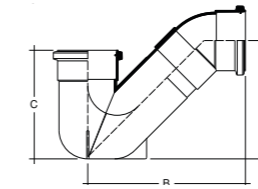

Size mm	Code	A	B	C	D	Colour	Qty
110	UG42	230	306	211		O	1

Push-fit socket inlet, 87½° socket outlet

GULLY TRAP BASE

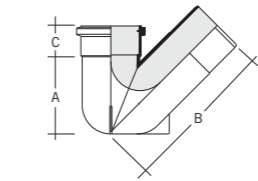

110	UG44	155	300	57		O	4
-----	-------------	-----	-----	----	--	---	---

Solvent socket inlet, 45° spigot outlet

RECTANGULAR HOPPER

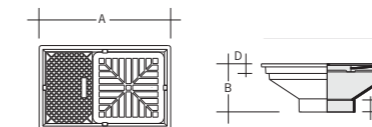

110	UG47	232	142	50		O	4
-----	-------------	-----	-----	----	--	---	---

SQUARE HOPPER

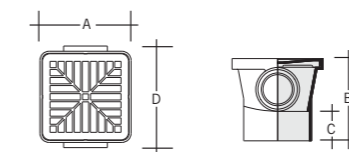

110	UG48	160	142	50		O	4
-----	-------------	-----	-----	----	--	---	---

Solvent socket, accepts 68mm downpipe inside larger boss with two 50mm boss upstands
Grating meets requirements of BS 4660: 2000 load Class K3

GRATING ASSEMBLY

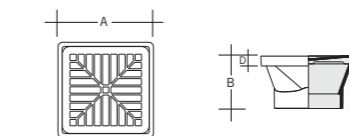

110	UG45	162	55	28		O	30
-----	-------------	-----	----	----	--	---	----

Solvent socket
Grating meets requirements of BS 4660: 2000 load Class K3

SPARE GULLY GRID

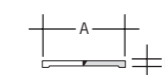

110	UG46	149	14			B	20
-----	-------------	-----	----	--	--	---	----

For use with UG45, UG47 & UG48 gully hoppers

SPARE GULLY BACK PLATE

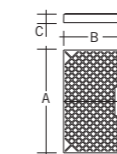

110	UG49	150	100	16		B	20
-----	-------------	-----	-----	----	--	---	----

For ancillary items

please refer to the Below Ground Trade Price List.

Solid wall drainage systems

INLET RAISING PIECES

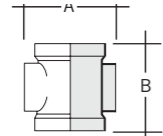

Size mm	Code	A	B	C	D	Colour	Qty
110	UWS43	148	156			O	4

2 x 82mm upstands

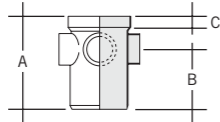

110	UW401	181	125	20		O	4
-----	--------------	-----	-----	----	--	---	---

Solvent socket/spigot, four 50mm boss upstands, one open

YARD GULLY

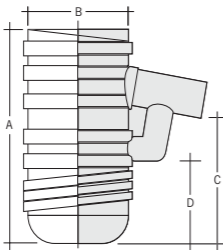

110	UYG40	634	315	392	238	B	1
-----	--------------	-----	-----	-----	-----	---	---

Black high density polyethylene with spigot outlet and removable rodding access plug

GRATING AND FRAME FOR YARD GULLY

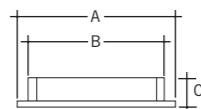

400	UYG42	400	320	75		B	1
-----	--------------	-----	-----	----	--	---	---

Cast iron with hinged grating
B125 loading (12.5 tonne test load) suitable for car park areas

ADAPTORS

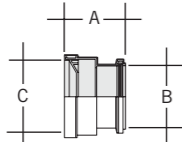

110	UCA40	120	110	130		B	1
-----	--------------	-----	-----	-----	--	---	---

Socket/socket to suit thin wall clayware spigot pipe

110	UCA41	120	110	138		B	1
-----	--------------	-----	-----	-----	--	---	---

Socket/socket to suit thick wall clayware pipe

ANTI-FLOOD VALVE

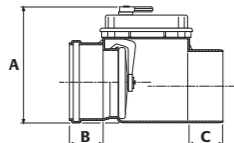

110	USW130	175	52	69		B	1
-----	---------------	-----	----	----	--	---	---

160	USW140	225	100	92		B	1
-----	---------------	-----	-----	----	--	---	---

Double flap

Quantum structured wall drainage systems

QUANTUM SEWER PIPE

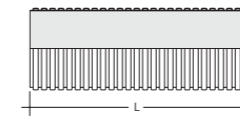

Size mm	Code	Length	A	B	C	D	Colour	Qty
150	ULS13	3m					A O	46
225	ULS23	3m					A O	16
300	ULS33	3m					A O	9
150	ULS16	6m					A O	46

Double spigot

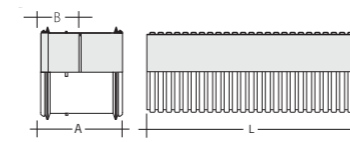

150	UPS13*	3m	170	83			A O	46
225	UPS23	3m	220	94			A O	16
300	UPS33	3m	237	110			A O	9
150	UPS16*	6m	170	83			A O	46
225	UPS26	6m	220	94			A O	16
300	UPS36	6m	237	110			A O	9

*Pipe with coupling and seals

QUANTUM HIGHWAY PIPE

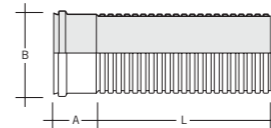

150	UPH16	6m	90	175			O	46
225	UPH26	6m	125	275			O	16
300	UPH36	6m	110	340			O	9

Push-fit socket

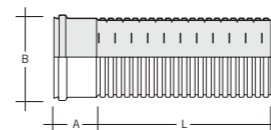

150	USH16	6m	90	175			O	46
225	USH26	6m	125	275			O	16
300	USH36	6m	110	340			O	9

Half slotted socket
Order seals if necessary

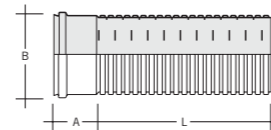

150	UHH16	6m	90	175			O	46
225	UHH26	6m	125	275			O	16
300	UHH36	6m	110	340			O	9

Fully slotted socket
Order seals if necessary

COUPLINGS

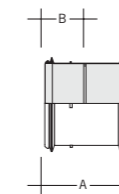

Straight

150	UME15Q	170	83				A O	4
225	UME25	220	94				A O	2
300	UME35	237	110				A O	2

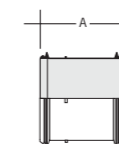

Slip

150	UME16Q	170					A O	4
225	UME26	220					A O	2
300	UME36	237					A O	2

Quantum structured wall drainage systems

BENDS		Size mm	Code	Angle	A	B	C	D	Colour	Qty
		150	UMB19Q	87½°	200				O	2
		225	UMB29	87½°	595				O	2
		300	UMB39	87½°	730				O	2
		150	UMB14Q	45°	115				O	2
		225	UMB24	45°	160				O	2
		300	UMB34	45°	195				O	2
		150	UMB13Q	30°	105				O	2
		225	UMB23	30°	145				O	2
		300	UMB33	30°	175				O	2
		150	UMB11Q	15°	95				O	2
		225	UMB21	15°	125				O	2
		300	UMB31	15°	150				O	2

Double socket

EQUAL BRANCH		Size mm	Code	Angle	A	B	C	D	Colour	Qty
		150	UMY13Q*	87½°	400	200	280		O	2
		150	UMY11Q*	45°	400	280	280		O	2
		225	UMB22	45°	655	430	460		O	2
		300	UMB33	45°	800	540	575		O	2

All socket

All socket

All socket

UNEQUAL BRANCH		Size mm	Code	Angle	A	B	C	D	Colour	Qty	
		87½°									
		150x110	UMY12Q*		340	180	236			O	2
		45°									
		150x110	UMY10Q*		316	232	236			O	2
		225x110	UMY20		370	300	300			O	1
		225x150	UMY21*		440	340	340			O	1
		300x110	UMY30		520	375	425			O	1
		300x150	UMY31*		590	425	460			O	1
		300x225	UMY32		700	520	480			O	1

* Supplied with black snap cap.
To convert 150mm branch to accept 160mm solid wall pipe, a snap cap SNC6 and ring seal SR160T must be fitted.

PLUGS		Size mm	Code	Colour	Qty
		Socket plug			
		150	UMJ11	O	1
		End cap			
		150	UMK11	O	1
		225	UMK21	O	1
300	UMK31	O	11		

LEVEL INVERT REDUCER		Size mm	Code	Colour	Qty
		225x150	UML21	O	1
		300x225	UML32	O	1

ADAPTORS		Size mm	Code	A	B	C	D	Colour	Qty
		150	UMA45	230	90	60		O	1
		Quantum/solid wall PVC to clayware pipe coupler							
		150	UMA17	160	71	82		O	1
		Quantum socket to solid wall spigot							

FLEXIBLE COUPLING		Size mm	Code	A	Colour	Qty
		150	UMD17	150	B	1
		225	UMD27	130	B	1
		300	UMD37	160	B	1

PIPE SEALS		Size mm	Code	A	B	Qty
		150	UMR150		B	5
		225	UMR225		B	5
		300	UMR300		B	5
Quantum pipe seal						
		150	SR160T		B	5
		BS 4660 seal to convert Quantum 150mm sockets for use with BS EN 1401 pipe				
		150	SNC6		O	1
		Snap cap to convert Quantum 150mm sockets for use with BS EN 1401 pipe				

POLYETHYLENE GULLY POT LINER		Size mm	Code	A	B	C	D	Colour	Qty
		150	UMA43	760	500	520	220	B	1
		90 litres 760mm deep x 500mm diameter							
		150	UMA49	920	500	680	380	B	1
		112 litres 920mm deep x 500mm diameter							

RODDING POINT		Size mm	Code	A	B	C	D	Colour	Qty
		45°							
		150	URP2Q	237	289	241		O	1
Socketed with aluminium cover									

SILICONE LUBRICANT		Size	Code	Qty
		Tub 1kg		
		1	UMA41	1
Water Research Centre Approved				

Large diameter quantum highway

6M PIPE

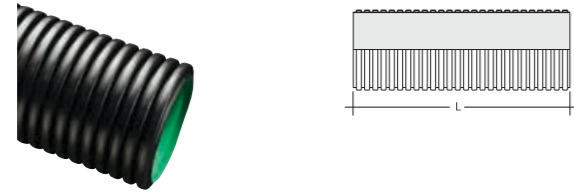

Size mm	Code	Length	A	B	C	D	Colour	Qty
Solid wall								
375	UPH375*	6m					B	1
450	UPH450*	6m					B	1
600	UPH600*	6m					B	1
Half perforated								
375	USH375	6m					B	1
450	USH450	6m					B	1
600	USH600	6m					B	1

Size mm	Code	Length	A	B	C	D	Colour	Qty
Fully perforated								
375	UHH375	6m					B	1
450	UHH450	6m					B	1
600	UHH600	6m					B	1

All pipes are socketed, or supplied with coupling and seal

COUPLING



375	UME375*	330					B	1
450	UME450*	396					B	1
600	UME600*	490					B	1

SEALING RING



375	UMR375*						B	1
450	UMR450*						B	1
600	UMR600*						B	1

BEND

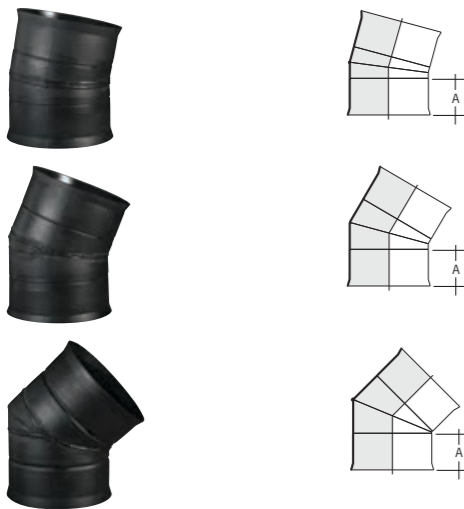

11.25°								
375	UMB3751	225					B	1
450	UMB4501	275					B	1
600	UMB6001	325					B	1
22.5°								
375	UMB3752	225					B	1
450	UMB4502	245					B	1
600	UMB6002	325					B	1
45°								
375	UMB3754*	225					B	1
450	UMB4504*	245					B	1
600	UMB6004	325					B	1

BEND



Size mm	Code	A	B	C	D	Colour	Qty
90°							
375	UMB3759	250	90			B	1
450	UMB4509	290	100			B	1
600	UMB6009	370	100			B	1

BRANCH

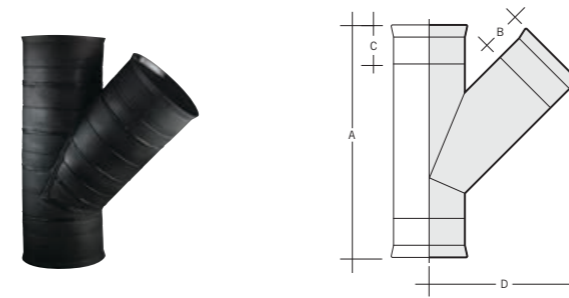

45°							
375x160	UMY3751*	795	80	185	595	B	1
375x250	UMY3752	970	140	185	695	B	1
375x315	UMY3753	1100	160	185	795	B	1
375x375	UMY3754	1240	185	185	760	B	1
450x160	UMY4501*	970	80	200	640	B	1
450x250	UMY4502	1130	140	200	735	B	1
450x315	UMY4503	1230	160	200	840	B	1
450x375	UMY4504	1390	185	200	800	B	1
450x450	UMY4505	1490	200	200	895	B	1
600x160	UMY6001	995	80	240	730	B	1
600x250	UMY6002	1190	140	240	825	B	1
600x315	UMY6003	1320	160	240	930	B	1
600x375	UMY6004	1505	185	240	890	B	1
600x450	UMY6005	1640	200	240	985	B	1
600x600	UMY6006	1900	240	240	1190	B	1

90°							
375x160	UMT3751	665	80	185	585	B	1
375x250	UMT3752	815	140	185	620	B	1
375x315	UMT3753	840	160	185	675	B	1
375x375	UMT3754	1000	185	185	500	B	1
450x160	UMT4501	710	80	200	580	B	1
450x250	UMT4502	815	140	200	665	B	1
450x315	UMT4503	870	160	200	720	B	1
450x375	UMT4504	980	185	200	540	B	1
450x450	UMT4505	1320	200	200	660	B	1
600x160	UMT6001	865	80	240	620	B	1
600x250	UMT6002	1060	140	240	665	B	1
600x315	UMT6003	1125	160	240	810	B	1
600x375	UMT6004	1190	185	240	630	B	1
600x450	UMT6005	1450	200	240	760	B	1
600x600	UMT6006	1650	240	240	825	B	1

160, 250 and 315mm branch connections are spigot ended and need to be used in conjunction with couplings and seals. For 160mm branch, use UME15C coupling. For 250mm branch, use UMD23 coupling. For 300mm branch use UMD33 coupling. Remove one snap cap and seal from UME15C to convert to 150mm quantum. The 375, 450 and 600mm branches are all socketed.

FLEXIBLE COUPLING



250/225	UMD23	250	150	250		B	1
315/300	UMD33	315	190	315		B	1

Statutory requirements

The following standards deal with drainage design:

- BS EN 752: Drain and sewer systems outside buildings.
- BS EN 2015: Construction and testing of drains and sewers.

The design and layout of drainage and sewerage systems should comply with The Building Regulations and Water Authority Specification. Reference should also be made to the Sewers for Adoption manual.

The following information is provided only as a general guide to good practice for the design of underground drainage systems. For full details please consult the relevant documents referred to left.

Means of access

Access is required to drainage installations for testing, inspection and removal of debris. Access to drainage allowing rodding in both directions can be provided by inspection chambers, manholes and other access fittings. Rodding eyes provide access for clearance of debris in the direction of flow only and should thus be used in conjunction with an access chamber or manhole at a point downstream.

No part of the drain or sewer should be more than 50m away from a manhole. The distance between points should therefore not exceed 100m.

For full guidance as to provision of access, reference should be made to BS EN 752. The table right details the maximum spacing of the access points as detailed in the above standard.

	To junction/branch	To access fitting	To inspection chamber	To manhole
From start of external drain		12	22	45
From rodding point	12	12	22	45
From access fitting	12	12	22	45
From inspection chamber	12	22	45	45
From manhole			45	90

Gradients

Foul water drainage systems are generally designed to run at a maximum of three quarters full bore. Pipe gradients should be established such that the velocity does not fall below 0.70 m/s to ensure adequate self-cleansing.

A 110mm foul drain taking the discharge of less than 1 l/s should be laid at a 1:40 (25mm per metre) fall. A foul drain taking the discharge from a minimum of one WC can be laid at 1:80 (12.5mm per metre).

Gullies incorporating in foul water or combined drainage systems must have a 50mm minimum water seal.

The table right is taken from BS EN 752 and provides guidance on minimum gradients for different size drains

Peak flow (a) litres/second	PVCu pipe size (mm)	Minimum gradient
<1	110	1:40
>1	110	1:80 (b)
	160	1:150 (c)

- (a) Peak flow based on probability flow calculation method
 (b) Minimum 1 WC
 (c) Minimum 5 WCs
 Surface water drainage systems may be designed to run full bore.

Physical characteristics

Dimensions and weights

	Material	BS nominal size (mm)	Min	Max	Wall thickness (mm)	Weight kg/metre
Solid Wall	PVCu	110	110.0	110.3	3.2	1.7
		160	160.0	160.4	4.0	3.0
Quantum Sewer	PVCu	150	145	160		1.85
		225	226	250		4.20
		300	297	330		7.00
Quantum Highway	PVCu	150	148	160		1.25
		225	230	250		2.75
		300	302	330		4.65
Quantum Highway	HDPE	375	396	465		8.50
		450	496	580		13.30
		600	598	700		20.83

Pipe strength

	Pipe type	Pipe size	SN N/m ² @ 20°C
Minimum short-term ring stiffness	Marley solid wall	110mm	8000
	Marley solid wall	160mm	4000
Minimum short-term ring stiffness	Quantum Sewer		8000
	Quantum Highway		6000
Minimum two-year ring stiffness	Quantum Sewer		4000
	Quantum Highway		3000

Solid wall perforated pipe

110mm solid wall perforated pipe is manufactured to the dimensional requirements of BS EN 1401-1. Pipe has two rows of slots that are 60mm apart and 1.75mm wide. Slot sizes as detailed in the table opposite.

The slotted cross sectional area for both solid wall and Quantum pipes exceed the perforation requirements of the Department of Transport 'Specification for Highway Works' 2001. This requires a minimum perforated area of 1000mm²/m irrespective of pipe diameter.

Pipe size (mm)	Slot width (mm)	Slot length (mm)	Slotted pipe (mm ² /m)
110	1.75	24	2041

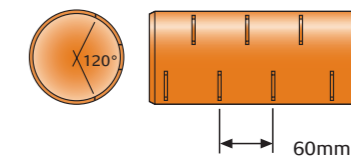

Quantum perforated pipes

Quantum highway pipes are available in 150, 225, 300, 375, 450 and 600mm sizes, in either fully slotted or half slotted options. Slot sizes are detailed in the table opposite.

Nominal pipe size (mm)	Slot width (mm)	Slot length (mm)	Area half slotted pipe (mm ² /m)	Area fully slotted pipe (mm ² /m)
150	1.5	22	3000	6000
225	1.5	38	3500	7000
300	1.5	58	4000	8000
375	3.5	35 - 40	11270	22540
450	3.5	35 - 40	9310	18620
600	3.5	35 - 40	7350	14700

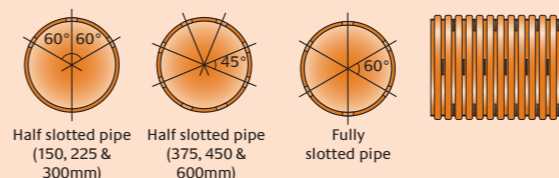

The following information is based on the recommendations in BS 5955: Part 6 'Installation of PVCu pipework for gravity drains and sewers' and BS EN 1610 'Construction and testing of drains and sewers' and is intended as a general guide to good practice in the selection of bedding and backfill materials for Marley solid wall and Quantum underground drainage systems.



Bedding & backfill

Where the as-dug material is suitable*, the bottom of the trench may be trimmed to form the pipe bed and the as-dug soil used as sidefill and backfill in accordance with BS EN 1610 bedding construction type B (see drawing below).

Where the as-dug material is unsuitable as bed and surround, installation should be carried out in accordance with BS EN 1610 bedding construction type 1, as shown below.

Trenches should be excavated to allow for the depth of bedding material. Before any pipework is installed the bedding material should be laid evenly along the bottom of the trench.

The sidefill material must be the same as the bedding material and extended to the crown of the pipe and be thoroughly compacted.

Where the backfill above the pipe contains stones larger than 40mm or where the pipework is deeper than 2m in poor ground, the granular material must extend at least 100mm above the pipe crown. Alternatively, backfill material can be graded to eliminate stones exceeding 40mm and this selected material used for the first 300mm above the pipe.

When the pipes are to be laid in rock, compacted sand or gravel, or in very soft or wet ground requiring mechanical means of trimming, the bedding should be a minimum of 100mm.

*Suitable material is defined as material in accordance with the recommendations of BS 5955: Part 6: Appendix A, having a maximum particle size not exceeding 20mm.



Excavation

Trenches should not be open for extended periods in advance of pipe laying and should be backfilled as soon as possible. It is essential that the sides of the trench are adequately supported during pipe laying. Trench widths should be as narrow as is practicable but not less than the pipe diameter plus 300mm to allow adequate sidefill to be placed. Deeper excavations should ideally incorporate a sub-trench in accordance with the diagram opposite.

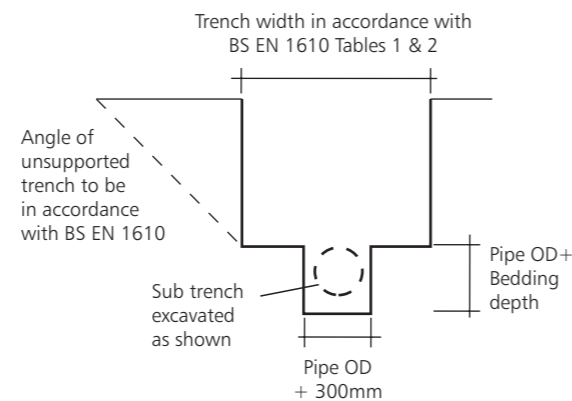

Granular material for bed & surround of PVCu drains and sewers

Suitable imported granular material for bedding and surrounding PVCu solid wall and Quantum pipes for private and adoptable sewer applications is detailed in the table opposite:

Grading complying with the requirements of BS EN 1610.

Nominal pipe size	Granular material size
100/110mm	10mm nominal single-size
	14 to 5mm course graded
150/160mm	10 or 14mm nominal single-size
	14 to 5mm course graded
150/225mm and over	10,14 or 20mm nominal single-size
	14 or 20 to 5mm course graded

BS EN 1610 bedding construction Type B

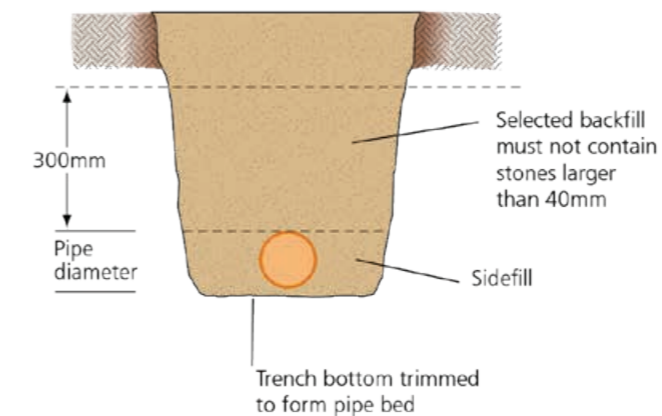

BS EN 1610 bedding construction Type 1

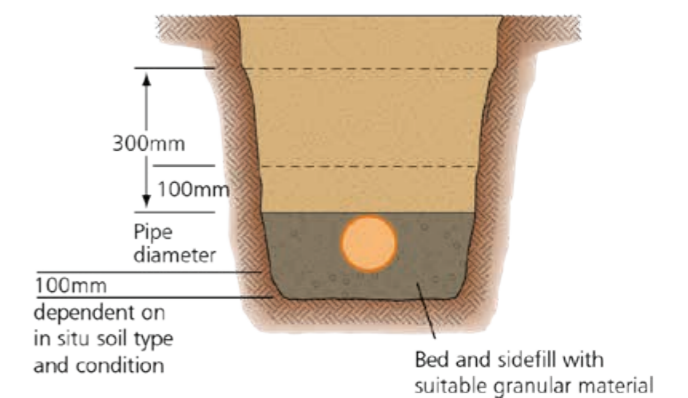

It is important to ensure that the ground is prepared correctly and that suitable bedding and backfill material is used, depending on the soil type and the loading required.



Shallow domestic drains

Pipes laid at depths less than 600mm and which are not under a road should, where necessary, be protected against damage by placing over them a layer of concrete, paving slabs or similar. A minimum 75mm cushioning layer of granular material must be laid between pipes and the slabs or concrete.

Where drains are laid in fields, additional protection may be required from heavy vehicles and equipment. It is recommended that the installation is carried out with a concrete slab spanning the trench as shown for drains under private roads (on opposite page below).

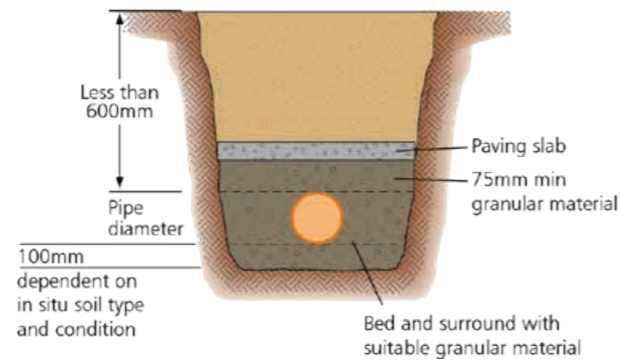

Drains under solid ground floors

Drains often have to be laid under buildings in order to connect sanitary pipework which has been positioned some distance from the outer walls. Where this occurs, deep hardcore within the foundation boundaries should be compacted first. The trench for the pipe should then be excavated and suitable material employed for the bedding and backfilling operation. If trenches are dug from original ground, pipes may be laid and surrounded as necessary before the top layer of hardcore is formed. Where a pipe passes through a wall or foundation of a building, a lintel or sleeve should be built-in to provide clearance around the pipe.

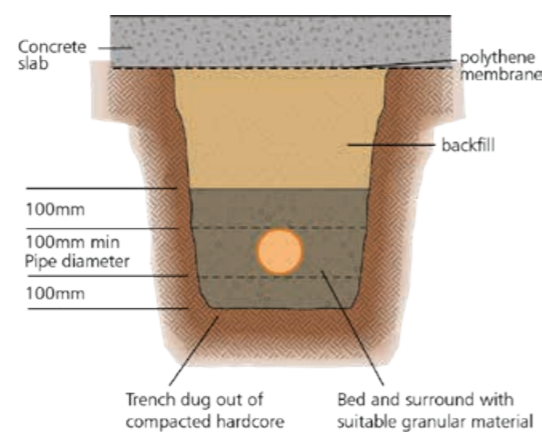

Concrete bed & surround

The flexible nature of PVCu pipes enables them to accommodate ground movement and other differential settlement that may occur under normal conditions. Therefore, the use of concrete bed and surround is not recommended and only under special circumstances, at very shallow cover depths or where it is necessary to safeguard foundations, should it be used. Where the use of concrete bed and surround is unavoidable, it is recommended that pipes are laid in 3 metre lengths and a compressible board is shaped to fit around each joint. Pipes should also be wrapped with polythene to prevent the ingress of cement slurry into ring seal joints.

Drains under private roads

If the depth of cover under a road or driveway is less than 0.9m, a concrete slab spanning the trench width is required.

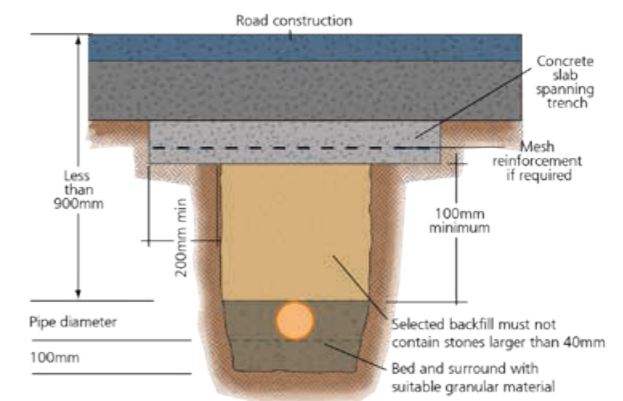

Adoptable sewers under roads

For adoptable sewer applications pipe bedding details should be in accordance with the Water Industry Specification. Selected as-dug material may be used for bedding and sidefill provided it meets the evaluation procedure and compaction fraction test values specified in WIS 4-08-01. The minimum cover under public roads should be 1.2m to the top of the pipe. The above information is for general guidance only and detailed proposals with regard to bedding and sidefill materials for sewers must be submitted to the relevant Adopting Authority for formal approval at the design stage of the project.

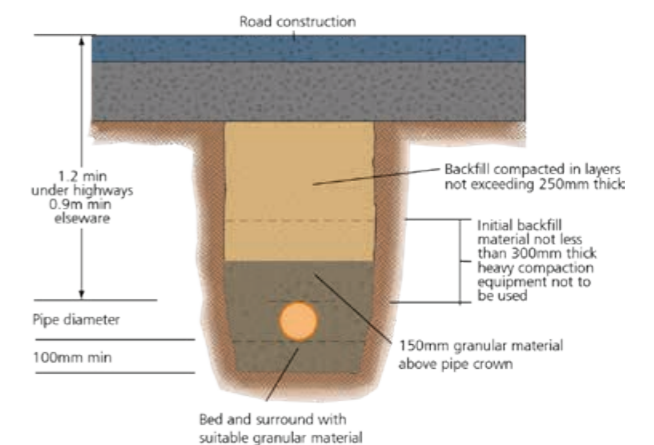

Highway drainage carrier drains

For applications in accordance with DTp requirements, the pipe bedding and backfill details shown below are recommended for PVCu pipes, as specified in the DTp Advice Note HA 40/01 'Determination of Pipe and Bedding Combinations for Drainage Works'.

Special consideration should be given to the protection of pipes from construction site traffic.

Filter drains

For applications in accordance with DTp requirements, the pipe bedding and backfill details shown opposite are as recommended in DTp Advice Note HA 40/89 'Determination of Pipe and Bedding Combinations for Drainage Works'.

Minimum cover to drains to be 900mm, maximum cover to be 6000mm.

Minimum trench width $Y = X + 300$ for drains not exceeding 1.5m cover below finished level.

$Y = X + 450$ for drains exceeding 1.5m cover.

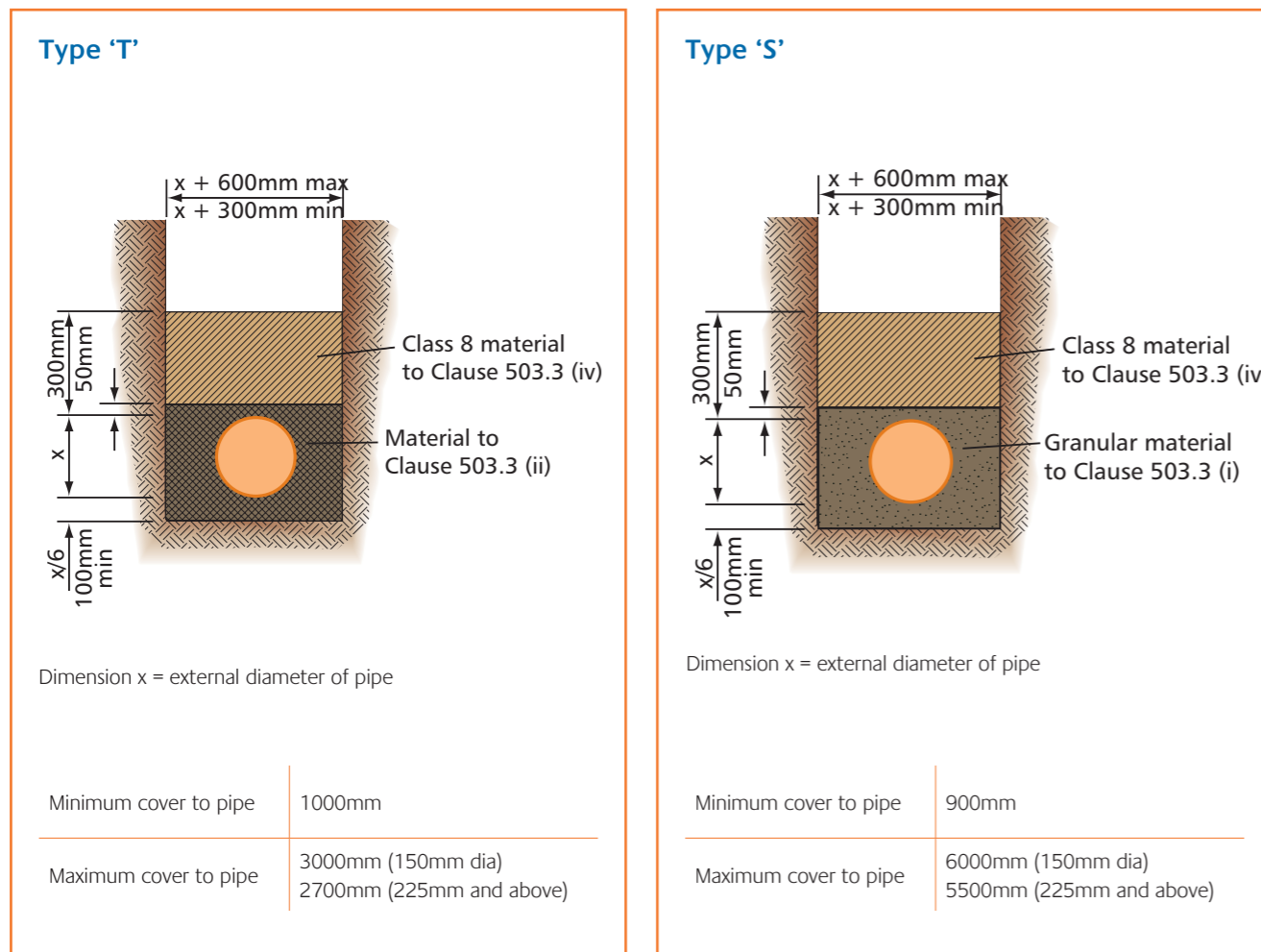

Note:

1. Clause numbers quoted opposite refer to the DTp 'Specification for Highway Works' 2001.
2. The minimum and maximum trench width applies on and below a line 300mm above the outside top of the pipe.

Bedding and Backfill Details

Type 'T' – Field Loading

Type 'S' – Main Road Loading

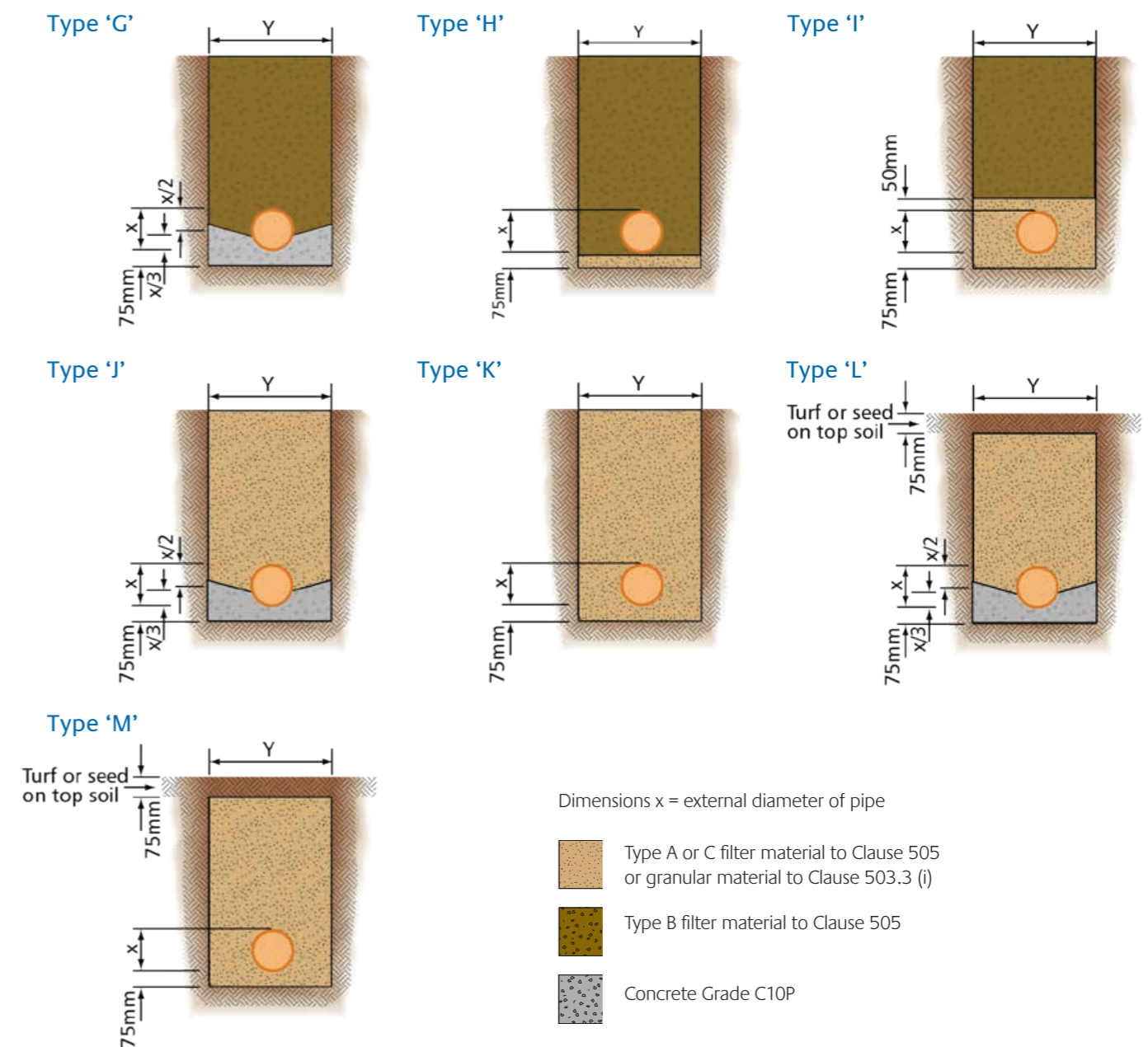

Rodding points

A rodding point may be located at the head of a drain as an alternative to an inspection chamber or manhole. As rodding is only possible in one direction, which must be in the direction of flow, sufficient rodding points should be incorporated to provide access to all parts of the drain.

Since it is not possible to remove debris from a rodding point, a shallow access chamber, inspection chamber or manhole must be provided at a point downstream.

Rodding points should not be used on drains with invert depths of more than 2m and care must be taken during installation to ensure no load is transferred onto the branch upstand of pipe. The URP1 45° rodding point terminal may be used in situations accessible to light motor vehicles of up to 0.5 tonne wheel load provided it is bedded and surrounded in concrete.

Where rodding points are positioned in gardens it is also recommended that the area surrounding the terminal is paved or concreted to prevent the cover from becoming concealed by grass or soil.

Head of drain rodding point

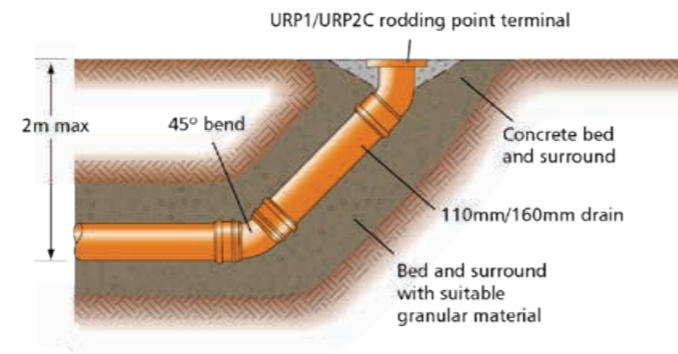

Inspection chambers

Where inspection chambers are used to make a 90° change of direction in the drain, 45° bends should be fitted to the inlet and outlet connections to maintain a level invert through the chamber. It is also recommended that the peak flow in the drain is always discharged through the main channel and chambers are rotated accordingly on site to accommodate this.

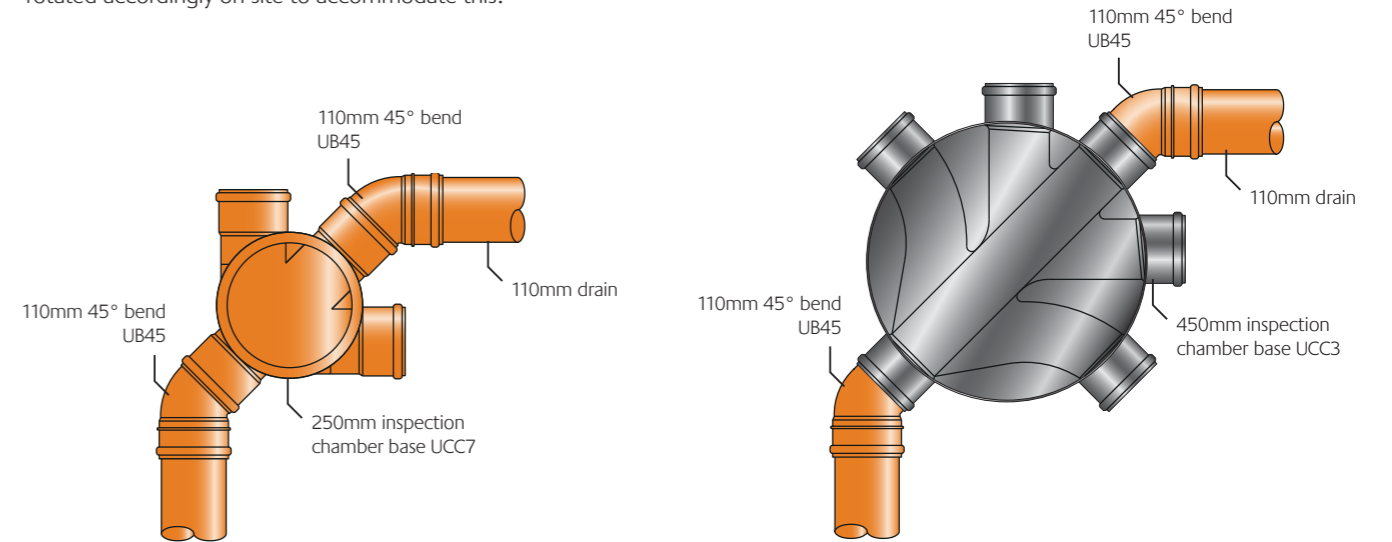

Typical 250mm inspection chamber 90° change of direction

Typical 450mm inspection chamber 90° change of direction

250mm inspection chambers

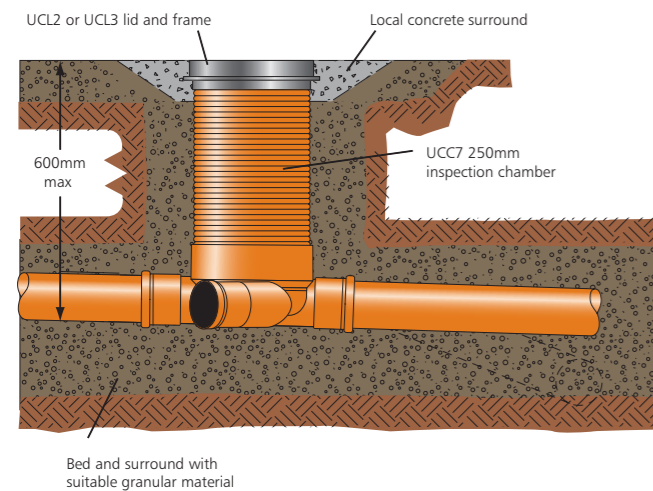

250mm inspection chambers may be used as an alternative to traditional manholes for invert depths up to 600mm. Intermediate depths can be accommodated by cutting the chamber riser using a hard tipped handsaw or similar.

The UCC7 is a one piece, level invert chamber with push-fit inlet and outlet sockets, making installation quick and easy.

Square or circular PVCu lids and frames are available for use with 250mm diameter inspection chambers and meet the loading requirements of BS EN 124 Class A15.

An alternative to the UCC7 is the level invert chamber base UAC44 with separate riser UAR1. Both square or circular lids and frames are suitable for use with this inspection chamber assembly.

250mm bottom outlet inspection chambers

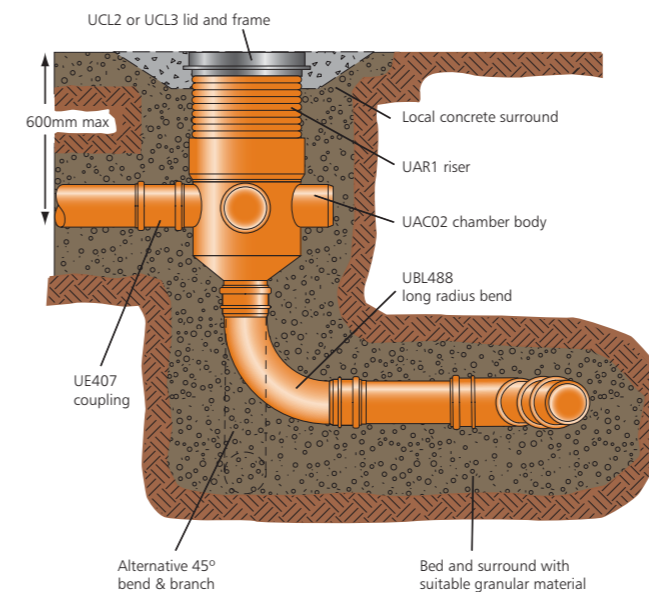

The 250mm bottom outlet inspection chamber UAC02 provides a multiple collection point for branch drains from one or more dwellings and may also serve as a rodding and testing point for the main drain. The 110mm bottom outlet ensures that discharges from the side branches are quickly transmitted to the main drain which may be situated directly under the chamber or to one side at a lower level.

The bottom outlet chamber is ideal for situations where the main drain runs parallel to a building at a lower level as this allows the chamber to be positioned directly above the drain. Connection is then made using a back drop arrangement with a 45° branch and bend to the main drain.

Each chamber has four 110mm spigot inlets, three of which are open and the fourth can be opened for use if necessary. The UE43 plug can be used to blank off connections not required and the chamber riser UAR1 cut to accommodate invert depths of less than 600mm.

The UCL2 circular or UCL3 square lid and frame can be used to provide access to the chamber at ground level.

Inspection chambers

450mm inspection chambers may be used as an alternative to traditionally constructed manholes for invert depths of up to 1.2 metres. Intermediate depths can easily be accommodated by simply cutting a riser, between the ribbed sections, to the desired height using a fine tooth saw.

450mm inspection chambers

Chambers should be installed on a 100mm bed of suitable as-dug or granular material and care should be taken to ensure the bedding material is evenly compacted under the base so that the chamber is fully supported.

During the installation stage and prior to backfilling, it is recommended that chamber riser retaining clips UCC10 are fitted to maintain vertical alignment of the chamber during the backfilling operation.

Sidefill material should extend to just below ground level and the cast iron cover and frame set in a concrete plinth.

Two versions of chamber base are available, the UCC3 has 110mm inlets and outlet and the UCC5 has 110/160mm inlets and 160mm outlet. Both have ring seal socket connections.

When connecting the UCC3 or UCC5 chamber base to a riser, the ring seal is always located in the first groove, as detailed opposite. To ease jointing it is recommended that silicone lubricant is used.

The UCC5 160mm chamber base is fully compatible with 150mm Quantum pipe. This is achieved by removing the snap cap and seal from the chamber base and inserting Quantum pipe into the socket, with the seal located into the first corrugation of pipe.

450mm inspection chambers are designed to withstand water testing in accordance with BS EN 1610.

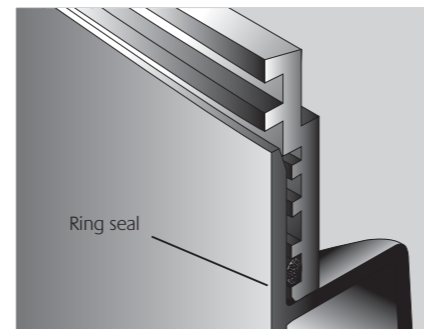

110mm (UCC3) / 160mm (UCC5)

450mm deep inspection chambers

For inspection chamber more than 1m depth (from cover to invert of pipe), safe egress cannot be achieved. To prevent unauthorised access, a recommended maximum clear opening size is 300mm x 300mm rectangular (350mm circular). Inspection and maintenance should be carried out by remotely operated equipment and the maximum depth is limited to 4m. Access is only permitted when there is no other alternative.

For full details please refer to the Building Regulations (England & Wales) Approved Document H – Drainage & Waste Disposal – April 2002 or Part 3 of the Building (Scotland) Regulations 2004 BSEN 752.

Please note that the standard UCC3 chamber base and UCR2 riser are not suitable for deep inspection applications.

Featuring increased ring stiffness over our standard inspection chamber riser, the UCR3 deep inspection riser must be used for all deep inspection applications.

Identifiable by tabs marked 'Deep Inspection' on the inside, each riser is 480mm high (effective height 440mm) and is supplied with a 450mm ring seal.

The UCR3 must be used in conjunction with the UCC5 or UCC450 inspection chambers for deep inspection.

The reduced access ring (UCLRR2) fits into the UCL35PP and UCL125 lid respectively and creates the required restricted opening for non-man entry.

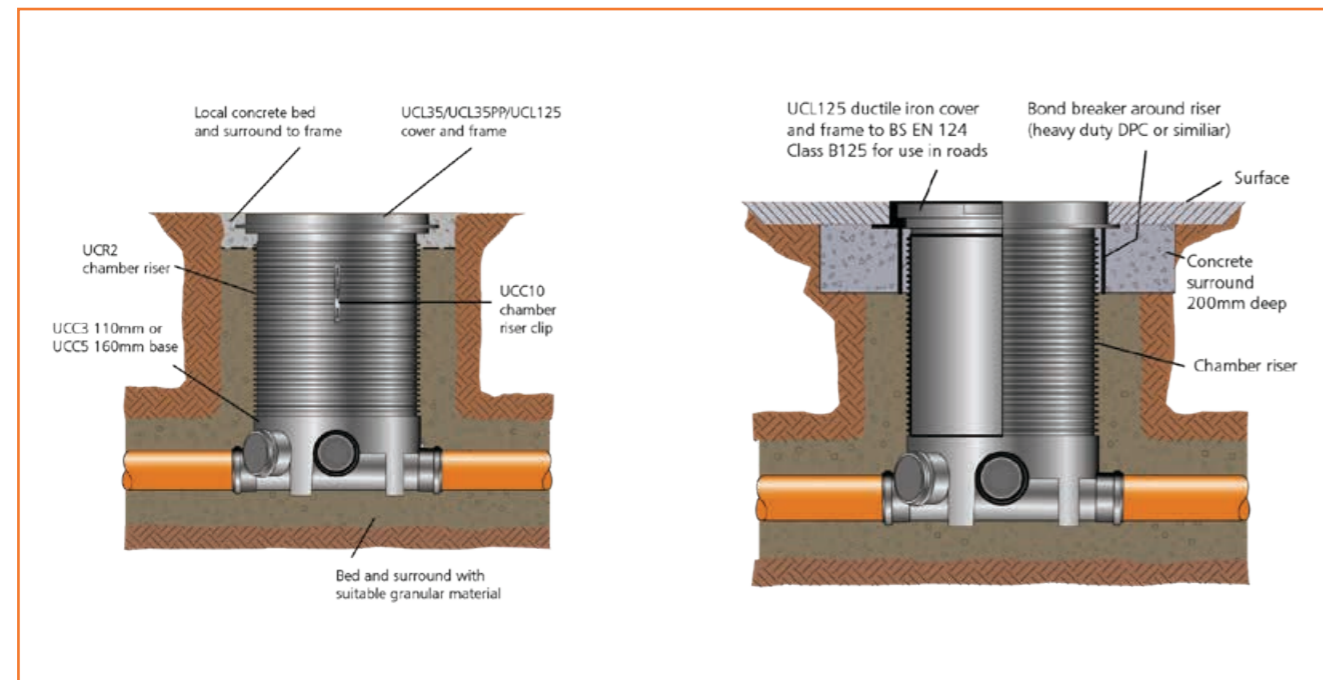

Inspection Chamber product selector

Product	Inlet Size (mm)	Nominal Base Dia (mm)	Non SfA max invert level (m)	SfA type	SfA max invert level (m)	Kitemark approval
UAC02	110	250	0.6	X	X	X
UAC44	110	250	0.6	X	X	X
UCC7	110	250	0.6	X	X	X
UCC3	110	450	1	X	X	X
UCC250	110	250	2*	4	2	✔
UCC315	110	315	2*	4	2	✔
UCC450	110	450	4* †	3	3 †	✔
UCC5	110/160	450	4* †	3	3 †	✔

*Refer to local authority regulations for maximum allowable installation depth
 † 450mm inspection chambers require a 350mm reduced access when exceeding 1.0m in depth

Note: Kitemarked product performance:
 Max allowable groundwater depth above Invert (H) = 3m
 Max installation depth = 5m

Adoptable inspection chambers

Where adoptable inspection chamber systems are applicable

Sewers for Adoption is applicable where a drain or sewer serves two or more properties and flows to the public sewerage network.

The Water & Sewerage company responsible for this network will require the contractor to have used adoptable inspection chambers to comply with sewers for adoption and Building Regulations.

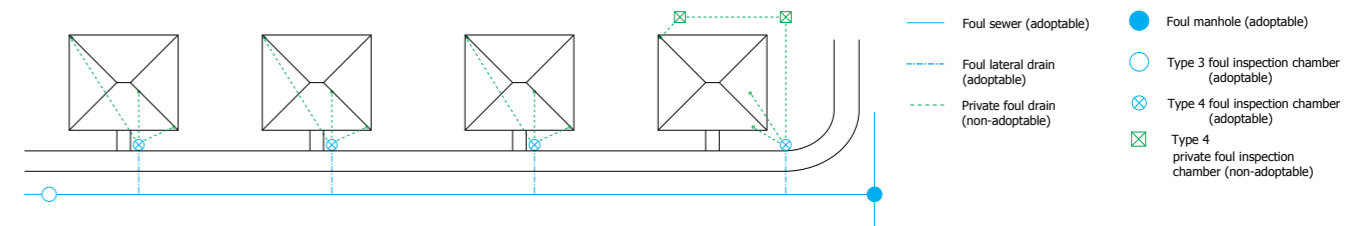

Typical 250mm inspection chamber detail (Type 4)

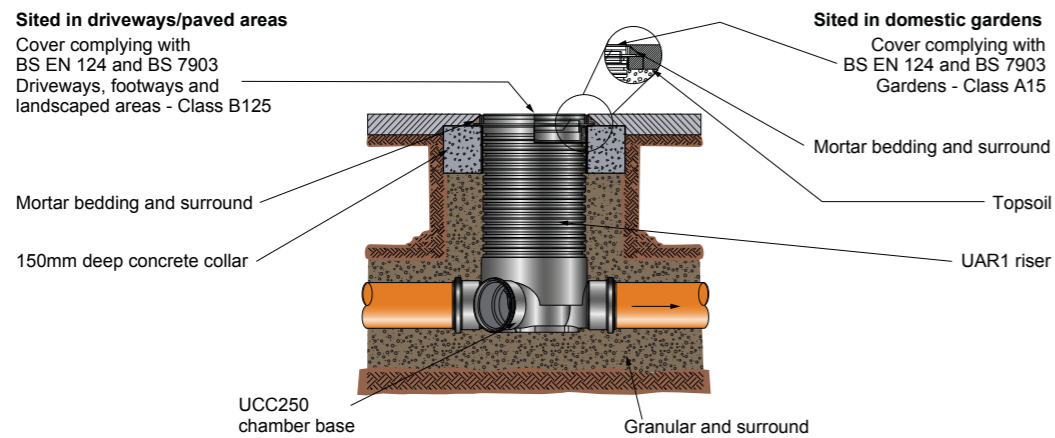

Typical 315mm inspection chamber detail (Type 4)

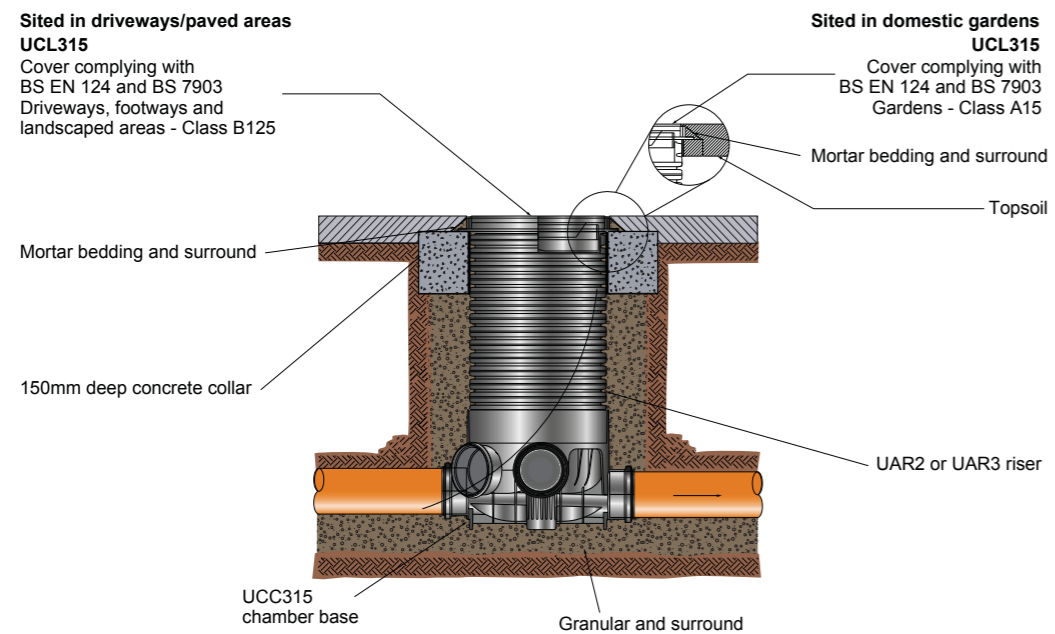

Typical 450mm inspection chamber detail (Type 3)

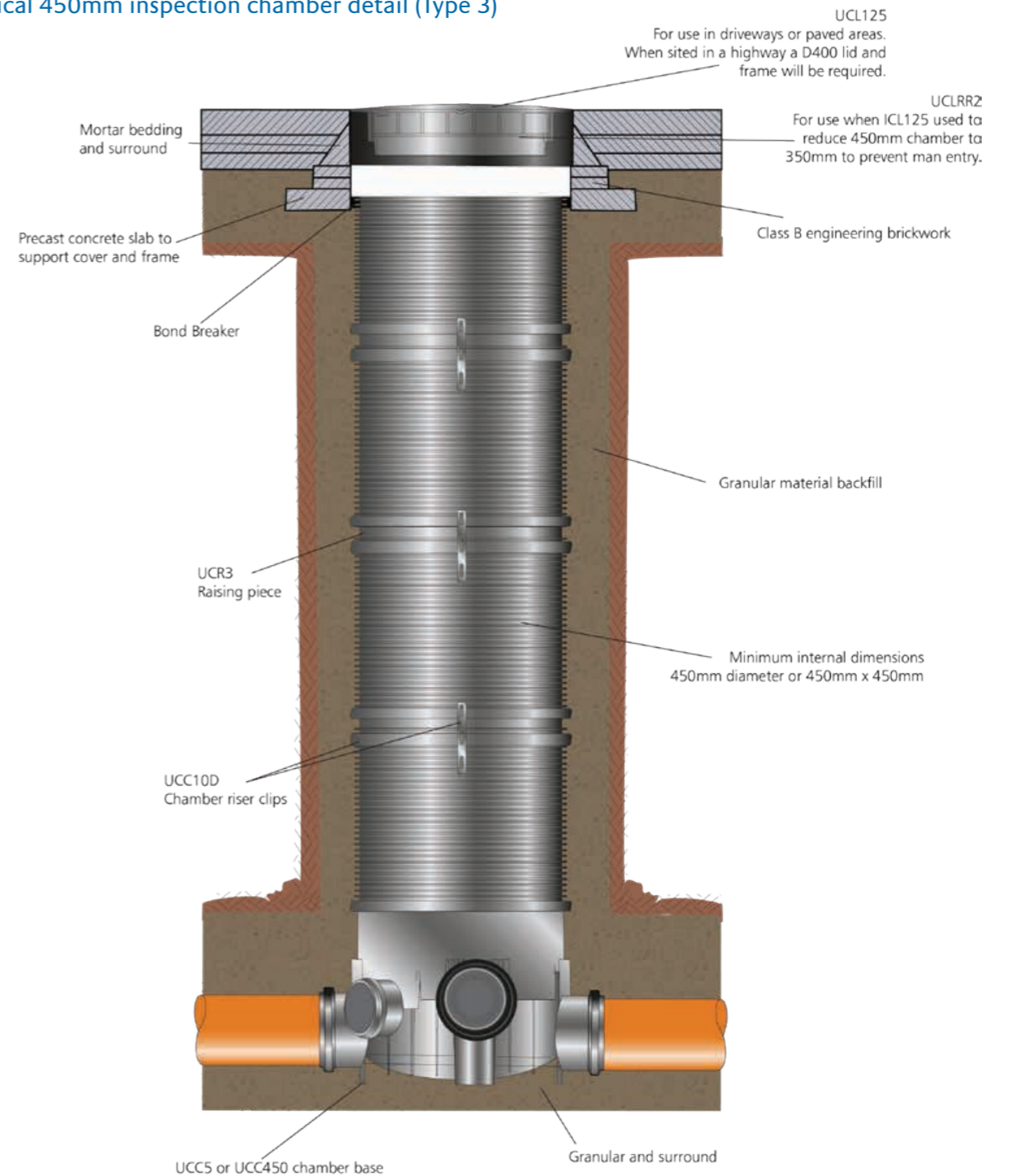

Open channel manholes

250mm inspection chambers provide an alternative to traditionally constructed manholes for invert depths of up to 600mm and 1200mm respectively. However, at greater invert depths there will be a need to construct manholes using brick or precast concrete sections.

For this reason a range of PVCu open channel pipes and fittings have been designed specifically for building into brick or concrete manholes. Each component is designed to provide a good key for sand and cement benching.

Where PVCu straight channel pipes and fittings are used, these should be bedded in cement mortar on a suitably prepared concrete base. Side branches should connect to the main channel using slipper bends trimmed to the required angle of entry, which must be less than 90° and positioned to ensure a smooth discharge into the main drain.

Concrete infill and benching should rise vertically from the top edge of the channel to a height not less than the soffit of the outlet, and be sloped upwards to the wall of the manhole at a gradient of approximately 1 in 12. The surface should be floated to a smooth, hard finish with 1:2 cement mortar, laid monolithic with the benching and rounded off to a 25mm radius.

Where a 90° change of direction is required within an open channel manhole the 110mm long radius channel bend UCB48L may be used.

Adoptable manholes

For adoptable sewer applications manhole details should be used in accordance with the 'Sewers for Adoption Manual' and any additional requirements specified by the relevant Adopting Authority.

All changes in direction between incoming and outgoing sewers should be accommodated within the manhole chamber as no external bends are permitted.

Typical manhole chamber sizes for sewers between 150mm and 300mm diameter are as follows:

Depth to Pipe Soffit	Chamber Size
Less than 1m or 900 x 675mm	1050 diameter
1m to 1.35m or 1240 x 675mm	1350 diameter
1.35m to 6.0m	1200 diameter

External backdrops may be used where appropriate but are subject to approval. A typical construction detail is shown opposite.

Certain Adopting Authorities now allow the use of pre-formed chamber bases built into traditional manholes as shown opposite, providing that the directions of the sewers suit the angles of the inlets and outlet. However, prior approval of the Adopting

Manhole with open channel and slipper bend

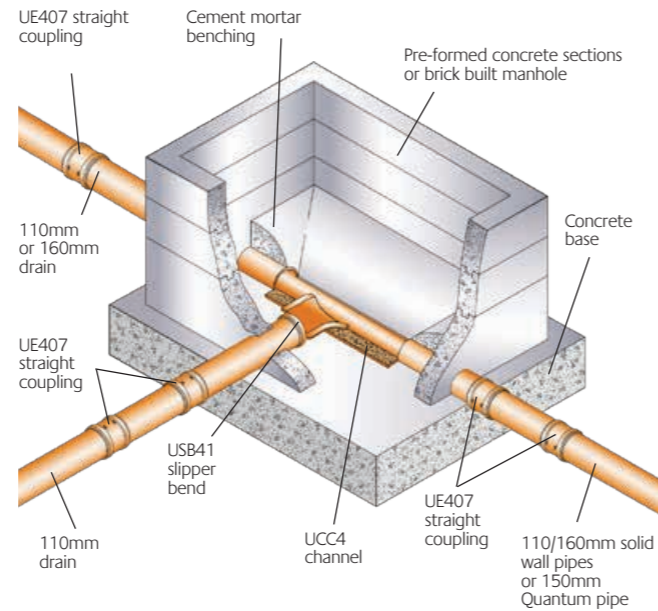

Authority must be sought before utilising pre-formed chamber bases on adoptable sewer systems.

It is recommended that ring seal couplings are located as close as possible to entry and exit points of manholes to create 'rocker pipes' to accommodate any differential settlement that may occur following the backfilling operation.

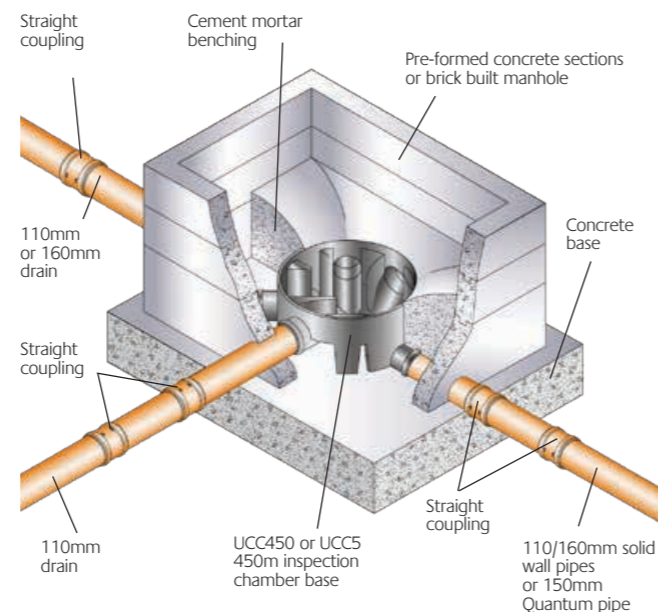

Typical Quantum sewer backdrop assembly

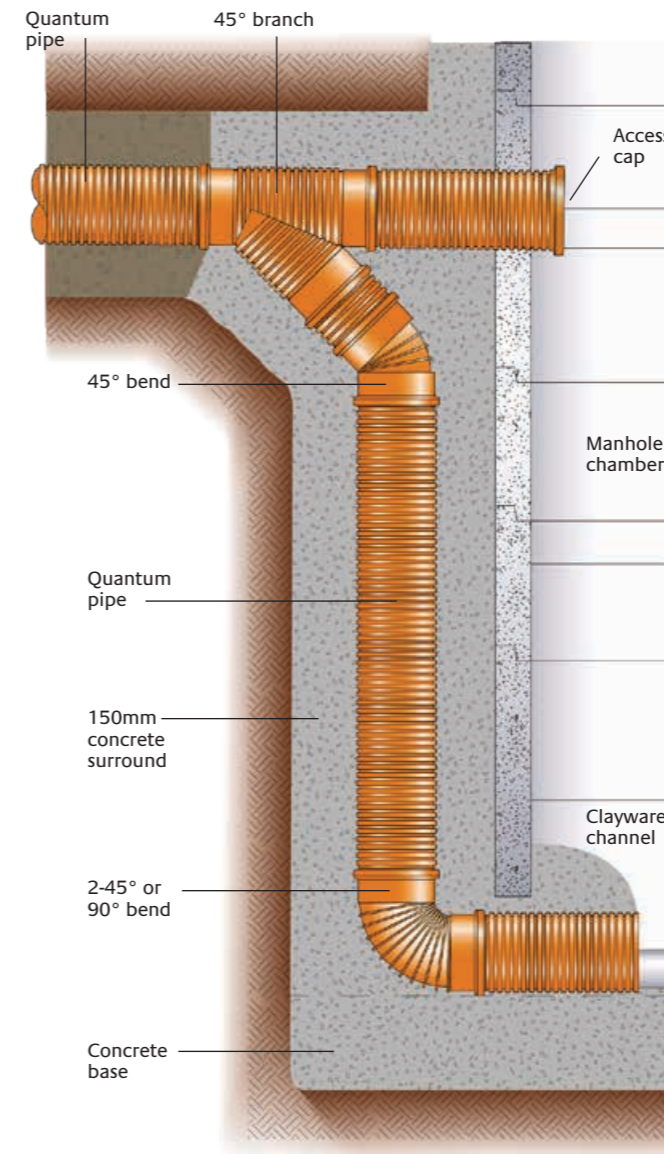

Typical Quantum sewer manhole connection

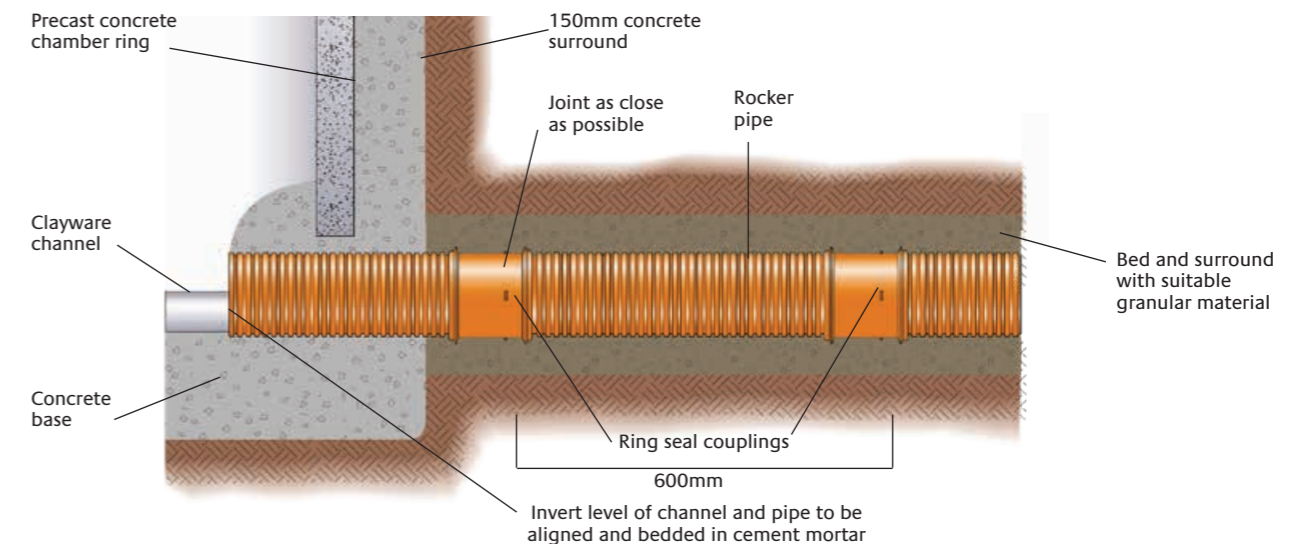

Gully combinations

A comprehensive range of gully components are available, allowing a wide variety of gully combinations to be assembled on site to accommodate different applications.

Square or rectangular gully hoppers

The square or rectangular gully hoppers UG47/UG48 and the gully inlet raising piece UW401 all have connections for small diameter pipework above the trap water level but below the gully grating.

Waste pipes can be connected using standard Marley universal boss adaptors, as illustrated.

The larger diameter upstands on the square or rectangular gully hoppers are designed to provide a solvent socket connection for 68mm circular rainwater pipes.

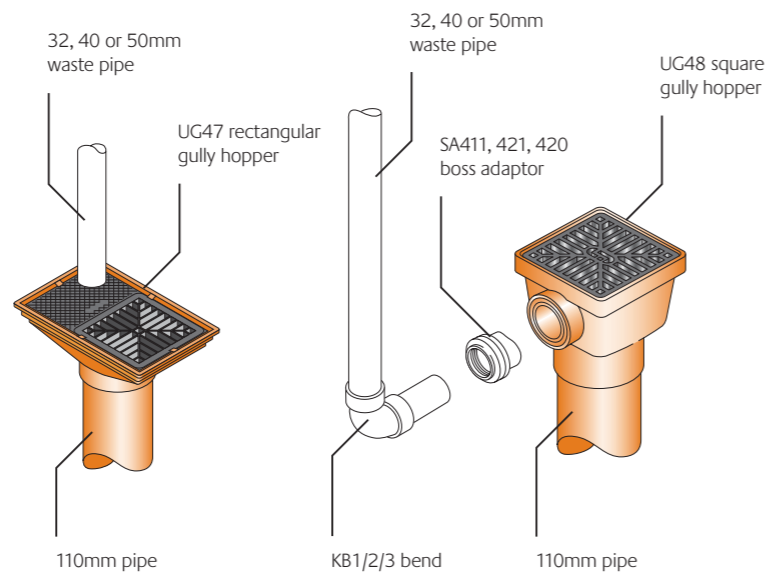

P trap gully

The double socket design of the UG42 P Trap Gully makes it ideal for use in restricted spaces and allows the trap to be orientated to suit the direction of the outlet pipe.

Both the square UG48 and rectangular UG47 hoppers can be connected to the gully using a short length of 110mm pipe cut to suit ground level.

The UG45 gully grating can also be used with the UW401 raising piece to receive waste pipe connections below ground level.

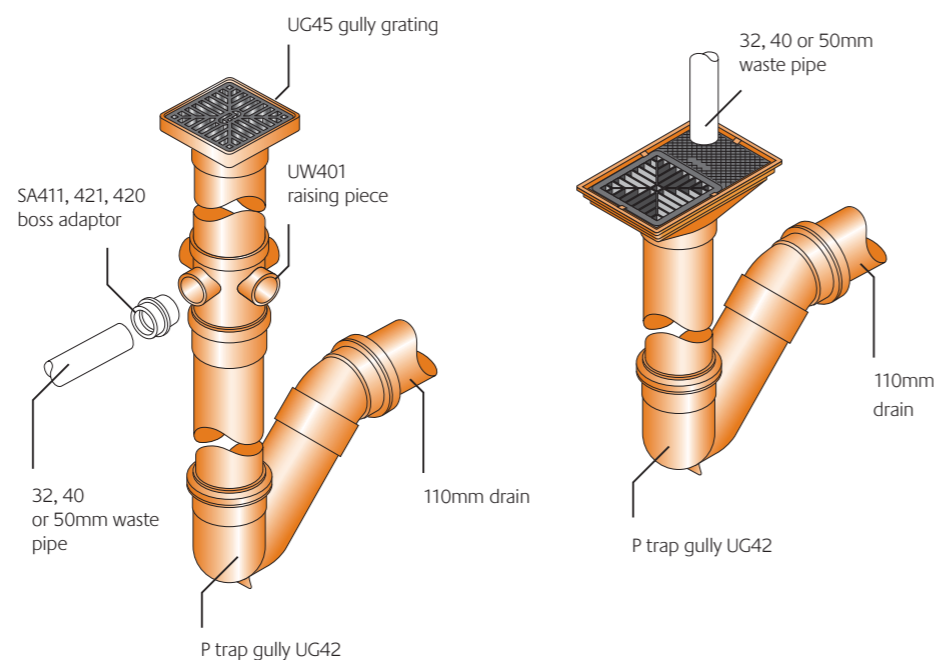

Bottle gully

The UG50 bottle gully is ideal for new or replacement installations and it provides the facility for direct 110mm connections and waste pipe connections via boss adaptors.

The fully rotating gully body allows the outlet to be orientated to suit the drain connection. A removable rubber plug provides access for cleaning.

The gully raising piece UG52 allows the gully to be installed at depths up to 520mm.

Installation procedure for bottle gully

1. Cut raising piece to required length by saw
2. Lubricate and push fit raising piece into top of gully body.
3. Gully frame spigot can then be solvent welded into top of raising piece. The gully grating may be secured to the frame if necessary with two 6 x 13mm self tapping pan head corrosion resistant screws (not supplied).

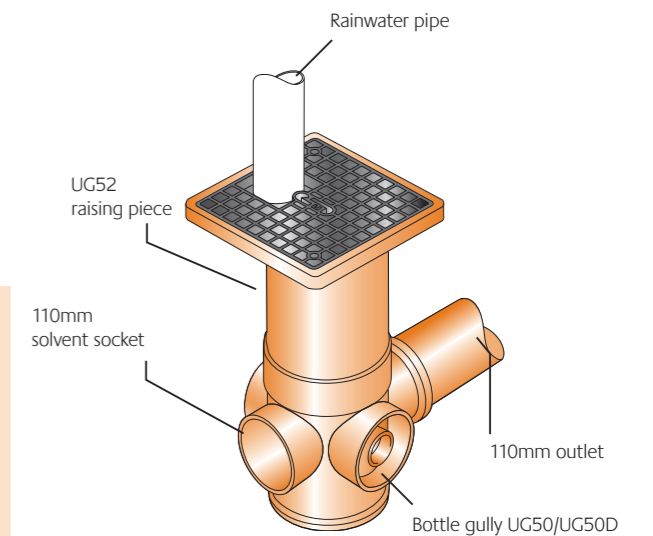

Highway road gullies

The Marley Gully Pot Liners UMA43 & UMA49 meet the requirements set out in DTP 'Specification For Highway Works' for use as permanent shuttering when forming an in situ concrete gully.

For DTP applications gully construction details to be in accordance with DTP 'Highway Construction Details' Drawing No. F13.

A standard UR61T seal and seal cap SNC6 are provided with each gully pot liner. These are to be fitted to a Quantum coupling or bend to enable a direct push fit connection to be made to the gully pot spigot outlet.

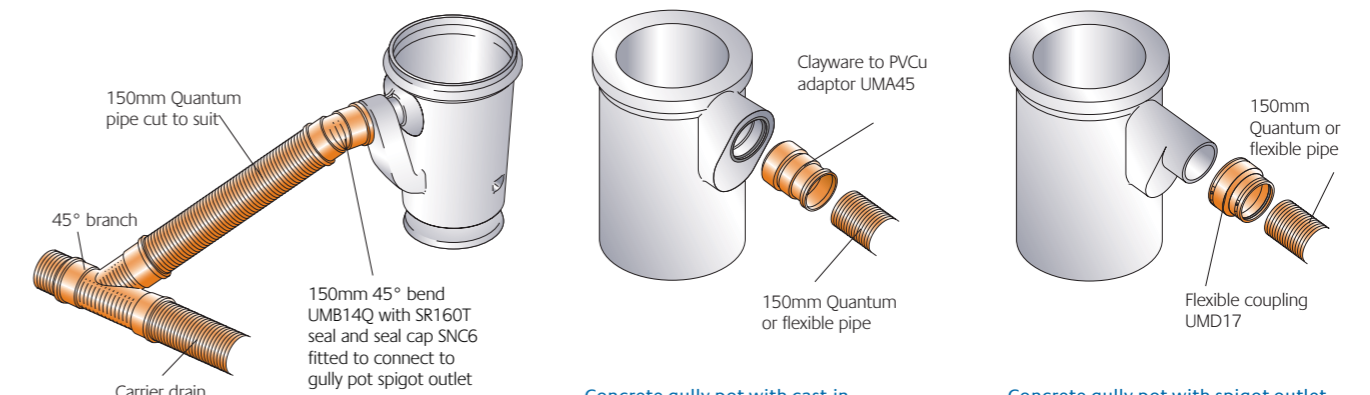
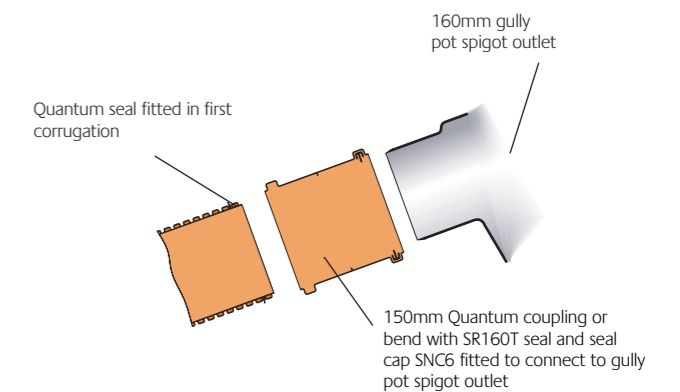

Concrete gully pot with cast-in polypropylene socket for clayware pipes

Concrete gully pot with spigot outlet

Transition to other systems

Marley offer a range of adaptors which allow connections from soil or rainwater to drain, making the process quick and straightforward.

Stub waste connections

Isolated ground floor sanitary appliances are frequently supplied with their own 110mm drain in the form of an oversized and unventilated branch.

There are two methods of connecting waste pipework direct to drain. The SRM402 reducer may be used and solvent welded onto a plain spigot-upstand of pipe.

With the SE41 reducer a flexible connection is provided at floor level as this fitting push fits into a ring seal socket. Standard Marley boss adaptors are used with both types of reducer.

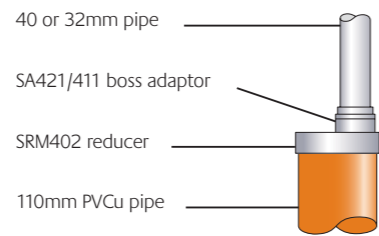

110mm PVCu to 40 or 32mm pipe

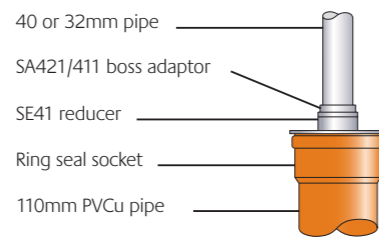

110mm PVCu to 40 or 32mm pipe

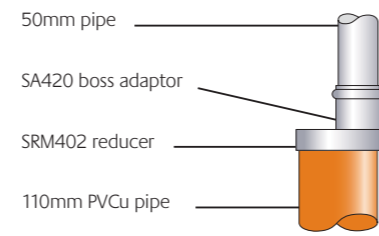

110mm PVCu to 50mm pipe

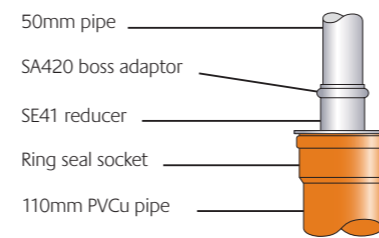

110mm PVCu to 50mm pipe

Rainwater pipe connections

External rainwater pipes usually connect direct to the drain or, depending on the design of the sewerage system, via a gully trap.

Where rainwater pipes connect directly to a drain and are of different sizes, a suitable reducer and adaptor fitting will be required.

The diameter of 110mm PVCu solid wall above and below ground drainage systems are the same and therefore direct connection may be achieved without an adaptor.

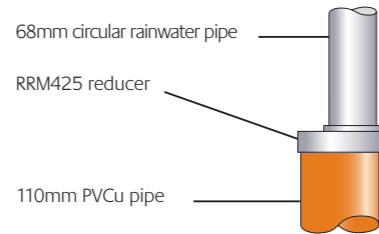

110mm PVCu to 68mm circular rainwater pipe

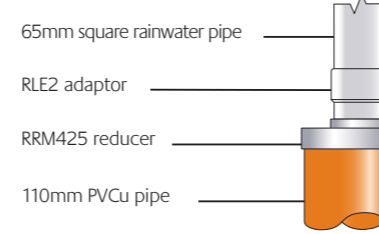

110mm PVCu to 65mm square rainwater pipe

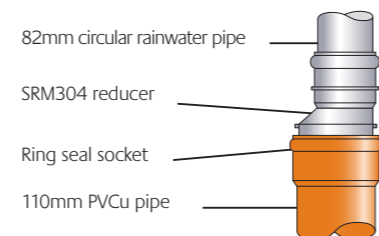

110mm PVCu to 82mm circular rainwater pipe

Connections to other materials

Marley also offer a range of adaptors allowing connections to be made to other materials, including clay. This allows for the replacement of existing sections of the pipe or simply to connect a new system to an existing one.

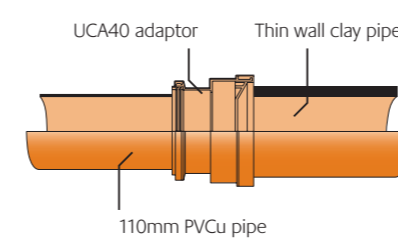

PVCu pipe socket to thin wall clayware socket

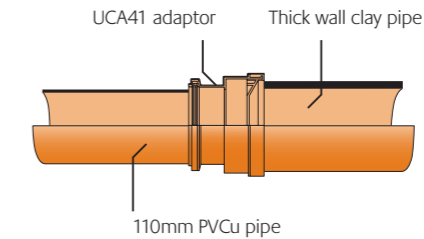

PVCu pipe socket to thick wall clayware socket

The UMA45 adaptor can be used to connect 160mm solid wall drainage pipes to BS EN 1401 to 150mm diameter nominal size clayware pipes as shown on page 45.

Cutting and jointing Quantum pipes

Quantum pipes may be easily cut to length on site if required using a fine tooth saw. Saw cuts should be made square to the pipe midway between the corrugations. It is not necessary to chamfer the end of the pipe after cutting.

Unlike joints on standard solid wall pipe, where the ring seal is located in a housing within the socket, with Quantum pipe the ring seal is fitted around the pipe.

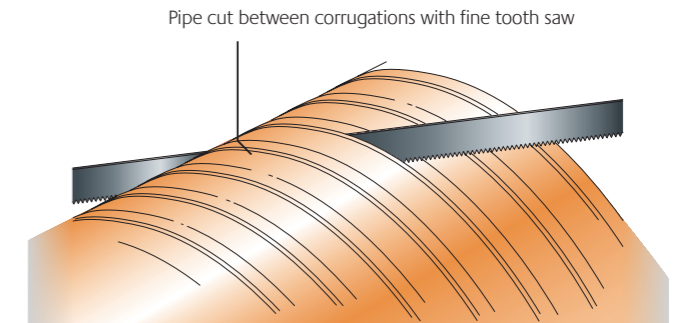

The procedure for jointing is as follows:

1. Ensure that the end of the pipe and inside the socket are free from swarf, grit, etc.
2. Fit seal into the first corrugation of the pipe making sure that the seal is correctly handed, as shown right, and that it is not twisted.
3. Apply lubricant around the pipe seal and inside the socket.
4. Push pipe fully into the socket either by hand or by using a timber block and lever on the other end of the pipe.

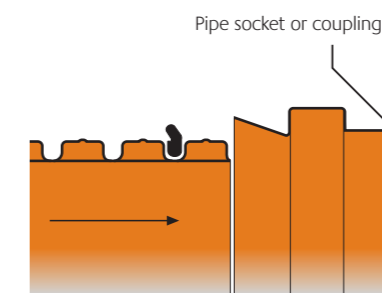

Quantum seal fitted in first corrugation of pipe and handed as shown

Flexible couplings

The range of flexible couplings allow connections to be made between Quantum pipes and pipes of other materials.

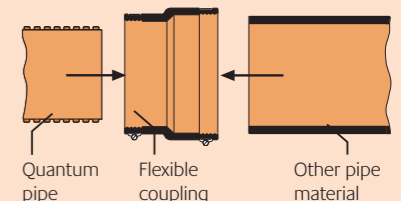

Quantum couplings, bends, branches and reducers have an all socket configuration and jointing these to Quantum pipe is achieved in the same way as described above.

Flexible Couplings

Pipe	Flexible Coupling	Other Pipe Material
150mm Quantum (160mm outside diameter)	UMD17	150mm clayware
		150mm concrete
		150mm PVCu twin wall
		150mm outlet plastic
		Gully pot liners
		Maximum outside diameter of pipe – 200mm
225mm Quantum (250mm outside diameter)	UMD27	225mm clayware
		225mm concrete
		250mm ductile iron
		250mm PVCu pipes to BS 5481
		Maximum outside diameter of pipe – 290mm
		Minimum outside diameter of pipe – 265mm
300mm Quantum (330mm outside diameter)	UMD37	300mm clayware
		300mm concrete
		315mm PVCu pipes to BS 5481
		Maximum outside diameter of pipe – 385mm

Connection to 110mm solid wall drainage pipes

Connection between 150mm Quantum and 110mm solid wall pipe can be achieved by fitting a snap cap SNC6 and seal SR160T to the end of the socket. A connection can then be made to a reducer URM604 as shown right.

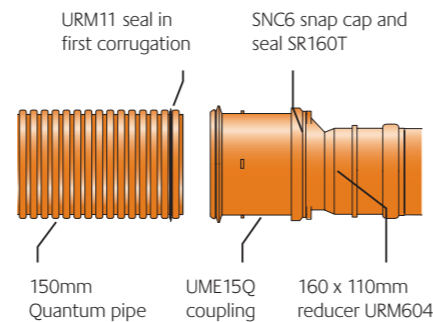

Connection to 160mm solid wall pipe

All 150mm Quantum sockets have been designed for use with Quantum pipes and 160mm solid wall pipes to BS EN 1401. To adapt a Quantum fitting to accept 160mm solid wall drainage pipe, a snap cap SNC6 and seal SP160T must be fitted to the end of the socket to enable a connection to be made, as shown right.

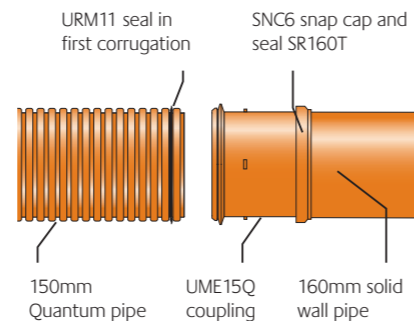

Quantum to thick wall clayware

The UMA45 adaptor may be used to connect 150mm Quantum pipe to Densleeve or Hepsleeve 188mm outside diameter clayware pipe.

The adaptor is designed to allow Quantum pipe to be jointed with clayware pipe using a standard clayware pipe coupler.

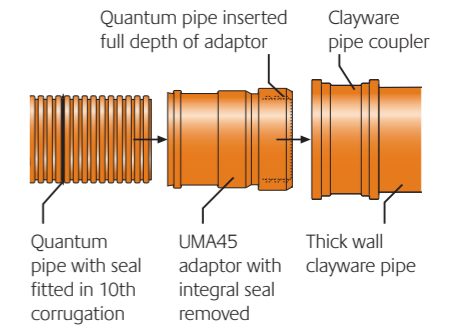

Installation procedure

1. Remove factory fitted 'T' seal from adaptor socket.
2. Fit Quantum seal on the pipe in the 10th corrugation from the end of the pipe ensuring the seal is correctly handed.
3. Lubricate the seal and inside the socket of the adaptor. Push the adaptor over the pipe, ensuring the pipe passes completely through the adaptor until the end of the pipe aligns with the end of the adaptor.
4. Lubricate the adaptor spigot and push into the clayware pipe coupler up to the central register.

Quantum to thin wall clayware

The same adaptor can also be used to connect 150mm Quantum pipe to Hepsleeve or Supersleeve 178mm outside diameter clayware pipe. For this application the end spigot of the adaptor is first removed using a fine tooth saw. The remaining section of the adaptor is then suitable for connecting directly into a standard polypropylene clayware pipe coupler as shown right.

The installation sequence for this application is similar to that previously described but the seal is fitted on the Quantum pipe in the 6th corrugation from the end of the pipe to take into account the shortened length of the adaptor.

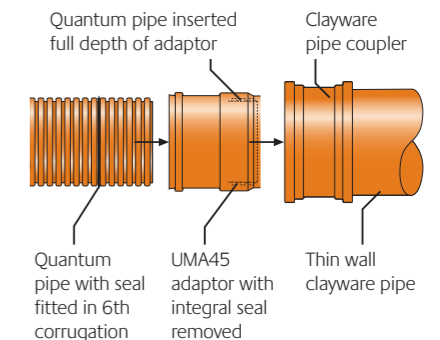

Solid wall PVCu pipe to clayware

The UMA45 adaptor can also be used as supplied to connect 160mm solid wall PVCu pipe to clayware drainage, as shown right.

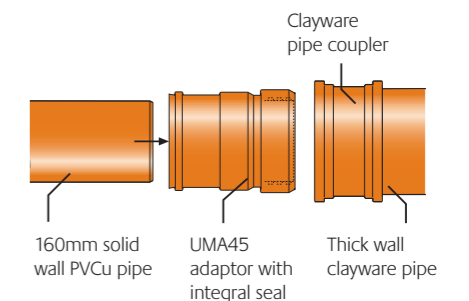

Future connections

If a drainage system is likely to be extended in the future, branches at appropriate locations should be installed with the branch pipes blanked off with socket plugs. However, should it be required to install a new branch connection into an existing drain the following procedure should be adopted:

1. Materials required:-
 - Branch fitting of appropriate size.
 - Two short lengths of pipe (minimum length 300mm).
 - Quantum pipe seals.
 - Two slip couplings.
2. Fit the two short lengths of pipe into the branch fitting using the standard jointing procedure shown on page 44. Mark ends of pipe at half a coupling depth.
3. Use this assembly to mark the length of existing pipe to be removed and then cut out the section of pipe.
4. Ensure the ends of the existing pipe are free from dirt, swarf, etc.
 - Lubricate two slip couplings and slide fully over the ends of the existing pipe past the first corrugation.
5. Fit Quantum pipe seals to the first corrugation of each pipe end with the seals handed as illustrated to allow the couplings to slide back over the seals.
6. Lubricate all pipe seals and place branch assembly into position with branch pipe in desired plane.
7. Slide couplings back over joints using marks to ensure couplings are centralised on joints.

The above method of constructing a new connection to an existing drain meets the requirements of BS EN 1610: 2015 Clause 9-2.

A Quantum branch fitting can be installed into an existing concrete or clayware drain by following a similar procedure as described above but utilising appropriate flexible coupling in place of the slip couplings.

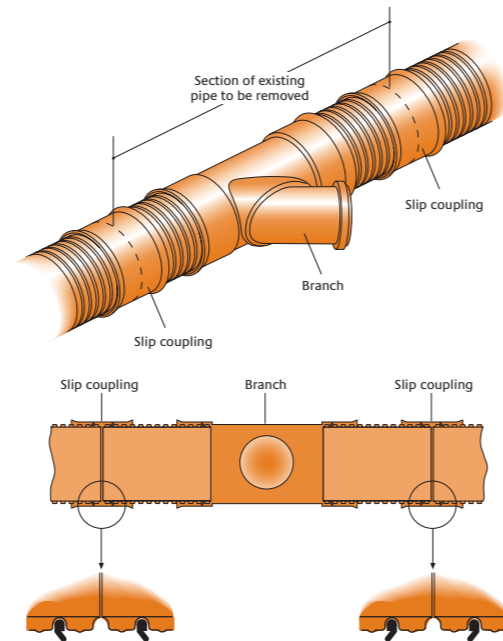

Pipe seals to be handed as shown to allow couplings to slide back over joint

Testing drainage systems

Air or water testing of systems should be carried out as required by the particular approving Authority. Reference should be made to the following documents for guidance:

Building Regulations Part H-Clause 2.26.
BS EN 1610: 2015 Sections 12 and 13.

It is recommended that air test method LA is adopted. However the standard water test can also be used.

Due to the non-absorbent nature of plastic materials the one hour conditioning period is not necessary prior to commencing a water test.

Rodding equipment

Marley underground drainage systems may be rodded using continuous flexible rods, sectional polypropylene rods or other similar flexible systems. Rodding heads should incorporate a guide roller, and rigid couplings between sectional rods should not exceed 100mm in length.

Pointed or boring type metal fittings are not recommended. Mechanical rodding techniques may be used with the exception of rotating toothed root cutters. These devices were primarily designed for use on traditional pipe materials where joint failure has occurred and allowed the ingress of roots. The incidence of PVCu ring seal joints failing in this way is extremely rare.

Water jetting PVCu drains and sewers

High pressure water jetting is now used extensively and is a recommended technique for the general cleaning, de-scaling and removal of blockages from both Marley solid wall pipes and Quantum drainage systems.

The Code of Practice for Sewer Jetting published by The Water Research Centre contains detailed guidance on the use of this type of equipment for drain and sewer maintenance. Adherence to the recommendations contained in this document is strongly advised when jetting all pipe materials.

The Code of Practice recommends for all house drainage systems and sewers where exact details of the condition, age and pipe material cannot be verified that a jetting pressure of 130 bar (1900 psi) is not exceeded.

Independent jetting trials for blockage clearance in PVCu pipes have conclusively demonstrated that the improved hydraulic performance and smoother internal bore allows most types of blockages to be removed using standard rear facing jet nozzles at jetting pressures well below the maximum recommended in the Code.

The Code of Practice recommends for all pipe materials that static jetting above 1900 psi is used only following confirmation that the pipeline being jetted is in good structural condition. Where up to date and accurate records of the condition of the sewer are unavailable a CCTV survey may be required prior to jetting above 1900 psi.

The Code of Practice recommends a maximum jetting pressure of 180 bar (2600 psi) for PVCu pipes, when using a standard jet head.

Where the distance from the access point to the blockage exceeds the travel capability of the standard jet head running at 180 bar (2600 psi) the use of a low impact jet head will allow higher pressures (thus great running distance) to be achieved without increased risk of pipe damage.

The jet head manufacturer's recommendations for maximum operating pressures should be observed when using these types of jet head.

Safety

Safety

The relevant regulations as outlined in the Health and Safety at Work Act 1974 should be followed. Also follow the recommendations contained in the booklet 'Safe Working in Sewers and Sewerage Works' published by the National Joint Health and Safety Committee for Water Services.

Transportation and handling

PVCu pipes and fittings are strong and lightweight and therefore very easily handled, however, reasonable care should be exercised. During transportation loose pipes should preferably be loaded and unloaded by hand but if mechanical equipment is utilised, web or rope slings are recommended.

Larger quantities of pipes are delivered in secure bundles within timber frames and wherever possible the pipes should remain within this packaging until required for installation. It is recommended that pipe bundles are unloaded by forklift or by using web or rope slings.

Fittings are generally packed in cardboard boxes, plastic bags or in shrink-wrapped form.

Storage of loose pipes on site

Pipe bundles may be stacked up to three high on firm level ground ensuring that the frames are placed 'wood to wood' to avoid damaging the pipes. Pipes should not be removed from any position within stacked bundles. Before removing pipes the bundles should be placed at ground level and provision made to retain the frames in an upright position as pipes are removed. Although Marley Quantum pipes have a corrugated external profile their unique design allows them to be easily slid out without the corrugations interlocking.

Pipes which have been delivered loose or have been removed from pre-packed bundles should be stored on a reasonably flat, level surface on timber battens not less than 75mm wide spaced at a maximum of 1m centres. Side support should also be provided at intervals not exceeding 1.5m.

Pipes of different sizes should preferably be stacked separately but where this is not possible larger diameter pipes should be placed at the bottom. Spigot and socket pipes should be stacked with sockets at alternate ends protruding to ensure pipes are evenly supported over their length.

Pipes stored in the open for long periods or exposed to strong sunlight should be covered with an opaque sheet (not black).

Fittings supplied in cardboard boxes or polythene bags should be stored in a cool place out of direct sunlight and away from any heat source.

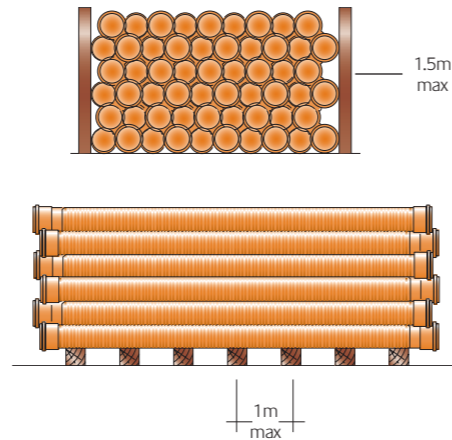

Solid wall pipes

Size	Pipes per Bundle
110mm	100
160mm	46

Quantum sewer & highway drainage pipes

Size	Pipes per Bundle
150mm	46
225mm	16
300mm	9

FLOWLOC VORTEX FLOW CONTROL UNIT

Flowloc controls the rate at which water is discharged to a surface water drain or watercourse. The design of Flowloc is based on the proven vortex principle, and enables a near constant discharge rate to be achieved, independent of the head of water in the tank.

- Accommodates flow rates ranging from 2 l/s to 15 l/s,
- Installed in a chamber base with a withdrawal handle to allow easy access from the surface for maintenance.
- Suitable for use with tank depths up to 4m.
- The chamber base is also suitable for installation within a conventional man entry inspection chamber if required.



For more information visit marleypd.com



British Standards

A wide range of components featured in this price list conform to British Standard Specifications, many items bear the British Standards Institution's Kite Mark symbol, , as indicated throughout this price list. The presence of this mark on, or in relation to, a product is an assurance that the goods have been produced under a system of supervision, control and testing, operated during manufacture and including periodical inspection of the manufacturer's works in accordance with the Certification Mark Scheme.

Agrément Certificates

Certain components and systems illustrated in this price list have been independently assessed and are the subject of certification by the British Board of Agrément. These items are indicated by the BBA symbol, , throughout this price list.

Copies of Marley Plumbing & Drainage BBA Certificates are freely available from the Company upon request or from marleypd.co.uk.

British & European Standards

BS 4660 & BS EN 1401

Thermoplastics ancillary fittings of nominal sizes 110 and 160 for below ground gravity drainage and sewerage.

BS 4962

Specification for plastic pipes and fittings for use as subsoil field drains.

BS EN 14680

Adhesives for non-pressure thermoplastic pipe systems.

BS EN 13598-2

Plastic piping systems for non-pressure underground drainage and sewerage – Unplasticized poly(vinyl chloride) (PVCU), polypropylene (PP) and polyethylene (PE) Part 2: Specifications for manholes and inspection chambers

BS EN 124

Gully tops and manhole tops for vehicular and pedestrian areas. Design requirements, type testing, marking, quality control.

BS EN 295

Vitrified clay pipes & fittings and pipe joints for drains and sewers.

BS EN 681-1

Elastomeric seals. Material requirements for pipe joint seals used in water and drainage applications.

BS EN 752

Drain & Sewer Systems outside buildings.

BS EN 1295-1

Structural design of buried pipelines under various conditions of loading. General requirements.

BS EN 1610

Construction & Testing of Drains & Sewers.

BS EN 13476-3

Plastics piping systems for non-pressure drainage and sewerage, structured wall piping systems with smooth bore and profiled external surface.

BS EN ISO 9001: 2008

Quality management systems.

BS EN ISO 14001: 2004

Environmental management systems requirements with guidance for use.

BBA 11/H172

Quantum Highway Drainage System. 375-600mm pipes and couplings.

BBA 88/1977

Marley Underground Drainage System.

BBA 09/H146

Quantum Highway PVCu Twinwall Drainage System.

BBA 94/2985

Marley Quantum Sewer PVCu Twinwall Underground Drainage and Sewerage System.

BBA 98/3486

Marley Quantum Highway PVCu Twinwall Surface Water Drainage System.

WIS 4-08-01

Bedding and sidefill materials for buried pipelines.



PVCu push-fit and solvent weld systems, ideal for domestic and commercial applications. Innovative fittings include the 8-way collar boss with top and side entries which allow for multiple inlet connections.



Certified to BS EN 1519, the Marley HDPE system offers an alternative solution to cast iron. The combination of the excellent material properties of HDPE with homogenous welded joints provide greater installation flexibility with a range of jointing options.



Used in conjunction with the acoustic pipe brackets, Marley dBlue is designed to reduce noise and acoustic vibrations to a level of 16dB at 4/s, making it perfect for multi-occupancy developments.



The Marley rainwater range comprises advanced Life4 technology, textured Foundry Finish, and profiles up to heavy industrial to make it the most comprehensive available.



Solid wall for round the house drainage with a range of adoptable inspection chambers. Quantum structured wall with smooth bore for good hydraulic performance in sewer and highway drainage applications.



Studor P.A.P.A. (Positive Air Pressure Attenuator) and Studor air admittance valves provide a complete active drainage ventilation system solution which is particularly suited to high-rise applications.



Multikwik sanitary frames and concealed cisterns deliver behind the wall reliability for wall hung toilets and basins. Glass, metal and plastic flush plates offer client choice for modern bathroom designs.

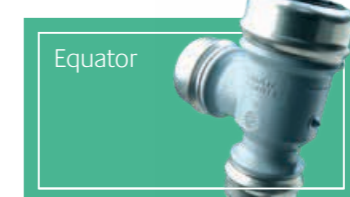

Equator is a hot & cold water system manufactured from cross-linked polyethylene (PE-X) and stainless steel. Fittings are tamperproof, but fully demountable and reusable with the use of the demounting tool.



Flowloc is a Vortex flow control unit, which is used as part of an attenuation scheme. It controls the rate at which water is discharged to a drainage system or watercourse.

Accreditations



Certificate No. 88/1977
94/2985
98/3486
09/H146
11/H172

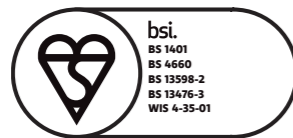

KM 05495
KM 682928
KM 542682
KM 56157



FM 30637 EMS 96207





MARLEY
Plumbing & Drainage Solutions

marleypd.co.uk

For general enquiries and details of your nearest stockist please call the customer services department:

Tel: 01622 852585

Email: customerservice@marleypd.co.uk

To place an order

For delivery to **England & Wales**

Email: orders.lenham@marleypd.co.uk

Fax: 01622 851111

For delivery to **Scotland**

Email: orders.uddingston@marleypd.co.uk

Fax: 01698 810307

For all estimate requests

Email: estimates@marleypd.co.uk

For Technical advice please call

01622 852695

Head Office

Lenham, Maidstone

Kent ME17 2DE

Tel: 01622 858888

Fax: 01622 858725

Email: marketing@marleypd.co.uk

Scotland

Birkenshaw Industrial Estate

Uddingston, Glasgow G71 5PA

Tel: 01698 815231

Fax: 01698 810307

Export Division

Lenham, Maidstone

Kent ME17 2DE England

Tel: +44 (0)1622 858888

Fax: +44 (0)1622 850778

Email: export@marleypd.co.uk

an *OAliaxis* company

AUGUST 2019