

## Terrain Underground



PVC underground drainage systems

# Terrain Underground

Using the latest plastics manufacturing technology to satisfy the requirements of today's installers, the Terrain underground range offers both rigid and foam core pipe and a comprehensive range of fittings to suit all applications. Terrain underground products represent the benchmark for quality, supported with outstanding service levels. Our comprehensive range of underground drainage products are suitable for commercial, industrial, housing and public sector developments.

- Industry leading
- Simple to install
- Flexible, to accommodate normal ground movement
- Adaptable, to connect to existing drainage systems
- Supported through extensive technical experience on all aspects of design and installation
- Fully accredited product system

## Solid wall pipes and fittings

Available in 82, 110 and 160mm diameters.

110 and 160mm comply with BS EN 1401 (BS 4660).

## Foamcore pipe

Manufactured using the latest tri-extrusion techniques to produce a three layer pipe that is 25% lighter than standard PVC-u pipe.

Available in 110 and 160mm diameters. Carries BBA certificate 95/3086.

As you would expect from a market leader our products come with all relevant standards including:

## Manufacturing Standards

EN 1401:1998 Underground Drainage

EN 7158:2001 Plastic Inspection Chambers for Drains and Sewers

## Quality Management Systems Standards

EN ISO 9001:2008 Management System

EN ISO14001:2004 Management System

BS OHSAS 18001:2007 Management System

PASS 99:2006 Integrated Management Registration



Larger pipework and fittings for 315mm diameter are available on request

### Sustainable Materials

Plastics are among the most researched materials in the world and rapid technological and manufacturing developments made in recent years have allowed for continuous innovation.

Polypipe Terrain pioneered the development of PVC material for the manufacturing of drainage pipes and fittings; we remain at the forefront of the industry across the globe and are proud to be pioneering the industry with the development of our LEAD-FREE system.

Utilising a lead-free material composition contributes significantly to an environmentally friendly manufacturing process and gives a finished product that is fully recyclable in accordance with British Standards.

For further information, please refer to [www.polypipe.com](http://www.polypipe.com)

# Contents

## Terrain Underground

Terrain Pipes & Fittings	04 - 09
Terrain Gullies & Hoppers	10 - 11
Terrain Inspection Chambers	12
Accessories	12
Terrain Adaptors	13
Flexicon Couplings & End Caps	14 - 15
System Planning	16 - 24
Further Information	25
UK Basic Design Principles	26 - 27
Sustainable Products and Manufacturing Process	28 - 29
Product Index	30 - 31

## Terrain pipes & fittings

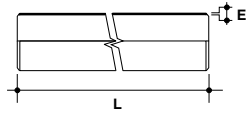

	Size (mm)	L	E (min)	Code
<b>SOLID WALL PIPE PLAIN ENDED</b>				
	82	3m	2.25	3DP3
▽	110	3m	3.2	4DP3
▽	160	3m	4.1	6DP3
	82	5.8m	2.25	3DP58
▽	110	5.8m	3.2	4DP58
▽	160	5.8m	4.1	6DP58

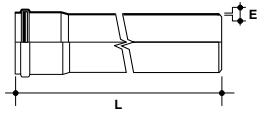

	Size (mm)	L	E (min)	Code
<b>SOLID WALL PIPE SINGLE SOCKET</b>				
▽	110	3m	3.2	4DP3S
▽	110	6m	3.2	4DP6S
▽	160	6m	4.1	6DP6S

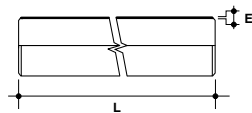

	Size (mm)	L	E (min)	Code
<b>FOAMCORE PIPE PLAIN ENDED</b>				
	110	3m	3.2	4EUP3
	110	5.8m	3.2	4EUP58
	160	5.8m	4.1	6EUP58

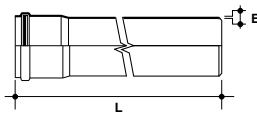

	Size (mm)	L	E (min)	Code
<b>FOAMCORE PIPE SINGLE SOCKET</b>				
	110	3m	3.2	4EUP3S
	110	6m	3.2	4EUP6S
	160	3m	4.1	6EUP3S
	160	6m	4.1	6EUP6S

# Terrain Drainage System

## Terrain pipes & fittings D Range

Size (mm)	L	Z	Code
<b>COUPLER DOUBLE SOCKET - with central stop</b>			
82	136	3.5	3D20D
♥ 110	122	2	4D20D
♥ 160	154	4	6D20D

Size (mm)	L	Code
<b>SLIP COUPLER - for inserting new fittings into existing pipework (e.g. refurbishment or repair)</b>		
♥ 110	122	4D20DSC
♥ 160	154	6D20DSC

Size (mm)	L1	L2	Z	Code
<b>PIPE END SOCKET</b>				
♥ 110	121	48	3	4D69
♥ 160	167	68	3	6D69

Size (mm)	Z	Code
<b>LEVEL INVERT TAPER - larger end spigot and smaller end socket</b>		
♥ 110/82	104	43DT
♥ 160/110	143	64DT

Material: PVC-u

Size (mm)	Angle°	L	Z	Code
<b>SHORT RADIUS BEND DOUBLE SOCKET - to change pipe direction: 87½°, 45°, 30° &amp; 15° as standard</b>				
82	87½	142	70	3D23D
82	45	97	25	3D25D
♥ 110	87½	120	70	4D23D
♥ 110	45	87	37	4D25D
♥ 110	30	83	27	4D27D
♥ 110	15	76	20	4D29D
♥ 160	87½	202	124	6D23D
♥ 160	45	122	49	6D25D

Size (mm)	Angle°	L1	L2	Z1	Z2	Code
<b>SHORT RADIUS BEND SINGLE SOCKET - to change pipe direction: 87½°, 45°, 30° &amp; 15° as standard</b>						
♥ 110	45	85	89	27	39	4D25
♥ 110	30	78	86	17	29	4D27
♥ 110	15	71	79	9	22	4D29
♥ 160	87½	164	166	84	100	6D23
♥ 160	45	117	116	37	50	6D25
♥ 160	30	107	112	25	40	6D27

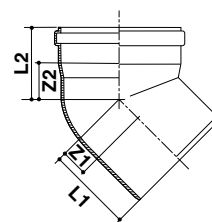
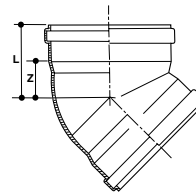
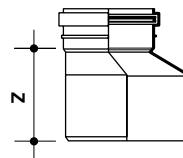
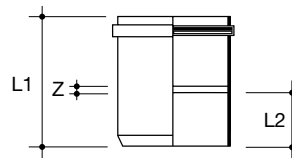
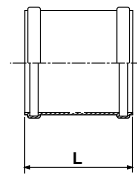
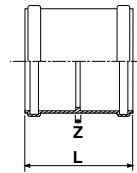

# Pipes & Fittings

## Terrain pipes & fittings D Range

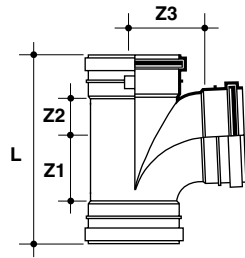

	Size (mm)	Angle°	L	Z1	Z2	Z3	Code
<b>SINGLE EQUAL JUNCTION</b>							
▽	110	87½	268	87	57	87	<b>4D30D</b>
▽	160	87½	338	95	99	99	<b>6D30D</b>
	82	45	265	19	108	102	<b>3D33D</b>
▽	110	45	294	37	137	137	<b>4D33D</b>
▽	160	45	399	52	203	203	<b>6D33D</b>

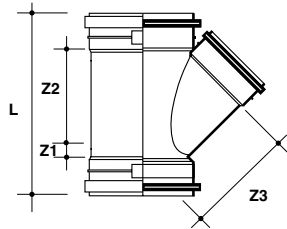

	Size (mm)	Angle°	L	Z1	Z2	Z3	Code
<b>SINGLE UNEQUAL JUNCTION (all sockets)</b> - to join 110mm branch pipe to 160mm main pipe at an angle							
▽	160/110	45	278	27	143	143	<b>64D33D</b>

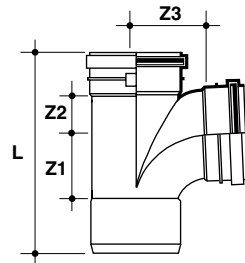

	Size (mm)	Angle°	L	Z1	Z2	Z3	Code
<b>SINGLE EQUAL JUNCTION SPIGOT OUTLET</b> - to join 110 or 160mm branch to 110 or 160mm main pipe at an angle							
▽	110	87½	239	59	69	69	<b>4D30</b>

(110mm) 87½° and 45° as standard. (160mm) 45° as standard.

# Terrain Drainage System

Size (mm)	Angle°	L	R	Z1	Z2	Code
<b>REST BEND SINGLE SOCKET</b> - to change 110mm at base of soil stack: 87½° as standard						
110	87½	230	200	245	170	<b>4D21</b>

Satisfies recommendations of BS 5772: 1994.

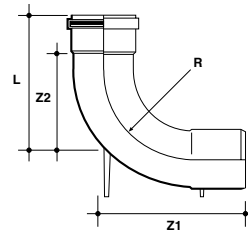

Size (mm)	Angle°	L	R	Z1	Z2	Code
<b>REST BEND DOUBLE SOCKET</b> - to change 110mm at base of soil stack: 87½° as standard						
110	87½	205	200	245	170	<b>4D21D</b>

Satisfies recommendations of BS 5772: 1994.

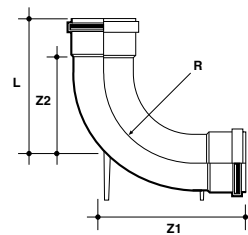

Size (mm)	Angle°	Z1	Z2	Code
<b>VARIABLE BEND SINGLE SOCKET</b> - to change 110mm pipe direction by 0-25°				
110	0-25	86	45	<b>4DV40</b>

Z dimensions are constant whichever angle is selected.  
Any non-standard angle can be achieved if used in conjunction with a standard fitting.

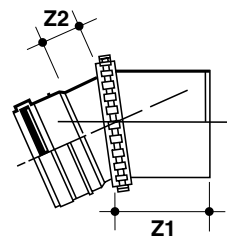

# Pipes & Fittings

## Terrain pipes & fittings

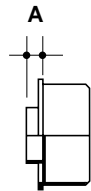

Size (mm)	A	Code
<b>SOCKET PLUG</b> - to blank off any ring seal socket plus allowing a boss connection		
110	18	<b>4D68</b>
160	16	<b>4D68</b>



Size (mm)	A	Code
<b>TEMPORARY SITE CAP</b> - for temporary capping of system		
110	30	<b>4D65</b>

Versions for external and internal use.

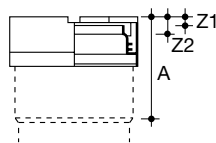

Size (mm)	A	Z1	Z2	Code
<b>ACCESS CAP</b> - Solvent Socket				
110	97	21	46	<b>4D63</b>
160	122	22	42	<b>6D63</b>

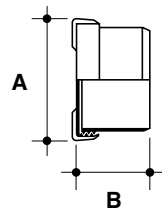

Size (mm)	A	B	Code
<b>ACCESS CAP</b> - to allow full bore access to 82, 110 or 160mm pipework for inspection or rodding			
110	118	103	<b>4D64</b>
160	186	107	<b>6D64</b>

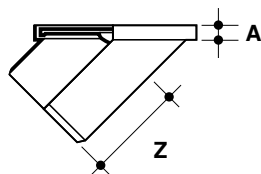

Size (mm)	A	Z	Code
<b>RODDING EYE</b> - elliptical rodding eye with 110mm pipe size spigot			
110	13	95	<b>4DRE</b>

Material: Aluminium. Access aperture size: 118 x 90mm.



# Terrain Drainage System

## Terrain gullies & hoppers

Size (mm)	A	B	Z1	Z2	Code
<b>GULLY TRAP</b> - to obtain 'P' trap, add 45° bend					
110	50	190	120	210	<b>4DG90</b>

Material: Polypropylene

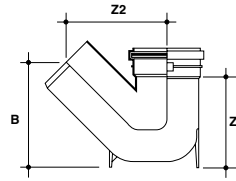

Size (mm)	A	B	Z1	Z2	Code
<b>'P' TRAP</b> - to obtain 'Q' or 'S' trap, add 45° or 87½° bend					
110	104	193	92	265	<b>4DG91</b>

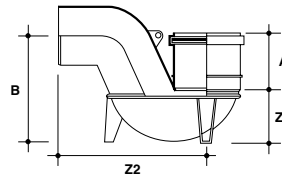

Size (mm)	L	Z	Code
<b>SQUARE HOPPER HEAD</b> - Spigot outlet may be cut off to reveal socket which can accept solvent-welded pipe as extended spigot			
110	203	105	<b>4DG92</b>

Material: PVC-u and Polypropylene. Terracotta body with black grid.

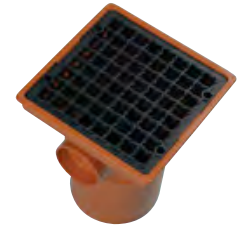
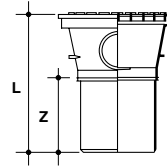

Size (mm)	A	L	Z	Code
<b>RECTANGULAR HOPPER HEAD</b> - Back inlet plate incorporates two easily removable discs to create apertures for insertion of 40mm waste pipes				
110	85	203	105	<b>4DG93</b>

Material: PVC-u and Polypropylene. Terracotta body with black grid.

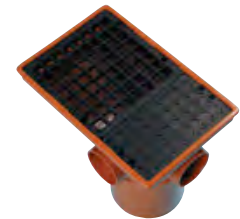
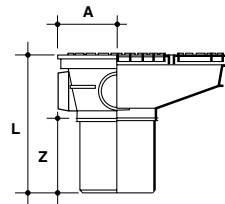

Size (mm)	A	B	L	Z	Code
<b>CIRCULAR GULLY</b> - Incorporates plugged horizontal pipe entries: 2 x 110mm spigots, 1 x 110mm ring seal socket and 1 x 68mm rainwater pipe socket					
110	104	193	92	265	<b>4DG80</b>

Material: PVC-u. Spigot outlet may be cut off to reveal socket which can accept solvent-welded pipe as extended spigot.

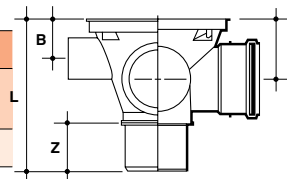

A	L	Code
<b>EXTENSION PIECE</b> - to extend upper aperture of 4DG80 Circular Gully to surface level or to lower horizontal pipe entries beneath surface level		
213	150	<b>4DG81</b>

Requires mastic sealant for forming airtight/watertight seal.

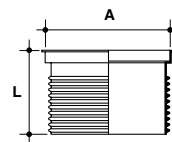

Size (mm)	A	D	E	F	G	Code
<b>BOTTLE GULLY WITH ROUND COVER</b> - removable dip tube provides 50mm deep trap						
110	213	150	154	304	190	<b>4DG97</b>

Material: PVC-u and Polypropylene. Incorporates 110mm back inlet connection. Terracotta body with black cover.

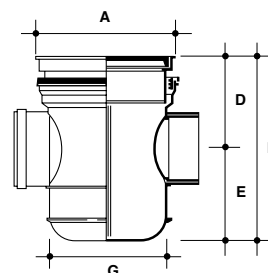

# Gullies & Hoppers

## Terrain gullies & hoppers

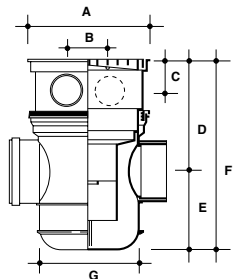

Size (mm)	A	B	C	D	E	F	G	Code
<b>BOTTLE GULLY WITH SQUARE COVER</b> - removable dip tube provides 50mm deep trap								
110	232	76	60	212	154	366	190	<b>4DG89</b>

Material: PVC-u and Polypropylene. Incorporates 2 x waste back inlet connections, can also accept up to 6 different pipes either direct or via adaptors. Terracotta body with black grid.

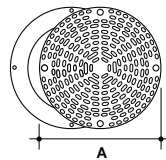
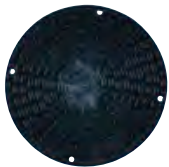

A	Code
<b>SEALED COVER</b> - to cap 4DG80 Circular Gully or 4DG81 extension	
211	<b>4DG82</b>

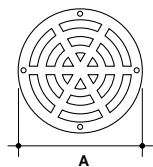
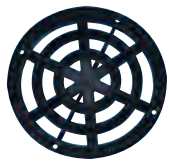

A	Code
<b>CIRCULAR GRATING</b> - to provide an open grating for surface water drainage for 4DG80 Circular Gully or 4DG81 Extension Piece	
211	<b>4DG83</b>

Also: spare grating for 4DG97 Bottle Gully.

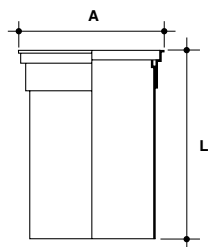

Size (mm)	A	L	Code
<b>RAISING PIECE</b> - to extend upper aperture of 4DG97 Bottle Gully to surface level or to lower horizontal pipe entries beneath surface level			
200	213	470	<b>4DG96</b>

Material: PVC-u and Polypropylene. Terracotta body with black grid.



Depth (mm)	Width (mm)	Height (mm)	Code
<b>SQUARE HOPPER COVER</b> - spare grid for 4DG92 Hopper Head			
13	155	155	<b>4DG92G</b>

Material: Polypropylene.



Width (mm)	Height (mm)	Code
<b>SQUARE SEALED COVER</b> - converts 4DG92 Square Hopper Head from open grid to sealed cover		
155	155	<b>4DG92GS</b>

Material: Polypropylene.

# Terrain Drainage System

## Terrain inspection chambers

Size (mm)	A	L	Z	Code
<b>SHALLOW INSPECTION CHAMBER</b> - to allow inspection of drainage system				
110	200	586	261	<b>4DI600</b>

Supplied with 2 plugs for unused entries 200mm socket has angular tolerance of  $\pm 7^\circ$  allowing up to  $14^\circ$  adjustment to accommodate pipe variation and ground fall.  
9163.4 Access Door may be fitted to the lower opening to achieve double seal.  
Access aperture size: 162 x 100mm.

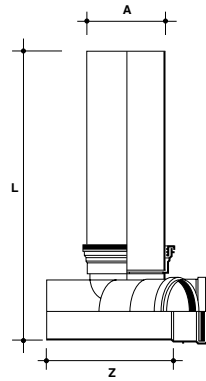

Size (mm)	A	B	Code
<b>SEALED COVER AND FRAME</b> - to cap 4DI600 Shallow Inspection Chamber			
110	211	43	<b>4DIFC1</b>

Ring seal joint to shaft.

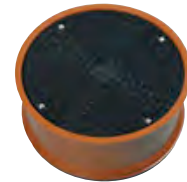
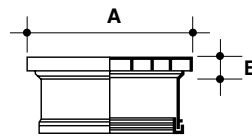

Size (mm)	A	B	Code
<b>EQUAL INSPECTION CHAMBER BASE (460mm diameter)</b> - 110mm Chamber Base with 4 x 110mm side branch inlets - 2 at $45^\circ$ and 2 at $90^\circ$			
110	460	220	<b>4DI240B</b>

Material: Polyethylene. Supplied with 3 x blanking plugs.

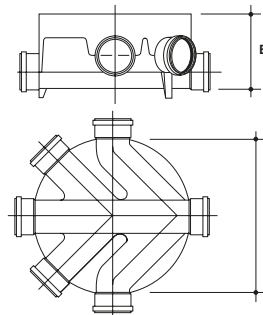

Size (mm)	A	B	Code
<b>UNEQUAL INSPECTION CHAMBER BASE (475mm diameter)</b> - 160mm Chamber base with 4 side branch inlets - 2 x 110mm at $45^\circ$ and 2 x 160mm at $90^\circ$			
160/110	460	610	<b>64DI240B</b>

Material: Polyethylene. Supplied with 4 x blanking plugs.

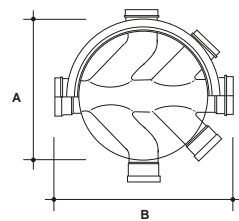

	A	B	Code
<b>SIDE RISER</b> - Side riser to be used with 4DI240B and 64DI240B chamber bases. Should be used with riser sealing ring 4DI215S			
	460	215	<b>4DI215R</b>

Material: Polypropylene.

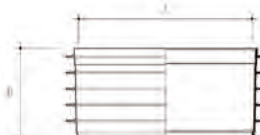

	Diameter	Code
<b>RISER SEALING RING</b> - Riser sealing ring (for dry fix to 4DI215R)		
	470	<b>4DI215S</b>



Please Note: Purchased as individual items according to final installation depth requirements.

# Terrain Adaptors

## Terrain inspection chambers



	A	B	Code
<b>COVER AND FRAME</b> - BS EN 124: 1994 - Group 1, Class A15 (formerly BS497: 1976 Class C+)			
♠	579	454	<b>4DIFC4</b>

Material: Polypropylene cover and frame. For domestic drive-ways accessible to vehicles up to one tonne maximum wheel load.

## Terrain accessories



Size (ml)	Code
<b>TERRAIN ACCESSORIES - CLEANING FLUID</b> - for cleaning PVC-u pipe and fittings before applying Liquid Weld	
250	<b>9101.250</b>

Material: Acetone. Screw top cans.



Size (ml)		Code
<b>TERRAIN ACCESSORIES - LUBRICANT</b> - for lubricating seal rings on expansion fittings		
250	Tub (Silicone)	<b>9136.250</b>
500	Tub (Soluble)	<b>9136.500</b>

Material: Silicone grease or Soluble lubricant.



Size (ml)		Code
<b>TERRAIN ACCESSORIES - LIQUID WELD</b> - for solvent jointing of PVC-u pipes and fittings cap, incorporates integral brush		
♠ 250	Tub	<b>9100.250</b>
♠ 500	Tub	<b>9100.500</b>

# Terrain Drainage System

## Terrain adaptors

Size (mm)	A	B	Code
<b>UNIVERSAL RAINWATER ADAPTOR</b> - for connecting round and square PVC-u rainwater downpipe (up to 68mm) to underground drainpipe			
110	110	102	4D76

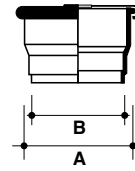

Size (mm)	A	L	Code
<b>UNIVERSAL RAINWATER ADAPTOR</b> - for connecting round and square PVC-u rainwater downpipe (up to 68mm) to underground drainpipe			
110	8	40	4DW200

Material: EPDM

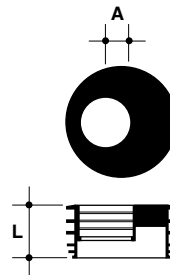

Size (mm)	A	L	Code
<b>ADAPTOR TO ABOVE GROUND DRAIN</b> - for connecting 68mm downpipes and 82mm underground drain			
82/68	41	54	3DW25
110/68	56	54	4DW25
110/82	56	54	4DW3

Material: Flex PVC. For round downpipe.

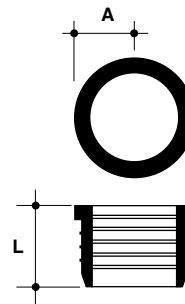

Size (mm)	A	L	Code
<b>ADAPTOR TO ABOVE GROUND DRAIN</b> - for connecting 62mm or 75mm downpipes and 82mm underground drain			
110/62	56	54	4DW23
110/75	37	58	4DW33

Material: Flex PVC. For square downpipe.

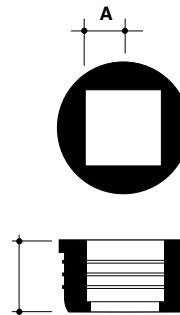

# Flexicon Couplings & End Caps

## Flexicon adaptors



	Range AB mm	Length (min)	Code	Driver
<b>FLEXICON UNIVERSAL ADAPTORS (XAC)</b>				
▽	120 - 135/100 - 115	100	XAC400T	7mm/8mm



	Range AB mm	Length (min)	Code	Driver
<b>FLEXICON DRAINAGE ADAPTORS (XAC)</b>				
▽	100 - 115/75 - 85	100	XAC85/115T	7mm/7mm
▽	100 - 115/85 - 95	100	XAC95/115T	7mm/7mm
▽	130 - 145/110 - 125	120	XAC125/145T	7mm/7mm
▽	145 - 160/110 - 125	120	XAC125/160T	7mm/7mm
▽	150 - 165/110 - 115	120	XAC115/165T	7mm/7mm
▽	160 - 175/110 - 125	120	XAC125/175T	7mm/7mm



	Range AB mm	Length (min)	Code	Driver
<b>FLEXICON PLUMBING ADAPTORS (XPA)</b>				
▽	50 - 65/30 - 45	80	XPA45/65T	7mm/7mm
▽	80 - 95/45 - 50	100	XPA50/95T	7mm/7mm



	Range AB mm	Length (min)	Code	Driver
<b>FLEXICON DRAIN COUPLINGS (XDR)</b>				
▽	50 - 65	95	XDR65T	7mm
▽	80 - 95	110	XDR95T	7mm
▽	100 - 115	110	XDR115T	7mm
▽	110 - 125	120	XDR125T	7mm
▽	150 - 165	120	XDR165T	7mm
▽	150 - 175	120	XDR175T	7mm
▽	175 - 200	150	XDR200T	8mm

## Flexicon couplings

	Range AB mm	Length (min)	Code	Driver
<b>FLEXICON SHEAR BAND STANDARD COUPLINGS (XSB)</b>				
▽	100 - 125	120	XSB125T	8mm
▽	110 - 120	120	XSB120T	8mm



	Range AB mm	Code	Driver
<b>FLEXICON END CAPS (XST)</b>			
▽	50 - 65	XST65T	7mm
▽	80 - 95	XST95T	7mm
▽	100 - 115	XST115T	7mm



# Terrain System Planning

## System planning

### Handling

- Take all reasonable care when handling PVC-u, particularly in very cold conditions when the impact strength of the material is reduced.
- Do not throw or drop pipes, or drag them along hard surfaces.
- In case of mechanical handling, use protective slings and padded supports. Metal chains and hooks should not make direct contact with the pipe.

### On-site storage

- Stack pipe lengths:
  - either on a flat base
  - or on level ground
  - or on 75mm x 75mm timber at 1.0m maximum centres
- Provide side support with 75mm wide battens at 1m centres (Fig. 1).
- Maximum stack: seven layers high.
- Ideally, stacks should contain one diameter pipe size only. Where this is not possible, stack largest diameter pipes at base of stack. Small pipes may be nested inside larger pipes.
- If stored in the open for long periods, or exposed to strong sunlight, cover the stack with opaque sheeting.

- Store fittings under cover. Do not remove from cartons or packaging until required.
- Store solvent cement and cleaning fluid in a cool place in accordance with the relevant regulations detailed in the Health & Safety at Work Act 1974.

### Storage in hot climates

- Ultra-violet light can affect pipes and fittings: pipe colour may change and rubber seals may be degraded.
- Accordingly:
  - store all materials in well-ventilated, shady conditions
  - do NOT expose to direct sunlight
  - keep fittings in original packaging until required for use
- Maximum stack (hot conditions): six layers high.

### Site safety

- The relevant regulations detailed in the Health & Safety at Work Act 1974, and Construction (Design & Management) Regulations 1995, must be adhered to on-site.
- COSHH data sheets are available on request.

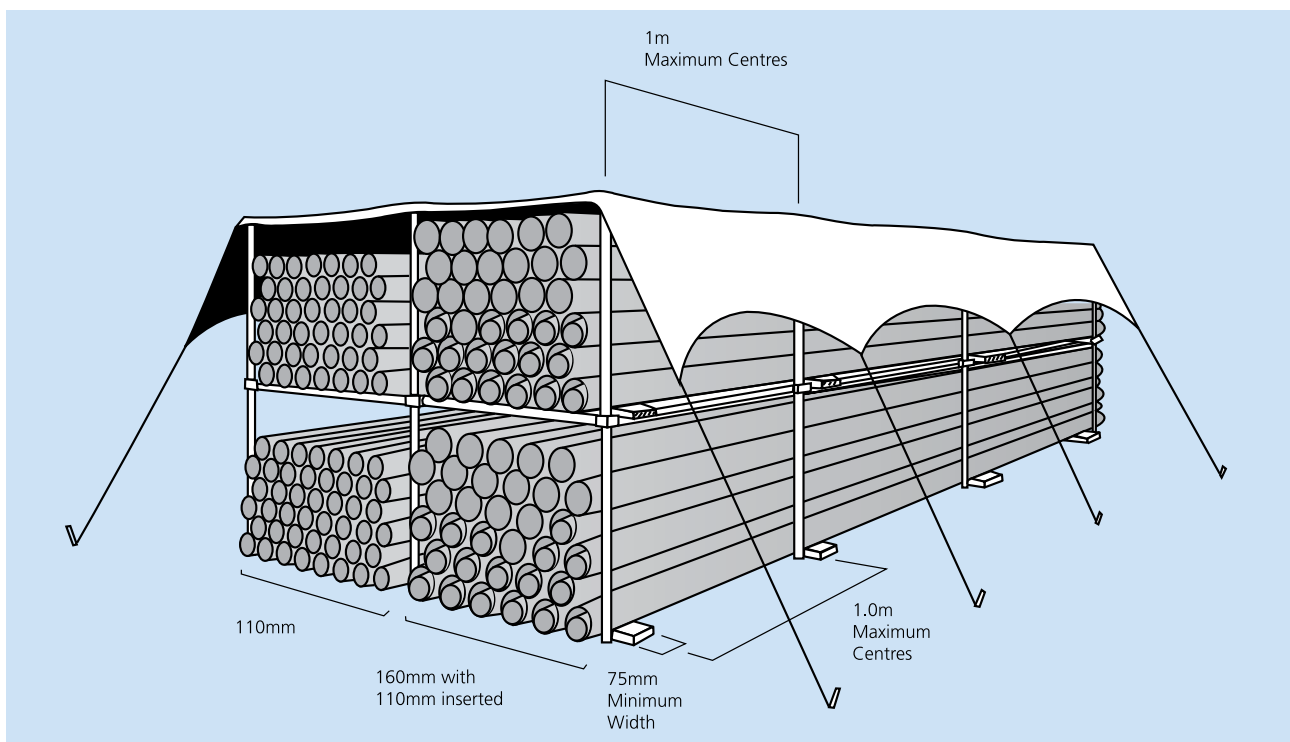

Fig. 1 Pipe stacking



## System planning

### Seal ring jointing

**Important:** A 9mm expansion gap must be created at all seal ring joints to allow pipes to expand or contract without stressing during wide temperature variations.

#### Step 1

Pipe lengths are supplied ready-chamfered. For site-cut pipes and offcuts, ensure cut is square - then file ends to provide 45° external chamfer. (Do not chamfer to a knife edge.) Lubricate rubber seal with 9136 Lubricant (Fig. 2a).

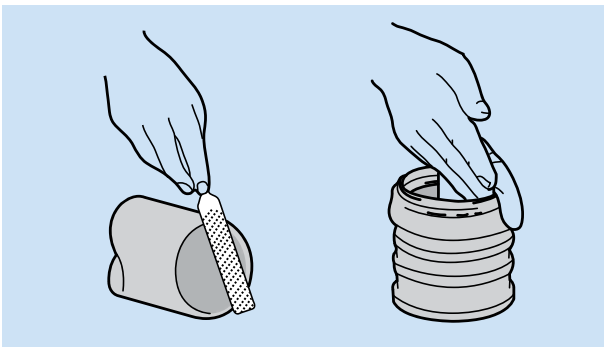

Fig. 2a Filing chamfer

#### Step 2

Push pipe fully into socket. Mark pipe against socket edge as shown (Fig. 2b).

#### Step 3

Withdraw pipe until mark is 9mm from socket edge to provide required expansion gap (Figs 2c and 2d).

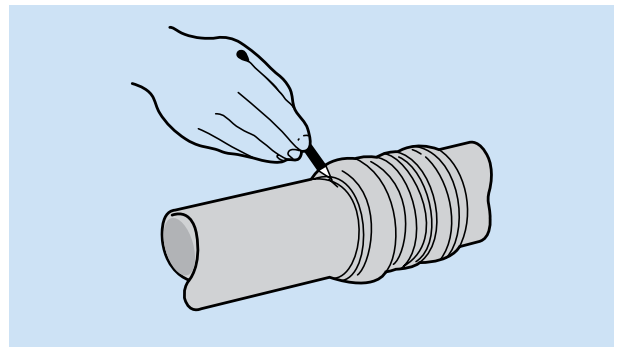

Fig. 2b Pushing in pipe/marking pipe

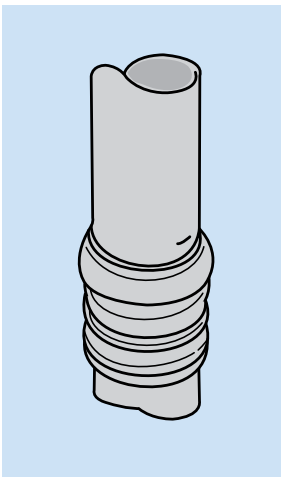

Fig. 2c Pipe withdrawn by 9mm

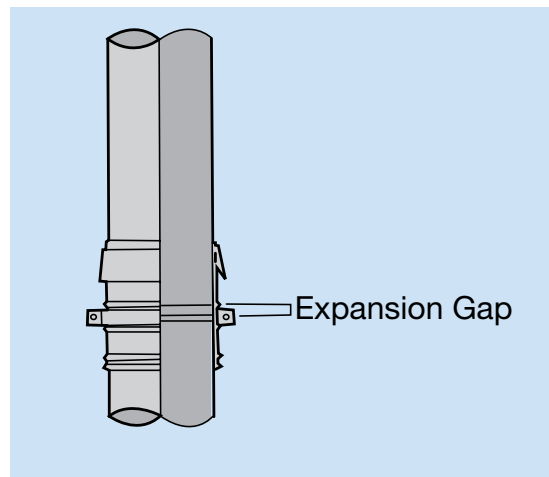

Fig. 2d Pipe Expansion gap

# Terrain System Planning

## System planning

### Pipe bedding and backfill

All bedding and backfilling of Terrain Underground pipes should be in accordance with BS EN 5955: Part 6 Installation of PVC-u pipework for gravity drains and sewers, or the BBA Certificate.

Terrain 110mm and 160mm PVC-u underground drainage systems have been awarded British Board of Agrément Certificate No. 94/3049. This allows:

- 50mm depth of granular bedding (Fig. 3)
- Where the as-dug soil is suitable, pipes may be laid directly on a trimmed trench bottom (Fig. 4)

Suitable material is defined as granular material in accordance with the recommendations of BS EN 5955: Part 6: 1980 having a nominal particle size not exceeding 10mm or 14mm for 110mm and 160mm diameter pipes respectively, or that which passes the tests described in appendix A of the above standard.

#### Where the as-dug material is unsuitable

A bed of suitable imported granular material must be laid on the trench bottom prior to installation of pipes and be used for sidefill up to the level of the crown of the pipe.

If the trench may be hand trimmed by shovel and is not puddled when walked on, a bed of 50mm is sufficient (Fig. 3).

When pipes are to be laid in hard ground requiring mechanical means of trimming (e.g. rock, compacted sand or gravel), or in very soft or wet ground, a bed of min. 100mm is required (Fig. 5).

### Drains under buildings

Where drains are required to be laid under buildings, deep hardcore from within the foundation boundaries should be compacted prior to excavating the trench for the pipe. Suitable material should then be employed for the bedding and backfilling.

When trenches are dug from original ground, pipes may be laid and surrounded with appropriate material before the top layer of hardcore is placed.

Where pipes pass through a wall or foundations of a building, they should be protected by a lintel or sleeve.

### Shallow drains

Where there is risk of damage, pipes laid at less than 600mm depth (not under a road) should be protected by use of a paving slab or similar. A minimum 75mm cushioning layer of granular material must be laid between any slab and the crown of the pipe.

### Pipes laid under roads

The minimum cover under roads should be 1.2m from the top of the pipe. Where this is less than 1.2m additional protection is required ie. reinforced bridging slabs.

## Requirements for imported material for backfill

Nominal pipe size	Material complying with BS 882: 1992
110mm	10mm nominal single-sized aggregate
160mm	14mm nominal single-sized aggregate

Fig. 3

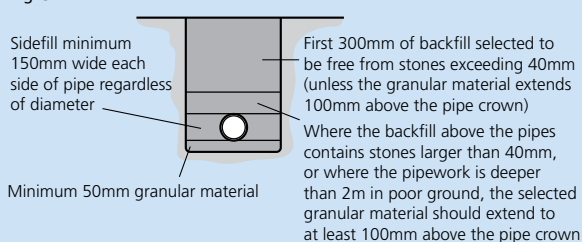

Fig. 4

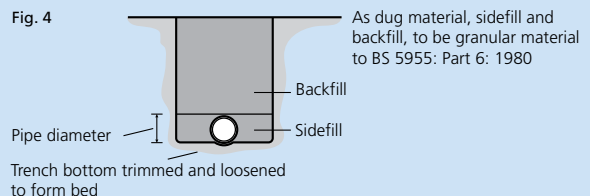
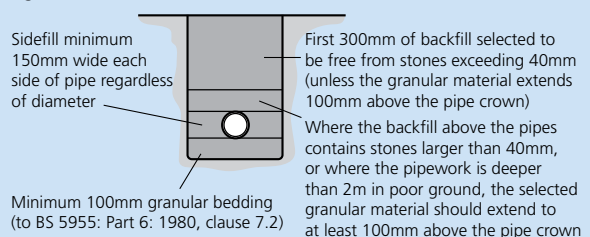

Fig. 5



## System planning

### Rodding points

Rodding points may be used on drains with invert depths up to 2m. They may be located at the head of a drain or at intermediate positions as an alternative to an inspection chamber or manhole. However,

- Because rodding is possible in the direction of flow only, sufficient rodding points must be incorporated to provide access to all parts of the drain.
- As it is not possible to remove debris from a rodding point, an inspection chamber or manhole must be provided at a point downstream.

During installation, care must be taken to ensure no load is transferred onto the branch upstand of the pipe.

### Shallow inspection chamber

Provides an alternative to traditional manholes for invert depths up to 600mm. Intermediate depths can be accommodated by cutting chamber riser with a fine-tooth saw. The base unit is supplied with two contoured plugs sealing the two side connections. For left or right hand single connections, the appropriate plug is removed. The 4DI600 Shallow Inspection Chamber can be used with 4DIFC1 Sealed Cover and Frame (PVC-u) (Fig. 6).

If situated in an area where it may be damaged, the frame should be surrounded with concrete to prevent movement and provide extra security.

### Inspection chambers

The Terrain 4DI240B and 64DI240B Inspection Chambers provide an alternative to traditional manholes for invert depths up to 1.2 metres. It comprises a base unit and three raising pieces (4DI215R) to allow a range of heights to be easily achieved (Fig. 7).

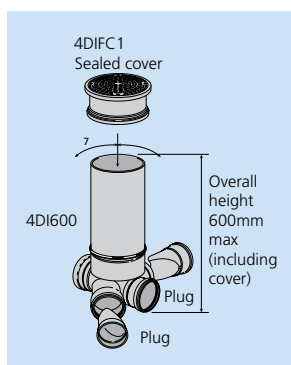

Fig. 6

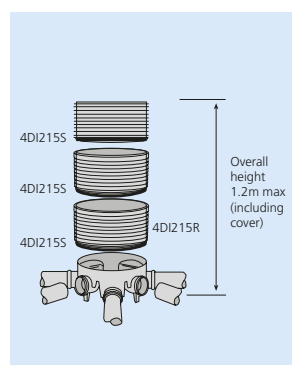

Fig. 7

### Overall heights

Overall heights	
Including cast iron frame and cover	
Base Unit	285mm
Base unit plus 1 raising piece	520mm
Base unit plus 2 raising pieces	755mm
Base unit plus 3 raising pieces	990mm
Base unit plus 4 raising pieces	1225mm

Intermediate heights can be achieved by cutting the top raising piece as necessary. Chambers should be installed on a 100mm bed of suitable granular material or as dug material. The bedding material must be evenly compacted under the base so that the chamber is fully supported. Different covers are available to meet varying application requirements:

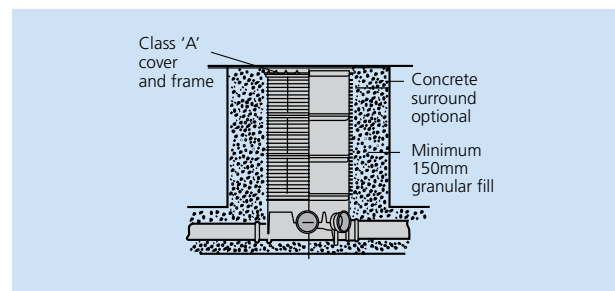

Fig. 8

### Polypropylene cover and frame (4DIFC4):

For use where cars and light vehicles have access but NOT heavy vehicles (Fig. 9) rated to 35kN.

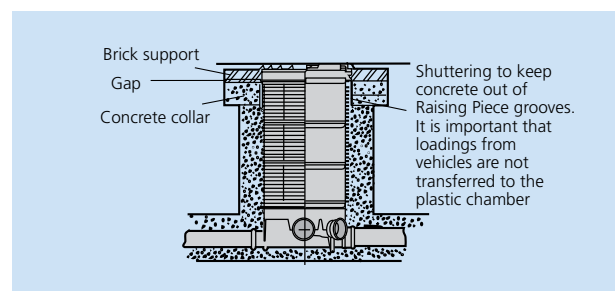

Fig. 9

# Terrain System Planning

## System planning

### Unequal inspection chamber

Suitable for invert depths of up to 1.2metres, the 64DI240B Unequal Inspection Chamber incorporates a through drain of 2 x 160mm and side connections of 2 x 110mm (Fig. 10).

The specific required height can be achieved by cutting the chamber body or extension piece (4DI235R) with a fine-tooth saw.

The unit is supplied with all inlets and outlets blanked off. These are easily opened for use by cutting off the ends with a fine tooth saw.

The appropriate cover should be selected, as for the Terrain Inspection Chamber. For installation details see page 21.

### Brick or concrete ring manholes

One or more inspection chamber bases 4DI240B or 64DI240B with upstand removed may be used at the base of manholes as an alternative to benching in half channel or slip couplings.

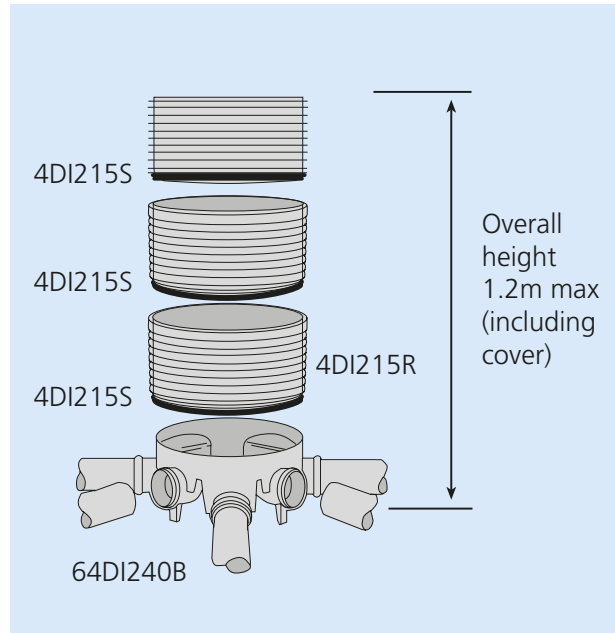

Fig. 10

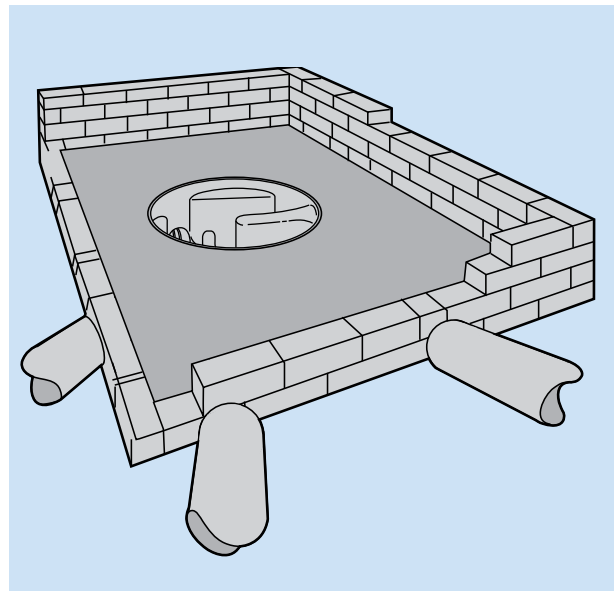

Fig. 11



# Terrain System Planning

## System planning

### Bottle gully - square cover (Fig. 16)

The frame and cover may be rotated to meet site requirements and the square grid cut away to suit rainwater or waste pipe entry. The back inlet socket is suitable for solvent weld connection of 110mm diameter pipe. A push-in blank plug is supplied for use when connection is not required.

**To connect waste pipes to back inlet bosses:** remove rubber plug from side bosses and solvent-weld appropriate fitting (Fig. 17).

### For straight connectors

Straight connectors	
32mm	117.125
40mm	117.15
50mm	117.2

### For 90° bend connectors

90° Bend connectors	
32mm	117.15.90 & 224.15.125
40mm	117.15.90
50mm	117.2.90

NOTE: The height of the cover and frame (with the back inlets) may be raised by cutting off the spigot and extending with 200mm pipe.

### Bottle gully - round cover (Fig. 18)

**To connect 110mm pipe to back inlet socket:** remove polypropylene plug and solvent-weld pipe or spigot of fitting. The gully may be extended by using the 4DG96 Raising Piece (Fig. 19). The grating and frame should be removed from the gully and the raising piece inserted. The grating should then be fixed to the top of the raising piece. The original gully frame unit should be discarded.

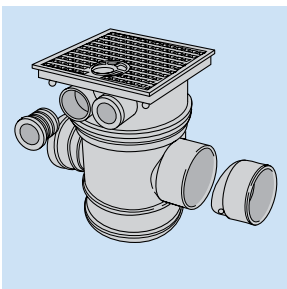

Fig. 16

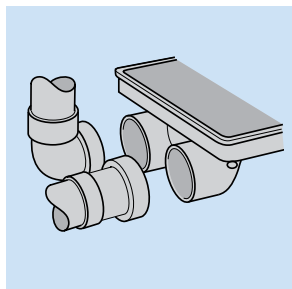

Fig. 17

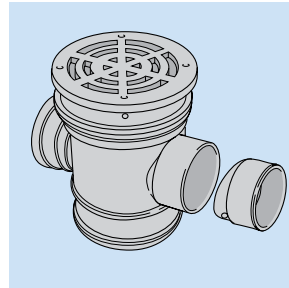

Fig. 18

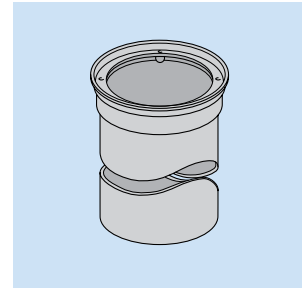

Fig. 19

## Gully traps/bends arrangements

### P Trap

- Use 4DG90 Gully Trap and 4D25D Bend 45° (Fig. 20)

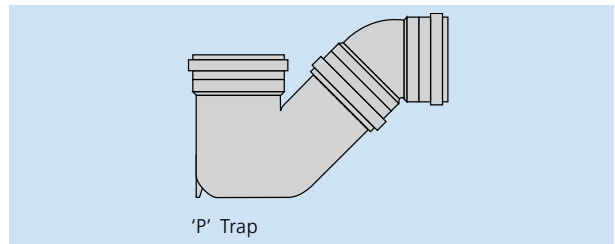

Fig. 20

### Q Trap

- Use 4DG90 Gully Trap and 4D23D Bend 87 1/2° (Fig. 21)

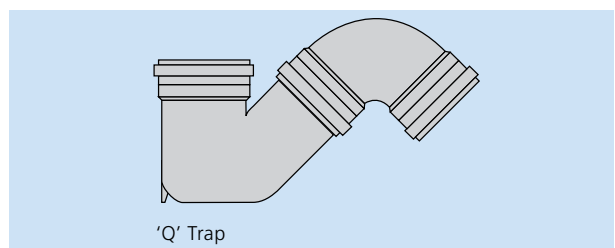

Fig. 21

### Q Trap

- Use 4DG90 Gully Trap with 4D23D Bend 87 1/2° and 4D25 Bend 45° (Fig. 22)

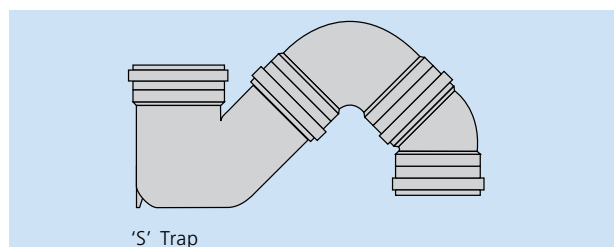

Fig. 22

## System planning

### Circular gully and traps (Fig. 23)

This 4DG80 gully is designed to accept both the 4DG82 Sealed Cover and the 4DG83 Circular Grating.

Where required, the unit may be extended by fitting the 4DG81 Extension Piece into the top of the gully.

The gully fitting incorporates:

- 2 x side spigot inlets (110mm dia spigots)
- 1 x 110mm ring seal socket inlet
- 1 x 68mm spigot inlet, to accept rainwater pipe

Each inlet is fitted with a removable polypropylene plug.

The 110mm spigot outlet may be removed - by cutting with a fine-tooth hand saw - to leave a socket to accept 110mm pipe with solvent-weld joint.

### Hoppers and traps (Fig. 24)

Hoppers are supplied with open grids which snap into place. Sealed covers are available and should be secured using the self-tapping screws provided.

The 110mm spigot outlets may be removed – by cutting with a fine-tooth hand saw – to leave a socket to accept 110mm pipe with solvent-weld joint

To connect waste pipe to side bosses

- Drill out blanking plug using a 51mm diameter hole saw
- Solvent-weld appropriate fitting:

### For straight connectors

Straight connectors	
32mm	117.125
40mm	117.15
50mm	117.2

### For 90° bend connectors

90° Bend connectors	
32mm	117.15.90 & 224.15.125
40mm	117.15.90
50mm	117.2.90

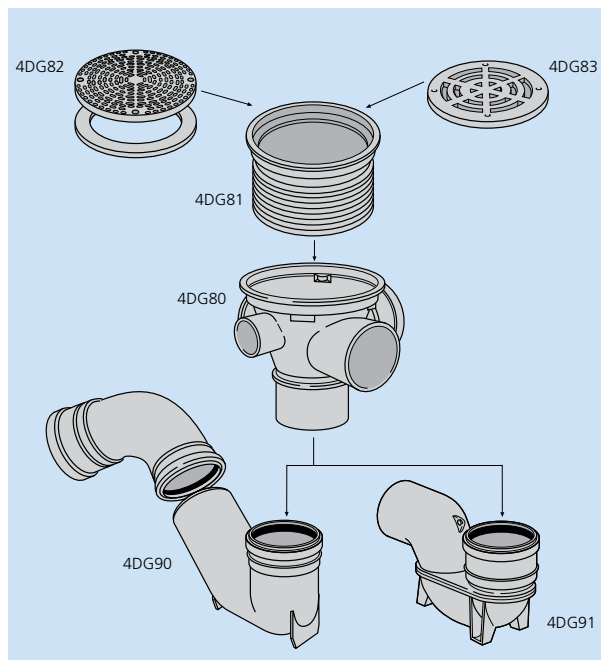

Fig. 23

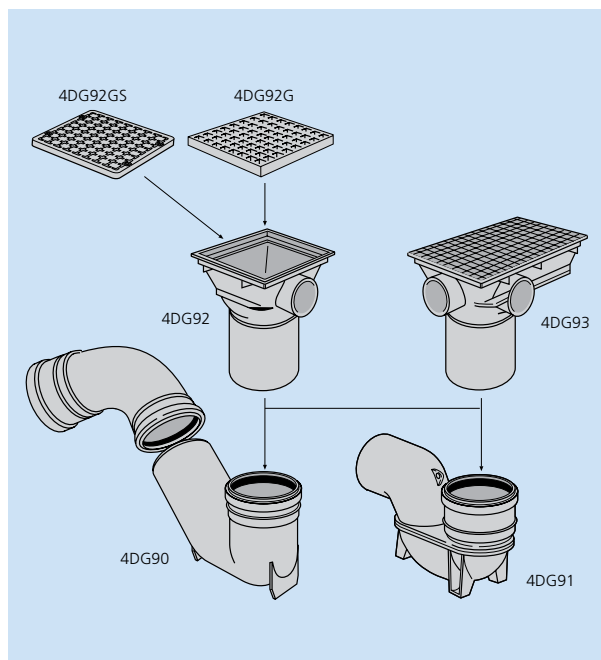

Fig. 24

# Terrain System Planning

## System planning

### System connections to above ground drainage

#### Connecting to soil system (soil pipe to BS EN 1329)

- **110mm Underground Pipe to 110mm Soil Pipe**  
110mm Underground Pipe may be connected directly to 110mm Soil Pipe (Fig. 25)
- A 45° external chamfer should be filed onto the end of square cut soil pipe. The soil pipe is then push-fit into the underground drain ring seal socket, using **9136 Lubricant**
- **110mm Underground Pipe to 82mm Soil Pipe** (Fig. 26)  
Connection should be made using the **4DW3 Socket Reducer**. The socket reducer is inserted into the plain end of the underground pipe. The 82mm soil pipe is then pushed into top of reducer

#### Connecting to waste system (waste pipe to BS EN 5255/1566)

Connection is made using the **124 Socket Reducer**. The socket reducer is pushed into the ring seal of the socket on the underground drain pipe. The waste pipe is solvent-welded into reducer. Additional reducers may be used as required.

#### Connecting to rainwater or waste system (using rubber adaptor) (Fig. 27)

The **4DW Adaptor** enables simple push-fit connection of 110mm underground pipe to waste or rainwater systems. It is available for the following pipe sizes:

Rainwater	
68mm round	4DW25
62mm square	4DW23
75mm square	4DW33
82mm round	4DW3
Waste	
32mm round	
40mm square	4DW200
50mm round	

#### Connecting to BS EN 5255/524/1566 waste pipe (Fig. 28) (also to copper waste pipe)

The centre of **4D68/6D68 Socket Plug** should be drilled out, ready for solvent-weld connection of the appropriate size **4DW Boss Adaptor**. Seal rings on 4DW and underground drain socket should be lubricated using **9136 Lubricant**. The socket plug is then inserted into the underground drain socket and **200 Waste Pipe** (or copper waste pipe) into 4DW adaptor.

All dimensions in mm unless otherwise stated

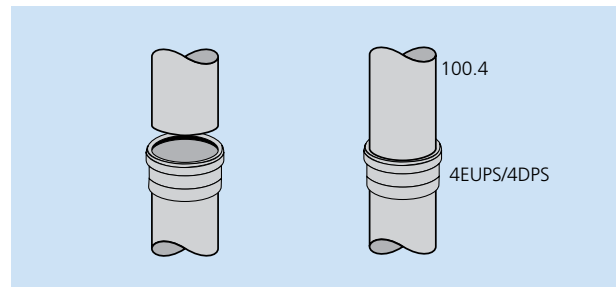

Fig. 25

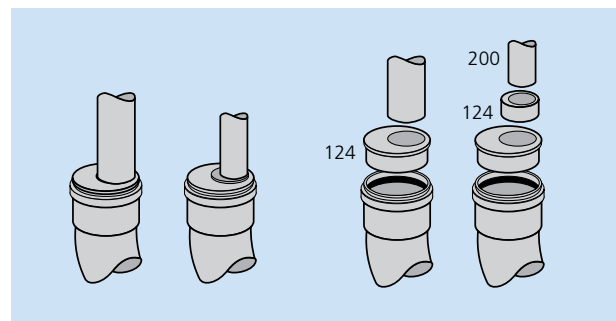

Fig. 26

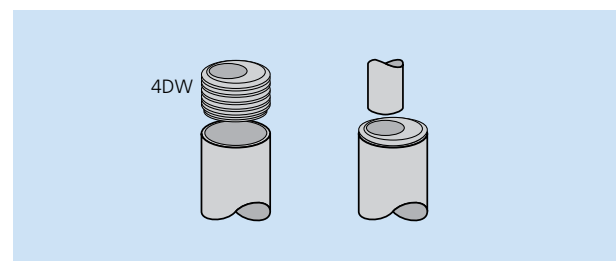

Fig. 27

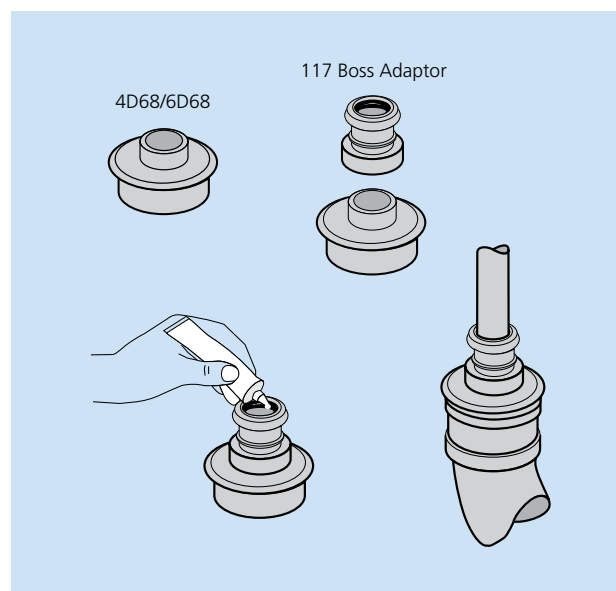

Fig. 28



## Further Information

### Further information and assistance

Terrain products are backed by a comprehensive technical advisory service, available to provide advice and design guidance on all aspects of above and below ground drainage.

#### Technical services include:

- Soil and waste schematics and applicable details
- Specification, product scheduling and estimating
- CAD drawings, including products and application details on disk

Many products are also available in CAD format for ready incorporation into design drawings. To obtain a disk or CD Rom in the appropriate format, simply contact Technical Services.

- On-site advice and problem solving
- Prefabrication and fabrication design service

For prompt assistance, please contact the

#### Terrain Technical Services Department:

Tel: +44 (0)1622 795200

Fax: +44 (0)1622 716796

### Special component design service

For over 30 years our Fabrication Service has been helping specifiers and contractors overcome problems on-site and at the design stage of projects. We can provide the solution to even the most demanding problems with specials fabricated to order.

### Terrain standard specials

Created from modifications to standard products to meet frequently occurring design problems. These are identified with an F prefix in the product listing where applicable.

### Terrain design specials

Products can be manufactured on a one-off or small batch basis to meet the demands of unique installations/applications. These can be produced to customer specification in virtually any size or shape. Contact Technical Services for further assistance.

### Materials and colours

Pipe and most fittings are manufactured in terracotta PVC-u. Where other materials are used these are generally PP/PE.

### Quality assurance

Terrain is accredited to BS EN ISO 9001:2000 Quality Management Systems.

### Standards compliance

Terrain underground complies with the appropriate British Standard/European Norm and, where applicable, is Kitemarked to BS EN 1401:1998.

The Inspection Chamber Base (4DI240B) and Raising Piece (4DI235R) meet the requirements of BS 7158:2001 for Plastic Inspection Chambers for drains.

### Certifications

Foamcore pipe is covered by the following British Board of Agrément certificate: **95/3086**

Eurodrain (Foamcore) Underground Drainage Pipe 110 and 160mm comply with BS EN 1401 (BS 4660).

EN1401:1998 Underground Drainage.

EN7158:2001 Plastic Inspection Chambers for Drains and Sewers.

### Availability

For details of a wide range of stockists, please contact **Sales Support on +44 (0)1622 795200**

# UK Basic Design Principles

## Installation

Installation should be carried out in accordance with BS5955: Part 6: 1980. Plastic pipe work (thermoplastics materials) - Code of practice for the installation of unplasticized PVC pipe work for gravity drains and sewers, BS8301: 1985 code of practice for building drainage and this detail sheet.

### 1. Bedding:

Where the as-dug material is suitable for use as bedding, (i.e. having a nominal particle size not exceeding 10mm or 14mm for 110mm and 160mm diameter pipes respectively), the bottom trench may be trimmed to form the pipe bed.

See BS5955: part 6: 1980: Appendix A

Where as-dug material must be hand trimmed by shovel and is not puddled when walked upon a 50mm depth of bedding material may be used.

In this case the material must be nominal 10mm single sized aggregate with no sharp edges e.g. pea gravel.

### 2. Side Fill:

In all cases the side fill must be the same specification as the bedding material and extend to the level of the crown of the pipe and placed and compacted in accordance with BS5955: part 6: 1980.

### 3. Backfill:

Where the backfill above the pipe contains stones larger than 40mm or where the pipe work is deeper than 2 metres, in poor ground, the selected granular material should be extended at least 100mm above the crown of the pipe.

### 4. Backfill:

The first 300mm of the backfill selected must be from stones exceeding 40mm (unless the granular material extends 100mm above the pipe crown - as noted 3).

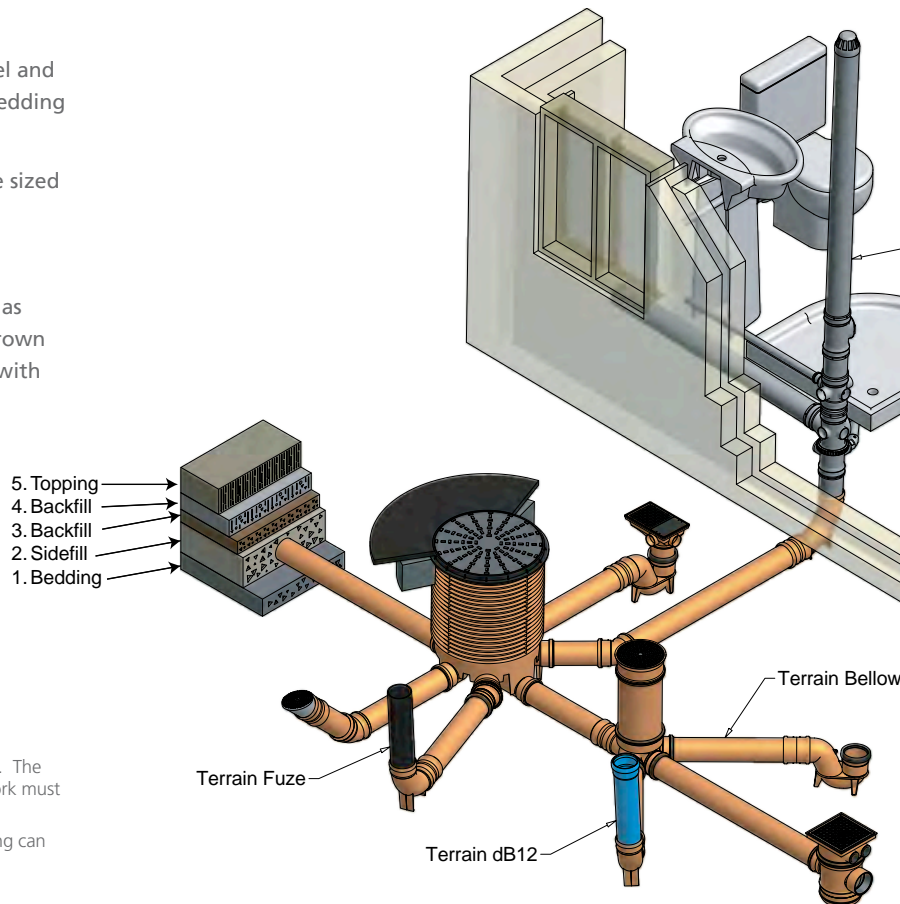

## NOTES:

### 1. Inspection Chamber Installation:

The base should be placed on the same bedding material as the pipe. The blanking plugs should be placed in the sockets not used. All pipe work must be chamfered before pushing into seals.

Once the upstand has been trimmed to the required height back filling can take place using the selected material and tamping layers.

The base is supplied with 4 blanking plugs.

### Covers:

Class 'C+' \*\* (ref 4DIFC4) suitable for cars and light vehicles. The cover and frame may be bedded onto a concrete surround.

Class 'B' (By other) Required where vehicular traffic is expected. The concrete surround must be separated from the upstand by shuttering to prevent load being transmitted to inspectional chamber base.

BS497:1976. †EN124-Class A15

### 2. Pipe Adhesion

To enable mortar or concrete to adhere to UPVC, the external surface of the pipe or fitting should be coated with Terrain solvent cement and the whole of the coated area dusted with dry coarse sharp sand, whilst the solvent cement is still tacky.

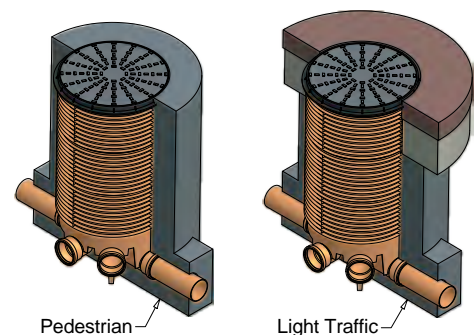

Gullies and Hoppers

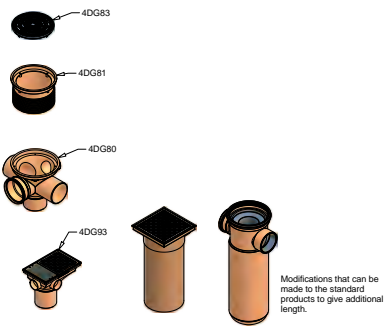

Terrain Above Ground

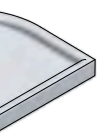

Ground

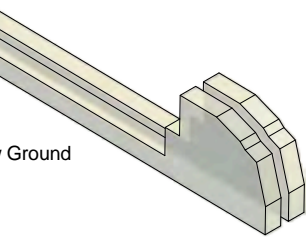

**Discharge Units**

Flow rates, probability of discharge factors and discharge unit ratings

Appliances	Capacity	Discharge Data		Recurrence use interval (frequency of use)	Probability discharge, P p=t T	Discharge, P p=t T
		Flow rate	Duration			
	L	L/s	S	S*		
<b>WC</b> (9L high level cistern)	9	2.3	5	1200	0.004	7†
600				0.008	14	
300				0.017	28	
<b>Washbasin</b> (32mm branch discharge pipe)	6	0.6	10	1200	0.008	1†
600				0.017	14	
300				0.033	18	
<b>Sink</b> (40mm branch discharge pipe)	23	0.9	25	1200	0.021	6†
600				0.042	14	
300				0.083	18	
<b>Bath</b> (40mm branch discharge pipe)	80	1.1	75	4500	0.017	7†
(domestic)						
1800				0.042	27	
<b>Automatic washing machine</b>	180	0.7	300	15000	0.020	4
<b>Shower</b>	-	0.1	-	-	-	Use flow rate
<b>Spray tap</b>	-	0.06	-	-	-	Use flow rate
<b>Urinal</b> (per stall, automatic flushing)	4.5	0.15	30	1200	0.025	0.3
900				0.330		

\* A use or recurrent interval (frequency of use) of 1200's corresponds to domestic use; 600's to commercial use; 300's to congested use such as in public toilets, schools and factories

† to domestic installations, the highest loading occurs during the morning peak period and is made up of the discharge from WC's basins, and sinks. For this reason, a dwelling is usually allotted a fixed number of discharge units for a group consisting of one each of these appliances<sup>1</sup>. In this code, 14 discharge units per dwelling is assumed (see BS 5572).

<sup>1</sup> Some proportion of the total number of appliances may be assumed to be in simultaneous operation if considered appropriate.

**Gradients**

Size of PVC-U	Minimum gradient	Standard workmanship and supervision
110mm	1 in 80*	normal
110mm	1 in 130	high
160mm	1 in 150	normal
160mm	1 in 200	high

\* must include discharge from 1 WC where the rate of flow is small, eg from gully trap connections, their gradient should generally not be less than 1 in 40. Ref BS CP 8301 Clause 7.4.4.4.

**Surface Water Drains**

Capacity of surface water drains that may be drained by 110mm and 160mm pipes

Size of PVC-U	Minimum gradient	Capacity flowing full litres per second
82mm	1 in 40	5.5*
82mm	1 in 80	3.2*
110mm	1 in 80	6.54*
110mm	1 in 130	5.13*
160mm	1 in 150	14.10*
160mm	1 in 200	12.20*
200mm	1 in 100	44.0*
200mm	1 in 200	30.0*

\* from Crimp and Bruges Tables and Diagrams Metric Edition 1969

**NOTE\***

1 in 40 = 25.0mm per metre

1 in 80 = 12.5mm per metre

1 in 130 = 7.5 per metre

1 in 150 = 6.6 per metre

1 in 200 = 5.0 per metre

Local authorities throughout the United Kingdom differ widely in their attitude towards the approval of drainage schemes and it must be emphasised that these brief notes are for general guidance only.

# Sustainable Products and Manufac

Evolving solutions are the key to success,  
at Polypipe we're making it happen

At Polypipe we aim to make our customers' lives easier. We know they are faced with ever increasing regulation and legislation and have therefore developed an outstanding range of product and system solutions that meet more legislation requirements than anyone else.

We always work with sustainability in mind, in fact sustainability isn't just a pipe dream... at Polypipe we are making it happen.

Our innovative approach to changing regulations and legislation has made us synonymous with best practice within our industry.

Plastics are lighter and more robust than traditional materials - less to do more. They help reduce energy usage and therefore greenhouse gas emissions because they are lightweight in production, transport and use. In comparison to traditional materials, like concrete or clay, plastics are recyclable, require no quarrying activities and reduce the carbon footprint from transportation.

## We produce:

- Products which consider the long-term effects to the environment and which provide environmentally friendly solutions
- Rainwater harvesting and recycling solutions
- Energy saving products
- Clean, lightweight, flame-free, non-hazardous products
- Products which reduce noise
- Stormwater management systems

Due to its longer lengths and lighter weight, it can be 70% cheaper to transport than equivalent concrete pipes

Our Philosophy:  
Reduce, Reuse,  
Recycle



# uring Processes

Polypipe has always led the way in manufacturing quality products to meet and exceed ever changing regulations

With the support of WaterAid, more than 5.5 million people have gained access to safe, clean water thanks to the use of plastic pipes

APME (Association of Plastics Manufacturers in Europe), Plastics: At Work for a Sustainable Future

Polypipe sustainable indoor environmental solutions can help meet the Merton Rule by providing at least 10% of predicted energy requirements through incorporating renewable energy production equipment on larger developments

Rainwater harvested from a Rainstream system can easily replace 50% of the domestic demand for non-potable water



# Index

Code	Product Description	Page No.
3D20D	COUPLER DOUBLE SOCKET - with central stop	5
3D23D	SHORT RADIUS BEND DOUBLE SOCKET	5
3D25D	SHORT RADIUS BEND DOUBLE SOCKET	5
3D33D	SINGLE EQUAL JUNCTION	6
3DP3	SOLID WALL PIPE PLAIN ENDED	4
3DP58	SOLID WALL PIPE PLAIN ENDED	4
3DW25	ADAPTOR TO ABOVE GROUND DRAIN	13
43DT	LEVEL INVERT TAPER	5
4D20D	COUPLER DOUBLE SOCKET - with central stop	5
4D20DSC	SLIP COUPLER	5
4D21	REST BEND SINGLE SOCKET	7
4D21D	REST BEND SINGLE SOCKET	7
4D23D	SHORT RADIUS BEND DOUBLE SOCKET	5
4D25	SHORT RADIUS BEND DOUBLE SOCKET	5
4D25D	SHORT RADIUS BEND DOUBLE SOCKET	5
4D27	SHORT RADIUS BEND DOUBLE SOCKET	5
4D27D	SHORT RADIUS BEND DOUBLE SOCKET	5
4D28	LONG RADIUS BENDS (Plain ended)	7
4D29	SHORT RADIUS BEND DOUBLE SOCKET	5
4D29D	SHORT RADIUS BEND DOUBLE SOCKET	5
4D30	SINGLE EQUAL JUNCTION SPIGOT OUTLET	6
4D30D	SINGLE EQUAL JUNCTION	6
4D63	ACCESS CAP	8
4D64	ACCESS CAP	8
4D65	TEMPORARY SITE CAP	8
4D68	SOCKET PLUG	8
4D69	PIPE END SOCKET	5
4D76	UNIVERSAL RAINWATER ADAPTOR	13
4DG80	CIRCULAR GULLY	9
4DG81	EXTENSION PIECE	9
4DG82	SEALED COVER	10
4DG83	CIRCULAR GRATING	10
4DG89	BOTTLE GULLY WITH SQUARE COVER	10
4DG90	GULLY TRAP	9
4DG91	SHORT RADIUS BEND DOUBLE SOCKET	9
4DG92	SQUARE HOPPER HEAD	9
4DG92G	SQUARE HOPPER HEAD	10

Code	Product Description	Page No.
4DG92GS	SQUARE SEALED COVER	10
4DG93	RECTANGULAR HOPPER HEAD	9
4DG96	RAISING PIECE	10
4DG97	BOTTLE GULLY WITH ROUND COVER	9
4DI215R	RAISING PIECE	11
4DI215S	SEAL RING	11
4DI240B	INSPECTION CHAMBER BASE (470mm diameter)	11
4DI600	SHALLOW INSPECTION CHAMBER	11
4DIFC1	SEALED COVER AND FRAME	11
4DIFC4	COVER AND FRAME	12
4DP3	SOLID WALL PIPE PLAIN ENDED	4
4DP3S	SOLID WALL PIPE SINGLE SOCKET	4
4DP58	SOLID WALL PIPE PLAIN ENDED	4
4DP6S	SOLID WALL PIPE SINGLE SOCKET	4
4DRE	RODDING EYE	8
4DV40	VARIABLE BEND SINGLE SOCKET	7
4DW200	UNIVERSAL RAINWATER ADAPTOR	13
4DW23	ADAPTOR TO ABOVE GROUND DRAIN	13
4DW25	ADAPTOR TO ABOVE GROUND DRAIN	13
4DW3	ADAPTOR TO ABOVE GROUND DRAIN	13
4EUP3	FOAMCORE PIPE PLAIN ENDED	4
4EUP3S	FOAMCORE PIPE SINGLE SOCKET	4
4EUP58	FOAMCORE PIPE PLAIN ENDED	4
4EUP6S	FOAMCORE PIPE SINGLE SOCKET	4
64D30D	SINGLE UNEQUAL JUNCTION (All sockets)	6
64D33	SPIGOT OUTLET	6
64D33D	SINGLE UNEQUAL JUNCTION (All sockets)	6
64DI240B	UNEQUAL INSPECTION CHAMBER BASE (475mm diameter)	11
64DT	LEVEL INVERT TAPER	5
6D20D	COUPLER DOUBLE SOCKET - with central stop	5
6D20DSC	SLIP COUPLER	5
6D23	SHORT RADIUS BEND DOUBLE SOCKET	5
6D23D	SHORT RADIUS BEND DOUBLE SOCKET	5
6D25	SHORT RADIUS BEND DOUBLE SOCKET	5
6D25D	SHORT RADIUS BEND DOUBLE SOCKET	5
6D27	SHORT RADIUS BEND DOUBLE SOCKET	5
6D30D	SINGLE EQUAL JUNCTION	6

Code	Product Description	Page No.
6D33D	SINGLE EQUAL JUNCTION	6
6D63	ACCESS CAP	8
6D64	ACCESS CAP	8
6D69	PIPE END SOCKET	5
6DP3	SOLID WALL PIPE PLAIN ENDED	4
6DP58	SOLID WALL PIPE PLAIN ENDED	4
6DP65	SOLID WALL PIPE SINGLE SOCKET	4
6EUP35	FOAMCORE PIPE SINGLE SOCKET	4
6EUP58	FOAMCORE PIPE PLAIN ENDED	4
6EUP65	FOAMCORE PIPE SINGLE SOCKET	4
9100.250	TERRAIN ACCESSORIES - LIQUID WELD	12
9100.500	TERRAIN ACCESSORIES - LIQUID WELD	12
9101.250	TERRAIN ACCESSORIES - CLEANING FLUID	12
9101.125	TERRAIN ACCESSORIES - CLEANING FLUID	12
9136.250	TERRAIN ACCESSORIES - LUBRICANT	12
9136.500	TERRAIN ACCESSORIES - LUBRICANT	12
XAC400T	Flexi Adapt 120-135 / 100-115	14
XAC85/115T	100-115/75-85MM FLEXI DRAIN ADAPT	14
XAC95/115T	100-115/85-95MM FLEXI DRAIN ADAPT	14
XAC125/145T	130-145/110-125MM FLEXI DRAIN ADAPT	14
XAC125/160T	160-165/100-125MM FLEXI DRAIN ADAPT	14
XAC115/165T	150-165/100-115MM FLEXI DRAIN ADAPT	14
XAC125/175T	100-125/100-125MM FLEXI DRAIN ADAPT	14
XPA45/65T	50-65/30-45MM FLEXI PLUMBING ADAPT	14
XPA50/95T	80-95/45-50MM FLEXI PLUMBING ADAPT	14
XDR65T	FLEXIBLE COUPLER (50MM-65MM)	14
XDR95T	FLEXIBLE COUPLER (80MM-95MM)	14
XDR115T	FLEXIBLE COUPLER (100MM-115MM)	14
XDR125T	FLEXIBLE COUPLER (110MM-125MM)	14
XDR165T	FLEXIBLE COUPLER (150MM-165MM)	14
XDR175T	FLEXIBLE COUPLER (150MM-175MM)	14
XDR200T	FLEXIBLE COUPLER (175-200MM)	14
XSB125T	SHEAR BAND COUPLINGS (100-125MM)	15
XSB120T	SHEAR BAND COUPLINGS (110-120MM)	15
XST65T	FLEXIBLE END CAP (50-65MM)	15
XST95T	FLEXIBLE END CAP (80-95MM)	15
XST115T	FLEXIBLE END CAP (100-115MM)	15

## Terrain Underground



### Polypipe Building Services

New Hythe Business Park

College Road

Aylesford

Kent

ME20 7PJ

United Kingdom

Tel: +44 (0)1622 795200

Fax: +44 (0)1622 716796

email: [commercialenquiries@polypipe.com](mailto:commercialenquiries@polypipe.com)

[www.polypipe.com/commercial-building-services](http://www.polypipe.com/commercial-building-services)

