



The perfect wall panel solution for Bathrooms and Showers.

Manufactured in Scotland, Selkie Board is backed by our comprehensive 10 year guarantee and is available 'off the shelf' from leading bathroom and plumbing suppliers throughout the UK.

REARO®

Rearo, Loanbank House, Loanbank Quadrant, Govan, Glasgow, G51 3HZ
 Tel: 0141 440 0800 Fax: 0141 445 3342 www.rearo.co.uk sales@rearo.co.uk

Rearo WASHINGTON

Unit 15, Tilley Road
 Crowther Industrial Estate
 Washington
 Tyne & Wear
 NE38 0AE
 T: 0191 482 2298
 F: 0191 482 6245
 E: washington@rearo.co.uk

Rearo NORTHAMPTON

5 Rye Hill Close
 Britannia Trade Park
 Northampton
 NN5 7UA
 T: 01604 212 559
 E: northampton@rearo.co.uk

Rearo SHETLAND

Staneyhill Gas Depot
 North Road
 Lerwick
 Shetland Isles
 ZE1 0QA
 T: 01595 692807
 F: 01595 695469
 E: lerwick@rearo.co.uk

Rearo ROSYTH

Unit 15 & 16 Primrose Lane
 Dunfermline Business Park
 Rosyth
 KY11 2RN
 T: 01383 414000
 F: 01383 414400
 E: rosyth@rearo.co.uk

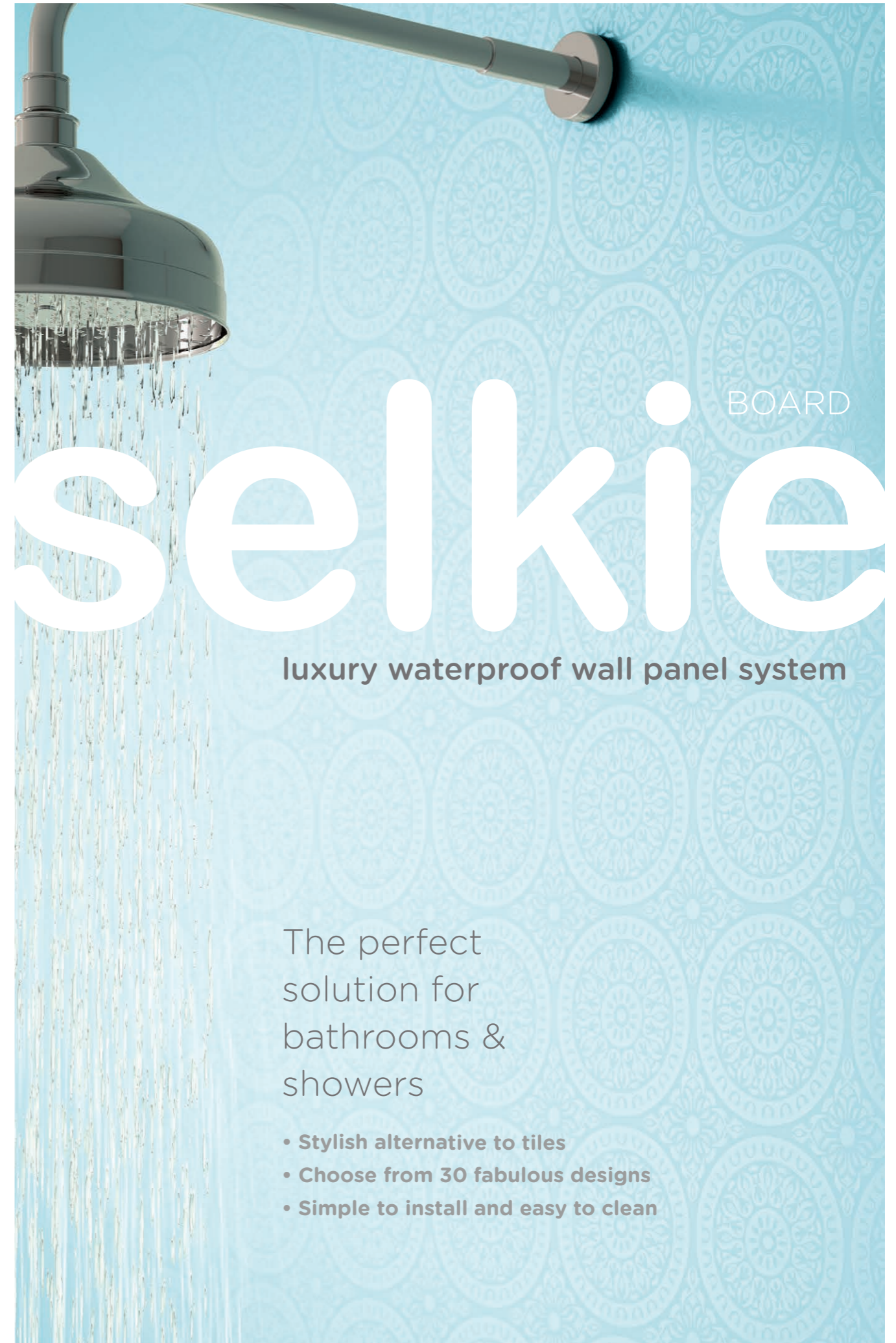

selkie

BOARD

luxury waterproof wall panel system

The perfect solution for bathrooms & showers

- Stylish alternative to tiles
- Choose from 30 fabulous designs
- Simple to install and easy to clean

luxury waterproof wall panel system

Our new range of 30 modern, innovative textures and decors will transform your bathroom or shower room with remarkable results. The latest Selkie Board collection consists of market leading 3D effects and the very latest colour palettes.

Offering a 'Straight over tiles' solution, Selkie is simple to install and easy to clean – the smooth surface ensures that mould and germs can not gather.



salmon wave

silver rain

2 panel enclosure

Manufactured in Scotland to the highest standards, each Selkie Board is backed by our comprehensive 10 year guarantee and is available 'off the shelf' from leading bathroom and plumbing supply merchants throughout the UK.

Choose from 30 modern, fashionable designs which are simple to install and easy to clean. There's no need for grouting and a quick wipe-down will have the Selkie board looking like new.

Pastel colours and textures create a simple but stunning space.

CREATING THIS ROOM

- 2x Selkie Boards
- 1x Internal Corner
- 2x End Caps
- 1x Panseal Kits
- 1x Clear Silicone
- 2x Panel Adhesive

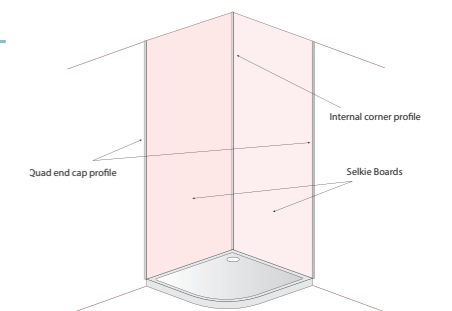

T&G edges must be removed to create a square edge prior to inserting panel into internal corner



Full Bathroom

Create a stylish, but practical family bathroom with striking colours and textures. Craft a fully waterproof wall with the use of Selkie's tongue & groove profile for a smooth overall finish.



CREATING THIS ROOM

- 12x Selkie Panels
- 12x Panel Adhesive
- 4x Silicone
- 1x External Corner
- 5x Internal Corner
- 2x Quad End Caps

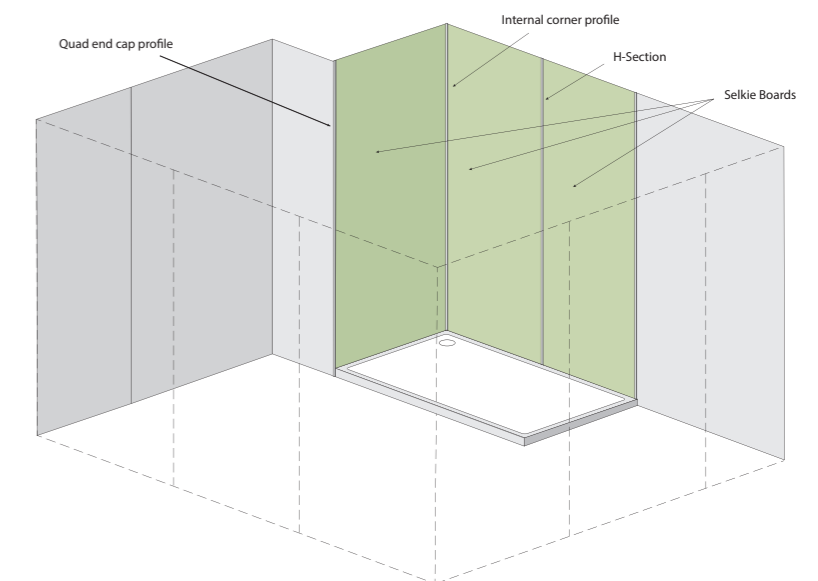

tropical green

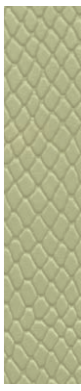

medusa beige

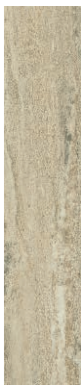

textured concrete





persian grey



Tongue & Groove

Put Selkie Boards at the heart of your design and the results are only limited by your imagination.

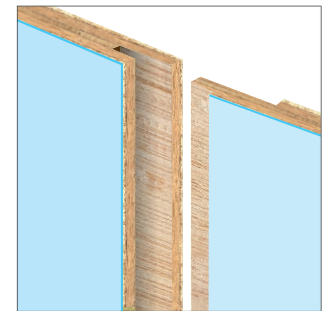

CREATING THIS ROOM

- 3x Selkie Boards (one square edge, two Tongue & Groove)
- 1x Internal Corner Joint
- 1x Colour Match Sealant
- 2x Quad End Caps
- 1x Clear Silicone
- 3x Panel Adhesive

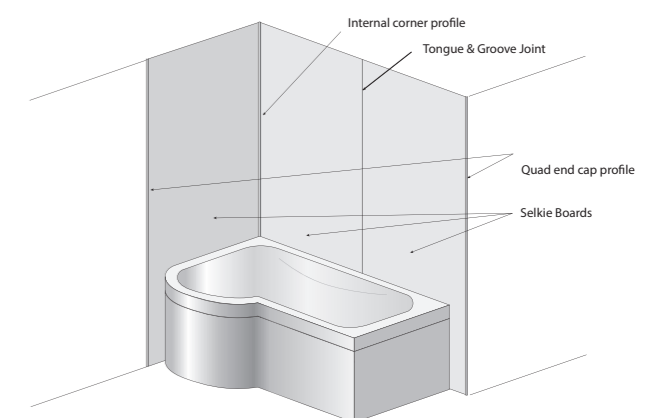

selkie colours

waterproof wall panel systems



With 30 decors across two ranges: Urban & Signature, the SELKIE board collection offers a simple, modern solution for your bathroom or shower cubicle. All stocked boards have a solid 9mm core made from Moisture Resistant (MR) MDF and are supplied Tongue & Grooved as standard.*



Signature Collection



Structured White
Textured
1020 CW



Salmon Wave
Textured
1007 WH



Tropical Green
Textured
1025 ER



Raindrop
Textured
192 CP



Lemon Grass
Textured
1054 CC



Oyster Pixel
Textured
8003 WW

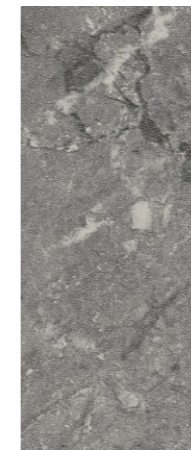

Persian Grey
Gloss
54057



Sorrento Stone
Gloss
Lavante 40



Carrera Marble
Satin
3460



Textured Concrete
Textured
JK583

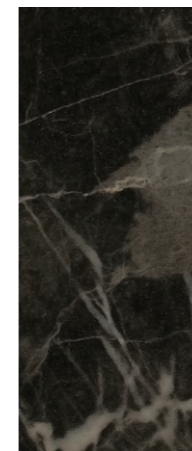

Sepia Marble
Gloss
Mai 712



Lava Grey
Textured
LA 437



Medusa Beige
Textured
M372



Luna Marble
Textured
SL225

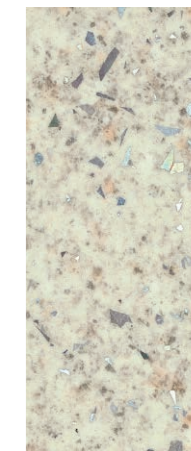

Desert Shimmer
Gloss
S022



Graphite Sparkle
Gloss
D074



Silver Rain
Textured
4539



Travertine Rain
Textured
4540



Linea Grey
Textured
7530FN

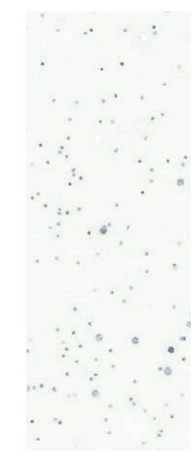

Rocca White
Textured
M001

Urban Collection

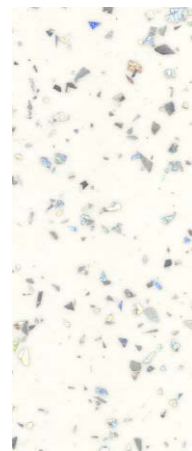

Snow Shimmer
Gloss
8002

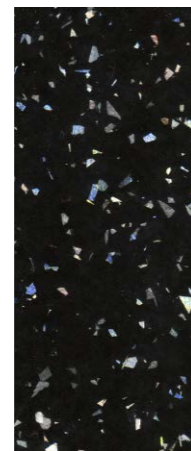

Moonlight Shimmer
Gloss
8142

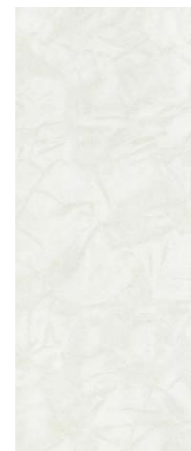

Frosty Ice
Gloss
0015



White Gloss
Gloss
8001



Iranian Travertine
Gloss
3526



Winter Cloud
Gloss
IS1



Summer Cloud
Gloss
IR8



Cream Pearl
Gloss
5637



Silver Pearlescent
Gloss
7480



German Chalk
Matt
1430

*When using T&G panels our range of Selkie Topseal Colour Match should be used on all joints.

Note that on certain decors there can be a variance in pattern alignment due to the printing process, please make reference to our Décor Disclaimer document prior to purchase.



UK MANUFACTURING

Manufactured in Glasgow within a modern 60,000 sq ft factory,

Selkie Board utilises the very latest laminate fabrication technology, including advanced CNC machinery.

The combination of skills, experience and the investment in the latest equipment ensures that every Selkie Board is made to the highest standards possible within our 60,000 sq ft Glasgow factory. Our dedicated fulfilment centre allows us to make sure that all items are always in stock – ready for a speedy delivery direct to your door.

We strive for quality and safety during all aspects of manufacture and we have ISO accreditations for Health & Safety, Quality Management and Environmental Management.



Easy to install

Installation is quick and easy, saving time and money in comparison to traditional methods. Corner profiles, end caps, shower tray seals and Selkie Topseal Colour Match sealant (when using 'tongue and groove' joints for the perfect finish) are all available.



The range of Selkie® silicone is available in clear and white, together with Selkie 'GRIP ALL' adhesive.

Selkie® Board can be supplied complete with a range of required finishing trims; internal corner, external corner, end cap, quad end cap. All profiles are available in satin aluminium, polished silver, black or white finishes.

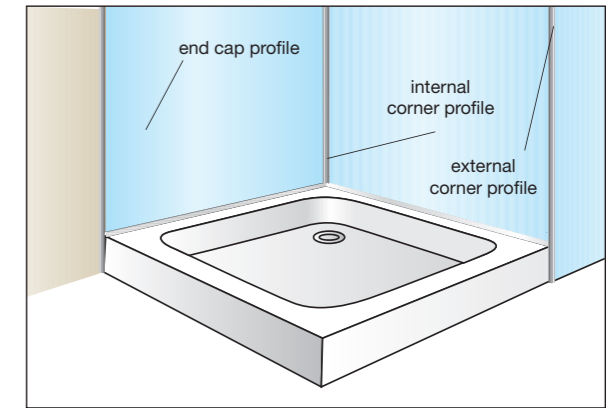

Typical Corner Sited Installation

Tongue & Groove



Tongue & groove joining is used where a tight, solid seam is required between separate Selkie® Boards. It provides an exceptionally accurate finish and with the correct use of sealant provides a water-tight joint. The tongue & groove process reduces the panel face width to approx. 1180mm.

HOW IT WORKS

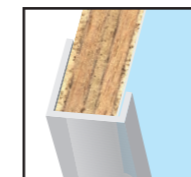

End cap

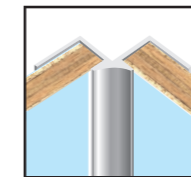

Internal corner profile

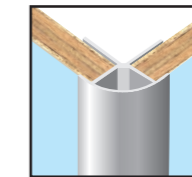

External corner profile

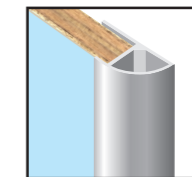

Quad end cap profile

Technical Specification

Height	2420mm
Width	1200mm (face size) or 1180mm when T&G
Thickness	11mm
Core Substrate	Water and Boil Proof (WBP) 9mm Plywood or MR-MDF available to order
Colours	Standard range of 30 decors Custom colours can be manufactured on request
Joining	Stocked as Square Edge panels or Tongued and Grooved
Fire Rating	Class 2 surface spread of flame as standard BS476 Part 7 Can be tailored for Class 1 or Class 0
Resistance to water	PUR Hotmelt adhesive conforms to D4 moisture resistance

A full technical installation guide is available from www.rearo.co.uk
Guarantee subject to compliance with recommended installation instructions



Terrazzo Stone
Matte

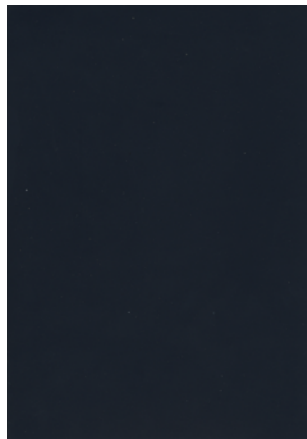

Dusk
Matte



Gransasso
Matte



Bamboo
Matte



Eclipse Grey
Matte



Cappuccino
Gloss

BOARD
selkie
six fresh new décors for 2020

The biggest trends of 2020 are technology, spa bathrooms and connecting with nature.

Our six new Selkie décors carefully reflect all of the above themes while also sitting harmoniously with our current range.

Using complementary pantone shades and feature walls, these new 2020 décors consider the full bathroom and take our Selkie panels beyond just the shower area.



selkie BOARD

INSTALLATION GUIDE

DOMESTIC 2 OR 3 SIDED SHOWER INSTALLATION

Please carefully read the following information to ensure that you do not invalidate your 10 year guarantee.

Selkie Board Installation Guide

Getting Started

Tools

We recommend that the following tools are available prior to installation.

- Pencil & Ruler • Measuring Tape
- Jig saw or Hand saw • Masking Tape
- High-grab adhesive • Silicone Sealant

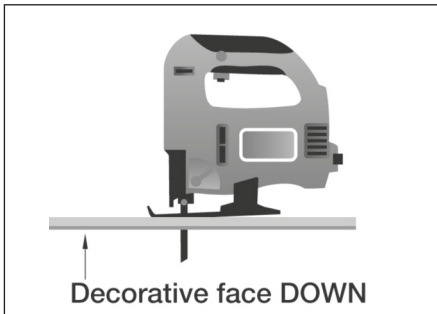

Fig1.

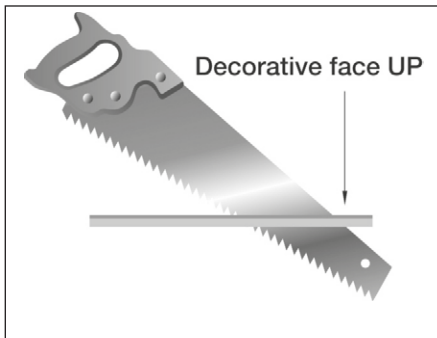

Fig2.

Wall preparation

It is essential that walls should be completely dry before installing Selkie and any source of dampness is treated. Wherever possible, remove existing wall coverings such as wall paper and fabrics. Assuming walls are reasonably level/flat then there is no need to make good the surface to be covered.

Cutting of Panels

When using a jig-saw with upward cutting jig-saw blade (fig 1), panels should be cut from the back, decorative face down to prevent chipping of the laminate surface. When using a standard hand saw (fig 2) - decorative face should be UP.

For the best results - where possible apply masking tape along the line of cut.

Cutting Apertures

Although Selkie Board has a highly durable finish, care should be taken when cutting apertures or inspection hatches.

Internal corners of apertures and cut outs MUST always be smoothly radiused to as large as possible, with a 5mm minimum radius. This radius should be increased as the side lengths of the aperture are increased.

Ensure that wooden blocks are placed below your drilling areas to prevent 'burst out' and any possible damage to the decorative face.

Mark out cutting shape to rear face and drill positions on front ensuring one at each corner.

Drill holes at suitable intervals around perimeter of shape on front face (fig 3).

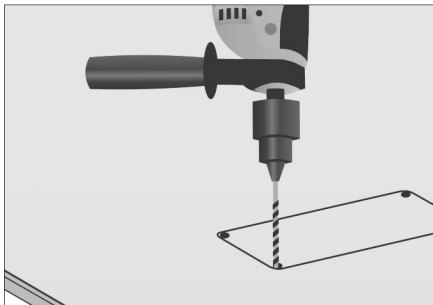

Fig3.

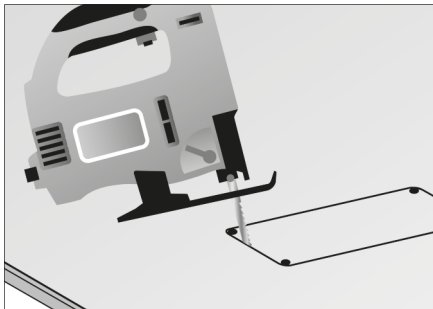

Fig4.

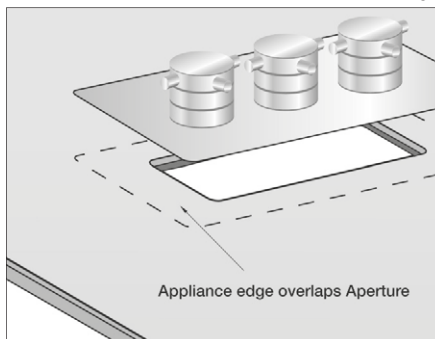

Fig5.

Leave a 3mm clearance around all pipes and accessories and seal with silicone sealant.

Using jigsaw, slowly cut around perimeter of shape of cut out on rear face (fig 4).

When using a circular saw or fine-tooth blade hand-saw, panels should be cut decorative face up, with the protective film removed from the cutting line only.

Ensure that your fitting overlaps the aperture cut-out. (fig 5).

When measuring distance from walls, or past shower enclosures, allowances should be made for the thickness of aluminium profiles and the space between walls and profiles.



BY REARO

selkie waterproof wall cladding system is quick and easy to install

2 Sided Shower Enclosure

(a) Position shower tray, level and fix in accordance with the manufacturer's instructions (fig 6)

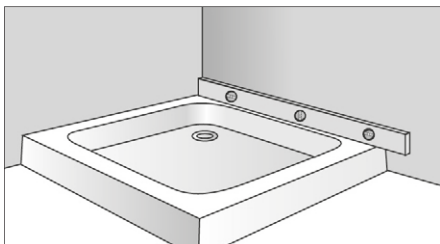

Fig6.

(b) Begin by securely screw fixing the internal corner profile extrusion in the required position (fig 7), ensuring that it is plumb in both directions.

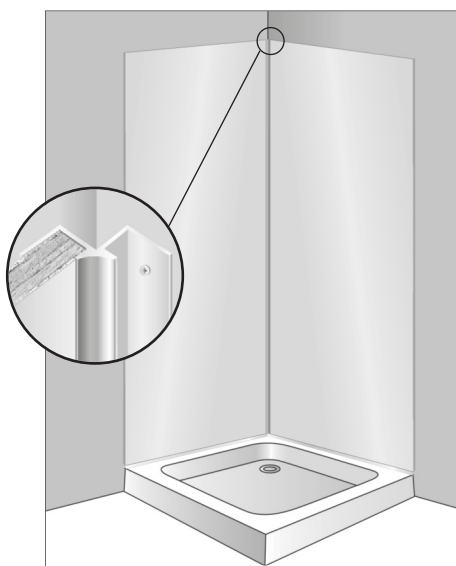

Fig7.

(c) Before measuring the correct height and width of the panel please remove the tongue and groove to create a square edge finish, this will ensure a water tight fit. Please Note: Peel back the protective film at this stage by approx. 50mm to accommodate fitting. After cutting - we recommend a "dry fit" (before applying adhesive or Silicon Sealant) of the Selkie Board to ensure correct fitting



Fig8.

(d) Apply a generous bead of silicone sealant into the channel of the corner profile section (fig 8).

(e) If applying an 'end cap' (fig 9) apply a generous bead of sealant along the length of the 'end cap', then fix into position by applying hand pressure across the full area of the panel.

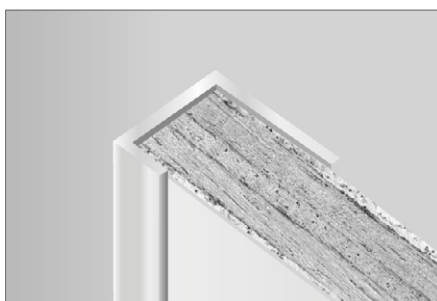

Fig9.

Please note: take care not to apply excessive silicone to channels in profiles

(f) Apply a bead of panel adhesive around the perimeter on the back surface of the panel along with a grid (approx 300mm squares) covering the full area of the panel (fig 10).

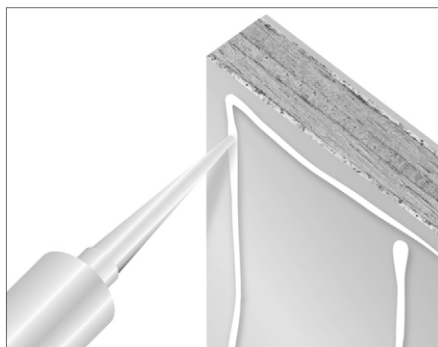

Fig10.

(g) The Selkie Board should be fitted to be positioned just above the shower tray. Using 'packers', leave a 3-4 mm gap from the base of the Selkie board to the top edge of the shower tray.



Fig11

(h) Ease the panel into the corner profile and fit panel onto wall (fig 11).

(i) When the adhesive has set and the Selkie Board securely in position remove the 'packers'.

(j) Fill the gap between the tray and the panel with silicone so the panel is effectively sitting on a "bed" of sealant.

(k) Run bead of silicone to face of gap ensuring a neat smooth "perfect" finish

(l) Repeat the same process on the adjacent panel.

(m) Remove the remainder of the protective film to complete the installation (fig12)'.

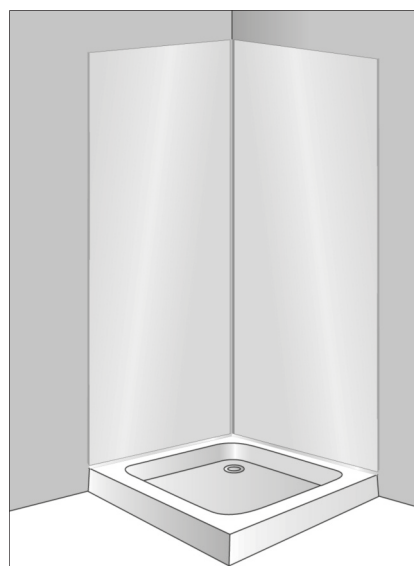

Fig12.

3 Sided Shower Enclosure

When installing three Selkie Boards in a 'U' shape formation - follow the above guidelines, however ensure that the second internal corner profile is fitted to 'panel 2' - middle panel, prior to fixing to 'wall and before 'installing panel 3' (fig 13).

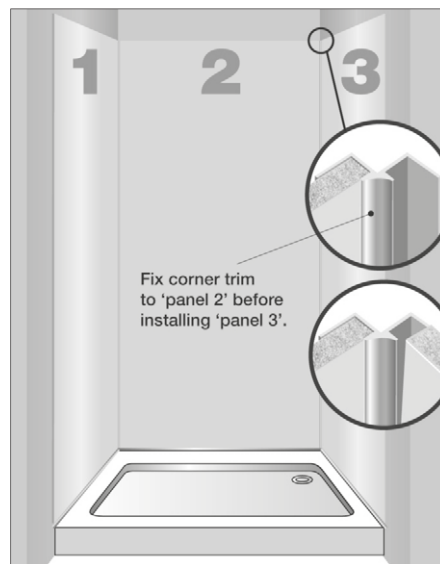

Fig13.

It is always wise to dry fit first to ensure a good fit.

Accessories and Sealants

Important accessories to help with a successful installation of Selkie Board include:

Finishing Trims: designed specifically for Selkie Board are available in satin silver, polished chrome, white and black including:- Internal Corner Profile, External Corner Profile, End Cap, Quad End cap and 'H' section, for vertical application in heights above 2400mm height.

Sealants and Adhesives: For best results we recommend that Selkie Board is installed using an external grade 'high grab adhesive' such as GRIP FILL. This will quickly secure the Selkie Board to the fixed wall. For sealing of all profiles and trims we recommend the use of a clear silicone waterproof sealant.

If you are panelling an entire wall using tongue and grooved* panels, we recommend the use of Rearo colour matched sealant for a seamless finish.

*Please see *Tongue and Grooved installation guide*.

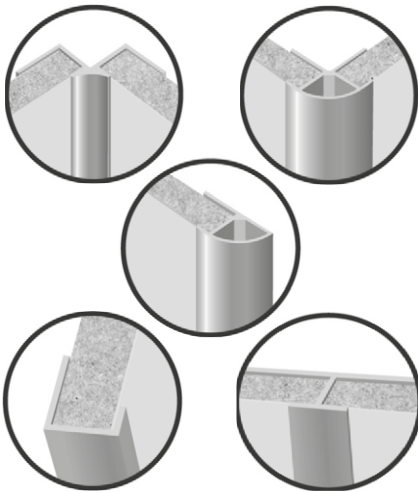

Cleaning

Once installed, Selkie Board requires minimal maintenance. Selkie Board should be cleaned with warm water and a nonabrasive mild detergent.

Scouring products or similar products should not be used, and doing so may invalidate your warranty.



Panseal Kit

Where it is identified that there may be a risk of movement such as a flexible floor or the possibility of settlement it may be appropriate to use a system such as "Panseal". The Panseal kit ensures that the joint between the bottom of the Selkie Board and the top of the shower tray is secure and watertight. (fig 14)

Please see fitting instructions supplied with kit.

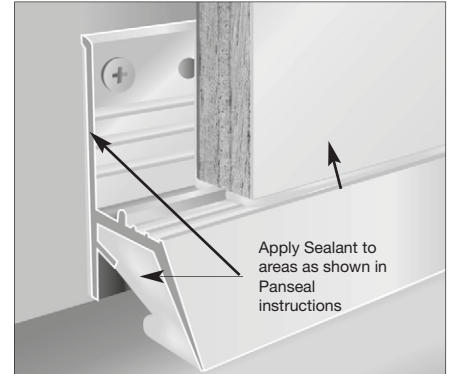

Fig14.

Please be aware that these instructions are not exhaustive, if you require further information, advice or are in any doubt as to how to proceed please contact the Rearo technical team on 0141 440 0800.

Please also note that for all installations there are some general, simple guidelines which must be followed without which our warranty would be invalidated including:

- all exposed edges of panels must be sealed.
- panels should never be fitted directly onto a shower tray without adequate sealing. Please see instructions.

FURTHER INFORMATION

For further information please contact your local rearo service centre, where our experienced team can offer further advice regarding installation or maintenance.

REARO®

Rearo, Loanbank House, Loanbank Quadrant, Govan, Glasgow, G51 3HZ
Tel: 0141 440 0800 Fax: 0141 445 3342 www.rearo.co.uk sales@rearo.co.uk

Rearo SHETLAND

Staneyhill Gas Depot
 North Road
 Lerwick
 Shetland Isles
 ZE1 0QA

T: 01595 692807

F: 01595 695469

E: lerwick@rearo.co.uk

Rearo NORTHAMPTON

5 Rye Hill Close
 Britannia Trade Park,
 Northampton
 NN5 7UA

T: 01604 212559

F:

E: northampton@rearo.co.uk

Rearo ROSYTH

Unit 15 & 16 Primrose Lane
 Dunfermline Business Park
 Rosyth
 KY11 2RN

T: 01383 414000

F: 01383 414400

E: rosyth@rearo.co.uk

Rearo WASHINGTON

Unit 15, Tilley Road
 Crowther Industrial Estate
 Washington
 Tyne & Wear NE38 0AE

T: 0191 482 2298

F: 0191 482 6245

E: washington@rearo.co.uk



TONGUE & GROOVE INSTALLATION

selkie BOARD

INSTALLATION GUIDE

TONGUE & GROOVE INSTALLATION

Please carefully read the following information to ensure that you do not invalidate your 15 year warranty.

Selkie Board Tongue & groove

Larger Room or Commercial Installation

Tools

We recommend that the following tools are available prior to installation.

- Pencil & Ruler
- Measuring Tape
- Jig saw or Hand saw
- Masking Tape
- High-grab adhesive
- Silicone Sealant



Fig1.

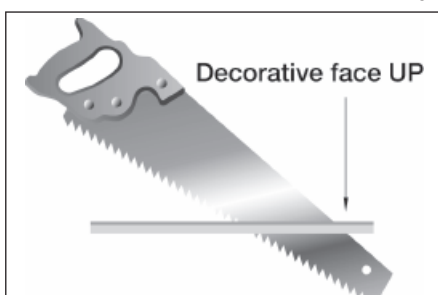

Fig2.

Wall preparation

It is essential that walls should be completely dry before installing Selkie and any source of dampness is treated. Wherever possible, remove existing wall coverings such as wall paper and fabrics. There is no need to make good the surface to be covered.

Groundwork

Rearo do not recommend direct fixing of tongue & groove boards to masonry, cement or plastered surfaces, however flat and well finished.

The best results for Selkie™ "Tongue and Groove" are achieved by securely fixing a groundwork of horizontal timber battens

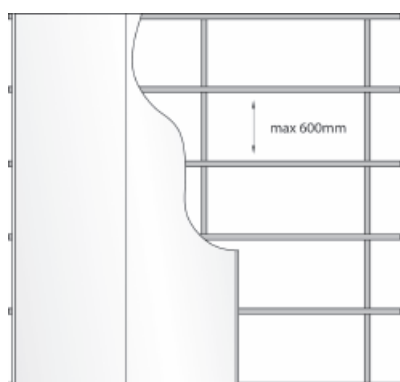

Fig3.

e.g. 25mm x 50mm (rot proofed if required) at maximum 600mm centres, packed out to a true, flat and plumb surface. Always ensure a batten is placed at the extreme top and bottom of the panels. Vertical panels will be necessary around windows and doors. Additional battens must be used where heavy items such as cabinetry and sanitary-ware are to be fixed.

Cutting of Panels

When using a jig-saw (with upward cutting jig-saw blade), panels should be cut from the back, decorative face down (Fig1) to prevent chipping of the laminate surface. When using a standard hand saw - decorative face should be UP (Fig 2).

For the best results - where possible apply masking tape along the line of cut.

Cutting Apertures

Although Selkie Board has a highly durable finish, care should be taken when cutting apertures or inspection hatches.

Internal corners of apertures and cut outs MUST always be smoothly radiused to as large as possible, with a 5mm minimum radius. This radius should be increased as the side lengths of the aperture are increased. (Fig 4)

Ensure that wooden blocks are placed below your drilling areas to prevent 'burst out' and any possible damage to the decorative face.

Mark out cutting shape to rear face and drill positions on front ensuring one at each corner.

Drill holes at suitable intervals around perimeter of shape on front face.

Leave a 3mm clearance around all pipes and accessories and seal with silicone sealant.

Using jigsaw, slowly cut around perimeter of shape on rear face, taking care to retain the radius in the corners.

Ensure that your fitting overlaps the aperture cut-out. (fig 6)

When using a circular saw or fine-tooth blade hand-saw, panels should be cut decorative face up, with the protective film removed from the cutting line only

When measuring distance from walls, or past shower enclosures, allowances should be made for the thickness of aluminium profiles and the space between walls and profiles.



selkie waterproof wall cladding system is quick and easy to install

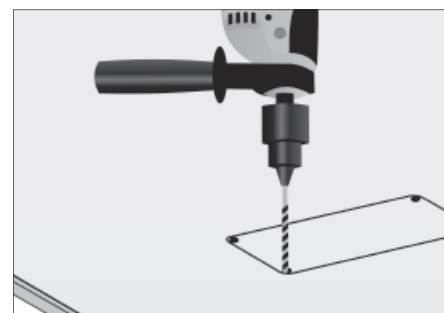

Fig4.

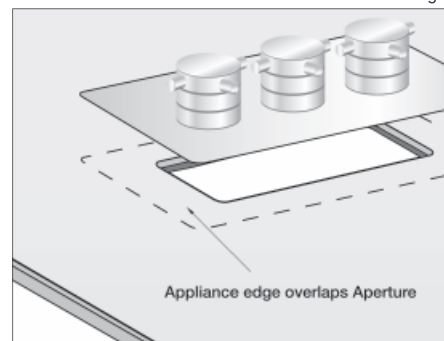

Fig5.

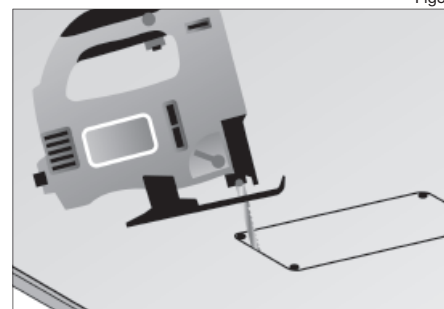
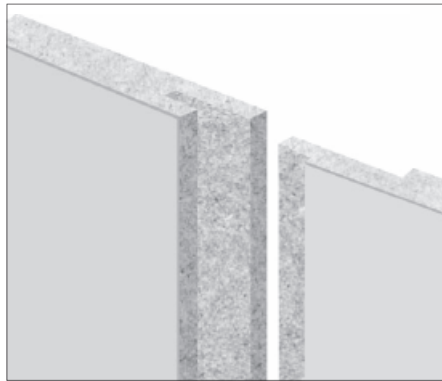

Fig6.

Installation for a 2 or 3 sided shower enclosure

For larger installations Selkie Board may be supplied as a Tongue and Groove option - this is often a more practical option and together with colour matched sealant results in a professional installation. (fig 7)



Plan the room

Start in the corner furthest from the door, fix Selkie™ panels with 3/4" x No. 6 wood screws through the back shoulder of the groove (ensure that screw heads do not obstruct the tongue of the next panel, insert the tongue of the next panel into the groove and fix as before.(Fig 8)

Fixing tongue and groove panels

Tongue and groove panels should be dry jointed prior to final installation to ensure a sufficiently flush and tight joint will be achieved between all panels and also to ensure colour consistency between panels.

Screws should be at 400 – 600mm centres with the bottom screw a maximum of 35mm from the bottom edge of the panel.

Panels should always be screwed to the horizontal timber battens to ensure a smooth surface at maximum 600mm centres.(Fig 9)



Fig9.

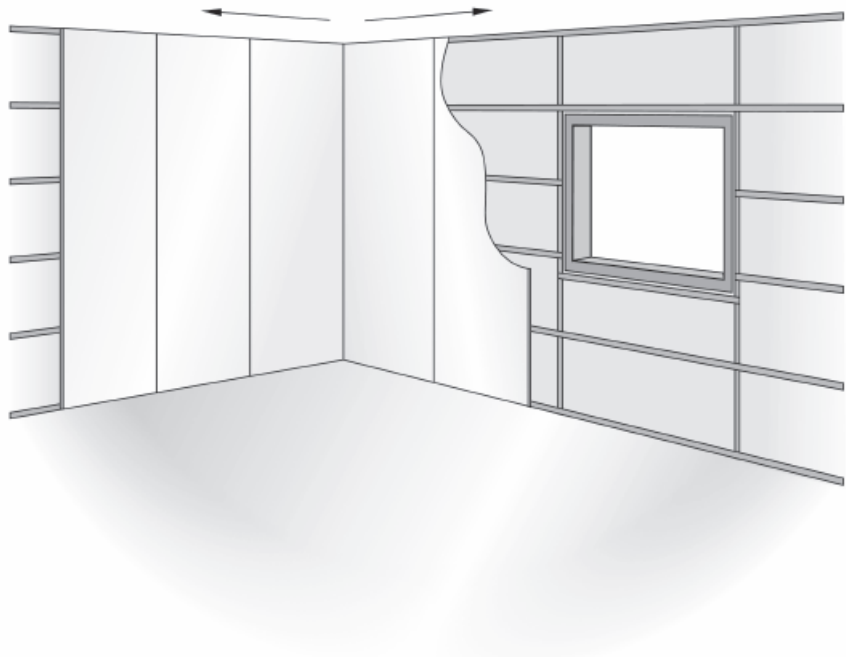

Fig8.

Around the Room

Continue to work around the room, apply a ribbon of colour match sealant onto the long shoulder of the tongue of the next panel to be inserted. Insert the edge of the next panel. Again fix the panels into place through the back of the groove.

Cut the last panel of this wall section to size, fit corner profile to panel and swing panel into position. Screw fix profile along the free edge, again continue installing the panels, as before.

For the last panel above the door, cut to size from the groove edge leaving the tongue intact. Rebate the back edge and insert the tongue into the groove (fig 6). Fix the rebated edge to the battens with panel adhesive.

Internal corners. (Fig 10)

First fix an internal corner profile in position ensuring that it is plumb. Cut off tongue edge to be fixed into profile, apply sealant along profile recess.

Please note: take care not to apply excessive silicone to channels in profiles

Insert the cut edge of the panel (fig 4).

Using a 3/4 No6 screw, fix the opposite edge to the batten through the back of the groove.

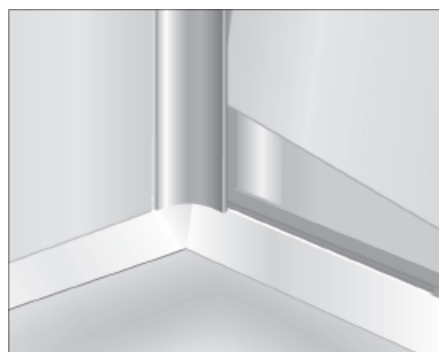

Fig10.

External corners (Fig 11)

Cut panel to size.

Locate edge profile on square edge and place panel into position (fig 7).

Fix using 3/4 No6 screws through exposed profile section tongue. A few dabs of sealant applied to the battens will help secure the panel.

Trim tongue of next panel, insert into profile and continue to fix as normal.

The external corner profile can (when required) also be used around window sills.

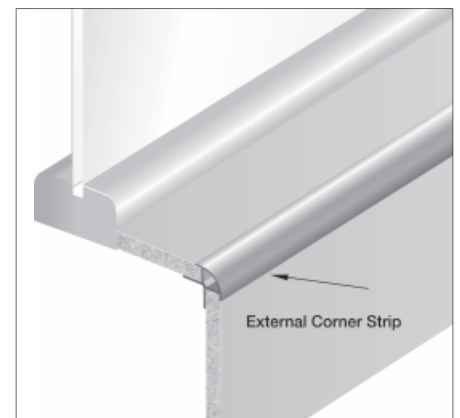

Fig11.

Use of an "L section" or an end cap profile is preferred if a profile is required around the entire windows recess.

If cutting an external corner for use around window frames a 'packing piece' should be used.

Colour Match Sealant

Selkie colour matched sealant will enhance your installation and provide a sanitary quality waterproof and flexible seal that will not crack.

- Ensure that surfaces are clean, dry and grease free
- Apply a thin bead onto tongue (see illustration)
- Bring the two panels together and apply pressure until the joint is closed
- A small bead of sealant will squeeze out of the joint, which should be allowed to dry for 10-15 minutes
- Clean off remaining adhesive by wiping across the joint with a damp cloth. (If the adhesive is allowed to dry a strong solvent will be required).

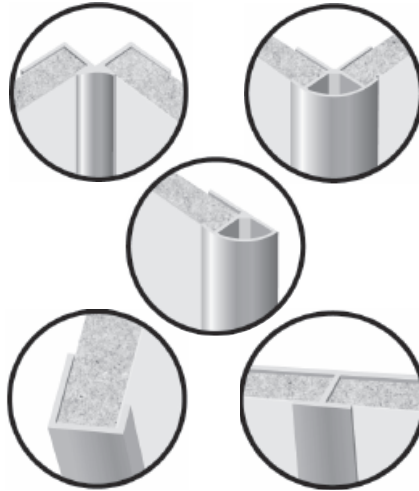
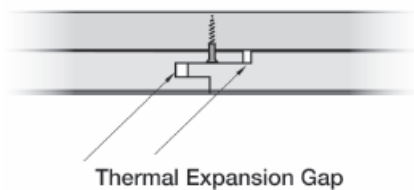
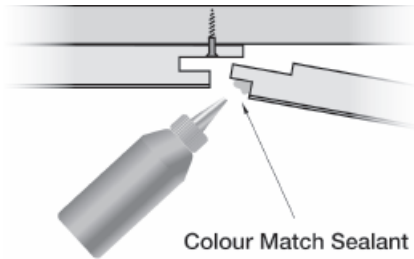

Once installed, Selkie Board requires minimal maintenance. Selkie Board should be cleaned with warm water and a non-abrasive mild detergent.

Scouring products or similar products should not be used, and doing so may invalidate your warranty.



Finishing Trims

Selkie Tongue & Groove panels can be supplied complete with a range of required finishing trims – Internal corner, External corner, End cap, 'H' section & 'L' section

All profiles are available in satin silver, polished silver, black and white finishes.

Cleaning



Please be aware that these instructions are not exhaustive, if you require further information, advice or are in any doubt as to how to proceed please contact the Rearo technical team on 0141 440 0800.

Please also note that for all installations there are some general, simple guidelines which must be followed without which our warranty would be invalidated including:

- all exposed edges of panels must be sealed.
- panels should never be fitted directly onto a shower tray without adequate sealing. Please see instructions.

Note: It is always wise to dry fit first to ensure a good fit.

FURTHER INFORMATION

For further information please contact your local rearo service centre, where our experienced team can offer further advice regarding installation or maintenance.

REARO®

Rearo, Loanbank House, Loanbank Quadrant, Govan, Glasgow, G51 3HZ
Tel: 0141 440 0800 Fax: 0141 445 3342 www.rearo.co.uk sales@rearo.co.uk

Rearo SHETLAND
Staneyhill Gas Depot
North Road
Lerwick
Shetland Isles
ZE1 0QA
T: 01595 692807
F: 01595 695469
E: lerwick@rearo.co.uk

Rearo NORTHAMPTON
5 Rye Hill Close
Britannia Trade Park,
Northampton
NN5 7UA
T: 01604 212559
F:
E: northampton@rearo.co.uk

Rearo ROSYTH
Unit 15 & 16 Primrose Lane
Dunfermline Business Park
Rosyth
KY11 2RN
T: 01383 414000
F: 01383 414400
E: rosyth@rearo.co.uk

Rearo WASHINGTON
Unit 15, Tilley Road
Crowther Industrial Estate
Washington
Tyne & Wear NE38 0AE
T: 0191 482 2298
F: 0191 482 6245
E: washington@rearo.co.uk