

EMMETI

ZONATM

COMFORTABLE HOMES
THE SMART WAY



Operating Instructions

Contents

Getting to Know your ZONA Thermostat	3
Turning your ZONA ON/OFF	3
Setting the Time and Date	3
Programming Modes	3
To Select the Programming Mode	4
Programming Logic	4
To Enter the Programme Parameters	4
Manual Override	5
Locking and Unlocking your ZONA	5
Advanced Settings List	5
Advanced Settings	5
Connecting your ZONA to the ZONA App	6
Creating an Account by Email or Phone	6
Once you have Created an Account	7
Creating a Family on the ZONA App	7
Connecting your ZONA Thermostat(s) to the App	7 & 8
Entering the Programme Parameters on the App	9
Locking/Unlocking the Thermostat via the App	10
Turning the Thermostat OFF/ON via the App	10
Advanced Modes	11
Wiring Diagram	12



Getting to know your ZONA Thermostat

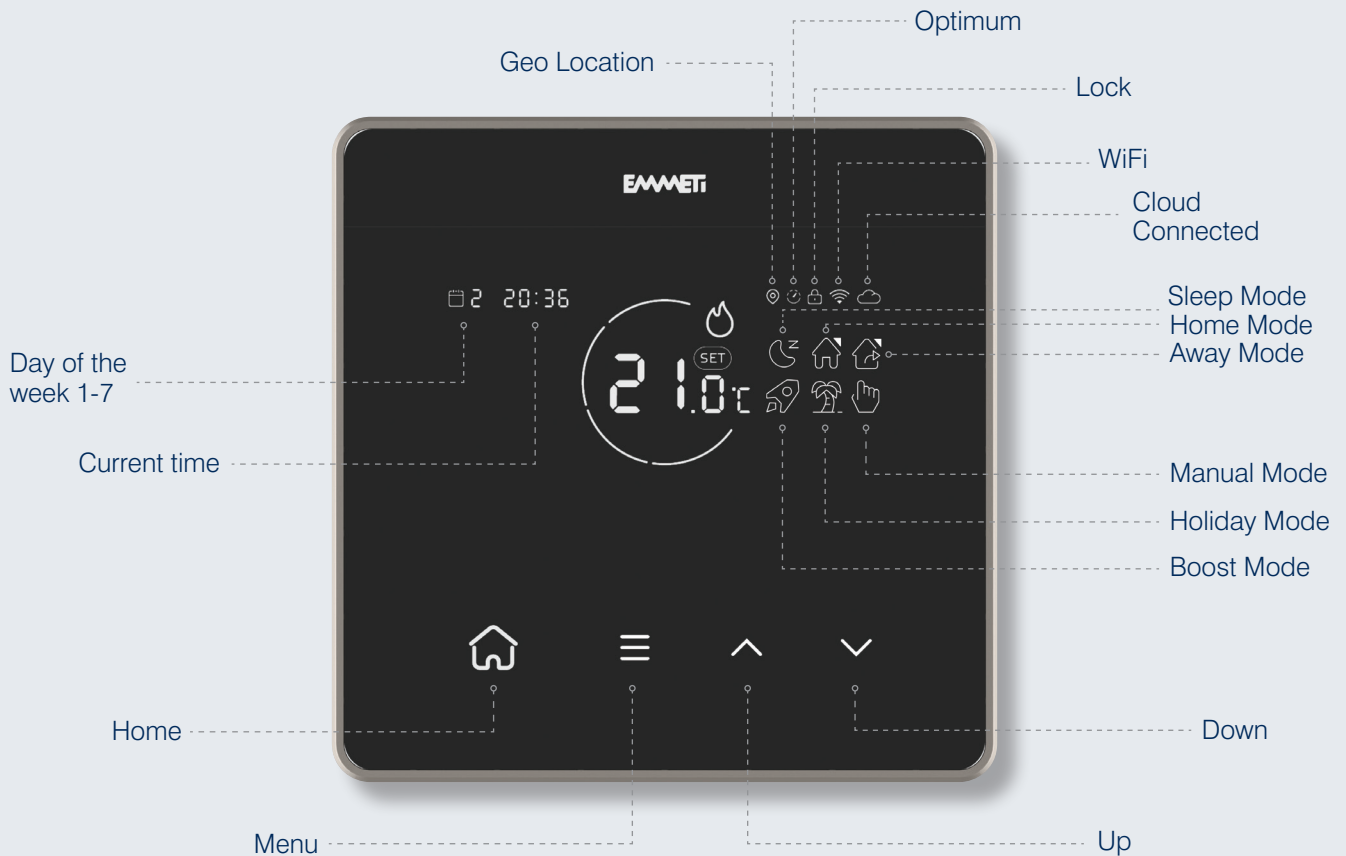

Turning your ZONA ON/OFF

While OFF, your ZONA will not perform any of its functions.

PLEASE NOTE: Low Temperature Protection (Frost Protection) will also be inactive.

Hold  for 3 seconds to turn the ZONA on or off.

Setting the Time and Date

Hold  for 3 seconds.

The format for entering the date is YY/MM/DD.

Use  &  to change the Year, and  to confirm and move to the Month.

Repeat these steps to set the Date, Day, and the Time, then press  to finish setting and return to the main display.

Programming Modes



7 Day (07) – This mode allows you to programme all 7 days of the week individually.

5 Day & 2 Day (52) – This mode allows you to programme Monday to Friday, and Saturday to Sunday individually.

24hr (24) – This mode allows you to create a single programme which will repeat on a daily basis.

To Select the Programming Mode

Hold  &  together for 3 seconds to enter the programming function.

Using the  & , select the required Programming Mode.

Use  to confirm your selection.

Programming Logic

When programming this thermostat you will be asked to enter a time and then the temperature you require at that time. You can set 4 time/temperature switches through a single day.

E.g. 07:00 & 22°C > 10:00 & 18°C > 15:00 & 22°C > 22:00 & 18°C

With these temperature settings, the heating will be increased to 22°C by 07:00 and maintain that temperature until 10:00 when the temperature requirement will switch to 18°C. This new temperature will be maintained until 22°C is required at 15:00, 22°C will be maintained until 22:00 when only 18°C is required. This last time setting will maintain the specified temperature until 07:00 the next morning*.

*Description simplified for clarity. Building, heat up & cool down rates are not explained here, and will vary according to various external parameters.

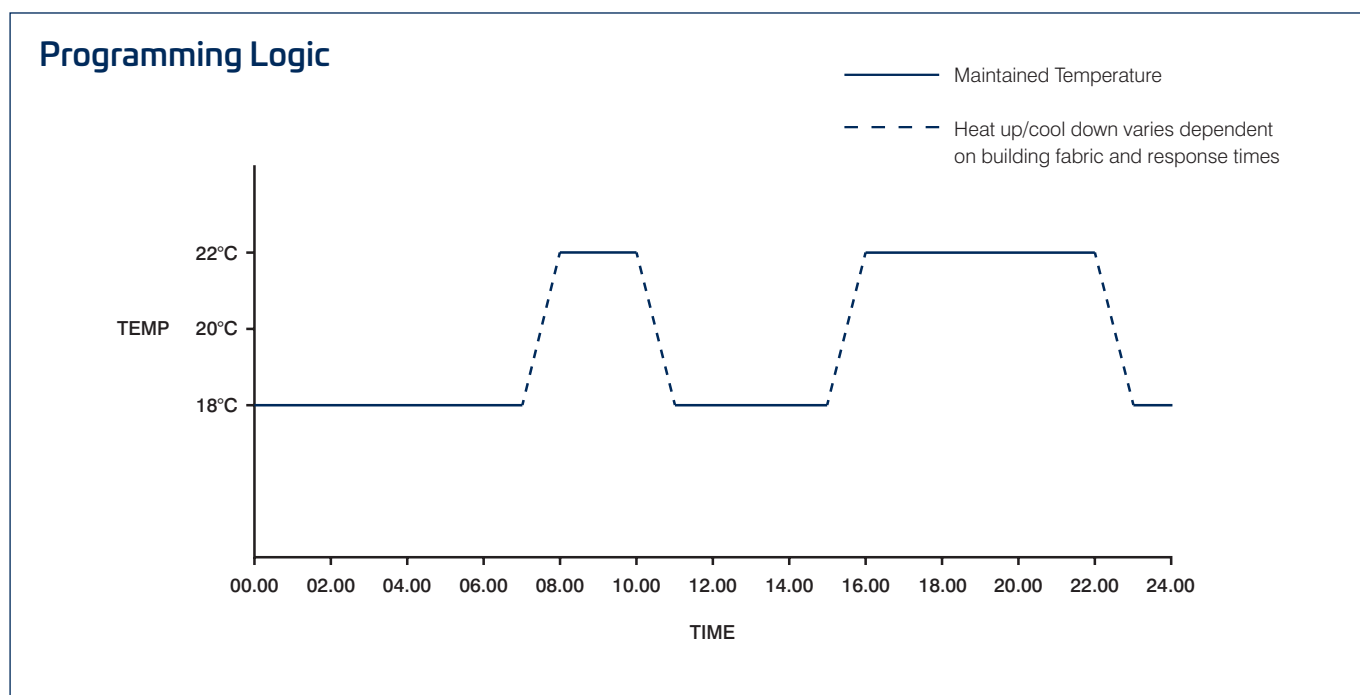

To Enter the Programme Parameters

Hold  &  together for 3 seconds to enter the programming function.

Use  to confirm your selection.



The time display will be flashing – use  &  to change the hours and press  to confirm. Repeat for the minutes.

The temperature display will now be flashing – use  &  to select the desired temperature and press  to confirm.

Repeat these steps for the remainder of that day, then as necessary depending on your programming mode after that.

Manual Override

Manual Override allows you to set a temperature (higher or lower) than the current room temperature by interrupting the current programme. This new temperature will be maintained until the Manual Override is turned off.

From the main display, briefly press either  or , the Manual symbol  will appear and the temperature can then be changed to the desired temperature.

Press  to confirm your selection.

To cancel Manual Override press . The Manual Override will be removed, press  to return to the main display.

The ZONA will resume the previously set programme.



Locking and Unlocking your ZONA

Locking the ZONA disables all the functions of the buttons and shows the small padlock symbol in the top right of the display.

Hold  &  together for 3 seconds. The padlock symbol will appear, indicating that the ZONA has been locked.

Repeat these steps to unlock the ZONA.

Advanced Settings List

- 1. Boost Setting** - Hours and Target Temperature 5-35°C
- 2. Holiday Setting** - Days and Target Temperature 5-35°C
- 3. Sensor Type** - 00 Inner Sensor, 01 External Sensor, 02 Inner & External Sensor, Default 00
- 4. High Temperature Protection** - 35-90°C, Default 90°C
- 5. Low Temperature Protection (Frost Protection)** - 0-10°C, Default 5°C
- 6. Swing** - 1-9°C, Default 1°C
- 7. Temperature Calibration ADJ** - $\pm 9^\circ\text{C}$, Default 0°C
- 8. Highest Target Temperature** - 35-90°C, Default 35°C
- 9. Lowest Target Temperature** - 0-30°C, Default 5°C
- 10. Home Mode** - Temperature Setting 5-25°C, Default 22°C
- 11. Away Mode** - Temperature Setting 5-25°C, Default 15°C
- 12. Sleep Mode** - Temperature Setting 5-25°C, Default 18°C
- 13. Restart Thermostat / Reset Thermostat** -
 - a. Screen shows '— —'
 - b. Press  or  and the screen will change to '== ='
 - c. Wait 10 seconds or press  button to confirm setting

Advanced Settings

From here you can access the Advanced Settings for your ZONA. These settings will allow you to personalise the way your ZONA works.

To access the Advanced Setting Menu:

Hold  &  together for 3 seconds.

Use  to switch between the Advanced Settings. Use  &  to make changes to the chosen Advanced Setting.

Once you have finished altering the Advanced Settings, press  to confirm changes and return to the main display.

Connecting your ZONA to the ZONA App

 Search your App Store for EMMETI ZONA and download

Creating an Account by Email, or Phone

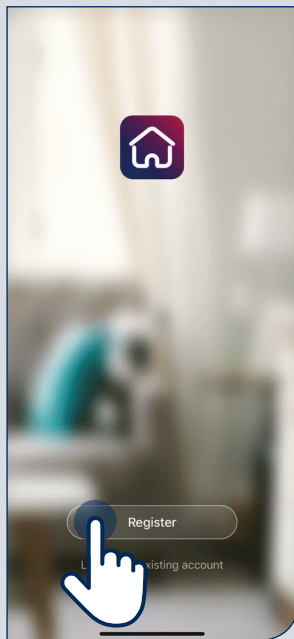

If you are setting up the App for the first time you will need to register your details.

After registering you can simply log in with these details, should you log out from the App.

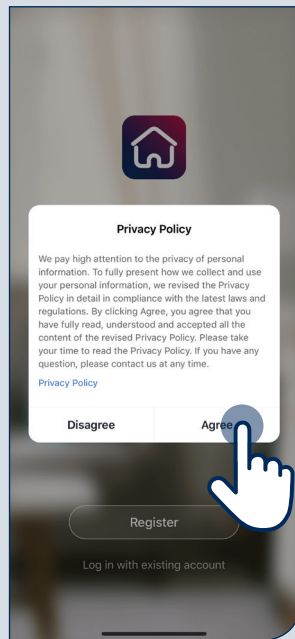

Accept the Privacy Policy to proceed.

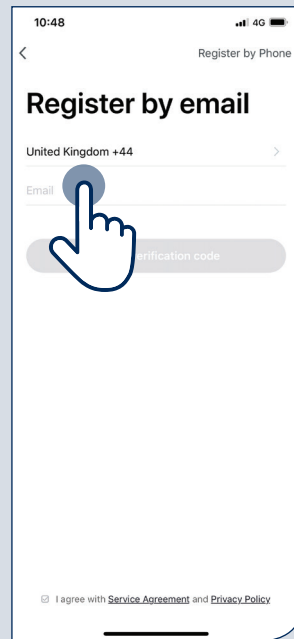

Enter a valid email address as confirmation is required.

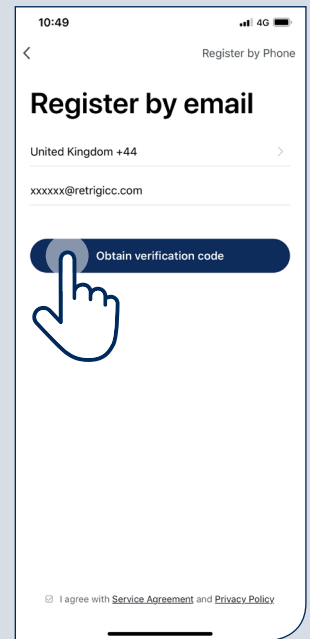

A unique code will be sent to your email address which you will then enter on the following screen.

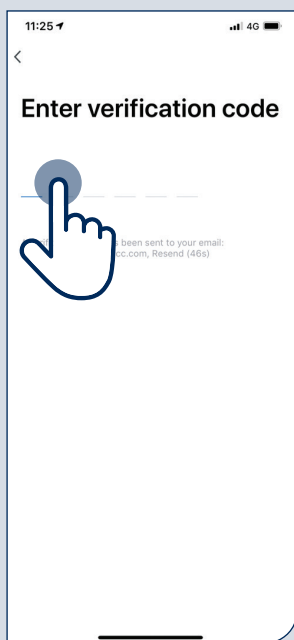

Enter the six digit verification code.

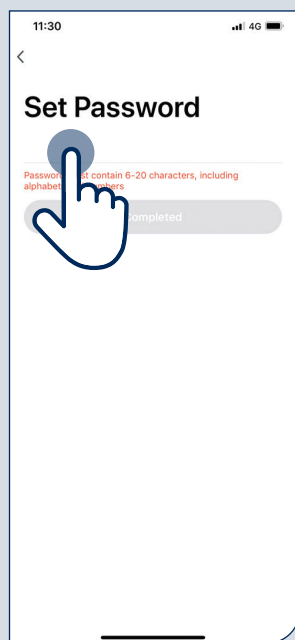

You will then be prompted for a password.

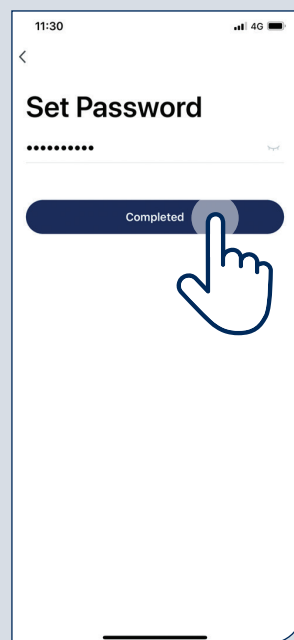

Once password has been chosen press 'Completed'.

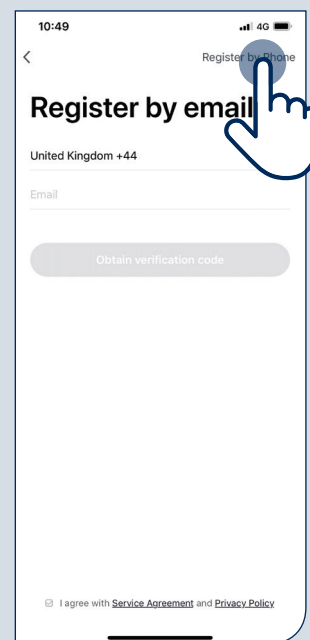

You can also register by phone by selecting 'Register by Phone' in top right corner of the App.

Once you have Created an Account

Creating a Family on the ZONA App

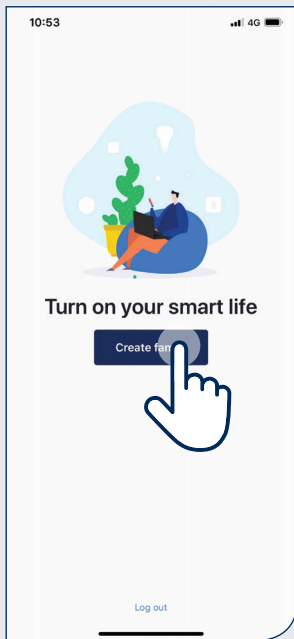

Click 'Create family' to set up your Smart Life.

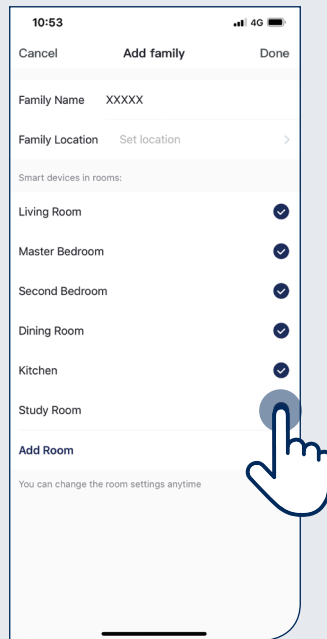

Add family details by selecting 'Family Name' and 'Location'. To add rooms, click the tick icon.

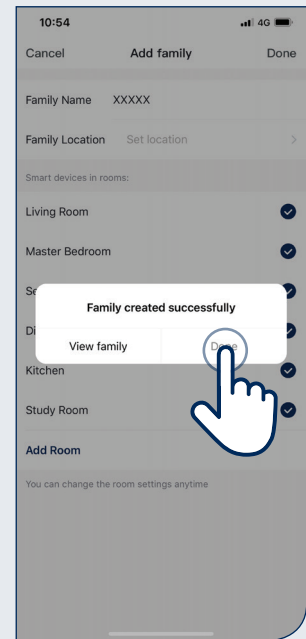

Once family is complete press 'Done'.

Connecting your ZONA Thermostat(s) to the App

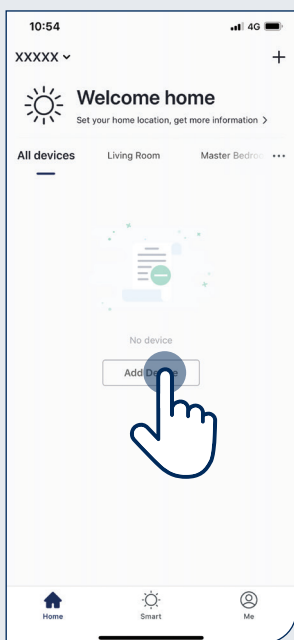

From the main screen you can view all your added thermostats together or by room.



We recommend adding your ZONA manually to begin with.

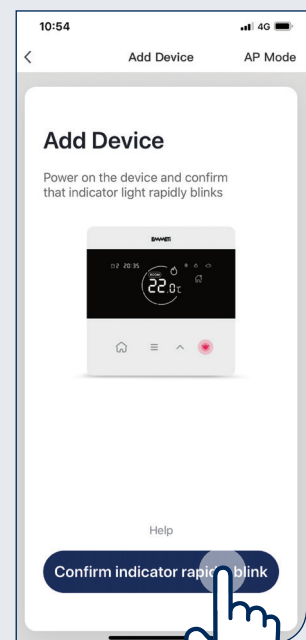

NOTE: Hold down  on your ZONA for 3 seconds to enter 'WiFi Compatibility' mode. The WiFi indicator on the thermostat will begin to blink rapidly.

Once you have Created an Account (continued)

Connecting your ZONA Thermostat(s) to the App (continued)

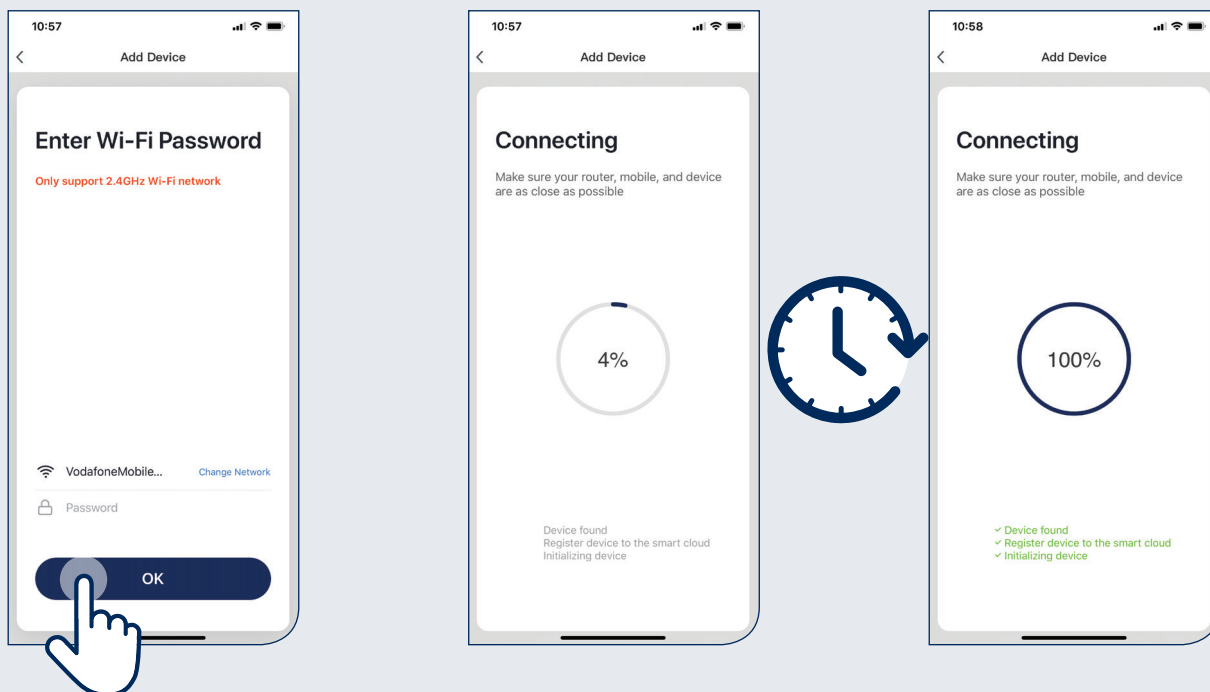

The App will pick up your home network, or you can change it if required.

It may take a few minutes to connect to your ZONA and complete the pairing.

When the thermostat and App have paired, the Cloud symbol ☁ will appear on the display of the thermostat.

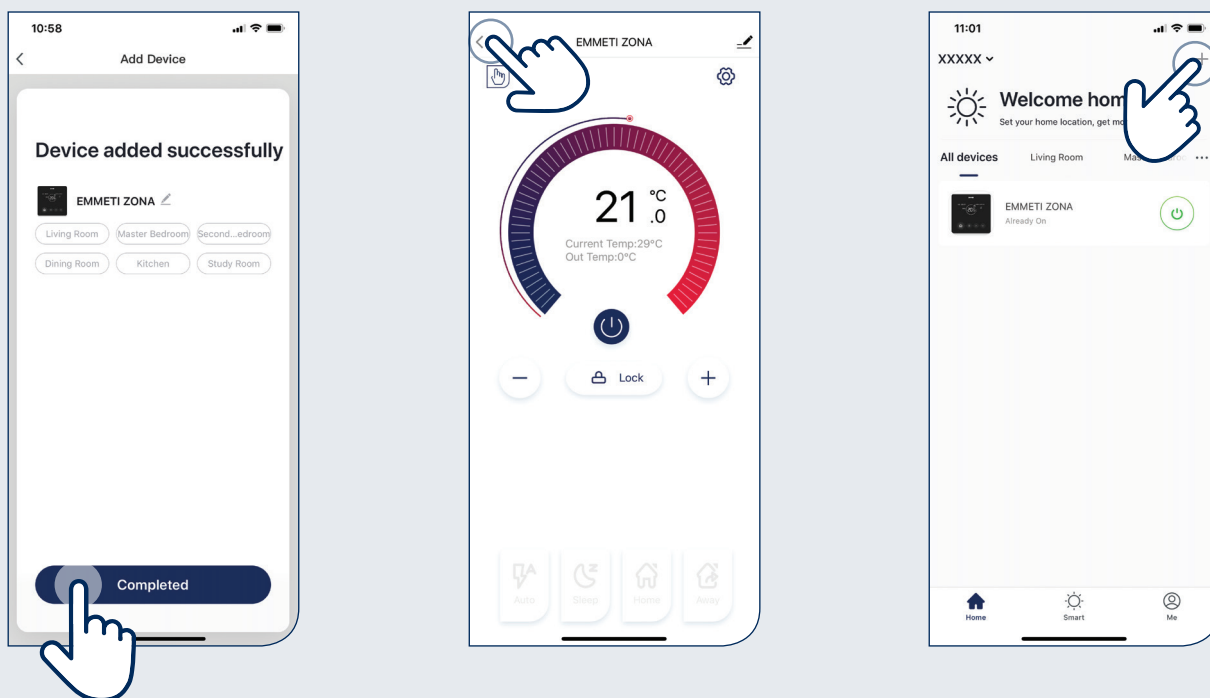

Once connected, identify your ZONA, or use one of the labels provided.

From here you can control the ZONA you have just added, or return to the Welcome menu.

To add further ZONA thermostat(s) simply click the '+' and repeat the previous steps.

Entering the Programme Parameters on the App

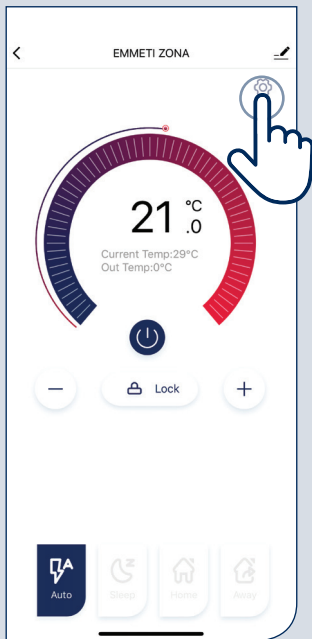

Click the settings icon to enter settings for the desired thermostat.

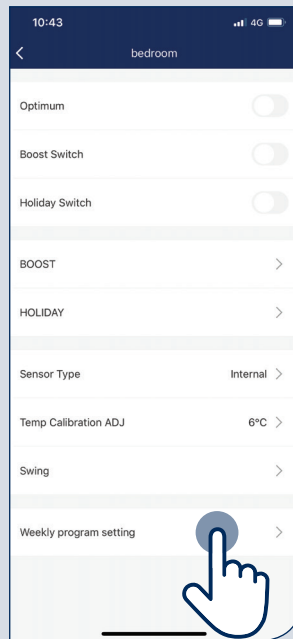

Click 'Weekly Programme Setting'.

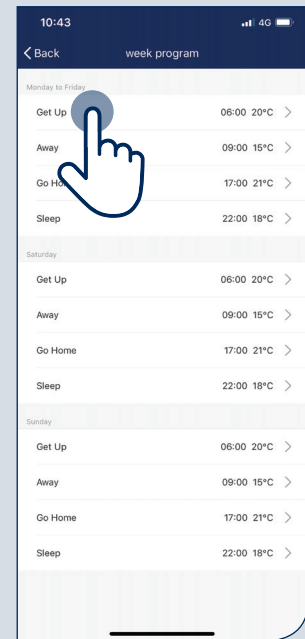

From here you can change the time and temperature.

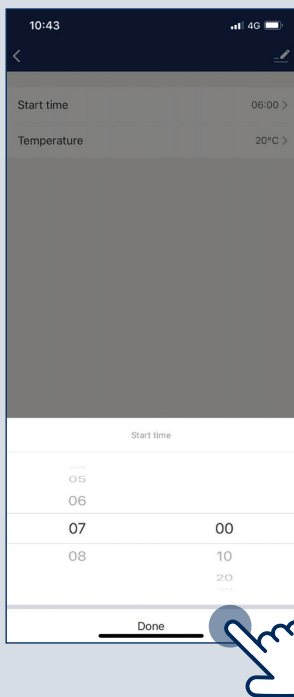

To alter the default setting; click the desired time period, i.e. 'Get Up'. You can now set the start time for the heating, i.e. 7am click 'Done' to confirm.

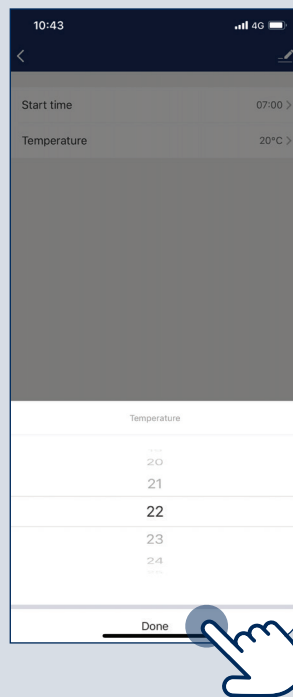

Click 'Temperature' to set the required temperature, i.e. 22°C, click 'Done' to confirm.

To confirm time and temperature changes, click 'Done' at the bottom of the screen.

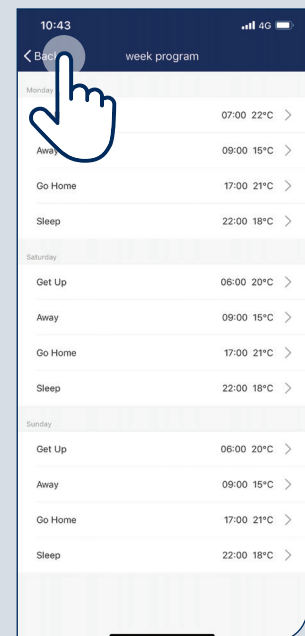

Repeat as required.

Locking/Unlocking the Thermostat via the App

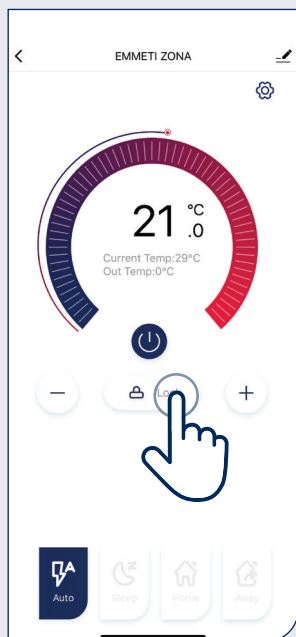

Click the thermostat you wish to lock or unlock. Click the 'Lock' button.

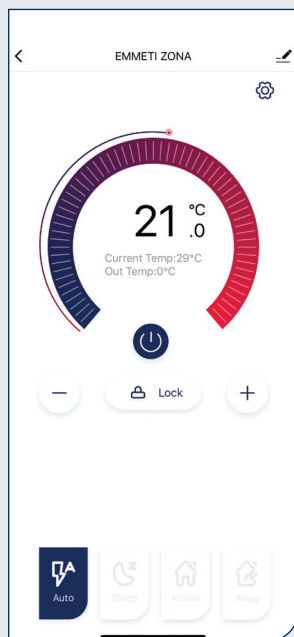

The lock symbol will now appear closed. A lock symbol will have also appeared on the thermostat. The App and thermostat are now locked.

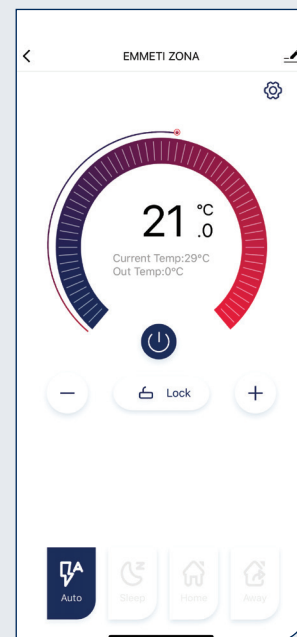

To unlock simply reverse the procedure.

Turning the Thermostat OFF/ON via the App

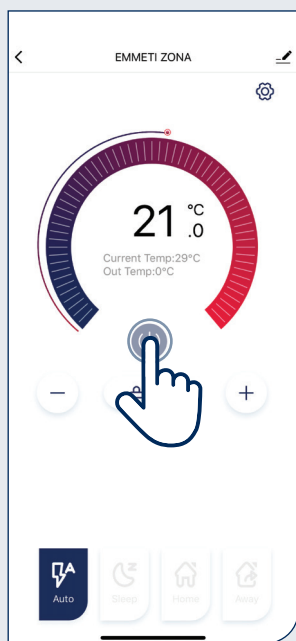

Click the power button in the centre of the screen for the thermostat you wish to turn off.

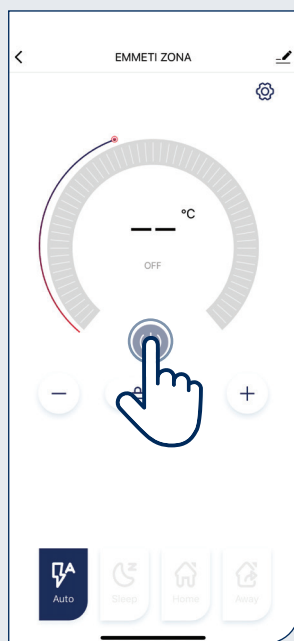

The temperature display will show as dashed lines and the word 'OFF' will be displayed. The thermostat will now be switched off.

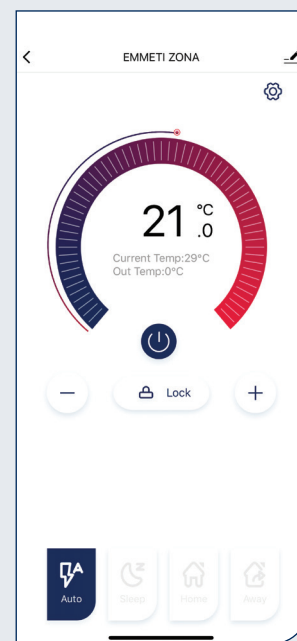

To turn the thermostat back on repeat the procedure. NOTE: Low Temperature Protection (Frost protection) will be inactive while the thermostat is off.

Advanced Modes

Your ZONA thermostat can be set on 6 different modes as shown below:

MODE	DESCRIPTION	RANGE
<p>AUTO</p> 	<p>If you have entered any of the other modes AUTO will return you to your current programme.</p>	-
<p>SLEEP</p> 	<p>The standard night set back temperature.</p>	5°C - 25°C
<p>HOME</p> 	<p>Used as an override to the current setting i.e. If you are home during the day when your programme may be at a low temperature.</p>	5°C - 25°C
<p>AWAY</p> 	<p>This is a setback temperature which your ZONA will maintain if you are away for a short time.</p>	5°C - 25°C
<p>HOLIDAY</p> 	<p>Set a specific temperature for the heating while you are away for a prolonged time.</p>	Up to 99 days
<p>BOOST</p> 	<p>Override the temperature on the thermostat for a specific amount of time.</p>	Up to 24 hours

Wiring Diagram

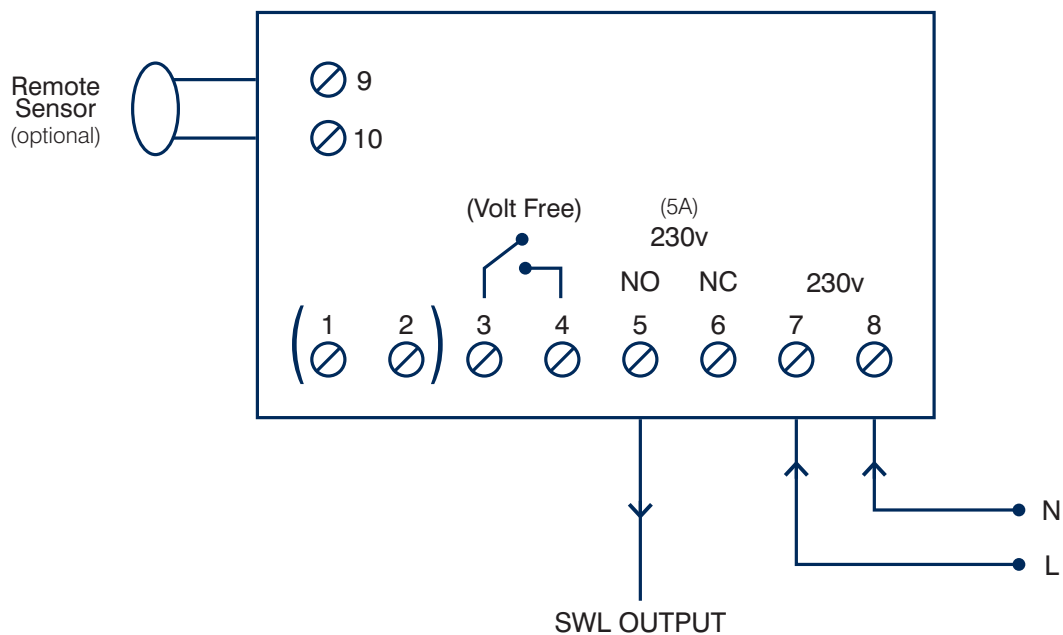

Terminal 1	Spare - Do Not Use
Terminal 2	Spare - Do Not Use
Terminal 3	Volt free switch
Terminal 4	Volt free switch
Terminal 5	Normally open direct contact
Terminal 6	Normally closed direct contact
Terminal 7 & 8	Live & Neutral

EMMETI

Engineered Water Solutions

6 Tannery Yard
Witney Street
Burford
Oxfordshire
OX18 4DQ

T: +44 (0) 1993 824900
F: +44 (0) 1993 824990
E: sales@emmeti.co.uk



01.07.19

www.emmeti.co.uk