

Products & Parts Catalogue 2022-23

Dudley



Epson



Beta



The source of **clever plumbing, people and products**



Welcome to our Catalogue 2022

TYDE brings together the strengths of Thomas Dudley Bathroom products and Masefield Beta Ltd to create a whole new level of service that puts customers right at the heart of our business.

TYDE is the home of over 6,000 trusted plumbing products ranging from high quality WRAS Approved Dudley Syphons and Toilet Cisterns to Beta Plumbing Brassware and Epon Washers and Seals.

Our friendly team of sales professionals are on hand to assist you with your sales and aftersales enquiries via telephone, email, fax and personal visits. Our website contains extensive product information including datasheets, FAQ's and install and maintenance videos. You can find our website at www.thomasdudley.co.uk/tyde



Free Delivery on orders over

£150

Carriage and Minimum Order Value

UK Shipping-excludes Highlands, some Scottish postcodes, Islands and Northern Ireland. Smaller orders subject to carriage charge.



Minimum Order Value

£35



British design,
British build,
Family business



Our brands

We combine the products and expertise across our five brands, Dudley, Epson, Beta, Resan and Cronex, to bring you a one-stop solution for your plumbing requirements. Each of our brands have been carefully designed to include a specific range of products allowing you to quickly and easily find the products you are looking for.

- One convenient, customer driven supplier
- Access to the Dudley, Epson, Beta, Resan & Cronex brands
- Over 6,000 innovative products
- Bespoke and own brand packaging formats
- One order, one invoice and one delivery
- Unrivalled UK stock holding and service
- Advanced warehousing and logistics
- Sales and Marketing support
- On site UKAS accredited and WRAS recognised test facility



6,000

trusted plumbing parts



100

years experience

Dudley 

Dudley manufactures superior quality plumbing products in our dedicated and ultra-modern facilities here in the UK.

Epson 

Quality doesn't have to cost the earth. Epson supplies cost-effective solutions for a wealth of reliable plumbing parts.

Beta 

Our plumbing brassware range, suitable for an array of plumbing jobs with excellence at the heart of each part.

Resan 

We manufacture anti-ligature sanitaryware products for many market sectors.

Cronex 

Cronex is our export range, distributing the best plumbing, hardware and electrical supplies worldwide.

contents

Innovations

01

Washroom fill & flush

02

Plumbing Fittings & Spares

03

Pipes, Valves & Fittings

04

ProFit+

05

Spares

- 14** **BUTTONS & PUSH PLATES**
- 20** **FRAMES**
- 25** **INLET VALVES**
- 29** **OUTLET VALVES**
- 30** **SYPHONS**

- 34** **TOILET CISTERNS**
CONCEALED CISTERNS
EXPOSED CISTERNS
AUTO CISTERNS
CISTERN OPTIONS
- 42** **TOUCH-FREE**
SOAP DISPENSORS
TAPS
URINAL CONTROLS
WC CONTROLS
ACCESSORIES

- 49** **RESAN SANITARYWARE**
BASINS
PANS
URINAL
MIRROR
SHELF
RESAN OPTIONS

- 60** **BATHROOM / KITCHEN ACCESSORIES**
WASTE, TRAPS & ACCESSORIES
PAN CONNECTORS
TOILET SEATS
ACCESSORIES
GRAB RAILS
PLUGS & CHAINS
- 93** **CISTERN LEVERS & PULLS**

- 102** **CISTERN TANK FITTINGS**
SYPHON & FLUSHING VALVE ACCESSORIES
FLUSHPIPE BENDS & ACCESSORIES
CLOSE COUPLING KITS & SPARES
- 108** **PRE-PACKED PRODUCTS**
PLUMBING BOXES
POLY BAG RANGE

- 115** **WASHERS AND SEALS**
TAP
TOILET CISTERN / TANK TRAP & WASTE
CENTRAL HEATING
SERVICE & HOSE
GENERAL
O RINGS

- 122** **BRASS FLOAT VALVES & ACCESSORIES**
- 128** **PLASTIC FLOATS**
- 129** **COMPRESSION PIPE FITTINGS**
BRASS PIPE FITTINGS
CHROME PIPE FITTINGS
DZR PIPE FITTINGS
LEAD FREE PIPE FITTINGS
- 137** **END FEED PIPE FITTINGS**

- 141** **SOLDER RING PIPE FITTINGS**
- 144** **THREADED PIPE FITTINGS**
- 147** **CONSUMABLES**
- 148** **DRAINAGE EQUIPMENT**
- 153** **GAS PRODUCTS**
- 156** **PIPE CLIPS**

- 160** **PLUMBING BRASSWARE & ACCESSORIES**
RADIATOR & HEATING PRODUCTS
WASHING MACHINE ACCESSORIES
VALVES
FLEXIBLE TAP CONNECTORS
- 175** **WATER HAMMER ARRESTORS**

177

178



Innovations



Innovation is at the heart of everything we do

TYDE products are designed with installers in mind and are quick and easy to fit and service.

At TYDE we pride ourselves on having in-depth knowledge and experience of our market, our sales team alone has acquired over 100 years of combined industry experience!

The technical customer support package provided by TYDE is unmatched. From dedicated phone lines to in-person site visits, our highly experienced team is available to guide you through any technical issues you may encounter.

DID YOU KNOW?



British manufacturing

We operate our own manufacturing centre in Dudley, West Midlands. We are proud to be a British Manufacturer.

We deliver

We deliver to every corner of the UK.

Providing our customers with unrivalled access to the widest product range on the market.

For live product lead times please see TYDE website.

Over 6,000 product lines

We stock over 6,000 product lines providing a one-stop-shop for all plumbing related products.

Innovations

DESIGN

height adjustment guides

40% smaller than turbo 88

smaller than turbo 51-11

smaller than fm ultra

light touch activation and superior flushing performance

retrofits onto all Dudley downlegs

simple to install and service

captive yellow pin does not have to be fully removed

Meet The Experts



Our History

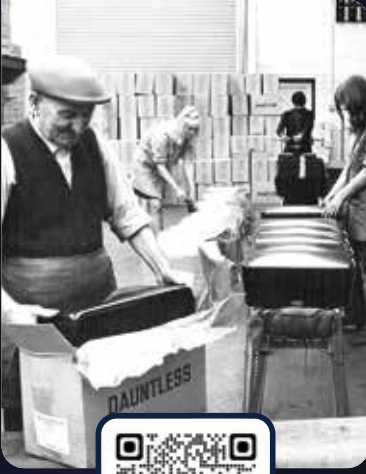

TYDE manufactures superior quality plumbing products in our dedicated and ultra-modern facilities here in the UK.

TYDE has earned an unrivalled reputation among professional installers because the trade has helped us create it.

We are leaders in innovations such as fluid dynamics and water control technology. We test our products in our own testing laboratory to the requirements of the UK Water Supply (Water Fittings) Regulations 1999 and all applicable national standards.

How To



FAQs



Case Studies



New Products



OSMO® F1 The World's first front access syphon cistern

SYPHONS // WASHROOM FILL & FLUSH

- Compatible with the Dudley Turbo Edge®
- Guaranteed Leak Free Flush
- Unique Patented front-access system
- Type AB weir overflow [Fluid Category 5 compliant]
- Easily serviceable by non-professionals
- Ergonomically designed
- Unique registered design flush handle available in multiple finishes
- Light touch operation
- Dual flush control

Type	Code
OSMO® F1	371854



Unique registered design flush handle available in multiple finishes:



Polished Copper



Brushed Copper



Chrome



Brushed Brass



Matt Black



Guaranteed leak-free flush mechanism.

TYDE's OSMO® F1 is the world's first front access serviceable syphon cistern, fitted with the **New Dudley Turbo Edge® syphon**, designed for use with WC furniture and IPS panelling. Manufactured in the UK by Thomas Dudley, OSMO® F1 is a new innovative concealed cistern designed to be stylish, versatile and easy to fit and service with minimal disruption to WC furniture or panelling.



• The World's first front access syphon cistern

Visit our website



New Products



OSMO® T1

Top access concealed reversible cistern with AXIS Technology™ creating multiple inlet and outlet options as standard for pod applications. Perfectly designed to be mounted on GRP, Timber and Steel framed pods.

- Unique reversible cistern body due to AXIS Technology™ achieving multiple outlet and inlet options
- Available with offset flush outlets and varying flush volumes
- Flush Pipe Stability System (FPSS™) with SureLock™ Bracket
- Fluid category 5 cistern; the only way to achieve a water regulations compliant cistern in standard height pod shelves

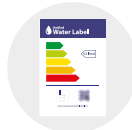

Product	Code
OSMO® T1	377201



Turbo Edge® Adjustable Syphon

Dudley's Turbo Edge® is the world's most compact syphon, guaranteed to fit more places than any others, with absolutely no compromise on flush performance.

- The Turbo Edge® is guaranteed to fit into all types of lever-operated cistern currently available
- Dudley's Turbo Edge® is the world's most compact syphon, guaranteed to fit more places than any others
- 6/7/9 Litre volume adjustment guaranteeing optimum flush performance
- Retrofits Dudley Downlegs over 7.5"

Item	Code
Turbo Edge® Adjustable Syphon	370873



Basin Waste with LEAK-FREE Basin Mate

Slotted with Mushroom Spring Plug with Basin Mate Seal Kit

- Basin Mate – Includes a sealing ring, washer & seating – everything you need for a quick & easy installation. There is no need for paint, putty or mastic!
- LEAK-FREE
- Quick & simple installation
- 2 Year guarantee
- High quality chrome plating to BS1224, providing a contemporary yet traditional look

Item	Code
Basin Waste with Leak-Free Basin Mate	372393



90° S Pan Connector with Outlet

A flexible and extendable Pan connector that is suitable for either domestic or commercial use, whether you are looking to complete a new installation or fix a broken part that isn't working quite as it should, you can always count on these products being of the best quality, durable, reliable and easy to install.

- Flexible
- Extendable (240 - 460mm)
- Made to BS5627
- 10 Year Warranty

Item	Code
90° S Pan Connector with Outlet	363744

Washroom fill & flush

Our fill and flush toilet products have been developed by expert plumbers who truly understand the needs and preferences of both installers and users. Each and every toilet part we manufacture here in the UK has been created to the highest of standards and we're proud of the unrivalled reputation our Dudley toilet parts have among professional installers. Our fill and flush products are not only superior quality, they've also been designed with a quick and simple fit in mind so you can install them swiftly and move on to the next job.

For live product lead times please visit our website.

Dudley



In this section

01	»Buttons & Push Plates	14	07	»Touch-Free Soap Dispensors	42
02	»Frames	20		Taps	43
03	»Inlet Valves	25		Urinal Controls	44
04	»Outlet Valves	29		WC Controls	46
05	»Syphons	30		Accessories	47
06	»Toilet Cisterns	34	08	»Resan Basins	48
	Concealed Cisterns	34		Pans	49
	Exposed Cisterns	36		Urinal	52
	Auto Cisterns	37		Mirror	56
	Cistern Options	38		Shelf	56
				Resan Options	57

Visit our website

Visit our website and search our extensive range of plumbing parts, find key product information such as technical specifications, installation and troubleshooting guides and create your order all in one place using our Quote Builder function.



01 Buttons & Push Plates

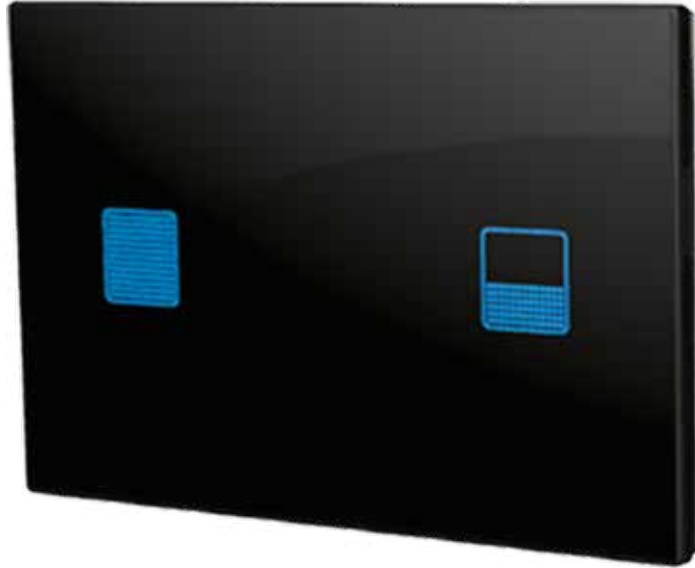

Wave S3 – Push Plate

BUTTONS & PUSH PLATES // WASHROOM FILL & FLUSH

Wave S3 Touch-Free Electronic Push Plate

- 242mm [W] x 156mm [H] x 12mm [D]
- Electronic Dualflush Feature
- Touch-Free

Type	Code
Square Corners	330264
Radius Corners	330265

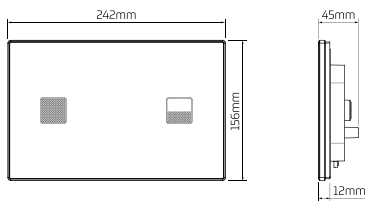

- Electronic dualflush feature
- Touch-free

Visit our website



Buttons & Push Plates 01

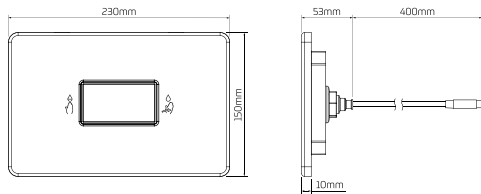

WAVE S2 – PUSH PLATE

BUTTONS & PUSH PLATES // WASHROOM FILL & FLUSH

Wave S2 Touch-Free Electronic Push Plate

- 229mm [W] x 149mm [H] x 10mm [D]
- Electronic Dualflush Feature
- Touch-Free

Type	Code
Wave S2 – Push Plate	326395

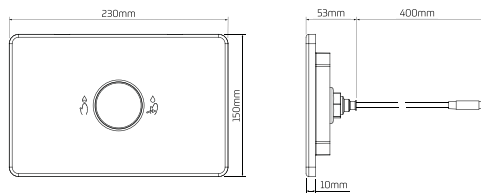

WAVE S1 – PUSH PLATE

BUTTONS & PUSH PLATES // WASHROOM FILL & FLUSH

Wave S1 Touch-Free Electronic Push Plate

- 229mm [W] x 149mm [H] x 10mm [D]
- Electronic Dualflush Feature
- Touch-Free

Item	Code
Wave S1 – Push Plate	326394



01 Buttons & Push Plates



Dio – Dualflush Pushbutton

51mm POLISHED CHROME DUALFLUSH PUSHBUTTON

- 51mm Diameter Pushbutton
- Dualflush feature
- Alternative finishes available

Packaging/Finish	Code
Boxed	327733
Unboxed	322408



Miniflo Polished Chrome – Dualflush Pushbutton

51mm POLISHED CHROME DUALFLUSH PUSHBUTTON

- 51mm Diameter Pushbutton
- Dualflush feature
- Alternative finishes available

Item	Code
Miniflo Polished Chrome Pushbutton	322905



Geo - Dualflush Pushbutton

73.5mm POLISHED CHROME DUALFLUSH PUSHBUTTON

- 73.5mm Diameter Pushbutton
- Dualflush feature
- Alternative finishes available

Item	Code
Polished Chrome Pushbutton	372873

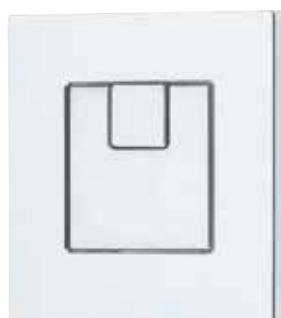

Piazza – Square Dualflush Pushbutton

73.5mm SQUARE DUALFLUSH PUSHBUTTON

- Dualflush feature
- Chrome Finish
- Alternative finishes available

Item	Code
Piazza – Square Dualflush Pushbutton	327734

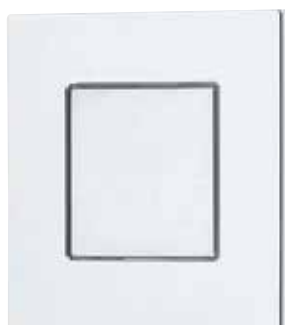

Piazza – Square Single Flush Pushbutton

73.5mm SINGLE FLUSH PUSHBUTTON

- Single Flush
- Chrome Finish
- Alternative finishes available

Item	Code
Piazza – Square Single Flush Pushbutton	325277

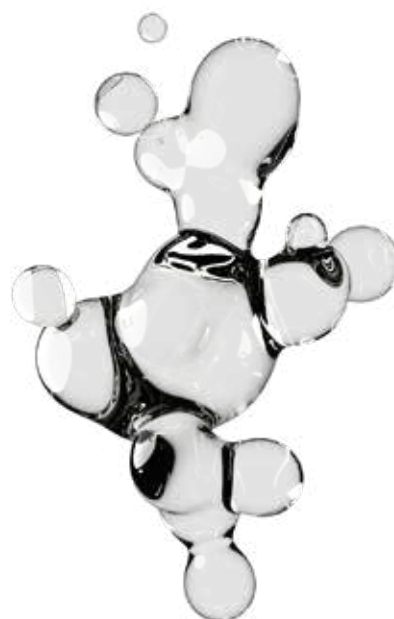

Buttons & Push Plates 01



CP Round Dualflush Pushbutton

73.5mm DUALFLUSH PUSHBUTTON IN VARIOUS FINISHES

- 73.5mm Diameter Pushbutton
- Dualflush Feature
- Chrome Plated, and White
- Boxed and Unboxed available on certain buttons

Finish/Packaging	Code
Chrome Plated Boxed	327732
Chrome Plated Unboxed	315921
White	321194



CP Round - Single Flush Pushbutton

73.5mm CHROME SINGLE FLUSH PUSHBUTTON IN VARIOUS FINISHES

- 73.5mm Diameter Pushbutton
- Single Flush
- Chrome Plated and Mixage Finish
- Boxed and Unboxed available on certain buttons

Finish/Packaging	Code
Chrome Plated Boxed	327736
Chrome Plated Unboxed	313085



Metal Royal - Pushbutton

METAL ROYAL VANDAL RESISTANT PUSHBUTTON

- 51mm Diameter
- High impact vandal-resistant stainless steel construction
- Flat metal button cannot be unscrewed from the front, providing an anti-ligature solution.
- Single Flush

Item	Code
Metal Royal - Pushbutton	321685



Royal - Pushbutton

51mm SINGLE FLUSH PUSHBUTTON

- 51mm Diameter Pushbutton
- Single Flush
- Chrome Finish
- Alternative finishes available

Packaging	Code
Boxed	327735
Unboxed	313621



Palm Push Royal - Pushbutton

51mm SINGLE FLUSH PUSHBUTTON

- 51mm Diameter Pushbutton
- Single Flush
- Chrome Finish
- Alternative finishes available

Item	Code
Palm Push Royal - Pushbutton	324379



Royal Twin Palm - Pushbutton

51mm PALM PUSH DUALFLUSH PUSHBUTTON

- 51mm Diameter Pushbutton
- Dualflush feature
- Palm Push

Item	Code
Royal Twin Palm - Pushbutton	327655

01 Buttons & Push Plates



Drift – Push Plate

DRIFT DUALFLUSH PUSH PLATE

- 242mm [W] x 156mm [H] x 12mm [D]
- Dualflush Feature
- Chrome Finish
- Alternative finishes available

Item	Code
Chrome Drift Push Plate	372565



Reef – Push Plate

REEF DUALFLUSH PUSH PLATE

- 232mm [W] x 152mm [H] x 14mm [D]
- Dualflush Feature
- Chrome Finish
- Alternative finishes available

Finish	Code
Chrome Reef Push Plate	326393

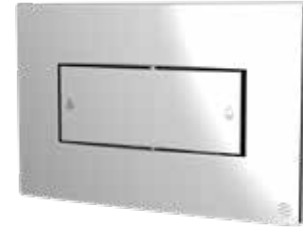

Coral – Push Plate

CORAL DUALFLUSH PUSH PLATE

- 232mm [W] x 152mm [H] x 14mm [D]
- Dualflush Feature
- Chrome Finish
- Alternative finishes available

Finish	Code
Chrome Coral Push Plate	326392

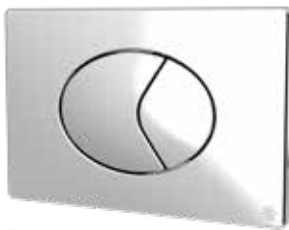

Oyster – Push Plate

OYSTER DUALFLUSH PUSH PLATE

- 232mm [W] x 152mm [H] x 16mm [D]
- Dualflush Feature
- Chrome Finish
- Alternative finishes available

Item	Code
Chrome Oyster Push Plate	322903



Metal Pearl – Push Plate

PEARL STAINLESS STEEL VANDAL RESISTANT PUSH PLATE

- 125mm [W] x 82mm [H] x 8mm [D]
- High impact vandal-resistant stainless steel construction
- Flat metal button cannot be unscrewed from the front, providing an anti-ligature solution

Item	Code
Metal Pearl Push Plate	326488

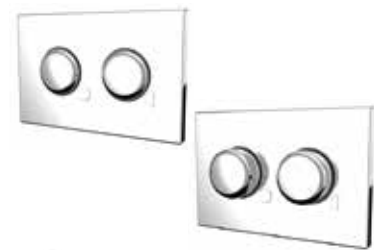

Pearl / Pearl Palm – Push Plate

PEARL / PEARL PALM DUALFLUSH PUSH PLATE

- 125mm [W] x 82mm [H] x 8mm [D]
- Dualflush Feature
- Chrome Finish

Item	Code
Chrome Pearl Push Plate	324697
Chrome Pearl Palm Push Plate	324762

Buttons & Push Plates 01



Metal Remora – Push Plate

METAL REMORA VANDAL RESISTANT PUSH PLATE

- 229mm [W] x 149mm [H] x 10mm [D]
- High impact vandal-resistant stainless steel construction
- Flat metal button cannot be unscrewed from the front, providing an anti-ligature solution

Item	Code
Stainless Steel Remora Push Plate	327227

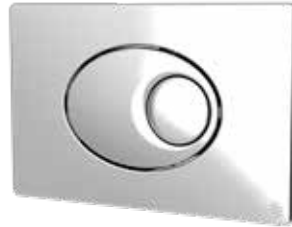

Pebble – Push Plate

PEBBLE DUALFLUSH PUSH PLATE

- 232mm [W] x 152mm [H] x 16mm [D]
- Dualflush Feature
- Chrome Finish

Item	Code
Chrome Pebble Push Plate	322904



Cone – Pushbutton

50mm SINGLE FLUSH PUSHBUTTON

- 50mm Diameter Pushbutton
- Single Flush
- Chrome Finish

Item	Code
Chrome Cone Pushbutton	316269



Dome – Pushbutton

91mm SINGLE FLUSH PUSHBUTTON

- 91mm Diameter Pushbutton
- Single Flush
- Chrome Finish

Item	Code
Dome – Pushbutton	316562



Petite – Pushbutton

46mm SINGLE FLUSH PUSHBUTTON

- 46mm Diameter Pushbutton
- Single Flush
- Chrome Finish

Item	Code
Petite – Pushbutton	320185



Metal Flat – Pushbutton

METAL FLAT VANDAL RESISTANT SINGLE FLUSH PUSHBUTTON

- 63.5mm Diameter
- High impact vandal-resistant stainless steel construction
- Flat metal button cannot be unscrewed from the front, providing an anti-ligature solution

Item	Code
Metal Flat – Pushbutton	319473

02 Frames



Dudley Illusion A

FRAMES // WASHROOM FILL & FLUSH

Height adjustable wall-hung WC pan support frame designed for use against flat walls and in corners

- Unique design enables frame to be set between 825mm and 1120mm for unrivalled installation flexibility
- Integral factory fitted Dudley Vantage cistern
- Floor brackets rotate through 360°
- Available for use with various buttons operated by the Dudley Niagara Pneumatic Flush Valve
- Vantage cisterns are available with a Type AB weir overflow (Fluid Category 5 Compliant)
- Wall and floor fixing brackets can be fixed through 180 degrees and 360 degrees respectively to simplify installation
- Strong steel tubular section
- Height adjustable

Type	Code
Dudley Illusion A (supplied with Oyster plate)	325470

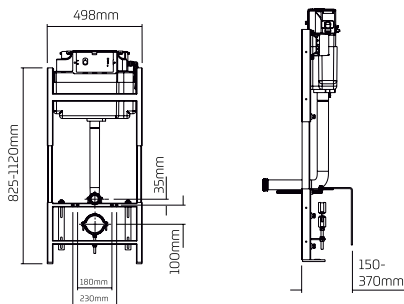

The Dudley Illusion range of support frames are ideal for use with most wall-hung sanitaryware. They also provide a proven solution behind panelling and tiles and in fitted bathroom furniture. Illusion A and V frames incorporate an integral Vantage cistern that can be quickly and easily converted to deliver factory set to 6/4L convertible to 5/3-4/2-6L dualflush to support BREEAM and other initiatives. Illusion Universal, Compact Universal and Freestanda frames can be installed in conjunction with any Dudley concealed cistern to provide a bespoke water saving solution. Wall hung WC pan support frame designed for use against flat walls and in corners. Ideal for most domestic and commercial applications.

- Unique design
- Floor brackets rotate through 360°

Visit our website



Frames 02

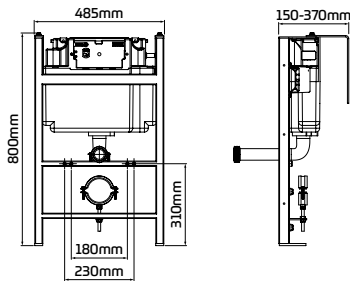

DUDLEY ILLUSION V

FRAMES // WASHROOM FILL & FLUSH

Wall-hung WC pan support frame designed for use against flat walls and in corners

- Integral factory fitted Dudley Vantage cistern
- Fixed height frame, legs adjust to offer WC pan height fixing flexibility
- Available for use with various buttons operated by the Dudley Niagara Pneumatic Flush Valve
- Floor brackets rotate through 360°
- Wall and floor fixing brackets can be fixed through 180° and 360° respectively to simplify installation
- Strong steel tubular section
- Floor and WC pan fixing bolts included

Type	Code
Dudley Illusion V (supplied with Oyster plate)	323345

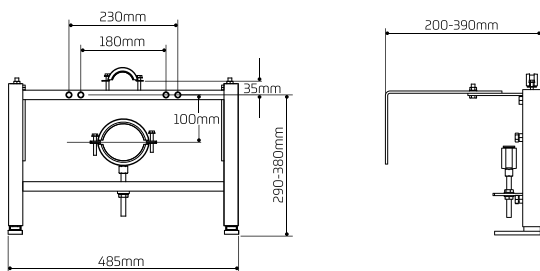

DUDLEY ILLUSION UNIVERSAL

FRAMES // WASHROOM FILL & FLUSH

Height adjustable wall-hung WC pan support frame designed for use against flat walls and in corners

- Comes with flushbend and WC pan connector clamps
- Legs adjust to offer WC pan height fixing flexibility
- Wall and floor fixing brackets can be fixed through 180° and 360° respectively to simplify installation
- Strong steel tubular section
- Floor and WC pan fixing bolts included

Item	Code
Dudley Illusion Universal	314802

02 Frames

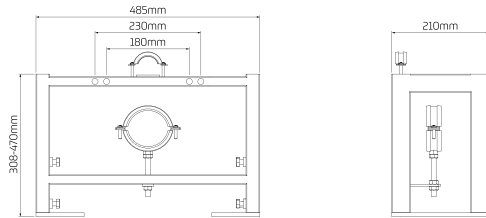

DUDLEY ILLUSION FREESTANDA

FRAMES // WASHROOM FILL & FLUSH

Free-standing height adjustable wall-hung WC pan support frame. Can be used against flat walls and in corners.

- Sturdy floor brackets remove the need for rear wall fixing
- Legs adjust to offer WC pan height fixing flexibility
- Blue painted finish and zinc plated wall and floor brackets
- Strong steel tubular section
- Floor and WC pan fixing bolts included
- Comes with flushbend and WC connector clamps

Item	Code
Dudley Illusion Freestanda	316233

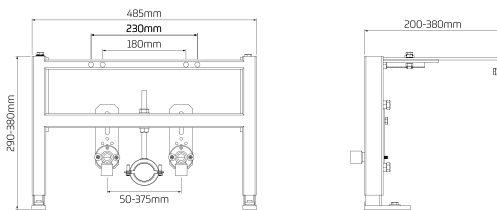

DUDLEY ILLUSION BIDET

FRAMES // WASHROOM FILL & FLUSH

Wall-hung bidet support frame designed for use against flat walls and in corners

- Blue painted finish and zinc plated wall and floor brackets
- Legs adjust to up to 150mm to offer WC pan height fixing flexibility
- Wall and floor fixing brackets can be fixed through 180 degrees and 360 degrees respectively to simplify installation
- Strong steel tubular section
- Floor and bidet fixing bolts included

Item	Code
Dudley Illusion Bidet	314887

Frames 02

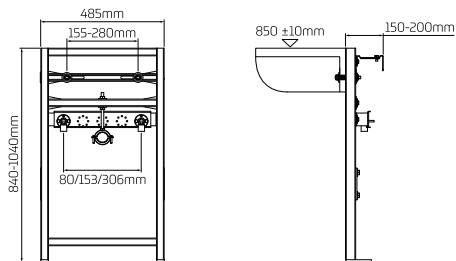

DUDLEY ILLUSION BASIN

FRAMES // WASHROOM FILL & FLUSH

Wall-hung basin support frame designed for use against flat walls and in corners

- Blue painted finish and zinc plated wall and floor brackets
- Fixed height frame, legs adjust to offer basin height fixing flexibility
- Wall and floor fixing brackets can be fixed through 180 degrees and 360 degrees respectively to simplify installation
- Strong steel tubular section
- Floor and bidet fixing bolts included

Type	Code
Dudley Illusion Basin	319207



Dudley Illusion Sentinel

WALL-HUNG WC PAN SUPPORT BRACKETS. IDEAL FOR MOST DOMESTIC AND COMMERCIAL APPLICATIONS.

- Strong cast iron construction
- Vertical slot offers WC pan height fixing flexibility
- Wall & floor fixing brackets can be fixed through 180° & 360° respectively to simplify installation
- Grey painted finish
- Floor and WC Pan fixing bolts available as optional extras

Item	Code
Bracket	317614

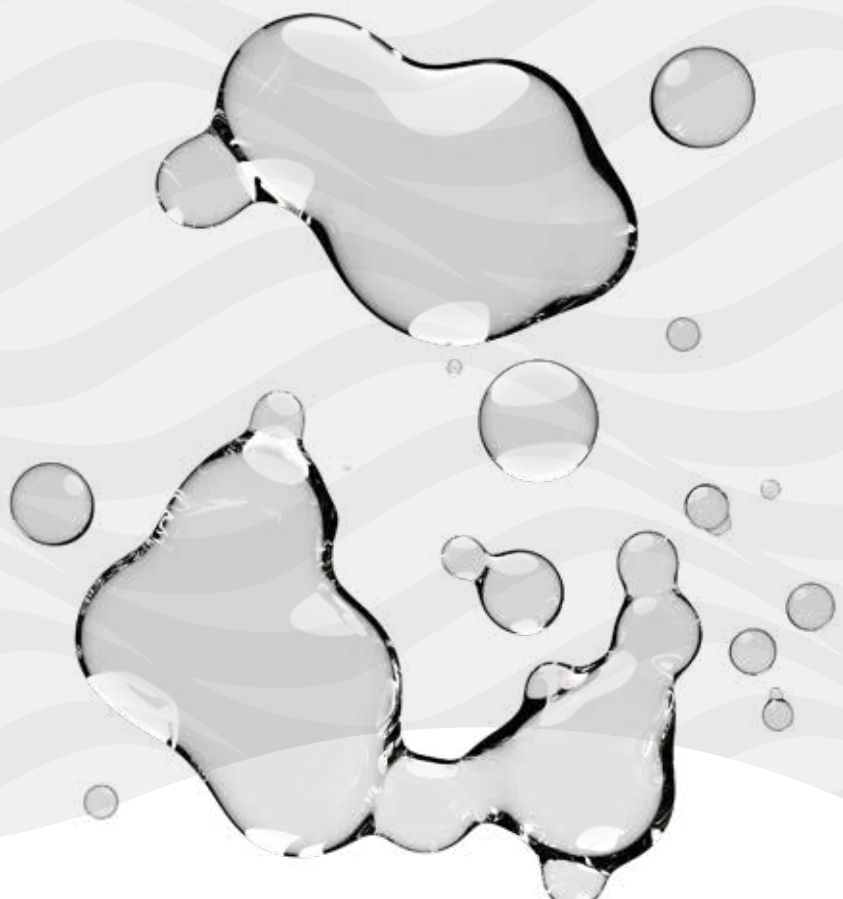

Frames – Options

Frame System and Cistern with Polystyrene Insulation Jacket and With:

Code	Product Name	Description
323063	Dudley Illusion 'V'	No Button / Plate
325638	Dudley Illusion 'V'	Round/Round CP Button (73.5mm)
325636	Dudley Illusion 'V'	Palm Push CP Button (51mm)
327210	Dudley Illusion 'V'	Dualflush CP Reef Plate
327280	Dudley Illusion 'V'	Dualflush CP Pearl Palm Push Plate

Frame System and Cistern without Polystyrene Insulation Jacket and With:

325639	Dudley Illusion 'V'	Round/Round CP Button (73.5mm)
--------	---------------------	--------------------------------

6/4 Litre Dualflush (Converts to 5/3 or 4/2.6 Litre) (Button Packed with Cistern):

Frame System and Cistern with Polystyrene Insulation Jacket and With:

325336	Dudley Illusion 'V'	Square Piazza CP Button (73.5mm)
322252	Dudley Illusion 'V'	Round/Round CP Button (73.5mm)
322805	Dudley Illusion 'V'	Dio CP Button (51mm)
323345	Dudley Illusion 'V'	Oyster Pushplate
324775	Dudley Illusion 'V'	Electroflo Touch Free Flushing and 40mm CP Sensor Surround - Battery
324262	Dudley Illusion 'V'	Electroflo Touch Free Flushing and 40mm CP Sensor Surround - Mains
324478	Dudley Illusion 'V'	Electroflo Touch Free Flushing and 100mm CP Commercial Sensor Surround (Mains)

Frame system and Cistern without Polystyrene Insulation Jacket and With:

322017	Dudley Illusion 'V'	Round/Round CP Button (73.5mm)
322577	Dudley Illusion 'V'	Dio CP Button (51mm)
323344	Dudley Illusion 'V'	Oyster Pushplate

Single Flush (Button Packed with Cistern)

Frame System and Cistern with Polystyrene Insulation Jacket and With:

Code	Product Name	Description
325685	Dudley Illusion 'A'	No Button / Plate
325452	Dudley Illusion 'A'	Round/Round CP Button (73.5mm)
325455	Dudley Illusion 'A'	Square Piazza CP Button (73.5mm)
330803	Dudley Illusion 'A'	Remora Stainless Steel Button (Polished)

Frame System and Cistern without Polystyrene Insulation Jacket and With:

325456	Dudley Illusion 'A'	Round/Round CP Button (73.5mm)
325458	Dudley Illusion 'A'	Palm Push CP Button (51mm)

6/4 Litre Dualflush (Converts to 5/3 or 4/2.6 Litre) (Button Packed with Cistern):

Frame System and Cistern with Polystyrene Insulation Jacket and With:

325469	Dudley Illusion 'A'	Square Piazza CP Button (73.5mm)
325467	Dudley Illusion 'A'	Round/Round CP Button (73.5mm)
326644	Dudley Illusion 'A'	Reef CP Plate
325468	Dudley Illusion 'A'	Dio CP Button (51mm)
325470	Dudley Illusion 'A'	Oyster Push Plate
330493	Dudley Illusion 'A'	Wave S3 With Radius Corners (Mains Power)
330494	Dudley Illusion 'A'	Wave S3 With Square Corners (Mains Power)
325476	Dudley Illusion 'A'	Electroflo Touch Free Flushing and 40mm CP Sensor Surround (Mains Power)
325475	Dudley Illusion 'A'	Electroflo Touch Free Flushing and 100mm CP Commercial Sensor Surround (Mains Power)

Frame System and Cistern without Polystyrene Insulation Jacket and With:

325464	Dudley Illusion 'A'	Square Piazza CP Button (73.5mm)
325462	Dudley Illusion 'A'	Round/Round CP Button (73.5mm)
325463	Dudley Illusion 'A'	Dio CP Button (51mm)
325461	Dudley Illusion 'A'	Oyster Push Plate

Code	Product Name	Description
325405	Extra	Chrome 40mm Surround for Dudley 'Electroflo' Sensor
330092	Extra	Fixing Pack for Dudley Illusion 'V' and 'A' Frames



Hydroflo Telescopic Bottom Inlet Compact Delay Brass Tail

INLET VALVES // WASHROOM FILL & FLUSH

Hydroflo Telescopic compact delay fill bottom inlet valve with brass tail

- Unique key is provided for simple and safe removal of the filter
- Adjustable Height 8" – 11½"
- ½" Brass Tail

Type	Code
Hydroflo Telescopic	324301

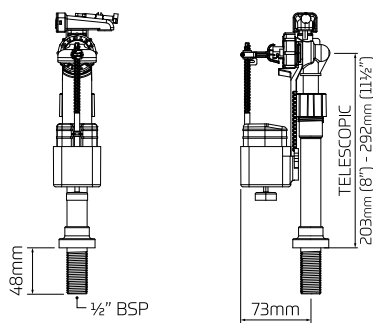

Dudley Hydroflo Float Valves are Equilibrium Quiet Filling Part 4 Valves, manufactured to BS1212 standards. These are available in side or adjustable bottom inlet from 8" to 11½", with either a plastic or brass tail option to help prevent cross-threading. The unique float arm makes it impossible for the float to become detached. Filter removal is made quick and simple by providing a key attached to every diverter, without causing any damage to the valve. Simple and easy to install, this valve is a great replacement for any cistern. Telescopic valves can have a joint beneath the waterline when installed. To ensure full compliance to water regulations when fitting, please ensure the joint is above the critical waterline

- **Unique float arm**
- **Adjustable Height 8" – 11½"**

Visit our website



03 Inlet Valves



HYDROFLO AIRGAP SIDE INLET DELAY FILL

INLET VALVES // WASHROOM FILL & FLUSH

Hydroflo side inlet compact float valve with brass tail or plastic tail

- Supplied with 'Air Gap' as standard since 2004
- Supplied fitted with an integral flow restrictor
- Unique key is provided for simple and safe removal of the filter
- ½" Brass Tail or Plastic Tail
- The unique side inlet float arm makes it impossible for the float to become detached.

Type	Code
Side Inlet Delay Fill Brass Tail	324298
Side Inlet Delay Fill Plastic Tail	334686



Hydroflo Telescopic Bottom Inlet Standard Fill Brass Tail

HYDROFLO TELESCOPIC BOTTOM INLET VALVE WITH BRASS TAIL

- Unique key is provided for simple and safe removal of the filter
- Supplied fitted with and integral flow regulator
- Adjustable Height 8" – 11.5"
- ½" Brass Tail

Item	Code
Hydroflo Telescopic Bottom Inlet Standard Fill Brass Tail	324302



Hydroflo Side Inlet Standard Fill Brass Tail

HYDROFLO SIDE INLET VALVE WITH BRASS TAIL

- Supplied with 'Air Gap' as standard since 2004
- Supplied fitted with & integral flow regulator
- Unique key is provided for simple and safe removal of the filter
- ½" Brass Tail
- The unique side inlet float arm makes it impossible for the float to become detached

Item	Code
Hydroflo Side Inlet Standard Fill Brass Tail	324299



FEATURED

Hydroflo Airgap Compact Bottom Inlet Delay Brass Tail

INLET VALVES // WASHROOM FILL & FLUSH

Hydroflo compact delay fill bottom inlet valve with brass tail

- Supplied with 'Air Gap' as standard since 2004
- Water regulations compliant replacement inlet valve for most modern ceramic and plastic cisterns. Fixed height bottom inlet valve, ensure fitment is appropriate for the size of cistern. (241mm 9.5" recommended for most applications)
- Compact float will not catch on tight cistern installations where the inlet valve is close to the syphon or outlet valve, ensuring perfect operation
- Wide waterline adjustment range of 140mm to 220mm
- Professional ½" brass tail
- Water saving delay fill action
- Time saving, flow regulation works for all water pressures; no need for removal
- Patented integrated quiet fill action
- Unique key is provided for simple and safe removal of the filter
- Unique float arm makes it impossible for the float to become detached
- The only compliant valve with no IRN's
- WRAS approved

Size	Code
203mm (8")	370908
216mm (8.5")	370909
229mm (9")	370910
241mm (9.5")	334604
254mm (10")	370912
267mm (10.5")	370913
280mm (11")	370914
292mm (11.5")	370915
305mm (12")	370916



• Air Gap as standard

• Unique float arm

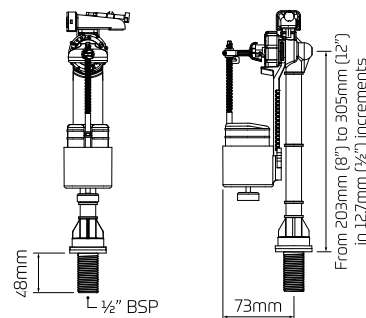

Visit our website



03 Inlet Valves



Dudley Beta+ Side Inlet Valve

PART 3 SIDE INLET VALVE WITH PLASTIC OR BRASS TAIL

- Compatible with furniture, tiles, partitioning and walls
- Unique float arm can be fixed in 3 positions
- Float arm extends from 185mm – 285mm
- Quickly adjust to not obstruct other cistern components
- Plastic/Brass Tail

Tail	Code
Plastic	332316
Brass	327640



Dudley Beta+ Part 3 Telescopic Bottom Inlet Brass Tail

DUDLEY BETA+ PART 3 TELESCOPIC BOTTOM INLET BRASS TAIL

- Fits Virtually all float operated cisterns
- Easy Installation
- Designed and manufactured in the UK to BS1212 Standard
- Unique float arm can be fixed in 3 positions
- Float arm extends from 185mm - 285mm

Item	Code
Dudley Beta+ Bottom Inlet 9" Part 3 Float Valve	327645



Beta+ Bottom Inlet 9" Part 3 Float Valve

DUDLEY BETA+ BOTTOM INLET 9" (229mm) PART 3 FLOAT VALVE, ADJUSTABLE ARM

- Fits virtually all float operated cisterns
- Easy Installation
- Designed and manufactured in the UK to BS1212 Standard
- Unique float arm and can be fixed in 3 positions
- Float arm extends from 185mm - 285mm

Item	Code
Dudley Beta Fixed Bottom Inlet Valve	332318



Outlet Valves 04



VICTORIA CABLE OPERATED DUALFLUSH VALVE

OUTLET VALVES // WASHROOM FILL & FLUSH

Ideal solution to suit most situations where a flushing valve is required

- 6/4 Litre Dual Flush
- Comes fitted with a stylish chrome pushbutton that sits neatly in to the lid of the cistern, it will also fit in to the front lever hole of the cistern
- 325648 [300mm] comes with 42mm [1½"] outlet tail, supplied with adaptor for a 53mm [2"] outlet
- 325691 [470mm] suitable for 2" outlet
- Bayonet fixing allows easy access for maintenance
- Design allows for easy adjustment
- Available with cable lengths for 300mm long [for close coupled cisterns] and 470mm long [for concealed cisterns]

Cable Length	Code
300mm	325648
470mm	325691



Niagara Mechanical Dualflush Valve

THE DUDLEY NIAGARA DUAL FLUSH VALVE IS AN IDEAL REPLACEMENT FOR MOST TOILET VALVES

- Long-life silicon rubber seal
- 51mm [2"] outlet
- WRAS approved. 6/4 litre dual flush
- Top Flush
- Serviced in under 5 mins
- Chrome Push Button

Item	Code
Niagara Mechanical Dualflush Valve	313348



Niagara Pneumatic Dualflush Valve

IDEAL FOR USE AS A REPLACEMENT IN MOST CONCEALED CISTERNS

- 6/4 Litre Dual Flush & 6 Litre Single Flush
- 51mm [2"] Outlet
- Fitted with a long-life silicon rubber seal
- Can be operated by a wide range of pushbuttons, push plates & electronic sensors (Sold separately) Niagara Pneumatic tubes supplied
- Supplied as standard in Vantage, Miniflo & Royal Cisterns

Item	Code
Niagara Pneumatic Dualflush Valve	327628

For available buttons please see pages 14-19

05 Syphons



Turbo Edge® Adjustable Syphon

SYPHONS // WASHROOM FILL & FLUSH

The Turbo Edge® is the world's most compact syphon, guaranteed to fit more places than any others

- 6/7/9 Litre volume adjustment guaranteeing optimum flush performance
- Fully captive yellow fixing pin does not need to be removed to install syphon, easing installation
- Internal overflow
- It has a 2-part design that enables the syphon body to be simply removed from the cistern leaving the white downleg in position. This feature enables the Turbo Edge® to be serviced in under 5 minutes without disconnecting water supply and dismantling cistern
- Retrofits ALL Dudley Downlegs over 7.5" (Including Turbo 88, Turbo 44 & Turbo S1-11)
- The Turbo Edge® is the ONLY syphon you will ever need
- Fits all syphon flush ceramic & plastic WC cistern

THE ONLY SYPHON TO HAVE THE EDGE ON THE TURBO 88™



Type	Code
Turbo Edge® Adjustable Syphon	370873

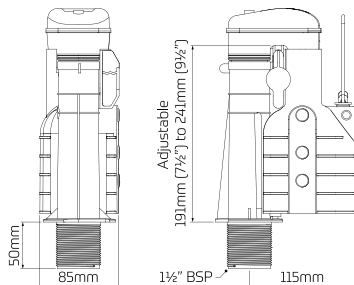

Dudley's Turbo Edge® is the world's most compact syphon, guaranteed to fit more places than any others, with absolutely no compromise on flush performance. Manufactured in the UK by Thomas Dudley, Turbo Edge® is guaranteed to fit into all types of lever-operated cistern currently available, offering plumbers, installers and designers a versatile, easy-to fit and easy-to-service solution even in the tightest spaces. Fully adjustable from 7½" to 9½".

THE BEST JUST GOT BETTER



Syphons 05



CASCADE+ SYPHON

SYPHONS // WASHROOM FILL & FLUSH

Compact one piece syphon that delivers exceptional flushing performance

- Suitable for low level use
- 6/7/9 litre convertible allowing flush to be configured
- Internal overflow
- 1½" [38mm] BSP outlet
- Can be used with a variety of different levers
- WRAS approved

Size	Code
7"	334642
7.5"	334643
8"	334644
8.5"	334645
9"	334607
9.5"	334646



ADJUSTABLE TURBO 88™

SYPHONS // WASHROOM FILL & FLUSH

The Adjustable Turbo 88™ is an adjustable syphon suitable for most lever operated cisterns

- Duoflush water-saving feature. This delivers a water-saving reduced flush when the cistern lever is depressed and held down
- It has a 2-part design that enables the syphon body to be simply removed from the cistern leaving the white downleg in position. This feature enables the Turbo 88™ to be serviced in under 5 minutes without disconnecting water supply and dismantling cistern
- Internal overflow
- 1½" [42mm] diameter outlet
- 6/7/9 Litre Convertible
- Compatible in most lever operated cisterns

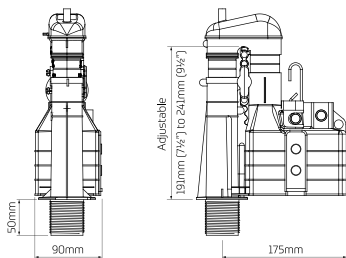

Item	Code
Adjustable Turbo 88™	324395

05 Syphons



TURBO 88™ FIXED HEIGHT

SYPHONS // WASHROOM FILL & FLUSH

The Turbo 88™ is an ideal replacement for syphons in most lever operated cisterns

- Duoflush water-saving feature. This delivers a water-saving reduced flush when the cistern lever is depressed and held down
- When the lever is depressed and released, the Turbo 88™ Duoflush delivers a full flush that is as reliable every time
- Internal overflow
- Compatible in most lever operated cisterns

Size	Code
7"	313826
7.5"	316965
8"	313639
8.5"	319023
9"	315293
9.5"	313673
10"	313879

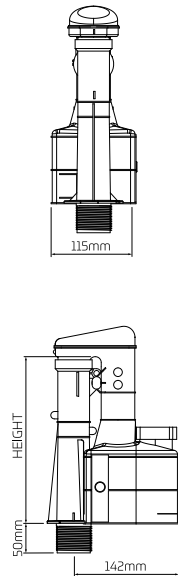

TURBO 44

SYPHONS // WASHROOM FILL & FLUSH

A WRAS approved 9 litre 2-part syphon. Suitable for high and low level use

- It has a 2-part design that enables the syphon body to be simply removed from the cistern leaving the white downleg in position. This feature enables the Turbo 44 to be serviced in under 5 minutes without disconnecting water supply and dismantling cistern
- The Turbo 44 has been designed specifically to suit narrow cisterns
- Internal overflow
- 38mm [$\frac{1}{2}$ "] Outlet
- 7/9 Litre Convertible
- Compatible in most lever operated cisterns. Specifically suited to narrow cisterns

Size	Code	Size	Code
8"	313326	10"	316300
8.5"	318546	10.5"	319200
9"	315749	11"	319764
9.5"	313970	11.5"	316943

Syphons 05



Turbo S1-11

A WRAS APPROVED 7 OR 9 LITRE 2-PART SYPHON. IDEAL FOR WELL-BOTTOMED CISTERNS

- Compatible in most low-level lever operated cisterns. Specifically suited well-bottomed cisterns

Size/Outlet	Code
9" Brass (Rubberline)	317449
9" Plastic (Rubberwell)	318743



S9 Hi-Flo

A WRAS APPROVED ONE-PIECE SYPHON. 6/7/9 LITRE CONVERTIBLE

- 6/7/9 Litre One Piece Syphon, suitable for high and low level use
- 38mm [1½"] Outlet
- Other sizes available please enquire
- Compatible in most low-level lever operated cisterns

Size/Outlet	Code
7½"	317963
8"	315308
9"	313553

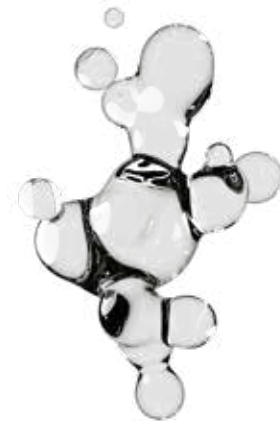

Auto Syphons

WRAS APPROVED AUTOMATIC SYPHON

- Easily controlled to minimise water usage with use of petcock
- Requires no electricity supply
- Requires virtually no maintenance
- Simple to install

Size/Flushing Height	Code
140mm (5½") – 1" BSPT	364932
140mm (5½") – 1¼" BSPT	325939
159mm (6¼") – 1" BSPT	364944
159mm (6¼") – 1¼" BSPT	364947
191mm (7½") – 1" BSPT	364948
191mm (7½") – 1¼" BSPT	364953
210mm (8¼") – 1" BSPT	364955
210mm (8¼") – 1¼" BSPT	364958
235mm (9¼") – 1" BSPT	364959
235mm (9¼") – 1¼" BSPT	364963

AUTO SYPHONS

SYPHONS // WASHROOM FILL & FLUSH

Our WRAS approved Auto Syphons have been available for over 30 years and have built an enviable reputation for both quality and reliability. This has resulted in their specification by many large OEM's for use in their own cisterns.

When it comes to controlling the flushing of urinals, the Auto Syphon is still the most inexpensive, trouble-free and simple to install product on the market.

The Auto Syphon requires NO electricity supply and with no moving parts it requires virtually no maintenance.

Designed to cater for the varied flushing requirements of large and small urinal w.c installations of all types conform to BS 1876 and are available in two outlet sizes:

- 1" [25mm] BSPT
- 1¼" [32mm] BSPT

All Auto Syphons are supplied complete with two rubber washers & back nut. Each Auto Syphon is fully tested before leaving the factory.

Can be used in conjunction with other products in our range such as:

- Sparge Pipes [Page 102]
- Spreaders [Page 102]
- Brackets [Page 88]
- Pet Cock [Page 102]
- Kinetic Range [Page 46]
- Urinal Wastes [Page 74]

06 Toilet Cisterns // Concealed



Dudley Vantage

TOILET CISTERNS // WASHROOM FILL & FLUSH

High quality concealed cistern designed specifically for use in bathroom furniture

- 460mm [W] x 369mm [H] x 125mm [D]
- Fitted with integral isolating valve & internal overflow warning
- Air tubes enable button, plate or sensor to be installed up to 750mm away from cistern
- Front & Top Access panels
- Compact dimensions enables the Dudley Vantage to fit neatly into furniture units as small as 500mm [W] x 200mm [D] x 800mm [H]
- Fitted with Hydroflo Side Inlet, Niagara Pneumatic Valve & Dio Button
- Available with ½" brass tail water supply connection*
- Other Options Available: Insulation Jacket, Single Flush, 73.5mm Button, Piazza Button, Royal Button, Oyster Plate, Reef Plate Coral Plate, Electroflo & more
- Vantage cisterns are available with a Type AB weir overflow (Fluid Category 5 Compliant)
- For other variations please contact TYDE



Thomas Dudley manufactures a market-leading range of high quality concealed cisterns. These are perfect for use in all domestic and commercial applications and can be used with confidence in fitted furniture or behind tiles and most partitioning materials. A vast range of pushbuttons, push plates, levers and touch-free electronic sensors is available to provide the perfect finishing touch to any project. The Vantage has been designed specifically for use in bathroom furniture. It is ideal for use behind tiles and partitioning and in most other concealed applications. Available in multiple specifications. Please contact TYDE for more information.

Size	Code
Dudley Vantage	322420

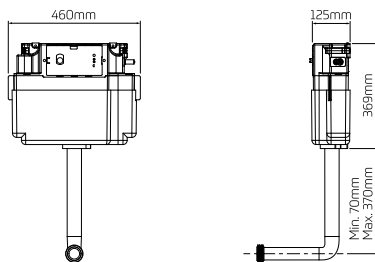

- Front and top access panels
- Compact dimensions
- The Dudley Vantage is available in multiple specification options

Visit our website



Toilet Cisterns // Concealed 06



Dudley Miniflo

HIGH QUALITY COMPACT CONCEALED TOILET CISTERN. DESIGNED TO FIT INTO SMALLER SPACES

- 411mm [W] x 276mm [H] x 131mm [D]
- Top Access
- Air tubes enable button, plate or sensor to be installed up to 750mm away from cistern
- Compact dimensions enables the Dudley Miniflo to fit neatly into 150mm ducts
- Internal overflow warning
- Fitted with Hydroflo Side Inlet
- Fitted with Niagara Pneumatic Valve
- Fitted with 51mm Chrome Plated Button
- Other Options Available; Bottom Inlet, Single Flush, Buttons, Plates & Electroflo
- For other variations please contact TYDE

Item	Code
Dudley Miniflo	322875



Dudley Mirage

CONCEALED TOILET CISTERN FITTED WITH VANDAL RESISTANT STOPS

- 505mm [W] x 285mm [H] x 146mm [D]
- 6/7 Litre convertible
- Top Access
- Levers are fitted with vandal-resistant stops to prevent them being rotated backwards
- Internal overflow warning
- WRAS Approved Dudley Part 3 Side Inlet
- WRAS Approved Dudley syphon
- Fitted with Kit W Extended Lever
- Other Options Available: Bottom Inlet, Turbo Edge®/88 Syphon, Kit P, Kit A, Kit B, Dimple Kit W, Cistern Only
- For other variations please contact TYDE

Item	Code
Dudley Mirage	316399



Dudley Phantom

CONCEALED TOILET CISTERN WITH TOP ACCESS AND INTERNAL OVERFLOW WARNING

- 420mm [W] x 300mm [H] x 150mm [D]
- Top Access
- Levers are fitted with vandal-resistant stops to prevent them being rotated backwards
- Internal overflow warning
- Fitted with Part 3 Side Inlet
- Fitted with Cascade Syphon
- Fitted with Kit W Extended Lever
- Other Options Available: Bottom Inlet, Turbo 88 Syphon, Kit P, Kit A, Kit B, Dimple Kit W, Cistern Only
- For other variations please contact TYDE

Item	Code
Dudley Phantom	315863

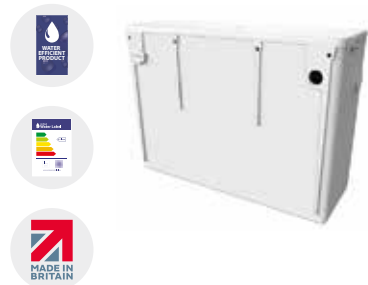

Dudley Pushflo

COMPACT CONCEALED TOILET CISTERN IDEAL FOR USE BEHIND TILES AND PARTITIONING

- 420mm [W] x 300mm [H] x 150mm [D]
- Can be either side or bottom inlet
- Air tubes enable button, plate or sensor to be installed up to 750mm away from cistern
- Compact dimensions fits neatly into most ducts
- Internal overflow warning
- Fitted with Hydroflo Side Inlet & Pinto Valve
- Fitted with Single Flush Royal Button
- Other Options Available: Bottom Inlet, Dome Button, Petite Button, Vandal Resistant Button
- For other variations please contact TYDE

Item	Code
Dudley Pushflo	319409



Dudley OSMO® F1

CONCEALED TOILET CISTERN - THE WORLD'S FIRST FRONT ACCESS SERVICEABLE SYPHON CISTERN

- 390mm [W] x 346mm [H] x 156mm [D]
- Designed for use with WC furniture & IPS panelling
- Fluid category 5 cistern
- Multiple flushing volumes: 6/4, 6/3, 4/2.6 Litre
- Front access
- Fitted with WRAS approved Turbo Edge® syphon & guaranteed to be leak-free
- WRAS approved Hydroflo with compact float & brass tail - fully compliant to BS 1212-4
- Actuator sold separately
- Unique registered light-touch design flush handle with dual flush control available in multiple finishes - For variations please contact TYDE

Item	Code
Dudley OSMO® F1 (right hand)	371854
Dudley OSMO® F1 (left hand)	371855

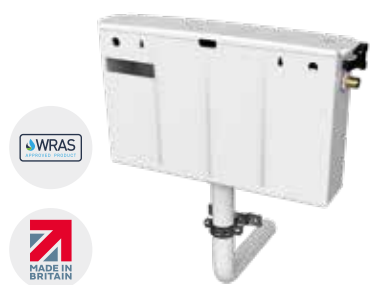

Dudley OSMO® T1

TOP ACCESS CONCEALED REVERSIBLE CISTERN WITH AXIS TECHNOLOGY™

- 550mm [W] x 315mm [H] x 110mm [D]
- Easy top access with reversible SnapLock lid™
- Unique reversible cistern body due to AXIS Technology™ achieving multiple outlet & inlet options
- Flush Pipe Stability System (FPSS™) with SureLock™ Bracket
- Multiple Flushing Volumes: 6/4 – 5/3 – 4/2.6 Litre (Alternative volumes upon request)
- Fluid category 5 cistern; the only way to achieve a water regulations compliant cistern in standard height pod shelves
- WRAS Approved Niagara pneumatic flush valve
- WRAS Approved Victoria cable flush valve
- WRAS Approved Hydroflo 7s Delay Fill Brass Tail Inlet Valve (Side or Bottom Inlet)
- For other variations please contact TYDE

Item	Code
Dudley OSMO® T1	377201

06 Toilet Cisterns // Exposed



Dudley Acclaim

CONTEMPORARY STYLED EXPOSED TOILET CISTERN IDEAL FOR LIGHT TO MEDIUM USE

- 460mm [W] x 343mm [H] x 155mm [D]
- Contemporary Styling
- Fitted with Part 3 Side Inlet and an Internal Overflow Warning
- White plastic lever as standard, chrome available
- Cistern body manufactured in high density polystyrene
- A pushbutton operated acclaim also available
- Internal overflow warning
- Fitted with Cascade+ Syphon or Niagara Mechanical Valve
- Other Options Available: Bottom Inlet, High Level, T88 Syphon and Hydroflo
- For other variations please contact TYDE

Outlet/Actuator	Code
Syphon – White Lever	315196
Valve – Button	319125



Dudley Diplomat

TRADITIONALLY STYLED EXPOSED TOILET CISTERN IDEAL FOR LIGHT TO MEDIUM USE

- 498mm [W] x 295mm [H] x 186mm [D]
- Fitted with Part 3 Side Inlet and an Internal Overflow Warning
- Various fitting options available including levers and buttons
- Cistern body manufactured in high density polystyrene
- Fitted with Cascade+ Syphon
- Fitted with White Lever
- Other Options Available: Bottom Inlet, High Level, Turbo 88, Hydroflo, Black
- For other variations please contact TYDE

Item	Code
Dudley Diplomat	319217



Dudley Elite

TRADITIONALLY STYLED EXPOSED TOILET CISTERN IDEAL FOR LIGHT TO MEDIUM USE

- 584mm [W] x 330mm [H] x 140mm [D]
- Fitted with Part 3 Side Inlet and an Internal Overflow Warning
- Various fitting options available including levers and buttons
- Cistern body manufactured in high density polystyrene
- Fitted with Cascade+ Syphon
- Fitted with White Lever
- Other Options Available: Bottom Inlet, T88 Syphon, Hydroflo.
- For other variations please contact TYDE

Item	Code
Dudley Elite	319189



Dudley Slimline

TRADITIONALLY STYLED EXPOSED TOILET CISTERN IDEAL FOR LIGHT TO MEDIUM USE

- 505mm [W] x 316mm [H] x 146mm [D]
- Fitted with Part 3 Side Inlet and an Internal Overflow Warning
- Black & white low level models come with white lever as standard. High level options supplied with chain pull
- Various fitting options available including levers and buttons
- Fitted with Cascade+ Syphon
- Other Options Available: Bottom Inlet, T88 Syphon, Hydroflo, Black Cistern
- For other variations please contact TYDE

Item	Code
Dudley Slimline	315262



Dudley Tri-Shell Turbo

EXPOSED TOILET CISTERN SUITABLE FOR WHERE THERE MAY BE THE POTENTIAL FOR VANDALISM OR MISUSE

- 516mm [W] x 287mm [H] x 188mm [D]
- Fitted with Part 3 Side Inlet and an Internal Overflow Warning
- Cistern body manufactured using a unique sandwich foam moulding process, which provides unsurpassed strength and durability
- Fitted with Turbo 88 Syphon
- Fitted with Chrome Plated Plastic Lever
- Other Options Available: Bottom Inlet, High Level, Hydroflo, Dimple Lever, Black
- For other variations please contact TYDE

Item	Code
Dudley Tri-Shell Turbo	315754



Dudley Tri-Well Turbo

EXPOSED CHAIN PULL ACTIVATED TOILET CISTERN SUITABLE WHERE THERE MAY BE THE POTENTIAL FOR VANDALISM OR MISUSE

- 467mm [W] x 292mm [H] x 243mm [D]
- Fitted with Part 3 Side Inlet and an Internal Overflow Warning
- Cistern body manufactured using a unique sandwich foam moulding process, providing unsurpassed strength & durability
- Fitted with Turbo 51-11 Syphon
- Fitted with Metal Fulcrum Arm
- Other Options Available: Black, Brass Tailed Syphon Outlet, Pt.2 Brass Ball Valve
- For other variations please contact TYDE

Item	Code
Dudley Tri-Well Turbo	313510

Toilet Cisterns // Auto 06



Dudley Acclaim Auto

EXPOSED AUTOMATIC TOILET CISTERN FINISHED TO A HIGH GLOSS

- 460mm [W] x 343mm [H] x 155mm [D]
- Outlet centre 74mm from wall
- Fitted with 4.5 Litre Auto Syphon
- Other Option Available: 9 Litre
- High-gloss finish in white
- Cistern body in high-impact polystyrene
- Supplied with automatic syphon and petcock
- For other variations please contact TYDE

Item	Code
Dudley Acclaim Auto	314934



Dudley 'D' Auto

EXPOSED AUTOMATIC TOILET CISTERN FINISHED TO A HIGH-GLOSS

- 498mm [W] x 295mm [H] x 186mm [D]
- Outlet centre 93mm from wall
- Fitted with 4.5 Litre Auto Syphon
- Other Options Available: 9 Litre, 13.5 Litre, Black
- High-gloss finish in white or black
- Cistern body manufactured in high impact polystyrene.
- Supplied with automatic syphon and petcock
- Black version available
- For other variations please contact TYDE

Item	Code
Dudley 'D' Auto	317960



Dudley Tri-Shell Heavy Duty Auto

EXCEPTIONALLY STRONG EXPOSED AUTOMATIC TOILET CISTERN FINISHED TO A HIGH GLOSS

- 516mm [W] x 287mm [H] x 188mm [D]
- Outlet centre 90mm from wall
- Fitted with 4.5 Litre Auto Syphon
- Other Options Available: 9 Litre, 13.5 Litre, Black
- High-gloss finish in white or black
- Cistern body manufactured using a unique sandwich foam moulding process making it exceptionally strong
- Supplied with automatic syphon and petcock
- For other variations please contact TYDE

Item	Code
Dudley Tri-Shell Heavy Duty Auto	315633



Dudley Mirage Concealed Auto

TOILET CISTERN PERFECT FOR USE IN MODERN CONCEALED WASHROOMS

- 505mm [W] x 285mm [H] x 146mm [D]
- Outlet centre 73mm from wall
- Fitted with 4.5 ltr Auto Syphon
- Other Options Available: 9 or 13.5 Litre capacities
- Cistern body in high-impact polystyrene
- Supplied with automatic syphon and petcock
- For other variations please contact TYDE

Item	Code
Dudley Mirage Concealed Auto	314128



For all cistern spares please see pages 182-184

Dudley automatic cisterns can also be supplied with the Kinetic intelligent urinal control please see page 46

Cisterns // Options // Concealed

Supplied factory assembled with front and top access panels. Single flush (6 litre) or dualflush 6/4 Litre that converts to a 5/3 Litre or 4/2.6 Litre (Button packed with Cistern) 460mm (W) x 369mm (H) x 125mm (D)

Code	Product Name	Option	Description
Dualflush With Polystyrene Insulation Jacket and with:			
320433	Dudley Vantage		No Button
322422	Dudley Vantage		51mm Dio Button
325285	Dudley Vantage		73.5mm Piazza Button
319710	Dudley Vantage		73.5mm Chrome Plated Button
326917	Dudley Vantage		Reef Flush Plate
327023	Dudley Vantage		Coral Flush Plate
325040	Dudley Vantage		Pearl Classic Push Plate
326680	Dudley Vantage		Pearl Palm Push Plate
323377	Dudley Vantage		Chrome Plated Oyster Dualflush Push Plate
322892	Dudley Vantage		Electroflo Dualflush Infrared Sensor with 40mm CP Surround

Dualflush Without Polystyrene Insulation Jacket and With:			
313330	Dudley Vantage		No Button
322420	Dudley Vantage		51mm Dio Button
325284	Dudley Vantage		73.5mm Piazza Button
319194	Dudley Vantage		73.5mm Chrome Plated Button
323376	Dudley Vantage		Oyster Push Plate
327022	Dudley Vantage		Coral Push Plate
326681	Dudley Vantage		Pearl Palm Push Plate
322891	Dudley Vantage		Electroflo Dualflush Infrared Sensor with 100mm CP Surround
326922	Dudley Vantage		Wave S1 Electronic Flush Plate
326936	Dudley Vantage		Wave S2 Electronic Flush Plate
330791	Dudley Vantage		Wave S3 Electronic Flush Plate - Square Corners
330781	Dudley Vantage		Wave S3 Electronic Flush Plate - Radius Corners

Single Flush (Button packed with Cistern) With Polystyrene Insulation Jacket and with:			
314454	Dudley Vantage		51mm Royal Chrome Plated Button
325635	Dudley Vantage		51mm Royal Palm Push Button
325287	Dudley Vantage		73.5mm Piazza Button
314408	Dudley Vantage		73.5mm Chrome Plated Button
322888	Dudley Vantage		Electroflo Infrared Sensor with 40mm CP Surround

Single Flush Without Polystyrene Insulation Jacket and With:			
318750	Dudley Vantage		51mm Royal Chrome Plated Button
324600	Dudley Vantage		51mm Royal Palm Push Button
325286	Dudley Vantage		73.5mm Piazza Button
319787	Dudley Vantage		73.5mm Chrome Plated Button
320133	Dudley Vantage		Stainless Steel Royal Single Flush Push Button
322887	Dudley Vantage		Electroflo Infrared Sensor with 100mm CP Surround
322889	Dudley Vantage		Electroflo Infrared Sensor with 40mm CP Surround
330236	Dudley Vantage		Remora Satin Stainless Steel Single Flush Push Button

Pneumatically operated Cistern with 6/4 litre dualflush. Can be converted to 5/3 or 4/2.6 litre dualflush. Supplied assembled and comes with flushbend, hanging bracket, Hydroflo Inlet and Niagara Outlet Valve - 411mm (W) x 276mm (H) x 131mm (D). (Button packed with Cistern).

Code	Product Name	Option	Description
322875	Dudley MiniFlo	SISO	Dualflush CP Button
322876	Dudley MiniFlo	BIBO	Dualflush CP Button
322878	Dudley MiniFlo	SISO	Single Flush Royal CP Button (51mm)
322879	Dudley MiniFlo	BIBO	Single Flush Royal CP Button (51mm)
324875	Dudley MiniFlo	BIBO	Electroflo Singleflush Infrared Sensor with 100mm CP Surround
324728	Dudley MiniFlo	SISO	Electroflo Singleflush Infrared Sensor with 100mm CP Surround
324841	Dudley MiniFlo	SISO	Electroflo Dualflush Infrared Sensor with 40mm CP Surround
325021	Dudley MiniFlo	SISO	Electroflo Dualflush Infrared Sensor with 100mm Surround
325289	Dudley MiniFlo	SISO	Dualflush CP Piazza Button
325291	Dudley MiniFlo	SISO	Single Flush CP Piazza Button
325447	Dudley MiniFlo	SISO	Single Flush CP Palm Push Button
325629	Dudley MiniFlo	SISO	Single Flush Stainless Steel 160mm Royal Push Button
325802	Dudley MiniFlo	SISO	Dualflush CP Pearl Classic Push Plate
327787	Dudley MiniFlo	SISO	Dualflush CP Dio Button

For more cistern information, please see pages 34-37

Cisterns // Options // Concealed

**Concealed slimline plastic Cistern with 6/7 litre convertible syphon - 505mm (W) x 285mm (H) x 146mm (D).
Connections can be left or right handed**

Code	Product Name	Option	Description
313098	Dudley Mirage	SISO	Mirage Cistern Only - (Without Lever Kit)
319503	Dudley Mirage	BIBO	Mirage Cistern Only - (Without Lever Kit)
315770	Dudley Mirage	SISO	KIT 'A' CP Lever for wall and duct up to 245mm overall (325mm spindle, 260mm bush)
313961	Dudley Mirage	BIBO	KIT 'A' CP Lever for wall and duct up to 245mm overall (325mm spindle, 260mm bush)
317725	Dudley Mirage	SISO	KIT 'B' CP Lever for wall and duct up to 365mm overall (430mm spindle, 368mm bush)
314332	Dudley Mirage	BIBO	KIT 'B' CP Lever for wall and duct up to 365mm overall (430mm spindle, 368mm bush)
316647	Dudley Mirage	SISO	KIT 'P' CP Lever for Cistern fitted immediately behind 12-65mm partition (115mm spindle, 80mm bush)
314994	Dudley Mirage	BIBO	KIT 'P' CP Lever for Cistern fitted immediately behind 12-65mm partition (115mm spindle, 80mm bush)
316399	Dudley Mirage	SISO	KIT 'W' CP Lever for Cistern fitted immediately behind 114mm wall (225mm spindle, 160mm bush)
317251	Dudley Mirage	BIBO	KIT 'W' CP Lever for Cistern fitted immediately behind 114mm wall (225mm spindle, 160mm bush)
316701	Dudley Mirage	SISO	DIMPLE KIT 'W' for easy flushing by the less able CP Lever for cistern fitted immediately behind 145mm wall (225mm spindle, 160mm bush)
317937	Dudley Mirage	BIBO	DIMPLE KIT 'W' for easy flushing by the less able CP Lever for cistern fitted immediately behind 145mm wall (225mm spindle, 160mm bush)

**Concealed plastic Cistern with water saving 6/7 litre convertible Duoflush syphon - 420mm (W) x 300mm (H) x 150mm (D).
Connection can be left or right handed**

Code	Product Name	Option	Description
316709	Dudley Phantom	SISO	Phantom Cistern Only (Without Lever Kit)
319685	Dudley Phantom	BIBO	Phantom Cistern Only (Without Lever Kit)
313867	Dudley Phantom	SISO	Kit 'A' CP Lever for wall and duct up to 245mm overall (325mm spindle, 260mm bush)
317985	Dudley Phantom	BIBO	Kit 'A' CP Lever for wall and duct up to 245mm overall (325mm spindle, 260mm bush)
319721	Dudley Phantom	SISO	Kit 'B' CP Lever for wall and duct up to 365mm overall (430mm spindle, 368mm bush)
314013	Dudley Phantom	BIBO	Kit 'B' CP Lever for wall and duct up to 365mm overall (430mm spindle, 368mm bush)
315563	Dudley Phantom	SISO	KIT 'P' CP Lever for cistern fitted immediately behind 12-65mm partition (115mm spindle, 80mm bush)
319758	Dudley Phantom	BIBO	KIT 'P' CP Lever for cistern fitted immediately behind 12-65mm partition (115mm spindle, 80mm bush)

Concealed plastic Cistern - 420mm (W) x 300mm (H) x 150mm (D). Connection can be left or right handed

Code	Product Name	Option	Description
315863	Dudley Phantom	SISO	Kit 'W' CP Lever for cistern fitted immediately behind 145mm wall (225mm spindle, 160mm bush)
313088	Dudley Phantom	BIBO	Kit 'W' CP Lever for cistern fitted immediately behind 145mm wall (225mm spindle, 160mm bush)
323986	Dudley Phantom		LL 6L with 'Niagara' Pneumatic Single Flush Valve and Stainless Steel Ext. Royal Push Button
324836	Dudley Phantom		LL 6L with 'Pinto' Pneumatic Single Flush Valve and Extended Flat Metal Vandal Resistant Push Button

**Concealed 6 or 7 litre plastic Cistern with Dudley Pinto pneumatic flushvalve - 420mm (W) x 300mm (H) x 150mm (D).
Connection can be left or right handed**

Code	Product Name	Option	Description
320267	Dudley Pushflo	SISO	Cistern with Petite Button
314197	Dudley Pushflo	SISO	Cistern with Dome Button
319409	Dudley Pushflo	SISO	Cistern with Cone Button
320507	Dudley Pushflo	BIBO	Cistern with Petite Button
317950	Dudley Pushflo	BIBO	Cistern with Dome Button
315076	Dudley Pushflo	BIBO	Cistern with Cone Button
319312	Dudley Pushflo	BIBO	Cistern with Pinto Button

**Concealed 6 or 7 litre plastic Cistern with Dudley Niagara pneumatic flushvalve - 420mm (W) x 300mm (H) x 150mm (D).
Connection can be left or right handed**

Code	Product Name	Option	Description
318552	Dudley Royal Pushflo	SISO	Cistern with Royal Pushbutton
324204	Dudley Royal Pushflo	SISO	Cistern with Palm Pushbutton
313922	Dudley Royal Pushflo	BIBO	Cistern with Royal Pushbutton
324205	Dudley Royal Pushflo	BIBO	Cistern with Palm Pushbutton

For more cistern information, please see pages 34-37

Cisterns // Options // Exposed

Plastic Cistern with water saving 6/4 litre convertible Duoflush syphon - 460mm (W) x 343mm (H) x 155mm (D). Connections can be left or right handed

Code	Product Name	Option	Description
317712	Dudley Acclaim 'S'	SISO	H/L White
315196	Dudley Acclaim 'S'	SISO	L/L White (with white Front Lever)
316015	Dudley Acclaim 'S'	SISO	L/L White (with White Lever)
313397	Dudley Acclaim 'S'	BIBO	H/L White
314328	Dudley Acclaim 'S'	BIBO	L/L White (with white Front Lever)

Plastic Cistern with 6/4 litre dualflush Dudley Niagara valve with CP top push button

Code	Product Name	Option	Description
319125	Dudley Acclaim V	SISO	L/L White
314488	Dudley Acclaim V	BIBO	L/L White

Plastic Cistern with water saving 6/7/9 litre convertible Duoflush syphon - 498mm (W) x 295mm (H) x 186mm (D)

Code	Product Name	Option	Description
318229	Dudley Diplomat	SISO	H/L (with reversible LH or RH)
319217	Dudley Diplomat	SISO	L/L (with White Front Lever)
316733	Dudley Diplomat	BIBO	H/L (with reversible LH or RH)
319640	Dudley Diplomat	BIBO	L/L (with White Front Lever)

Plastic Panel Cistern with water saving 6/7 litre convertible Duoflush syphon - 584mm (W) x 330mm (H) x 140mm (D). Connections can be left or right handed

Code	Product Name	Option	Description
319189	Dudley Elite	SISO	L/L White (with White Front Lever)
318491	Dudley Elite	BIBO	L/L White (with White Front Lever)

Plastic multi-purpose Cistern with water saving 6/7 litre convertible Duoflush syphon - 505mm (W) x 316mm (H) x 146mm (D). Connection can be left or right handed

Code	Product Name	Option	Description
315262	Dudley Slimline	SISO	L/L (with White Front Lever) - White
313280	Dudley Slimline	BIBO	L/L (with White Front Lever) - White

Sandwich foam heavy duty plastic Cistern with water saving 6/7/9 litre convertible Dudley syphon - 516mm (W) x 287mm (H) x 188mm (D)

Code	Product Name	Option	Description
317978	Dudley Tri-Shell Turbo	SISO	H/L with Turbo 88 single flush 2-part 6/7/9L convertible syphon and reversible LH or RH Chain Pull - White
319617	Dudley Tri-Shell Turbo	SISO	H/L with Turbo 88 single flush 2-part 6/7/9L convertible syphon and reversible LH or RH Chain Pull - Black
315754	Dudley Tri-Shell Turbo	SISO	L/L with Turbo 88 Duoflush 2-part 6/7/9L convertible syphon - White
314289	Dudley Tri-Shell Turbo	SISO	L/L with Turbo 88 Duoflush 2-part 6/7/9L convertible syphon - Black
314218	Dudley Tri-Shell Turbo	BIBO	H/L with Turbo 88 single flush 2-part 6/7/9L convertible syphon and reversible LH or RH Chain Pull - White
313491	Dudley Tri-Shell Turbo	BIBO	H/L with Turbo 88 single flush 2-part 6/7/9L convertible syphon and reversible LH or RH Chain Pull - Black
318021	Dudley Tri-Shell Turbo	BIBO	L/L with Turbo 88 Duoflush 2-part 6/7/9L convertible syphon - White
319457	Dudley Tri-Shell Turbo	BIBO	L/L with Turbo 88 Duoflush 2-part 6/7/9L convertible syphon - Black

Sandwich foam heavy duty well-bottom Cistern with Turbo S1-11, 2 part 6/7/9 litre convertible syphon - 467mm (W) x 292mm (H) x 243mm (D)

Code	Product Name	Option	Description
313510	Dudley Tri-Well Turbo	SISO	H/L with plastic outlet and nuts and reversible LH or RH Chain Pull - White
315207	Dudley Tri-Well Turbo	SISO	H/L with plastic outlet and nuts and reversible LH or RH Chain Pull - Black
313810	Dudley Tri-Well Turbo	SISO	H/L with brass outlet and nuts and reversible LH or RH Chain Pull - White
319868	Dudley Tri-Well Turbo	SISO	H/L with brass outlet and nuts and reversible LH or RH Chain Pull - Black

For more cistern information, please see pages 34-37

Cisterns // Options // Auto

Thermoplastic Automatic Cistern - 460mm (W) x 343mm (H) x 155mm (D)

Code	Product Name	Option	Description
314934	Dudley Acclaim Auto	White	4.5 Litre (1 Gallon)
314002	Dudley Acclaim Auto	White	9.0 Litre (2 Gallon)

Thermoplastic Automatic Cistern - 498mm (W) x 295mm (H) x 186mm (D)

Code	Product Name	Option	Description
317960	Dudley 'D' Auto	White	4.5 Litre (1 Gallon)
319337	Dudley 'D' Auto	Black	4.5 Litre (1 Gallon)
314825	Dudley 'D' Auto	White	9.0 Litre (2 Gallon)
314698	Dudley 'D' Auto	Black	9.0 Litre (2 Gallon)
314494	Dudley 'D' Auto	White	13.5 Litre (3 Gallon)
318580	Dudley 'D' Auto	Black	13.5 Litre (3 Gallon)
317622	Dudley 'D' Auto	White	13.5 Litre (3 Gallon)

Sandwich foam heavy duty plastic Automatic Cistern - 516mm (W) x 287mm (H) x 188mm (D)

Code	Product Name	Option	Description
315633	Dudley Tri-Shell Auto	White	4.5 Litre (1 Gallon)
318283	Dudley Tri-Shell Auto	Black	4.5 Litre (1 Gallon)
315651	Dudley Tri-Shell Auto	White	9.0 Litre (2 Gallon)
315023	Dudley Tri-Shell Auto	Black	9.0 Litre (2 Gallon)
314767	Dudley Tri-Shell Auto	White	13.5 Litre (3 Gallon)
313244	Dudley Tri-Shell Auto	Black	13.5 Litre (3 Gallon)

Concealed thermoplastic Automatic Cistern - 505mm (W) x 285mm (H) x 146mm (D)

Code	Product Name	Option	Description
318281	Dudley Mirage Auto		9.0 Litre (1 Gallon)
319755	Dudley Mirage Auto		13.5 Litre (3 Gallon)

For more cistern information, please see pages 34-37

07 Touch Free



Electroflo® Contemporary™ Tap

TOUCH FREE // WASHROOM FILL & FLUSH

Touch-Free Contemporary Tap

- Stylish tubular design
- Hygienic touch-free operation
- Robust brass body
- Attractive chrome plated, stainless steel or black finishes are available
- Delivers cold or premixed warm water
- Shuts off when hand is removed from in front of sensor
- Water delivery automatically stops after 90 seconds
- Pre-fitted with 5LPM flow regulator
- Suitable for pressures of 0.5-8.0 bar + with flow restrictor
- 316G Stainless Steel version available



Finish/Power	Code
Polished Chrome – Mains	323681
Polished Chrome – Battery	323680
Stainless Steel Effect – Mains	327965
Matt Black – Mains	327966

Our Dudley Electroflo Contemporary Tap is a vanity top/basin mounted electronic tap. Ideal for use in most domestic and commercial applications. Its contemporary design will improve the look of any washroom. Delivers as little as 1 litre of water per visit.

- Stylish tubular design
- Hygienic touch-free operation



Polished Chrome



Stainless Steel Effect



Matt Black

Visit our website



Touch Free // Soap Dispensors 07



Polished Chrome



Stainless Steel Effect



Matt Black

ELECTROFLO® CONTEMPORARY™ SOAP DISPENSER

TOUCH FREE // WASHROOM FILL & FLUSH

Touch-Free Contemporary™ Soap Dispenser and Hand Sanitiser

- Stylish tubular design
- Hygienic touch-free operation
- Robust brass body
- Attractive chrome plated, stainless steel or black finishes are available
- 1 litre capacity
- 50mm – 300mm sensor range
- Suitable for soap and hand sanitiser with viscosities of 0 to 3800cps

Finish/Power	Code
Polished Chrome – Mains	324327
Polished Chrome – Battery	326437
Stainless Steel Effect – Mains	327974
Matt Black – Mains	327975

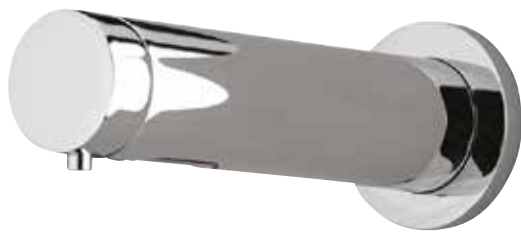

Polished Chrome



Stainless Steel Effect



Matt Black

ELECTROFLO® HORIZON™ SOAP DISPENSER

TOUCH FREE // WASHROOM FILL & FLUSH

Touch-Free Horizontal™ Soap Dispenser and Hand Sanitiser

- Minimalistic design
- Hygienic touch-free operation
- Robust brass body
- Attractive chrome plated, stainless steel or black finishes are available
- 1 litre capacity
- 50mm – 300mm sensor range
- Suitable for soap and hand sanitiser with viscosities of 0 to 3800cps

Finish/Power	Code
Polished Chrome – Mains	325423
Polished Chrome – Battery	325424
Stainless Steel Effect – Mains	327976
Matt Black – Mains	327977

07 Touch Free // Taps



Polished Chrome



Stainless Steel Effect



Matt Black

ELECTROFLO® HORIZON TAP

TOUCH FREE // WASHROOM FILL & FLUSH

Touch-Free Horizon Tap

- Minimalistic design
- Hygienic touch-free operation
- Delivers cold or premixed warm water
- Shuts off when hand is removed from in front of sensor
- Water delivery automatically stops after 90 seconds
- Suitable for pressures of 0.5-8.0 bar + with flow restrictor
- 50mm – 300mm sensor range
- Supports BREEAM
- Pre-fitted with 5LPM flow regulator
- 316G Stainless Steel version available

Finish/Power	Code
Polished Chrome – Mains	324329
Polished Chrome – Battery	324328
Stainless Steel Effect – Mains	327968
Matt Black – Mains	327969



Polished Chrome



Stainless Steel Effect

ELECTROFLO® ARC TAP

TOUCH FREE // WASHROOM FILL & FLUSH

Touch-Free Arc tap

- Classic Swan Neck design
- Hygienic touch-free operation
- Delivers cold or premixed warm water
- Shuts off when hand is removed from in front of sensor
- Water delivery automatically stops after 90 seconds
- Suitable for pressures of 0.5-8.0 bar + with flow restrictor
- Pre-fitted with 5LPM flow regulator

Finish	Code
Polished Chrome - Mains	327972
Stainless Steel Effect - Mains	327973

Touch Free // Taps 07



Polished Chrome



Stainless Steel Effect

ELECTROFLO® LINEAR TAP

TOUCH FREE // WASHROOM FILL & FLUSH

Touch-Free Linear Tap

- Minimalistic design
- Hygienic touch-free operation
- Delivers cold or premixed warm water
- Shuts off when hand is removed from in front of sensor
- Water delivery automatically stops after 90 seconds
- Suitable for pressures of 0.5-8.0 bar + with flow restrictor
- 50mm – 300mm sensor range
- Supports BREEAM
- Pre-fitted with 5LPM flow regulator

Finish/Power	Code
Polished Chrome – Mains	323685
Polished Chrome – Battery	323684
Stainless Steel Effect – Mains	327967



Polished Chrome



Stainless Steel Effect

ELECTROFLO® AVANTI TAP

TOUCH FREE // WASHROOM FILL & FLUSH

Touch-Free Avanti Tap

- Sleek minimalistic design
- Hygienic touch-free operation
- Delivers cold or premixed warm water
- Shuts off when hand is removed from in front of sensor
- Water delivery automatically stops after 90 seconds
- Suitable for pressures of 0.5-8.0 bar + with flow restrictor
- 50mm – 300mm sensor range
- Supports BREEAM
- Pre-fitted with 5LPM flow regulator

Finish	Code
Chrome - Mains	326400
Stainless Steel Effect - Mains	326575

07 Touch Free // Urinal Controls



KINETIC® INFRARED URINAL FLUSH CONTROL

TOUCH FREE // WASHROOM FILL & FLUSH

Dudley Kinetic® intelligent multi urinal flush control

- Ideal for use with automatic cisterns and multiple station urinals
- Can be easily installed into pipework, wall or ceiling mounted applications.
- Supplied with an aesthetically pleasing flush mounting kit.
- Each unit can be powered by mains, 4 x AA batteries or mains with battery backup (batteries not included).
- Control box can be installed remotely from the solenoid and is supplied as standard with a 1m cable.
- Can be serviced without removing the Kinetic controller and opening the Kinetic valve
- Passive infrared sensor detects user movement. After a pre-set time, the solenoid valve allows water to fill the cistern and deliver a flush.
- Fast fill reduces scale build up.
- Suitable for water pressures ranging from 0.1 bar to 10 bar.
- Quick and simple set up via user-friendly buttons and intuitive software without having to continually refill and empty the automatic cistern.
- 12 hour hygiene and 24 hour economy flushing modes can also be quickly configured to customer requirements.
- Tamper proof design and chrome fittings are conveniently included.
- Control box dimensions: 118mm(h) x 118mm(w) x 33mm(d).
- Solenoid box dimensions: 98mm(h) x 100mm(w) x 50mm(d).
- Regulates flushing based on actual washroom usage to save up to 80% of water when compared to traditional systems.

Finish	Code
White/White	327877
Grey/Grey	327878

Kinetic Package Options

Includes: Kinetic in White/White, 4.5L Dudley 'D' Auto Cistern, 1pc Sparge Pipe Set & Top Inlet Spreader	330272
Includes: Kinetic in White/White, 9L Dudley 'D' Auto Cistern, 2pc Sparge Pipe Set & Top Inlet Spreaders	330273
Includes: Kinetic in White/White, 13.5L Dudley 'D' Auto Cistern, 3pc Sparge Pipe Set & Top Inlet Spreaders	330274
Includes: Kinetic in White/White, 9L Dudley 'Tri-Shell' Auto Cistern, 2pc Sparge Pipe Set & Top Inlet Spreaders	330277



Can be used in conjunction with other products in our range, please see page 102

Touch Free // Urinal Controls // WC Controls 07



Chrome



Stainless Steel



Matt Black

ELECTROFLO® TOUCH FREE URINAL SENSOR

TOUCH FREE // WASHROOM FILL & FLUSH

Touch Free Flushing For Direct Flush Urinal Systems

- Provides touch free flushing for direct flush urinal systems.
- 300 – 800mm Adjustable Sensor Range
- Mains or Battery Powered – check relevant product code
- 6 Second Preset Flush Time
- Can be supplied with Dudley DC Pipe Interrupter - 327995 (air gap) to achieve fluid category 5 back flow prevention
- Adjustable flow rate and flush time
- Programmable flow time
- Sensor bezel available in various finishes

Finish/Power	Code
Chrome – Mains	323687
Stainless Steel Effect – Mains	327979
Matt Black – Mains	333959
Chrome – Battery	323686



Chrome



Stainless Steel



Matt Black

ELECTROFLO® TOUCH FREE WC KIT

TOUCH FREE // WASHROOM FILL & FLUSH

Touch Free Flushing For Concealed Cisterns

- Dual flush functionality can deliver 6/4, 5/3 or 4/2.6 litre flush volumes
- Ø40mm IR sensor available in chrome and matt black finishes or machined 304 stainless steel
- Ø100mm IR sensor includes instructional graphics
- Sensor detects a plurality of hand gestures; wave for full flush, hold hand in front of sensor for reduced flush
- LED flush indication
- Post flush sensor delay allows the cistern to refill before another flush can be delivered
- Control box can be integrally mounted with the sensor at the rear of the panel or independently mounted onto a suitable flat surface

Finish/Power/Size	Code
Stainless Steel – Mains – 40mm	371959
Matt Black – Mains – 40mm	372097
Chrome – Mains – 40mm	333388
Chrome – Mains – 100mm	372172

07 Touch Free // Accessories



Remote Control

REMOTE CONTROL FOR ELECTROFLO RANGE

- Allows same settings to be quickly applied to multiple individual taps

Item	Code
Tap Remote Control	323690
Dispensor Remote Control	327987



Thermostatic Mixing Valve

DUDLEY THERMOSTATIC MIXING VALVE

- Perfect for use with Dudley Electroflo Taps
- Can be used with pressures of 0.2 – 10 bar
- Delivers water between 30° and 50°
- Integral check valves and filters
- Available in 15mm and 22mm

Size	Code
15mm	324551
22mm	324552



Tap Junction Box

DUDLEY TAP JUNCTION BOX

- The Dudley Tap Junction box is perfect for powering up to 10 Electroflo Taps
- Two and Three way male to female and female to male power splitters available

Item	Code
Tap Junction Box	323691



Resan Sanitaryware // Basins 08



RESAN BASIN

RESAN SANITARYWARE // WASHROOM FILL & FLUSH

Anti-Ligature Basin Nose and 2 Tap Outlets

- Damage resistant basins, ideal for use in all applications where there may be the potential for vandalism, heavy treatment or misuse.
- Damage resistant and anti-ligature.
- Back to wall design allows all pipework to be safely concealed.
- Can be installed in conjunction with anti-ligature, water-saving basin controls.
- Water flow can be activated with pneumatic or electronic controls – please enquire.
- Easy clean matt and gloss finishes.
- Bespoke colours and designs can be supplied subject to sufficient demand.

Product	Code
Resan Basin Suitable for Pneumatic Controls	333883



RESAN BASIN

RESAN SANITARYWARE // WASHROOM FILL & FLUSH

Anti-Ligature Basin With Nose and 2 Tap Outlets

- Infrared Controlled
- Damage resistant basins, ideal for use in all applications where there may be the potential for vandalism, heavy treatment or misuse
- Damage resistant and anti-ligature
- Back to wall design allows all pipework to be safely concealed
- Infrared touch-free sensors can be used in through-wall applications up to 140mm thick when using extension piece
- Non-Flammable - BS476 Pt 6 & 7 Class '0' and Class '1'
- ISO EN 19712-3-2007 Rated 5 for durability, stain resistance and cigarette burns
- UK Ministry Of Justice Safer Cell Approved

Product	Code
Resan Basin	371149

08 Resan Sanitaryware // Basins



RESAN BASIN

RESAN SANITARYWARE // WASHROOM FILL & FLUSH

Anti-Ligature Basin with Central Single Tap Hole

- Damage resistant basins, ideal for use in all applications where there may be the potential for vandalism, heavy treatment or misuse
- Damage resistant and anti-ligature
- Back to wall design allows all pipework to be safely concealed
- Can be installed in conjunction with anti-ligature, water-saving basin controls
- Water flow can be activated with pneumatic or electronic controls – please enquire
- Easy clean matt and gloss finishes
- Bespoke colours and designs can be supplied subject to sufficient demand

Product	Code
Resan Basin	333887



RESAN BASIN

RESAN SANITARYWARE // WASHROOM FILL & FLUSH

Anti-Ligature Basin with Plain Back

- Damage resistant basins, ideal for use in all applications where there may be the potential for vandalism, heavy treatment or misuse
- Damage resistant and anti-ligature
- Back to wall design allows all pipework to be safely concealed

Product	Code
Resan Basin	333885

Resan Sanitaryware // Basins 08



RESAN BASIN

RESAN SANITARYWARE // WASHROOM FILL & FLUSH

Oval Wall Fixed Basin 1 Tap Hole No Overflow

- Damage resistant basins, ideal for use in all applications where there may be the potential for vandalism, heavy treatment or misuse
- Back to wall design can be mounted using our bespoke fixing bracket (code: 333413)
- Can be installed in conjunction with anti-ligature, water-saving basin controls
- Water flow can be activated with pneumatic or electronic controls – please enquire
- Non-Flammable – BS476 Pt 6 & 7 Class ‘0’ and Class ‘1’
- ISO EN 19712-3-2007 Rated 5 for durability, stain resistance and cigarette burns

Product	Code
Resan Basin	333973



RESAN BASIN

RESAN SANITARYWARE // WASHROOM FILL & FLUSH

Damage Resistant Rectangular Basin

- Damage resistant basins, ideal for use in all applications where there may be the potential for vandalism, heavy treatment or misuse
- Back to wall design allows all pipework to be safely concealed
- Can be installed in conjunction with water-saving basin controls
- Water flow can be activated with pneumatic or electronic controls – please enquire
- Easy clean matt and gloss finishes
- Bespoke colours and designs can be supplied subject to sufficient demand
- Non-Flammable – BS476 Pt 6 & 7 Class ‘0’ and Class ‘1’
- ISO EN 19712-3-2007 Rated 5 for durability, stain resistance and cigarette burns

Product	Code
Resan Basin	330812

08 Resan Sanitaryware // Pans



RESAN PAN

RESAN SANITARYWARE // WASHROOM FILL & FLUSH

Damage Resistant Toilet Pan Standard Height with Polished Resin for Gloss Effect

- Standard white WC pans are cast in a single piece, reducing join joints which are difficult to clean and enhancing strength
- The waste spigot height is 229mm
- Contrasting colour integral seats are available with a range of Resan WC Pans
- Non-Flammable – BS476 Pt 6 & 7 Class '0' and Class '1'
- ISO EN 19712-3-2007 Rated 5 for durability, stain resistance and cigarette burns
- BS EN 997 6/4 Litre and 5/3 Flush Approval
- BREEAM rated
- CE Marked
- UK Ministry Of Justice Safer Cell Approved



Resan Pan

Fitting	Finish	Seat	Code
Bolt To Floor	Polished Resin for Gloss Effect	Plain Seat Open Rim	334074
Bolt To Floor	Polished Resin for Gloss Effect	Blue Seat Open Rim	334075
Bolt To Floor	Polished Resin for Gloss Effect	Grey Seat Open Rim	372065
Bolt To Wall	Polished Resin for Gloss Effect	Blue Seat Open Rim	334076
Bolt To Wall	Polished Resin for Gloss Effect	Grey Seat Open Rim	334534
Bolt To Wall	Polished Resin for Gloss Effect	Plain Seat Open Rim	333986



Resan Sanitaryware // Pans 08



RESAN PAN

RESAN SANITARYWARE // WASHROOM FILL & FLUSH

Damage Resistant Toilet Pan for Less Able with Polished Resin for Gloss Effect

- Standard white WC pans are cast in a single piece, reducing join joints which are difficult to clean and enhancing strength
- The waste spigot height is 283mm.
- Contrasting colour integral seats are available with a range of Resan WC Pans
- Extension Box not fitted as standard
- An extension box is also provided which extends the projection of the pan out from the wall to 750mm from the standard 500mm
- These are particularly suitable for public washrooms which must conform to Approved Document M as well as environments such as Care Homes and Disabled Washroom facilities
- This raised height WC is considered as 'comfort height' being 480mm high rather than the standard 415mm
- Non-Flammable – BS476 Pt 6 & 7 Class '0' and Class '1'
- ISO EN 19712-3-2007 Rated 5 for durability, stain resistance and cigarette burns
- BS EN 997 6/4 Litre and 5/3 Flush Approval
- BREEAM rated
- CE Marked

Resan Pan

Fitting	Finish	Seat	Code
Bolt to Floor	Polished Resin for Gloss Effect	—	372561
Bolt to Floor	Polished Resin for Gloss Effect	Plain Blue	372562
Bolt to Floor	Polished Resin for Gloss Effect	Plain Grey	372563
Bolt to Wall	Polished Resin for Gloss Effect	—	372558
Bolt to Wall	Polished Resin for Gloss Effect	Plain Blue	372559
Bolt to Wall	Polished Resin for Gloss Effect	Plain Grey	372560
Extension Box Only			372564



08 Resan Sanitaryware // Pans



RESAN PAN

RESAN SANITARYWARE // WASHROOM FILL & FLUSH

Damage Resistant Toilet Pan for Less Able with Polished Resin for Gloss Effect - With Seat Fixing Holes

- This raised height WC is considered as 'comfort height' being 475mm high rather than the standard 415mm.
- The waste spigot height is 229mm.
- A heavy duty ABS plastic seat is provided with this version of our WC Pan
- Contrasting colour integral seats are available with a range of Resan WC Pans.
- Non-Flammable – BS476 Pt 6 & 7 Class '0' and Class '1'
- ISO EN 19712-3-2007 Rated 5 for durability, stain resistance and cigarette burns
- BS EN 997 6/4 Litre and 5/3 Flush Approval
- BREEAM rated
- CE Marked
- UK Ministry Of Justice Safer Cell Approved

Resan Pan

Fitting	Finish	Fixing	Code
Bolt To Wall	Polished Resin for Gloss Effect	Seat Fixing Holes	328094
Bolt To Floor	Polished Resin for Gloss Effect	Seat Fixing Holes	328096

Resan Sanitaryware // Pans 08



RESAN PAN

RESAN SANITARYWARE // WASHROOM FILL & FLUSH

Damage Resistant Toilet Pan Standard Height with Polished Resin for Gloss Effect - With Seat Fixing Holes

- The waste spigot height is 229mm.
- Standard white WC pans are cast in a single piece, reducing join joints which are difficult to clean and enhancing strength.
- Seat is NOT included with this model
- Contrasting colour integral seats are available with a range of Resan WC Pans.
- Non-Flammable – BS476 Pt 6 & 7 Class '0' and Class '1'
- ISO EN 19712-3-2007 Rated 5 for durability, stain resistance and cigarette burns
- BS EN 997 6/4 Litre and 5/3 Flush Approval
- BREEAM rated
- CE Marked

Resan Pan

Fitting	Finish	Fixing	Code
Bolt To Wall	Polished Resin for Gloss Effect	Seat Fixing Holes	334070
Bolt To Floor	Polished Resin for Gloss Effect	Seat Fixing Holes	334072



08 Resan Sanitaryware // Urinal // Mirror // Shelf



RESAN URINALS

RESAN SANITARYWARE // WASHROOM FILL & FLUSH

Resan Damage Resistant Urinal

- Damage resistant sanitaryware which is ideal for use in all applications where there may be the potential for vandalism, heavy treatment or misuse
- Damage-resistant and anti-ligature
- Back to wall design allows all pipework to be safely concealed
- Can be teamed with water-saving electronic urinal controls that support BREEAM and other initiatives
- Easy clean matt and gloss finishes
- Bespoke colours and designs can be supplied subject to sufficient demand
- Non-Flammable – BS476 Pt 6 & 7 Class '0' and Class '1'
- ISO EN 19712-3-2007 Rated 5 for durability, stain resistance and cigarette burns
- BREEAM rated
- CE Marked

Product	Code
Resan Urinals	325601
Accessories (Waste/Spreader & Trap Kit)	327395



Resan Mirror Frame

RESAN MIRROR FRAME SYSTEM

- Ideal for use alongside Resan sanitaryware where there may be the potential for vandalism, heavy treatment or misuse
- Damage resistant and anti-ligature
- Bespoke colours and designs can be supplied subject to sufficient demand
- 350mm x 250mm
- 600mm x 500mm
- UK Ministry Of Justice Safe Cell Approved
- Non-Flammable – BS476 Pt 6 & 7 Class '0' and Class '1'
- ISO EN 19712-3-2007 Rated 5 for durability, stain resistance and cigarette burns

Item	Code
Resan Mirror 350 x 250mm	326147
Resan Mirror 600 x 500mm	334297



Resan Shelf

RESAN ANTI-LIGATURE SHELF

- Ideal for use in conjunction with Resan sanitaryware to create damage resistant installations in all commercial applications
- Damage resistant and anti-ligature
- Bespoke colours and designs can be supplied subject to sufficient demand

Item	Code
Resan Shelf	326144

Resan // Options

Resan Accessories

Code	Description
326185	Dudley Safeflo Pneumatic Washbasin Control
335797	Resan Basin Infra-Red Control Kit (Two Sensors)
377214	Resan Basin Infra-Red Control Kit (One Sensor)
370997	Resan Basin Sensor Sleeve Extension (suitable for walls up to 140mm thick)
370996	Resan Basin Sensor Lock Out Remote Control
326186	Dudley Safeflo Through The Wall Shower Control Set
326183	Dudley Anti-Ligature Wall Mounted Shower Head
326184	Dudley Anti-Ligature Ceiling Mounted Shower Head
327395	Waste/Spreader & Trap Kit for Resan Urinal
326187	Dudley Safeflo WC Pneumatic Control
333413	Resan Oval Basin Bracket Set - Comes With Fixing Kit For Through Wall Applications



Plumbing Fittings & Spares

For high-quality plumbing fittings and plumbing spares, you're in the right place. Find exactly the parts you need in record time with our core categories, and you'll be onto the next job in no time.

For live product lead times please visit our website.





In this section

01	» Bathroom/Kitchen Accessories	60	04	» Pre-Packed Products	107
	Wastes, Traps & Accessories	60		Plumbing Boxes	107
	Pan Connectors	79		Polybag Range	112
	Toilet Seats	84	05	» Washers & Seals	115
	Accessories	86		Tap	115
	Grab Rails	86		Toilet Cistern/ Tank	116
	Plugs & Chains	90		Trap & Waste	117
02	» Cistern Levers & Pulls	93		Central Heating	118
03	» Cistern Tank Fittings	102		Service & Hose	118
	Syphon and Flush Valve Accessories	102		General	119
	Flushpipe Bends & Accessories	103		O Rings	119
	Close Coupling Kits & Spares	105			



Visit our website

Visit our website and search our extensive range of plumbing parts, find key product information such as technical specifications, installation and troubleshooting guides and create your order all in one place using our Quote Builder function.

01 Bathroom/Kitchen Accessories // Wastes, Traps & Accessories



Basin Mate

BATHROOM ACCESSORIES // PLUMBING FITTING & SPARES

Basin Mate Seal Kit - A handy way of sealing your old or new basin waste

- 1¼" Seal Kit
- Quick and East to Fit
- Saves Time and Money
- No need for Paint, Putty or Mastic



Item	Code
Basin Mate	368148

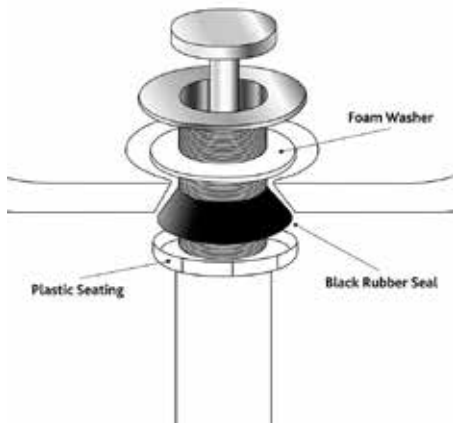

Say goodbye to leaky wastes! Installing basin wastes has never been so easy! Our Basin Mate seal kit is a handy way of sealing your old or new basin waste. The kit is manufactured from high quality materials and includes a sealing ring, washer and seating – everything you need for a quick and easy installation. There is no need for paint, putty or mastic!

- **A handy way of sealing your old or new basin waste.**
- **There is no need for paint, putty or mastic!**

Visit our website



Bathroom/Kitchen Accessories // Wastes, Traps and Accessories 01



BASIN WASTE WITH LEAK-FREE BASIN MATE

BATHROOM ACCESSORIES // BASIN WASTE

Unslotted Basin Waste with a Square Mushroom Spring Plug and Basin Mate Seal Kit

- High quality chrome plating to BS1224, providing a contemporary yet traditional look
- Ideal replacement for most plastic or ceramic basins
- Manufactured from high quality solid brass
- Supplied with square mushroom spring plug
- Unslotted Design

Item	Code
1 1/4" Basin Waste with LEAK-FREE Basin Mate	372467



BASIN WASTE WITH LEAK-FREE BASIN MATE

BATHROOM ACCESSORIES // BASIN WASTE

Slotted with Square Mushroom Spring Plug with Basin Mate Seal Kit

- High quality chrome plating to BS1224, providing a contemporary yet traditional look
- Ideal replacement for most plastic or ceramic basins
- Manufactured from high quality solid brass
- Supplied with square mushroom spring plug
- Slotted design suitable for basins with an overflow

Item	Code
1 1/4" Basin Waste with LEAK-FREE Basin Mate	372397



BASIN WASTE WITH LEAK-FREE BASIN MATE

BATHROOM ACCESSORIES // BASIN WASTE

Unslotted with Flip/Swivel Plug with Basin Mate Seal Kit

- High quality chrome plating to BS1224, providing a contemporary yet traditional look
- Ideal replacement for most plastic or ceramic basins
- Manufactured from high quality solid brass
- Supplied with flip/swivel (captive) plug
- Unslotted design

Item	Code
1 1/4" Basin Waste with LEAK-FREE Basin Mate	372396

01 Bathroom/Kitchen Accessories // Wastes, Traps and Accessories



BASIN WASTE WITH LEAK-FREE BASIN MATE

BATHROOM ACCESSORIES // BASIN WASTE

Slotted with Flip/Swivel Plug with Basin Mate Seal Kit

- High quality chrome plating to BS1224, providing a contemporary yet traditional look
- Ideal replacement for most plastic or ceramic basins
- Manufactured from high quality solid brass
- Supplied with flip/swivel (captive) plug
- Slotted design suitable for basins with an overflow

Item	Code
1 1/2" Basin Waste with LEAK-FREE Basin Mate	372395



BASIN WASTE WITH LEAK-FREE BASIN MATE

BATHROOM ACCESSORIES // BASIN WASTE

Unslotted with Mushroom Spring Plug with Basin Mate Seal Kit

- High quality chrome plating to BS1224, providing a contemporary yet traditional look
- Ideal replacement for most plastic or ceramic basins
- Manufactured from high quality solid brass
- Supplied with mushroom spring plug
- Unslotted design

Item	Code
1 1/2" Basin Waste with LEAK-FREE Basin Mate	372394

Packaging Samples



Bathroom/Kitchen Accessories // Wastes, Traps and Accessories 01



BASIN WASTE WITH LEAK-FREE BASIN MATE

BATHROOM ACCESSORIES // BASIN WASTE

Slotted with Mushroom Spring Plug with Basin Mate Seal Kit

- High quality chrome plating to BS1224, providing a contemporary yet traditional look
- Ideal replacement for most plastic or ceramic basins
- Manufactured from high quality solid brass
- Supplied with mushroom spring plug
- Slotted design suitable for basins with an overflow

Item	Code
1 1/4" Basin Waste with LEAK-FREE Basin Mate	372393



BASIN WASTE WITH LEAK-FREE BASIN MATE

BATHROOM ACCESSORIES // BASIN WASTE

Unslotted with Chrome Plug and Chain with Basin Mate Seal Kit

- High quality chrome plating to BS1224, providing a contemporary yet traditional look
- Ideal replacement for most plastic or ceramic basins
- Manufactured from high quality solid brass
- Supplied with chrome plug and chain stay
- Unslotted design

Item	Code
1 1/4" Basin Waste with LEAK-FREE Basin Mate	372392



BASIN WASTE WITH LEAK-FREE BASIN MATE

BATHROOM ACCESSORIES // BASIN WASTE

Slotted with Chrome Plug and Chain with Basin Mate Seal Kit

- High quality chrome plating to BS1224, providing a contemporary yet traditional look
- Ideal replacement for most plastic or ceramic basins
- Manufactured from high quality solid brass
- Supplied with chrome plug and chain stay
- Slotted design suitable for basins with an overflow

Item	Code
1 1/4" Basin Waste with LEAK-FREE Basin Mate	372391

01 Bathroom/Kitchen Accessories // Wastes, Traps and Accessories



BASIN WASTE WITH LEAK-FREE BASIN MATE

BATHROOM ACCESSORIES // BASIN WASTE

Unslotted with Poly Plug and Chain with Basin Mate Seal Kit

- High quality chrome plating to BS1224, providing a contemporary yet traditional look
- Ideal replacement for most plastic or ceramic basins
- Manufactured from high quality solid brass
- Supplied with poly plug and chain
- Unslotted design



Item	Code
1 1/4" Basin Waste with LEAK-FREE Basin Mate	372390



BASIN WASTE WITH LEAK-FREE BASIN MATE

BATHROOM ACCESSORIES // BASIN WASTE

Slotted with Poly Plug and Chain with Basin Mate Seal Kit

- High quality chrome plating to BS1224, providing a contemporary yet traditional look
- Ideal replacement for most plastic or ceramic basins
- Manufactured from high quality solid brass
- Supplied with poly plug and chain
- Slotted design suitable for basins with an overflow



Item	Code
1 1/4" Basin Waste with LEAK-FREE Basin Mate	372389

Bathroom/Kitchen Accessories // Wastes, Traps and Accessories 01



BASIN WASTE

BATHROOM ACCESSORIES // BASIN WASTE

Slotted Plastic Body and Poly Plug

- Quick and simple installation
- Creates a traditional look for your bathroom
- Slotted type – suitable for basin with overflow
- Manufactured from high quality materials
- Plastic Body
- Supplied with PVC plug, chain and stay

Item	Code
1 1/4" Basin Waste	368154



BASIN WASTE

BATHROOM ACCESSORIES // BASIN WASTE

Brass Body and Spring Clicker

- Quick and simple installation
- Creates a modern look for your bathroom
- Available in either Slotted or Unslotted
- Smooth chrome plated finish
- Manufactured from high quality materials
- Brass Body
- Spring Clicker

Item	Code
1 1/4" Slotted Brass Body	368167
1 1/4" Unslotted Brass Body	368172



BASIN WASTE

BATHROOM ACCESSORIES // BASIN WASTE

Brass Body and Poly Plug

- Quick and simple installation
- Creates a traditional look for your bathroom
- Available in either Slotted or Unslotted
- Supplied with PVC plug, chain and stay
- Manufactured from high quality material
- Brass Body
- Poly Plug

Item	Code
1 1/4" Slotted Brass Body	368165
1 1/4" Unslotted Brass Body	368171

01 Bathroom/Kitchen Accessories // Wastes, Traps and Accessories



BASIN WASTE

BATHROOM ACCESSORIES // BASIN WASTE

Brass Body and Mushroom Clicker

- Quick and simple installation
- Creates a modern look for your bathroom
- Available in either Slotted or Unslotted
- Smooth chrome plated finish
- Manufactured from high quality materials
- Brass Body
- Mushroom Clicker

Item	Code
1 1/4" Slotted Brass Body	368163
1 1/4" Unslotted Brass Body	368170



BASIN WASTE

BATHROOM ACCESSORIES // BASIN WASTE

Brass Body and Flipover

- Quick and simple installation
- Creates a modern look for your bathroom
- Available in either Slotted or Unslotted
- Smooth chrome plated finish
- Manufactured from high quality materials
- Brass Body
- Flip/swivel (captive) plug

Item	Code
1 1/4" Slotted Brass Body	368162
1 1/4" Unslotted Brass Body	368169



BASIN WASTE

BATHROOM ACCESSORIES // BASIN WASTE

Brass Body and Chrome Plug

- Quick and simple installation
- Creates a traditional look for your bathroom
- Slotted type – suitable for sink with overflow
- Manufactured from high quality material
- Brass Body
- Supplied with chrome plated plug, chain and stay

Item	Code
1 1/4" Basin Waste	368159

Bathroom/Kitchen Accessories // Wastes, Traps and Accessories 01



BASIN WASTE

BATHROOM ACCESSORIES // BASIN WASTE

Slotted Brass Body and Captive Plug

- Quick and simple installation
- Creates a traditional look for your bathroom
- Smooth chrome plated finish
- Manufactured from high quality materials
- Slotted Brass Body
- Captive Plug

Item	Code
1 1/4" Basin Waste	368160



BASIN WASTE

BATHROOM ACCESSORIES // BASIN WASTE

Slotted Brass Body and Square Clicker

- Quick and simple installation
- Creates a traditional look for your bathroom
- Smooth chrome plated finish
- Manufactured from high quality materials
- Brass Body
- Square Clicker

Item	Code
1 1/4" Basin Waste	368166



BASIN WASTE

BATHROOM ACCESSORIES // BASIN WASTE

Vanity Basin Combination Waste

- Quick and simple installation
- Creates a traditional look for your bathroom
- Smooth chrome plated finish
- Slotted Brass Body
- Manufactured from high quality materials
- Brass Body
- Chrome Plug

Item	Code
1 1/4" Basin Waste	368153

01 Bathroom/Kitchen Accessories // Wastes, Traps and Accessories

BATH WASTE

BATHROOM ACCESSORIES // BATH WASTE

Brass Body and Poly Plug

- Quick and simple installation
- Creates a traditional look for your bathroom
- Smooth chrome plated finish
- Manufactured from high quality materials
- Brass Body
- Poly Plug



Item	Code
1 1/2" Bath Waste	368183

BATH WASTE

BATHROOM ACCESSORIES // BATH WASTE

Brass Body and Chrome Plug

- Quick and simple installation
- Creates a traditional look for your bathroom
- Manufactured from high quality materials
- Smooth chrome plated finish
- Brass Body
- Chrome Plug



Item	Code
1 1/2" Bath Waste	368175

BATH WASTE

BATHROOM ACCESSORIES // BATH WASTE

Combi Plastic Body and Pop Up Waste

- Quick and simple installation
- Creates a modern look for your bathroom
- Smooth chrome plated finish
- Manufactured from high quality materials
- Handy pop up plug – no need to search for the plug at the end of the chain



Item	Code
1 1/2" Bath Waste	368181

Bathroom/Kitchen Accessories // Wastes, Traps and Accessories 01



BATH WASTE

BATHROOM ACCESSORIES // BATH WASTE

Combi Plastic Body and Mushroom Clicker

- Quick and simple installation
- Creates a modern look for your bathroom
- Spring loaded plug for easy drainage
- Smooth chrome plated finish
- Combi Waste
- Manufactured from high quality materials
- Plastic Body
- Mushroom Clicker

Item	Code
1 1/2" Bath Waste	368177



BATH WASTE

BATHROOM ACCESSORIES // BATH WASTE

Combi Plastic Body and Chrome Plug

- Quick and simple installation
- Creates a traditional look for your bathroom
- Parking plug design
- Smooth chrome plated finish
- Combi Waste
- Manufactured from high quality materials
- Plastic Body
- Chrome Plug

Item	Code
Bath Waste	368180



BATH WASTE

BATHROOM ACCESSORIES // BATH WASTE

Combi Brass Body and Poly Plug

- Quick and simple installation
- Creates a traditional look for your bathroom
- Smooth chrome plated finish
- Combi Waste
- Overflow
- Manufactured from high quality materials
- Brass Body
- Poly Plug

Item	Code
Bath Waste	368178

01 Bathroom/Kitchen Accessories // Wastes, Traps and Accessories



BATH WASTE

BATHROOM ACCESSORIES // BATH WASTE

Combi Plastic Body and Poly Plug

- Quick and simple installation
- Creates a traditional look for your bathroom
- Smooth chrome plated finish
- Combi Waste
- Manufactured from high quality materials
- Plastic Body
- Poly Plug

Item	Code
Bath Waste	368179



BATH WASTE

BATHROOM ACCESSORIES // BATH WASTE

Combi Plastic Body and Spring Clicker

- Quick and simple installation
- Creates a modern look for your bathroom
- Spring loaded plug for easy drainage
- Combi Waste
- Manufactured from high quality materials
- Smooth chrome plated finish
- Plastic Body
- Spring Clicker

Item	Code
Bath Waste	368182



BATH WASTE

BATHROOM ACCESSORIES // BATH WASTE

Combi Brass Body and Chrome Plug

- Quick and simple installation
- Creates a traditional look for your bathroom
- Smooth chrome plated finish
- Combi Waste, with overflow
- Manufactured from high quality materials
- Brass Body
- Chrome Plug

Item	Code
Bath Waste	368176

Bathroom/Kitchen Accessories // Wastes, Traps and Accessories 01



FLUSH GRATED WASTE

BATHROOM ACCESSORIES // FLUSH GRATED WASTE

Threaded Flush Grated Waste

- Chrome Plated
- Solid Tailed flush grated waste
- Unslotted
- Manufactured from high quality materials

Thread x Flange Size	Tail	Code
1¼" x 27/16"	89mm Solid Tail	368187
1½" x 27/16"	89mm Solid Tail	368191
1½" x 27/8"	38mm Solid Tail	368193
1½" x 33/8"	86mm Solid Tail	368195



FLUSH GRATED WASTE

BATHROOM ACCESSORIES // FLUSH GRATED SHOWER WASTE

Flush Grated Waste with Removable Top

- Quick and simple installation
- Chrome Plated
- Solid Tailed flush grated waste
- Unslotted
- Manufactured from high quality materials

Thread x Flange Size	Code
1½" x 1½"	368187



FLUSH GRATED WASTE

BATHROOM ACCESSORIES // FLUSH GRATED SHOWER WASTE

Flush Grated Waste with Removable Octagonal Centre

- Quick and simple installation
- Chrome Plated
- Solid Tailed flush grated waste
- Unslotted
- Manufactured from high quality materials

Thread x Flange Size	Code
1.½" x 2.76"	368194

01 Bathroom/Kitchen Accessories // Wastes, Traps and Accessories

SINK WASTE

KITCHEN ACCESSORIES // SINK WASTE

Combi Plastic Body and Poly Plug

- 1½" Sink Waste
- 18" ball style chain
- Manufactured from high quality materials
- Combi Waste, with overflow
- Plastic Body
- Poly Plug



Item	Code
1½" Sink Waste	368200

BELFAST STYLE SINK WASTE

KITCHEN ACCESSORIES // SINK WASTES

Belfast Style and Poly Plug

- 1½" Belfast Style Sink Waste
- Brass Body
- Poly Plug



Item	Code
Slotted Brass Body	368201
Unslotted Brass Body	368203

BASKET STRAINER WASTE

KITCHEN ACCESSORIES // BASKET STRAINERS

Strainer Waste with Overflow White/Stainless Steel

- Basket Strainer
- Comes with Overflow
- White



Item	Code
White	368199
Stainless Steel	368197

Bathroom/Kitchen Accessories // Wastes, Traps and Accessories 01



BASKET STRAINER WASTE

KITCHEN ACCESSORIES // BASKET STRAINERS

Strainer Waste. White/Stainless Steel

- Quick and simple installation
- Creates a traditional look for your kitchen
- Manufactured from high quality materials
- Basket Strainer
- White or Stainless Steel Finish

Item	Code
White	368198
Stainless Steel	368196



SINK STRAINER

KITCHEN ACCESSORIES // SINK WASTE

Economy Sink Strainer

- Rust Free
- Aluminium

Item	Code
Economy Sink Strainer	365570



SINK STRAINER

KITCHEN ACCESSORIES // SINK WASTE

Chrome Sink Strainer

- Chrome Flange

Item	Code
Chrome Sink Strainer	365668

01 Bathroom/Kitchen Accessories // Wastes, Traps and Accessories



Basin Waste Shroud

LONG BASIN WASTE UNIVERSAL SHROUD

- To suit slotted or unslotted wastes

Item	Code
Basin Waste Shroud	368173



Stainless Steel Urinal Waste

STAINLESS STEEL REMOVABLE DOME COVER

- Brass Body
- 3½" Tail Length
- 2½" Flange Size

Size	Code
1½"	368205
1½"	368208



Plastic Urinal Waste

WHITE PLASTIC FIXED DOME TOP

- Short and Long Tail Length Available
- 2½" Flange Size

Size	Code
1½"	368206
1½" Short Tail	368210



Straight Waste Connector

EPSON UNIFIX STRAIGHT WASTE CONNECTOR

Size	Code
32mm	368258
38mm	368263



Obtuse Bend Waste Connector

EPSON UNIFIX OBTUSE BEND CONNECTOR

Size	Code
32mm	368259
38mm	368264



90° Knuckle Bend Waste Connector

EPSON UNIFIX 90° KNUCKLE BEND CONNECTOR

Size	Code
32mm	368260
38mm	368265



Reducer Waste Connector

EPSON UNIFIX REDUCER 38mm TO 32mm

Item	Code
38mm - 32mm	368262



Waste Connector Coupled Both Ends

EPSON UNIFIX REDUCER 1½" - 1¼"

Item	Code
1½" - 1¼" Reducer	368267

Bathroom/Kitchen Accessories // Wastes, Traps and Accessories 01



P Traps

MOSTLY USED WITH DOMESTIC AND PROFESSIONAL BASINS

- Quick and easy to fit
- Manufactured to BS EN274
- Tubular two piece
- Supplied with unifix outlet to suit polypropylene, ABS and copper pipe
- Replacement washers available
- No solvent welding required
- Available in a range of sizes and styles

Size	Code
32mm x 38mm Seal	368211
38mm x 38mm Seal	368215
32mm x 75mm Seal	368213
38mm x 75mm Seal	368217
38mm x 38mm Seal Deep Seal Trap with Cleaning Eye	368219
38mm x 75mm Seal with Cleaning Eye	368220



P Traps for Bath & Showers

MOSTLY USED WITH DOMESTIC AND PROFESSIONAL BATHS & SHOWERS

- Quick and easy to fit
- Manufactured to BS EN274
- One piece
- Supplied with unifix outlet to suit polypropylene, ABS and copper pipe
- Replacement washers available
- No solvent welding required
- Available in a range of sizes and styles

Size	Code
38mm x 20mm Seal No Cleaning Eye	368235
38mm x 20mm Seal Single Cleaning Eye	368236



S Traps

MOSTLY USED WITH DOMESTIC AND PROFESSIONAL BASINS

- Quick and easy to fit
- Manufactured to BS EN274
- Tubular two piece
- Supplied with unifix outlet to suit polypropylene, ABS and copper pipe
- Replacement washers available
- No solvent welding required
- Available in a range of sizes and styles



Size	Code
32mm x 38mm Seal	368212
38mm x 38mm Seal	368216
32mm x 75mm Seal	368214
38mm x 75mm Seal	368218

01 Bathroom/Kitchen Accessories // Wastes, Traps and Accessories



P Trap for Baths

MOSTLY USED WITH DOMESTIC AND PROFESSIONAL BATHS

- Quick and easy to fit
- Manufactured to BS EN274
- Tubular two piece
- Supplied with unifix outlet to suit polypropylene, ABS and copper pipe
- Replacement washers available
- No solvent welding required

Size	Code
50mm with Overflow and Cleaning Eye	368234



Running P Trap

MOSTLY USED WITH DOMESTIC AND PROFESSIONAL BASINS

- Quick and easy to fit
- Manufactured to BS EN274
- Tubular two piece
- Supplied with unifix outlet to suit polypropylene, ABS and copper pipe
- Replacement washers available
- No solvent welding required

Size	Code
38mm x 75mm Seal	368252



P Traps with Telescopic Inlets

MOSTLY USED WITH DOMESTIC AND PROFESSIONAL BASINS

- Quick and easy to fit
- Manufactured to BS EN274
- Tubular two piece (180mm Tube)
- Supplied with unifix outlet to suit polypropylene, ABS and copper pipe
- Replacement washers available
- No solvent welding required

Size	Code
38mm x 75mm Seal	368227
38mm x 38mm Seal	368226



Fixed Height Bottle Trap - Anti-Vac

MOSTLY USED WITH DOMESTIC AND PROFESSIONAL BASINS

- Quick and easy to fit
- Manufactured to BS EN274
- Supplied with with adapters & unifix outlet to suit polypropylene, ABS and copper pipe
- Replacement washers available
- Compact
- No solvent welding required

Type	Code
Universal Trap with adaptors	368247



Telescopic Bottle Trap - Anti Vac

MOSTLY USED WITH DOMESTIC AND PROFESSIONAL BASINS

- Quick and easy to fit
- Manufactured to BS EN274
- Supplied with adapters & unifix outlet to suit polypropylene, ABS and copper pipe
- Replacement washers available
- Compact
- No solvent welding required

Type	Code
Universal Telescopic Trap with Adaptors (76mm seal)	368240



Straight through Pedestal Trap

MOSTLY USED WITH DOMESTIC AND PROFESSIONAL BASINS

- Quick and easy to fit
- Manufactured to BS EN274
- Telescopic
- Supplied with unifix outlet to suit polypropylene, ABS and copper pipe
- Replacement washers available
- No solvent welding required

Size	Code
32mm x 75mm Seal	368225

Bathroom/Kitchen Accessories // Wastes, Traps and Accessories 01



Appliance Traps

MOSTLY USED WITH DOMESTIC AND PROFESSIONAL APPLIANCES

- Quick and easy to fit
- Manufactured to BS EN274
- Supplied with unifix outlet to suit polypropylene, ABS and copper pipe
- Replacement washers available
- No solvent welding required
- Available in a range of sizes and styles

Size	Code
38mm x 75mm Seal Single Inlet	368230
38mm x 75mm Seal Double Inlet	368231
38mm x 75mm Seal Inlet Tee	368232
38mm x 75mm Seal (600mm Stand Pipe)	368228



Bottle Traps with Standard (Fixed) Inlets - Anti-Vac

MOSTLY USED WITH DOMESTIC AND PROFESSIONAL BASINS

- Quick and easy to fit
- Manufactured to BS EN274
- Fixed Inlet
- Supplied with unifix outlet to suit polypropylene, ABS and copper pipe
- Replacement washers available
- No solvent welding required
- Range of seal sizes

Size	Code
32mm x 38mm Seal	368244
38mm x 38mm Seal	368246
32mm x 75mm Seal	368242
38mm x 75mm Seal	368243



Chrome Plated Bottle Trap

TRADITIONAL STYLED BOTTLE TRAP

- Quick and easy to fit
- Adjustable
- Comes with 32mm stainless steel extension and wallplate
- Replacement washers available

Size	Code
1 ¼"	368254



Chrome Plated Bottle Trap

MODERN STYLED BOTTLE TRAP

- Quick and easy to fit
- Adjustable
- Comes with 32mm stainless steel extension and wallplate
- Replacement washers available

Size	Code
1 ¼"	368255

01 Bathroom/Kitchen Accessories // Pan Connectors



RIGIFLEX PAN CONNECTOR

BATHROOM ACCESSORIES // PAN CONNECTORS

Rigiflex Flexible WC Pan Connector

- Adjustable 230mm - 570mm (extendable)

Size	Code
230 - 570mm Extendable	313672



EXTENDABLE PAN CONNECTOR

BATHROOM ACCESSORIES // PAN CONNECTORS

Extendable Flexible Pan Connector

- x3 Extendable sizes
- 80 - 105mm Inlet
- 100 - 110mm Outlet
- Made to BS5627
- 10 Year Warranty

Size	Code
310mm - 650mm Length	363739
270mm - 500mm Length	363740
250mm - 350mm Length	363741



90° S EXTENDABLE PAN CONNECTOR

BATHROOM ACCESSORIES // PAN CONNECTORS

90° S Extendable Pan Connector. 280-460mm

- 90° S Pan Connector
- Extendable 280mm - 460mm
- 89 - 107mm Inlet
- 100 - 110mm Outlet
- Pack Qty: 24
- Made to BS5627
- 10 Year Warranty

Size	Code
280mm - 460mm	363742

Bathroom/Kitchen Accessories // Pan Connectors 01



90° S EXTENDABLE PAN CONNECTOR

BATHROOM ACCESSORIES // PAN CONNECTORS

90° S Extendable Pan Connector - 340-700mm

- 89 - 107mm Inlet / 100 - 110mm Outlet
- Pack Qty: 20
- Made to BS5627
- 10 Year Warranty

Item	Code
340mm – 700mm	363743



90° S EXTENDABLE PAN CONNECTOR WITH OUTLET

BATHROOM ACCESSORIES // PAN CONNECTORS

90° S Extendable Pan Connector with Outlet 240-460mm

- 90° S Extendable Pan Connector w/Outlet
- Extendable 240mm – 460mm
- 89 - 107mm Inlet
- 100 - 110mm Outlet
- Pack Qty: 24
- Made to BS5627
- 10 Year Warranty

Size	Code
240mm – 460mm	363744



90° S EXTENDABLE PAN CONNECTOR WITH OUTLET

BATHROOM ACCESSORIES // PAN CONNECTORS

S Extendable Pan Connector with Outlet 340-700mm

- S Extendable Pan Connector w/Outlet
- Extendable 340mm – 700mm
- 89 - 107mm Inlet
- 100 - 110mm Outlet
- Pack Qty: 20
- Made to BS5627
- 10 Year Warranty

Size	Code
340mm – 700mm	363745

01 Bathroom/Kitchen Accessories // Pan Connectors



STRAIGHT PAN CONNECTOR

BATHROOM ACCESSORIES // PAN CONNECTORS

Rigid Pan Connector – Straight

- Straight
- 90mm Length
- 89 - 107mm Inlet
- 90 - 100 - 110mm Outlet
- Pack Qty: 40
- Made to BS5627
- 10 Year Warranty

Size	Code
90mm Length Rigid Pan Connector	363732



EXTENDED STRAIGHT PAN CONNECTOR

BATHROOM ACCESSORIES // PAN CONNECTORS

Rigid Pan Connector – Extended Straight - 250mm

- 89-107mm Inlet / 100mm Outlet
- Pack Qty: 16
- Made to BS5627
- 10 Year Warranty

Item	Code
250mm	363736



ECCENTRIC OFFSET 20mm PAN CONNECTOR

BATHROOM ACCESSORIES // PAN CONNECTORS

Rigid Pan Connector – Eccentric/offset 20mm

- Eccentric/offset 20mm
- 127mm Length
- 89 - 107mm Inlet
- 90 - 100 - 110mm Outlet
- Pack Qty: 40
- Made to BS5627
- 10 Year Warranty

Size	Code
127mm Length Eccentric/offset 20mm	363733

Bathroom/Kitchen Accessories // Pan Connectors 01



ECCENTRIC OFFSET 40mm PAN CONNECTOR

BATHROOM ACCESSORIES // PAN CONNECTORS

Rigid Pan Connector – Eccentric/offset 40mm

- Eccentric/offset 40mm
- 122mm Length
- 89 - 107mm Inlet
- 90 - 100 - 110mm Outlet
- Pack Qty: 20
- Made to BS5627
- 10 Year Warranty

Size	Code
122mm Length Eccentric/ offset 40mm	363734



ECCENTRIC OFFSET 60mm PAN CONNECTOR

BATHROOM ACCESSORIES // PAN CONNECTORS

Rigid Pan Connector – Eccentric/offset 60mm

- Eccentric/offset 60mm
- 122mm Length
- 89 - 107mm Inlet
- 90 - 100 - 110mm Outlet
- Pack Qty: 20
- Made to BS5627
- 10 Year Warranty

Size	Code
122mm Length Eccentric/ offset 60mm	363735



90° ADJUSTABLE PAN CONNECTOR 300mm

BATHROOM ACCESSORIES // PAN CONNECTORS

Rigid Pan Connector – 90° S Adjustable 300mm

- Adjustable by cutting 300mm
- 360mm Length
- 89 - 107mm Inlet
- 100 - 110mm Outlet
- Pack Qty 16
- Made to BS5627
- 10 Year Warranty

Size	Code
360mm Length	331823



90° ADJUSTABLE PAN CONNECTOR 350mm

BATHROOM ACCESSORIES // PAN CONNECTORS

Rigid Pan Connector – 90° S Adjustable 350mm

- Adjustable by cutting 350mm
- 360mm Length
- 89 - 107mm Outlet
- 90 - 100 - 110mm Inlet
- Pack Qty 20
- Made to BS5627
- 10 Year Warranty

Item	Code
360mm	363738

01 Bathroom/Kitchen Accessories // Pan Connectors



104° PAN CONNECTOR

BATHROOM ACCESSORIES // PAN CONNECTORS

Rigid Pan Connector – 104°

- 150mm Length
- 89 - 110mm Inlet
- 90 - 100 - 110mm Outlet
- Made to BS5627
- 10 Year Warranty

Item	Code
Rigid Pan Connector – 104°	363724



SWAN NECK PAN CONNECTOR

BATHROOM ACCESSORIES // PAN CONNECTORS

Rigid Pan Connector – Low Level Swan Neck

- 360mm Length
- 89 - 107mm Inlet
- 90 - 100 - 110mm Outlet
- Made to BS5627
- 10 Year Warranty

Size	Code
360mm Length	363730



PAN CONNECTOR EXTENSION

BATHROOM ACCESSORIES // PAN CONNECTORS

Rigid Pan Connector – Extension - 250mm Length

- 100mm Inlet / 90 - 100 - 110mm Outlet
- Made to BS5627
- 10 Year Warranty

Size	Code
Extension 250mm Length	363729

Bathroom/Kitchen Accessories // Pan Connectors 01



BACK TO WALL PAN CONNECTOR 90° ADJUSTABLE 350mm

BATHROOM ACCESSORIES // PAN CONNECTORS

Back to the Wall Pan Connector - 90°
Adjustable by cutting 350mm

- 360mm Length
- 89 - 100mm Inlet
- 80 - 110mm Outlet
- Supplied with stabilising bolt which is designed to make back to wall installation easy and secure
- Made to BS5627
- 10 Year Warranty

Size	Code
360mm Length	363746



BACK TO WALL PAN CONNECTOR 90° ADJUSTABLE 0-15cm

BATHROOM ACCESSORIES // PAN CONNECTORS

Back to the Wall Pan Connector – 90°
Adjustable by cutting 0 – 15cm reach

- 343mm Length
- 95 - 105mm Inlet
- 100 - 110mm Outlet
- Supplied with stabilising bolt which is designed to make back to wall installation easy and secure
- Made to BS5627
- 10 Year Warranty

Size	Code
343mm Length	363747



S PAN BACK TO WALL PAN CONNECTOR

BATHROOM ACCESSORIES // PAN CONNECTORS

Back to the Wall S Pan Connector
Adjustable by cutting 15 – 20cm reach

- 343mm Length
- 87-105mm Inlet
- 100 - 110mm Outlet
- Supplied with stabilising bolt which is designed to make back to wall installation easy and secure
- Made to BS5627
- 10 Year Warranty

Size	Code
Back to Wall S Pan Connector 343mm Length	363748

01 Bathroom/Kitchen Accessories // Toilet Seats



AMELIA

BATHROOM ACCESSORIES // PLUMBING FITTING & SPARES

Thermoplastic medium-duty wrap-over style toilet seat

- Adjustable plastic hinges
- Medium Duty 1.2kg Seat
- Wrap-over style cover
- 423mm x 355mm
- 2 year guarantee

Item	Code
Amelia	320730



CELINE

BATHROOM ACCESSORIES // PLUMBING FITTING & SPARES

Thermoset, soft close heavy-duty toilet seat with stainless steel hinges

- Soft close, easy fit, stainless steel hinges
- Anti-Bacterial
- Heavy Duty 2.3kg Seat
- 456mm x 378mm
- 2 year guarantee

Item	Code
Celine	320723



DANIELLE

BATHROOM ACCESSORIES // PLUMBING FITTING & SPARES

Thermoplastic medium-duty toilet seat with adjustable plastic hinges

- Adjustable plastic hinges
- Medium Duty 1.65kg Seat
- 456mm x 378mm
- 2 year guarantee

Item	Code
Danielle	320732

Bathroom/Kitchen Accessories // Toilet Seats 01



EVE

BATHROOM ACCESSORIES // PLUMBING FITTING & SPARES

Thermoset, medium-duty toilet seat with adjustable hinges

- Adjustable stainless steel hinges
- Medium Duty 1.55kg Seat
- 432mm x 370mm
- 2 year guarantee

Item	Code
Eve	320725



FRANCESCA

BATHROOM ACCESSORIES // PLUMBING FITTING & SPARES

Thermoset, heavy-duty toilet seat with adjustable hinges

- Adjustable stainless steel hinges
- Heavy Duty 2.5kg Seat
- 440mm x 370mm
- 2 year guarantee

Item	Code
Francesca	320727



NADIA

BATHROOM ACCESSORIES // PLUMBING FITTING & SPARES

Thermoset, heavy-duty wrap-over style toilet seat

- Adjustable stainless steel hinges
- Heavy Duty 2.2kg Seat
- Wrap-over style cover
- 446mm x 370mm
- 2 year guarantee

Item	Code
Nadia	320729

01 Bathroom/Kitchen Accessories // Accessories



Toilet Seat Hinges
CHROME PLATED PILLAR HINGES

- Chrome Plated
- Bar Hinge
- C/W Universal Seat Fixing Kit

Item	Code
Toilet Seat Pillar Hinges	367422



Toilet Seat Hinges
CHROME PLATED 'L' SHAPED HINGES

- Chrome Plated
- 'L' Shaped

Item	Code
Toilet Seat Hinges	367418



Toilet Seat Hinges
CHROME PLATED BAR HINGES

- Chrome Plated

Item	Code
Toilet Seat Bar Hinges	367416



Toilet Seat Hinges
BRASS FINISH PILLAR HINGES

- Brass Finish

Item	Code
Toilet Seat Hinges	367420



Toilet Seat Hinges
UNIVERSAL SEAT FIXING KIT

- Universal Seat Fixing Kit
- 8cm [3"] Screws
- Washers
- Wing Nuts

Item	Code
Toilet Seat Hinges - Universal Seat Fixing Kit	367424



Toilet Seat Hinges
WHITE PLASTIC TOILET SEAT HINGES

- White Plastic Hinges
- Rod

Item	Code
Toilet Seat Hinges	367425



Toilet Seat Hinges
BLACK PLASTIC TOILET SEAT HINGES

- Black Plastic Hinges
- Rod
- Double Piston

Item	Code
Toilet Seat Hinges	367426



Toilet Roll Holder
CHROME MEDIUM PATTERN TOILET ROLL HOLDER

- Chrome

Item	Code
Toilet Roll Holder	366565



Toilet Roll Holder
STAINLESS STEEL TOILET ROLL HOLDER

- Stainless Steel
- Suitable for domestic and commercial use

Item	Code
Toilet Roll Holder	366566

Bathroom/Kitchen Accessories // Accessories 01



Toilet Roll Holder

LOCKING CHROME TOILET ROLL HOLDER

- Pack Qty: 1
- Chrome
- Lockable – supplied with key

Item	Code
Toilet Roll Holder	366563



Toilet Roll Holder

SPARE TOILET ROLL HOLDER ROLLER

- Pack Qty: 10
- Plastic

Item	Code
Toilet Roll Holder White	367428
Toilet Roll Holder Black	367429



Quarter Turn Tap Glands & Tap Top Headwork Gland

QUARTER TURN CERAMIC TAP GLANDS, 20 SPLINE

- High Spline
- Sold in Pairs

TAP TOP HEADWORK GLAND, 20 SPLINE – 7.5mm X 8.5mm.

- 7.5mm x 8.5mm

QUARTER TURN CERAMIC TAP GLANDS

Size	Code
8mm x 12mm	367895
7.6mm x 14.9mm	367896
7.7mm x 14.5mm	367897

QUARTER TURN CERAMIC TAP GLANDS

Size	Code
7.5mm x 8.5mm – Threaded (sold in pairs)	367898
7.5mm x 8.5mm – Unthreaded (sold in singles)	367899



Tap Swops

REPLACEMENT TAP HANDLES (PAIR)

- Adjustable to fit most spindles
- No plumbing required
- Supplied complete with fixings
- Sold as a pair

Item	Code
Tap Swops	366509



Tap Swops

METAL REPLACEMENT TAP HANDLES (PAIR)

- Adjustable to fit most spindles
- No plumbing required
- Supplied complete with fixings
- Sold as a pair

Item	Code
Tap Swops	366511



Tap Swops

REPLACEMENT CROSS HEAD TAP HANDLES (PAIR)

- Adjustable to fit most spindles
- No plumbing required
- Supplied complete with fixings
- Sold as a pair

Item	Code
Tap Swops	366512



Shower Hose

REPLACEMENT FOR ANY SHOWER

- Easy to install
- Standard 1/2" BSPT
- Manufactured from stainless steel – won't rust
- Replacement washers available

Size	Code
1.25m	364280
1.5m	364281
2m	364282



Shower Curtain

WHITE SHOWER CURTAIN

- 100% Polyester
- Lead Weighted Hem
- Brass Eyelets

Size	Code
2100mm x 2100mm	366581
1800mm x 1800mm	366582

01 Bathroom/Kitchen Accessories // Accessories



Sanitary Fixing Kit VERTICAL WC PAN FIXING KIT

- White and Chrome Caps
- No.6 x 70mm Screws

Item	Code
Sanitary Fixing Kit	367413



Sanitary Fixing Kit HORIZONTAL PAN & BIDET FIXING KIT

- No.6 x 70mm Hex Screws
- No.5 x 50mm SS Screws

Item	Code
Sanitary Fixing Kit	367405



Sanitary Fixing Kit WASHBASIN AND BIDET WALL FIXING KIT

- Suitable for Washbasin and Bidet

Size	Code
M10 x 120mm	367407
M10 x 140mm	367408
M8 x 110mm	367410



Cistern Support Brackets CISTERN SUPPORT BRACKETS

- 102mm x 102mm (4" x 4")
- 102mm x 51mm (4" x 2")
- Supplied in Pairs

Item	Code
Cistern Support Brackets (4" x 4")	366476
Cistern Support Brackets (4" x 2")	367395



Basin Hanger Bracket BASIN HANGER BRACKET - PRESSED STEEL

- Made from Pressed Steel
- Supplied in Pairs

Item	Code
Basin Hanger Bracket	367396



Basin/Urinal Bracket HEAVY DUTY BASIN/URINAL BRACKET

- Suitable for Basin and Urinal
- Supplied in Pairs

Item	Code
Basin/Urinal Bracket	367398



Urinal Brackets NARROW URINAL BRACKETS (PAIR)

- Narrow Urinal Brackets
- Supplied in Pairs

Item	Code
Urinal Brackets	367401



Basin Bracket UNDERCOUNTER BASIN BRACKET

- 6 Pieces per set

Item	Code
Basin Bracket	367402



Basin Bracket SEMI RECESSED BASIN BRACKET

- Semi Recessed Bracket with Screws

Item	Code
Basin Bracket	367403

Bathroom/Kitchen Accessories // Grab Rails 01



Bath Grips

CHROME PLATED BATH GRIPS

- Supplied in Pairs

Size	Code
190mm Standard, Top Fixing	364861
190mm Standard, Bottom Fixing	364860
254mm Eu Standard, Top Fixing	364863
255mm Eu Standard, Top Fixing, Profile	364859
254mm Eu Standard, Top Fixing, Profile	364864



Support Rail

HINGED SUPPORT RAIL

- 32mm Dia. X 750mm Length

Item	Code
Support Rail	364279



Grab/Support Rails

STEEL GRAB SUPPORT RAILS - CHROME PLATED OR WHITE

- Steel Grab Support Rails
- Available in Chrome or White

Size	Code
25mm Dia, 228mm Length Chrome Plated	364259
25mm Dia, 228mm Length White Coated	364258
25mm Dia, 305mm Length Chrome Plated	364261
25mm Dia, 305mm Length White Coated	364260
35mm Dia, 305mm Length Chrome Plated	364271
35mm Dia, 305mm Length White Coated	364270
25mm Dia, 457mm Length Chrome Plated	364264

Size	Code
25mm Dia, 457mm Length White Coated	364263
35mm Dia, 457mm Length Chrome Plated	364273
35mm Dia, 457mm Length White Coated	364272
25mm Dia, 610mm Length Chrome Plated	364267
25mm Dia, 610mm Length White Coated	364266
35mm Dia, 610mm Length Chrome Plated	364275



Grab Rail

ABS GRAB/SUPPORT RAIL (PLASTIC)

- Supplied with fixing screws
- Larger than normal diameter makes them easier to grasp
- Ribbed to ensure they are easier to grip
- Manufactured from high quality materials

Diameter	Length	Code
35mm	305mm	364276
35mm	457mm	364277
35mm	610mm	364278



Grab Rail

STAINLESS STEEL GRAB RAIL

- 32mm Diameter
- 305mm Length
- Supplied with fixing screws
- Larger than normal diameter makes them easier to grasp
- Manufactured from high quality stainless steel - won't rust

Item	Code
Grab Rail	364269

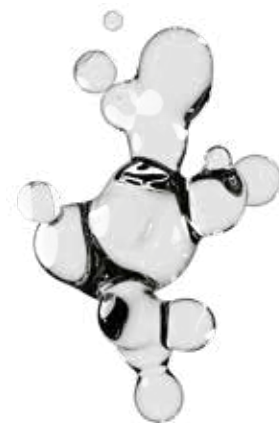

01 Bathroom/Kitchen Accessories // Plugs and Chains



Pop Up Plug
POP UP PLUG CHROME

- Chrome Effect
- Pop Up Plug

Finish	Code
Chrome Effect	368155
Gold Effect	368156



1 1/2" Plug
38mm POLYTHENE PLUG

- Supplied with triangle

Colour	Code
White	367166
Black	367167



1 3/4" Plug
42mm POLYTHENE PLUG

- Supplied with triangle

Colour	Code
White	367171
Black	367172



Chrome Plug
CHROME PLATED ON BRASS PLUG

- Chrome plated on brass plug
- Supplied with triangle

Size	Code
38mm (1 1/2")	367170
42mm (1 3/4")	367175



White Plug
RUBBER PLUG. VARIOUS SIZES

- Supplied with triangle

Size	Code
25mm (1")	367228
32mm (1 1/4")	367230
35mm (1 3/8")	367232
38mm (1 1/2")	367233
41mm (1 5/8")	367235

Size	Code
44mm (1 3/4")	367237
51mm (2")	367241
54mm (2 1/8")	367243
64mm (2 1/2")	367247



Bathroom/Kitchen Accessories // Plugs and Chains 01



White Tap Hole Stopper

WHITE TAP HOLE STOPPER WITH LOCKING NUT

Item	Code
White Tap Hole Stopper	367180



Chrome Tap Hole Stopper

CHROME PLATED TAP HOLE STOPPER WITH LOCKING NUT

Item	Code
Chrome Tap Hole Stopper	367183



Bath Overflow Stopper

BATH OVERFLOW STOPPER WHITE, GOLD OR CHROME PLATED

- Includes Locknut and Triangle
- Available in a range of finishes including white and gold plated
- Easy to fit

Finish	Code
White	367190
Gold Plated	367193



Cistern Hole Stopper

CISTERN HOLE STOPPER. WHITE AND CHROME PLATED

- Supplied With Locknut
- ½" BSP thread
- Easy to fit
- Available in white & chrome plated finishes

Finish	Code
White	367194
Chrome Plated	367199



Sink Overflow Stopper

WITH BLACK PLUG AND BACKNUT

- 32mm Black Sink Overflow Stopper
- Comes with Cap, Nut and Triangle

Item	Code
Sink Overflow Stopper	367189



Overflow Stopper

WHITE OVERFLOW STOPPER

- White Overflow Stopper supplied with 19mm [¾"] Washer and Jambnut for a secure fit.

Item	Code
Overflow Stopper	367198



01 Bathroom/Kitchen Accessories // Plugs and Chains



Basin Ball Chain

BASIN BALL CHAIN AND FITTINGS

- 305mm (12")
- Available in a range of styles
- Stylish and simple oval link chain

Fittings	Code
Stay and Hook	367202
Hook Both Ends	367204



Bath Ball Chain

BATH BALL CHAIN AND FITTINGS

- 457mm (18")
- Available in a range of styles
- Stylish and simple oval link chain

Fittings	Code
Stay and Hook	367215
Hook Both Ends	367217
Hook and 42mm [1½"] Plug	367219



Basin Oval Link Chain

BASIN OVAL LINK CHAIN AND FITTINGS

- 305mm (12")
- Available in a range of styles
- Stylish and simple oval link chain

Fittings	Code
Stay and Hook	367209
Hook Both Ends	367211



Oval Link Chain

610mm OVAL LINK CHAIN

- Hook both ends

Item	Code
Oval Link Chain	367227



Bath Oval Link Chain

BATH OVAL LINK CHAIN AND FITTINGS

- 18"
- Available in a range of styles
- Stylish and simple oval link chain

Fittings	Code
Stay and Hook	367221
Hook Both Ends	367223



Fittings	Code
Hook and 44mm [1¾"] Plug	367225

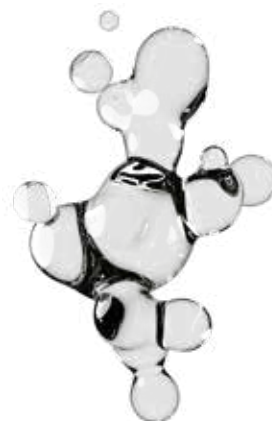

Cistern Levers and Pulls 02

WEDGE WASHER LEVER

BATHROOM ACCESSORIES // CISTERN LEVERS AND PULLS

Cistern Lever with Wedge Washer

- 120mm Spindle
- ½" Bush – Suitable for most standard cisterns
- Supplied with plastic multi purpose lift arm
- Suitable for curved fronted cisterns



Item	Code
120mm Spindle Chrome Effect	367100

E TYPE CISTERN LEVER

BATHROOM ACCESSORIES // CISTERN LEVERS AND PULLS

E-Type Finger Tip Front Cistern Levers

- ½" Bush – Suitable for most standard cisterns
- Supplied with plastic multi purpose lift arm



Item	Code
88mm Spindle Chrome Effect	367088
110mm Spindle Chrome Effect	367085
88mm Spindle Gold Effect	367132

D TYPE CISTERN LEVER

BATHROOM ACCESSORIES // CISTERN LEVERS AND PULLS

D-Type Cistern Grab Lever – Plastic Lift Arm

- 110mm Spindle
- ½" Bush – Suitable for most standard cisterns
- Supplied with plastic multi purpose lift arm



Item	Code
110mm Spindle	367078

02 Cistern Levers and Pulls



D TYPE CISTERN LEVER

BATHROOM ACCESSORIES // CISTERN LEVERS AND PULLS

D-Type Plastic Cistern Grab Lever – Brass Lift Arm

- 110mm Spindle
- ½" Bush - Supplied with Brass Adjustable Lift Arm

Item	Code
110mm Spindle Chrome Effect	367072
110mm Spindle Gold Effect	367129



S TYPE CISTERN LEVER

BATHROOM ACCESSORIES // CISTERN LEVERS AND PULLS

S-Type ¾" Front Cistern Levers

- 110mm Spindle
- ¾" Bush – Suitable for Ideal Standard cisterns with a smaller hole
- Supplied with plastic multi purpose lift arm

Item	Code
110mm Spindle Chrome Effect	367090
110mm Spindle Gold Effect	367133



X TYPE CISTERN LEVER

BATHROOM ACCESSORIES // CISTERN LEVERS AND PULLS

X-Type ¾" & ½" Universal Front Cistern Lever

- 110mm Spindle
- ¾" Bush - Suitable for Ideal Standard cisterns with a smaller hole
- ½" Bush - Suitable for most standard cisterns
- Supplied with plastic multi purpose lift arm

Finish	Code
110mm Spindle Chrome Effect	367093
110mm Spindle Gold Effect	367134

Cistern Levers and Pulls 02



SIDE CISTERN LEVER

BATHROOM ACCESSORIES // CISTERN LEVERS AND PULLS

Chrome Plated Cistern Side Lever

- 160mm Spindle
- ½" Bush – Suitable for most standard cisterns
- Plastic Lift Arm – Supplied with plastic multi purpose lift arm

Item	Code
160mm Spindle Cistern Lever	367087



ENABLER CISTERN LEVER

BATHROOM ACCESSORIES // CISTERN LEVERS AND PULLS

Chrome Plated Enabler Cistern Lever

- 120mm Spindle / 225mm Spindle
- ½" Bush – Suitable for most standard cisterns
- Supplied with plastic multi purpose lift arm

Item	Code
120mm Spindle Chrome Effect	367095
225mm Spindle Chrome Effect Concealed	317591



DIMPLE CISTERN LEVER

BATHROOM ACCESSORIES // CISTERN LEVERS AND PULLS

Chrome Plated Cistern Dimple Lever

- 114mm Spindle
- ½" Bush – Suitable for most standard cisterns
- Camel Multi Purpose Lift Arm
- Replaces most lever for easy operation

Item	Code
114mm Spindle Chrome Effect	315568

02 Cistern Levers and Pulls

PADDLE CISTERN LEVER

BATHROOM ACCESSORIES // CISTERN LEVERS AND PULLS

Chrome Plated Cistern Paddle Lever

- 100mm Spindle



Item	Code
110mm Spindle Chrome Plated	367098

CONCEALED CISTERN LEVER

BATHROOM ACCESSORIES // CISTERN LEVERS AND PULLS

Concealed Cistern Lever

- Range of spindle sizes
- $\frac{3}{8}$ " Bush – Suitable for Ideal Standard cisterns with a smaller hole
- Brass Adjustable Lift Arm



Item	Code
160mm (6") Spindle Chrome Effect	367073
225mm (9") Spindle Chrome Effect	367075
305mm (12") Spindle Chrome Effect	334610
160mm (6") Spindle Gold Effect	367125
225mm (9") Spindle Gold Effect	367126
305mm (12") Spindle Gold Effect	367127

SPECIAL LENGTH CONCEALED CISTERN LEVER

BATHROOM ACCESSORIES // CISTERN LEVERS AND PULLS

Special Length Concealed Cistern Levers

- Range of spindle sizes
- Chrome Plated
- $\frac{3}{8}$ " Bush – Suitable for Ideal Standard cisterns with a smaller hole
- Plastic Lift Arm – Supplied with plastic multi purpose lift arm



Item	Code
357mm (14") Spindle Chrome Effect	367081
408mm (16") Spindle Chrome Effect	367082
460mm (18") Spindle Chrome Effect	367083
600mm (24") Spindle Chrome Effect	367084

Cistern Levers and Pulls 02

CLASSIC CISTERN LEVER - MAHOGANY

BATHROOM ACCESSORIES // CISTERN LEVERS AND PULLS

Mahogany Finish Wooden Front Cistern Lever

- 110mm Spindle
- ½" Bush - Suitable for most standard cisterns
- Supplied with plastic multi purpose lift arm



Item	Code
110mm Spindle Chrome and Mahogany	367110
110mm Spindle Gold Effect and Mahogany	367142

CLASSIC CISTERN LEVER - PINE

BATHROOM ACCESSORIES // CISTERN LEVERS AND PULLS

Pine Finish Wooden Front Cistern Lever

- 110mm Spindle
- ½" Bush - Suitable for most standard cisterns
- Supplied with plastic multi purpose lift arm



Item	Code
110mm Spindle Chrome and Pine	367111
110mm Spindle Gold Effect and Pine	367143
110mm Spindle Gold Effect and Pine	367146

CLASSIC CISTERN LEVER - LIGHT OAK

BATHROOM ACCESSORIES // CISTERN LEVERS AND PULLS

Classic Wooden Front Cistern Lever – Light Oak Finish

- 110mm Spindle
- ½" Bush - Suitable for most standard cisterns
- Supplied with plastic multi purpose lift arm
- Chrome and Light Oak



Item	Code
110mm Spindle Chrome & Light Oak	367109

02 Cistern Levers and Pulls

CERAMIC CISTERN LEVER

BATHROOM ACCESSORIES // CISTERN LEVERS AND PULLS

Deluxe Ceramic Front Levers



- ½" Bush – Suitable for most standard cisterns
- ⅜" Bush – Suitable for Ideal Standard cisterns with a smaller hole
- Supplied with plastic multi purpose lift arm

Item	Code
110mm Spindle White - ½" Bush	367113
110mm Effect Gold Spindle - ½" Bush	367144
110mm Spindle White - ⅜" Bush	367116
110mm Spindle Gold Effect - ⅜" Bush	367147

CONCEALED CLASSIC CISTERN LEVER

BATHROOM ACCESSORIES // CISTERN LEVERS AND PULLS

Concealed Classic Cistern Levers



- ⅜" Bush – Suitable for Ideal Standard cisterns with a smaller hole
- Supplied with plastic and brass adjustable multi purpose lift arm

Item	Lift Arm	Code
160mm Spindle Chrome and White	Plastic	367102
160mm Spindle Gold Effect	Plastic	367137
225mm Spindle Chrome and White	Brass	367103
225mm Spindle Gold Effect	Brass	367139

CERAMIC CISTERN LEVER

BATHROOM ACCESSORIES // CISTERN LEVERS AND PULLS

Classic Ceramic Side Cistern Lever



- 160mm Spindle
- ½" Bush – Suitable for most standard cisterns
- Supplied with plastic multi purpose lift arm

Item	Code
160mm Spindle Chrome and White	367101
160mm Spindle Gold Effect	367137

Cistern Levers and Pulls 02

CERAMIC CISTERN LEVER

BATHROOM ACCESSORIES // CISTERN LEVERS AND PULLS

Economy Ceramic Front Cistern Lever

- 110mm Spindle
- ½" Bush – Suitable for most standard cisterns
- Supplied with plastic multi purpose lift arm
- White



Item	Code
110mm Spindle	367108



02 Cistern Levers and Pulls



CISTERN PULL

BATHROOM ACCESSORIES // CISTERN LEVERS AND PULLS

Victoriana Ceramic Cistern Pull Handle

- Supplied with a chrome plated 30" chain
- "Pull" Motif

Item	Code
Cistern Pull	367119



CISTERN PULL

BATHROOM ACCESSORIES // CISTERN LEVERS AND PULLS

Rubber Cistern Pull Handle

- Supplied with a chrome plated 30" chain

Item	Code
Cistern Pull	367310



CISTERN PULL

BATHROOM ACCESSORIES // CISTERN LEVERS AND PULLS

Wooden Cistern Pull Handle

- Supplied with a chrome plated 30" chain

Item	Code
Cistern Pull	367313

Cistern Levers and Pulls 02



High Level Cistern Lever
DIPLOMAT HIGH LEVEL CISTERN LEVER

- Supplied with fulcrum bracket and screw

Item	Code
High Level Cistern Lever	320008



High Level Cistern Lever
TRI-SHELL HIGH LEVEL CISTERN LEVER

- Supplied with fulcrum bracket and screw

Item	Code
High Level Cistern Lever	316173



High Level Cistern Lever
CHROME PLATED HIGH LEVEL CISTERN LEVER

- Supplied with fulcrum bracket and screw
- Chrome Plated

Item	Code
High Level Cistern Lever	367163



High Level Cistern Lever
POLISHED BRASS HIGH LEVEL CISTERN LEVER

- Supplied with fulcrum bracket and screw
- Polished Brass

Item	Code
High Level Cistern Lever	330217



Lift Arm
NATURAL PLASTIC MULTI PURPOSE
ADJUSTABLE LIFT-ARM

Item	Code
Lift Arm	367162



Lift Arm
BRASS ADJUSTABLE LIFT-ARM

Item	Code
Lift Arm	367159



Lift Arm
BLUE 'CAMEL' ADJUSTABLE LIFT-ARM

Item	Code
Lift Arm	316340



Lift Arm
NATURAL 'CAMEL' ADJUSTABLE LIFT-ARM

Item	Code
Lift Arm	317165



Lift Arm Bush
NATURAL 13mm (1/2") CISTERN LEVER BUSH

Item	Code
Lift Arm Bush	367158

03 Cistern & Tank Fittings // Syphon & Flush Valve Accessories



Coupling Nuts

HIGH QUALITY THREADED COUPLING NUT

- Manufactured from high quality materials and internally threaded
- Wide range of sizes providing plenty of options for all types of installations

Size	Code
19mm [¾"]	372927
25mm [1"] 22mm I.D	370785
25mm [1"] 28mm I.D	368270
32mm [1¼"] to suit 1" Pipe	368273
32mm [1¼"] to suit 1¼" Pipe	368274
50mm [2"]	371038
50mm [2"] European Thread	368275



Jamb Nuts

HIGH QUALITY THREADED JAMB NUT

- Manufactured from high quality materials
- Range of sizes from 10mm (¾") to 50mm (2")
- Internal thread
- European thread also available

Size	Code
10mm [¾"]	370343
13mm [½"]	370223
19mm [¾"]	370222
25mm [1"]	370815
32mm [1¼"]	368277
38mm [1½"]	370216
50mm [2"]	368278
50mm [2"] European Thread	368279

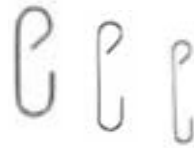

C-Links

STAINLESS STEEL 'C' LINKS

- Manufactured from high-quality stainless steel
- Connects syphon to cistern lever; easy flushing

Size	Code
2"	364880
Up to 3"	318134
3"	364882
3½"	317307
3¾"	317898
Up to 4"	317143
4"	364884
4¼"	322946
4½"	318323
5½"	317537



Syphon Diaphragm Washer

ROUND / OVAL SYPHON DIAPHRAGM WASHER

- 127mm (5") Oval Shape in clear, strong plastic
- 114mm (4½") and 127mm (5") Round Shape in clear, strong plastic
- Seals syphon housing to ensure water efficient flush

Item	Code
4½" Round	367473
5" Round	367477
5" Oval	367470



Syphon Extension Pieces

USED TO RAISE THE HEIGHT OF A SYPHON IN A LEVER OPERATED FLUSHING CISTERN

- Helps extend the height of syphon in lever operated cisterns

Size	Code
38mm [1½"]	364879



Petcock

ADJUSTABLE FLOW CONTROL PETCOCK. FOR USE WITH AUTOMATIC SYPHONS

- Suitable for use with Automatic Syphons see page 33
- Fitted to inlet pipe for adjustable flow control
- Can be easily adjusted by removing end cap, & twisting the valve inside to control fill rate to desired flow

Item	Code
Petcock (½" BSPT)	364979

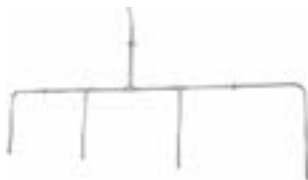

Sparge Pipe Sets

STAINLESS STEEL SPARGE SETS

- Includes Brackets & Fixings
- 23mm Bowl Offset & 90mm Cistern Offset
- Multiple Bowl set options

Bowl Set	Code
1	330621
2	330622
3	330623
4	330624



Urinal Spreader

EPSON URINAL SPREADER

- Top inlet is a push-fit mechanism; easy install
- Mostly used as a replacement in exposed urinal cistern systems
- Back Inlet Tail is made from solid brass and head has a smooth chrome finish

Inlet	Code
Back	364968
Top	364969



DC Pipe Interrupter

DC PIPE INTERRUPTER FOR USE WITH URINALS AND DIRECT FLUSH URINAL SENSORS

- 15mm Inlet / 22mm Outlet
- Prevents bacteria contaminating mains water supply
- For use with urinals & direct flush urinal sensors see pages 46-47

Item	Code
DC Pipe Interrupter	327995

Cistern & Tank Fittings // Flushpipe Bends & Accessories 03

Epson Europipe

SPECIFICALLY DESIGNED TO FIT EUROPEAN STYLED FITTINGS

- 457 x 457mm [18"x18"] 2" [50mm] to 1½" [41mm]
- Manufactured from one piece, rigid white PVC, has high strength & rigidity, allowing for a good seal at either end, & maintaining a full flush
- Standard size of 18" x 18" this allows the installer to cut the pipe horizontally or vertically to size, allowing greater flexibility in cistern height installation, & wall to pan distance
- Should you be presented with a more irregular installation problem, on request this flushpipe can be manufactured to a max height of 20" & a maxi wall to pan length of 36"
- Manufactured from one piece, rigid white PVC. On request horizontal length can be increased to a max of 36"



Item	Code
Epson Europipe	363705



PVC Flushbends

PVC LOW LEVEL AND EXTENDED FLUSHBENDS

- Manufactured with a 38mm Outside Diameter
- 90° Swept Bend
- Come supplied with tapered sealing ring

Size	Code
356mm x 229mm x 38mm [14" x 9" x 1½"]	363656
300mm x 300mm x 38mm [12" x 12" x 1½"]	363654
406mm x 254mm x 38mm [16" x 10" x 1½"]	363676
406mm x 356mm x 38mm [16" x 14" x 1½"]	363677
406mm x 406mm x 38mm [16" x 16" x 1½"]	363679
457mm x 457mm x 38mm [18" x 18" x 1½"]	363684
510mm x 510mm x 38mm [20" x 20" x 1½"]	363686
610mm x 457mm x 38mm [24" x 18" x 1½"]	363687
610mm x 610mm x 38mm [24" x 24" x 1½"]	363688
763mm x 457mm x 38mm [30" x 18" x 1½"]	363691

High Level Backwall

TWO-PIECE FLUSHPIPE MANUFACTURED FROM HIGH QUALITY WHITE PVC

- 1525mm [5'] Pan to Cistern Height
- Different top offsets can be manufactured to order
- Supplied with fitted 45mm flange



Size	Code
1657mm [5'6"] Pan to Cistern Height	363626

High Level Sidewall

THREE-PIECE FLUSHPIPE MANUFACTURED FROM TOP QUALITY WHITE PVC. 32mm BORE

- 1657mm [5'6"] Pan to Cistern Height



Item	Code
High Level Sidewall	363634

Tight Radius Flushbend

90° TIGHT RADIUS FLUSHBEND MANUFACTURED FROM HIGH QUALITY WHITE PVC

- 457mm x 305mm [18" x 12"]
- 90° Tight Radius
- 38mm Outside Diameter



Item	Code
Tight Radius Flushbend	363683

High Level Two-Piece Flushpipe

MANUFACTURED FROM HIGH QUALITY SEAMLESS BRASS TUBE

- 32mm Bore
- 110mm wall to centre top offset
- 203mm return bend
- 1657mm pan to cistern height
- Chrome Plated



Item	Code
High Level Two-Piece Flushpipe	363628

Low Level Flushpipe

MANUFACTURED FROM HIGH QUALITY SEAMLESS BRASS TUBE

- 408mm x 254mm [16" x 10"]
- Chrome Plated



Size	Code
Low Level Flushpipe	363642

03 Cistern & Tank Fittings // Flushpipe Bends & Accessories



Buffer Clip

CHROME PLATED DECORATIVE STYLED FLUSHPIPE CLIPS

- Chrome Plated
- High and Low Level Specification

Item	Code
Buffer Clip	363751



Syphon Tail Shroud

BELL SHAPED 35mm SPUN BRASS SYPHON TAIL SHROUD

- High and Low Level Specification
- Chrome Plated

Size	Code
High Level 35mm	363755
Low Level 38mm	363758



Tapered PVC Rings

TO SUIT FLUSHPIPES AND FLUSHBENDS

- Flexible tapered PVC sealing ring for sealing flushpipes or flushbends to syphon

Size	Code
32mm [1¼"]	367462
38mm [1½"]	367463
50mm [2"]	367464



EVA/Polythene Flushpipe Connector

EVA/POLYTHENE INTERNAL FIN TYPE

- To fit 38mm [1½"] Flushpipes
- EVA/Polythene Internal Fin Type

Item	Code
EVA/Polythene Flushpipe Connector	370220



PVC Flushpipe Connector

PVC INTERNAL

- To fit 38mm [1½"] Flushpipes
- PVC Internal

Item	Code
PVC Flushpipe Connector	370221



Universal Flushpipe Connector

UNIVERSAL - ACCOMMODATES BOTH 1¼" AND 1½" FLUSHPIPES

- Universal can fit both 38mm and 32mm [1½" and 1¼"]
- Universal External

Item	Code
Universal Flushpipe Connector	363717



European Flushpipe Connector

EUROPEAN TO SUIT 1½" FLUSHPIPE

- To suit 41mm [1½"] Flushpipes
- European to suit 1½" pipe

Item	Code
European Flushpipe Connector	370214



Cistern & Tank Fittings // Close Coupling Kits & Spares 03



Close Coupling Kit

DOUGHNUT WASHER 1 1/2" OUTLET

- Supplied with 1 1/2" cranked plate, nuts, bolts and a standard rubber doughnut washer
- For cisterns with 1 1/2" outlet

Item	Code
Close Coupling Kit	363765



Close Coupling Kit

FLAT PLATE AND IS RING 1 1/2" OUTLET

- Supplied with 1 1/2" flat plate, nuts, bolts and IS Sealing Ring
- For cisterns with 1 1/2" Outlet

Item	Code
Close Coupling Kit	363770



Close Coupling Kit

FOAM WASHER 2" OUTLET

- Supplied with a 2" cranked plate, nuts, bolts and a 2" foam washer
- For cisterns with 2" outlet

Item	Code
Close Coupling Kit	334181



Close Coupling Kit

FOAM WASHER 1 1/2" OUTLET

- Supplied with 1 1/2" cranked plate, nuts, bolts and a standard washer
- For cisterns with 1 1/2" outlet

Item	Code
Close Coupling Kit	363763



Close Coupling Kit

STEPPED WASHER 1 1/2" OUTLET

- Supplied with 1 1/2" cranked plate, nuts, bolts and a stepped rubber washer
- For cisterns with 1 1/2" outlet

Item	Code
Close Coupling Kit	363764



Close Coupling Kit Bolts

CISTERN TO PAN, NUT, BOLT AND WASHER SET

- Supplied with nuts, bolts and washers
- Long type bolts
- Multiple washers to ensure a watertight fit

Item	Code
Close Coupling Kit	363768



Close Coupling Kit Bolts

NUT, BOLT AND WASHERS (PAIR)

- Supplied with nuts, bolts and washers
- Standard size bolts

Item	Code
Close Coupling Kit	363761



03 Cistern & Tank Fittings // Close Coupling Kits & Spares



Close Coupling Kit Washer

DOUGHNUT WASHER

- Manufactured from high-quality strong rubber
- Fits securely between cistern and pan
- To suit 1½" outlet

Item	Code
Close Coupling Kit Washer	367486



Close Coupling Kit Washer

FOAM WASHER

- Manufactured from high-quality materials
- Fits securely between cistern and pan
- To suit 1½" outlet

Item	Code
Close Coupling Kit Washer	367491



Close Coupling Kit Washer

2" FOAM WASHER

- 2" Washer [110mm x 69mm x 18mm]
- Manufactured from high-quality materials
- Fits securely between cistern and pan
- To suit 2" outlet

Size	Code
2" Close Coupling Kit Washer	367494



Close Coupling Kit Washer

STEPPED WASHER

- Manufactured from high-quality strong rubber
- Fits securely between cistern and pan
- To suit 1½" outlet

Item	Code
Close Coupling Kit Washer	367490



Cistern to Pan Kit Washer

SELF CENTRING CONICAL SEALING WASHER

Item	Code
Close Coupling Kit Washer	367493



Close Coupling Kit Washer

IDEAL STANDARD RING

- Ideal Standard manufactured sealing ring
- Most commonly used with Ideal Standard toilets, but can also be used on other close coupled cisterns

Item	Code
Close Coupling Kit Washer	367488



Overflow

19mm [¾"] TANK CONNECTOR/ CISTERN OVERFLOW

- ¾" BSP

Size	Code
¾" BSP Overflow	367309



Overflow

19mm [¾"] VERTICAL CISTERN OVERFLOW STRAIGHT

- ¾" BSP

Size	Code
¾" BSP Overflow	367308



Overflow

19mm [¾"] VERTICAL CISTERN OVERFLOW OFFSET

- ¾" BSP

Size	Code
¾" BSP Overflow	367307

04 Pre-Packed Products // Plumbing Boxes



NO.1 IMPERIAL O RING PLUMBERS REPAIR KIT BOX

PRE-PACKED PRODUCTS // PLUMBING BOXES

No.1 Imperial O Ring Plumbers Repair Kit Box

Kit Contains:

- 018 'O' Ring x 15
- 19 'O' Ring x 15
- 115 'O' Ring x 15
- 212 'O' Ring x 5
- 213 'O' Ring x 5
- 119 'O' Ring x 5
- 121 'O' Ring x 5
- 117 'O' Ring x 10
- 110 'O' Ring x 15
- 025 'O' Ring x 15
- 118 'O' Ring x 5
- 119 'O' Ring x 5

Item	Code
No.1 Plumbers Repair Kit Box	367528



NO.2 BALLVALVE PLUMBERS REPAIR KIT BOX

PRE-PACKED PRODUCTS // PLUMBING BOXES

No.2 Ballvalve Plumbers Repair Kit Box

Kit Contains:

- ½" Ballvalve Rubber Washers x 10
- ¾" Ballvalve Rubber Washers x 5
- ½" Ballvalve Seat Fibre x 10
- Small/Medium Brass Split Pins x 2/5
- ¾" Ballvalve Rubber Washers x 10
- 1"¾" Ballvalve Rubber Washers x 5/5
- High Pressure Seats x 5
- Aquasave Ballvalve Rubber Washers x 5
- ¾" Ballvalve Rubber Washers x 10
- Ballvalve Stem Washer x 2
- 115 'O' Ring x 2
- Low Pressure Seats x 5

Item	Code
No.2 Plumbers Repair Kit Box	367505



NO.3 TAP WASHER PLUMBERS REPAIR KIT BOX

PRE-PACKED PRODUCTS // PLUMBING BOXES

No.3 Tap Washer Plumbers Repair Kit Box

Kit Contains:

- ¾" Flat Tap Rubber Washers x 10
- ½" Flat Tap Rubber Washers x 10
- ¾" Flat Tap Rubber Washers x 10
- ¾" Flat Tap Rubber Washers x 8
- ½" Tantofex Tap Rubber Washers x 10
- ½"/¾" Flat Tap and Jumper x 1/1
- ½" Delta Tap Washers x 5
- ½"/¾" Dome Tap and Jumpers x 2/1
- ¾" Tantofex Tap Rubber Washers x 10
- ½" Pegler/Barking Grohe Tap Washers x 3/2
- ¾" Delta Tap Washers x 5
- Supatap Type A/D/B Washers x 2/2/1

Item	Code
No.3 Plumbers Repair Kit Box	367542

04 Pre-Packed Products // Plumbing Boxes



NO.4 FIBRE AND RUBBER WASHERS PLUMBERS REPAIR KIT BOX

PRE-PACKED PRODUCTS // PLUMBING BOXES

No.4 Fibre & Rubber Washers Plumbers Repair Kit Box

Kit Contains:

- ½" Ballvalve Seat Fibre Washers x 10
- ¾" Ballvalve Seat Fibre Washers x 5
- 15mm Flexible Tap Connector Washers x 10
- ¾" Washing Machine Hose Rubber Washer x 10
- ½" Top of Tap Body Fibre Washers x 5
- 15mm Fibre Tap Connector Washers x 10
- 22mm Flexible Tap Connector Washers x 10
- ¾" Top of Tap Body Fibre Washers x 5
- 22mm Fibre Tap Connector Washers x 10
- Bath Shower Divertor/ Washing Machine Hose Filter/ Hot Water Bottle Washers x 5/1/5
- Rubber/ Fibre/ ¾" Draw Off Tap Washers x 5/5/2

Item	Code
No.4 Plumbers Repair Kit Box	367518



NO.5 METRIC O RING PLUMBERS REPAIR KIT BOX

PRE-PACKED PRODUCTS // PLUMBING BOXES

No.5 Metric 'O' Ring Plumbers Repair Kit Box

Kit Contains:

- 3mm x 2mm 'O' Ring x 25
- 4mm x 2mm 'O' Ring x 25
- 6mm x 2mm 'O' Ring x 25
- 7mm x 2mm 'O' Ring x 25
- 10mm x 2.5mm 'O' Ring x 20
- 11mm x 2.5mm 'O' Ring x 20
- 12mm x 2.5mm 'O' Ring x 20
- 17mm x 2.5mm 'O' Ring x 20
- 19mm x 2.5mm 'O' Ring x 10
- 19mm x 3mm 'O' Ring x 10
- 20mm x 3mm 'O' Ring x 10
- 24mm x 3mm 'O' Ring x 10

Item	Code
No.5 Plumbers Repair Kit Box	367531



DIAPHRAGM WASHER BOX

PRE-PACKED PRODUCTS // PLUMBING BOXES

24/7 Diaphragm Washer Box

Kit Contains:

- Siamp Diaphragm Washer x 10
- Fluidmaster Standard Seal x 5
- Ballvalve 'O' Ring / Tail Washers x2 / x2
- Wisa Diaphragm Washer x 2
- 1½" Ballvalve Diaphragm Washer x 10
- Wirquin Diaphragm Washer x 2
- Hydroflo Diaphragm Washer x 3
- 1½" Ballvalve Washer x 5
- ½" Ballvalve Stem Washer x 5
- ½" Ballvalve Washer x 10

Item	Code
Diaphragm Washer Box	367514

Pre-Packed Products // Plumbing Boxes 04



MEGA PLUMBING BOX

PRE-PACKED PRODUCTS // PLUMBING BOXES

Mega Plumbing Box. Contains 394 Products

Kit Contains:

- Various Tap Washers
- Ballvalve Washers
- Poly Washers
- Various 'O' Rings
- Hose Washers
- Fibre Washers
- Lift Arms
- Supa Tap A, B & D
- 1½" Ballvalve Diaphragm Washer
- Bath and Basin Plugs
- Ballvalve Seatings
- Bath and Basin Chain
- Brass Olives
- Cotter Pins
- Radiator Keys
- C Links
- Universal Seat Fixing Kit

Item	Code
Mega Plumbing Box	367556



MEGA TAP WASHER BOX

PRE-PACKED PRODUCTS // PLUMBING BOXES

Mega Tap Washer Box. Contains 695 Products

Kit Contains:

- ⅜" Flat Tap Washers x 50
- ½" Flat Tap Washers x 100
- ⅝" Flat Tap Washers x 50
- ¾" Flat Tap Washers x 100
- ⅜" Dome Tap Washers x 25
- ½" Dome Tap Washers x 100
- ⅜" Dome Tap Washers x 25
- ½" Dome Tap Washers x 100
- ⅜" Dome Tap Washers x 25
- ½" Dome Tap Washers x 100
- ⅜" Dome Tap Washers x 25
- ½" Dome Tap Washers x 100
- ⅜" Dome Tap Washers x 25
- ½" Dome Tap Washers x 100

Item	Code
Mega Tap Washer Box	367557



MEGA IMPERIAL 'O' RING BOX

PRE-PACKED PRODUCTS // PLUMBING BOXES

Mega Imperial 'O' Ring Plumbers Repair Box. 435 'O' Rings

Kit Contains:

- 006 'O' Ring x 30
- 007 'O' Ring x 30
- 008 'O' Ring x 30
- 009 'O' Ring x 30
- 010 'O' Ring x 30
- 011 'O' Ring x 30
- 012 'O' Ring x 30
- 013 'O' Ring x 20
- 014 'O' Ring x 20
- 015 'O' Ring x 10
- 016 'O' Ring x 10
- 017 'O' Ring x 10
- 018 'O' Ring x 10
- 019 'O' Ring x 15
- 020 'O' Ring x 15
- 113 'O' Ring x 15
- 114 'O' Ring x 10
- 115 'O' Ring x 10
- 116 'O' Ring x 10
- 117 'O' Ring x 10
- 118 'O' Ring x 5
- 119 'O' Ring x 5
- 120 'O' Ring x 5
- 211 'O' Ring x 5
- 212 'O' Ring x 5
- 213 'O' Ring x 5
- 214 'O' Ring x 5
- 215 'O' Ring x 5
- 216 'O' Ring x 5

Item	Code
Imperial 'O' ring Box	367559

04 Pre-Packed Products // Plumbing Boxes



24 COMPARTMENT 'O' RING BOX

PRE-PACKED PRODUCTS // PLUMBING BOXES

24 Compartment Plumbers Imperial 'O' Ring Box. 295 'O' Rings

Kit Contains:

- 019 'O' Ring x 15
- 020 'O' Ring x 15
- 120 'O' Ring x 15
- 121 'O' Ring x 15
- 122 'O' Ring x 15
- 123 'O' Ring x 15
- 124 'O' Ring x 15
- 125 'O' Ring x 15
- 126 'O' Ring x 15
- 217 'O' Ring x 15
- 218 'O' Ring x 15
- 219 'O' Ring x 15
- 220 'O' Ring x 15
- 221 'O' Ring x 10
- 222 'O' Ring x 10
- 223 'O' Ring x 10
- 224 'O' Ring x 10
- 226 'O' Ring x 10
- 225 'O' Ring x 10
- 325 'O' Ring x 10
- 326 'O' Ring x 10
- 327 'O' Ring x 10
- 328 'O' Ring x 5
- 329 'O' Ring x 5

Item	Code
24 Compartment 'O' Ring Box	367558



ASSORTED IMPERIAL 'O' RING BOX

PRE-PACKED PRODUCTS // PLUMBING BOXES

18 Compartment Plumbers Imperial 'O' Ring Box. 340 'O' Rings

Kit Contains:

- 011 'O' Ring x 20
- 012 'O' Ring x 20
- 013 'O' Ring x 20
- 014 'O' Ring x 20
- 015 'O' Ring x 20
- 016 'O' Ring x 20
- 017 'O' Ring x 20
- 018 'O' Ring x 20
- 111 'O' Ring x 20
- 112 'O' Ring x 20
- 113 'O' Ring x 20
- 114 'O' Ring x 20
- 115 'O' Ring x 20
- 116 'O' Ring x 20
- 117 'O' Ring x 20
- 118 'O' Ring x 20
- 123 'O' Ring x 10
- 124 'O' Ring x 10

Item	Code
Assorted Imperial 'O' Ring Box	367551



ASSORTED WASHER PACK

PRE-PACKED PRODUCTS // PLUMBING BOXES

18 Compartment Assorted Washer Pack 203 Washers.

Kit Contains:

- ½"/¾" Flex Tube Washers x 15/10
- Washing Machine Hose Washers x 10
- ½"/¾" Prestex Washers x 10/10
- Draw off Tap Washers x 15
- Ballvalve Diaphragm Washers x 5
- ¾"/½"/¾"/¼" Flat Tap Washers x 15/30/10/10
- ½"/¾" Ballvalve Seating Washers x 10/10
- ½"/¾" Flexible Tap Connector Washers x 15/10
- ¾" x ¾" Rubber Hot Water Bottle Washers x 10
- ½"/¾" Fibre Tap Body Washer x 5/3

Item	Code
Assorted Washer Pack	367552

Pre-Packed Products // Plumbing Boxes 04



HANDY WASHER PACK

PRE-PACKED PRODUCTS // PLUMBING BOXES

19 Compartment Handy Washer Pack 263 Washers

Kit Contains:

- ½"/¾" Flex Tube Washers x 20/20
- Washing Machine Hose Washers/ Draw off Tap Washers x 20/20
- ½"/¾" Prestex Washers x 20/20
- Ballvalve Diaphragm Washers x 5
- ½"/¾" Flat Tap Washers x 20/10
- Supatap 'A', 'D' and 'B' x 3/5/2
- ½"/¾" Ballvalve Seating Washers x 20/10
- ½"/¾" Flexible Tap Connector Washers x 20/20
- ½"/¾" Dome Tap Washers x 10/2
- ½"/¾" Dome Tap Washer and Jumper x 3/1
- ½"/¾" Flat Tap Washer and Jumper x 3/2
- ½"/¾" Top Body Washer x 5/2

Item	Code
Handy Washer Pack	367553



04 Pre-Packed Products // Polybag Range



Air Cocks and Keys

AIR COCKS AND KEYS – POLYBAG

- A range of high quality Air Cocks and Keys handily packed in polybags

Type	Pack Qty	Code
Brass Clock Type Rad Key	1	368888
Rad Key Alloy	2	368890
Rad Key Brass	2	368891
½" Air Vent	1	368893
½" Air Vent	2	368894
Air Vent Washer, Fibre	5	368763



Brass Olives

BRASS OLIVES - POLYBAG

- A range of high quality Brass Olives handily packed in polybags

Size	Pack Qty	Code
8mm Brass Olives	5	368459
10mm Brass Olives	5	368460
15mm Brass Olives	10	368461
¾" Brass Olives	5	368467
22mm Brass Olives	5	368463



Cistern Levers and Accessories

CISTERN LEVERS AND ACCESSORIES – POLYBAG

Type	Pack Qty	Code
'E' Type Lever	1	368543
Standard Cistern Lever, CP	1	368541
'D' Type Lever	1	368540
Brass Adjustable Lift Arm	1	368552
'X' Type Lever	1	368545
Multi-Purpose Lift-Arm	1	368553



Flexible Tube & Hose Washers

FLEXIBLE TUBE & HOSE WASHERS – POLYBAG

- A range of high quality flexible Tube and Hose Washers handily packed in polybags

Type	Pack Qty	Code
½" Shower Hose Washer	5	368846
¾" Gauze Filter Washer	2	368853
¾" Washing Machine Washer	5	368851
½" Flexible Tube Washer	10	368867



Flushpipe Accessories

FLUSHPIPE ACCESSORIES – POLYBAG

- A range of high quality Flushpipe Accessories handily packaged in polybags

Type	Pack Qty	Code
White Internal Connector	1	368387
Fin Type Pan Connector	1	368390
32mm Flushpipe Sealing Ring	2	368686
38mm Flushpipe Sealing Ring	2	368687



Hinges, Brackets & Accessories

HINGES, BRACKETS & ACCESSORIES – POLYBAG

- A range of high quality Hinges, Brackets and Accessories handily packed in polybags.

Type	Pack Qty	Code
Basin Brackets	Pair	368627
Universal Fixing Kit	Pair	368633
White Celmac Toilet Seat Hinge	1	368634
Black Celmac Toilet Seat Hinge	1	368635



Pre-Packed Products // Polybag Range 04



Inlet Valve Accessories

INLET VALVE ACCESSORIES - POLYBAG

Type	Pack Qty	Code
5/8" Ballvalve Washer, Rubber	2	368825
1/2 x 1/8 High Pressure Seating, White	5	368837
3/4" Ball Valve Washer, Rubber	2	368827

Type	Pack Qty	Code
Low Pressure Seating, Red	5	368839
1 1/4" Ballvalve Washer, Rubber	2	368819
Large Cotter Pin, Brass	2	368811
Ballvalve Repair Kit Pack	1	368829
1/2" Small Cotter Pin	2	368809
1/2" Ballvalve Seating Washer	5	368834
1 1/4" Ballvalve Washer	2	368813
3/4" Ballvalve Seating Washer	5	368836
1 1/4" Ballvalve Washer	5	368814
1/2" Ballvalve Tail washer	5	368857
1/2" Ballvalve Washer, Rubber	5	368820



Miscellaneous Washers

MISCELLANEOUS WASHERS - POLYBAG

Type	Pack Qty	Code
Immersion Heater Washer	1	368877
Bath/Shower Diverter Washer	2	368855
Large Immersion Heater Washer	1	368878



Nuts and Clips

NUTS AND CLIPS - POLYBAG

- A range of high quality Nuts and Clips handily packed in polybags

Type	Pack Qty	Code
15mm Snap in Pipe Clip	5	368600
16-22mm Hose Clip	2	368881
18-25mm Hose Clip	2	368882
15mm Wrap Over Pipe Clip	5	368603

Type	Pack Qty	Code
1 1/2" B.S.P.T Syphon Coupling Nut White	1	368904
1/2" Jamb Nut Pack	1	368906
15mm Nail In Pipe Clip	6	368610
13-20mm Hose Clip	2	368880



Pillar Tap Washers

PILLAR TAP WASHERS - POLYBAG

Type	Pack Qty	Code
1/2" Pillar Tap Washer	5	368637
1 1/4" Lavatory/ Basin Washer	5	368663
1/2" Pillar Tap Washer - C.N.A.F	10	368640
1 1/4" Sink Washer	5	368668
1/2" Pillar Tap Washer, Rubber	10	368644
1 1/2" Bath Washer	5	368671
1/2" Pillar Tap Washer, Rubber	5	368647
Assorted Washer Pack	8	368675
3/4" Pillar Tap Washer	10	368646
1 1/2" Sink Washer	5	368677
3/4" Pillar Tap Washer, C.N.A.F	10	368650
3/4" Pillar Tap Washer, Rubber	10	368654
Universal Top Hat Washer	2	368709
1" Tank Washer	5	368656
Split Klick Top Hat Washer	2	368711
Split Klick Centralising Washer	2	368712
1 1/4" Bath Washer	5	368661



Plugs, Chains and Stoppers

PLUGS, CHAINS AND STOPPERS - POLYBAG

- A range of high quality Plugs, Chains and Stoppers handily packed in polybags

Type	Pack Qty	Code
1 3/4" White Waste Plug	2	368562
White Bath Overflow Stopper	1	368578

Type	Pack Qty	Code
1 1/2" Black Waste Plug	2	368556
1 3/4" Black Waste Plug	2	368563
Cistern Hole Stopper - Chrome	1	368586
12" Ball Chain Stay & Hook	1	368588
1 1/2" Plug, CP on Brass	1	368559
1 3/4" Plug, CP on Brass	1	368565
Bath Overflow Stopper	1	368580
12" Oval Chain - Stay & Hook	1	368592
White Tap Hole Stopper	1	368571
18" Ball Chain Stay & Hook	1	368593
CP Tap Hole Stopper	1	368573
18" Ball Chain c/w 2 Hooks	1	368594

04 Pre-Packed Products // Polybag Range



Syphon Accessories

SYPHON ACCESSORIES – POLYBAG

Type	Pack Qty	Code
Nut, Bolt and Washer C.C Kit- Pair	Pair	368392
Mixed Pack Syphon Dia. Washer	10	368699
Close Coupling Kit	1	368396
Syvac Aspirator	1	368493
'Doughnut' C.C Kit Washer	1	368713
1½" Syphon Tail Washer, Rubber	2	368691
2" 'C' Link, Small	2	368496
1¼" Syphon Tail Washer, Rubber	2	368693
1" Syphon Tail Washer, Rubber	2	368695
'C' Link Small & Large	2	368498
4½" Syphon Dia. Washer	5	368700
4" C Link Large	2	368500
Petcock	1	368518



Tap Washers

TAP WASHERS – POLYBAG

Type	Pack Qty	Code
½" Flat Tap Washer c/w Jumper	2	368727
¾" Flat Tap Washer c/w Jumper	2	368729
¾" Flat Tap Washer	5	368731
¾" Prestex Washer	10	368769
½" Flat Tap Washer	10	368734
½" Flex Tap Connector Washer	10	368774
¾" Flat Tap Washer	10	368742
¾" Flex Tap Connector Washer	10	368780
¾" Flat Tap Washer	5	368743
½" Delta Tap Washer	5	368789
1" Flat Tap Washer	1	368747
¾" Delta Tap Washer	5	368794
½" Pegler Washer	5	368749
Supatap 'A' Washer	2	368798
Supatap 'B' Washer	2	368800
½" Dome Tap Washer c/w Jumper	2	368756
Supatap 'D' Washer	2	368802
¾" Dome Tap Washer c/w Jumper	2	368758
½" Tantofex Washer	5	368804
½" Dome Tap Washer	5	368760
¾" Tantofex Washer	5	368807
¾" Dome Tap Washer	5	368762
½" Draw Off Cock Washer	5	368862
½" Prestex Washer	10	368764



Trap Sealing Washers

TRAP SEALING WASHERS – POLYBAG

Type	Pack Qty	Code
32mm Trap Sealing Ring	2	368682
38mm Trap Sealing Ring	2	368684
32mm Trap Inlet Washer	2	368723
38mm Trap Inlet Washer	2	368725



Washers & Seals // Tap 05



Top Hat Washers

TO FIT EITHER 1/2" OR 3/4" TAPS

Item	Code
1/2"/3/4" Universal Top Hat Washer	370207
1/2" Top Hat Washer	367479
3/4" Top Hat Washer	367480
Pillar Tap Fixing Washer	367484



Split-Klick Washers

MINIMISES THE RISK OF TAP SPIN

- Manufactured from high quality materials
- Simple but effective product
- To suit 1/2" taps

Item	Code
Split Kick Top Hat Washer	367483
Split Kick Centralising Washer	367485



Flat Tap Washer comes with Brass Jumper

REPLACEMENT FOR WORN OR LEAKING TAP WASHERS

Size	Code
1/2"	367841
3/4"	367843



Flat Tap Washer

FLAT TAP WASHERS IN VARIOUS SIZES

Size	OD (mm)	ID (mm)	Thickness (mm)	Code
3/8"	15.84	4.46	4.5	367845
1/2"	18.56	4.7	4.5	367851
5/8"	21.42	4.87	5	370335
3/4"	24.96	4.93	5	367860
1"	30.76	4.73	4	367865



Dome Tap Washer

DOMED TAP WASHERS IN VARIOUS SIZES

Size	OD (mm)	ID (mm)	Thickness (mm)	Code
3/8"	15.22	7.05	7	367876
1/2"	17.08	3.37	9	370334
5/8"	19.77	4.55	9	367885
3/4"	22.9	5.06	10	367889
1"	29.8	10.2	10	367894



Red Fibre Tap Washer

RED FIBRE FLAT TAP WASHERS. VARIOUS SIZES.

Size	OD (mm)	ID (mm)	Thickness (mm)	Code
3/8"	16	3.86	2.85	367927
1/2"	19.15	4.7	4.2	367928
5/8"	22.1	4.5	4.74	367930
3/4"	25.5	5	2.9	367931



Dome Tap Washer with Jumper

DOMED TAP WASHERS IN VARIOUS SIZES - WITH PLASTIC JUMPER

- Designed to fit a range of tap sizes

Size	Code
3/8"	367871
1/2"	367872
5/8"	367874
3/4"	367875



Delta Tap Washer

DELTA (21) TAP WASHER

Size	OD (mm)	ID (mm)	Thickness (mm)	Code
1/2"	15.64	5.02	5.3	367934
3/4"	18.46	4.23	5.12	370344



Tantofex Tap Washer

TANTOFEX TAP WASHER. VARIOUS SIZES

Size	OD (mm)	ID (mm)	Thickness (mm)	Code
1/2"	16.42	5.63	5	370217
3/4"	19.6	5.96	4	367946

05 Washers & Seals // Taps // Toilet Cistern / Tank



Pegler Tap Washer

PEGLER TAP WASHER. VARIOUS SIZES.

Size	OD (mm)	ID (mm)	Thickness (mm)	Code
½"	15.92	3.8	4.5	370692
¾"	18.06	5.2	4	370693



Top of Tap Washer

TOP OF TAP BODY WASHERS – FIBRE

Type	OD (mm)	ID (mm)	Thickness (mm)	Code
No.1	31.5	28.51	1.5	367950
No.2	30.06	25.34	1.5	367952
No.3	28.47	23.8	1.5	367948
No.4	38.01	31	1.5	367949



Supa-Tap Washer

SUPA-TAP WASHERS. VARIOUS SIZES.

- Available in either ½" or ¾"

Size	Code
½" (Supa-tap A)	367938
¾" (Supa-tap B)	367941
½" (Supa-tap D)	367943



Anti-Splash Tap Washer

ANTI-SPLASH SUPA-TAP WASHER

Item	Code
Anti-Splash Tap Washer	367939



Ballvalve Washers

BALLVALVE WASHERS IN VARIOUS SIZES AND TYPES

Size	OD (mm)	Thickness (mm)	Code
⅜"	10	3	367980
½"	13	3	367982
½" Low Pressure	13	3	367984
⅝"	16	3.5	370336
¾"	19	3	367985
¾" Low Pressure	19	3	367987
⅞"	23	3	370218
1"	25	3	367972
1¼"	32	3	367975
1½"	38	3	367978



Ballvalve Seating Washer

BALLVALVE SEATING WASHERS IN VARIOUS SIZES

- Available in either ½" or ¾"

Size	OD (mm)	ID (mm)	Thickness (mm)	Code
½"	21.94	10.99	1.5	367989
¾"	23.8	16.73	1.5	367991

Washers & Seals // Trap / Waste 05



Poly Washers

MANUFACTURED FROM LOW DENSITY POLYTHENE

Size	OD (mm)	ID (mm)	Thickness (mm)	Code
½" Pillar Tap	38	22	1.5	367430
¾" Pillar Tap	44	29	1.5	367435
1" Tank	64	34	1.5	367441
1¼" Lavatory Basin	60	34	1.5	367445
1¼" Sink	89	43	2	367449
1½" Sink	89	49	1.5	367456
1¼" Bath	71	43	1.5	367444
1½" Bath	71	49	1.5	367453



Anti-Rotational Washers

MANUFACTURED FROM PE FOAM 2mm THICK

Size	OD (mm)	ID (mm)	Code
½" Pillar Tap	38	22	367431
¾" Pillar Tap	44	29	367436



Fibre Washers

1.5mm THICK FIBRE WASHERS

- Epson Holdtite Fibre Washers. Manufactured from C.N.A.F.

Size	OD (mm)	ID (mm)	Thickness (mm)	Code
½" Pillar Tap	38	22	1.5	367432
¾" Pillar Tap	45	28	1.5	367437
1" Tank	65	35	1.5	367442
1¼" Lavatory Basin	60	42	1.5	367446
1½" Sink	83	50	1.5	367457
1¼" Sink	88.2	43.2	1.5	367450

Rubber Washers

RUBBER WASHERS IN VARIOUS SIZES

- Epson Holdtite Rubber Washers



Size	OD (mm)	ID (mm)	Thickness (mm)	Code
½" Pillar Tap	38	22	1.5	367434
¾" Pillar Tap	44	29	2	367439
1" Tank	64	34	2	367440
1¼" Lavatory Basin	60	34	3	367447
1¼" Sink	85.2	43.2	1.5	367451
1½" Sink	88	51.6	1	367458
1½" Bath	71.4	46.5	1.5	367454



Trap Inlet Sealing Washer

2mm THICK TRAP INLET SEALING WASHERS IN VARIOUS SIZES

- Available in either 1¼" or 1½"

Size	OD (mm)	ID (mm)	Thickness (mm)	Code
1¼"	38	34	2	367732
1½"	42	38	2	367733



Outlet Sealing Washer

TAPERED TRAP OUTLET SEALING WASHER

Size	Code
1¼"	367460
1½"	367461



Top of Trap Washers

3mm THICK TOP OF TRAP WASHERS IN VARIOUS SIZES

- Available in either 1¼" or 1½"

Size	OD (mm)	ID (mm)	Thickness (mm)	Code
1¼"	40	32	3	368017
1½"	45	34	3	368018



Bottle Trap Washers

BOTTLE TRAP WASHERS IN VARIOUS SIZES

- Available in either 1¼" or 1½"

Size	OD (mm)	ID (mm)	Thickness (mm)	Code
Bottle Trap 'O' Ring Seal	68	63	2.5	367720
1¼"	40	33	2	368007
1½"	47	40.07	2	368008

05 Washers & Seals // Central Heating // Service & Hose



Draw Off Tap Washer

RANGE OF RUBBER AND FIBRE DRAW OFF TAP WASHERS

- Available in a range of sizes

Type	OD (mm)	ID (mm)	Thickness (mm)	Code
Rubber	13.82	4.02	3	370337
Fibre	14.84	3.82	2.5	368033
Rubber Type B	12.18	4.25	2.2	368031
Rubber	19	5.10	4.30	368029



Circulation Pump Washer

FIBRE AND RUBBER CIRCULATION PUMP WASHERS

- Available in a range of sizes

Type	OD (mm)	ID (mm)	Thickness (mm)	Code
Rubber	44.31	31.43	3	368026
Fibre	44.31	31.74	2	368027



Immersion Heater Washer

RANGE OF WASHERS FOR IMMERSSION HEATERS

- Available in a range of sizes

Type	OD (mm)	ID (mm)	Thickness (mm)	Code
Standard (Fibre)	84	65.96	2	368047
Large (Fibre)	96	67	2.5	368048
Graphite Coated Both Sides (Fibre)	95.4	67	2.5	368049



Swivel Washer

PRESTEX '43' SWIVEL WASHERS

- Available in a range of sizes

Type	OD (mm)	ID (mm)	Thickness (mm)	Code
½" (Fibre)	18.25	15	1.75	367908
¾" (Fibre)	23.88	19.85	1.65	367913
1" (Fibre)	31.33	28.67	1.5	367907



Cap and Liner Washer

WRAS APPROVED CAP & LINER WASHER

- Available in either ½" or ¾"

Size	OD (mm)	ID (mm)	Thickness (mm)	Code
½"	18.25	14.74	1.5	367910
¾"	23.6	19.67	1.5	367915



Nylon Tap Connector Washer

NYLON TAP CONNECTOR WASHERS IN MULTIPLE SIZES

- Available in either ½" or ¾"

Size	OD (mm)	ID (mm)	Thickness (mm)	Code
½"	18.45	14.6	2	367911
¾"	23.87	19.5	2	367916

Flexible Tap Connector Washers

FLEXIBLE TAP WASHERS IN VARIOUS STYLES AND SIZES

- Available in either ½" or ¾"

Size	OD (mm)	ID (mm)	Thickness (mm)	Code
½" C.N.A.F.	18.45	11.25	1.5	367919
¾" C.N.A.F.	24.29	14.25	1.5	367922
¾" Rubber	15	7.75	2.5	367918
¾" to suit SF 19mm (¾") Rubber	21	17	2	367926
½" Graphite Coated	19.38	11	1.5	367920
¾" Graphite Coated	24.32	14	1.5	367923
½" to suit SF 13mm (½") Rubber	18	13	2	367925



Cap and Liner Washer

VARIOUS NONE WRAS CAP AND LINER WASHERS

Size	OD (mm)	ID (mm)	Thickness (mm)	Code
½"	18	15	3	368023
¾"	20	17	2.5	368024
¾"	22	17	2.5	368025
¾" Boss Washer	32	26	3	368022



Washers & Seals // Service & Hose // General // O Rings 05



Flexible Tube and Hose Washers

TUBE AND HOSE WASHERS IN VARIOUS STYLES AND SIZES

- Available in a range of sizes

Type	OD (mm)	ID (mm)	Thickness (mm)	Code
3/4" Washing Machine Hose	24	12	2	368011
3/4" Gauze Filter to suit Washing Machine Hose	24.08	16	4	368014
1/2" Shower Hose	19.35	10	2	368009
1/2" Flexible Tube	20	10	1.7	368034
3/4" Flexible Tube	25.75	15	2	368036
Bath/Shower Mixer Diverter	27.45	10	1.5	368019
3/4" x 3/8" Hot Water Bottle	19.06	9.6	2	368046



Blanking Cap Washers

1.5mm BLANKING CAP WASHERS

- Manufactured from high quality materials
- Available in a range of sizes

Type	OD (mm)	Thickness (mm)	Code
Solid Fibre Disc (small)	18.7	1.5	368053
Solid Fibre Disc (Medium)	23.39	1.5	368055
Solid Fibre Disc (Large)	31.88	1.5	368057



Red Fibre Washers

RED FIBRE WASHERS [1.5mm THICK]

OD (mm)	ID (mm)	Thickness (mm)	Code
9	6.4	1.5	368058
12.6	8.3	1.5	368059
16	10	1.5	368060
17.5	11.5	1.5	368061
19	13.5	1.5	368062
22	14.6	1.5	368063
22	17	1.5	368064



O Rings Imperial

IMPERIAL 'O' RINGS IN VARIOUS SIZES

- O Rings supplied polybagged in packs of 10
- All O Rings are manufactured from Nitrile Rubber 70° Shore A



O Rings Metric

METRIC 'O' RINGS IN VARIOUS SIZES

- O Rings supplied polybagged in packs of 10
- All O Rings are manufactured from Nitrile Rubber 70° Shore A

VISIT OUR WEBSITE FOR THE FULL PRODUCT RANGE



VISIT OUR WEBSITE FOR THE FULL PRODUCT RANGE



Pipes, Valves & Fittings

For every job, there's a precise part that saves the day. Whether you're looking for plumbing pipes, fittings, valves, or something else entirely, you'll find exactly what you need in the full TYDE range.

For live product lead times please visit our website.

Beta



In this section

01	» Brass Float Valves & Accessories	122	07	» Consumables	147
02	» Plastic Floats	128	08	» Drainage Equipment	148
03	» Compression Pipe Fittings	129	09	» Gas Products	153
	Brass Pipe Fittings	129	10	» Pipe Clips	156
	Chrome Pipe Fittings	133	11	» Plumbing Brassware & Accessories	160
	DZR Pipe Fittings	134		Radiator & Heating Products	161
	Lead Free Pipe Fittings	136		Washing Machine Accessories	166
04	» End Feed Pipe Fittings	137		Valves	167
05	» Solder Ring Pipe Fittings	141		Flexible Tap Connectors	174
06	» Threaded Pipe Fittings	144	12	» Water Hammer Arrestors	175



Visit our website

Visit our website and search our extensive range of plumbing parts, find key product information such as technical specifications, installation and troubleshooting guides and create your order all in one place using our Quote Builder function.

01 Brass Float Valves & Accessories



PART 2 SIDE ENTRY BALLVALVE

BRASS FLOAT VALVES & ACCESSORIES // SIDE ENTRY BALLVALVE

Brass Part 2 Side Entry Ballvalve

- WRAS Approved
- To BS1212 Part 2
- Can be supplied with bronze seats, brass backnuts and varying lever lengths
- Recommended float use:
 $\frac{1}{2}$ " inlet – 4 $\frac{1}{2}$ " with $\frac{5}{16}$ " Thread;
 $\frac{3}{4}$ " inlet – 6" with $\frac{5}{16}$ " Thread
- Standard Nylon Seat supplied 60°; Bronze Seats 80°

High Pressure: $\frac{1}{2}$ " Inlet – 8.3/4" x 3.1/2" Lever, 1/8" Seat

Size	Code
1 $\frac{1}{4}$ " Standard Tail, Brass Backplate	366860
1 $\frac{1}{4}$ " Standard Tail, Plastic Backplate	366878
2" Tail, Brass Backplate	366879
3" Tail, Brass Backplate	366880

High Pressure: $\frac{3}{4}$ " Inlet – 8.3/4" x 3.1/2" Lever, 1/4" Seat

1 $\frac{1}{2}$ " Standard Tail, Brass Backplate	366886
--	--------

Low Pressure: $\frac{1}{2}$ " Inlet – 8.3/4" x 3.1/2" Lever, 3/8" Seat

1 $\frac{1}{4}$ " Standard Tail, Brass Backplate	330085
2" Tail, Brass Backplate	366898
3" Tail, Brass Backplate	366899

Low Pressure: $\frac{3}{4}$ " Inlet – 8.3/4" x 3.1/2" Lever, 3/8" Seat

1 $\frac{1}{2}$ " Standard Tail, Brass Backplate	366892
--	--------

Medium Pressure: $\frac{1}{2}$ " Inlet – 8.3/4" x 3.1/2" Lever, 3/16" Seat

1 $\frac{1}{4}$ " Standard Tail, Brass Backplate	366890
--	--------



PART 2 BOTTOM ENTRY BALLVALVE

BRASS FLOAT VALVES & ACCESSORIES // BOTTOM ENTRY PART 2 BALLVALVE

Part 2 Bottom Entry Ballvalve

- Can be supplied with bronze seats, brass backnut and varying lever lengths
- Standpipe can be supplied straight or offset and in varying lengths
- To BS1212 Part 2
- 9" Height
- Available in both High and Low Pressure specification

High Pressure: $\frac{1}{2}$ " Inlet – 8.3/4" x 3.1/2" Lever, 1/8" Seat

Size	Code
1 $\frac{1}{4}$ " Standard Tail, 9" Standpipe	366883

Low Pressure: $\frac{1}{2}$ " Inlet – 8.3/4" x 3.1/2" Lever x 3/8" Seat

Size	Code
1 $\frac{1}{4}$ " Standard Tail, 9" Standpipe	366900

Brass Float Valves & Accessories 01

PART 1 SIDE ENTRY BALLVALVE

BRASS FLOAT VALVES & ACCESSORIES // PART 1 SIDE ENTRY BALLVALVE

Brass Part 1 Side Entry Ballvalve

- To BS1212 Part 1
- Available with bronze seat, brass piston, brass backnut, and varying lever lengths if required
- Recommended float use:
 $\frac{1}{2}$ " inlet – 4 $\frac{1}{2}$ " with $\frac{5}{16}$ " Thread
 $\frac{3}{4}$ " inlet – 6" with $\frac{5}{16}$ " Thread



High Pressure: $\frac{1}{2}$ " Inlet – 8.3/4" Lever with 5/16th Thread, 1/8" Seat

Size	Code
1 $\frac{1}{4}$ " Standard Tail	366802
2" Tail	366818
3" Tail	366823

Low Pressure: $\frac{1}{2}$ " Inlet – 8.3/4" Lever with 5/16th Thread, 3/8" Seat

Size	Code
1 $\frac{1}{4}$ " Standard Tail	366838
2" Tail	366847
3" Tail	366851

PART 1 – 3/4" - 2" INLETS SIDE ENTRY BALLVALVE

BRASS FLOAT VALVES & ACCESSORIES // PART 1 3/4"– 2" INLETS SIDE ENTRY BALLVALVE

Brass Part 1 Side Entry Ballvalve

- Brass float operated
- Ballvalve supplied with removable seats and brass backnuts
- To suit BS1212 Part 1



High Pressure

Inlet	Lever	Seat	Piston	Tail	Code
$\frac{3}{4}$ "	13"	$\frac{1}{4}$ "	Nylon	1 $\frac{1}{2}$ "	366901
$\frac{3}{4}$ "	13"	$\frac{3}{4}$ "	Nylon	3"	366902
1"	16"	$\frac{3}{8}$ "	Brass	1 $\frac{1}{2}$ "	366836
1 $\frac{1}{4}$ "	22"	$\frac{3}{4}$ "	Brass	1 $\frac{3}{4}$ "	366854
1 $\frac{1}{2}$ "	22"	$\frac{3}{4}$ "	Brass	1 $\frac{3}{4}$ "	366856
2"	29"	1"	Brass	2"	366858

Low Pressure

Inlet	Lever	Seat	Piston	Tail	Code
$\frac{3}{4}$ "	13"	$\frac{1}{2}$ "	Nylon	1 $\frac{1}{2}$ "	366914
$\frac{3}{4}$ "	13"	$\frac{1}{2}$ "	Nylon	3"	366915
1 $\frac{1}{4}$ "	22"	$\frac{5}{16}$ "	Brass	1 $\frac{3}{4}$ "	366855
1 $\frac{1}{2}$ "	22"	$\frac{5}{16}$ "	Brass	1 $\frac{3}{4}$ "	366857
2"	29"	1 $\frac{1}{4}$ "	Brass	2"	366859

01 Brass Float Valves & Accessories



PART 1 BOTTOM ENTRY BALLVALVE

BRASS FLOAT VALVES & ACCESSORIES // BOTTOM ENTRY PART 1 BALLVALVE

Part 1 Bottom Entry Ballvalve

- To BS1212 Part 1
- 9" Height
- Can be supplied with bronze seat, brass backnut and varying lever lengths. Standpipe can be supplied straight or offset or in varying lengths

High Pressure: 1/2" Inlet – 8.3/4" Lever, 1/8" Seat

Size	Code
1 1/4" Tail, 9" Standpipe	366832

Low Pressure: 1/2" Inlet – 8.3/4" Lever x 3/8" Seat

Size	Code
1 1/4" Tail, 9" Standpipe	366853

Drop Arm and Adaptor

ENABLES 'AIR GAP' TO BE ACHIEVED

- Enables the correct 'Air Gap' to be achieved. Available to suit all float operated piston type valves.
- Manufactured from high quality materials
- Designed to help backflow prevention from contamination into clean water supply



Size	Drop	Code
1/16" BSW Brass Drop Arm	13"	367005
1/16" BSW Brass Drop Arm	18"	367006
1/16" BSW Brass Drop Arm	18"	367007
1/16" BSW Brass Drop Arm	12"	367008
1/16" BSW Brass Drop Arm	21"	367009
1/8" BSW Brass Drop Arm	24"	367010
3/16" BSW Brass Drop Arm	24"	367011
7/16" BSW Brass Drop Arm	24"	367012
3/8" BSW Brass Drop Arm	18"	367013



Float Operated Valve

MOH FLOAT OPERATED VALVE

- Manufactured from high quality materials
- 1/16" Thread on lever

Inlet	Lever	Seat	Tail	Code
1/2"	11 3/4"	1/8"	1 1/2"	366827
3/4"	13 1/2"	1/4"	1 1/4"	366908

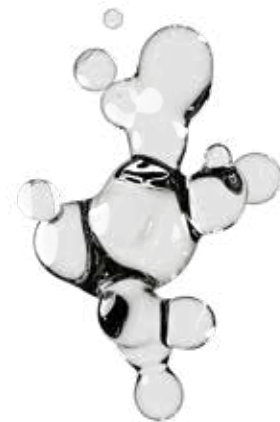

Brass Float Valves & Accessories 01



Lever Part 1

SUPPLIED WITH LOCKING NUT

- Supplied with locking nut
- Range of sizes to suit all needs
- Manufactured from high quality materials
- Do not bend

Size	Ballvalve Size	Code
8 3/4" Standard Lever	1/2"	366960
10 1/2" Lever	1/2"	366962
6" Lever	1/2"	366976
13" Standard Lever	3/4"	366973
8 3/4" Lever	3/4"	366981
6" Lever	3/4"	366984
16" Standard Lever	1"	366982
22" Standard Lever	1 1/4" & 1 1/2"	366964
29" Standard Lever	2"	366983



Lever Part 2

SUPPLIED WITH FLOAT ADJUSTER

- Supplied with Float Adjuster
- Range of sizes to suit all needs
- Manufactured from high quality materials
- Do not bend

Size	Code
8 3/4" x 3 1/2" for 1/2" Part 2 Ballvalve	366963



Brass Pistons

PART 1 BRASS PISTONS MADE TO BS1212

- Manufactured from high quality materials
- Supplied complete with washer

Size	Code
1/2" High Pressure	366989
1/2" Low Pressure	366990
3/4" High/Low Pressure	366993
1" High/Low Pressure	366991
1 1/4" & 1 1/2" High/Low Pressure	366992
2" High/Low Pressure	366994



Cotter Pins

BRASS COTTER PINS

- Suitable for linkage between ballvalve and lever
- Available in a variety of sizes to suit our range of Part 1 and 2 ballvalves

Dia	Fits	Code
1/8"	Part 2 (1/2")Ballvalve	367954
3/16"	Part 1 (1/2")Ballvalve	367956
1/4"	Part 1 (3/4 & 1") Ballvalve	367958
5/16"	Part 1 (1 1/4" & 1 1/2") Ballvalve	367960
3/8"	Part 1 (2")Ballvalve	367961



Bronze Seat

OPERATES UP TO TEMPERATURES OF 80°

- Manufactured from high quality materials
- Can be ran up to temperatures of 80°

Ballvalve x Seat x Pressure Size	Code
1/2" x 1/8" HP	366995
1/2" x 3/8" LP	366996
1/2" x 1/4" LP	366997
3/4" x 1/4" HP	366998
3/4" x 1/2" LP	366999
1" x 3/8" HP	367000
1 1/2" & 1 1/4" x 3/4" HP	367003
1 1/2" & 1 1/4" x 1 5/16" LP	367004
2" x 1" HP	367002
2" x 1 1/4" LP	367001

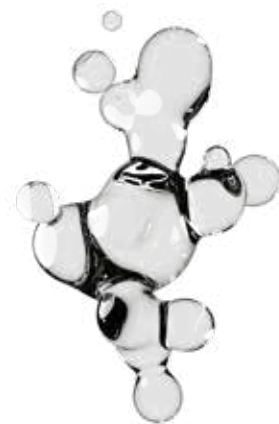

01 Brass Float Valves & Accessories



Ballvalve Seatings

½" X ¼" HIGH PRESSURE

- A wide range of pressures and sizes to suit ballvalves
- Manufactured from high-quality materials

Item	Code
Ballvalve Seatings	370219



Ballvalve Seatings

½" X ¾" LOW PRESSURE

- A wide range of pressures and sizes to suit ballvalves
- Manufactured from high-quality materials

Item	Code
Ballvalve Seatings	321754



Ballvalve Seatings

¾" X ½" HIGH PRESSURE

- A wide range of pressures and sizes to suit ballvalves
- Manufactured from high-quality materials

Item	Code
Ballvalve Seatings	321757



Ballvalve Seatings

¾" X ¼" LOW PRESSURE

- A wide range of pressures and sizes to suit ballvalves
- Manufactured from high-quality materials

Item	Code
Ballvalve Seatings	321756



Ballvalve Seatings

½" X ¾" LOW PRESSURE

- A wide range of pressures and sizes to suit ballvalves
- Manufactured from high-quality materials

Item	Code
Ballvalve Seatings	370215



Ballvalve Seatings

½" X ¼" MEDIUM PRESSURE

- A wide range of pressures and sizes to suit ballvalves
- Manufactured from high-quality materials

Item	Code
Ballvalve Seatings	321753



Ballvalve Piston

½" HIGH PRESSURE

- Manufactured from high quality materials
- Supplied complete with washer

Size	Code
Ballvalve Piston ½" HP Body	368002



Ballvalve Piston

BALLVALVE PISTON ½"/¾" - HIGH/LOW PRESSURE

- Manufactured from high quality materials
- Supplied complete with washer

Size	Code
½" LP Body	370697
¾" HP & LP Body	370696



Spigot Nut

½" SPIGOT NUT

- Manufactured from high quality materials
- ½" BSP
- Internal thread

Item	Code
Spigot Nut	370661

Brass Float Valves & Accessories 01



Equilibrium Float Valve

BRONZE BETA EQUILIBRIUM FLOAT VALVE

- Recommended Float Sizes for Beta Equilibrium Ballvalves
- Flow rate chart for Beta Equilibrium Ballvalves
- Copper floats recommended to be used with Equilibriums

Inlet	Lever	Float Thread	Code
1¼" BSP	11"	¾" x 1/16"	366952
1½" BSP	11"	¾" x 1/16"	366953
2" BSP	11"	¾"	366954
2½" BSP	19"	¾" x 1/16"	366955
3" BSP	20"	¾"	366956
4" BSP	21"	¾"	366957
6" BSP	23"	¾"	366958



Equilibrium Float Valve

EBCO EQUILIBRIUM FLOAT VALVE

- Full Flow
- Available in ½" to 4"
- BSP or Flanged inlets
- One size of seat and one size of ball float suits any working pressure up to the maximum recommended of 5.0 bar [72 psi]
- Copper floats recommended to be used with Equilibriums

Inlet	Lever	Float Size	Code
Screwed Connection			
½"	10"	4½" x 5/16"	366926
¾"	13"	6" x 5/16"	366927
1"	16"	8" x 7/16"	366928
1½"	17"	8" x 7/16"	366929
1½"	18"	10" x 9/16"	366930
2"	19"	12" x 5/8"	366931
2½"	20"	15" x 3/4"	366932
3"	21"	15" x 3/4"	366933
4"	23"	16" x 7/8"	366934

VISIT OUR WEBSITE FOR RECOMMENDED FLOAT SIZES FOR BETA EQUILIBRIUM BALLVALVES



Inlet	Lever	Float Size	Code
Flanged Connection			
¾"	13"	6" x 5/16"	366935
1"	16"	8" x 7/16"	366936
1¼"	17"	8" x 7/16"	366937
1½"	18"	10" x 9/16"	366938
2"	19"	12" x 5/8"	366939
3"	21"	15" x 3/4"	366940
4"	23"	16" x 7/8"	366941



Copper Float

SOLDERED - COLD WATER ONLY

- Soldered
- Cold water only

Size	Code
4.½" x 5/16" BSW Stud	366778
5" x 5/16" BSW Stud	366779
5.½" x 3/8" BSW Stud	366780
6" x 5/16" BSW Stud	366781
6" x 3/8" BSW Stud	366782
7" x 5/16" BSW Stud	366783
8" x 7/16" BSW Stud	366784
8" x 3/8" BSW Stud	366785
10" x 9/16" BSW Stud	366786
12" x 5/8" BSW Stud	366787
12" x 9/16" BSW Stud	366788
14" x 3/4" BSW Stud	366789
15" x 3/4" BSW Stud	366790
16" x 7/8" BSW Stud	366791



Washer Set

WASHER SET TO SUIT EBCO EQUILIBRIUM BALLVALVES

- Supplied in a range of sizes
- All the washers needed for an equilibrium valve

Size	Code
½"	366943
¾"	366944
1"	366945
1¼"	366946
1½"	366947
2"	366948
2 ½"	366950
3"	366949
4"	366951

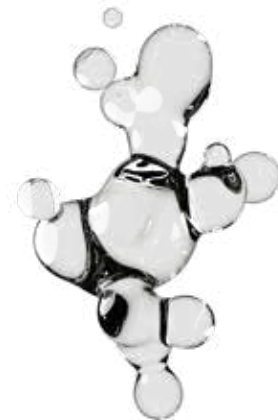

02 Plastic Floats

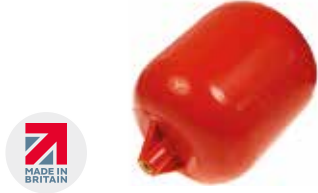

Elongated Plastic Ball Float 4 1/2"

4 1/2" [114mm] ELONGATED BALL FLOAT
• 1/16" Brass Thread

Size	Code
4 1/2" Elongated Plastic Ball Float	370210



Round Plastic Ball Float 4 1/2"

4 1/2" [114MM] ROUND BALL FLOAT
• 1/16" Brass Thread

Size	Code
4 1/2" Round Plastic Ball Float	370209



Round Plastic Ball Float 5"

5" [127mm] ROUND BALL FLOAT
• 1/16" Brass Thread

Size	Code
5" Round Plastic Ball Float	370211



Round Plastic Ball Float 6"

6" [153mm] ROUND BALL FLOAT
• 1/16" Brass Thread

Size	Code
6" Round Plastic Ball Float	370212



Round Plastic Ball Float 8"

8" [203mm] ROUND BALL FLOAT
• 1/16" Brass Thread

Size	Code
8" Round Plastic Ball Float	366794



Round Plastic Ball Float 10"

10" [254mm] ROUND BALL FLOAT
• 1/16" Brass Thread

Size	Code
10" Round Plastic Ball Float	366795

Round Plastic Ball Float 12"

12" [305mm] ROUND BALL FLOAT
• 1/8" Brass Thread

Size	Code
12" Round Plastic Ball Float	366796



*For copper floats options
please see page 127*

Compression Pipe Fittings // Brass 03



Coupler

BRASS COMPRESSION COUPLER IN VARIOUS SIZES

- Suitable for use with hot/cold water and central heating systems
- Manufactured to BSEN1254-2
- WRAS Approved

Size	Code
8mm	364595
10mm	364596
12mm	364597
15mm	364599
22mm	364601
28mm	364603
35mm	364604
42mm	364605
54mm	364606



Slip Coupler

BRASS COMPRESSION SLIP COUPLE AVAILABLE IN SIZES 15mm AND 22mm

- Suitable for use with hot/cold water and central heating systems
- Manufactured to BSEN1254-2
- WRAS Approved

Size	Code
15mm	364607
22mm	364608



Reducing Coupler

BRASS COMPRESSION REDUCING COUPLERS

- Suitable for use with hot/cold water and central heating systems
- Manufactured to BSEN1254-2
- WRAS Approved

Size	Code
10mm x 8mm	364643
15mm x 8mm	364644
15mm x 10mm	364639
15mm x 12mm	364640
22mm x 15mm	364641
28mm x 22mm	364642



FI Coupler

BRASS COMPRESSION FEMALE IRON COUPLERS

- Suitable for use with hot/cold water and central heating systems
- Manufactured to BSEN1254-2
- WRAS Approved

Size	Code
8mm x ¼"	364633
10mm x ¼"	364634
10mm x ⅜"	364635
15mm x ¼"	364636
15mm x ⅜"	364637
15mm x ½"	364624
15mm x ¾"	364626
22mm x ½"	364638
22mm x ¾"	364627
22mm x 1"	364632
28mm x 1"	364628
35mm x 1¼"	364629
42mm x 1½"	364630
54mm x 2"	364631



MI Coupler

BRASS COMPRESSION MALE IRON COUPLERS

- Suitable for use with hot/cold water and central heating systems
- Manufactured to BSEN1254-2
- WRAS Approved

Size	Code
8mm x ¼"	364618
10mm x ¼"	364619
10mm x ⅜"	364620
15mm x ¼"	364621
15mm x ⅜"	364622
15mm x ½"	364609
15mm x ¾"	364611
22mm x ½"	364623
22mm x ¾"	364612
22mm x 1"	364613
28mm x 1"	364614
35mm x 1¼"	364615
42mm x 1½"	364616
54mm x 2"	364617



Repair Coupler

BRASS COMPRESSION REPAIR COUPLER

- Suitable for use with hot/cold water and central heating systems
- Manufactured to BSEN1254-2
- WRAS Approved

Size	Code
15mm x 15mm x 82mm	364753

03 Compression Pipe Fittings // Brass



Equal Elbow

BRASS COMPRESSION EQUAL ELBOWS

- Suitable for use with hot/cold water and central heating systems
- Manufactured to BSEN1254-2
- WRAS Approved

Size	Code
8mm	364654
10mm	364653
12mm	364655
15mm	364657
22mm	364659
28mm	364661
35mm	364662
42mm	364663
54mm	364664



FI Elbow

BRASS COMPRESSION FEMALE IRON ELBOW

- Suitable for use with hot/cold water and central heating systems
- Manufactured to BSEN1254-2
- WRAS Approved

Size	Code
15mm x ½"	364676
22mm x ¾"	364678
22mm x 1"	364679
28mm x 1"	364681
35mm x 1¼"	364682
42mm x 1½"	364683
54mm x 2"	364684



MI Elbow

BRASS COMPRESSION MALE IRON ELBOW

- Suitable for use with hot/cold water and central heating systems
- Manufactured to BSEN1254-2
- WRAS Approved

Size	Code
15mm x ½"	364666
22mm x ¾"	364668
22mm x 1"	364669
28mm x 1"	364670
35mm x 1¼"	364671
42mm x 1½"	364672
54mm x 2"	364673



Reducing Elbow

BRASS COMPRESSION REDUCING ELBOW

- Suitable for use with hot/cold water and central heating systems
- Manufactured to BSEN1254-2
- WRAS Approved

Size	Code
22mm x 15mm	364665



Reducing Tees

BRASS COMPRESSION REDUCING TEES

- Suitable for use with hot/cold water and central heating systems
- Manufactured to BSEN1254-2
- WRAS Approved

Size	Code
15mm x 15mm x 22mm	364695
22mm x 15mm x 15mm	364696
22mm x 15mm x 22mm	364697
22mm x 22mm x 15mm	364698
28mm x 28mm x 15mm	364699
28mm x 28mm x 22mm	364700
28mm x 22mm x 22mm	364701



Equal Tees

BRASS COMPRESSION EQUAL TEES

- Suitable for use with hot/cold water and central heating systems
- Manufactured to BSEN1254-2
- WRAS Approved

Size	Code
8mm	364694
10mm	364685
15mm	364686
22mm	364688
28mm	364690
35mm	364691
42mm	364692
54mm	364693

Compression Pipe Fittings // Brass 03



Reducing FI Tees

BRASS COMPRESSION FEMALE IRON REDUCING TEES

- Suitable for use with hot/cold water and central heating systems
- Manufactured to BSEN1254-2
- WRAS Approved

Size	Code
15mm x 15mm x ½"	364702
22mm x 22mm x ½"	364703



Tap Connector

BRASS COMPRESSION TAP CONNECTORS

- Available both angled and straight and in sizes from 15mm to 22mm
- Manufactured to BSEN1254-2
- WRAS Approved

Size	Code
15mm x ½" Bent	364740
15mm x ½" Straight	364741
22mm x ¾" Straight	364743



Tank Connector

BRASS COMPRESSION TANK CONNECTORS

- Suitable for use with hot/cold water and central heating systems
- Manufactured to BSEN1254-2
- WRAS Approved

Size	Code
15mm	364744
22mm	364745
28mm	364746
35mm	364747
42mm	364748
54mm	364749



Stop Ends

BRASS COMPRESSION STOP ENDS

- Suitable for use with hot/cold water and central heating systems
- Manufactured to BSEN1254-2
- WRAS Approved

Size	Code
8mm	364738
10mm	364739
15mm	364731
22mm	364733
28mm	364734
35mm	364735
42mm	364736
54mm	364737



Wallplate Elbow

BRASS COMPRESSION WALLPLATE ELBOW

- Suitable for use with hot/cold water and central heating systems
- Manufactured to BSEN1254-2
- WRAS Approved

Size	Code
15mm x ½"	364750
22mm x ¾"	364752



3 Parts Reducers

3 PARTS BRASS REDUCERS. VARIOUS SIZES.

- Suitable for use with hot/cold water and central heating systems
- Manufactured to BSEN1254-2
- WRAS Approved

Size	Code
10mm x 8mm	364648
15mm x 8mm	364649
15mm x 10mm	364650
15mm x 12mm	364651
22mm x 15mm	364645
28mm x 22mm	364646

03 Compression Pipe Fittings // Brass



1 Part Reducers

1 PART BRASS REDUCERS. MULTIPLE SIZES.

- Suitable for use with hot/cold water and central heating systems
- Manufactured to BSEN1254-2
- WRAS Approved

Size	Code
22mm x 15mm	364652
28mm x 15mm	364647



Copper Olives

COPPER OLIVES IN VARIOUS SIZES

- Suitable for use with hot/cold water and central heating systems
- Manufactured to BSEN1254-2
- WRAS Approved

Size	Code
8mm	364705
10mm	364707
12mm	364709
15mm	364711
20mm	364723
22mm	364713
25mm	364721
28mm	364715
35mm	364717
42mm	364719
54mm	364724
¾" Imperial	364726



Brass Olives

BRASS OLIVES IN VARIOUS SIZES

- Suitable for use with hot/cold water and central heating systems
- Manufactured to BSEN1254-2
- WRAS Approved

Size	Code
8mm	364704
10mm	364706
12mm	364708
15mm	364710
20mm	364722
22mm	364712
25mm	364720
28mm	364714
35mm	364716
42mm	364718
¾" Imperial	364725



Lead Lines

SUPPLIED WITH COMPRESSION OLIVE, NUT AND SEAT

- Suitable for use with hot/cold water and central heating systems
- Manufactured to BSEN1254-2
- WRAS Approved

Size	Code
½" x 6lb x 15mm	364175
½" x 7lb x 15mm	364176
½" x 7lb x 20mm	364177
½" x 7lb x 25mm	364178
¾" x 11lb x 25mm	364179
¾" x 9lb x 22mm	364180
¾" x 5lb x 15mm	364181



Compression Nut

BRASS COMPRESSION NUT

- Suitable for use with hot/cold water and central heating systems
- Manufactured to BSEN1254-2
- WRAS Approved

Size	Code
15mm Brass	364727
22mm Brass	364729



Compression Pipe Fittings // Chrome 03



FI Coupler

CHROME PLATED COMPRESSION FEMALE IRON COUPLER

- Suitable for use with hot/cold water and central heating systems
- Manufactured to BSEN1254-2

Size	Code
15mm x 1/2"	364625



MI Coupler

CHROME PLATED COMPRESSION MALE IRON COUPLER

- Suitable for use with hot/cold water and central heating systems
- Manufactured to BSEN1254-2

Size	Code
15mm x 1/2"	364610



Compression Coupler

CHROME PLATED COMPRESSION COUPLER

- Suitable for use with hot/cold water and central heating systems
- Manufactured to BSEN1254-2

Size	Code
12mm	364598
15mm	364600
22mm	364602



MI Elbow

CHROME PLATED COMPRESSION MALE IRON ELBOW

- Suitable for use with hot/cold water and central heating systems
- Manufactured to BSEN1254-2

Size	Code
15mm x 1/2"	364667



FI Elbow

CHROME PLATED COMPRESSION FEMALE IRON ELBOW

- Suitable for use with hot/cold water and central heating systems
- Manufactured to BSEN1254-2

Size	Code
15mm x 1/2"	364677
22mm x 1"	364680



Equal Elbow

CHROME PLATED COMPRESSION EQUAL ELBOW

- Suitable for use with hot/cold water and central heating systems
- Manufactured to BSEN1254-2

Size	Code
12mm	364656
15mm	364658
22mm	364660



Equal Tees

CHROME PLATED EQUAL TEE

- Suitable for use with hot/cold water and central heating systems
- Manufactured to BSEN1254-2

Size	Code
15mm	364687
22mm	364689



Stop End

CHROME PLATED STOP END

- Suitable for use with hot/cold water and central heating systems
- Manufactured to BSEN1254-2

Size	Code
15mm	364732



Wallplate Elbow

CHROME PLATED WALLPLATE ELBOW

- Suitable for use with hot/cold water and central heating systems
- Manufactured to BSEN1254-2

Size	Code
15mm x 1/2"	364751



Compression Nuts

CHROME PLATED COMPRESSION NUTS

- Suitable for use with hot/cold water and central heating systems
- Manufactured to BSEN1254-1

Size	Code
15mm	364728
22mm	364730



03 Compression Pipe Fittings // DZR



DZR Coupler

DZR COMPRESSION COUPLER IN VARIOUS SIZES

- Suitable for use with hot/cold water and central heating systems
- Manufactured to BSEN1254-2
- WRAS Approved
- DZR

Size	Code
15mm	364754
22mm	364755
28mm	364756



DZR MI Coupler

DZR COMPRESSION MALE IRON COUPLER IN VARIOUS SIZES

- Suitable for use with hot/cold water and central heating systems
- Manufactured to BSEN1254-2
- WRAS Approved
- DZR

Size	Code
15mm x 1/2"	364757
22mm x 3/4"	364758
28mm x 1"	364759



DZR FI Coupler

DZR COMPRESSION FEMALE IRON COUPLER IN VARIOUS SIZES

- Suitable for use with hot/cold water and central heating systems
- Manufactured to BSEN1254-2
- WRAS Approved
- DZR

Size	Code
15mm x 1/2"	364760
22mm x 3/4"	364761
28mm x 1"	364762



DZR Equal Elbow

DZR COMPRESSION EQUAL ELBOW IN VARIOUS SIZES

- Suitable for use with hot/cold water and central heating systems
- Manufactured to BSEN1254-2
- WRAS Approved
- DZR

Size	Code
15mm	364763
22mm	364764
28mm	364765



DZR MI Elbow

DZR COMPRESSION MALE IRON ELBOW IN VARIOUS SIZES

- Suitable for use with hot/cold water and central heating systems
- Manufactured to BSEN1254-2
- WRAS Approved
- DZR

Size	Code
15mm x 1/2"	364767
22mm x 3/4"	364768
28mm x 1"	364769



DZR FI Elbow

DZR COMPRESSION FEMALE IRON ELBOW IN VARIOUS SIZES

- Suitable for use with hot/cold water and central heating systems
- Manufactured to BSEN1254-2
- WRAS Approved
- DZR

Size	Code
15mm x 1/2"	364770
22mm x 3/4"	364771
28mm x 1"	364772



DZR Equal Tees

DZR COMPRESSION EQUAL TEES

- Suitable for use with hot/cold water and central heating systems
- Manufactured to BSEN1254-2
- WRAS Approved
- DZR

Size	Code
15mm	364773
22mm	364774
28mm	364775



DZR Reducing Tees

DZR COMPRESSION REDUCING TEES

- Suitable for use with hot/cold water and central heating systems
- Manufactured to BSEN1254-2
- WRAS Approved
- DZR

Size	Code
22mm x 22mm x 15mm	364776



DZR Reducing FI Tees

DZR COMPRESSION FEMALE IRON TEES

- Suitable for use with hot/cold water and central heating systems
- Manufactured to BSEN1254-2
- WRAS Approved
- DZR

Size	Code
15mm x 15mm x 1/2"	364777

Compression Pipe Fittings // DZR 03



DZR Stop End

DZR COMPRESSION STOP END

- Suitable for use with hot/cold water and central heating systems
- Manufactured to BSEN1254-2
- WRAS Approved

Size	Code
15mm	364778
22mm	364779
28mm	364780



DZR Tap Connector

DZR COMPRESSION TAP CONNECTOR

- Suitable for use with hot/cold water and central heating systems
- Manufactured to BSEN1254-2
- WRAS Approved

Size	Code
15mm x ½" Bent	364781
15mm x ½" Straight	364782



DZR Wallplate Elbow

DZR COMPRESSION WALLPLATE ELBOW

- Suitable for use with hot/cold water and central heating systems
- Manufactured to BSEN1254-2
- WRAS Approved

Size	Code
15mm x ½"	364786



DZR Tank Connector

DZR COMPRESSION TANK CONNECTORS

- Suitable for use with hot/cold water and central heating systems
- Manufactured to BSEN1254-2
- WRAS Approved

Size	Code
15mm	364783
22mm	364784
28mm	364785

03 Compression Pipe Fittings // Lead Free



Lead Free Coupler

LEAD FREE COMPRESSION COUPLER

- Suitable for use with hot/cold water and central heating systems
- Manufactured to BSEN1254-2
- Lead Free

Size	Code
15mm	364787
22mm	364788
28mm	364789



Lead Free MI Coupler

LEAD FREE MALE IRON COMPRESSION COUPLER

- Suitable for use with hot/cold water and central heating systems
- Manufactured to BSEN1254-2
- Lead Free

Size	Code
15mm x 1/2"	364790
22mm x 3/4"	364791



Lead Free FI Coupler

LEAD FREE FEMALE IRON COMPRESSION COUPLER

- Suitable for use with hot/cold water and central heating systems
- Manufactured to BSEN1254-2
- Lead Free

Size	Code
15mm x 1/2"	364792
22mm x 3/4"	364793



Lead Free Reducing Coupler

LEAD FREE COMPRESSION REDUCING COUPLER

- Suitable for use with hot/cold water and central heating systems
- Manufactured to BSEN1254-2
- Lead Free

Size	Code
22mm x 15mm	364794



Lead Free Elbow

LEAD FREE COMPRESSION EQUAL ELBOW

- Suitable for use with hot/cold water and central heating systems
- Manufactured to BSEN1254-2
- Lead Free

Size	Code
15mm	364795
22mm	364796
28mm	364797



Lead Free Equal Tees

LEAD FREE COMPRESSION EQUAL TEE

- Suitable for use with hot/cold water and central heating systems
- Manufactured to BSEN1254-2
- Lead Free

Size	Code
15mm	364798
22mm	364799



Lead Free Reducing Tees

LEAD FREE COMPRESSION REDUCING TEE

- Suitable for use with hot/cold water and central heating systems
- Manufactured to BSEN1254-1
- Lead Free

Size	Code
22mm x 22mm x 15mm	364800



Lead Free Stop End

LEAD FREE COMPRESSION STOP END

- Suitable for use with hot/cold water and central heating systems
- Manufactured to BSEN1254-2
- Lead Free

Size	Code
15mm	364801
22mm	364802



Lead Free Isolating Valve

LEAD FREE ISOLATING VALVE FULL BORE SLOTTED

- Lead Free
- Manufactured to BSEN1254-2
- 15mm Isolating Valve Full Bore Slotted

Size	Code
15mm	364205

End Feed Pipe Fittings 04



Coupler

END FEED COPPER COUPLER

- Suitable for use with hot/cold water and central heating systems
- Manufactured to BSEN1254-1

Size	Code
8mm	364290
10mm	364291
12mm	364292
15mm	364293
22mm	364295
28mm	364297
35mm	364298
42mm	364299
54mm	364300
67mm	364301
76mm	364302
108mm	364303



Slip Coupler

END FEED COPPER SLIP COUPLER

- Suitable for use with hot/cold water and central heating systems
- Manufactured to BSEN1254-1

Size	Code
15mm	364304
22mm	364305



Long Tail Fitting Reducer

END FEED COPPER LONG TAIL FITTING REDUCER

- Suitable for use with hot/cold water and central heating systems
- Manufactured to BSEN1254-1

Size	Code
15mm x 8mm	364457
15mm x 10mm	364458
22mm x 15mm	364459



FI Coupler

END FEED FEMALE IRON COUPLER

- Suitable for use with hot/cold water and central heating systems
- Manufactured to BSEN1254-1

Size	Code
15mm x ½"	364306
22mm x ¾"	364307
28mm x 1"	364308



Reducing Coupler

END FEED COPPER REDUCING COUPLER

- Suitable for use with hot/cold water and central heating systems
- Manufactured to BSEN1254-1

Size	Code
15mm x 8mm	364313
15mm x 10mm	364314
22mm x 15mm	364315
28mm x 15mm	364316
28mm x 22mm	364317
35mm x 15mm	364323
35mm x 22mm	364318
42mm x 28mm	364319
42mm x 35mm	364320
54mm x 35mm	364321
54mm x 42mm	364322



Fitting Reducer

END FEED COPPER FITTING REDUCER

- Suitable for use with hot/cold water and central heating systems
- Manufactured to BSEN1254-1

Size	Code
10mm x 8mm	364412
15mm x 8mm	364413
15mm x 10mm	364414
15mm x 12mm	364415
22mm x 15mm	364416
28mm x 15mm	364418
28mm x 22mm	364419
35mm x 15mm	370820
35mm x 22mm	364420
35mm x 28mm	364421
42mm x 15mm	364422
42mm x 22mm	364423
42mm x 28mm	364424
42mm x 35mm	364425
54mm x 15mm	364426
54mm x 22mm	364427
54mm x 28mm	364428
54mm x 35mm	364429
54mm x 42mm	364430



MI Coupler

END FEED MALE IRON COUPLER

- Suitable for use with hot/cold water and central heating systems
- Manufactured to BSEN1254-1

Size	Code
15mm x ¾"	364310
15mm x ½"	364309
22mm x ¾"	364311
28mm x 1"	364312

Metric to Imperial Coupler

END FEED COPPER METRIC TO IMPERIAL COUPLER

- Suitable for use with hot/cold water and central heating systems
- Manufactured to BSEN1254-1

Size	Code
15mm x ½"	364460
22mm x ¾"	364461
28mm x 1"	364462
35mm x 1½"	364463



04 End Feed Pipe Fittings



Equal Elbow END FEED COPPER EQUAL ELBOW

- Suitable for use with hot/cold water and central heating systems
- Manufactured to BSEN1254-1

Size	Code
8mm	364363
10mm	364364
12mm	364365
15mm	364366
22mm	364368
28mm	364370
35mm	364371
42mm	364372
54mm	364373
67mm	364374
76mm	364375
108mm	364376



90° Long Tail Street Elbow END FEED COPPER 90° LONG TAIL STREET ELBOW

- Suitable for use with hot/cold water and central heating systems
- Manufactured to BSEN1254-1

Size	Code
15mm	364435
22mm	364436
28mm	364437



MI Elbow END FEED MALE IRON ELBOW

- Suitable for use with hot/cold water and central heating systems
- Manufactured to BSEN1254-1

Size	Code
15mm x ½"	364389
22mm x ¾"	364390
28mm x 1"	364391



45° Elbow END FEED COPPER 45° OBTUSE ELBOW

- Suitable for use with hot/cold water and central heating systems
- Manufactured to BSEN1254-1

Size	Code
15mm	364377
22mm	364378
28mm	364379
35mm	364380
42mm	364381
54mm	364382



FI Elbow END FEED FEMALE IRON ELBOW

- Suitable for use with hot/cold water and central heating systems
- Manufactured to BSEN1254-1

Size	Code
15mm x ½"	364386
22mm x ¾"	364387
28mm x 1"	364388



90° Street Elbow END FEED COPPER 90° STREET ELBOW

- Suitable for use with hot/cold water and central heating systems
- Manufactured to BSEN1254-1

Size	Code
10mm	364431
15mm	364432
22mm	364433
28mm	364434



45° Obtuse Street Elbow END FEED COPPER 45° OBTUSE STREET ELBOW

- Suitable for use with hot/cold water and central heating systems
- Manufactured to BSEN1254-1

Size	Code
15mm	364383
22mm	364384
28mm	364385



FI Reducing Tees END FEED FEMALE IRON REDUCING TEE

- Suitable for use with hot/cold water and central heating systems
- Manufactured to BSEN1254-1

Size	Code
15mm x 15mm x ½"	364406
22mm x 22mm x ½"	364407

End Feed Pipe Fittings 04



Equal Tees END FEED COPPER EQUAL TEE

- Suitable for use with hot/cold water and central heating systems
- Manufactured to BSEN1254-1

Size	Code
8mm	364401
10mm	364392
12mm	364402
15mm	364393
22mm	364395
28mm	364397
35mm	364398
42mm	364399
54mm	364400
67mm	364403
76mm	364404
108mm	364405



Reducing Tees END FEED COPPER REDUCING TEE

- Suitable for use with hot/cold water and central heating systems
- Manufactured to BSEN1254-1

Size	Code
10mm x 10mm x 15mm	364324
15mm x 10mm x 10mm	364325
15mm x 10mm x 15mm	364326
15mm x 15mm x 8mm	364327
15mm x 15mm x 10mm	364328
15mm x 15mm x 22mm	364329
22mm x 15mm x 15mm	364330
22mm x 15mm x 22mm	364331
22mm x 22mm x 10mm	364332
22mm x 22mm x 15mm	364333
22mm x 22mm x 28mm	364335
28mm x 15mm x 15mm	364336

Size	Code
28mm x 15mm x 28mm	364337
28mm x 22mm x 15mm	364338
28mm x 22mm x 22mm	364339
28mm x 22mm x 28mm	370683
28mm x 28mm x 15mm	364340
28mm x 28mm x 22mm	364341
28mm x 28mm x 35mm	364342
35mm x 22mm x 22mm	364343
35mm x 22mm x 35mm	364344
35mm x 28mm x 22mm	364345
35mm x 28mm x 35mm	364346
35mm x 35mm x 15mm	364347
35mm x 35mm x 22mm	364348
35mm x 35mm x 28mm	364349
42mm x 28mm x 42mm	364350
42mm x 35mm x 35mm	364351
42mm x 35mm x 42mm	364352
42mm x 42mm x 15mm	364353
42mm x 42mm x 22mm	364354
42mm x 42mm x 28mm	364355
42mm x 42mm x 35mm	364356
54mm x 42mm x 54mm	364357
54mm x 54mm x 15mm	364358
54mm x 54mm x 22mm	364359
54mm x 54mm x 28mm	364360
54mm x 54mm x 35mm	364361
54mm x 54mm x 42mm	364362



Feed Stop End END FEED COPPER STOP END

- Suitable for use with hot/cold water and central heating systems
- Manufactured to BSEN1254-2

Size	Code
8mm	364438
10mm	364439
15mm	364440
22mm	364442
28mm	364444
35mm	364445
42mm	364446
54mm	364447



Tap Connector END FEED TAP CONNECTOR STRAIGHT/BENT

- Suitable for use with hot/cold water and central heating systems
- Manufactured to BSEN1254-1
- Straight and Bent options available

Type	Size	Code
Straight	15mm x 1/2"	364454
Straight	15mm x 3/4"	364455
Straight	22mm x 3/4"	364456
Bent	15mm x 1/2"	364451
Bent	15mm x 3/4"	364452
Bent	22mm x 3/4"	364453



Cylinder Union END FEED CYLINDER UNION - STRAIGHT/BENT

- Suitable for use with hot/cold water and central heating systems
- Manufactured to BSEN1254-1

Type	Size	Code
Bent	22mm x 1"	364448
Bent	28mm x 1"	370821
Straight	22mm x 3/4"	370822
Straight	22mm x 1"	364449
Straight	28mm x 1"	364450

04 End Feed Pipe Fittings



End Feed Crossover

END FEED COPPER FULL AND PART CROSSOVER

- Suitable for use with hot/cold water and central heating systems
- Manufactured to BSEN1254-1
- Full and Part Crossover Available

Type	Size	Code
Full Crossover	15mm	364408
Full Crossover	22mm	364409
Part Crossover	15mm	364410
Part Crossover	22mm	364411



Wallplate Connector

END FEED BRASS WALLPLATE ELBOW CONNECTOR

- Suitable for use with hot/cold water and central heating systems
- Manufactured to BSEN1254-1

Size	Code
15mm x 1/2" Wallplate Elbow	364464
15mm x 1/2" Angled Wallplate Elbow Angled	364465
15mm x 1/2" Wallplate Connector Straight	364466



Solder Ring Pipe Fittings 05



Coupler SOLDER RING COPPER COUPLER

- Suitable for use with hot/cold water and central heating systems
- Manufactured to BSEN1254-1

Item	Code
8mm	364468
10mm	364469
15mm	364470
22mm	364471
28mm	364472
35mm	364473
42mm	364474
54mm	364475



FI Coupler SOLDER RING FEMALE IRON COUPLER

- Suitable for use with hot/cold water and central heating systems
- Manufactured to BSEN1254-21

Size	Code
15mm x 1/2"	364478
22mm x 3/4"	364480
28mm x 1"	364481
15mm x 3/4"	364479



MI Coupler SOLDER RING MALE IRON COUPLER

- Suitable for use with hot/cold water and central heating systems
- Manufactured to BSEN1254-1

Size	Code
15mm x 1/2"	364482
22mm x 3/4"	364484
28mm x 1"	364485
15mm x 3/4"	364483



Slip Coupler SOLDER RING COPPER SLIP COUPLER

- Suitable for use with hot/cold water and central heating systems
- Manufactured to BSEN1254-1

Size	Code
15mm	364476
22mm	364477



Reducing Coupler SOLDER RING COPPER REDUCING COUPLER

- Suitable for use with hot/cold water and central heating systems
- Manufactured to BSEN1254-1

Size	Code
15mm x 8mm	364486
15mm x 10mm	364487
22mm x 15mm	364488
28mm x 15mm	364489
28mm x 22mm	364490
35mm x 22mm	364491

Size	Code
35mm x 28mm	364492
42mm x 22mm	364493
42mm x 28mm	364494
42mm x 35mm	364495
54mm x 35mm	364496
54mm x 42mm	364497



Metric to Imperial Coupler SOLDER RING COPPER METRIC TO IMPERIAL COUPLER

- Suitable for use with hot/cold water and central heating systems
- Manufactured to BSEN1254-1

Size	Code
15mm x 1/2"	364591
22mm x 3/4"	364592
28mm x 1"	364593

Equal Elbow SOLDER RING COPPER EQUAL ELBOW

- Suitable for use with hot/cold water and central heating systems
- Manufactured to BSEN1254-1

Size	Code
8mm	364531
10mm	364524
15mm	364525
22mm	364526
28mm	364527
35mm	364528
42mm	364529
54mm	364530



05 Solder Ring Pipe Fittings



90° Street Elbow

SOLDER RING COPPER STREET ELBOW

- Suitable for use with hot/cold water and central heating systems
- Manufactured to BSEN1254-1

Size	Code
15mm	364574
22mm	364575
28mm	364576



90° Long Tail Street Elbow

SOLDER RING COPPER LONG TAIL STREET ELBOW

- Suitable for use with hot/cold water and central heating systems
- Manufactured to BSEN1254-1

Size	Code
15mm	364571
22mm	364572
28mm	364573



FI Elbow

SOLDER RING FEMALE IRON ELBOW

- Suitable for use with hot/cold water and central heating systems
- Manufactured to BSEN1254-1

Size	Code
15mm x ½"	364541
22mm x ¾"	364542



MI Elbow

SOLDER RING MALE IRON ELBOW

- Suitable for use with hot/cold water and central heating systems
- Manufactured to BSEN1254-1

Size	Code
15mm x ½"	364543
22mm x ¾"	364544



45° Obtuse Elbow

SOLDER RING COPPER 45° OBTUSE ELBOW

- Suitable for use with hot/cold water and central heating systems
- Manufactured to BSEN1254-1

Size	Code
15mm	364532
22mm	364533
28mm	364534
35mm	364535
42mm	364536
54mm	364537



45° Street Elbow

SOLDER RING 45° COPPER OBTUSE STREET ELBOW

- Suitable for use with hot/cold water and central heating systems
- Manufactured to BSEN1254-1

Size	Code
15mm	364538
22mm	364539
28mm	364540



Reducing Tees

SOLDER RING COPPER REDUCING TEES

- Suitable for use with hot/cold water and central heating systems
- Manufactured to BSEN1254-1

Size	Code
15mm x 15mm x 22mm	364498
22mm x 15mm x 15mm	364499
22mm x 15mm x 22mm	364500
22mm x 22mm x 15mm	364501
22mm x 22mm x 28mm	364502
28mm x 15mm x 15mm	364503
28mm x 15mm x 22mm	364504
28mm x 15mm x 28mm	364505
28mm x 22mm x 15mm	364506
28mm x 22mm x 22mm	364507
28mm x 22mm x 28mm	364508
28mm x 28mm x 15mm	364509
28mm x 28mm x 22mm	364510

Size	Code
35mm x 22mm x 22mm	364511
35mm x 35mm x 15mm	364512
35mm x 35mm x 22mm	364513
35mm x 35mm x 28mm	364514
42mm x 42mm x 15mm	364515
42mm x 42mm x 22mm	364516
42mm x 42mm x 28mm	364517
42mm x 42mm x 35mm	364518
54mm x 54mm x 15mm	364519
54mm x 54mm x 22mm	364520
54mm x 54mm x 28mm	364521
54mm x 54mm x 35mm	364522
54mm x 54mm x 42mm	364523

Solder Ring Pipe Fittings 05



Equal Tees

SOLDER RING COPPER EQUAL TEES

- Suitable for use with hot/cold water and central heating systems
- Manufactured to BSEN1254-1

Size	Code
8mm	364552
10mm	364545
15mm	364546
22mm	364547
28mm	364548
35mm	364549
42mm	364550
54mm	364551



Fitting Reducer

SOLDER RING COPPER FITTING REDUCER

- Suitable for use with hot/cold water and central heating systems
- Manufactured to BSEN1254-1

Size	Code
10mm x 8mm	364553
15mm x 8mm	364554
15mm x 10mm	364555
22mm x 15mm	364556

Size	Code
28mm x 15mm	364557
28mm x 22mm	364558
35mm x 15mm	364559
35mm x 22mm	364560
35mm x 28mm	364561
42mm x 15mm	364562
42mm x 22mm	364563
42mm x 28mm	364564
42mm x 35mm	364565
54mm x 15mm	364566
54mm x 22mm	364567
54mm x 28mm	364568
54mm x 35mm	364569
54mm x 42mm	364570



Long Tail Fitting Reducer

SOLDER RING COPPER LONG TAIL FITTING REDUCER

- Suitable for use with hot/cold water and central heating systems
- Manufactured to BSEN1254-1

Size	Code
15mm x 10mm	364590



Stop End

SOLDER RING COPPER STOP END

- Suitable for use with hot/cold water and central heating systems
- Manufactured to BSEN1254-1

Size	Code
8mm	364583
10mm	364584
15mm	364577
22mm	364578
28mm	364579
35mm	364580
42mm	364581
54mm	364582



Bent Tap Connector

SOLDER RING COPPER BENT TAP CONNECTOR

- Suitable for use with hot/cold water and central heating systems
- Manufactured to BSEN1254-1

Size	Code
15mm x 1/2"	364585
22mm x 3/4"	364586



Straight Tap Connector

SOLDER RING COPPER STRAIGHT TAP CONNECTOR

- Suitable for use with hot/cold water and central heating systems
- Manufactured to BSEN1254-1

Size	Code
15mm x 1/2"	364587
15mm x 3/4"	364588
22mm x 3/4"	364589



Wallplate Connector

BRASS SOLDER RING WALLPLATE CONNECTOR

- Suitable for use with hot/cold water and central heating systems
- Manufactured to BSEN1254-1

Size	Code
15mm x 1/2"	364594

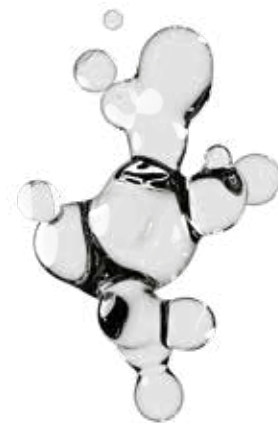

06 Threaded Pipe Fittings



Hex Bushes

BRASS AND CHROME PLATED HEX BUSHES

- Available in Brass and Chrome Plated Finish
- Available in various sizes

Size	Finish	Code
¼" x ¼"	Brass	369027
⅜" x ¼"	Brass	369028
⅝" x ⅜"	Brass	369029
½" x ⅜"	Brass	369030
½" x ½"	Brass	369031
½" x ¾"	Brass	369032
¾" x ½"	Brass	369033
¾" x ⅝"	Brass	369034
¾" x ¾"	Brass	369035
¾" x 1"	Brass	369037
¾" x 1½"	Brass	369038
1" x ¾"	Brass	369039
1" x 1"	Brass	369040
1¼" x 1"	Brass	369041

Size	Finish	Code
1¼" x ¾"	Brass	369042
1¼" x 1"	Brass	369043
1½" x 1¼"	Brass	369044
1½" x 1"	Brass	369045
1½" x ¾"	Brass	369046
1½" x ½"	Brass	369047
2" x 1½"	Brass	369048
2" x 1¼"	Brass	369049
2" x 1"	Brass	369050
2" x ¾"	Brass	369051
2" x ½"	Brass	369052
4" x 3"	Brass	369053
¾" x ½"	Chrome Plated	369036



Hex Nipples

BRASS HEX NIPPLES

Size	Code
⅛"	369127
¼"	369128
⅜"	369129
½"	369130
¾"	369131
1"	369132
1¼"	369133
1½"	369134
2"	369135



Running Nipples

BRASS RUNNING NIPPLE

Size	Code
⅛"	369150
¼"	369151
⅜"	369152
½"	369153
¾"	369154
1"	369155



Barrel Nipples

BRASS BARREL NIPPLE

Size	Code
⅛"	369073
¼"	369074
⅜"	369075
½"	369076
¾"	369077
1"	369078
1¼"	369079
1½"	369082
1" x 3"	369080
1" x 4"	369081
2"	369083



Flanged Plug

BRASS FLANGED PLUG

Size	Code
¼"	369106
½"	369098
¾"	369099
1"	369100
1¼"	369101
1"	369102
1¼"	369103
1½"	369105
2"	369104



Hex Plug

BRASS HEX PLUG

Size	Code
⅝"	369136
1¼"	369137
1½"	369138
2"	369139



Blanking Cap

BLANK CAP. VARIOUS SIZES

Size	Code
⅛"	369064
¼"	369054
⅜"	369055
½"	369056
¾"	369058
1"	369060
1¼"	369061
1½"	369062
2"	369063

Threaded Pipe Fittings 06



Chrome Blank Cap

CHROME PLATED BLANK CAP. VARIOUS SIZES.

Size	Code
1/2"	369057
3/4"	369059



Backnut

BRASS BACKNUT

Size	Code
1/4"	369084
3/8"	369085
1/2"	369086
1/2" BS - Large Flange	369087
3/4"	369088
3/4" BS - Large Flange	369089
1"	369090
1 1/4"	369091
1 1/2"	369093
2"	369094
2 1/4"	369095



Socket

BRASS SOCKET

Size	Code
1/8"	369156
1/4"	369157
3/8"	369158
1/2"	369159
3/4"	369160
1"	369161
1 1/4"	369162
1 1/2"	369163
2"	369164



Taper Plug

BRASS TAPER PLUG

Size	Code
3/8"	369168
1/2"	369169
3/4"	369170
1 1/4"	369171



Tee

BRASS THREADED FEMALE EQUAL TEES

Size	Code
1/4"	369165
3/8"	370649
1/2"	369166
3/4"	369167



Hose Tail

BRASS THREADED HOSE TAIL

Size	Code
1/4" x 1/4"	369140
3/8" x 3/8"	369141
1/2" x 1/2"	369142
3/4" x 3/4"	369143
1" x 1"	369145
1 1/4" x 1 1/4"	369146
1 1/2" x 1 1/2"	369147
2" x 2"	369148



Tap Extension

BRASS THREADED TAP EXTENSION

Size	Code
1/2"	364222
3/4"	364223



Blanking Disk

BRASS BLANKING DISK

Size	Code
15mm	369065
22mm	369066



Manifold

BRASS MANIFOLD

Size	Code
22mm x 8mm x 2	369067
22mm x 8mm x 3	369068
22mm x 8mm x 4	369069
22mm x 10mm x 2	369070
22mm x 10mm x 3	369071
22mm x 10mm x 4	369072

06 Threaded Pipe Fittings



Female Geka Fitting
FEMALE GEKA FITTING

Size	Code
½"	369107
¾"	369109
1"	369111



Tail Geka Fitting
HOSE TAIL GEKA FITTING

Size	Code
½"	369119
¾"	369121
1"	369123



Male Geka Fitting
MALE GEKA FITTING

Size	Code
½"	369113
¾"	369115
1"	369117



Geka Washer
WASHER TO SUIT GEKA FITTINGS

Item	Code
Geka Washer	369125



Consumables 07



PTFE Tape
PTFE THREAD SEAL TAPE

Item	Code
PTFE Tape	364215



PTFE Gas Tape
GAS PTFE THREAD SEAL TAPE

Item	Code
PTFE Gas Tape	364216



Jointing Compound
BOSS JOINTING COMPOUND

- Suitable for use with threaded products that require a watertight seal
- Manufactured from high quality materials

Type	Code
400gm Green	364212
400gm White	364213
400gm Gastite	364214



Flux
LA-CO REGULAR FLUX

- Suitable for use with any copper pipe systems
- Manufactured from high quality materials

Type	Code
2oz LA-CO Regular Flux	364208
4oz LA-CO Regular Flux	364209
1lb LA-CO Regular Flux	364207



Solder
LEADED SOLDER REEL

- 500g

Item	Code
Solder	364211



Lead Free Solder
LEAD FREE SOLDER REEL

- 500g

Item	Code
Lead Free Solder	329881



Small Pipe Cutter
SMALL PIPE CUTTER. 3mm - 22mm

- 3mm - 22mm Pipe Cutter

Item	Code
Small Pipe Cutter	363989



08 Drainage Equipment



Set Contents	Fitting	Code
No tools	Universal	363815
c/w Plunger and Double Worm	Universal	363785
c/w Plunger, Double Worm and Drop Scraper	Universal	363799
c/w Plunger, Double Worm, Drop Scraper and Guide Wheel	Universal	363822

DRAIN MASTER SET

DRAINAGE EQUIPMENT // DRAIN MASTER SET

Universal and Lockfast Fitting

- Rods strapped together and polybagged
- Each set supplied with 10 Polypropylene Rods ¾" Dia x 3ft with Riveted Brass Ferrules

Set Contents	Fitting	Code
Rods only. No tools	Lockfast	363813
c/w Plunger and Double Worm	Lockfast	363793
c/w Plunger, Double Worm and Drop Scraper	Lockfast	363803



DRAIN MASTER SET

DRAINAGE EQUIPMENT // DRAIN MASTER SET

Universal and Lockfast Fitting in Carry Case

- Each set supplied with 10 Polypropylene Rods ¾" Dia x 3ft with Riveted Brass Ferrules
- Supplied in carrying/storage case

Set Contents	Fitting	Code
c/w Plunger and Double Worm	Universal	363788
c/w Plunger, Double Worm and Drop Scraper	Universal	363800
c/w Plunger, Double Worm and Drop Scraper	Lockfast	363802



DRAIN MASTER SET

DRAINAGE EQUIPMENT // DRAIN MASTER SET

Drain Master Set in Canvas Bag

- Each set supplied with 10 Polypropylene Rods ¾" Dia x 3ft with Riveted Brass Ferrules
- Supplied in carrying/storage case
- c/w Plunger and Double Worm
- Supplied in Canvas Bag

Item	Code
Universal Fitting	363786
Lockfast Fitting	363787

Drainage Equipment 08



POLYPROPYLENE RODS

DRAINAGE EQUIPMENT // POLYPROPYLENE RODS

Universal and Lockfast Fitting Polypropylene Rods with Riveted Brass Ferrules

- ¾" Dia x 3ft with Riveted Brass Ferrules

Set Contents	Fitting	Code
¾" [19mm] Dia x 3ft	Universal	363804
¾" [22mm] Dia x 3ft	Universal	363807
1" [25mm] Dia x 3ft	Universal	363805
¾" [19mm] Dia x 3ft	Lockfast	363812
¾" [22mm] Dia x 3ft	Lockfast	363808
1" [25mm] Dia x 3ft	Lockfast	363806



SWEEP SET

DRAINAGE EQUIPMENT // SWEEP SET

Sweep Set – Universal and Lockfast Fitting

- Rods strapped together and polybagged
- Each set supplied with 10 Polypropylene Rods ¾" Dia x 3ft with Riveted Brass Ferrules and 16" sweepbrush

Fitting	Code
Universal Fitting	363919
Lockfast Fitting	363920

08 Drainage Equipment



Double Worm Screw

DOUBLE WORM SCREW – UNIVERSAL AND LOCKFAST FITTING – 2" DIAMETER

- Screws into soft materials, making withdrawal easy
- 2" Diameter

Item	Size	Code
Universal Fitting	2"	363894
Lockfast Fitting	2"	363895



Cleaning Brushes

CLEANING BRUSHES WITH PLASTIC STOCK – UNIVERSAL AND LOCKFAST FITTING

- Sturdy bristles for a thorough clean
- Universal and Lockfast fitting options available

Size	Fitting	Code
100mm 4" (Drain)	Universal	363868
150mm 6" (Drain)	Universal	363873
200mm 8" (Drain)	Universal	363877
225mm 9" (Drain)	Universal	363879
400mm 16" (Chimney)	Universal	363863
100mm 4" (Drain)	Lockfast	363869
150mm 6" (Drain)	Lockfast	363874
225mm 9" (Drain)	Lockfast	363880
400mm 16" (Chimney)	Lockfast	363864



Drop Scraper

DROP SCRAPER – UNIVERSAL AND LOCKFAST FITTING

- Used with polypropylene drain rods to remove any obstructions
- A hinged blade passes over obstruction & reverts back to vertical position, allowing obstruction to be dragged back to operator
- Universal and Lockfast fitting options available

Size	Fitting	Code
100mm 4" dia	Universal	363828
150mm 6" dia	Universal	363837
100mm 4" dia	Lockfast	363830
150mm 6" dia	Lockfast	363838



Guide Wheel

GUIDE WHEEL – UNIVERSAL FITTING

- Ideal for guiding rods around bends in pipes
- Manufactured in the UK
- Universal Fitting

Item	Code
Guide Wheel	363903



Rubber Plunger

RUBBER PLUNGER – UNIVERSAL AND LOCKFAST FITTING

- Removes most obstructions
- Universal and Lockfast fitting options available

Size	Fitting	Code
100mm 4" dia	Universal	363824
150mm 6" dia	Universal	363833
100mm 4" dia	Lockfast	363825
150mm 6" dia	Lockfast	363834



Force Cup/Plunger

FOR CLEARING BLOCKAGES IN SINKS AND BATHS

- Clears most blockages in sinks and baths
- Safe to use – no harmful chemicals
- Mostly for domestic use

Size	Code
Small	363902
Medium	363901
Large	363900

Drainage Equipment 08



Test Kit

AIR TESTING KIT FOR DRAINS

- All types of drains
- Test Plugs sold separately
- Manufactured in the UK

Item	Code
Test Kit	363858



Smoke Pellets

TUBE OF 6

- White smoke
- 40 second burn time over 18m³ of smoke
- Clean to use, no residue
- Cool to touch after burning
- Harmful if swallowed – keep out of reach of children.
- Do not breathe smoke.
- Manufactured in the UK

Item	Code
Smoke Pellets	363918



Smoke Matches

BOX OF 12

- White smoke
- 20 second burn time over 1.4m³
- Clean to use, no residue
- Cool to touch after burning
- Harmful if swallowed – keep out of reach of children.
- Do not breathe smoke.
- Manufactured in the UK

Item	Code
Smoke Matches	363917



Drain Trace Dye

NON TOXIC – BIODEGRADABLE – QUICK METHOD FOR LOCATING LEAKS IN DRAINS

- Manufactured in the UK
- 200gm jar
- Powder form
- Non toxic
- Odourless
- Large range of colours
- Biodegradable
- A quick method of locating leaks in drains

Colour	Code
Green – 200gm	363887
Red – 200gm	363890
Blue – 200gm	363885
Yellow – 200gm	363898
Violet – 200gm	363892
Orange – 200gm	363889
Green – 100gm	363888
Red – 100gm	363891
Blue – 100gm	363886
Yellow – 100gm	363899
Violet – 100gm	363893



Air Test Bag

AIR TEST BAGS TESTED UP TO 10PSI

- Range of sizes and lengths available
- Inflator pump sold separately
- Manufactured from high quality materials

Type	Material	Code
50mm 2"	Canvas	363937
75mm 3"	Canvas	363938
100mm 4"	Canvas	363939
100mm 4" 3 Metre Long	Canvas	363940
150mm 6"	Canvas	363941
150mm 6" 3 Meter Long	Canvas	363942
225mm 9"	Canvas	363943
50mm 2"	PVC	363841
75mm 3"	PVC	363842
100mm 4"	PVC	363843
150mm 6"	PVC	363844
8"-12"	PVC	363845



Inflator Pump

FOR INFLATING PVC AND CANVAS AIR BAG

- Manufactured from high quality materials
- Also available in brass

Item	Code
Inflator Pump	363908
Brass Inflator Pump	363909

08 Drainage Equipment

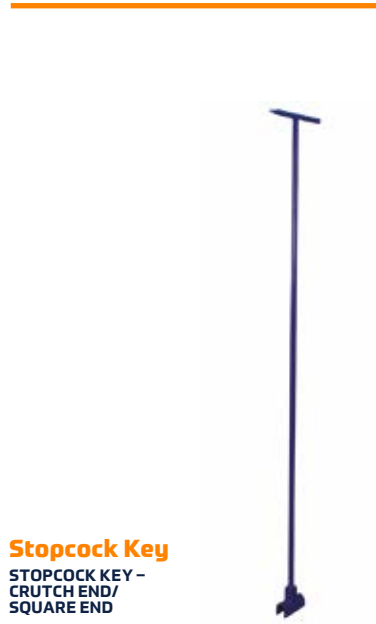

Stopcock Key
STOPCOCK KEY –
CRUTCH END/
SQUARE END

Item	Code
Stopcock Key with Crutch End	363921
Stopcock Key with Square End	363922



Hydrant Standpipe
HYDRANT STANDPIPE
SCREWED LONDON THREAD

Item	Code
Hydrant Standpipe	363906



Hydrant Key
HYDRANT KEY

Item	Code
Hydrant Key	363924



TEST PLUG

DRAINAGE EQUIPMENT // PIPES VALVES AND FITTINGS

Test plug in Aluminium and Steel

- Larger sizes also available
- Manufactured from high quality materials
- Available in Aluminium and Steel

	Part No. BBDR	Pipe Bore Size		Plug Expansion Range		Minimum Insertion Into Pipe	Overall Plug Length	Diameter of Waterway	Maximum Allowable Back Pressure	Approx. Product Weight
		Metric	Imperial	Min	Max					
Steel	363911	100mm	4"	94mm	108mm	37.5mm	83.3mm	½" BSP	10 P.S.I	0.410Kg
	363914	150mm	6"	150mm	160mm	39.7mm	83.3mm	½" BSP	10 P.S.I	0.750Kg
	363916	225mm	9"	210mm	230mm	58mm	150mm	1" BSP	7 P.S.I	1.930Kg
Aluminium	363854	50mm	2"	49mm	62mm	43mm	90mm	½" BSP	30 P.S.I	0.220Kg
	363856	63mm	2 ½"	62mm	77mm	43mm	92mm	½" BSP	30 P.S.I	0.270Kg
	363857	75mm	3"	73mm	89mm	43mm	94mm	½" BSP	20 P.S.I	0.310Kg
	363846	100mm	4"	94mm	110mm	47mm	94mm	½" BSP	10 P.S.I	0.360Kg
	363847	150mm	6"	146mm	168mm	48mm	96mm	½" BSP	10 P.S.I	0.700Kg
	363848	200mm	8"	193mm	220mm	64mm	100mm	1" BSP	7 P.S.I	1.590Kg
	363849	225mm	9"	220mm	240mm	64mm	170mm	1" BSP	7 P.S.I	2.060Kg
	363850	250mm	10"	245mm	270mm	73mm	178mm	1" BSP	7 P.S.I	2.520Kg
	363851	300mm	12"	295mm	325mm	77mm	200mm	1" BSP	7 P.S.I	3.420Kg
	363852	375mm	15"	370mm	410mm	110mm	225mm	1" BSP	5 P.S.I	5.350Kg

Gas Products 09



Compression Gas Cock

SELF COLOURED BRASS COMPRESSION GAS COCK

- For controlling gas flow, so necessary repairs can be carried out
- Gas can easily be shut off in the event of an emergency
- Manufactured from high quality materials
- Self coloured brass
- Must be fitted by a Gas Safe Registered Engineer

Size	Code
8mm Rigid Fan	364119
8mm CP Rigid Fan	364120
10mm Rigid Fan	364121
15mm Rigid Fan	364122
22mm Rigid Fan	364123



Capillary Gas Cock

SELF COLOURED BRASS CAPILLARY GAS COCK

- For controlling gas flow, so necessary repairs can be carried out
- Gas can easily be shut off in the event of an emergency
- Manufactured from high quality materials
- Must be fitted by a Gas Safe Registered Engineer

Size	Code
8mm Rigid Fan	364124
15mm Rigid Fan	364125
22mm Rigid Fan	364126



Ball Type Gas Cock

EN331 GAS APPROVED BALL TYPE

- For controlling gas flow, so necessary repairs can be carried out
- Gas can easily be shut off in the event of an emergency
- Manufactured from high quality materials
- EN331 Gas Approved Ball Type
- Must be fitted by a Gas Safe Registered Engineer

Size	Code
8mm	364130
10mm	364127
15mm	364129



Pressure Testing Nipple

1/8" PRESSURE TESTING NIPPLE

- 1/8" thread
- Manufactured from high quality materials
- Must be fitted by a Gas Safe Registered Engineer

Size	Code
1/8" Pressure Testing Nipple	364165



Straight Mini Gas Ball Valve

COMPRESSION X COMPRESSION STRAIGHT MINI BALL VALVE

- Compression x Compression – to EN331. 10 bar, temperature -20° to 85°C
- Compact chrome plated brass ballvalve with yellow coded handle
- For controlling pipe flow, so necessary repairs can be carried out
- Gas can easily be shut off in the event of an emergency
- Manufactured from high quality materials
- Must be fitted by a Gas Safe Registered Engineer

Size	Code
8mm	364152
10mm	364148
15mm	364150
8mm with Back Plate	364155



Angled Mini Gas Ball Valve

COMPRESSION X COMPRESSION ANGLE MINI BALL VALVE

- Compression x Compression – to EN331. 10 bar, temperature -20° to 85°C
- Compact chrome plated brass ballvalve with yellow coded handle
- For controlling pipe flow, so necessary repairs can be carried out
- Gas can easily be shut off in the event of an emergency
- Manufactured from high quality materials
- Must be fitted by a Gas Safe Registered Engineer

Size	Code
8mm	364151
10mm	364154

09 Gas Products



BSP Angle Socket

½" BSP ANGLE BAYONET PLUG-IN SOCKET

- Manufactured from high quality materials
- Bayonet fitting
- Must be fitted by a Gas Safe Registered Engineer

Size	Code
½" BSP Angle Socket	364132



BSP Straight Socket

½" BSP STRAIGHT BAYONET PLUG-IN SOCKET

- Manufactured from high quality materials
- Bayonet fitting
- Must be fitted by a Gas Safe Registered Engineer

Size	Code
½" BSP Straight Socket	364133



Micropoint Socket

BRASS MICROPPOINT SOCKET

- Manufactured from high quality materials
- Micropoint fitting
- Must be fitted by a Gas Safe Registered Engineer

Size	Code
Micropoint Socket	364160



Gas Meter Union

GAS METER UNIONS MADE TO BS746

- Manufactured from high quality materials

Size	Code
22mm Grooved	364162
28mm Grooved	364163
22/28mm Universal	364161
Meter Union Washer	364164



Catering Hose

APPROVED TO BS669 PART 2 1997

- Approved to BS669 Part 2 1997
- Manufactured to high specification

Size	Code
½" x 1000mm	367297
½" x 1000mm Braided	367298
½" x 1500mm	367299
½" x 1500mm Braided	367300
¾" x 1000mm	367301
¾" x 1000mm Braided	367302
¾" x 1500mm	367303
¾" x 1500mm Braided	367304
½" x 1000mm Bayonet	367305
½" x 1250mm Bayonet	367306



Cooker Hose

COOKER HOSE FOR LPG AND NATURAL GAS

- Manufactured to BS669:1
- Bayonet and Micropoint fitting
- Must be fitted by a Gas Safe Registered Engineer
- Available for LPG and Natural Gas

Type	Size	Fitting	Code
LPG	3ft	Bayonet	364138
LPG	4ft	Bayonet	364137
Natural Gas	3ft	Bayonet	364134
Natural Gas	4ft	Bayonet	364135
Natural Gas	3ft	Micropoint	364156
Natural Gas	3.5ft	Micropoint	364157
Natural Gas	4ft	Micropoint	364158

Gas Products 09



Cooker Stability Chain

FOR SECURING GAS AND ELECTRIC COOKERS

- Manufactured from high quality materials
- All parts supplied in a bag
- Easy to fit
- Supplied with snap hook for easy release
- Lots of uses around the home and garden
- No accidents with small children or elderly

Item	Code
Cooker Stability Chain	364283



Meter Box Key

FOR OPENING AND CLOSING GAS AND ELECTRIC METER CUPBOARDS

- Manufactured from durable plastic
- Triangular shape for locks
- Hole For Attaching To Keyring

Item	Code
Meter Box Key	364284



Gas Restrictor Tube

CHROME PLATED

- Manufactured from high quality materials
- Chrome Plated
- For natural gas only

Size	Code
1m long x 8mm	364142
1m long x 12mm	364139
1.25m long x 8mm	364141
1.25m long x 12mm	364140



Gas Fibre Washers

WASHERS SUITABLE FOR GAS APPLICATIONS

Item	OD (mm)	ID (mm)	QTY (pack)	Thickness	Code
¼"	10.4	6.26	6	2	368868
⅜"	14.55	8.8	6	2	368869
½"	18.38	11.1	8	2	368870
¾"	23.7	18	6	2	368871
1"	29.7	24	3	2	368872
1¼"	38.2	30.3	2	2	368873
1½"	44.4	31.75	2	2	368874
3 x ½" - 3 x ¾" - 1 x 1"			7		368875



Lever Ballvalve F x F

FEMALE X FEMALE GAS LEVER BALLVALVE. YELLOW HANDLE

- Brass body and plated finish
- Female x Female
- For isolating part of the system, this avoids the need to drain down the whole system in order to carry out repairs.
- For gas
- Manufactured from high quality materials

Size	Code
¼"	364182
⅜"	364183
½"	332976
¾"	332977
1"	332980
1¼"	364189
1½"	364190
2"	364191
2½"	364192
4"	364193



Lever Ballvalve Compression

COMPRESSION LEVER BALL VALVE. YELLOW HANDLE

- Brass body and plated finish
- Compression x Compression
- For isolating part of the system, this avoids the need to drain down the whole system in order to carry out repairs.
- For gas
- Manufactured from high quality materials

Size	Code
15mm	364925
22mm	364926
28mm	364927
35mm	364928
42mm	364929
54mm	364930

10 Pipe Clips



Snap-in Pipe Clip

INTA-LOC SNAP-IN PIPE CLIP

- Manufactured from high quality materials
- Easily push pipes in to place
- Range of sizes from 15mm, 22mm and 28mm providing plenty of options for all types of installations

Size	Code
15mm	367315
22mm	367316
28mm	367317



Wrap Over Pipe Clips

INTA-LOC WRAP OVER PIPE CLIPS

- Manufactured from high quality materials
- Easily holds pipes in to place
- Range of sizes from 15mm, 22mm and 28mm providing plenty of options for all types of installations

Size	Code
15mm	367318
22mm	367320
28mm	367322



Nail in Pipe Clips

NAIL IN TYPE PIPE CLIPS

- Manufactured from high quality materials
- Easily secure pipes in to place
- Range of sizes from 7-10mm-10-14mm, 15mm and 22mm providing plenty of options for all types of installations

Size	Code
7mm – 10mm	367324
10mm – 14mm	367325
15mm	367326
22mm	367328



Hose Clip

BETA HOLDTITE HOSE CLIPS

- Range of sizes from 9.5mm - 160mm

Size	Code
(000) 9½ – 12mm	368100
(M00) 12 – 16mm	368101
(00) 14 – 20mm	368102
(0) 16 – 22mm	368103
(0X) 18 – 25mm	368104
(1A) 22 – 30mm	368105
(1) 25 – 35mm	368106
(1X) 30 – 40mm	368107
(1M) 32 – 45mm	368108
(2A) 35 – 50mm	368109
(2) 42 – 55mm	368110
(2X) 45 – 60mm	368111
(3) 50 – 70mm	368112
(3X) 60 – 80mm	368113
(4) 70 – 90mm	368114
(4X) 80 – 100mm	368115
(5) 100 – 120mm	368116
(6) 125 – 140mm	368117
(7) 140 – 160mm	368118



Jubilee Hose Clip

GENUINE JUBILEE HOSE CLIPS

- Manufactured from stainless steel
- Tested by the British Standards Institute (BSI)
- Carry BS Kitemark™
- Available in a wide range of sizes
- Adjustable to get perfect fit

Size	Code
000C12 9½ – 12mm [¾" – ½"]	368065
M00C16 11 – 16mm [½" – ¾"]	368067
00C20 13 – 20mm [½" – ¾"]	368069
0C22 16 – 22mm [¾" – 7/8"]	368071
0XC25 18 – 25mm [¾" – 1"]	368073
1AC30 22 – 30mm [7/8" – 1½"]	368075
1C35 25 – 35mm [1" – 1¾"]	368077
1XC40 30 – 40mm [1½" – 1¾"]	368079
1MC45 [32 – 45mm [1¾" – 1¾"]	368081
2AC50 35 – 50mm [1½" – 1¾"]	368082
2C55 40 – 55mm [1½" – 2½"]	368084
2XC60 45 – 60mm [1¾" – 2½"]	368086
3C70 55 – 70mm [2.0" – 2¾"]	368087
3XC80 60 – 80mm [2¾" – 3½"]	368089
4C90 70 – 90mm [2¾" – 3½"]	368091
4XC100 85 – 100mm [3¾" – 4.0"]	368092
5C120 90 – 120mm [3¾" – 4½"]	368094



Hi Grip Hose Clip

BETA HOLDTITE HOSE CLIP WITH THUMBSCREW

- Ideal for use in applications where frequent removal of hoses may be necessary

Size	Code
¾" – 1" [18mm – 25mm]	368119
1½" – 1¾" [30mm – 40mm]	368120

Pipe Clips 10



Single Munsen Ring

SINGLE MUNSEN RING. BRASS AND CHROME

- Manufactured from high quality materials
- M10
- Larger sizes available

Size	Finish	Code
15mm	Brass	367330
22mm	Brass	367333
28mm	Brass	367336
35mm	Brass	367339
42mm	Brass	367341
54mm	Brass	367343
15mm	Chrome	367331
22mm	Chrome	367334
28mm	Chrome	367337
35mm	Chrome	367340
42mm	Chrome	367342
54mm	Chrome	367344



Double Munsen Ring

BRASS DOUBLE MUNSEN RING

- Helps to secure pipe running along ceilings and walls
- Manufactured from high quality materials
- M10
- Range of sizes from 15mm to 28mm
- Larger sizes available

Size	Code
15mm	367332
22mm	367335
28mm	367338



Copper Saddle Clips

COPPER SADDLE CLIP. VARIOUS SIZES.

- Helps to secure pipe running along ceilings and walls
- Manufactured from high quality materials
- Range of sizes from 15mm to 28mm

Size	Code
15mm	367375
22mm	367377
28mm	367379



2 Piece Copper Saddle Clips

COPPER 2 PIECE SADDLE CLIP

- Helps to secure pipe running along ceilings & walls
- Manufactured from high quality materials
- 15mm

Size	Code
15mm	367380



Chrome Saddle Clips

CHROME SADDLE CLIP - MULTIPLE SIZES

- Helps to secure pipe running along ceilings & walls
- Manufactured from high quality materials
- Sizes include 15mm and 22mm

Size	Code
15mm	367376
22mm	367378



School Board Clip

CAST SCHOOL BOARD CLIP BRASS AND CHROME AVAILABLE

- Manufactured from high quality materials
- Range of sizes from 15mm to 54mm
- Brass and Chrome

Size	Finish	Code
15mm	Brass	367345
22mm	Brass	367347
28mm	Brass	367349
35mm	Brass	367351
42mm	Brass	367353
54mm	Brass	367355
15mm	Chrome	367346
22mm	Chrome	367348
28mm	Chrome	367350
35mm	Chrome	367352
42mm	Chrome	367354
54mm	Chrome	367356

School Board Clip

PRESSED SCHOOL BOARD CLIP. BRASS AND CHROME

- Manufactured from high quality materials
- Range of sizes from 15mm to 54mm

Size	Finish	Code
15mm	Brass	367357
22mm	Brass	367359
28mm	Brass	367361
35mm	Brass	367363
42mm	Brass	367365
54mm	Brass	367367



Size	Finish	Code
15mm	Chrome	367358
22mm	Chrome	367360
28mm	Chrome	367362
35mm	Chrome	367364
42mm	Chrome	367366
54mm	Chrome	367368

10 Pipe Clips



Backplate

- BRASS/CHROME M10 FEMALE IRON BACKPLATE**
- FEMALE THREAD
 - STANDARD M10 THREAD

Finish	Code
Brass	367381
Chrome	367382



Backplate

- BRASS/CHROME M10 MALE IRON BACKPLATE**
- MALE THREAD
 - STANDARD M10 THREAD

Finish	Code
Brass	367383
Chrome	367384



Mild Steel Clip

- RUBBER LINED M8/M10 MILD STEEL CLIPS**
- M8/M10 THREAD

Size	Code
12-15mm M8/M10 Threaded	367391
15-19mm M8/M10 Threaded	367392
20-24mm M8/M10 Threaded	367393
25-30mm M8/M10 Threaded	367394



Hospital Bracket

- HOSPITAL BRACKET IN BRASS OR CHROME**
- Manufactured from high quality materials
 - Range of sizes from 15mm to 28mm
 - Available in Brass and Chrome

Size	Finish	Code
15mm	Brass	367369
22mm	Brass	367371
28mm	Brass	367373
15mm	Chrome	367370
22mm	Chrome	367372
28mm	Chrome	367374



Dual Purpose Clips

- DUAL PURPOSE CLIP. BRASS AND CHROME.**
- Manufactured from high quality materials
 - Range of sizes from 15mm to 28mm
 - Available in Brass and Chrome

Size	Finish	Code
15mm	Brass	367385
22mm	Brass	367387
28mm	Brass	367389
15mm	Chrome	367386
22mm	Chrome	367388
28mm	Chrome	367390



Pipe Clips 10



Flexible Rubber Coupling

FLEXIBLE RUBBER COUPLING. VARIOUS SIZES

- Manufactured from an elastomeric compound
- Stainless Steel Hex Head Screws
- Meets requirements of ASTM C-564

Size	Code
1½" Copper or 1½" PL/ST/LD x 1½" PL/ST/LD	367250
1½" CI/PL/ST/LD x 1½" CI/PL/ST/LD	367251
1½" CI/PL/ST/LD x 1½" CI/PL/ST/LD or 1½" PI/ST/LD	367252
2" x 1½"	367253
2" x 2"	367254
3" x 2"	367255
3" x 3"	367256
4" x 1½"	367257
4" x 2"	367258
4" x 3"	367259

Size	Code
4" x 4"	367260
5" x 4"	367261
5" x 5"	367262
6" x 4"	367263
6" x 5"	367264
6" x 6"	367265
8" x 4"	367266
8" x 6"	367267
8" x 8"	367268
10" x 8"	367269
10" x 10"	367270
12" x 12"	367271



Rubber End Cap

FLEXIBLE RUBBER END CAP

- Manufactured from an elastomeric compound
- Stainless Steel Hex Head Screws
- Meets requirements of ASTM C-564

Size	Code
1½"	367282
2"	367283
3"	367284
4"	367285
5"	367286
6"	367287
8"	367288



Rubber Elbow

FLEXIBLE RUBBER ELBOW

- Manufactured from an elastomeric compound
- Stainless Steel Hex Head Screws
- Meets requirements of ASTM C-564

Size	Code
1½"	367289
2"	367290
3"	367291
4"	367292



Rubber Tees

FLEXIBLE RUBBER TEES

- Manufactured from an elastomeric compound
- Stainless Steel Hex Head Screws
- Meets requirements of ASTM C-564

Size	Code
1½"	367293
2"	367294
3"	367295
4"	367296



Cast Iron/Plastic Rubber Coupling

CAST IRON/PLASTIC FLEXIBLE RUBBER COUPLING

- Manufactured from an elastomeric compound
- Stainless Steel Hex Head Screws
- Meets requirements of ASTM C-564

Size	Code
4" Clay x 4" Cast Iron/Plastic	367272
5" Clay x 5" Cast Iron/Plastic	367273
6" Clay x 4" Cast Iron/Plastic	367274
6" Clay x 6" Cast Iron/Plastic	367275
8" Clay x 6" Cast Iron/Plastic	367276
8" Clay x 8" Cast Iron/Plastic	367277
10" Clay x 10" Cast Iron/Plastic	367278



Rubber Coupling for Drainage

RUBBER COUPLING FOR DRAINAGE

- Manufactured from an elastomeric compound
- Stainless Steel Hex Head Screws
- Meets requirements of ASTM C-564

Size	Code
0.75 or 1" x 1" Dishwasher Connector	367279
1½" x 1½" Tubular Traps Connector (for 1½" or 1½" drain piping)	367280
1½" x 1½" Tubular Traps Connector (for 2" drain piping)	367281

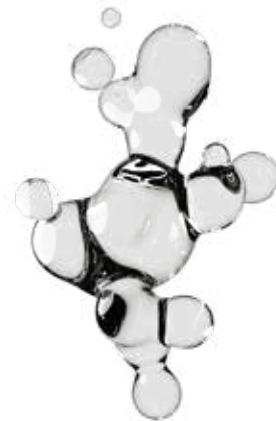

11 Plumbing Brassware & Accessories



Y Strainer

PLUMBING BRASSWARE & ACCESSORIES // VALVES // Y STRAINER

15mm Compression Y Strainer

- 15mm in-line isolating valve
- Double check valve
- Integral removable strainer
- 40 Mesh
- Supplied with both red & blue handles
- 180° rotation
- Suitable for copper & plastic pipe



Type	Code
15mm Compression with Double Check Valve, 40 Mesh	364116

For alternative Y Strainer please see page 171

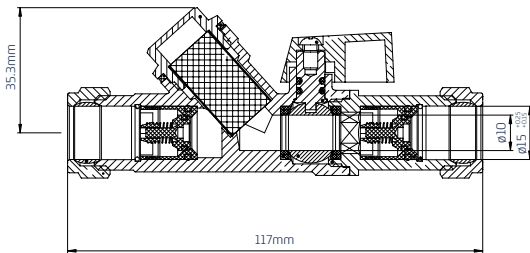

Ideal for isolating both domestic and commercial systems, where particles or sediment may impact the performance or lifespan of the system

- Compact and easy to clean fitted with a removable drain plug
- Ideally suited for applications to protect pumps, meters and valves

Visit our website



Plumbing Brassware & Accessories // Radiator & Heating Products 11



Angle Radiator Valve

ANGLE RADIATOR VALVE - VARIOUS SIZES AVAILABLE

- Brass Body
- Chrome Plated
- Supplied with wheelhead and lockshield tops

Type	Size	Code
Angle	15mm	363945
Angle	10mm	363947
Angle	8mm	363949
Angle with 3/4" Union Tale	15mm	363946
Angle with 3/4" Union Tale	10mm	363948
Angle with 3/4" Union Tale	8mm	363950



Radiator Valve Angle with Drain Off

ANGLE RADIATOR VALVE WITH DRAIN OFF - VARIOUS SIZES

- Brass Body
- Chrome plated
- Supplied with wheelhead and lockshield tops
- Drain off – quick and easy when emptying the radiator of water

Size	Code
15mm	363953
10mm	363952
8mm	363951



Radiator Valve Angle with Rubber Grommet

ANGLE RADIATOR VALVE WITH RUBBER GROMMET - VARIOUS SIZES

Chrome Plated

- Supplied with wheelhead and lockshield tops
- Water flow can be easily adjusted by use of a spanner
- Complete with rubber grommet

Size	Code
15mm Wallace Radiator Valve	363967
10mm Wallace Radiator Valve	363968



Straight Radiator Valve

STRAIGHT RADIATOR VALVE - VARIOUS SIZES

- Chrome Plated
- Supplied with wheelhead & lockshield tops

Size	Code
15mm	363954



Brass Angle Radiator Valve

BRASS ANGLE RADIATOR VALVE - VARIOUS SIZES

- Brass Body
- Supplied with wheelhead & lockshield tops

Size	Code
15mm	363955
8mm	363956



Thermostatic Radiator Valve

THERMOSTATIC RADIATOR VALVE. VARIOUS SIZES

- 15mm Liquid Sensor

Size	Code
15mm	363961

11 Plumbing Brassware & Accessories // Radiator & Heating Products



Towel Rail Valve

TOWEL RAIL VALVE WITH METAL TOPS

- Brass Body
- Chrome Plated
- Supplied in Pairs
- Supplied with Metal Tops
- Heavy Pattern

Size	Tops	Code
15mm x 1/2" Angle	Metal	363962



Radiator Drain Off

RADIATOR DRAIN OFF VALVE

Item	Code
Radiator Drain Off	364035



Radiator Tail

ADJUSTABLE RADIATOR TAIL

Size	Code
20mm	363959
40mm	363960



Radiator Spanner

- Manufactured from high-quality materials
- Hexagonal shape
- Square socket end
- For use with radiator tails and valves

Item	Code
Radiator Spanner	364286



Radiator Brackets

- Supplied in sets of 4
- Fits most standard radiators
- Manufactured from high-quality materials

Item	Code
Radiator Brackets	364285



Alloy Radiator Key

ALLOY RADIATOR KEY WITH SQUARE FEMALE END

Item	Code
Alloy Radiator Key	368126



Clock Type Radiator Key

BRASS CLOCK TYPE WITH SQUARE FEMALE END

Item	Code
Clock Type Radiator Key	368123



Tommy Bar Radiator Key

BRASS TOMMY BAR TYPE WITH SQUARE FEMALE END

Item	Code
Tommy Bar Radiator Key	368127

Plumbing Brassware & Accessories // Radiator & Heating Products 11



Air Vents

3mm [3/8"] WITHOUT KEY

- Brass with BSP male parallel thread
- 10bar max

Size	Code
3/8"	368129



Air Vents

6mm [1/4"] WITHOUT KEY

- Brass with BSP male parallel thread
- 10bar max

Size	Code
1/4"	368131



Air Vents

13mm [1/2"] WITHOUT KEY

- Brass with BSP male parallel thread
- 10bar max

Size	Code
1/2"	368133



Air Vents

CAPILLARY AIR VENT

- Brass with BSP male parallel thread
- 10bar max

Size	Code
15mm	364441
22mm	364443



Air Vents

1/4" CHROME PLATED AUTO AIR VENT

- Brass with BSP male parallel thread
- 10bar max

Size	Code
1/4"	368124



Radmaster Radiator Tail

RADMASTER ISOLATING RADIATOR TAIL

- Compatible with all systems irrespective of size of inlet/outlet valves
- No airlocks & no need to drain the system
- Isolates radiator from heating system
- One man operation
- Tested to 25 bar
- Allen key operation for all round access
- No need to re-pressurize the system
- Tested and conforms to BS2767

Item	Code
Radmaster Radiator Tail 1/2" BSP	368354



Type A Capillary Draincock

TYPE A CAPILLARY DRAINCOCK IN VARIOUS SIZES
15mm LONG SHANK

- Sturdy brass construction
- Supplied with seal inside body, this keeps the product watertight when not in use
- Lockshield top – no need for a specific key to tighten
- Water flow easily adjusted by use of a spanner

Size	Code
15mm	364028
15mm DZR	364029
15mm DZR Lockshield	364030



Type A Capillary Long Draincock

TYPE A CAPILLARY LONG DRAINCOCK
15mm TAIL SHANK

- Sturdy brass construction
- Supplied with seal inside body, this keeps the product watertight when not in use
- No need for a specific key to tighten
- Water flow can be easily adjusted by use of a spanner

Item	Code
Type A Capillary Long Draincock	364031



Type A Draincock

TYPE A DRAINCOCK IN VARIOUS SIZES

- Sturdy brass construction
- Supplied with seal inside body, this keeps the product watertight when not in use
- No need for a specific key to tighten
- Water flow can be easily adjusted by use of a spanner

Size	Code
1/2"	364024
1/2" DZR	364025
3/4"	364036
1/2" DZR Lockshield	364026
1/2" Lockshield	364027

11 Plumbing Brassware & Accessories // Radiator & Heating Products



Type B Draincock

TYPE B DRAINCOCK IN VARIOUS SIZES

- Sturdy brass construction
- No need for a specific key to tighten
- Water flow easily adjusted by use of a spanner

Size	Code
½"	364032
15mm	364033



Auto Air Vent

BLASTED BRASS AUTO AIR VENT

- Manufactured from blasted brass
- Automatically does all the work for you
- Supplied with Isolating Valve

Size	Code
½" with Isolating Valve	368122
¾" with Isolating Valve	368121



Combi Filling Loop

DZR DOUBLE CHECK VALVE

- Manufactured from high quality materials
- DZR double check valve connected to either straight or tee brass isolating valve

Type	Code
Tee	368957
Straight	368958
Part 'L'	368959



Gate Type Pump Valve

BRASS GATE TYPE PUMP VALVE

- Manufactured from high quality materials
- Supplied with fibre washers
- Suitable for water
- Adjustable flow control

Size	Code
22mm	364061
28mm	364062



Ball Type Pump Valve

BALL TYPE PUMP VALVE

- Manufactured from high quality materials
- Supplied with fibre washers
- Suitable for water

Size	Code
22mm	364063
28mm	364064



Pump Valve Fitting Nuts

BRASS NUT

- Manufactured from high quality materials
- Suitable for water

Item	Code
Pump Valve Fitting Brass Nuts	364065



Pump Union

1½" x 1" BRASS PUMP UNION

- Manufactured from high quality materials
- Supplied with fibre washers
- Suitable for water

Size	Code
1½" x 1" Brass Pump Union	364066



Plumbing Brassware & Accessories // Radiator & Heating Products 11



Short Adapter

1½" SHORT ADAPTOR

- Manufactured from high quality materials
- Supplied with fibre washers
- Suitable for water

Size	Code
1½" Short Adapter	364067



Long Adaptor

1½" LONG ADAPTOR

- Manufactured from high quality materials
- Supplied with fibre washers
- Suitable for water

Size	Code
1½" Long Adaptor	364068



Extension Pump Union

EXTENSION PUMP UNION

- Manufactured from high quality materials
- Supplied with fibre washers
- Suitable for water

Item	Code
Extension Pump Union	364069



Pump Gasket

1½" PUMP GASKET

- Manufactured from high quality materials
- Suitable for water

Size	Code
1½" Pump Gasket (fibre)	364070



Immersion Heater Plug

COPPER CYLINDER IMMERSION HEATER PLUG

- For use in copper cylinders
- Size 2¼"
- Accessories available

Size	Code
2¼" Immersion Heater Plug (comes with fibre washer)	364087



Spare Washer

IMMERSION HEATER PLUG SPARE WASHER

Item	Code
Spare Washer (fibre)	364088



Spring Safety Valves

SAFETY VALVE OPERATED BY INTERNAL SPRING

- Manufactured from high quality materials
- Operated by an internal spring
- Valve vents if set pressure is exceeded
- Internal spring operated
- Maximum opening pressure between 4-5 bar

Size	Code
½"	364085
¾"	364086



11 Plumbing Brassware & Accessories // Washing Machine Accessories



Washing Machine Taps

WASHING MACHINE TAPS SUPPLIED WITH RED AND BLUE HANDLES

- Brass Body, Chrome Plated
- Supplied with red and blue handles
- 15mm x 3/4" BSP
- Suitable for both hot and cold water

Type	Code
Straight	
Straight Light Pattern	363971
Straight Heavy Pattern	363973
Straight with Single Check Valve	363985
Angle	
WRAS approved Angle Washing Machine Taps	363976
Tee	
WRAS approved Tee Washing Machine Taps	363977



Self Cutting Washing Machine Tap

SELF CUTTING WASHING MACHINE TAP. 15mm STRAIGHT

- A quick and easy way to install a washing machine tap
- Fits standard 15mm copper pipe
- Suitable for both hot and cold water

Item	Code
Self Cutting Washing Machine Tap	363972



Blue / Red Washing Machine Hose

BLUE/RED WASHING MACHINE HOSE. UNIVERSAL TO FIT WASHING MACHINE/DISHWASHER

Size	Code
1.5m Blue	363978
2.5m Blue	363981
1.5m Red	363979
2.5m Red	363982



Grey Outlet Hose

WASHING MACHINE/DISHWASHER OUTLET HOSE

Size	Code
1.5m	363986
2.5m	363987



Plumbing Out Kit

SUITABLE FOR 32mm & 40mm WASTE CONNECTIONS

- Supplied with easy boring all steel cutter
- Built in non return valve to prevent back flow and drainage smells

Size	Code
Plumbing Out Kit	363988



Y Adaptor

UNIVERSAL TO FIT WASHING MACHINE / DISHWASHER

- Universal to fit washing machine/dishwasher
- Allows 2 appliances to use the same water supply

Size	Code
3/4" BSP Y Adaptor	363980



Outlet Hose Connector

EXTENDER FOR WASHING MACHINE/ DISHWASHER WASTE OUTLET

- Designed to extend a washing machine or dishwasher waster outlet
- Size: 17mm
- Simple and easy to fit – push fit no tools required
- Recommend using our genuine Jubilee Hose Clips to help secure hose

Size	Code
17mm Outlet Hose Connector	363984



Inlet Hose Connector

DESIGNED TO JOIN TWO WASHING MACHINE HOSES TOGETHER

- Size: 3/4"

Size	Code
3/4" Inlet Hose Connector	363983

Plumbing Brassware & Accessories // Valves 11



Chrome Isolating Valve

CHROME COMPRESSION X COMPRESSION ISOLATING VALVE. VARIOUS SIZES

- Compression x Compression
- For isolating part of the system, this avoids the need to drain down the whole system in order to carry out repairs
- Manufactured from high quality materials

Size	Code
15mm Light Pattern with Screw Slot	364052
22mm with Screw Slot	364047
15mm Angled with Screw Slot	364053



Chrome Full Bore Isolating Valve

CHROME COMPRESSION X COMPRESSION FULL BORE ISOLATING VALVE

- Compression x Compression
- For isolating part of the system, this avoids the need to drain down the whole system in order to carry out repairs
- Manufactured from high quality materials

Size	Code
15mm with Screw Slot	364039
22mm with Screw Slot	364048



Chrome Isolating Valve with Handle

CHROME COMPRESSION X COMPRESSION ISOLATING VALVE WITH HANDLE

- Compression x Compression
- For isolating part of the system, this avoids the need to drain down the whole system in order to carry out repairs
- Manufactured from high quality materials

Size	Code
15mm Light Pattern	364054
15mm	364042
22mm	364049



Full Bore Isolating Valve

BRASS COMPRESSION X COMPRESSION FULL BORE ISOLATING VALVE

- Compression x Compression
- For isolating part of the system, this avoids the need to drain down the whole system in order to carry out repairs.
- Manufactured from high quality materials
- 15mm Full Bore with Screw Slot

Size	Code
15mm	364037



Isolating Valve

BRASS COMPRESSION X COMPRESSION ISOLATING VALVE

Size	Code
15mm Light Pattern with Screw Slot	364050
22mm with Screw Slot	364043



Isolating Valve with Handle

BRASS COMPRESSION X COMPRESSION ISOLATING VALVE WITH HANDLE

- Compression x Compression
- For isolating part of the system, this avoids the need to drain down the whole system in order to carry out repairs
- Manufactured from high quality materials

Size	Code
15mm Light Pattern	364051
22mm	364046



Straight Service Valve

CHROME STRAIGHT SERVICE VALVE

- Compression x Swivel Nut
- Screwdriver Slot
- Used to isolate part of the system
- Brass body, chrome plated

Size	Code
15mm x 1/2"	364055
22mm x 3/4"	364081



Angle Service Valve

CHROME ANGLE SERVICE VALVE

- Compression x Swivel Nut
- Screwdriver Slot
- Used to isolate part of the system
- Brass body, chrome plated

Size	Code
15mm x 1/2"	364058



Push Fit Service Valve

CHROME STRAIGHT PUSH FIT

- Screwdriver Slot
- Used to isolate part of the system
- Brass body, chrome plated

Size	Code
15mm	364056

11 Plumbing Brassware & Accessories // Valves



WRAS Straight Service Valve
CHROME WRAS APPROVED STRAIGHT

- Compression x Swivel Nut
- Screwdriver Slot
- Used to isolate part of the system
- Brass body, chrome plated

Size	Code
15mm x 1/2"	364057



WRAS Angle Service Valve
CHROME WRAS APPROVED ANGLE

- Compression x Swivel Nut
- Screwdriver Slot
- Used to isolate part of the system
- Brass body, chrome plated
- WRAS Approved

Size	Code
15mm x 1/2"	364059



Checkvalve

SINGLE BRASS COMPRESSION X COMPRESSION

- Brass spring loaded
- Compression x Compression
- Fully self automating valve
- Eliminates water contamination or back flow

Size	Code
15mm	364072
22mm	364073
28mm	364074



Checkvalve
FULL BORE

- 28mm

Size	Code
28mm	364075



Checkvalve

DOUBLE DZR COMPRESSION X COMPRESSION

- Compression x Compression
- DZR
- Fully self automating valve
- Eliminates water contamination or back flow

Size	Code
15mm	364076
22mm	364078



Checkvalve

DOUBLE DZR FEMALE X FEMALE

- DZR
- Female x Female
- Fully self automating valve
- Eliminates water contamination or back flow

Size	Code
3/4" Checkvalve	364079

Plumbing Brassware & Accessories // Valves 11



Standard Outdoor Tap Kit STANDARD KIT CONTAINING 9 PIECES

- Simple DIY installation
- 1 x Compression Elbow
- 1 x Isolating Valve with Handle
- 1 x Compression Tee Joint
- 1 x Hose Union Bibtap with double check valve
- 1 x Wallplate with Copper Tube
- 3 x Screws and Plugs
- 1 x Roll of PTFE Tape

Item	Code
Standard Outdoor Tap Kit	364017



Economy Outdoor Tap Kit ECONOMY KIT CONTAINING 5 PIECES

- Simple DIY installation
- 1 x 15mm Tee Isolating Valve Brass with double check valve
- 1 x 15mm x 1/2" (500mm long x 7.5mm) bore Flexi Connector
- 1 x 1/2" BS1010 Hose Union Bibtap
- 1 x Wallplate with Copper Tube
- 1 x Roll of PTFE Tape

Item	Code
Economy Outdoor Tap Kit	364006



Wallplate Connector & Kit WITH COPPER TUBE

- 1/2" female threaded tap mounting flange
- 15mm copper tube
- Available in 14" or 20" length
- Simple DIY installation

Size	Code
14" Copper Tube	364022
20" Copper Tube	364023



Hose Union Bibcocks

MADE TO BRITISH STANDARD BS1010

- Manufactured to British Standard BS1010
- For outdoor taps

Size	Code
1/2"	364005
3/4"	364012



DZR Hose Union Bibcocks

DOUBLE CHECK VALVE DZR

- Supplied with internal double check valve
- For outdoor taps

Size	Code
1/2"	364016
3/4"	364020



Tail and Union

HOSE UNION BIBCOCK TAIL AND UNION

Size	Code
To suit 1/2"	364010
To suit 3/4"	364014

11 Plumbing Brassware & Accessories // Valves



Lever Ballvalve Compression

RED HANDLE LEVER BALLVALVE - COMPRESSION

- Brass body and plated finish
- Compression x Compression
- For isolating part of the system, this avoids the need to drain down the whole system in order to carry out repairs.
- For hot water
- Manufactured from high quality materials

Size	Code
15mm	364904
22mm	332979
28mm	364906
35mm	364907
42mm	364908
54mm	364909



Lever Ballvalve Compression

RED BUTTERFLY HANDLE LEVER BALLVALVE - COMPRESSION

- Brass body and plated finish
- Compression x Compression
- For isolating part of the system, this avoids the need to drain down the whole system in order to carry out repairs.
- For hot water
- Manufactured from high quality materials

Size	Code
15mm	332974
22mm	364911



Lever Ballvalve Female x Female

RED HANDLE LEVER BALLVALVE - FEMALE X FEMALE

- Brass body and plated finish
- For isolating part of the system, this avoids the need to drain down the whole system in order to carry out repairs.
- For hot water
- Manufactured from high quality materials
- Female x Female

Size	Code
1/4"	364912
3/8"	364913
1/2"	364914
3/4"	364915
1"	364916
1 1/4"	364917
1 1/2"	364918
2"	364919



Lever Ballvalve Female x Female

RED BUTTERFLY HANDLE LEVER BALLVALVE - FEMALE X FEMALE

- For isolating part of the system, this avoids the need to drain down the whole system in order to carry out repairs.
- For hot water
- Manufactured from high quality materials
- Female x Female

Size	Code
1/2"	364920
3/4"	364921



Lever Ballvalve Compression

BLUE HANDLE LEVER BALLVALVE - COMPRESSION

- Brass body and plated finish
- Compression x Compression
- For isolating part of the system, this avoids the need to drain down the whole system in order to carry out repairs.
- For cold water
- Manufactured from high quality materials

Size	Code
15mm	364886
22mm	332978
28mm	364888
35mm	364889
42mm	364890
54mm	364891



Lever Ballvalve Female x Female

BLUE BUTTERFLY HANDLE LEVER BALLVALVE - FEMALE X FEMALE

- Brass body and plated finish
- For isolating part of the system, this avoids the need to drain down the whole system in order to carry out repairs.
- For cold water
- Manufactured from high quality materials
- Female x Female

Size	Code
1/2"	364902
3/4"	364903

Plumbing Brassware & Accessories // Valves 11



Lever Ball Valve Compression BLUE BUTTERFLY HANDLE LEVER BALL VALVE

- Brass body and plated finish
- Compression x Compression
- For isolating part of the system, this avoids the need to drain down the whole system in order to carry out repairs.
- For cold water
- Manufactured from high quality materials

Size	Code
15mm	364892
22mm	364893



Lever Ball Valve Female x Female

BLUE HANDLE LEVER BALL VALVE - FEMALE X FEMALE

- Brass body and plated finish
- For isolating part of the system, this avoids the need to drain down the whole system in order to carry out repairs.
- For cold water
- Manufactured from high quality materials
- Female x Female

Size	Code
1/4"	364894
3/8"	364895
1/2"	364896
3/4"	364897
1"	364898
1 1/4"	364899
1 1/2"	364900
2"	364901



Lever Ball Valve Female x Female

FEMALE X FEMALE GAS LEVER BALL VALVE. YELLOW HANDLE.

- Brass body and plated finish
- Female x Female
- For isolating part of the system, this avoids the need to drain down the whole system in order to carry out repairs
- For gas
- Manufactured from high quality materials

Size	Code
1/4"	364182
3/8"	364183
1/2"	332976
3/4"	332977
1"	332980
1 1/4"	364189
1 1/2"	364190
2"	364191
2 1/2"	364192
4"	364193



Lever Ball Valve Compression COMPRESSION LEVER BALL VALVE. YELLOW HANDLE.

- Brass body and plated finish
- Compression x Compression
- For isolating part of the system, this avoids the need to drain down the whole system in order to carry out repairs.
- For gas
- Manufactured from high quality materials

Size	Code
15mm	364925
22mm	364926
28mm	364927
35mm	364928
42mm	364929
54mm	364930



Y Strainer COMPRESSION Y STRAINER

Size	Code
15mm Compression	364117
15mm Compression with Double Check Valve, 40 mesh	364116

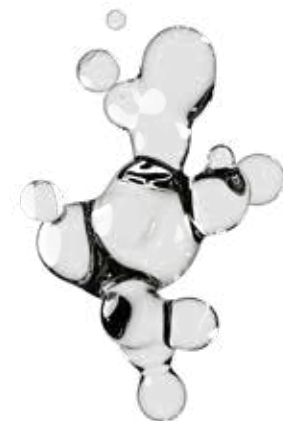

11 Plumbing Brassware & Accessories // Valves



CxC Gate Valve

BRASS COMPRESSION X COMPRESSION GATE VALVES

- Water flow can be easily adjusted manually without any need for tools
- For isolating part of the system, this avoids the need to drain down the whole system in order to carry out repairs.
- Manufactured from high quality materials

Size	Code
15mm	363990
22mm	363991
28mm	363992



Lockshield Gate Valve

BRASS LOCKSHIELD GATE VALVE

- For isolating part of the system, this avoids the need to drain down the whole system in order to carry out repairs.
- Manufactured from high quality materials

Size	Code
15mm	363993
22mm	363994



British Standard Gate Valve

BRASS GATE VALVE MADE TO BRITISH STANDARD BS5154

- Water flow can be easily adjusted manually without any need for tools
- Manufactured to British Standard BS5154
- For isolating part of the system, this avoids the need to drain down the whole system in order to carry out repairs.
- Manufactured from high quality materials

Size	Code
15mm	364089
22mm	364090
28mm	364091
35mm	364104
42mm	364105
54mm	364106



Lockshield British Standard Gate Valve

BRASS LOCKSHIELD GATE VALVE MADE TO BRITISH STANDARD BS5154

- Manufactured to British Standard BS5154
- For isolating part of the system, this avoids the need to drain down the whole system in order to carry out repairs.
- Manufactured from high quality materials

Size	Code
15mm	364092
22mm	364093
28mm	364094



FxX Gate Valve

BRASS FEMALE X FEMALE GATE VALVE

- Water flow can be easily adjusted manually without any need for tools
- For isolating part of the system, this avoids the need to drain down the whole system in order to carry out repairs.
- Manufactured from high quality materials

Size	Code
½"	364095
¾"	364097
1"	364099
1½"	364101
1½"	364102
2"	364103



Plumbing Brassware & Accessories // Valves 11



CxC Stopcock

COMPRESSION X COMPRESSION STOPCOCK

- For isolating part of the system, this avoids the need to drain down the whole system in order to carry out repairs.
- Manufactured from high quality materials
- Compression x Compression BS1010

Size	Code
15mm	363995
22mm	363996
28mm	363997
15mm Bronze	364001
22mm Bronze	364002
35mm DZR	364218
42mm DZR	364219
54mm DZR	364220



Stopcock Drain Off

15MM STOPCOCK DRAIN OFF

- Supplied with drain off
- For isolating part of the system, this avoids the need to drain down the whole system in order to carry out repairs.
- Manufactured from high quality materials
- 15mm Stopcock Drain Off

Item	Code
Stopcock Drain Off	364034



Female x Female Stopcock

FEMALE X FEMALE STOPCOCK. VARIOUS SIZES.

- Female x Female
- For isolating part of the system, this avoids the need to drain down the whole system in order to carry out repairs.
- Manufactured from high quality materials

Size	Code
½"	364107
¾"	364109



Compression x Poly Stopcock

COMPRESSION X POLY BS1010. FOR CONNECTING COPPER TO MDPE PIPE.

- Compression x Poly
- For isolating part of the system, this avoids the need to drain down the whole system in order to carry out repairs.
- Manufactured from high quality materials
- For connecting copper to MDPE pipe

Size	Code
25mm x 25mm	363998
15mm x 25mm	363999
15mm x 20mm	364000
20mm x 20mm	364003
22mm x 25mm	364004



Lead Free Stopcock

LEAD FREE 15mm STOPCOCK

- Lead Free
- 15mm Stopcock

Size	Code
15mm Lead Free Stopcock	364204



Lead Free Check Valve

LEAD FREE 15mm DOUBLE CHECK VALVE

- Lead Free
- 15mm Double Check Valve

Size	Code
15mm Checkvalve	364206

11 Plumbing Brassware & Accessories // Flexible Tap Connectors



Flexible Tap Connector FxC

FEMALE X COMPRESSION
STANDARD AND FULL BORE

- Stainless Steel Braided over EPDM rubber – 10 bar tested
- Manufactured from high quality materials
- Female x Compression
- Standard and Full Bore available
- Standard Bore Type WRAS approved

Size	Bore Size	Code
Standard Bore Type		
15mm x 1/2" x 300mm	9mm	368965
15mm x 1/2" x 500mm	9mm	368970
15mm x 1/2" x 900mm	9mm	368973
15mm x 3/4" x 300mm	9mm	368960
15mm x 3/4" x 500mm	9mm	368990
15mm x 3/4" x 900mm	9mm	368991
15mm x 3/8" x 300mm	9mm	368979
22mm x 3/4" x 300mm	13mm	368980
22mm x 3/4" x 500mm	13mm	368982
22mm x 3/4" x 900mm	13mm	368984
Full Bore Type		
15mm x 1/2" x 300mm	13mm	368974
15mm x 3/4" x 300mm	13mm	368992
15mm x 1/2" x 500mm	13mm	368971
22mm x 3/4" x 300mm	19mm	368985
Standard Bore Type WRAS Approved		
15mm x 1/2" x 300mm	9mm	368978
22mm x 3/4" x 300mm	13mm	368989
15mm x 3/4" x 300mm	9mm	369000



Pushfit Flexible Tap Connector

PUSH FIT STANDARD AND FULL BORE

- Stainless Steel Braided over EPDM rubber – 10 bar tested
- Manufactured from high quality materials
- Push fit – simple to install

Size	Bore Size	Code
Standard Bore Type		
15mm x 1/2" x 150mm	9mm	368977
15mm x 1/2" x 300mm	9mm	368976
15mm x 1/2" x 500mm	9mm	368972
15mm x 3/4" x 300mm	9mm	368999
22mm x 3/4" x 300mm	13mm	368988
22mm x 3/4" x 500mm	13mm	368983
Standard Bore Type with Isolation Valve		
15mm x 1/2" x 300mm	9mm	368975
22mm x 3/4" x 300mm	13mm	368987
Standard Bore Type with Push Fit Both Ends		
15mm x 15mm x 300mm	9mm	368969



Flexible Tap Connector with Isolation Valve

WITH ISOLATION VALVE
STANDARD AND FULL BORE

- Stainless Steel Braided over EPDM rubber – 10 bar tested
- Manufactured from high quality materials
- Supplied with isolation valve
- Standard and Full Bore available
- Standard Bore Type WRAS approved

Size	Bore Size	Code
Standard Bore Type		
15mm x 1/2" x 300mm	9mm	368961
15mm x 1/2" x 500mm	9mm	368962
22mm x 3/4" x 300mm	13mm	368986
Full Bore Type		
15mm x 1/2" x 300mm	13mm	368963
Standard Bore Type WRAS Approved		
15mm x 1/2" x 300mm	9mm	368964



Flexible Tap Connector

COMPRESSION X COMPRESSION
STANDARD AND FULL BORE

- Stainless Steel Braided over EPDM rubber – 10 bar tested
- Manufactured from high quality materials
- Compression x Compression
- Standard and Full Bore

Size	Bore Size	Code
Standard Bore Type		
15mm x 15mm x 300mm	9mm	368966
22mm x 22mm x 300mm	13mm	368981
Full Bore Type		
15mm x 15mm x 300mm	13mm	368968



Flexible Tap FxF Connector

FEMALE X FEMALE FLEXIBLE TAP CONNECTOR

- 1/2" x 1/2" x 300mm – 9mm Bore
- Stainless Steel Braided over EPDM rubber – 10 bar tested
- Manufactured from high quality materials
- Female x Female

Size	Bore Size	Code
1/2" x 1/2" x 300mm	9mm	368996



Monobloc Flexible Tap Connectors (K)

FLEXIBLE TAP CONNECTORS

- Stainless Steel Braided over EPDM rubber – 10 bar tested
- Supplied in pairs
- Manufactured from high quality materials

Size	Bore Size	Code
M10 x 15mm x 300mm	8mm	368997
M12 x 15mm x 300mm	8mm	368998

Water Hammer Arrestors 12

MINI RESTER

PIPES VALVES AND FITTINGS // WATER HAMMER ARRESTORS

Sioux Chief ½" Mini Rester

- Arrestors should be installed within six feet of the problem valve/tap
- May be installed at any angle
- Mini Resters with a male ½" thread are simply fitted with Female ½" x 15mm Iron Tee
- Mini Resters with a Hose Tee Connection install directly on Washing Machine Supply Valves or directly to Washing Machines
- Designed for residential use
- For Single Application Installation



Size	Code
½" BSP Mini Rester	367065

MINI RESTER WASHING MACHINE FITTING

PIPES VALVES AND FITTINGS // WATER HAMMER ARRESTORS

Sioux Chief ½" Washing Machine/ Dishwasher Fitting

- Arrestors should be installed within six feet of the problem valve/tap
- May be installed at any angle
- Mini Resters with a male ½" thread are simply fitted with Female ½" x 15mm Iron Tee
- Mini Resters with a Hose Tee Connection install directly on Washing Machine Supply Valves or directly to Washing Machines
- Designed for residential use
- For Single Application Installation



Size	Code
¾" BSP Mini Rester Washing Machine Fitting	367068

12 Water Hammer Arrestors

HYDRA RESTER

PIPES VALVES AND FITTINGS // WATER HAMMER ARRESTORS

Sioux Chief Hydra Rester For Multi Appliance Installation. Various sizes

- Arrestors should be installed within six feet of the problem valve/tap
- May be installed at any angle
- Mini Resters with a male ½" thread are simply fitted with Female ½" x 15mm Iron Tee
- Mini Resters with a Hose Tee Connection install directly on Washing Machine Supply Valves or directly to Washing Machines
- Designed for residential use
- For Multiple Application Installation
- Various sizes available



Type	Size (L x W)	Packaging	Code
½" BSP Threaded Fitting	6½" x 1¾"	Boxed	367059
¾" BSP Threaded Fitting	8¾" x 1¾"	Boxed	367060
1" BSP Threaded Fitting	11" x 1¾"	Boxed	367061
1" BSP Threaded Fitting	10¾" x 2½"	Boxed	367062
1" BSP Threaded Fitting	12¾" x 2½"	Boxed	367063
1" BSP Threaded Fitting	15¾" x 2½"	Boxed	367064



**SIGN UP TODAY!
&
ENJOY ALL THE BENEFITS**



ProFit

PLUS



COLLECT



UPLOAD



REWARD

At TYDE we value the thousands of installers who buy & fit our bathroom products. That's why we launched ProFit+ to reward you for choosing TYDE. Wherever you see the ProFit+ sign, points will be included in the product packaging to collect and upload to access a range of benefits.

Spares

If you are in need of high-quality replacement parts you will find exactly what you are looking for within our spares and accessories section. We have spares for our Toilet Cisterns, Syphons, Electroflo and Kinetic ranges as well as Hydroflo and Ballvalve spares.

All our spares and accessories are made to exacting standards and undergo a range of quality tests and checks prior to despatch.

Dudley



Epson



Beta





In this section

- | | | | |
|----|------------------------------------|----|--|
| 01 | » Toilet Seat Spares & Accessories | 06 | » Inlet Float Valve Spares & Accessories |
| 02 | » Electroflo Spares & Accessories | 07 | » Hydroflo Inlet Float Valve Spares & Accessories |
| 03 | » Kinetic Spares & Accessories | 08 | » PVC Flushbends & Flushpipes Spares & Accessories |
| 04 | » Syphon Spares & Accessories | 09 | » Ballvalve & General Parts |
| 05 | » Flush Valve Spares & Accessories | 10 | » Toilet Cistern Spares |



Visit our website

Visit our website and search our extensive range of plumbing parts, find key product information such as technical specifications, installation and troubleshooting guides and create your order all in one place using our Quote Builder function.

Spares

Toilet Seat Spares & Accessories

Code	Product Name	Description
320910	Toilet Seat Hinge	C25 Easy Fit Plastic Toilet Seat Hinge for Epson Toilet Seats
320911	Toilet Seat Hinge	C30 Easy Fit Stainless Steel Toilet Seat Hinge for Epson Toilet Seats
320912	Toilet Seat Hinge	C31 Easy Fit Stainless Steel Toilet Seat Hinge for Epson Toilet Seats
320913	Toilet Seat Hinge	C33 Top Fix Easy Fit Stainless Steel Toilet Seat Hinge for Epson Toilet Seats
323745	Toilet Seat Hinge	Top Fix Hinge for Rhianna and Esme Soft Close Toilet Seat

Electroflo Spares & Accessories

Code	Product Name	Description
323694	Battery Box	IP67 Battery Box for Battery Operated Dudley Electroflo Taps (Except Contemporary)
323692	Power Splitter	Two Way Power Splitter (M-F2) 100mm (For use with Contemporary Taps)
324324	Power Splitter	Two Way Power Splitter (F-M2) 100mm
324325	Power Splitter	Three Way Power Splitter (F-M3) 100mm
326398	Cable Extension	3 Metre Cable Extension for Electroflo Taps, Urinals and Soap Dispensers (RED)
326998	Solenoid Valve	Solenoid Valve Spare, for Dudley Electroflo Taps and Urinal Sensor. (Includes Diaphragm)
333866	Diaphragm	Diaphragm only for Solenoid Valve for Dudley Electroflo Taps. 10 Pack

Electroflo WC flush Spares & Accessories

Code	Product Name	Description
325443	Junction Box	Transformer Junction Box for Dudley 'Electroflo' Cisterns (Suitable for up to 10 Cisterns)
324468	Electroflo Control Box & Sensor	Electroflo Control Box & Sensor only
324469	CP Single Flush	100mm Surround only Dudley 'Electroflo'
324470	CP Dualflush	100mm Surround only Dudley 'Electroflo'
325270	Electroflo Extension Lead	500mm Extension Lead
325894	Infrared Sensor Eye	Infrared Sensor Eye with Cable for Dudley 'Electroflo' Cistern
326647	Electroflo Control Box	Electroflo Control Box only
329984	Dudley 'Electroflo' Sensor	Satin Stainless Steel Surround, Sensor, 304G
323107	Mains Adaptor Dudley 'Electroflo' Cistern	Mains Adaptor Dudley 'Electroflo' Cistern
324217	Wall Extension kit	125mm Wall Extension kit for WC Electroflo Sensor

Kinetic Spares & Accessories

Code	Product Name	Description
330349	Servicing Kit	Kinetic Servicing Kit
330350	Kinetic Solenoid Valve	White
330351	Kinetic Solenoid Valve	Grey
330353	Kinetic Front Panel	White
330355	Cable	Kinetic Solenoid 1 Meter Cable

Dudley Spares

Dudley Syphon Spares & Accessories

Code	Description
372687	Universal Syphon Toilet Repair Kit Including: Turbo Edge Adjustable Syphon, Hydroflo Telescopic Compact Float Valve & Cistern Lever
313313	Dudley Syvac Syphonic Aspirator (For S7 and Turbo 88 only)
316855	Plastic Piston with Polythene Diaphragm for Turbo 88 Syphon
319797	Plastic Piston with Polythene Diaphragm for Turbo S1-11 Syphon
314837	1½" Plastic Backnut
316571	1½" Capnut
318134	Stainless Steel 'C' Link - Up To 76mm [3"]
317307	Stainless Steel 'C' Link - 3½"
317898	Stainless Steel 'C' Link - 3¾"
317143	Stainless Steel 'C' Link - 4"
322946	Stainless Steel 'C' Link - 4¼"
318323	Stainless Steel 'C' Link - 4½"
317537	Stainless Steel 'C' Link - 5½"
313245	Polythene Syphon Diaphragm to suit Turbo 88 / S7 Cascade
314095	Polythene Syphon Diaphragm to suit S9, Hi-Flo / Japtic
316288	Polythene Syphon Diaphragm to suit Turbo S44
316576	Polythene Syphon Diaphragm to suit Turbo S1-11
319228	Spares Pack for Dudley Turbo 88 2-Part Syphon
315716	Spares Pack for Dudley Turbo S1-11 2-Part Syphon
318665	Spares Pack for Dudley Turbo S44-R 2-Part Syphon
320494	6/7L White Plug for Turbo 88 Syphon
315267	Natural Plastic Bung for Turbo 88 Syphon
370213	38.42mm ID Coupling Nut
367465	2" Syphon Washer Rubber
367466	11/2" Rubber Washer for Syphon Tail
367467	11/4" Rubber Washer for Syphon Tail
367468	1" Rubber Washer for Syphon Tail
367473	120mm Round Diaphragm Washer (41/2")
367475	Diaphragm Washer to Suit Turbo 11 (Rubberwell) Syphon
316068	203mm Dudley Turbo S44-R 2-Part Syphon.
314642	Dudley 216mm Turbo 88 2-Part Singleflush Syphon
315375	Yellow (single) Snap Pin For Dudley Turbo 2-Part Syphons
318729	83mm 'C' Link (31/4")
318927	Piston Assembly Turbo S44-R Syphon
319211	Domed Rubber Washer For Syvac Syphonic Aspirator
371155	Spares Pack for Dudley Turbo Edge® Compact Syphon
371156	Spares Pack for Dudley Cascade+ 1 Piece Syphon
367476	Diaphragm Washer to Suit Turbo 44 Syphon
367477	130mm Round Diaphragm Washer (5")

Dudley Flush Valve Spares & Accessories

Code	Description
372686	Universal Flush Valve Repair Kit Including: Victoria Dualflush Valve, Hydroflo Telescopic Compact Float Valve, Cistern to Pan Close Coupled Nut, Bolt & Washer Set & Close Coupling Kit Including Washer
318082	1½" Adaptor (Reducer) Suitable for Niagara Mechanical Valve
315900	Push Rods for Niagara Mechanical Valve
325691	Dudley 'Victoria' Dualflush Cable Operated Valve, Chrome Plated Dual Flush Button, 2" Outlet with 470mm Cable Length and 68mm Diameter Back Nut
325972	2" Outlet Cage and 'O' Rings
326900	1½" White Outlet Cage, 40mm Tail, Overflow Pipe & Nut, Backnut, Capnut, Cone Ring & 1½" Outlet Washer
316129	Dudley "Pinto" Pneumatic Single Flush Valve. 2" Outlet. Air Tube & Outer Protective Corrugated Sleeve. 6 Litre.
315297	Rubber Valve Sealing Washer For Dudley Pinto Valve (60x 24x 3mm) Grey
318948	75 x 58 x 4mm Rubber Outlet Washer For Dudley Pinto Valve Outlet
323306	Stepped Rubber Valve Sealing Washer Dudley Niagara Valve (65x 37x 4mm)
314574	Rubber Valve Sealing Washer For Niagara Mechanical Valve 38mm [I.D.]
323768	Clear Bellows for Dudley Niagara Pneumatic Valve
318947	Bellows for Dudley Pinto Valve
318289	Rubber Outlet Washer For Niagara Valve Outlet
315604	2" Backnut
313838	Length of Corrugated Outer Sleeve For Dome/cone Pb.
314962	Black 51mm i.d. Tapered Cone Ring (2")
319678	2" Capnut

Dudley Spares

Hydroflo Inlet Float Valve Spares & Accessories

Code	Description
317158	Filter and 'O' Ring
313299	Filter Key
317673	Rubber Washer [375mm O.D.]
317733	Float
318949	Float Arm and Pressure Chamber Cover
327211	Compact Delay Fill Float Arm and Pressure Chamber Cover
318756	White Flow Restrictor
315067	Blue Flow Restrictor
324037	Red Flow Restrictor
319726	Black Rubber Diaphragm Washer c/w blue pin for standard Hydroflo
316295	½" Backnut
316999	Overhead Discharge Nozzle Assembly (Diverter including silence tube)

PVC Flushbends & Flushpipes Spares & Accessories

Code	Description
315587	1676mm x 45mm White 3-Piece PVC Side Wall Flushpipe
318054	Flow Restrictor for high level flush pipe (Baffle)
317308	Finned Push-In WC Pan Connector
319415	356mm x 229mm x 38mm White Flushbend & Ring
322326	Tapered White Flushbend 51mm to 41mm
323782	457mm x 457mm Tapered Flushbend (Europipe) 45.75mm I.D. to 41.35mm O.D.
315841	38mm [1½"] I.D. Tapered Cone Ring
315432	32mm [1¼"] I.D. Tapered Cone Ring
316721	Slip Ring (Yellow) 51mm to 41mm Flushbend
363710	Standard European Flushbend 50mm (2") to 41mm (1½") DIA. 230 X 210mm
327598	Natural 51mm i.d. Tapered Cone Ring (2")
315480	1676x32mm 4-Pce PVC B'Wall F'Pipe White. H/L Cone Ring (5'6"x 1.¼")
321958	Rubber Flushbend Connector 60mm 2" Reducing Flushbend
317684	610mm x 457mm x 38mm White Flushbend & Ring

Ballvalves & General Parts

Code	Description
316574	32mm Diameter Diaphragm
317820	114mm [4½"] Blue Round "Qualifloat" Plastic Float
317501	114mm [4½"] Elongated Plastic Float
316828	19mm [¾"] Plastic Side Entry Overflow. Comes With Backnut & Capnut
316308	Plastic Pedestal Overflow Comes With Nuts & Washer
367963	32mm B.V. DIAPHRAGM WASHER (1¼")
316467	Rubber Washer for Thread of Pedestal Ballvalve
370224	32mm B.V. Diaphragm Washer (1¼")

Vantage Toilet Cisterns Spares

Code	Description
313748	Blue Access Top Cover for Dudley 'Vantage' Cistern
323579	Blue Access Front Cover for Dudley Vantage 2 Cistern to include Air Tube Connectors
326095	"Dudley 'Electroflo' Dual Flush for 'Vantage 2' & 'Miniflo' Cistern control box and sensor, 'Niagara' DF Pneumatic Valve, CP 100mm & 40mm Surround Sensor, Battery Operated"
326096	"Dudley 'Electroflo' Dual Flush for 'Vantage 2' & 'Miniflo' Cistern control box and sensor, 'Niagara' DF Pneumatic Valve, CP 100mm & 40mm Surround Sensor, Mains Operated"
325570	Wall Clamp & Fixing Clip Dudley 'Vantage 2' Cistern
326243	Volume Baffle/Partition Dudley 'Vantage 2'
325087	Braided Hose & Isolating Valve Dudley 'Vantage 2' Cistern (Overall Length 270mm) with White Bulk Head
329580	Braided Hose & Isolating Valve Dudley 'Vantage 2' Cistern (Overall Length 270mm) with Black Bulk Head
317532	Speedfit Inlet Elbow
318634	Vantage Pneumatic Tube (Green) (750mm)
319059	Vantage Pneumatic Tube (Clear) (750mm)

Dudley Spares

Toilet Cistern Levers and Spares

Code	Description
316786	Windsor Flush Lever Assembly, Chrome Plated. 80mm Spindle, Camel Adjustable Lift Arm
317072	Windsor Flush Lever Assembly. Chrome Plated. 140mm Spindle, Camel Adjustable Lift Arm
318090	Front Fit Kit W. Chrome Plated
318659	Windsor Flush Lever Assembly. Chrome Plated. 110mm Spindle, Camel Adjustable Lift Arm
319732	Concealed Kit W. Chrome Plated
315881	Plastic Flush Lever Assembly. Chrome Plated. 120mm Spindle, Camel Adjustable Lift Arm
316549	Plastic Flush Lever Assembly. Chrome Plated
313907	White Plastic Flush Lever Assembly
326866	CP 100mm Surround only Dio, Royal & Miniflo Buttons
319042	Plastic Front Lever Assembly Chrome Plated. 100mm Spindle, Green Lift Arm
313126	HL Fulcrum Bracket & Screw for Tri-Shell/Aclaim/Mirage/Diplomat/Tri-Well Levers
313301	140mm Metal Lever (5.½")
313942	Green Plastic Lift Arm
315056	Concealed H/L Adaptor Kit
318166	Red Plastic Lift Arm
318671	Push Knob Pin & Cotter Pin
318741	170mm P2/P3 Lever Linkage
318851	125mm P2/P3 Lever Linkage for Dudley Cistern
316437	'Windsor' Flush Lever Chrome Plated 120mm Spindle, Camel Adjustable Lift Arm.
313964	Concealed Kit A. Chrome Plated.
315616	Front Fit Kit A. Chrome Plated.
313149	Concealed Kit B. Chrome Plated.
318138	Dimple (B) PH Lever Kit B Assembly. Chrome Plated. Camel Adjustable Lift Arm
318252	Dimple (A) PH Lever Kit A (311mm) Assembly. Chrome Plated. Adjustable Lift Arm
315194	Nylon Cord & Plastic Pull
314065	Plated Chain & Plastic Pull

Toilet Cisterns Spares

Code	Description
319249	¾" Blanking Off Plug Comes With Backnut & Washer
368051	Overflow Washer
314241	Close Coupling Kit (Oval Hole) c/w 95x 70x 12.5mm Sealing Washer
317093	Screw For Cistern Lid White (18.5mm)
331610	Access Tunnel for Dudley Flush Plate
314063	Screw for Cistern Plastic Lid (31.5mm)
316218	Screw For Cistern Plastic Lid. White (23.5mm)

Dudley Push Button and spares

Code	Description
318767	Concealed Kit P. Chrome Plated
323280	Dudley Stainless Steel Extended 'Royal' Push Button Assembly with 160mm Long Plastic Threaded Bush
323459	(160mm) Dudley Chrome Plated 'Royal' Single Flush Push Button Assembly with 160mm Long Plastic Threaded Bush
323705	Dudley CP Extended 'Royal' Single Flush Push Button with 260mm Long Plastic Threaded Bush
333926	Pack of 2 Dudley Chrome Plated 'Royal' Push Buttons
321194	Dudley White Round Dual Flush 73.5mm Button. Dudley 'Niagara' Valve
322250	"225mm Long Dudley Metal Flat Vandal Resistant Button Assembly to suit Dudley 'Pinto' Flush Valve Suitable for 150mm Thick Wall"
326377	CP 51mm Surround only Dio, Royal & Miniflo Buttons

Dudley Spares

Miniflo Cistern Spares

Code	Description
323923	Hanging Bracket for Dudley 'Miniflo' Cistern
324371	Volume Baffle/Partition Dudley 'Miniflo' (white)

Diplomat Cistern Spares

315643	Diplomat HL 130mm Plastic Lever (5")
318806	Diplomat HL/Acclaim HL 140mm Plastic Lever (5½")

Tri-Shell Cistern Spares

Code	Description
314614	Tri-Shell HL 152mm Metal Lever (6")
317814	Tri-Shell Metal Front Lever Assembly. Chrome Plated. Pink Lift Arm
320963	Tri-Well HL 108mm Metal Lever

Elite Cistern Spares

Code	Description
313604	Push Knob for Elite. Chrome Plated

Slimline Cistern Spares

Code	Description
314926	H/L Conversion Kit for Slimline (to include Lever, Chain, Pull, Medallion, 3-pce Flushpipe)

Index

A

Adjustable Syphons	30
Air Vents and Keys	163
Auto Syphons	33

B

Backplates	158
Ball Floats	128
Ballvalve Diaphragm Washers	109
Ballvalves	122
Ballvalve Seating and Pistons	126
Ballvalve Washers	116
Basin (Resan)	49
Basin Hanger Bracket	88
Basin Wastes	65
Basin Wastes with Basin Mate	61
Basin Waste Seal Kit	60
Basket Strainer Waste	73
Bathroom Accessories	60
Bath & Basin Chains	92
Bath Grips	89
Bath Overflow Stoppers	91
Bath Wastes	68
Beta+ Inlet Valves	28
Boss Jointing Compound	147
Bottle Traps	76
Brackets (Resan)	23
Brass Pipe Fittings	129
Brass Olives	132
Bushes	144
Buttons & Pushplates	14

C

Cascade+	31
C-Links	102
Catering Hoses	154
Ceramic Tap Glands	87
Chains (Basin & Bath)	92
Checkvalves	168
Cisterns	30
Chrome Pipe Fittings	133
Cisterns	34
Cistern and Tank Fittings	103
Cistern Hole Stoppers	91
Cistern Levers	93
Cistern Pulls	100

Close Coupling Kits	105
Close Coupling Kit Washers	106
Combi Filling Loop	164
Compression Fittings	129
Concealed Cisterns	34
Consumables	147
Cooker Hoses	154
Cooker Stability Chain	155
Copper Float	127
Copper Saddle Clips	157
Cotter Pins	125
Coupling Nuts	102

D

DC Pipe Interrupter	102
Diaphragm Washer	102
Disabled (Dimple) Levers	95
Drain Test Plug	152
Drain Rods and Tools	148
Drain Trace Dye	151
Draincocks	163
Drop Arm & Adaptor	124
Dualflush Buttons	16
Dual Purpose Clips	158
Dudley Range	12
DZR Pipe Fittings	134

E

Electroflo Accessories	38
Electroflo Soap Dispensers	43
Electroflo Taps	42
Electroflo Urinal Sensor	47
Electroflo WC Sensor	47
End Feed Fittings	137
Epson Range	58
Equilibrium Float Valve	127
Europipe	103
Extension Pieces (Syphon)	102
Exposed Cisterns	36

F

Fixing Kits (Sanitary)	88
Flexible Rubber Fittings	159
Flexible Tap Connectors	174
Floats (Plastic)	128

Floats (Copper)	127
Float Operated Valve	124
Flush Grated Waste	71
Flushing (Outlet) Valves	29
Flushpipe Connectors	104
Flushpipes	103
Flux	147
Force Cup (Plunger)	150
Frames	20

G

Gas Cocks	153
Gas Products	153
Gas Tape (PTFE)	147
Gas Restrictor Tubes	155
Gas Washers	155
Gatevalves	172
Geka Fittings	146
Grab / Support Rails	89

H

Hinges (Toilet)	86
Hose Clips	156
Hose Union Bibcocks	169
Hose Washer	119
Hospital Brackets	158
Hydrant Standpipe & Keys	152
Hydroflo Inlet Valves	25

I

Immersion Heater Plugs	165
Inflator Bags	151
Inflator Pumps	151
Inlet Hose Connector	119
Inlet Valve Accessories	113
Inlet Valves	25
Isolating Valves	167

K

Kinetic Range	46
Kinetic Urinal Flush Control	46
Kinetic Urinal Sensors	47
Kinetic Urinal Accessories	48
Kitchen Accessories	60

Index

L

Lead Free Fittings136
 Lever Ballvalves170
 Levers93
 Lift Arms.....101

M

MDPE Fittings173
 Metal Flushpipes & Accessories ..103
 Meter Box Keys.....155
 Mini Gas Ballvalves153
 Mirror (Resan)56
 Munsen Rings.....157

N

Niagara Range.....29
 Nuts102

O

O Rings119
 Olives132
 Osmo F110 / 35
 Osmo T111 / 35
 Outdoor Tap Kits169
 Outlet Hose Connector166
 Outlet Valves29
 Overflows.....106
 Overflow Stopper.....91

P

P Traps75
 Pans (Resan).....52
 Pan Connectors.....78
 Petcock102
 Pipe Clips156
 Pipe Cutters147
 Pipe Fittings129
 Pipes, Valves and Fittings120
 Plastic Ball Floats.....128
 Plugs.....90
 Plumber boxes.....107
 Plumbing Fittings & Spares.....58
 Poly Bag Range.....112
 Poly Washers117

Pre Packed Products108
 PTFE Tape.....147
 Pump Valve164
 Pulls (Cistern).....100

R

Radiator & Heating Products161
 Radiator Brackets162
 Radiator Keys.....162
 Radiator Valves.....161
 Resan Range.....49
 Rubber Lined Clips.....158

S

S Traps.....75
 Saddle Clips.....157
 Sanitaryware (Resan)49
 Sanitary Fixing Kits.....88
 School Board Clips.....157
 Service Valves167
 Shelf (Resan).....56
 Shower Curtain87
 Shower Hoses87
 Sink Overflow Stoppers.....91
 Sink Strainers.....73
 Sink Waste.....72
 Smoke Testers.....151
 Socket154
 Solder.....147
 Solder Ring Pipe Fittings141
 Sparge Pipe Sets102
 Spreaders102
 Spring Safety Valves165
 Stopcocks173
 Stopcock Key152
 Stoppers.....91
 Supa-Tap Washers.....116
 Support Rail89
 Syphon Accessories102
 Syphon Extension Pieces.....102
 Syphon Washers102
 Syphons30
 Syvac Aspirator114

T

Tap Extension145
 Tap Glands.....87

Tap Hole Stoppers.....91
 Tap Swops.....87
 Tap Washers.....115
 Test Kits (Drains)151
 Test Plugs152
 Threaded Pipe Fittings144
 Toilet Cisterns34
 Toilet Roll Holders86
 Toilet Roll Holder Inserts.....87
 Toilet Seats84
 Toilet Seats Hinges86
 Top Hat Washers115
 Touch Free.....14/42
 Towel Rail Valves162
 Traps75
 Turbo Edge30
 Turbo 88.....31

U

Urinal (Resan).....56
 Urinal Flush Controls46
 Urinal Pipework.....102
 Urinal Sensors47
 Urinal Spreaders.....102
 Urinal Waste74

V

Valves (Inlet).....25
 Valves (Outlet).....29
 Vantage.....34

W

Wallplate Connector140
 Washers and Seals115
 Washing Machine Hoses.....166
 Washing Machine Taps166
 Washroom Fill and Flush.....12
 Wastes, Traps & Accessories60
 Water Hammer Arrestors175
 Wave Touch Free Range.....14
 Whats New10

Y

Y Adaptor.....166
 Y Strainer.....160

Terms & Conditions of Sale

For full terms and conditions of sale please visit our website



WRAS Standards

TYDE tests its products in our own testing laboratory that meets the strict standards of WRAS

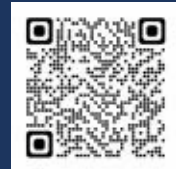

TYDE is proud to support Made in Britain

For more information please visit the Made in Britain Website



Committed to the Environment

TYDE has a commitment to comply with all relevant Environmental Policies, associated statutory legislation and approved codes of practice. For more information please visit our website



When Quality & Commitment Counts

TYDE is committed to manufacturing high quality products that are both innovative and extremely reliable. We hold a number of accreditations including ISO 9001, ISO14001 and OHSAS18001





The source of **clever plumbing, people and products**



HEAD OF SALES

Zoe Rees
p +44 (0) 121 530 7000

BDM SCOTLAND & IRELAND

James McCartney
m +44 (0) 7803 236 049

BDM NORTH

James Barnes
m +44 (0) 7703 193 370

SENIOR BDM - CENTRAL

Anthony McDonagh
m +44 (0) 7508 442 672

BDM SOUTH

Jamie Abethell
m +44 (0) 7880 291 399

BDM SOUTH WEST

Leigh Randell
m +44 (0) 7711 800 166

SENIOR BDM

Andy Lovett
m +44 (0) 7803 890 796

**NATIONAL SPECIFICATION
& OEM MANAGER**

Daniel Mills
m +44 (0) 7712 842 787

**NATIONAL MANAGER -
RESAN & SPECIALIST PROJECTS**

Tony Haworth
m +44 (0) 7747 446 146

SPECIFICATION MANAGER NORTH

Ash Meah
m +44 (0) 7867 170 142

SPECIFICATION MANAGER SOUTH

David Scarlett
m +44 (0) 7717 200 699

UK ENQUIRIES

t +44 (0)121 530 7000

or e sales@tyde.co.uk



PSPSPL373014